

Secondary Loan Trading
Oracle Banking Corporate Lending
Release 14.7.0.0.0

Part Number F72087-01

November 2022

Secondary Loan Trading
November 2022
Oracle Financial Services Software Limited

Oracle Park

Off Western Express Highway
Goregaon (East)
Mumbai, Maharashtra 400 063
India

Worldwide Inquiries:

Phone: +91 22 6718 3000

Fax: +91 22 6718 3001

www.oracle.com/financialservices/

Copyright © 2007, 2023, Oracle and/or its affiliates. All rights reserved.

Oracle and Java are registered trademarks of Oracle and/or its affiliates. Other names may be trademarks of their respective owners.

U.S. GOVERNMENT END USERS: Oracle programs, including any operating system, integrated software, any programs installed on the hardware, and/or documentation, delivered to U.S. Government end users are "commercial computer software" pursuant to the applicable Federal Acquisition Regulation and agency-specific supplemental regulations. As such, use, duplication, disclosure, modification, and adaptation of the programs, including any operating system, integrated software, any programs installed on the hardware, and/or documentation, shall be subject to license terms and license restrictions applicable to the programs. No other rights are granted to the U.S. Government.

This software or hardware is developed for general use in a variety of information management applications. It is not developed or intended for use in any inherently dangerous applications, including applications that may create a risk of personal injury. If you use this software or hardware in dangerous applications, then you shall be responsible to take all appropriate failsafe, backup, redundancy, and other measures to ensure its safe use. Oracle Corporation and its affiliates disclaim any liability for any damages caused by use of this software or hardware in dangerous applications.

This software and related documentation are provided under a license agreement containing restrictions on use and disclosure and are protected by intellectual property laws. Except as expressly permitted in your license agreement or allowed by law, you may not use, copy, reproduce, translate, broadcast, modify, license, transmit, distribute, exhibit, perform, publish or display any part, in any form, or by any means. Reverse engineering, disassembly, or decompilation of this software, unless required by law for interoperability, is prohibited.

The information contained herein is subject to change without notice and is not warranted to be error-free. If you find any errors, please report them to us in writing.

This software or hardware and documentation may provide access to or information on content, products and services from third parties. Oracle Corporation and its affiliates are not responsible for and expressly disclaim all warranties of any kind with respect to third-party content, products, and services. Oracle Corporation and its affiliates will not be responsible for any loss, costs, or damages incurred due to your access to or use of third-party content, products, or services.

Contents

1.	About this Manual	1-1
1.1	Introduction.....	1-1
1.2	Audience.....	1-1
1.3	Documentation Accessibility.....	1-1
1.4	Organization	1-1
1.5	Related documents.....	1-2
1.6	Glossary of Icons.....	1-2
2.	Secondary Loan Trading - An Overview	2-1
2.1	Introduction.....	2-1
2.2	Features	2-2
3.	Maintaining Details Specific to SLT	3-1
3.1	Introduction.....	3-1
3.2	Maintaining SLT Branch Parameters.....	3-1
3.3	Maintaining Settlement Instructions.....	3-3
3.4	Maintaining Desk Details	3-4
3.5	Maintaining SLT Position Product	3-5
3.6	Maintaining Portfolio Details	3-5
3.6.1	<i>Creating Portfolio IDs</i>	<i>3-7</i>
3.6.2	<i>Creating Position Identifiers.....</i>	<i>3-9</i>
3.6.3	<i>Creating LB - OL Product and Component Mapping</i>	<i>3-9</i>
3.6.4	<i>Portfolio Resolution</i>	<i>3-10</i>
3.6.5	<i>Specifying Revaluation Details</i>	<i>3-10</i>
3.6.6	<i>Specifying Reserve Calculation Details.....</i>	<i>3-10</i>
3.6.7	<i>Specifying Identifier Format Details.....</i>	<i>3-11</i>
3.7	Maintaining Position Identifier Details.....	3-11
3.8	Mapping MCC.....	3-14
3.9	Capturing LIBOR Rate Details.....	3-15
3.10	Maintaining Market Price Details	3-16
3.11	Maintaining CUSIP Rating.....	3-17
3.12	Maintaining Credit Rate Mapping	3-18
3.13	Maintaining Bid/Ask Factor.....	3-20
3.14	Maintaining Age Factor Details.....	3-20
3.15	Mapping of SLT Product, Portfolio Expense Code, Internal Customer	3-21
3.15.1	<i>SLT Product Mapping.....</i>	<i>3-21</i>
3.15.2	<i>Portfolio Expense Code Mapping.....</i>	<i>3-22</i>
3.15.3	<i>Internal Customer Mapping</i>	<i>3-23</i>
3.16	Maintaining SLT Fee Class	3-24
4.	Defining Attributes of an SLT Product	4-1
4.1	Introduction.....	4-1
4.1.1	<i>Specifying Product Preferences</i>	<i>4-2</i>
4.1.2	<i>Specifying Fee Details.....</i>	<i>4-8</i>
4.2	Control Accounts for SLT Trades	4-11
4.2.1	<i>Processing Products with Control Accounts.....</i>	<i>4-12</i>
4.2.2	<i>Processing SLT Batch for Trade Date Accounting</i>	<i>4-13</i>
4.2.3	<i>Control Account for Origination Contracts</i>	<i>4-13</i>
5.	Processing an SLT Contract	5-1

5.1	Introduction.....	5-1
5.1.1	<i>Specifying Trade Details</i>	5-3
5.1.2	<i>Specifying Markit/ClearPar Details</i>	5-4
5.1.3	<i>Specifying Contract Details</i>	5-4
5.1.4	<i>Specifying Booking Details</i>	5-6
5.1.5	<i>Specifying Other Details</i>	5-6
5.1.6	<i>Specifying Holiday Preferences</i>	5-8
5.1.7	<i>Financial Centre Holiday Treatment</i>	5-9
5.2	Viewing Exceptions Summary.....	5-10
5.3	Viewing Draft Trade Summary.....	5-11
5.4	Processing Internal Trades for HFI to HFS Transfer.....	5-12
5.4.1	<i>Impact on CoC Balance</i>	5-13
5.4.2	<i>Reversing Internal Trades</i>	5-13
5.5	Viewing Processed Trades.....	5-14
5.5.1	<i>Capturing swap Details</i>	5-15
5.5.2	<i>Specifying Fee Details</i>	5-16
5.5.3	<i>Specifying Settlements Details</i>	5-20
5.5.4	<i>Specifying MIS Details</i>	5-20
5.5.5	<i>Specifying SSI Mnemonics</i>	5-20
5.5.6	<i>Viewing Funding Memo Details</i>	5-21
5.5.7	<i>Maintaining Events</i>	5-22
5.5.8	<i>Viewing the Amortized Fee Log Details</i>	5-22
5.5.9	<i>Financial Centre Holiday Treatment</i>	5-23
5.5.10	<i>Viewing Commitment Reduction Log</i>	5-24
5.5.11	<i>Reversing Trade Contract</i>	5-25
5.6	Querying Trade Contract.....	5-25
5.7	Capturing Agency Details.....	5-26
5.7.1	<i>Capturing the Pricing Details</i>	5-28
5.7.2	<i>Capturing Interest Details</i>	5-29
5.7.3	<i>Auto Booking of Drawdown Details</i>	5-30
5.7.4	<i>Capturing Additional Drawdown Details</i>	5-31
5.8	Capturing Origination Trade Details.....	5-32
5.8.1	<i>Processing CLP Sell Line Trades</i>	5-32
5.8.2	<i>Processing Cost of Credit Valuation for Commitments</i>	5-35
5.8.3	<i>Validating Unamortized Fee</i>	5-35
5.8.4	<i>Processing CLP Buy Line Trades</i>	5-36
5.9	Trading with PIK Facility.....	5-36
5.10	Querying Position Balances.....	5-37
5.10.1	<i>Resolving Multiple Portfolio Mapping to a Single Expense Code</i>	5-40
5.10.2	<i>Updating Positions for Commitment Reductions/ Increases</i>	5-40
5.11	Calculating Realized Profit and Loss.....	5-41
5.11.1	<i>Calculating Realized PnL for Commitment Reductions</i>	5-42
5.12	Re-valuating Positions.....	5-42
5.13	Maintaining CUSIP-Tranche Linkage.....	5-44
5.14	Viewing CUSIP-Tranche Linkage Summary.....	5-46
5.15	Capturing Funding Memo Details.....	5-46
5.15.1	<i>Specifying Fee Details</i>	5-50
5.15.2	<i>Viewing Funding Memo Details</i>	5-50
5.15.3	<i>Viewing Break Funding Fee Details</i>	5-53
5.15.4	<i>Viewing Currency-wise Settlement Details</i>	5-54

5.16	Settling Trades Individually.....	5-55
5.16.1	<i>Capturing External Counterparty Mnemonic Details</i>	5-57
5.17	Settling Trades at Ticket Level	5-58
5.17.1	<i>Viewing Currency Wise Settlement Details in Ticket Settlement</i>	5-62
5.17.2	<i>Handling Exceptions during Ticket Settlement</i>	5-62
5.17.3	<i>Viewing Settlement Instructions before Authorization</i>	5-63
5.17.4	<i>Specifying Fee Details</i>	5-64
5.17.5	<i>Specifying Payment Details</i>	5-67
5.17.6	<i>Capturing Currency-wise SSI Mnemonics</i>	5-67
5.17.7	<i>Capturing Mnemonic Details</i>	5-68
5.17.8	<i>Field 72 Population in Wire Messages</i>	5-70
5.18	Settling Combined Tickets.....	5-71
5.18.1	<i>Specifying Fee Details</i>	5-72
5.18.2	<i>Capturing Mnemonic Details</i>	5-73
5.18.3	<i>Consolidated Interface Browser</i>	5-78
5.18.4	<i>Specifying options in Loan Parameters screen</i>	5-79
5.18.5	<i>Auto Creation of New Mnemonics</i>	5-82
5.19	Specifying Adjustment Rate	5-83
5.20	Settling DCF on First-time	5-83
5.21	Reversing Trade Settlement.....	5-84
5.22	Reversing Trade	5-84
5.23	Calculating Reserve	5-85
5.24	Reclassification.....	5-85
5.24.1	<i>SLT Batch Process for Reclassification</i>	5-86
5.25	Agency Confirmation	5-87
5.26	Amending an SLT Contract	5-89
5.26.1	<i>Amending of CUSIP/ISIN and Firm Account Mnemonic</i>	5-94
5.27	Processing Silent Participation	5-97
5.27.1	<i>Processing Sell Participation</i>	5-98
5.27.2	<i>Processing Buy Participation</i>	5-100
5.28	Processing Swap Deals.....	5-102
5.28.1	<i>Exchanging Information between SLT and LB modules</i>	5-104
5.29	Forward Processing of Events	5-104
5.29.1	<i>Fetching the Contracts for Forward Processing</i>	5-106
5.29.2	<i>Confirming the Generation of Messages for an Event</i>	5-107
5.29.3	<i>Processing Contracts For Secondary Loan Trading</i>	5-107
5.30	SLT Processing for LMA / LSTA Participation.....	5-108
5.31	SLT Processing for Primary Delayed Compensation	5-114
5.31.1	<i>Portfolio Details screen</i>	5-114
5.31.2	<i>Position Identifier Screen</i>	5-115
5.31.3	<i>Trading on Lead Agent Deals</i>	5-116
5.31.4	<i>Trading on Non-Lead Agent Deals</i>	5-117
5.31.5	<i>Reduction of Un-Amortized Fees during trade</i>	5-121
5.31.6	<i>Placement Processing</i>	5-121
5.31.7	<i>Trade Type Amendment</i>	5-123
6.	Processing Fee Details	6-1
6.1	Introduction.....	6-1
6.1.1	<i>Specifying Assignment Fee Details</i>	6-2
6.1.2	<i>Suppressing Wire Messages for Assignment Fees</i>	6-3
6.1.3	<i>LQT Trade Upload</i>	6-3

6.1.4	<i>Specifying Amendment Fee Details</i>	6-3
6.1.5	<i>Specifying Line/Accommodation Fee Details</i>	6-13
6.1.6	<i>SLT - Accounting for Amendment Fee</i>	6-14
6.1.7	<i>Specifying Delayed Compensation Fee Details</i>	6-16
6.1.8	<i>Specifying Break Fund Fee Details</i>	6-24
6.1.9	<i>Specifying Waiver Fee Details</i>	6-24
6.1.10	<i>Specifying Benefit of Commitment Reduction Fee (BCR) Details</i>	6-24
6.1.11	<i>Specifying Upfront Fee Details</i>	6-25
6.1.12	<i>Specifying Adhoc Fee Details</i>	6-25
6.1.13	<i>Specifying Brokerage Details</i>	6-25
6.2	Amending Fee Details	6-26
6.2.1	<i>Viewing Event Details</i>	6-29
6.3	Liquidating Fee Components	6-33
6.3.1	<i>DCF Flat Unrealized Liquidation</i>	6-34
6.3.2	<i>Trade Settlement Threshold Limit</i>	6-36
7.	Interface between SLT and LB modules	7-1
7.1	Introduction	7-1
7.2	Deals Originated by Bank	7-1
7.2.1	<i>Viewing LB Handoff Details</i>	7-2
7.2.2	<i>Future Buy/Sell Deal with Bank as Lead Agent</i>	7-5
7.2.3	<i>Participation Sell where Bank as Lead Agent</i>	7-6
7.3	Deals where Bank is not Lead Agent	7-8
7.3.1	<i>Handing-off Commitment Reduction Details</i>	7-12
7.3.2	<i>Viewing LQT Trade Browser Details</i>	7-14
7.4	Viewing Multiple Firm Account	7-15
7.5	Viewing Referential Data from Secure	7-16
7.6	Viewing the External Agency Interface Browser	7-17
7.6.1	<i>Viewing Trade Details</i>	7-19
7.6.2	<i>Viewing External Allocation Details</i>	7-19
7.6.3	<i>Viewing Currency-wise Settlement Details</i>	7-20
7.6.4	<i>Viewing the Error Messages</i>	7-20
7.6.5	<i>Viewing External Agency Interface Browser History</i>	7-21
7.7	Matching Process and Manual Linkage of SLT and Markit Trades	7-22
7.8	Settlement Queue for Markit Trades	7-24
7.8.1	<i>Viewing the SSI Mnemonic Details</i>	7-27
7.8.2	<i>Viewing the Funding Memo Details</i>	7-27
7.8.3	<i>Viewing the Funding Memo Reconciliation Details</i>	7-27
7.8.4	<i>Funding Memo Status</i>	7-31
7.8.5	<i>Viewing the Exception Log</i>	7-32
7.8.6	<i>Viewing Automated Settlement Queue History</i>	7-33
7.9	Viewing LQT Mnemonic Browser Details	7-34
8.	Annexure – Accounting Entries	8-1
8.1	Introduction	8-1
8.1.1	<i>Accounting Roles</i>	8-1
8.1.2	<i>Events</i>	8-3
8.1.3	<i>Amount Tags</i>	8-4
8.1.4	<i>Advices</i>	8-5
8.1.5	<i>Error Codes</i>	8-5
8.1.6	<i>Event-wise Accounting Entries</i>	8-9
8.1.7	<i>Maintaining SLT Accounting Entries</i>	8-40

8.1.8	<i>LOR Accounting Entries</i>	8-43
9.	Jobs and EOD Batches	9-1
10.	Function ID Glossary	10-1

1. About this Manual

1.1 Introduction

This manual is designed to help acquaint you with the Secondary Loan Trading (SLT) module of Oracle Banking Corporate Lending (OBCL).

It provides an overview of the module and guides you through the various steps involved in trading syndicated loans in the secondary market.

In addition to this User Manual, you can find answers to specific features and procedures, in the Online Help. It can be invoked by choosing Help Contents from the Help Menu of the software. You can further obtain information about to a particular field by placing the cursor on the relevant field and pressing the <F1> key on the keyboard.

1.2 Audience

This manual is intended for the following User/User Roles:

Role	Function
Back office data entry clerk	Input functions for contracts
Back office managers/officers	Authorization functions
Product Managers	Product definition and authorization
End of Day operators	Processing during End of Day/ Beginning of Day
Financial Controller / Product Managers	Generation of reports

1.3 Documentation Accessibility

For information about Oracle's commitment to accessibility, visit the Oracle Accessibility Program website at <http://www.oracle.com/pls/topic/lookup?ctx=acc&id=docacc>.

1.4 Organization

This manual is organized into the following chapters:

Chapter 1	<i>About this Manual</i> - gives information about the intended audience. It also lists the various chapters covered in this User Manual.
Chapter 2	<i>Secondary Loan Trading - An Overview</i> - explains the features of this module.
Chapter 3	<i>Maintaining Details Specific to SLT</i> - explains the various maintenances required for SLT.
Chapter 4	<i>Defining Attributes of an SLT Product</i> – explains about defining the attributes specific to setting up a trading product.

Chapter 5	<i>Processing an SLT Contract</i> – explains the various activities involved in the processing of an SLT contract like evaluation of positions, generation of funding memo, trade settlement, and so on.
Chapter 6	<i>Processing Fee Details</i> – explains about the different types of fees involved in secondary loan trading.
Chapter 7	<i>Interface between SLT and LB modules</i> – explains the data exchanges that take place between the SLT and LB modules.
Chapter 8	<i>Annexure – A</i> – explains about the event-wise accounting entries and advices.





1.5 Related documents

You may need to refer to any or all of the User Manuals while working on the Secondary Loan Trading module:

- Loan Syndication
- Bilateral Loans
- Procedures
- Settlements
- Brokerage
- Charges and Fees
- User Defined Field
- MIS

1.6 Glossary of Icons

This User Manual may refer to all or some of the following icons:

Icons	Function
	Exit
	Add row
	Delete row
	Option List

2. Secondary Loan Trading - An Overview

This chapter contains the following sections:

- [Section 2.1, "Introduction"](#)
- [Section 2.2, "Features"](#)

2.1 Introduction

Secondary Loan Trading module or the SLT module is primarily concerned with the trading of syndicated loans in the secondary market. The participants in a syndication deal can carry out trading operations on the loan, once the syndication deal is closed and allocated. Brokers also can get involved in the trading process.

There are two possible options for carrying out a sale:

- Assignment where bank is directly involved in the trade
- Participation where bank is silently participating in the trade

The SLT process at your bank can be classified as specified below:

- Par – normal trading that happens in the secondary market
- Total Return Swap (TRS) - two parties exchange cash flows for a set period of time
- Distressed Trading – defaulted trades are handled under this category
- Origination Trades – handles internal trade deals

Loans QT is a front-end application which books buy and sell deals processed under secondary loan trading. A unique reference number called CUSIP indicates the facility associated with a syndication trade deal.

The profitability of the financial instruments involved in a deal can be ascertained by a method known as 'marking the position to the current market price' (MTM), where the actual cost involved in the deal is compared to the current market price. Any profit or loss arising from this is booked to Unrealized P&L on a daily basis. In case of any buy or sell trade, the profitability of the transaction is arrived at by comparing the buy and sell prices. This gets booked into realized P&L on the trade date.

The settlement usually happens T+7 days from the trade date. On the settlement date, the seller sends out an advice called the 'Funding Memo' to the trade counterparty. Funding memo gets generated on or before trade settlement and funding memo advice gets generated during save or authorization of Funding Memo, based on the advice parameters that have been maintained.

Funding memo contains details regarding the fees, funded and unfunded amounts, settlement accounts, and so on. On the settlement date, the deal details are captured manually using the information gathered from trade ticket and funding memo.

The trade deals captured using external systems can be uploaded to the SLT module and further processing can be carried out. SLT module also allows you to capture buy or sell deals, amend the details, if required and carry out the settlement of the deal.

Note

SLT trades are applicable only for pro-rata tranches with 'Cascade Participation' option enabled.

2.2 Features

SLT module interfaces with Loans QT, which is an external front-end application used to book buy and sell deals. The details of new trade deals as well as amendments to the existing deals are exchanged between Loans QT and Oracle Banking Corporate Lending. SLT module also interfaces with other external systems like Hamper to get the market price details for the CUSIPs.

SLT module also allows you to capture new trade deals and amendments to existing deals, independent of Loans QT. The settlement of a deal can be initiated from the SLT Trade Settlement screen.

SLT module interacts with the following core modules also:

- Fee Module – for calculation of Assignment, Amendment, Line/Accommodation and Delayed Compensation Fees.
- Accounting Module – for passing all the accounting entries related to Fees, Trade Date Accounting & MTM entries
- Messaging Module – for generation of Payment messages and Funding Memo
- MIS Module – for passing the accounting entries with the relevant Expense Codes.
- Brokerage Module – for passing Brokerage entries into the Payable Account
- Loans Syndication – trading details are passed on from SLT to LB module which in turn will interface with the OL module

The following diagram graphically represents the way in which SLT module interfaces with the external applications as well as other modules:

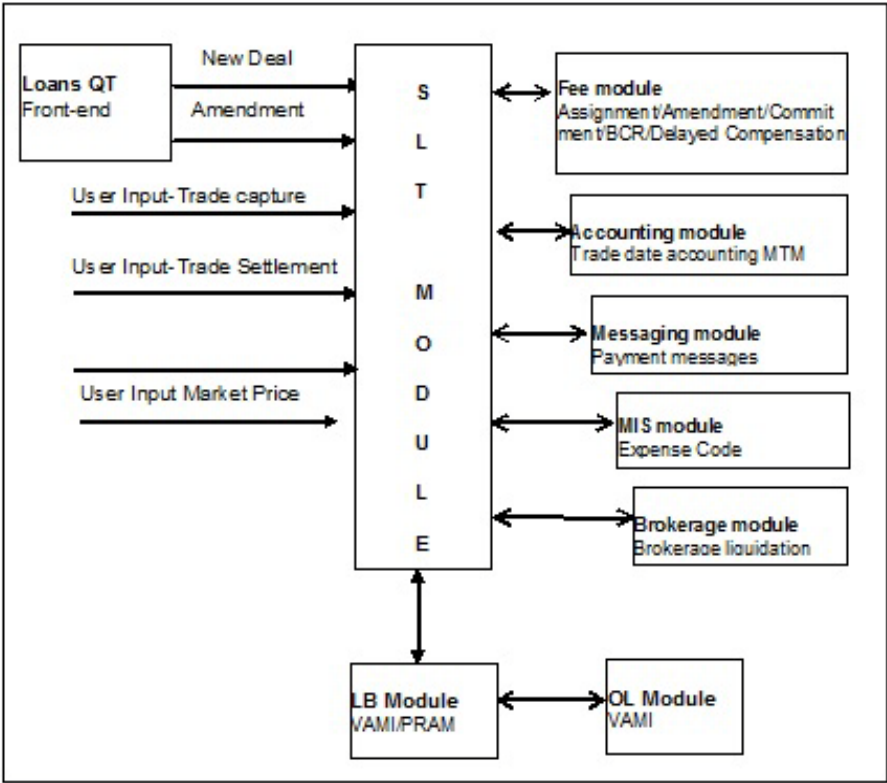

The following list of activities can be performed using the Secondary Loan Trading module:

- Upload trades captured using external system into Oracle Banking Corporate Lending
- Capture trades using the front-end provided in SLT
- Maintain open and closed positions on facilities
- Allow pairing or squaring off deals using WAC, FIFO, and LIFO methodologies
- Calculate and pass unrealized P&L entries at EOD, using the market rate uploaded from external system
- Support calculation and settlement of fees incurred in the process of each trade transaction
- Support calculation of brokerage
- Perform trade date accounting
- Generate funding memo
- Generate payment messages on settlement

These activities and other related details are explained in the subsequent sections.

3. Maintaining Details Specific to SLT

This chapter contains the following sections:

- [Section 3.1, "Introduction"](#)
- [Section 3.2, "Maintaining SLT Branch Parameters"](#)
- [Section 3.3, "Maintaining Settlement Instructions"](#)
- [Section 3.4, "Maintaining Desk Details"](#)
- [Section 3.5, "Maintaining SLT Position Product"](#)
- [Section 3.6, "Maintaining Portfolio Details"](#)
- [Section 3.7, "Maintaining Position Identifier Details"](#)
- [Section 3.8, "Mapping MCC"](#)
- [Section 3.9, "Capturing LIBOR Rate Details"](#)
- [Section 3.10, "Maintaining Market Price Details"](#)
- [Section 3.11, "Maintaining CUSIP Rating"](#)
- [Section 3.12, "Maintaining Credit Rate Mapping"](#)
- [Section 3.13, "Maintaining Bid/Ask Factor"](#)
- [Section 3.14, "Maintaining Age Factor Details"](#)
- [Section 3.15, "Mapping of SLT Product, Portfolio Expense Code, Internal Customer"](#)
- [Section 3.16, "Maintaining SLT Fee Class"](#)

3.1 Introduction

You need to maintain certain basic information specific to SLT module, before you start processing any trade deal. The following details need to be maintained:

- SLT branch parameters
- Settlement instructions
- Desk maintenance
- SLT position product details
- Portfolio maintenance
- Position identifier details
- LIBOR rate details
- Market price details for CUSIPs
- CUSIP rating details
- Credit rate mapping
- Bid/Ask factor
- Age factor

3.2 Maintaining SLT Branch Parameters

You can maintain the branch parameters specific to the SLT module in 'Secondary Loan Trading – Branch Parameters' screen.

You can invoke the 'Secondary Loan Trading - Branch Parameters Maintenance' screen by typing 'TLDBRPRM' in the field at the top right corner of the Application tool bar and clicking on the adjoining arrow button.

You can maintain the following details in this screen:

Branch Code

The branch code of the current branch, for which the parameters are being maintained, gets defaulted here. The description associated with the branch code is also defaulted in the adjacent column.

Ticket Settlement Required

Select the option to indicate whether ticket settlement should be enabled or not, for the branch specified.

If you select 'Yes', then you can perform the settlement only using the 'Ticket Settlement' screen. If you select 'No', then ticket settlements can not be carried out for that branch. In this case, all settlements need to be done at trade level, using the 'Trade Settlement' screen.

Note

- For 'Ticket Settlement' enabled branches, trade level settlement is allowed in exceptional cases where settlement has failed during ticket settlement or for settlement of trade after a trade settlement reversal.
 - This check box is disabled only if the 'Ticket and Trade Settlement Allowed' box is selected.
-

Process Till

Select the option to indicate till which date the automatic processes of your branch should be executed if they fall due on holidays. The options available are:

- Next Working Day-1 - select this option to indicate that the events scheduled for a holiday should be processed on the last working day before the holiday
- System Date - select this option to indicate that all automatic events scheduled till (inclusive of) the current system date need to be processed

Payment Message Netting at Ticket Level

Select this check box to indicate that consolidated payment messages need to be generated at ticket level. Payment messages are generated at trade level if this option is not selected.

'Payment Message Netting at Ticket Level' is enabled only if 'Ticket Settlement required is selected as 'Yes'.

Payment Browser

Select this check box to indicate that payments that are utilized for secondary loan trading should be processed using the forward processing 'Payment Browser'.

Archive Days

Specify the number of days till which messages pertaining to secondary loan trading should be retained in the forward processing 'Payment Browser. Messages whose dates are earlier than the archive days mentioned are archived and can be viewed only from the 'Outgoing Message Browser'.

Ticket and Trade Settlement Allowed

Select this check box to indicate that both, ticket and trade settlements are allowed for a branch. If this check box is selected, then you can settle all trades for a ticket in the ticket settlement screen or you can settle trades individually in the trade settlement screen.

Note

Ticket settlement is not allowed if atleast one trade under the ticket is settled in trade settlement screen, however the reverse is allowed.

Trade Settlement Acknowledgement to LQT

Select this check box to indicate that settlement acknowledgement message to LQT must be sent at individual trade level. However, if this check box is not selected, then settlement acknowledgement message to LQT is sent at a ticket level.

Note

- Trade level acknowledgement is sent to Loans QT for each trade after it is settled either from ticket settlement or from trade settlement screen.
 - Trade level acknowledgement message is sent only for the Loans QT trades which is received from Loans QT and settled in Oracle Banking Corporate Lending.
 - Trade level acknowledgement message will not be sent for Origination line trades and Par line trades
 - Trade level settlement acknowledgement message is sent once the trade settlement is authorized successfully
-

3.3 Maintaining Settlement Instructions

You need to maintain separate sets of settlement instructions for all counterparties involved in a trade transaction. The module name to be associated with the settlement instruction needs to be specified as 'TL'. The settlement instructions for the agent Id also needs to be maintained with the module as TL'. This is used in trades involving assignment fee.

You can also capture currency-wise mnemonics while specifying settlement instructions. Settlement instructions need to be maintained for each portfolio (Desk, Branch, and Expense code combination) as this is represented by a customer Id.

For each individual SLT contract, you can amend the settlement instructions before the settlement date.

3.4 Maintaining Desk Details

Different types of desks are available for processing the deals at different priorities. You can maintain the details related to desks in 'Desk Code Maintenance' screen. You can invoke the 'Desk Maintenance' screen by typing 'LBDDKMNT' in the field at the top right corner of the Application tool bar and clicking on the adjoining arrow button.

Maker	Date Time:	Mod No	Record Status
Checker	Date Time:		Authorization Status

You can specify the following details in this screen:

Desk Code

Specify a unique identification code for the desk and provide a suitable description for the desk code in the adjacent column.

Desk Type

Select the type of the desk from the drop-down list. The following values are provided for selection:

- Par – handles normal trading that happens in the secondary market
- TRS/Swap – cash flows are exchanged between the parties involved, for a set period of time
- Distress – the trades that move to defaulted status are handled by this desk
- Originations – a internal investment trade desk
- ORIGINATION-HFS – internal trade desk for holding 'Held for Sale' position

To process transfer of portfolio from HFI to HFS, you need to maintain a desk of the type 'ORIGINATION-HFS.'

3.5 Maintaining SLT Position Product

You need to maintain a position product to keep track of the position details of the entities involved in a deal. You can maintain a position product in 'Secondary Loan Trade – Product Definition' screen. You can invoke the 'Secondary Loan Trade - Product Definition' screen by typing 'TLDPRMNT' in the field at the top right corner of the Application tool bar and clicking the adjoining arrow button.

The screenshot shows the 'Secondary Loan Trade - Product Definition' window. It features a header with 'New' and 'Enter Query' buttons. The main area contains a form with the following fields: 'Product Code*' (required), 'Product Description', 'Product Module' (TL), 'Module Description' (Secondary Loan Trading), 'Product Type' (radio buttons for Trade and Position Product), 'Product Slogan', 'Product Group*' (required), 'Product Group Description', 'Start Date' (YYYY-MM-DD), 'End Date' (YYYY-MM-DD), 'Format Name', and 'Remarks'. At the bottom, there is a navigation bar with 'Accounting Roles | Events | Preferences | MIS | Fees | Fields | Change Log'. Below this is a status bar with 'Maker', 'Checker', 'Date Time:', 'Mod No', 'Record Status', and 'Authorization Status' fields, and an 'Exit' button.

You can specify the following details related to the position product, in this screen:

- Product code, description, type of the product and the module to which the product is attached
- A suitable slogan for the product
- Group to which the product belongs
- Start date and end date of the product
- Format Name to be used for generating the reference number

For more details on this screen, refer 'Defining Attributes of an SLT Product' chapter in this user manual.

3.6 Maintaining Portfolio Details

Portfolios are maintained for a combination of branch, desk, and expense code. Every branch-desk-expense code combination is uniquely identified as a portfolio in SLT module. For instance, you have to maintain a portfolio for HFS with the Originations-HFS desk. You can maintain the details related to a portfolio in 'Portfolio Details' screen.

This section contains the following topics:

- [Section 3.6.1, "Creating Portfolio IDs"](#)

- [Section 3.6.2, "Creating Position Identifiers"](#)
- [Section 3.6.3, "Creating LB - OL Product and Component Mapping "](#)
- [Section 3.6.4, "Portfolio Resolution"](#)
- [Section 3.6.5, "Specifying Revaluation Details"](#)
- [Section 3.6.6, "Specifying Reserve Calculation Details"](#)
- [Section 3.6.7, "Specifying Identifier Format Details"](#)

You can invoke the 'Portfolio Details' screen by typing 'TLDPOMNT' in the field at the top right corner of the Application tool bar and clicking the adjoining arrow button.

You can specify the following details in this screen:

Portfolio

Select a unique identification for the portfolio from the option list provided. The option list displays a list of valid customers for the branch, desk, and expense code combination, from which you can select the required value.

Branch

Select the branch code associated with the portfolio whose details are being maintained, from the option list provided.

Desk

Select the desk code associated with the portfolio from the list of options provided. All desk codes maintained in 'Desk Maintenance' are displayed.

Firm Account Mnemonic

Specify a firm account mnemonic that is associated with branch code and desk code. The adjoining option list displays a list of valid CFPI firm account mnemonic uploaded through MCC.

Expense Code

Select the expense code to be used for the portfolio from the option list provided. All expense codes maintained under an MIS class gets displayed here.

Costing Method

Select the costing method to be used to arrive at a profitable price at which you can trade, from the options provided in the drop-down list. The following options are available:

- Weighted Average Cost (WAC) - the acquired cost of each security in a portfolio is maintained as an average cost
- Last in first out (LIFO) - in this method of cost accounting, the securities that have been bought last by a portfolio would be sold first
- First in first out (FIFO) - in this case the securities that have been bought first by a portfolio would be sold first

Note

By default, WAC is selected for all desk types.

Position Product

Select the position product to be used to track the position details of the portfolio, from the option list provided. All position products maintained in 'SLT Product Definition' screen are displayed in the list.

3.6.1 Creating Portfolio IDs

Oracle Banking Corporate Lending automatically creates the Portfolio details whenever system receives a new Firm Account Mnemonic from e-sales.

System derives the Portfolio ID and other details using the following logic:

- Based on the MCC received from e-sales, system derives the following fields that are used to setup the portfolio. For non-CFPI cases too, e-sales sends MCC, and that MCC is used to compare with the 'MCC mapping' maintenance to derive the following fields:
 - Desk Code
 - Branch Code
 - CFPI (Yes/No)
 - Position Product

If the MCC maintenance does not exist, then Portfolio creation is not done and an exception is logged for the same.

- These identified details are used to create a Portfolio.
- System creates a unique customer number for a Portfolio. A new customer is uploaded for every new Portfolio that is created.
- Customer maintenance for this customer number is auto-authorized
- The following basic details are populated for the system created Customer number:
 - Short Name: Firm Account Mnemonic
 - Name: Firm Account Mnemonic
 - Address Line 1: MCC code

- GFCID will be blank
- MEI code UDF for this portfolio is populated based on the MEI code that is mapped at the branch level for the resolved Branch Code based on the MCC mapping maintenance
- Country, Nationality and Exposure is populated with the country code maintained for the resolved branch code
- Customer Type: I
- Source Code: CFPI
- SIC Code: Firm Account Mnemonic
- US_PAY_ID_TYPE: N
- Once Auth: Y
- FX MANUAL LIQD: N
- Disallow Changes: N
- AML Required: N
- Record Status: O
- Portfolio maintenance is created using the above details
 - Portfolio- System generated new Customer Id
 - Desk- Resolved based on the MCC mapping (as described above)
 - Branch- Resolved based on the MCC mapping (as described above)
 - Firm Acct Mnemonic- This is populated with the firm account mnemonic for which the portfolio is being created (For both CFPI and Non-CFPI portfolios)
- The details for the Portfolio for the other fields are defaulted as below:
 - Default Portfolio-Not checked
 - Costing Method- WAC
 - Interface Type- Internal
 - Position Product- Is picked from the MCC maintenance
 - Reval Req- Yes
 - Reval Frequency- Daily
 - Reserve Calculation Req- No
 - Auto Generate Position Identifier- Not checked
 - Position Identifier Format- Blank

Portfolio Id Maintenance is auto-authorized with 'SYSTEM' as the user id.

Note

- Portfolio creation happens only if the Firm Account Mnemonic is being received for the first time to Oracle Banking Corporate Lending
- If it's an existing Firm Account Mnemonic and updated details are received for the same, then no action is taken in Oracle Banking Corporate Lending for such cases
- The Portfolio Id's once created systematically reside in the system. No systematic updates happen on these Portfolio Id's for any subsequent updates.
- If the portfolio has to be closed/amended, user should initiate it from the Portfolio Id maintenance screen, as per existing functionality
- The existing functionality for user to create portfolio, maintain firm account mnemonic – expense code mapping, create new customer, and so on all continue to function as it is, with only the automation process newly added as summarized in the approach

- While creating a new position, system populates the firm account mnemonic. For existing positions, one-off conversion script to link all the existing positions with a firm account mnemonic is taken up as an implementation exercise
-

3.6.2 Creating Position Identifiers

Position Identifiers are automatically created by the system.

- For each new Portfolio that is created, automatic Position Identifier is generated.
- Position Identifier is defaulted with the Portfolio
- Position Identifier type is Self
- The newly created portfolio is linked to this Position Identifier
- The following details are blank/not checked for this Position Identifier record,
 - Silent Participant– Not Checked
 - First Buy Participant– Not Checked
 - Collateral Online Mnemonic– Blank
 - Collateral Settlement Mnemonic– Blank
- The Position Identifier maintenance is auto-authorized with SYSTEM as the user id.

3.6.3 Creating LB - OL Product and Component Mapping

A new LB OL Product and Component Mapping is created when a new portfolio is created either for CFPI and non-CFPI instances.

3.6.3.1 Maintaining Default Portfolio

System performs the following processing for maintaining the default portfolio:

- The 'Default Portfolio' field in the 'MCC Mapping' screen is used to maintain the default portfolio during the automatic creation of LB OL Product and Component mapping
- You can maintain the 'Default Portfolio' with New/Unlock options.
- All available portfolio ids for which LB OL Product and Component mapping is maintained for the selected branch code as the OL branch, are listed so that you can select the default portfolio

3.6.3.2 Creating LB OL Product and Component Mapping

System performs the following processing for creating LB OL product and component mapping:

- Based on the 'MCC mapping' screen, the Default Portfolio and Branch code is resolved for the MCC
- All LB OL product and component mapping maintained for the resolved default portfolio and branch code are replicated for the new portfolio
- All details pertaining to the LB OL product and component mapping remains the same, with only change in the portfolio, as a result of this replication
- The LB OL Product and Component mapping is auto-authorized with SYSTEM as the user Id
- If the 'Default Portfolio' is not maintained at the 'MCC mapping' level, then the LB OL Product and Component mapping is not created for the new portfolio.

3.6.4 Portfolio Resolution

System derives the expense code and the desk code, and then fetches the portfolio which is mapped to the expense code, resolved desk code, branch code, and firm account mnemonic

- System then performs the following validations/processing:
- Once the expense code is derived, system fetches the Position Identifier from the SLT Position balance screen, based on the CUSIP, Expense code and Firm account mnemonic
- System checks if the position (settled or unsettled) is non-zero for any of the mapped position identifiers, then that position identifier is used to resolve the trade Portfolio, and further processing is done
- If no position is found or the position (settled and unsettled) is zero, then system
- Fetches the portfolio which is mapped to the expense code, resolved desk code, firm account and the branch code, then the same is taken as trade portfolio and further processing is done

This processing is performed only for non-CLP trades so that trades do not go for manual enrichment. However, there are no changes for CLP trades, so manual enrichment is required.

3.6.5 Specifying Revaluation Details

You can specify the following details related to the revaluation of the positions associated with the portfolio.

Reval Frequency

Select the frequency at which you need to perform a revaluation of the portfolio position, from the drop-down list provided. The following options are available:

- Daily
- Monthly
- Quarterly
- Half Yearly
- Yearly

Reval Start Month

Select the month in which the revaluation has to begin, from the drop-down list provided.

This is applicable if you specify any revaluation frequency other than daily or monthly.

Start Day

Specify the date on which the revaluation should be done during the month. For example, if you specify the date as '20', revaluation will be carried out on that day of the month, depending on the revaluation frequency.

3.6.6 Specifying Reserve Calculation Details

Reserve calculation is applicable for buy trades that have not been sold for a period that exceeds a pre-defined number of days. You can specify the following preferences for reserve calculation for a trade deal.

Reserve Calculation Reqd

Select this check box to indicate that reserve calculation needs to be performed for the portfolio, if the number of days up to which a buy deal remains un-sold exceeds the 'Reserve Days' specified.

Reserve Days

Specify the number of days up to which a buy deal can remain un-sold, exceeding which reserve calculation for the trade gets initiated.

Frequency

Select the frequency as 'Daily' or 'Monthly' at which reserve calculation needs to be performed for trades that are marked for the same.

3.6.7 Specifying Identifier Format Details

You can specify the following details related to the position identifier.

Auto-generate Position Identifier

Select this check box to indicate that position identifier needs to be generated automatically during trade creation.

This is applicable only for 'TRS' desk types.

Position Identifier Format

Select the format in which position identifier needs to be generated, from the option list provided.

Note

This is applicable only if 'Auto-generate Position Identifier' is selected.

3.7 Maintaining Position Identifier Details

Position Identifier indicates the level at which position needs to be maintained for a portfolio. You can maintain settled and unsettled positions at position identifier level. You can maintain the details related to position identifier in 'Position Identifier Detail' screen.

You can invoke the 'Position Identifier Detail' screen by typing 'TLDPIMNT' in the field at the top right corner of the Application tool bar and clicking the adjoining arrow button.

Position Identifier

Specify a unique identification for the position identifier to be used for tracking the position of the portfolio selected.

Position Description

You can also provide a description for the identifier in the adjoining column.

Type

Select the type of the position identifier from the drop-down list. The following options are provided:

- Swap
- Silent
- Self

Note

For TRS trades, you need to specify the type as 'Self' in case of parent trades, and for corresponding swap trades the type gets defaulted as 'Swap'.

Portfolio

The portfolio number specified in the 'Position Details' screen gets displayed here. The branch, desk, and expense code details associated with this portfolio are also defaulted.

Position Qualifier

Select the position qualifier from the option list provided, for identifiers of type 'Silent'. The option list displays the list of existing customers in Oracle Banking Corporate Lending.

If type is 'Swap', the position qualifier indicates the Swap ID.

Note

Position qualifier is disabled for 'Self' identifier types.

Branch

Select the branch code associated with the position qualifier.

Desk

Select the desk code associated with the position qualifier from the list of options provided. All desk codes are maintained in 'Desk Maintenance' are displayed.

Firm Account Mnemonic

The system displays the firm account mnemonic maintained in the 'Portfolio Maintenance' screen. This displays only the valid CFPI firm account mnemonic uploaded through MCC and not the existing firm account mnemonic.

Silent Participant

Select this check box to indicate that the specific position identifier is a silent participant. If this option is selected, the position identifier type should be selected as 'Self' and the desk type as 'Par' or 'Distress'. A single silent participant represents all the external participants who have bought the Participation from the bank.

You can mark a specific position identifier as a 'silent participant' across the branches and desk. If the position identifier for the Silent participant is not maintained, SLT-LB Handoff is in 'Failed' status in SLT-LB Interface browser for Participation sell.

During SLT-LB handoff, a new wrapper contract is created for all the silent participation sold across the bank entities.

Collateral Online Mnemonic

Specify the collateral online mnemonic to the margin desk account. The adjoining option list displays all mnemonics that are maintained for the collateral online customer in the system.

Collateral Settlement Mnemonic

Specify the collateral settlement mnemonic to the margin desk account. The adjoining option list displays all mnemonics that are maintained for the collateral settlement customer in the system.

First Buy Participant

Check this box to indicate that the position identifier is a first time buy investor. Only one such position identifier can be marked as first time buy investor across branches and desks. This is applicable only for non-lead agency contracts.

Tranche/DDs for the first-time buy trade CUSIP has to be created manually before the expected settlement date of trade with 100% participation from the first-time buy investor. When such tranche contracts are created, the delayed compensation fee (DCF) is calculated for the first-time buy trades between the committed settlement date and the actual settlement date.

Note

- When a bank entity is selling the participation, and if the CUSIP exists in the system, during SLT to agency handoff, the external counterparty is replaced by the silent participant maintained in the 'Position Identifier Detail' screen.

- As part of the Agency handoff, the bank position is reduced and the position of the Silent Participant position identifier which is representing all the External parties in the sell participation is increased to the extent of sell participation.
- System fires PRAM (Participant transfer) on the agency contract transferring the participant amount between bank entity and Silent participant.
- A new commitment contract is created to the extent of the trade amount in tranche currency, and Tranche maturity date as the commitment maturity date. This is done as part of STP to Originations for the Silent participant.
- The expense code of the bank entity who sold the Participation to the external party is used as the expense code for the new commitment contract.
- System STP further PRAM events from agency to newly created commitment for the silent participant, if there is subsequent sell of Participations by the same bank entity.
- For every Sell of Participations by another bank entity, another new commitment gets created for the silent participant to the extent of trade amount.
- System does not create loans for the underlying draw-down contracts for these silent participants.

3.8 Mapping MCC

You can map strategy codes to region codes and branch codes using the 'Strategy Code Mapping' screen.

You can invoke the 'MCC Mapping' screen by typing 'TLDSTRCM' in the field at the top right corner of the Application tool bar and clicking on the adjoining arrow button.

The screenshot shows the 'MCC Mapping' application window. The window has a title bar with 'MCC Mapping' and standard window controls. Below the title bar, there are two buttons: 'New' and 'Enter Query'. The main area contains several input fields with red asterisks indicating required fields: 'MCC*', 'Desk Code*', 'Branch Code*', and 'Region Code*'. There are also 'Default Portfolio', 'Position Product', and a 'CFPI' checkbox. At the bottom of the window, there are fields for 'Maker', 'Checker', 'Date Time', 'Mod No', 'Record Status', and 'Authorization Status'. An 'Exit' button is located in the bottom right corner.

Specify the following details:

MCC

Specify the MCC which you want to map to the region code and branch code. The adjoining option list displays all strategy codes maintained in the system. Choose the appropriate one.

The combination of portfolio, branch desk code and Firm account mnemonic should be unique.

Note

- MCC captured in this screen is not restricted to the MCCs that are uploaded from e-sales. A pick-list lists the available MCCs uploaded from e-sales.
 - Using this screen, only one record can be maintained for each MCC.
 - MCC is one level higher than the Strategy Code, and hence multiple strategy codes can be mapped to one MCC.
-

Region Code

Specify the region code that needs to be mapped to the strategy code. This is not a mandatory field.

Branch Code

Specify the branch code that needs to be mapped to the strategy code. The adjoining option list displays all branch codes maintained in the system. Choose the appropriate one. This is not a mandatory field.

CFPI

Select this check box to indicate the branch falls under CFPI account.

Desk Code

Select the desk code from the adjoining option list. The list contains all valid Desk codes maintained in system.

Position Product

Select the position product from the adjoining option list. The list contains all valid position products maintained in system.

Default Portfolio

Specify the default portfolio that is used during the automatic creation of LB OL Product and Component mapping.

3.9 Capturing LIBOR Rate Details

You can capture the LIBOR rate to be used for computing 'Cost of Fund' and 'Cost of Carry' components of delayed compensation fee, in the 'Average Rate Maintenance' screen.

You can invoke the 'Average Rate Maintenance' screen by typing 'TLDRTMNT' in the field at the top right corner of the Application tool bar and clicking on the adjoining arrow button.

You can specify the following details in this screen:

Rate Code

The rate code defaults to 'LIBOR'. You cannot modify this value.

Ccy

Select the currency to be linked to the LIBOR rates, from the option list provided.

Effective Date

Specify the date on which the LIBOR rate specified becomes effective.

Rate

Specify the LIBOR rate in terms of the selected currency.

Note

The LIBOR rate information is obtained from the website 'averagelibor.com'.

3.10 Maintaining Market Price Details

You can maintain market price ratings for all CUSIPs involved in trade, which can be used for the revaluation of the positions associated with the CUSIP.

You can capture the market price details for CUSIPs in 'Market Price Maintenance' screen. You can invoke the 'Market Price Maintenance' screen by typing 'TLDPRCMT' in the field at the top right corner of the Application tool bar and clicking on the adjoining arrow button.

Market Price Maintenance

Enter Query

Price Master Code

Price Detail

1 Of 1 Go

<input type="checkbox"/>	CUSIP/ISIN	Market Price	Source

Maker Date Time: Mod No Record Status
 Checker Date Time: Authorization Status

Exit

The following details are displayed in this screen:

CUSIP/ISIN

Specify the CUSIP for which you need to maintain the market price details.

Market Price

Specify the market price associated with a CUSIP.

Source

Specify the source from where the market price for the CUSIP was obtained.

If the market price gets revised, the old value is retained in the history.

3.11 Maintaining CUSIP Rating

You need to maintain reserve ratings for all CUSIPs available at agency level to facilitate reserve calculation for a trade.

You can maintain ratings for the CUSIPs in the 'CUSIP Rating Maintenance' screen.

You can invoke the 'CUSIP Rating' screen by typing 'TLDCUMNT' in the field at the top right corner of the Application tool bar and clicking on the adjoining arrow button.

The screenshot shows the 'CUSIP Rating' application window. The title bar reads 'CUSIP Rating'. Below the title bar is a menu bar with 'New' and 'Enter Query'. The main content area has three input fields: 'Cusip No*' (empty), 'Reserve Rating*' (a dropdown menu with 'Moody's' and 'S and P' options), and 'Rating Value' (empty). At the bottom of the window, there are several fields: 'Maker', 'Checker', 'Date Time', 'Date Time', 'Mod No', 'Record Status', and 'Authorization Status'. An 'Exit' button is located in the bottom right corner.

You can specify the following details in this screen:

CUSIP/ISIN

Select the CUSIP for which you need to maintain reserve rating from the option list provided. All CUSIP available at the agency level are displayed in the list.

You can also modify the rating for a CUSIP in this screen.

Reserve Rating

Select the external rating agency from where the credit rating for the CUSIP selected, should be obtained. The following options are possible:

- Moody's
- S & P

Rating Value

Specify the rating value obtained for the CUSIP from the external credit rating agency.

3.12 Maintaining Credit Rate Mapping

You can maintain a mapping of the credit rating values obtained from Moody's and S&P's in the 'Rating Matching – Detailed' screen.

You can invoke the 'Rating Match -Detailed' screen by typing 'TLDRTMCH' in the field at the top right corner of the Application tool bar and clicking on the adjoining arrow button.

You can specify the following details in this screen:

Reserve Rating 1

Select the first credit rating agency to be considered for finding the rate match. The following options are provided:

- Moody's
- S & P

Reserve Rating 2

Select the second credit rating agency to be considered for finding the rate match. The following options are provided:

- Moody's
- S & P

Note

You cannot select the same value for 'Reserve Rating 1' and 'Reserve Rating 2'.

Rating Value 1

Select a rating value associated with the rating agency specified in 'Reserve Rating 1'.

Rating Value 2

Select the rating value associated with the rating agency specified in 'Reserve Rating 2'.

You can maintain a mapping for all the credit values obtained from the two credit rating agencies.

3.13 Maintaining Bid/Ask Factor

Bid price is the highest price that a buyer is willing to pay in a trade deal whereas ask rate is the lowest price that the seller is willing to accept. The ratio of the bid price to the ask price is termed as Bid/Ask factor.

You can maintain the Bid/Ask factor for the credit rating values available from S&P in the 'Bid/Ask Factor Maintenance' screen. You can invoke the 'Bid Ask Factor' screen by typing 'TLDBDMNT' in the field at the top right corner of the Application tool bar and clicking on the adjoining arrow button.

The screenshot shows a web application window titled "Bid Ask Factor". At the top, there is a "New Enter Query" button. Below it is a "Reserve Rating" dropdown menu with "Moody's" selected. A "Go" button is positioned to the right of the dropdown. Below the dropdown is a table with two columns: "Rating Value" and "Bid Factor". The table is currently empty. At the bottom of the window, there are several fields: "Maker", "Checker", "Date Time", "Mod No", "Record Status", and "Authorization Status". An "Exit" button is located in the bottom right corner.

You can specify the following details in this screen:

Reserve Rating

Select the credit rating agency for which you need to maintain Bid/Ask factor for the associated rating values. The following options are available:

- Moody's
- S & P

Rating Value

Specify the rating value obtained from the rating agency selected.

Bid Factor

Specify the Bid/Ask factor corresponding to the reserve rating obtained from the rating agency.

3.14 Maintaining Age Factor Details

Age factor is a value that is used for reserve calculation for trade deals. You can maintain the age factor details in the 'Age Factor Maintenance' screen. You can invoke the 'Age Factor Maintenance' screen by typing 'TLDAFMNT' in the field at the top right corner of the Application tool bar and clicking on the adjoining arrow button.

You can specify the following details here:

Module Code

Select the module to which you want to associate the age factors.

Module Description

The module description appears once the module code is selected.

Till Days

Specify the till days for which you want to maintain the age factor.

Age Factor

Specify the age factor associated with the till days specified.

3.15 Mapping of SLT Product, Portfolio Expense Code, Internal Customer

This section contains the following topics:

- [Section 3.15.1, "SLT Product Mapping"](#)
- [Section 3.15.2, "Portfolio Expense Code Mapping"](#)
- [Section 3.15.3, "Internal Customer Mapping"](#)

3.15.1 SLT Product Mapping

You can invoke the 'SLT Product Mapping' screen by typing 'TLDPRDMP' in the field at the top right corner of the Application tool bar and clicking on the adjoining arrow button.

Desk Code

Desk code is one of the deciding factor as each desk may have require product set up.

Branch

Branch code also be used as one of the selection criteria. “ALL” option is allowed in case if there are no branch specific set up requirement.

Settlement Applicable

This parameter indicates if the trade requires the trade settlement and agency hand off.

Product

This field is used to capture the SLT product by which trade is going to book.

CLP product

When trade is of ORIG Desk, then ‘CLP Product’ should be ‘Yes’.

3.15.2 Portfolio Expense Code Mapping

Portfolio can be mapped to multiple expense codes in portfolio expense code mapping screen.

You can invoke the ‘Portfolio Expense Code Mapping’ screen by typing ‘TLDPEMAP’ in the field at the top right corner of the Application tool bar and clicking on the adjoining arrow button.

Portfolio Expense Code Mapping

New Enter Query

Portfolio Details

Portfolio * Portfolio Description

Expense Code

1 Of 1 Go + -

Expense Code *	Expense Code Description

Maker Date Time: Mod No Record Status
 Checker Date Time: Authorization Status

Exit

3.15.3 Internal Customer Mapping

In OBCL, branch specific inter company customers are maintained.

If the trade has the combination of the branch and customers maintained, then in this maintenance, such trades are identified as inter company trades.

You can invoke the 'Internal Customer Mapping' screen by typing 'TLDICMNT' in the field at the top right corner of the Application tool bar and clicking on the adjoining arrow button.

Inter Company Customer Detailed

New Enter Query

Module Code

1 Of 1 Go

<input type="checkbox"/>	Branch *	Customer No *

Maker Date Time: Mod No Record Status
 Checker Date Time: Authorization Status

Exit

3.16 Maintaining SLT Fee Class

You can invoke the 'SLT Fee Class Maintenance' screen by typing 'TLDFEECL' in the field at the top right corner of the Application tool bar and clicking the adjoining arrow button.

SLT Fee Class Maintenance

New Enter Query

Class Details

Module * TL Module Description Secondary Loan Trading

Class Code * Class Description

Fee Component Details

Fee Type * Status Tracking Required

DCF Category

Fee Calc Basis

Fee Basis

Maker Date Time: Mod No Record Status

Checker Date Time: Authorization Status

Exit

Module

By default, TL module is displayed. This field is a non-editable

Class Code

Fee class name is user input text field

Fee Type

- Broker Fee
- Break-fund Fee
- Waiver Fee
- Assignment Fee
- Amendment Fee
- Adhoc Buyer Fee
- Adhoc Seller Fee
- Line/Accommodation Fee
- DCF or Delayed Compensation Fee

DCF Category

- DCF_FIX_INT – all-in-rate interest for fixed type drawdowns
- DCF_FIX_MARGIN – interest using margin for fixed type drawdowns
- DCF_FIX_COC – cost of carry for fixed type drawdowns
- DCF_FLT_INT – all-in-rate interest for floating type drawdowns
- DCF_FLT_COF – cost of funds for floating type drawdowns
- DCF_FLT_COC – cost of carry for floating type drawdowns

- DCFUTILIZ – utilization fee
- DCFFACILITY – facility fee
- DCFSTBYLC – standby LC fee
- DCFCOMMLC – commercial LC fee
- DCFCOMM – commitment fee

Fee Calc Basis

SLT and Agency are the two options available in fee calculation basis

Fee Basis

- 30(Euro)/360
- 30(US)/360
- Actual/360
- 30(Euro)/365
- 30(US)/365
- Actual/365
- 30(Euro)/Actual
- 30(US)/Actual
- Actual/Actual

Status Tracking Required

This check box is available for only DCF type fees

4. Defining Attributes of an SLT Product

This chapter contains the following sections:

- [Section 4.1, "Introduction"](#)
- [Section 4.2, "Control Accounts for SLT Trades"](#)

4.1 Introduction

In this chapter, you can define attributes specific to a Secondary Loan Trading product.

You can create an SLT product and maintain basic information relating to the product such as the product code, description, product type and so on, in the 'Secondary Loan Trade - Product Definition' screen.

This section contains the following topics:

- [Section 4.1.1, "Specifying Product Preferences"](#)
- [Section 4.1.2, "Specifying Fee Details"](#)

You can invoke the 'Secondary Loan Trade- Product Definition' screen by typing 'TLDPRMNT' in the field at the top right corner of the Application tool bar and clicking on the adjoining arrow button.

The screenshot shows the 'Secondary Loan Trade - Product Definition' window. The title bar includes 'Secondary Loan Trade - Product Definition' and window control icons. Below the title bar is a toolbar with 'New' and 'Enter Query'. The main content area contains the following fields and controls:

- Product Code ***: A text input field with a red asterisk indicating it is required.
- Product Description**: A text input field.
- Product Module**: A dropdown menu with 'TL' selected.
- Module Description**: A dropdown menu with 'Secondary Loan Trading' selected.
- Product Type**: Two radio buttons, 'Trade' (selected) and 'Position Product'.
- Product Slogan**: A text input field.
- Product Group ***: A text input field with a red asterisk indicating it is required.
- Product Group Description**: A text input field.
- Start Date**: A date input field with the format 'YYYY-MM-DD'.
- End Date**: A date input field with the format 'YYYY-MM-DD'.
- Format Name**: A text input field.
- Remarks**: A text input field.

At the bottom of the window, there is a navigation bar with the following links: Accounting Roles | Events | Preferences | MIS | Fees | Fields | Change Log. Below the navigation bar is a status bar with the following fields: Maker, Date Time, Mod No, Record Status, Checker, Date Time, Authorization Status, and an Exit button.

For an SLT product, you can define generic attributes such as branch, currency, customer restrictions, and so on, by clicking on the appropriate icon in the horizontal array of icons in this screen. In addition to these generic attributes, you can define attributes specifically for an SLT product. These attributes are discussed in detail in this chapter.

For further information on these generic product attributes, refer the following Oracle Banking Corporate Lending User Manuals.

- Products

- Charges and Fees
- User Defined Fields
- Settlements

You can specify the following details specific to SLT module, in this screen:

Product Code

Specify a unique identification code for the SLT product.

Product Module

The product module displays a default value 'LT' indicating Secondary Loan Trading.

Product Type

Select the type of the SLT product from the drop-down list. The following options are provided:

- Trade
- Position Product

Description

Specify a suitable description for the product.

Product Slogan

Specify a slogan for promoting the product.

Product Group

Select the group to which the product belongs from the option list provided.

Start Date

Specify the date on which the product becomes effective.

End Date

Specify the date on which the product ceases to be effective.

Format Name

Select the format name to be used to generate the customer reference number.

Remarks

Specify additional remarks regarding the SLT product, if any.

4.1.1 Specifying Product Preferences

Preferences are the options available for defining the attributes of a product. You can specify the preferences associated with an SLT product in 'Secondary Loan Trade – Product Preferences' screen. To invoke this screen, click 'Preferences' in the Product Definition screen.

You can specify the following details in this screen:

Settlement Days

Specify the number of days after the trade, within which settlement should happen.

Settlement/Funding Memo Required

Select this check box to indicate that a settlement or a funding memo needs to be sent to the trade counterparty.

Internal Deal

Select this check box to indicate that the trade deal involved is an inter company deal.

Note

You need to deselect 'Settlement/Funding Memo Required' for internal deals.

Suppress Ticket Settlement

The 'Suppress Ticket Settlement' check box is cleared by default. You can select this check box as part of product amendment.

You are not allowed to select 'Suppress Ticket Settlement' check if the 'Automate Ticket Settlement' check box is not selected and authorized in the 'Loans Parameters' screen.

Note

The system does not validate if the 'Automate Ticket Settlement' check box is not selected in the 'Loans Parameters' screen when the 'Suppress Ticket Settlement' is selected and authorized in the 'Secondary Loan Trade- Product Definition' screen.

The system does not validate if the 'Suppress Ticket Settlement' check box is not selected in the 'Secondary Loan Trade- Product Definition' screen when the new flag 'Automate Ticket Settlement' is checked/unchecked in the 'Loans Parameters' screen.

If the 'Suppress Ticket Settlement' check box is selected, the trades booked under the product are excluded from systematic settlement even if the 'Automate Ticket Settlement' check box is selected in the 'Loans Parameters' screen.

If the 'Suppress Ticket Settlement' check box is not selected, the trades are settled systematically if the 'Automate Ticket Settlement' check box is selected in the 'Loans Parameters' screen.

If you copy an existing product with the 'Suppress Ticket Settlement' check box selected, the check box value is not copied.

Markit Trade Settlement Allowed Check box - Loans Parameters Screen	Automate Ticket Settlement Check box - Loans Parameters Screen	Suppress Ticket Settlement Check box - SLT Product Definition Screen	Processing in Corporate Lending
Selected	Selected	Not Selected	The system processes the effective Markit SDN message and the settlement systematically. Only effective SDN notices that are received from Markit are processed. Other notices are not processed.
Not Selected	Selected	Not Selected	Any notice received from Markit is not processed. You should process trade settlement manually.
Selected	Not Selected	Not Selected	The notices received from Markit is processed. However systematic trade settlement is not processed on receipt of notices from Markit. All the notices such as trade match, syndicated loan trade allocation, trade status update, settlement details and trade closed notice are processed.

Not Selected	Not Selected	Not Selected	Any notice received from Markit is not processed. You should process trade settlement manually.
Selected	Selected	Selected	For the trades contracts booked under this product, neither the new automated settlement process on receipt of effective SDN is done nor the old set of Markit notices are processed. You should process trade settlement manually.
Not Selected	Selected	Selected	Any notice received from Markit will not be processed. User should process trade settlement manually.
Selected	Not Selected	Selected	The notices received from Markit will be processed. However systematic trade settlement will not be processed on receipt of notices from Markit. All the notices such as trade match, syndicated loan trade allocation, trade status update, settlement details and trade closed notice will be processed by Oracle Banking Corporate Lending.
Not Selected	Not Selected	Selected	Any notice received from Markit will not be processed. User should process trade settlement manually.

Specifying Holiday Preferences

You can indicate your preferences for holiday treatment, here.

Holiday Ccy

Select the currency associated with a trade deal, for which you want to specify the holiday preferences.

Ignore Holidays

Select this check box to indicate that the settlement date is fixed without taking the holidays into account.

Consider Branch Holiday

Select this check box to indicate that the settlement date is fixed taking into consideration the holidays specified for the branch.

Apply Local Holiday Currency

Select this check box to indicate that local currency holidays need to be taken into consideration while fixing the settlement date.

Apply Contract Holiday Currency

Select this check box to indicate that the contract currency holidays need to be taken into consideration while fixing the settlement date.

Apply Fin Centre Holiday Currency

This check box allows you to enable financial centre holiday treatment and add the financial centres for the holiday treatment.

For more information about maintaining financial centre for holiday treatment refer to Products User Manual.

Specifying DCF Details

Delayed compensation fee is associated with trades for which the trade settlement date exceeds the expected settlement date. You can specify the following preferences related to DCF here:

Accrual Required

Select this check box to indicate that you need to accrue the delayed compensation fee component at specific intervals.

Frequency

Select the frequency at which you would like to accrue the delayed compensation fee, from the options provided in the drop-down list. The following options are available:

- Daily
- Monthly
- Quarterly
- Half yearly
- Yearly

Start Month

Select the month in which the accrual of the fee component has to begin, from the drop-down list provided.

This is applicable if you specify any accrual frequency other than daily or monthly.

Start Day

Specify the date on which the accrual should be done during the month. For example, if you specify the date as '20', accrual is carried out on that day of the month, depending on the accrual frequency.

Allow Amendment of Non Accrual

Select this check box to indicate that the system allows you to change the preference maintained for the box 'Stop DCF Accrual' at Position contract level.

Specifying Rekey Details

Trade Date Accounting

Select this check box to indicate that the trade date accounting functionality is applicable for the following products maintained for CFPI trading:

- SLT trade product
- Internal product
- Position product

If this check box is deselected for any product, then system does not post trade date accounting entries for the contract associated with the product. This results in position break in control accounts.

Note

You cannot amend this check box once the product is authorized.

Rekey Required

Select this check box to indicate that certain important details related an SLT need to be rekeyed, at the time of authorization. You can specify any or all of the following as rekey fields:

- Counterparty
- Currency
- Trade Amount
- Trade Price
- Trade Date
- Expt Settl. Date

HFS Transfer

Select this check box to indicate that trades under this product should be considered as HFS transfer transactions. Note that you can select this check box only if the check box 'HFS transfer and Sale' is selected in the 'Loan Parameters' screen.

Once the product is authorized, you cannot deselect this check box.

LMA/LSTA Participation

The 'LMA / LSTA Participation' (Loan Market Association /Loan Syndications and Trading Association, Inc.) check box is not selected by default. This check box is enabled only for 'Trade' products. Even after authorization, you can edit this check box.

However, the change in the value of check box impacts only the new trades booked under the product. Existing trade contracts are not impacted. The value of the check box is copied when you copy an existing trade product with the check box selected.

Product Restrictions

When you create a product, you can provide product restrictions. That is, you can specify the branches of your bank that can offer this product, the currencies that are allowed or disallowed and the customers who can avail the product.

You can set preferences in this screen and the same is defaulted to 'Bilateral Loan and Commitment Restrictions' screen.

4.1.2 Specifying Fee Details

You can specify the details regarding the fee associated with an SLT in 'SLT Product Fees Details' screen. To invoke this screen, click 'Fees' in the 'Secondary Loan -Product Definition' screen.

The screenshot shows the 'SLT Product Fees Details' window. At the top, there are input fields for 'Product' and 'Product Description'. Below this is a 'Fee Details' section with a table. The table has two columns: 'Component' and 'Description'. The 'Description' field is highlighted with a blue button labeled 'Default From Class'. Below the table are several dropdown menus: 'Fee Type', 'DCF Category', 'Fee Calc Basis', and 'Fee Basis'. At the bottom, there are two checkboxes: 'Stop Association' and 'Status Tracking Required'. The window ends with 'Ok' and 'Cancel' buttons.

You can specify the following details regarding fee, in this screen:

Component

Specify the name of the fee component for which you are maintaining the details.

Description

Specify a suitable description for the fee component.

Fee Type

Select the type of the fee from the drop-down list. The following options are provided:

- Broker Fee
- Break-fund Fee
- Waiver Fee
- Assignment Fee
- Amendment Fee
- Adhoc Buyer Fee
- Adhoc Seller Fee
- Line/Accommodation Fee
- DCF or Delayed Compensation Fee

DCF Category

Select the sub category associated with the delayed compensation fee from the drop-down list. The following options are provided:

- DCF_FIX_INT – all-in-rate interest for fixed type drawdowns
- DCF_FIX_MARGIN – interest using margin for fixed type drawdowns
- DCF_FLT_INT – all-in-rate interest for floating type drawdowns
- DCF_FLT_COF – cost of funds for floating type drawdowns
- DCF_COC - calculates COC for all type of funded amounts together.
- DCFUTILIZ – utilization fee
- DCFFACILITY – facility fee
- DCFSTBYLC – standby LC fee
- DCFCOMMLC – commercial LC fee
- DCFCOMM – commitment fee

DCF category is enabled only if you select the fee type as 'DCF'.

The formula to calculate COC is given below;

- $$\frac{(\text{Funded Amount} * \text{Price} - (\text{Unfunded Amount} + \text{Commitment Reduction}) * (1 - \text{Price})) * (\text{Average LIBOR Rate}) * (\text{No of Days})}{\text{Denominator basis}}$$

The computation is done based on the method 'Rule of 25' and will continue until the actual settlement date. The derivation of 'Rule 25 on T+20 and T+21' is mentioned below:

$$\frac{[(\text{Fund} * \text{Price} - (\text{Unfunded} + \text{Commitment Reduction}) * (1 - \text{Price})) \text{ as of T+20 (Expected Settlement Date)}}{\text{Rule-25-factor on T+20} = \text{-----}}$$

$$\frac{[(\text{Fund} * \text{Price} - (\text{Unfunded} + \text{Commitment Reduction}) * (1 - \text{Price})) \text{ as of Trade Date}}{\text{Rule-25-factor on T+20} = \text{-----}}$$

$$\frac{[(\text{Fund} * \text{Price} - (\text{Unfunded} + \text{Commitment Reduction}) * (1 - \text{Price})) \text{ as of T+21}}{\text{Rule-25-factor on T+21} = \text{-----}}$$

$$\frac{[(\text{Fund} * \text{Price} - (\text{Unfunded} + \text{Commitment Reduction}) * (1 - \text{Price})) \text{ as of T+21}}{\text{Rule-25-factor on T+21} = \text{-----}}$$

$$\frac{[(\text{Fund} * \text{Price} - (\text{Unfunded} + \text{Commitment Reduction}) * (1 - \text{Price})) \text{ as of Trade Date}}{\text{Rule-25-factor on T+21} = \text{-----}}$$

$$\frac{[(\text{Fund} * \text{Price} - (\text{Unfunded} + \text{Commitment Reduction}) * (1 - \text{Price})) \text{ as of Trade Date}}{\text{Rule-25-factor on T+21} = \text{-----}}$$

Note

- For distress trades, the Rule-25 factor is computed starting from the Expected settlement date (T+20) till the actual settlement date.
- DCF category is applicable only for distress type of desk.
- If Rule of 25 becomes 'Yes' for the current application date, then it remains 'Yes' for all the subsequent dates, even if the variance changes to less than 25% for the same date due to some Back valued activities entered in the subsequent date.
- If Rule of 25 remain 'No' from the Expected settlement date till the previous application date and if it becomes "Yes" while computing the factor on the current application date due to some back valued activities, then the Rule of 25 is applicable from the current application date only, not from the past dates.
- DCF COC value remains positive during the computation period.

- Till the Rule of 25 is 'No', the basis amount for DCF-COC computation is the COC basis amounts as on Expected Settlement Date (T+20). From the date Rule of 25 is 'Yes', basis amount for DCF-COC computation is derived on daily basis.
 - Once the Rule of 25 becomes 'Yes', the daily balances are considered for the COC even if the Rule of 25 factors is 'No' on any subsequent date. In other words, once COC catches Rule of 25, it remain with Rule of 25 for the rest of the delayed period.
 - If the variance of the Rule-25-factor is greater than or equal to 25% (i.e. Rule-25-factor ≤ 0.75 OR Rule-25-factor ≥ 1.25) then Rule-of-25 is applicable for the computation. Otherwise Rule-of-25 is not applicable.
 - If Rule-of-25 is applicable then the system computes DCF COC on daily basis from the Expected Settlement Date to the Actual Settlement Date, as per the below formula:
-

For the trade currency,

- $(\text{Fund} * \text{Price} - (\text{Unfunded} + \text{Commitment Reduction}) * (1 - \text{Price})) * \text{Average LIBOR} * \text{Days} / \text{Denominator basis}$

For the other funded currencies,

- $(\text{Fund} * \text{Price}) * \text{Average LIBOR} * \text{Days} / \text{Denominator basis}$
- If Rule-of-25 is not applicable then system computes DCF COC as the balance available on Expected Settlement Date as per the below formula;

For the trade currency,

- $(\text{Fund amount as of Expected Settlement Date} * \text{Price} - (\text{Unfunded amount as of Expected Settlement Date} + \text{Commitment Reduction amount as of Expected Settlement Date}) * (1 - \text{Price})) * \text{Average LIBOR} * \text{Days} / \text{Denominator basis}$

For the other funded currencies,

- $(\text{Fund amount as of Expected Settlement Date} * \text{Price}) * \text{Average LIBOR} * \text{Days} / \text{Denominator basis}$

Formula to calculate DCF (Fixed and Floating type of drawdowns) is given below;

- $\text{Funded amount} * (\text{Actual Settlement Date} - \text{Expected Settlement Date}) * \text{All-in Rate} / \text{Denominator basis}$

Fee Calc Basis

Select the source for deriving the 'Fee Basis' for calculating the fee amount, from the drop-down list. The following options are provided:

- Agency - Fee Basis is arrived from LB Module for the respective component
- SLT – Fee Basis needs to be manually specified at the SLT product or contract level

This is enabled if you select the fee type as 'DCF' or 'Break-fund Fee'.

Fee Basis

The Fee Basis indicates the method in which a given fee amount has to be calculated. The values in the drop-down list are:

- 30(Euro)/360
- 30(US)/360
- Actual/360
- 30(Euro)/365

- 30(US)/365
- Actual/365
- 30(Euro)/Actual
- 30(US)/Actual
- Actual/Actual

This is enabled if you select the fee type as 'DCF' or 'Break-fund Fee'. If you specify the Fee Calc Basis as 'Agency', this will get disabled.

Stop Association

Select this check box to indicate the fee component should not be associated with the product henceforth.

Note

There are no fee components associated with internal deal type of products.

Status Tracking Required

Select this check box to allow the system to start and restart accrual of DCF components.

Note

You can select this check box only for the following type of DCF components:

- DCF FUNDED FLOATING COF
 - DCF FUNDED FLOATING INT
 - DCF FUNDED FIXED INTEREST
 - DCF FUNDED FIXED MARGIN
 - DCF UNFUNDED COMMLC
 - DCF UNFUNDED COMM
 - DCF UNFUNDED FACILITY
 - DCF UNFUNDED STANDBYLC
 - DCF UNFUNDED UTILIZED
-

4.2 Control Accounts for SLT Trades

This section contains the following topics:

- [Section 4.2.1, "Processing Products with Control Accounts"](#)
- [Section 4.2.2, "Processing SLT Batch for Trade Date Accounting"](#)
- [Section 4.2.3, "Control Account for Origination Contracts"](#)

Control accounts can be a GL or a customer account, which is used to distinguish the trade date and settlement date balances for a given SLT trade. The following table gives a brief description of the various control accounts:

Control Account	Description
Control Account#1	Account to track the latest trade portion of funded amount

Control Account#2	Account to track the trade portion of funded amount as of settlement date
Control Account#3	Account to track the Premium/Discount and PNL amount as of trade date
Control Account#4	Account to track the Premium/Discount and PNL amount as of settlement date

In SLT module, accounting entries are defined for the following products with control accounts:

- SLT trade product
- Internal product
- Position product

4.2.1 **Processing Products with Control Accounts**

System does a zero-based computation to arrive at the trade portion of funded and unfunded amount. System also computes the premium discount and PNL amount. Based on the accounting setup, system appropriately posts the accounting entries to the control accounts for SLT trades and origination contracts. For zero-based computation, system considers the latest trade amount from SLT as well as the funded and unfunded amount as on the application date for the CUSIP from agency.

Funded and unfunded percentage is calculated as follows:

- $\text{Funded percentage} = (\text{Tranche outstanding amount} / \text{Sum of tranche outstanding and tranche available amount}) * 100$
- $\text{Unfunded percentage} = (\text{Tranche available amount} / \text{Sum of tranche outstanding and tranche available amount}) * 100$

Note

- Tranche outstanding amount is the total of the underlying non-LC drawdown's outstanding
 - Tranche available amount is the total of Tranche availability and underlying LC drawdown's outstanding.
 - During commitment reduction or trade amendment, system considers the balances already posted to the inventory accounts and any difference is additionally posted as trade date accounting.
 - If the CUSIP does not exist in agency (LB) module, then system considers the tranche to be fully funded.
-

System posts the accounting entries in SLT module as follows:

- During SLT trade booking system considers the latest funded and unfunded percentage from agency as on the Application date and computes the trade portion of funded, unfunded, premium/discount and PNL amount, and then passes the trade date accounting entries
- During SLT trade amendment for open trades including commitment reduction, system looks at the balances already posted to the inventory accounts and any difference is additionally posted. Funded and unfunded balance in agency as of application date and the latest trade amount from SLT are used for zero based computation.

- For commitment reduction on settled trades, system posts the delta entries for the differential funded amount at the internal trade level. There is no change in the functionalities of internal trades which are booked during commitment reduction on settled trades, other than posting the additional funded amount for CFPI trade date accounting entry.
- During trade settlement, unsettled position becomes settled and the trade portion of funded amount and PNL/premium discount balance is moved to the control accounts.
- During trade settlement, offsetting entries are booked in control accounts instead of reversing the posted accounting entries in trade booking.
- Any agency activity for tranches and drawdowns resulting in change of the available or outstanding amount of the tranche will change the funded and unfunded percentage of the trade amount for SLT trades. System tracks these changes for SLT trades as part of end of day batch process.
- Since accounting entries cannot be posted for the settled trades, system posts the delta accounting entries for the funded portion at the position contract level during the batch process.
- For any trade amendment post settlement, the settlement has to be reversed first and then the amendment has to be applied and resettled operationally.
- Reversal of settlement reverses the settlement entries and the position is moved from settled to unsettled. Any subsequent amendments to these trades go through zero-based calculation and post additional entries.
- Reversal of trade reverses all the trade dated and settlement dated accounting entries
- Memo account is used only for partially funded or completely unfunded scenarios.
- To recall, you can make changes to the accounts (GLs) mapped at the product level accounting entry setup. However, there will not be any change in the accounting entries already posted for the contracts associated with the product for such product level account (GL) amendments and reconciliation of balances for such accounts should be handled operationally.

4.2.2 Processing SLT Batch for Trade Date Accounting

The SLT Batch for trade date accounting is used to track the funded or unfunded balance change for the associated CUSIP in the agency module. System computes the funded and unfunded percentage based on funded and unfunded balance from agency as of application date and applies the percentage on the latest trade amount in SLT to arrive at the trade portion of the funded and unfunded amount.

The computed trade portion of funded and unfunded balances is compared with the funded and unfunded balances already posted for the SLT trades. If there is any difference, then system posts the additional entries for the funded and unfunded amount as follows:

- The event 'TDCH' (Trade Date Balance Change) posts additional funded and unfunded amounts
- If the trade is open, then the TDCH event is registered for the trade to pass accounting entries for the differential funded and unfunded amount
- If the trade is settled, then the TDCH event is registered for the position contract to pass accounting entries only for the differential funded amount

4.2.3 Control Account for Origination Contracts

Trade settlement flowing to origination module through STP processing impacts the control accounts instead of the inventory accounts for the loan contracts

You should manually maintain the appropriate control account (Control Account#2) at the origination loan product level so that the accounting entries are posted at control account 2 during trade settlement which flows to origination module through STP.

All the independent loan activities manually performed by a user such as new loan booking, value dated amendment for loan principal increase/decrease, loan payment and all the corresponding reversal events will post the accounting entries at control account 2, based on the product accounting setup.

Note

- CFPI trade date accounting entries are not applicable for CLP trades.
 - CFPI positions are tracked in a separate Oracle Banking Corporate Lending branch and new set of products are used in agency, origination and SLT modules for CFPI trading in Oracle Banking Corporate Lending.
 - Appropriate accounting entry set up should be done at the SLT and OL loan products to pass accounting entries for unfunded portion of the trade amount. This should be operationally controlled.
 - Control accounts may not get reconciled if there are STP failures between TL to LB or LB to OL. This should be operationally controlled.
 - Control account is applicable for funded amount and memo GL is applicable for unfunded amount.
 - Since the accounting entries are defined at the product level for the trade settlement with identified accounting roles/accounting entry, if there is any change to the mapped GL then balance re-class has to be handled manually.
-

5. Processing an SLT Contract

This chapter contains the following sections:

- [Section 5.1, "Introduction"](#)
- [Section 5.2, "Viewing Exceptions Summary"](#)
- [Section 5.3, "Viewing Draft Trade Summary"](#)
- [Section 5.4, "Processing Internal Trades for HFI to HFS Transfer"](#)
- [Section 5.5, "Viewing Processed Trades"](#)
- [Section 5.6, "Querying Trade Contract"](#)
- [Section 5.7, "Capturing Agency Details"](#)
- [Section 5.8, "Capturing Origination Trade Details"](#)
- [Section 5.9, "Trading with PIK Facility"](#)
- [Section 5.10, "Querying Position Balances"](#)
- [Section 5.11, "Calculating Realized Profit and Loss"](#)
- [Section 5.12, "Re-valuating Positions"](#)
- [Section 5.13, "Maintaining CUSIP-Tranche Linkage"](#)
- [Section 5.14, "Viewing CUSIP-Tranche Linkage Summary"](#)
- [Section 5.15, ".Capturing Funding Memo Details"](#)
- [Section 5.16, "Settling Trades Individually"](#)
- [Section 5.17, "Settling Trades at Ticket Level"](#)
- [Section 5.18, "Settling Combined Tickets"](#)
- [Section 5.20, "Settling DCF on First-time"](#)
- [Section 5.21, "Reversing Trade Settlement"](#)
- [Section 5.22, "Reversing Trade"](#)
- [Section 5.23, "Calculating Reserve "](#)
- [Section 5.24, "Reclassification"](#)
- [Section 5.25, "Agency Confirmation"](#)
- [Section 5.26, "Amending an SLT Contract "](#)
- [Section 5.27, "Processing Silent Participation"](#)
- [Section 5.28, "Processing Swap Deals"](#)
- [Section 5.29, "Forward Processing of Events "](#)
- [Section 5.30, "SLT Processing for LMA / LSTA Participation"](#)
- [Section 5.31, "SLT Processing for Primary Delayed Compensation"](#)

5.1 Introduction

A contract is a specific agreement or transaction entered into between two or more entities. In SLT module, the trade details for initiating a contract can originate from any of the following sources:

- Trade details can be manually entered in SLT module
- Trade details can be uploaded from the external system, Loans QT
- Trade deal can originate from the LB module

Except for trades originating from LB, you can use the 'Secondary Loan Trading - Draft Trade' screen to enter the details of the contract.

This section contains the following topics:

- [Section 5.1.1, "Specifying Trade Details"](#)
- [Section 5.1.2, "Specifying Markit/ClearPar Details"](#)
- [Section 5.1.3, "Specifying Contract Details"](#)
- [Section 5.1.4, "Specifying Booking Details"](#)
- [Section 5.1.5, "Specifying Other Details"](#)
- [Section 5.1.6, "Specifying Holiday Preferences"](#)

You can invoke the 'Trade- Online' screen by typing 'TLDTDONL' in the field at the top right corner of the Application tool bar and clicking on the adjoining arrow button.

When you click the 'New' from the menu, the 'Trade Type' screen is displayed where you can specify the type of the trade you want to perform.

You can specify the following details in this screen:

Trade Type

Select the type of your trade from the drop-down list provided. From the menu, select 'New' to specify the details for a new trade deal. or select 'Modify' if you want to modify the details of an existing deal

Contract Ref. No.

Select the reference number of the contract whose details you want to modify, from the option list provided. This is applicable only for "Modiy" type of trades.

Product

Select the product code of the trade product you want to use for the trade deal, from the option list. All trade products maintained in the 'Secondary Loan Trade - Product Definition' screen are displayed in the list.

Product is enabled only for 'New' trades.

Position Identifier

Select the position identifier or the branch-desk-expense code combination, to be used to track the position details of a portfolio. Position identifiers corresponding to all the portfolios defined for the current branch are displayed in the option list.

Position identifier is enabled only for 'New' trades.

5.1.1 Specifying Trade Details

The following details are defaulted for a new trade:

- External Contract Ref No which indicates the reference number in the external system Loans QT
- Upload reference number and User reference number
- Product code, department and treasury details
- Branch, desk, expense code and portfolio details
- Position identifier and position qualifier
- Booking date of the trade

The trade reference number gets generated on successful processing of the trade contract.

You can specify the following details related to the trade, in this screen:

CUSIP/ISIN

Specify the unique reference number indicating the facility to be associated with the deal. You can specify either a new CUSIP number or an existing CUSIP whose details have already been captured in the LB module.

Facility Name

Specify a name for the facility, if you are entering a new CUSIP. For existing CUSIP, the related facility name gets defaulted here.

Ticket Id

Specify a ticket Id to be associated with the trade. Many trades can be grouped together under one ticket.

All trades under the same ticket must have same trade date, expected settlement date and counterparty. In case of line trades, the counterparty can be different.

Note

Ticket Id can be 'NULL' if the trade originated as part of agency creation.

Cascade Participation

This option is selected by default. You can deselect this check box if the trade is Non Pro-rata CUSIP and the agency details are not available in the system. This is applicable only for 'Par' and 'Distress' types of trade.

For the trades in the Non Pro-rata, the DCF computation is considered as follows:

- DCF-FIX-MARGIN - Applicable only for 'Par' trades
- DCF-FIX-INT and DCF-FIX-COC – applicable for 'Distress' trades

5.1.2 **Specifying Markit/ClearPar Details**

Trade ID

Specify the trade id to uniquely identify the associated SLT trade in Oracle Banking Corporate Lending for each of the trade sent from Markit.

Note

If LQT trade that is received for trade booking (TBOK) is in 'Failed' / 'Enrich' / 'Extracted' status then you are not allowed to input (if ClearPar trade ID is blank) or override (if ClearPar trade ID is not blank) the ClearPar trade ID value in 'Draft Trade' screen while processing such trades.

You are allowed to input the ClearPar trade ID in 'Draft Trade' screen when trade is manually booked (TBOK) in Oracle Banking Corporate Lending.

The maximum length for ClearPar trade ID is 25.

Trade booking or amendment fails in LQT trade browser if LQT sends ClearPar trade ID with special characters. You have to reject and resend the trade from LQT with corrected ClearPar trade ID.

You cannot save trade in draft trade screen (manual TBOK) with special characters in Markit /ClearPar trade ID.

Note: Blank space is allowed in ClearPar trade ID. If more than one ClearPar trade ID is associated with a trade then those can be separated by a blank space.

You cannot amend ClearPar trade ID during trade amendment (TAMD) processing. However, Oracle Banking Corporate Lending updates the trade systematically with the new ClearPar trade ID during trade amendment when LQT sends the revised value.

If a trade amendment leads to reversal and rebook, then the new trade is updated with the ClearPar trade ID from the old (reversed) trade

Allocation ID

Specify the allocation id for the matching processing and manual linkage of SLT and Markit trades.

5.1.3 **Specifying Contract Details**

Counterparty

Select the unique identification of the counterparty involved in the trade deal from the option list. The list of all valid customers is displayed from which you can select the counterparty.

Note

The buyer or seller should be an existing customer of your bank.

Currency

Select the currency to be associated with the tranche from the option list provided.

Trade Amount

Specify the tranche amount that you want to buy or sell. The amount you specify here should not exceed the total amount for the tranche.

Trade Price

Specify the price at which the trade transaction is being carried out.

Original Trade Amount

The trade amount specified at the time of booking the contract gets displayed. Original trade amount is not impacted by any further amendments to the trade amount. This is used for calculating the broker fee involved in the trade.

Type

Select the contract type from the options available. The type of contract is not considered while processing the trade.

Quotation

Select the type of quotation to be associated with the trade, from the drop-down list. The following options are available:

- Flat – delayed compensation fee will not be computed for deals booked under this quotation method, even if there is delay in settlement
- SWOA - Delayed compensation fees will be computed from the expected settlement date(T+7 or T+21)

PIK Amount

Specify the PIK portion associated with the funded amount for the trade.

Buy/Sell Indicator

Select 'Buy' option to indicate that the related trade is a buy transaction or select 'Sell' to indicate that it is a sell transaction.

Trade Type

Select the type of the trade from the drop-down list. The options available are as follows:

- Customer Trade
- Line Accommodation

Deal Type

Select the type of the trade deal from the drop-down list. The following options are available:

- Assignment – where bank is directly involved in the trade
- Participation – where bank is silently participating in the trade

Commitment Reduction Amount

Specify the amount indicating a reduction in the commitment amount for the tranche.

Commitment Reduction Price

Specify the commitment reduction discount/ premium price for trade booking and trade amendment. You cannot amend 'Commitment Reduction Price' alone as part of commitment reduction amendment.

Note

'Commitment Reduction Price' in the 'Draft Input' screen cannot be amended as part of any normal amendment.

Collateral %

Specify the collateral percentage.

Transfer Price

The system displays the price entered while processing the associated HFS transfer as part of PRAM in the LB module. This value is displayed only for trades processed as part of HFI to HFS transfer.

HFS Transferred Cost Basis

The system displays the lowest of LOCOM Carry Value and Transfer price, and displays it here for internal sell trades processed as part of HFI to HFS transfer.

5.1.4 Specifying Booking Details

You can specify the following details related to the booking of a trade deal

Booking Date

Booking date is the date on which the trade transaction is initiated. The system date gets defaulted here.

Trade Date

Specify the date on which the actual trade happens.

Note

Trade date cannot be greater than the expected settlement date.

Expt. Settl. Date

Expected settlement date is defaulted based on the trade date and the settlement days, maintained in the 'Product Preferences' screen. You can modify this, if required.

Maturity Date

Specify the contract maturity date or select the maturity date from the calendar available. Maturity date is not considered while processing the trade.

5.1.5 Specifying Other Details

You can specify following other details related to the trade deal:

Agency Id

Select the Id of the lead agent of the transaction, to whom the assignment fee needs to be sent.

Broker

Select the Id of the broker involved in the deal, if any, to whom the broker fee needs to be sent.

Assignment Fee Remitter

Select the party that remits the assignment fee to the lead agent. The options available are as follows:

- Buyer
- Seller

Ext CUSIP/ISIN

Specify the external CUSIP number to be associated with the trade deal.

Borrower

Specify/select the borrower from the options available. Borrower is not considered while processing the trade.

Commitment Reduction/Increase Amendment

Select this check box to indicate that the amendment is due to commitment reduction/increase..

PIK Amendment

Select this check box to indicate that the amendment is due to PIK component associated with the trade amount.

Parent Line Trade

Select this check box to indicate that the associated customer trade is created as a result of a line trade.

Note

This is applicable only for trades of type 'Customer Trade'.

Apply Cmt Redn/PIK for CUSIP Amendment

Select this check box to indicate that reduction in commitment amount is applicable for the tranche during CUSIP amendment. The reduction is applicable only if the trade has commitment reduction/PIK amount.

Primary Trade

If the 'Primary Trade' is selected, the system identifies the trade as a primary trade.

The value of the 'Primary Trade' check box is defaulted from the 'Draft Trade Input' screen. For the trades booked from LQT, the value of the 'Primary Trade' is defaulted from the value of the field 'Primary Trade' from LQT.

Document Type

The DCF (Delayed Compensation Fees) categories for a trade are derived based on the document type specified.

Select the document type from the adjoining drop down list. The list displays the following values:

- Par
- Distress

Note

- This option cannot be modified as part of trade amendment if the system date is greater than or equal to the expected settlement date.
 - Once the draft trade is processed, the document type field can be viewed in trade online screen also.
-

If the document type is 'Par' then the following funded DCF categories are applicable;

- DCF-FIX-MARGIN
- DCF-FLT-INT
- DCF-FLT-COF

If the document type is 'Distress' then the following funded DCF categories are applicable;

- DCF-FLT-INT
- DCF-FIX-INT

- DCF-COC

Trade Standard

The following are the list of values in the 'Trade Standard' drop-down list.

- LMA
- LSTA
- Non-Standard

This field is only a display-only field and the value is defaulted while processing the feed from LQT.

Firm Account Mnemonic

The system displays the corresponding firm account mnemonic based on the position identifier/portfolio.

5.1.6 Specifying Holiday Preferences

The holiday treatment preferences specified for the product gets defaulted here. You can modify there details, if required.

Ignore Holidays

Select this check box to indicate that the settlement date is fixed without taking the holidays into account.

Consider Branch Holiday

Select this check box to indicate that the settlement date is fixed taking into consideration the holidays specified for the branch.

Holiday Ccy

Select the currency associated with a trade deal, for which you want to specify the holiday preferences.

Apply Local Ccy

Select this check box to indicate that local currency holidays need to taken into consideration while fixing the settlement date.

Apply Contract Ccy

Select this check box to indicate that the contract currency holidays need to taken into consideration while fixing the settlement date.

Apply Fin Centre Holiday Currency

This check box allows you to enable financial centre holiday treatment and add the financial centres for the holiday treatment.

For more information about maintaining financial centre for holiday treatment refer to Products User Manual.

Remarks

Specify remarks, if any, to be associated with the trade contract.

After entering the basic trade details, you can validate the same by clicking 'Verify' button.

On successful validation, you can select the 'Submit' option to send the trade details for further processing, after authorization. All trades specified in this screen remains in the draft

stage until they are selected for submission. Before submitting the details for further processing, you can modify the details any number of times by unlocking the record and amending the details. You can also delete the details, if required, before it is submitted for further processing.

After successful validation of the trade details, if you select the 'Reject' option, the details specified can be rejected, in case of any discrepancies.

You can also perform an amendment of the trade details in this screen, before trade settlement.

Note

Trades uploaded from Loan QT are treated as confirmed trades by default. You cannot modify the expected settlement date, in this case.

A unique reference number called the Trade Reference Number gets generated for every processed trade and the position details of the trade are also updated. The trade details are processed further in the SLT module.

You can view the details of a processed trade in the 'Trade Online' screen.

For more details on Trade Online screen, refer the section 'Viewing Processed Trades' in this user manual.

Note

The details of trades uploaded from Loans QT are processed automatically with the default selection of 'Validation' and 'Submit' options.

5.1.7 Financial Centre Holiday Treatment

Click 'Financial Centre' tab in 'Trade Online' screen to open 'Financial Centres for Trade Expected Settle date' screen.

Trade Details

Ext Contract Ref No _____ Product _____
 Trade/Trn Ref No _____ Branch _____
 Version Number _____ Portfolio _____

Financial Centres for Trade Expected Settle date

Financial Centre	Financial Centre Description

Ok Exit

Financial center maintained at product level is defaulted in 'Draft Trade' (TLDTDUPL) screen. If required, you can add or remove the financial center.

5.2 Viewing Exceptions Summary

The exceptions arising out of validation or processing of draft trade details can be viewed in this screen. You can proceed further by unlocking the draft trade record and correcting the exceptions.

You can also view a summary of exceptions for all the failed contracts in the 'Exceptions Summary' screen. You can invoke the 'Exceptions Summary' screen by typing 'TLSERONL' in the field at the top right corner of the Application tool bar and clicking on the adjoining arrow button.

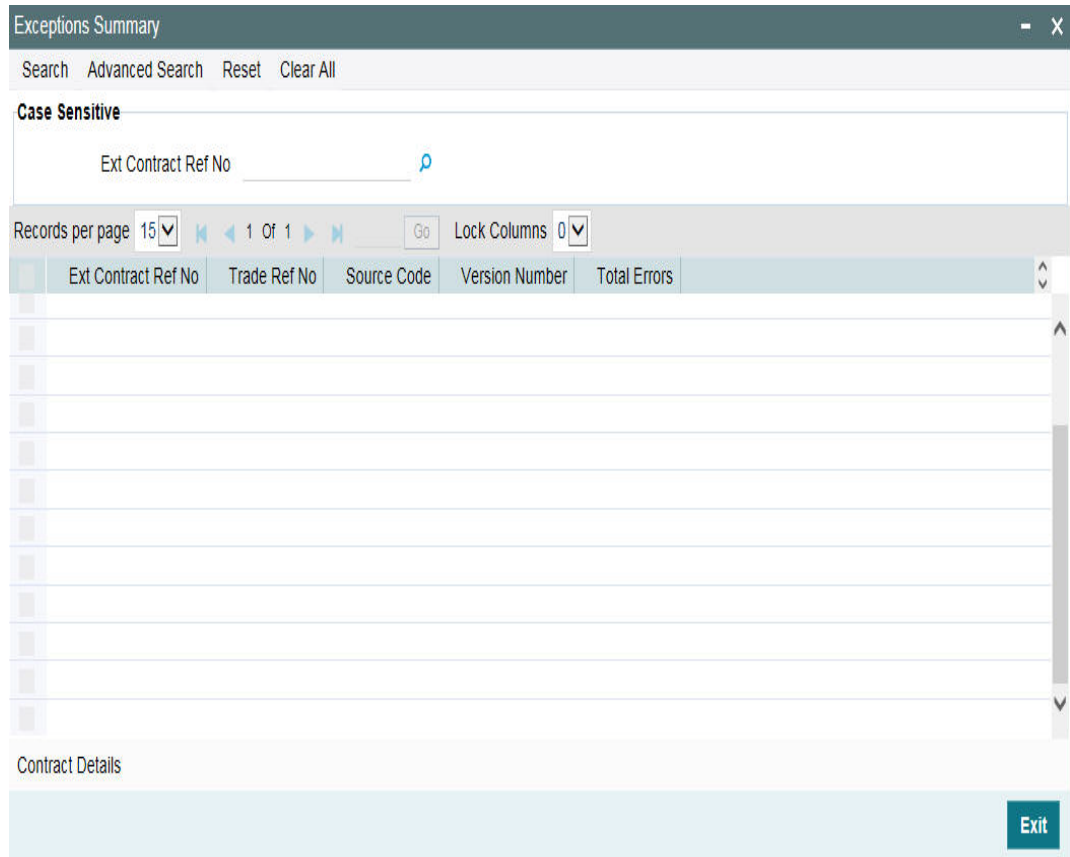

To view the exceptions related to a particular contract, click the 'Contract Details' of the contract. Alternatively, you can double-click to view the exceptions .

5.3 Viewing Draft Trade Summary

You can view a summary of all the trades entered in the Draft Trade screen, in the 'Trade Input Summary' screen. You can invoke the 'Draft Trade Summary' screen by typing 'TLSTDUPL' in the field at the top right corner of the Application tool bar and clicking on the adjoining arrow button.

In this screen you can view all trade contracts at different processing status like Unprocessed, Submit, Failed, Rejected, Drafted, and Processed.

For 'Failed' trades, you can view the errors that occurred while processing the trade by clicking 'Error Log'. Double-clicking the trade contract takes you to the 'Draft Trade' screen with the contract details.

5.4 Processing Internal Trades for HFI to HFS Transfer

In case of HFS transfer, the system automatically creates two internal trades (a 'Buy' and a 'Sell') in the SLT module based on participant transfer instructions. The 'Buy' trade increases the settled position of HFS Portfolio (by the amount of the transfer to HFS) whereas the 'Sell' trade reduces the settled position of the HFI Portfolio by a corresponding amount.

The counterparty used for the internal trades are internal customers and the settlement account maintained for these internal customers will be internal GLs. The accounting role 'CUSTOMER' represents internal GLs.

The Buy trade is booked against the HFS product mapped to the origination-HFS desk. The 'Trade Amount' for this sell trade is the 'Transfer Amount' entered in the 'Participant Transfer' screen and the Trade Price is the 'HFS Transferred Cost Basis' value computed for the Sell trade. Profit and Loss is not applicable for this trade. There are no accounting entries posted for the HFS buy internal trade processed as part of HFI to HFS transfer, including settlement entries. Weighted Average Cost (WAC) is always be '100' and it is not recomputed during the life cycle of the trades involving HFS portfolio. Transfer Mark is computed during HFI to HFS Transfer as $\text{Transfer amount} * (100 - \text{HFS Transferred Cost Basis})$. This amount is uploaded systematically on HFS commitment contract as an Amort fee during internal HFS buy trade processing.

You should have maintained and attached income and expense type of amortization fee components with 'CLP Buy Price Diff' check box selected, to the HFS commitment product. These components should be unique to a commitment product.

The entire trade amount is considered as unfunded amount while posting accounting entries during HFS transfer for internal Sell deals.

The HFI Sell trade is booked using the Origination trade product that is mapped in the 'Product Mapping' screen for CLP trade for the branch. The 'Trade Amount' for this sell trade is the 'Transfer Amount' entered in the 'Participant Transfer' screen and the Trade Price is the 'HFS Transferred Cost Basis' value.

The system picks up this HFS Transferred Cost Basis and display it in the 'Secondary Loan –Trade Online' screen during trade upload processing. The LOCOM Carry value, HFS Transferred Cost Basis and Transfer Price is computed and stored in % terms. Note that LOCOM Carry value is not displayed in the 'Secondary Loan –Trade Online' screen.

Profit and Loss due to HFI to HFS transfer is posted for the HFI internal 'Sell' deals

5.4.1 Impact on CoC Balance

Based on the 'Transfer Amount' and the overall commitment amount, the system computes the pro-rata amount for each of the following balances:

- Pro-rata reduction of write-off
- Pro-rata reduction of contra interest
- Pro-rata reduction of FAS 114 reserve
- Pro-rata reduction of FAS 91 fees, Asset Transfer Marks

Origination queue is updated for the CoC balances and automatically confirmed. Amort fee is reduced systematically on HFI commitment during internal HFI sell trade processing as part of HFS transfer. The balances computed as part of the internal trades are based on the HFS transfer amount. The amounts to be released for underlying commitment and loan/LC loan contracts in the Originations modules are computed as part of the actions (VAMI) performed on the actual contracts.

Accounting entries are posted for the prorata CoC balances for the internal sell deal.

5.4.2 Reversing Internal Trades

You have to reverse the PRAM event processed for HFI to HFS transfer in the agency module. STP for this PRAM is not processed systematically in the trading module. Upon reversal of PRAM, you have to trigger reversal events in the trading module for the internal buy and sell trades separately, to reverse the HFI to HFS transfer.

It is not possible to reverse an internal trade if the position goes negative due to the reversal.

You are not allowed to reverse the HFS internal buy trade that is processed as part of HFI to HFS transfer, if there are any open or settled trades for the CUSIP and HFS portfolio. However, you can reverse the HFS internal trade, if all the HFS open trades (sale from HFS) are reversed.

During reversal of the internal trade for HFI sell and HFS buy, WAC remains as '100.' Internal trade reversal is allowed only for the trades that are systematically processed from agency as part of HFI to HFS transfer.

5.5 Viewing Processed Trades

The trades input in 'Draft Trade' screen that have been successfully processed can be viewed in the 'Secondary Loan – Trade Online' screen. This section contains the following topics:

- [Section 5.5.2, "Specifying Fee Details"](#)
- [Section 5.5.5, "Specifying SSI Mnemonics"](#)
- [Section 5.5.6, "Viewing Funding Memo Details"](#)
- [Section 5.5.8, "Viewing the Amortized Fee Log Details"](#)
- [Section 5.5.11, "Reversing Trade Contract"](#)

You can invoke the 'Trade- Online' screen by typing 'TLDTDONL' in the field at the top right corner of the Application tool bar and clicking on the adjoining arrow button.

The screenshot shows the 'Trade Online' application window. At the top, there is a title bar with 'Trade Online' and window control buttons. Below the title bar is a search bar labeled 'Enter Query'. A navigation bar shows 'Of' with left and right arrows. The main area contains two columns of input fields. The left column includes: Contract Ref No, User Reference Number, Custom Ref No, External Ref No, Ticket ID, Portfolio, CUSIP/ISIN, Facility Name, and Commitment Type. The right column includes: Product, Description, Branch, Department, Treasury, Desk, Expense Code, Position Identifier, and Position Qualifier. Below these fields is a section titled 'Markit/ClearPar Details' with 'Markit Trade Id' and 'Allocation ID' fields. A 'Cascade Participation' checkbox is located below the 'Allocation ID' field. A horizontal menu bar contains links: Swap | Fee | Settlements | MIS | SSI | UDF | Funding Memo | Events | CLP Fee Log | Financial Centre | CR Log. At the bottom, there are three columns of labels: 'Input By' and 'Date Time', 'Auth By' and 'Date Time', and 'Auth Status' and 'Contract Status'. An 'Exit' button is positioned in the bottom right corner.

The details specified in the draft trade screen are defaulted here. From this screen, you can view the accounting entries and the events associated with the trade.

You can also capture following additional details related to the trade, in this screen:

- Fee details
- SSI mnemonic details
- Funding memo details
- CLP Fee Log details
- Collateral % details

5.5.1 Capturing swap Details

Once the trade contract is authorized, Oracle Banking Corporate Lending spawns Swap contracts for each of the swap ID, Quantity captured in the Trade Online screen.

Once the Swap contracts are created for each swap ID allocation, Oracle Banking Corporate Lending creates/updates Unsettled position for the Branch (Legal Entity), Desk code, Expense code, and swap ID combination.

The Swap contract screen can be used for only viewing the individual swap ID deals. No operations can be performed from this screen. While the aggregate of Amendment, Assignment, Brokerage, and Delayed Compensation Fees can be viewed from the 'Trade Online' screen. The contribution/distribution of the same across the various swap contracts can be viewed from the 'Swap Details' screen.

Settlement of the Swap Trade needs to be triggered from the 'Trade Settlement' screen.

The screenshot shows a window titled "Swap Details" with a close button (X) in the top right corner. The window contains two columns of input fields:

- Contract Reference No
- Branch
- Desk
- Portfolio
- Position Identifier
- Cusip No
- User Reference No
- Expense Code
- Ticket ID
- Portfolio Description
- Position Qualifier
- Parent Reference No

Below the input fields is a navigation bar with a "Go" button and a "1 Of 1" indicator. Below the navigation bar is a table with the following columns:

Swap ID	Swap Counterparty	Amount	OASYS ID	Swap Reference No
---------	-------------------	--------	----------	-------------------

At the bottom right of the window are "Ok" and "Exit" buttons.

The trade details are defaulted from the SLT contract.

Swap Details

Swap ID

Swap ID to be entered by the user.

Swap Counterparty

Counterparty corresponding to the swap ID.

Amount

Trade amount for the swap ID. The sum of trade amount for all swap ID should be equal to the total trade amount.

OASYS ID

OASYS ID to be entered by the user.

Swap Reference Number

The system creates trade contract for each of the swap IDs. The contract ref no of the swap level trade contract is displayed here.

5.5.2 Specifying Fee Details

You can capture the fee details associated with a trade contract in the 'Fee Components' screen. To invoke this screen, click 'Fee' in Trade Online screen.

The screenshot displays the 'Fee Components' application window. At the top, there is a header bar with the title 'Fee Components' and a close button. Below the header is a 'Execute Query' button. The main area is divided into two sections: 'Trade Details' and 'Fee Components'.

Trade Details: This section contains two columns of input fields. The left column includes 'Contract Reference *', 'User Reference', 'Portfolio', 'Position Identifier', 'CUSIP/ISIN', 'Branch', and 'Desk code'. The right column includes 'Version Number *', 'Expense Code', 'Portfolio Description', 'Position Qualifier', 'Ticket ID', and 'Parent Reference No'.

Fee Components: This section features a table with the following columns: 'Component', 'Component Description', 'Fee Type', 'DCF Category', 'Fee Calc Basis', and 'Fee Basis'. The table is currently empty. Above the table is a navigation bar with '1 Of 1' and a 'Go' button.

Below the 'Fee Components' table is another section titled 'Assignment Fee', which contains a table with columns: 'Component Currency', 'Buyer Split Amount', 'Seller Split Amount', and 'Actual Amount'. This table is also empty. Below this table is a section for 'Amendment Fee Details'.

At the bottom right of the application window, there is a 'Cancel' button.

The basic trade details, given below are defaulted from the Trade Online screen:

- External contract reference number, trade reference number and upload reference number
- Branch, desk and expense code
- Portfolio Id, position identifier and position qualifier
- CUSIP/ISIN and ticket Id

The following details related to the fee components are defaulted from the product level:

- Fee Component
- Fee Type
- DCF Category
- Fee Calc Basis
- Fee Basis

You can modify 'Fee Calc Basis' and 'Fee Basis', if required.

Fee Rate

Specify the fee rate to be used by the system to arrive at the fee amount. You can specify either the 'Fee Rate' or the 'Amount'.

Note

This is enabled only for fee types 'Broker Fee' and 'Line/Accommodation Fee'.

Amount

Specify the fee amount to be associated with the selected fee component. You can specify either the 'Fee Rate' or the 'Amount'.

For 'Assignment fee' the sum of the Buyer's Split Amount and Seller's Split Amount gets displayed here.

Note

This is not applicable for fee types 'DCF' and 'Break-fund Fee'.

Currency

Select the trade currency from the adjoining option list. This list displays all valid currency maintained at the currency level. This option is enabled only for 'Assignment' type of fee.

You need to maintain a valid SSI Mnemonic either for the agent and/or for the trade counter party based on the assignment fee remitter and assignment fee type for the currency selected. This is used during the trade/ticket settlement.

The SSI Mnemonic needs to be maintained for the different parties as specified below:

- For the trade counter party - if the assignment FEE remitter is the trade counter party and bank has to pay its contribution
- For the agent - if the assignment FEE remitter is bank and bank has to pay its contribution,
- For the Agent and trade counter party - if the assignment FEE remitter is bank and both bank and the trade counter parties has to pay their contribution

Waiver

Select this check box to indicate that you want to waive off all fee components except delayed compensation fee (DCF), for the trade contract.

DCF Waiver

Select this check to indicate that you want to waive off the delayed compensation fee (DCF) associated with the trade contract.

Note

This gets displayed only for 'DCF' fee types.

5.5.2.1 Specifying Assignment Fee Details

For fee components of type 'Assignment' you can specify the following details:

Assignment Fee Type

Select the method of sharing the assignment fee between the buyer and seller, from the drop-down list. The following options are provided:

- Buyer - the entire assignment fee amount is booked against the buyer
- Seller - the entire assignment fee amount is booked against the seller
- Split - assignment fee amount can be split between the buyer and seller

- Paid In Advance - assignment fee can be paid in advance.

Buyer's Split Amount

Specify the assignment fee amount that has to be booked against the buyer associated with the trade deal.

Seller's Split Amount

Specify the assignment fee amount that has to be booked against the seller associated with the trade deal.

Note

- Buyer's Split Amount and Seller's Split Amount are enabled only for assignment fee of type 'Split'.
 - The sum of Buyer's Split Amount and Seller's Split Amount gets updated as the 'Amount', in this case.
-

5.5.2.2 Viewing Amendment Fee History

From 'Fee Components' screen, click 'Amendment Fee Details' button to open 'Amendment Fee History' screen. You can use this screen to only view 'Amendment Fee History' screen.

1. You are not allowed to modify the amendment fee in the 'TL Fee Amendment' (TLDFEAMD) screen for both active and settled trades.
2. Amendment fee component is not displayed in the 'TL Fee Amendment' screen
3. You are allowed to capture/amend/waive fee in the 'TL Fee Amendment' screen for the remaining components

5.5.2.3 Other Trade Processing Changes for Fees

1. Amendment fee is applied systematically on a new trade when the trade is booked from LQT or manually in Oracle Banking Corporate Lending or when the trade is booked as part of trade amendment resulting in trade reversal and rebook.
2. Amendment fee is applied systematically on new trades when below mentioned conditions are met.
 - 'Auto Apply Amendment Fee' check box is selected.
 - Open amendment fee maintenance exists in the 'Amendment Fee Input' screen for the associated CUSIP with amendment date greater than or equal to trade date.
3. Oracle Banking Corporate Lending applies amendment fee systematically for new trades as explained below
 - New trade is populated in the 'Amendment Fee Input' screen for each amendment date.
 - 'Waive' check box is cleared by default for all the amendment dates if the trade is booked from LQT or manually in Oracle Banking Corporate Lending. This is applicable even if 'Waive All' check box was selected while capturing amendment fee for a specific amendment date under the CUSIP.
 - If the new trade is booked as part of trade amendment resulting into trade reversal and rebook then
 - 'Waive' check box is copied from the old trade (reversed trade) for each amendment date.
 - If amendment fee is waived at the component level for old trade then amendment fee is waived at the component level for the child trade as well. Amendment fee is applied systematically on new trade for each amendment date.

- However, amendment fee is not allowed to be settled if amendment fee is waived at the component level.
- If multiple amendment records exist for the CUSIP before and after trade date then 'Amendment Fee Input' screen is populated only for the records having amendment date greater than or equal to the trade date.

Example:-

Maintenance exists for CUSIP 1 as below

Amendment Date	Fee Rate	Waive
10-May-2015	0.4%	Yes
1-Jun-2015	0.3%	No
1-Jul-2015	0.2%	No

Scenario 1:- New trade is booked with CUSIP1

Trade Date	10-May-2015
Trade Amount	200,000.00

Record will be populated for the new trade in amendment fee input screen as below

Amendment Date	Fee Rate	Waive	Fee Amount
10-May-2015	0.4%	No	800.00
1-Jun-2015	0.3%	No	600.00
1-Jul-2015	0.2%	No	400.00

Amendment fee amount for the new trade is 1,800.00

Scenario 2:- New trade is booked with CUSIP1 due to trade amendment

Trade Date	10-May-2015
Trade Amount	200,000.00

Record will be populated for the new trade in 'Amendment Fee Input' screen as below

Amendment Date	Fee Rate	Waive	Fee Amount
10-May-2015	0.4%	Yes	800.00
1-Jun-2015	0.3%	No	600.00
1-Jul-2015	0.2%	No	400.00

Amendment fee amount for the new trade will be 1000.00

- Trade amount as of the amendment date is used to calculate the amendment fee. This is explained in detail below.
 - FAMD event is registered and auto authorized.
4. Once the trade is booked, you are allowed to waive or un-waive the trade record for a specific amendment date in the 'Amendment Fee Input' screen
 5. Amendment fee is systematically applied as explained above for the trades booked with Par, Distress and Origination desks.
 6. There is no change in amendment fee for the existing trades (trades booked prior to this enhancement). Existing trades are impacted only in the below mentioned scenarios.

- Trade amendment results into reversal and rebook
- Trade amendment to waive or un-waive the amendment fee at component level

5.5.3 Specifying Settlements Details

For information on settlement details, refer to 'Processing Settlements' topic in *Settlements User Manual*.

5.5.4 Specifying MIS Details

To invoke the MIS details screen for a contract, click on the 'MIS' button.

For a contract, the transaction type of MIS class, the cost code and pool code are picked up from the product under which the contract is processed. The composite MIS code is picked up from the definition made for the customer, on behalf of whom the contract is being processed.

The interest calculation method for the refinancing rates of the pool is picked up default from Pool Codes maintenance. These can be changed. For an account, the transaction type of MIS class is picked up from the account class, along with the cost codes and pool codes. The composite type of MIS class is defaulted from those defined for the customer. These too can be changed.

5.5.5 Specifying SSI Mnemonics

You can capture currency-wise SSI mnemonics in the 'SSI Mnemonics' screen. To invoke this screen, click 'SSI' in the Trade Online screen.

The basic trade details associated with the trade contract are defaulted in this screen.

5.5.5.1 **Capturing Agent Mnemonic Details**

If assignment fee is involved in a trade contract, you can capture the SSI mnemonic for the currency of the agent, to whom the assignment fee needs to be paid.

SSI Mnemonic

Select the SSI mnemonic value to be linked to the agent currency, from the option list provided.

5.5.5.2 **Capturing Mnemonic Details for Trade Counterparties**

You can also capture the SSI mnemonics for the currencies associated with different counterparties involved in the trade deal.

Ccy

Select the currency associated with the trade counterparty from the option list provided.

SSI Mnemonic

Select the SSI mnemonic value to be linked to the currency associated with the trade counterparty, from the option list.

Remarks

Specify any additional information about the mnemonics details.

5.5.6 **Viewing Funding Memo Details**

You can view the funding memo details associated with a trade contract by clicking the 'Funding Memo' tab in the Trade Online screen. The funding memo details for the current

trade get displayed, if it has already been extracted. You cannot make any changes in the funding memo details.

For more details on funding memo refer the section 'Capturing Funding Memo Details' in this user manual.

5.5.7 Maintaining Events

A contract goes through different stages in its life cycle. In Oracle Banking Corporate Lending, the different stages a contract passes through in its life cycle are referred to as 'Events'.

At an event, typically, you would want to post the accounting entries to the appropriate account heads and generate the required advices.

For more information on events, refer to 'Maintaining Details Specific to SLT' topic in *Bilateral Loans User Manual*.

5.5.8 Viewing the Amortized Fee Log Details

You can view the amortized fee log details in the 'Un Amortized Fee Log' screen. To invoke this screen, click 'CLP Fee Log' in the Trade Online screen. The screen displays the status of amortization fee processed during settlement (TSTL) or reversal of settlement (RSTL) event of origination buy trade.

Exceptions						
1 Of 1		Go				
<input type="checkbox"/>	Contract Ref No	Event Seq No	Event Code	Comm Ref No	Comm Fee Esn	Fee Currency

[Exit](#)

Any action which is resulting in the trade settlement reversal of the CLP Buy, attempts to refund the FEE component amounts computed for the current trade being reversed. In case if the FEE component does not have enough balance due to any of the following reasons, system will log the exception without performing the refund:

- If the FEE components are chosen for daily accruals, the accrual would have started from the day the FEE component is liquidated as part of BUY trade settlement. Now, while reversing such trades, some amount would have been accrued and the entire amount is not available for refund.
- After creating/liquidating the new amortization FEE components as part CLP Buy trade settlement, if the CLP desk is involved in a Sell trade, the pro-rata share of this fee would have been considered while arriving at the carrying value/COC for the Sell trade and the FEE component amount would be refunded to that extent as part of CLP Sell trade booking. Now, while reversing the Buy trades, some amount would have been refunded as part of Sell trade booking and the entire amount is not available for refund.

5.5.9 Financial Centre Holiday Treatment

Click 'Financial Centre' tab in 'Trade Online' screen to open 'Financial Centres for Trade Expected Settle date' screen.

Financial Centres for Trade Expected Settle date

Trade Details

Ext Contract Ref No _____ Product _____
 Trade/Tm Ref No _____ Branch _____
 Version Number _____ Portfolio _____

Financial Centres for Trade Expected Settle date

1 Of 1 Go + - ☰

<input type="checkbox"/>	Financial Centre	Financial Centre Description

Ok Exit

Financial center maintained at trade draft level is displayed in 'Trade Online' (TLDTDONL) screen.

5.5.10 Viewing Commitment Reduction Log

You can view the details of each commitment reduction for a trade by clicking the 'CR Log' tab.

Trade/TRN Ref No _____

Commitment Reduction Details

1 Of 1 Go + - ☰

<input type="checkbox"/>	Version No	Commitment Reduction Price	Commitment Reduction Amount

Net Commitment Reduction Amount _____ Average Commitment Reduction Price _____

Exit

In this screen, you can also view the net commitment reduction amount and the average commitment reduction price.

While calculating the final settlement reduction amount for a trade during the trade settlement, the net commitment reduction amount is considered at the average commitment reduction price.

5.5.11 Reversing Trade Contract

You can reverse the trade contract details before or after trade settlement in the 'Trade Online' screen. You can also authorize the trade reversal transaction in this screen.

5.6 Querying Trade Contract

You can view a summary of all the processed draft trades and query for a trade in the 'Secondary Loan - Trade Summary' screen. You can invoke the 'Secondary Loan - Trade Summary' screen by typing 'TLSTDONL' in the field at the top right corner of the Application tool bar and clicking on the adjoining arrow button.

Click 'Search' to view summary of all processed draft trades.

	Auth Status	Contract Status	Branch	Contract Reference	Ticket ID	Position Identifier	Portfolio	Cusip No	Counterparty	Desk Code	Buy/Sell	Cun
<input type="checkbox"/>	A	A	000	001SLT1161820012	K1871	060083	060083	K18772	200608	PAR	B	USD
<input type="checkbox"/>	A	A	000	001SLT1161413011	SLTAMSAMPLE	060086	060086	SLTAMFEE01	023388	ORIG	B	USD
<input type="checkbox"/>	A	L	000	000HFS2150911002	789	060083	000000111	K18772	000000112	DeskCode	S	USD
<input type="checkbox"/>	A	A	000	000HFS2150919005	RANJAN22	060083	000000111	CUSIP	000000111	DeskCode	S	USD
<input type="checkbox"/>	A	V	000	000HFS2150912003	789	060083	000000111	K18772	000000111	DeskCode	S	USD
<input type="checkbox"/>	A	A	000	000HFS2150913001	789	060083	000000111	K18772	000000111	DeskCode	S	USD
<input type="checkbox"/>	A	A	000	000HFS2150913002	789	060083	000000111	K18772	000000111	DeskCode	S	USD
<input type="checkbox"/>	A	A	000	000HFS2150913003	789	060083	000000111	K18772	000000111	DeskCode	S	USD
<input type="checkbox"/>	A	A	000	000HFS2150913006	789	060083	000000111	K18772	000000111	DeskCode	B	USD
<input type="checkbox"/>	A	A	000	000HFS2150919003	RANJAN11	060083	000000111	CUSIP	000000111	DeskCode	B	USD
<input type="checkbox"/>	A	A	000	000HFS2150914001	789	060083	000000111	K18772	000000111	DeskCode	S	USD
<input type="checkbox"/>	A	A	000	000HFS2150919004	RANJAN22	060083	000000111	CUSIP	000000111	DeskCode	S	USD

You can view the details of a trade in the 'Trade Online' screen by selecting a desired row in the summary screen and double-clicking the same.

You can also query for a trade using the 'Advanced Search' screen which can be invoked by clicking 'Advanced Search' in this screen.

In this screen you can perform the following types of queries for all contracts booked for a CUSIP:

- All trades bought or sold
- All contracts booked between two trade dates
- All contracts booked between two settlement dates
- All contracts booked with a particular counterparty
- All contracts booked for a particular desk
- All contracts booked for a Swap Id

5.7 Capturing Agency Details

You can capture agency branch details in the 'Agency Detail Input' screen.

This section contains the following topics:

- [Section 5.7.1, "Capturing the Pricing Details"](#)
- [Section 5.7.2, "Capturing Interest Details"](#)
- [Section 5.7.3, "Auto Booking of Drawdown Details"](#)
- [Section 5.7.4, "Capturing Additional Drawdown Details"](#)

From 'Trade Settlement Detailed' screen (TLDSETTL), click 'Manual Funding Memo' tab.

The following trade related details are displayed here:

- Contract Ref No is the SLT contract number.
- Trade Price is the price at which the deal is booked
- Trade amount is the amount which is bought/sold
- Portfolio is each Branch-Desk combination with in a unique Portfolio.

Tranche ref no

Specify the tranche no from the adjoining option list.

Note

- This field is disabled if the parameter 'Buy back for Zero Position tranche' is not checked
 - If 'Buy-back for Zero Position tranche' is checked, 'Tranche Reference Number' of all zero-position non-lead tranches linked to the CUSIP is populated in the adjoining option list.
 - If 'Buy-back for Zero Position tranche' is selected and the Funding Memo source is 'Manual' for a tranche with position, the Tranche option list is not disabled. The option list does not have any values.
 - You need to enter the drawdown details in the 'funding memo upload screen'. You are not allowed to select the existing Drawdowns even though the drawdown outstanding is zero, using 'drawdown selection' screen for zero-position tranche.
-

Global Tranche Amount

Specify the total tranche amount for a CUSIP

Upfront Fee

Specify the upfront fee here. The fee is not used while processing any settlement.

BCR Fee

Specify the BCR Fee (Benefit of Commitment reduction) here. The fee is not used while processing any settlement.

The following details are displayed and computed based on the drawdown details specified:

- Global Funded Amount (system arrives at this amount based on the pricing details captured in this screen)
- Global Unfunded Amount (system arrives at this amount based on the Global Tranche amount, Trade amount and drawdown details)
- Trade Funded Amount
- Trade Unfunded Amount

5.7.1 Capturing the Pricing Details**Drawdown ref no**

Specify the drawdown reference number. The adjoining option list displays all valid drawdown products maintained at the Tranche level. You can select the appropriate one.

Note

In order to create a single drawdown for multiple trades, you need to select the same dummy reference number for all the relevant trades

For the first trade under a Ticket ID for which dummy reference numbers are yet to be generated, You are required to 'Generate' the first dummy reference number by clicking on the 'Generate' button; since no values will be available for selection from the option list.

If you select a dummy reference number from the option list and press 'Generate' button the selected reference number will be replaced with newly generated reference number.

You can generate a dummy reference number using 'Generate' option and then overwrite the generated value with a value selected from the pick list. The Total Drawdown amount under a particular dummy reference is the cumulative sum of the funded amounts under the trades for the ticket

Drawdown CCY

Specify the currency of the Drawdown which can be used for processing.

Drawdown Product

Specify the drawdown of the product. The adjoining option list displays all valid drawdown products maintained at the Tranche level. You can select the appropriate one.

Funded Amount

The total drawdown amount in the drawdown currency

Funded Amount in Trade CCy

The system displays the funded amount in trade currency.

Ex Rate

Specify the fixed exchange rate between the Funding currency and Tranche/Trade currency if both are not same. Funded amount in Trade currency gets displayed in the adjacent field using the exchange rate given.

Borrower

Specify the borrower number. The adjoining option list displays all valid borrowers maintained at the Tranche level. You can select the appropriate one.

Value Date

Specify the value Date of the Drawdown

Maturity Date

Specify the maturity date of the Drawdown. The date should be greater than the Drawdown date

The system will validate the drawdown value date and maturity date to be within the tranche value date and tranche maturity date.

Original Start Date

Specify the original start date of the Drawdown. The date should be less than or equal to Drawdown date.

Rate Type

Specify the interest rate type of the Drawdown from the options available:

- Fixed
- Floating

Rate Basis

Specify the rate basis. The adjoining option list displays all valid rate basis maintained in the system. You can select the appropriate one.

Buyer's Share

Specify the buyer's share amount as on the actual settlement details. This is used for DCF computation.

For Pro-Rata agency contracts, the system populates the details based on the trade ratio whereas for Non Pro-rata agency contract, you need to provide the details for each drawdown. Only those drawdown should be captured in which the Seller of the trade is an active participant.

5.7.2 Capturing Interest Details

Alternative Risk-Free Rates Preferences

The options of 'Alternative Risk-Free Rates Preferences' are defaulted from 'Loans Syndication – Borrower Product Definition' (LBDPRMNT). If required, you can modify it.

For more information on 'Alternative Risk-Free Rates Preferences' fields, refer to *Interest User Manual*.

Component

Specify the interest component of a Drawdown

Amount

Specify the amount of the specified component

Buyer's Share

Specify the buyer's share amount.

Start Date

Specify the start date of interest component computation

Re-price Date

Specify the end date of interest component computation

Base Rate

The base rate for the interest component

Margin

Specify the margin details of the interest component

Final Rate

Specify the final rate of the interest component after calculating the base rate and margin.

Note

For more details on negative rate processing, refer the title 'Maintaining Loans Parameters Details' in the chapter 'Bank Parameters' in Core Services User Manual.

5.7.3 Auto Booking of Drawdown Details

The drawdown is created automatically in agency if you input the drawdown details in 'Agency Details Input' screen of funding memo during ticket / trade settlement. The Auto book of drawdown in agency through STP from SLT is applicable only if it satisfies all the following conditions:

- DD Upload by Trade settlement should be 'Yes' in the 'Loan Parameters' screen
- 'Non-Prorata / PIK settlement' flag is checked during trade / ticket settlement
- Pro-rata Tranche (Cascade Participation – Yes)
- Par or Distress type of trades
- Buy type of trades
- Non-lead trades / Non-bank agented trades
- Cusip should have only one participant with 100% ratio or multiple participant with one participant as 100% and other participants with 0% and it should be the buyer in the trade
- Ticket / Trade settlement with new drawdown's details captured

If you have selected the 'Non-Prorata/PIK Settlement' option in ticket / trade settlement, the system defaults all the existing drawdown details with buyer's share and corresponding drawdown amounts in the 'Agency Detail Input' screen.

If the drawdown exists under a CUSIP during the trade/ticket settlement, the system does the following:

- Changing the buyer's share of the individual drawdown which triggers VAMI after the TL-LB processing
- Deleting the existing drawdown details in 'Agency Detail Input' screen and allowing to capture the new drawdown details
- the net buyer's share across drawdown in tranche currency should not exceed the trade amount

In case, if the both new drawdown and existing details are available, the system displays an error message.

The system checks if the 'Non-prorata / PIK settlement' option is selected, then it arrives at the corresponding drawdown amounts based on the buyer's share for the individual drawdown's while processing the records from the TL-LB handoff browser.

Once the trade is settled and processed in LB browser, the system does not reverse the Drawdown newly created when Trade Settlement is reversed.

If the trade settlement is reversed, then the system fires an offset VAMI that is, negative VAMI for buy reversal for all drawdowns affected as part of the settlement. But it allows the creation of drawdown for back dated ticket settlement provided there is no ticket settlement / agency activity with value date after ticket settlement date.

In case of multiple open trades with different new drawdown details in 'Agency Details Input' screen, the system creates multiple new drawdowns during TL-LB STP after ticket settlement.

5.7.4 **Capturing Additional Drawdown Details**

You can capture additional drawdown details in 'Additional Drawdown Details' screen by clicking 'Addl Drawdown Details' in the 'Agency Detail Input' screen.

The screenshot shows a window titled 'LBL_CVS_ADDL_DD'. At the top, there are navigation controls including '1 Of 1', a 'Go' button, and zoom controls. Below this is a table with the following columns: 'All in Rate', 'LBL_RAC_RATE', 'LBL_NET_RATE', 'Rate Basis', 'LBL_IRFX_TIME', and 'LE'. The table is currently empty. At the bottom right of the window, there are 'Ok' and 'Exit' buttons.

Specify the following details:

RAC Rate

Specify the RAC rate. The RAC rate is difference between net rate and base rate which is always zero and validates if RAC rate is not zero.

Rate Basis (LIBOR/EURIBOR)

Specify the rate basis. The adjoining option list displays all valid rate basis maintained in the system. You can select the appropriate one.

The new drawdown is created only based on the rates mentioned in the 'Agency Detail Input' screen and not the details specified here.

The system displays the following details:

- All In Rate
- Net Rate

- Interest Rate Fixing Time
- Exchange Rate Fixing Time
- Location
- Interest Period

5.8 Capturing Origination Trade Details

Line trades are trades which are handled by a desk on behalf of another desk. Origination trade supports not only 'Assignment type', but also 'Participation type'. However, the actual participation happens only during the internal Origination trade.

Trade deals involving the Origination desk are handled as line trades in Loans QT. These deals, discussed in detail in subsequent sections, can be either CLP Buy or CLP Sell.

This section contains the following topics:

- [Section 5.8.1, "Processing CLP Sell Line Trades"](#)
- [Section 5.8.2, "Processing Cost of Credit Valuation for Commitments"](#)
- [Section 5.8.3, "Validating Unamortized Fee"](#)
- [Section 5.8.4, "Processing CLP Buy Line Trades"](#)

5.8.1 Processing CLP Sell Line Trades

For CLP Sell line trades involving the origination desk, the following three separate trade deals are generated.

7. Par desk selling to customer
8. Par desk buying from Origination desk
9. Origination desk selling to Par desk

Note

Loans QT may send multiple sell trade from Par desk to Customer (the first type of trade mentioned above) for line trades within a single ticket.

These three deals are created under the same ticket and are settled together during the ticket settlement. For the first trade, where par desk sells to customer, you need to select the 'Parent Line Trade' check box.

The origination trade processing is carried out as follows:

1. When the third trade details, that is, origination desk selling to par desk, are handed off from Loans QT to Oracle Banking Corporate Lending, the system checks if the related trade is a line trade.
2. If it is a line trade, then the details of this origination sell trade get populated in the 'Line Trade – Origination Details' screen. Unamortized fee amount, Reserve amount and the Contra amount applicable for the origination desk corresponding to the Participation sell gets defaulted, whereas Participation buy should be handled manually.
3. The origination line trade is processed once you confirm these details.

Note

If the contra and reserve are captured in cross currency loans, then the contra and reserve is not defaulted and it is assumed to be zero.

You can invoke the 'Line Trade - Origination Details' screen by typing 'TLDORGQU' in the field at the top right corner of the Application tool bar and clicking on the adjoining arrow button.

Line Trade-Origination Details

Enter Query

Ext Contract Ref No *

Ticket ID

CUSIP/SIN

Version ◀ Of ▶

Trade Details

Currency

Trade Amount

Trade Date YYYY-MM-DD

Deal Type

Buy Sell Indicator Buy Sell

Trade Price

Expt Settl Date

Origination Details

Position Identifier

Desk

Unamortised Fee Amount/FAS91 Fee Amount

Asset Transfer Marks Amount

Product Code

Branch

Contra Amount

FAS114 Reserve Funded Amount

Confirm

Maker ID Checker ID Authorization Status

Maker Date Stamp Checker Date Stamp Contract Status

Exit

Following details related to the origination line trade are displayed here:

- Trade amount, price, trade booking date, trade currency and the expected settlement date
- Deal Type
- Position identifier, product, and portfolio
- Desk, branch, and expense code
- Unamortized fee amount (or FAS91 Fee Amount), contra amount and Writeoff Amount. If the cost of credit valuation is being done for the commitment, then the system displays the 'FAS91 Fee Amount'; else the system displays the 'Unamortised Fee Amount'.
- Asset Transfer Marks Amount, FAS114 Reserve Funded Amount, FAS114 Reserve Unfunded Amount. These amounts are computed by applying the pro-rata percentage of Sell on the relevant Origination total amounts at commitment level

Note

For CLP buy line trade, if the deal type is 'Participation', the SLT position and the agency activities to be tracked independently for the normal participant and silent participant. In

such cases, when the Participation Buy is entered for the first time, system does not have the corresponding CLP Participation commitment in place. The FEE components should be handled manually as part of manual creation of agency and origination details.

Confirm/Reject

Select the option to indicate whether you want to confirm or reject the details specified in this screen.

The line fee gets settled as part of line trade booking. Line fee income for the par desk is passed during the line trade and line fee expense for the origination desk is passed during the origination sell deal.

For origination sell deal, the unamortized fee, reserve amount and contra amount are considered for PnL calculation.

The carrying value, cost of carry and PnL are computed based on the following formulae:

- **Carrying Value** = (Fund Amount Sold / Outstanding Fund Amount) * (Outstanding Fund Amount – Unamortized Fee – Reserve – Contra)
- **Cost of carry** = Carrying Value – Fund Amount * Price + Unfunded amount *(1– Price) + LC amount * (1– Price)
- **Cost of Carry (PnL)** = Trade amount * (1– Price) + Unamortized FEE + Reserve + Contra

The PnL entries, in case of loss, are passed as part of trade booking, whereas the PnL entries, in case of profit, are passed as part of trade settlement for the origination desk.

Any amendments to the CLP Sell line origination trades resulting in change of position or PnL, results in an internal reversal of the trade and the trade is re-booked with the revised details. The PnL entries of the original trade is reversed and the reserve, contra and unamortized fee amount as per the revised trade is considered for PnL computation. However, amendment from assignment to Participation type or vice versa is not allowed. It has to be handled by means of reversing the current trade and rebooking the revised trade with the proper deal type.

The amendments also get populated in the 'Line Trade – Origination Details' screen and the amended details have to be confirmed before it can be processed further.

A batch program in the OL module handles the reclassification of an exposure as Held for Sale (HFS), for the origination trade amounts. It identifies the list of open trades and trades booked on the current date and arrives at the reclassification break up required for funded amount, unfunded amount and LC amount for each of the origination entity. The reclassification entries are passed for the affected loans and commitment contracts as part of the 'TRCL' event. If the cost of credit valuation is selected for the commitment underlying the trades, instead of the re-classification happening during batch, the system does the re-classification during trade booking itself.

Note

- In case of inter desk trading; only the buy leg of the transaction is handed off to agency.
 - In case of the new Agency tranche creation involving originations, Oracle Banking Corporate Lending automatically creates the buy trades for the origination desk to reflect the proper position in the SLT layer.
-

5.8.2 Processing Cost of Credit Valuation for Commitments

If a cost of credit valuation is required for a commitment, when booking is done for a sell trade and the confirmation is received from the origination queue, the following events takes place:

- For the Commitment:
 - Refund of unamortized fee for Asset Transfer Marks(FELR) for the reduction in Asset Transfer Marks because of the sell trade
 - Refund of FAS 91 fees(FELR) based on the pro-rata % - since FAS 91 fees is combination of all amortization fees except Asset Transfer Marks, refund for FAS91 fees is done by taking the percentage of the loan sales against outstanding of each of the amortization fee components, and refunded, except Asset Transfer Marks
 - FAS 114 Unfunded Reserve Release(FRSV) event on the commitment based on the FAS 114 Reserve Unfunded amount confirmed by the Origination Queue
- For the loan
 - Write-off (RESR for Principal Decrease) is done on each of the loans based on the pro-rata % of loan sales
 - FAS 114 Reserve Funded Release (FRSV) event happens for each of the loan based on the pro-rata % of the loans sales

Note

The offset entry (Credit leg) for these events are posted to the SLT OL Bridge GL (maintained in 'SLT Branch parameters' screen) instead of the regular account it would have been posted into, if the triggering had been done manually at the commitment level.

Additionally, the system computes the following balances:

- Direct Write-off (if the computed net PnL results in loss (negative))
- Net Loss
- Net Recovery (if the sale results in profit, PnL being positive)

If there is any amendment in the trade amount, then all the balances required to be computed for the cost of credit valuation is recomputed based on the latest trade amount and new entries posted.

As part of the settlement (TSTL), the system does the net recovery in the following order:

- to the extent of the write-off reduced due to trade booking
- to the extent of Contra reduced due to trade booking
- to the extent of FAS91 fees refunded due to trade booking
- to the extent of Asset Transfer Marks refunded due to trade booking

After net recovery is done, the residual of each of the amounts that was not recovered is recorded, so that the balances in the GL's for each of these amounts are correct. The net entries for the difference between the Recovery amount for each of the Write-off / Contra / FAS91 fees / Marks and the actual balance populated in Origination Queue is posted at the trade level.

5.8.3 Validating Unamortized Fee

You can re-compute the unamortized fees at TL and OL layer during the origination queue confirmation. If the recomputed fee is different from the existing computed fee then an override is displayed to show the newly computed unamortized fee amount. Click OK if you

want the system to overwrite the existing fee and do the processing based on the recomputed fee.

5.8.4 Processing CLP Buy Line Trades

For CLP Buy line trades involving the origination desk, the following three separate trade deals are generated.

1. Par desk buying from Customer.(Customer trade)
2. Par desk selling to Origination/CLP desk
3. Origination/CLP desk buying from Par desk

These three deals are created under the same ticket and are settled together during the ticket settlement.

The origination trade processing is carried out as follows:

1. When the third trade details, i.e, origination desk buying from par desk, are handed off from Loans QT to Oracle Banking Corporate Lending, the system checks if the related trade is a line trade.
2. If it is a line trade, then the details of this origination buy trade get populated as a separate queue in the 'Line Trade – Origination Details' screen.
3. Unamortized fee amount, Reserve amount and the contra amount applicable for the Origination desk corresponding to the trade is not fetched to the origination queue for CLP buy trades.
4. The origination line trade is processed once you confirm these details.

Upon trade settlement authorization, the system does the amortization FEE liquidation to pass the accounting entries for the price differential during the elevation process of the trade. If the CLP commitment is not associated with the relevant Income/expense amortization FEE components, accounting entries are not passed during trade elevation. The amortization FEE adjustments are to be handled manually.

If the new amortization FEE entries are passed during trade settlement authorization, it does not have any impact on the FEE component due to any kind of CLP Buy trade amendments before the settlement.

Any amendment to the Line Origination buy trades resulting in change of position, the original trade is internally be reversed and rebooked for the revised details. Any change in the unamortized fee which is triggered by Buy trades which is leading to the exceptional cases have to be handled manually.

5.9 Trading with PIK Facility

A PIK loan is a type of loan that does not involve any cash flows from the borrower to the lender, between the drawdown date and the maturity date. Trades involving PIK always need to have the quotation method specified as 'Flat'.

For trades involving the PIK component, the following three scenarios are possible:

- Tranche has partial availability of the PIK amount
- Tranche has no availability of the PIK amount
- Tranche has sufficient availability of the PIK amount

If the PIK allocation has already happened before the trade is booked, there is not any separate trade processing for the PIK portion. PIK also is treated as part of normal trade amount.

If the PIK happens in the agency, resulting in a commitment increase, the commitment increase details are handed off to Loans QT with the indication that the increase in the commitment is due to PIK. The commitment increase due to PIK is considered at a price equal to zero except for origination trades, where it is considered at price equal to 100. Loans QT sends an internal deal to Oracle Banking Corporate Lending to the extent of the commitment increase and settled position gets updated with the PIK amount. This internal trade is booked and settled immediately in SLT. For a buy deal, the costing details are updated and for a sell deal the PnL entries are updated. For open trades, Loans QT sends trade amendments to the extent of PIK amount. During settlement, the PIK amount is not considered as it is priced at zero.

If the PIK changes in the agency do not result in commitment increase, the existing settled position remains unchanged. For open trades, the funded portion increases by the PIK amount and the unfunded portion decreases by the PIK amount.

Note

- Delayed compensation fee is not applicable for PIK trades, as they are always quoted as 'Flat'.
 - PIK is applicable only for drawings in the trade currency.
-

5.10 Querying Position Balances

Positions are maintained for each CUSIP for a combination of desk, branch, expense code, and swap Id/settlement party in case of silent participation. The positions get updated when you book a trade and also when any amendment happens to the trade amount or the buy/sell indicator.

A buy deal results in an open position which gets reduced by a subsequent sell of the CUSIP. A short sell results in a negative position. Position for a CUSIP, can be negative due to short sells, before the settlement date. On the actual settlement date a CUSIP cannot have a negative position.

You can view the position balances for a given position identifier in the 'Position Balances' screen.

This section contains the following topics:

- [Section 5.10.1, "Resolving Multiple Portfolio Mapping to a Single Expense Code"](#)
- [Section 5.10.2, "Updating Positions for Commitment Reductions/ Increases"](#)

You can invoke the 'Position Balance' screen by typing 'TLDPOSBL' in the field at the top right corner of the Application tool bar and clicking on the adjoining arrow button.

You can specify the following details in this screen:

Position Identifier

Select the position identifier for which you want to view position balances for the associated CUSIP.

Following details related to the CUSIP associated with the position identifier selected, are displayed:

- Currency
- Tranche Ref number
- Facility Name
- Expense Code
- Settled position
- Unsettled position
- Total position
- Weighted average costing for the total position of CUSIP
- Settled WAC for the combination of Position Identifier, CUSIP and Expense code
- HFS Cost Basis
- Firm Account Mnemonic

Commitment reduction and PIK amounts are considered for computing settled WAC, at the prices of 100% and zero respectively. The remaining trade amounts are considered at the trade price. The settled WAC is calculated for the net trade amount using the trade price, during trade settlement or reversal of trade settlement. Settled WAC is calculated for all the costing methods (LIFO, FIFO, and WAC) and is applicable for internal trades also.

Note

Settled WAC is not used for any processing in SLT. It is used only for funding activities.

You can get a more detailed view of the balances in the 'Position Balance Enquiry' screen. You can invoke the 'Position Balance Enquiry' screen by typing 'TLSPOSBQ' in the field at the top right corner of the Application tool bar and clicking on the adjoining arrow button.

Position Identifier	Cusip number	Expense Code	Currency	Total Position	Unsettled Position	Settled Position	Portfolio	Branch	Swap Counterparty	Position Qualifier	Desk code
---------------------	--------------	--------------	----------	----------------	--------------------	------------------	-----------	--------	-------------------	--------------------	-----------

In this screen you can specify any of the following search parameters:

Position Identifier

Select the position identifier to be used to query the position balances for the CUSIPs.

Portfolio

Select the portfolio to be used to query the position balances for the CUSIPs.

Position Qualifier

Select the position qualifier to be used to query the position balances for the CUSIPs.

Desk

Select the desk for which you want to query the position balances.

Branch

Select the branch for which you want to query the position balances.

Expense Code

Select the expense code for which you want to query the position balances for the CUSIPs.

SWAP Counterparty

Select the SWAP counterparty of the CUSIP for which you want to query the position balances.

The details related to position balances get displayed, according to the search parameters specified. All records satisfying the values specified get displayed for the combination of position identifier and CUSIP.

Note

Branch, desk, and expense code are defaulted, if you specify a value for portfolio.

5.10.1 Resolving Multiple Portfolio Mapping to a Single Expense Code

In case of multiple portfolio mappings for the same expense code, desk code and branch code combinations, system checks if the position (settled or unsettled) is non-zero for any of the mapped portfolios. If system finds any such portfolio, then it is taken as trade portfolio and further processing is done. However, if no position is found or the position (settled and unsettled) is zero, then system takes the default portfolio and proceed with trade processing.

5.10.2 Updating Positions for Commitment Reductions/ Increases

Commitment reductions can happen during trade amendment either using 'Draft Trade' screen or from Loans QT. Commitment reduction can happen in the agency, when there is a re-payment for a non-revolving tranche or when there is a reduction in the tranche amount. Commitment increases also can happen during value dated amendments.

The details of the commitment reductions or increases happening in the agency are handed off to Loans QT. The settled positions for the trade amounts for open trades and inter company sell trades are amended, corresponding to these details that are handed off.

Internal trades are automatically settled in the system. For internal trades created because of commitment reduction, system posts accounting entries during settlement since price is involved for the commitment reduction.

To handle commitment reduction for open position, Loans QT sends trade amendments for each open trade. Each of these commitment reductions will be treated with their respective price to calculate PnL or to update the WAC.

The impact of commitment reduction should be considered in case of reversal and rebook (TCNC + TREV + TBOK) of a trade due to trade amendment. Since each commitment reduction can have different price associated with it, the net commitment reduction amount is considered at an average price for such cancellation and rebook.

As part of trade reversal, system cancels and reverses the events (TCNC + TREV).

Note

In case of commitment reduction for CLP trades, the CR price is always considered as 100 for all the three trades irrespective of the CR price received from LQT.

The following a/c entries will be posted during settlement of internal trade created because of commitment reduction:

For Internal Buy Trade with discounted price

Accounting Role	Amount Tag	Dr/Cr
CUSTOMER (Internal GLs)	UNFND-DIS-BUY	Dr
SLT-PREM-DISC	UNFND-DIS-BUY	Cr

For Internal Buy Trade with premium price

Accounting Role	Amount Tag	Dr/Cr
SLT-PREM-DISC	UNFND-PRM-BUY	Dr
CUSTOMER (Internal GLs)	UNFND-PRM-BUY	Cr

For Internal Sell Trade with discounted price

Accounting Role	Amount Tag	Dr/Cr
SLT-PREM-DISC	UNFND-DIS-SEL	Dr
CUSTOMER (Internal GLs)	UNFND-DIS-SEL	Cr

For Internal Sell Trade with premium price

Accounting Role	Amount Tag	Dr/Cr
CUSTOMER (Internal GLs)	UNFND-PRM-SEL	Dr
SLT-PREM-DISC	UNFND-PRM-SEL	Cr

5.11 Calculating Realized Profit and Loss

Realized PnL is calculated during the booking of a trade as well as during cancellation of a trade. During trade amendment, if there are any changes in the position or price, then also realized PnL is calculated.

The costing method to be used for calculating PnL is derived from the portfolio for which the deal has been booked. The costing methods used can be any of the following:

- WAC (Weighted Average Cost)
- FIFO (First in First Out)

- LIFO (Last in First Out)

Realized P&L could result out of either a sale of CUSIP under the same position, or a buy of CUSIP under the same position, if the position is short.

5.11.1 Calculating Realized PnL for Commitment Reductions

When an amendment record comes from Loans QT, a corresponding amendment event gets initiated for the SLT contract also. During amendment the realized PnL entries are not reversed. For the amendment, realized PnL entries are posted for the difference between the initial trade amount and the amended amount.

If the costing method for the portfolio is WAC, it remains unchanged for commitment reductions. The commitment reduction amount is considered at par price for PnL and WAC calculations.

The following example illustrates the computation of realized PnL during commitment reductions:

Example

Let us assume that there is an unsettled buy deal for 100mn, where the costing method used is WAC. If there is a commitment reduction to the extent of 20%, the trade amount is amended to 80mn. PnL entries are posted for a sale of 20mn at par. The PnL is computed by comparing the par price with the price at which the trade was done.

Similarly, if the costing method is WAC and there is an unsettled sell deal for 100mn, in the event of commitment reduction of 20%, the trade amount is amended to 80mn.

PnL entries are posted for a buy of 20mn at par.

5.12 Re-valuating Positions

Revaluation is performed for each open position under a CUSIP against the corresponding position identifier. For each combination of CUSIP and position identifier, the system generates a unique position contract reference number. The revaluation and reserve events along with the related accounting entries are passed for this position reference number.

The revaluation accounting entries are posted for the total position (settled + unsettled) as part of EOD batch program. These accounting entries posted are reversed during the BOD batch for the next working day.

Revaluation is performed using the market price details captured for the CUSIP. If the costing method defined for the portfolio is WAC, the system compares the market price with the WAC for the position. If the costing method is either LIFO or FIFO, then the system compares the trade price with the market price for each deal. A single set of accounting entries are posted for the position contract reference number, netting the revaluation entries for all deals under the CUSIP.

You can view the re-valuation preferences for a position contract in the 'Position Detail' screen. You can also view the revaluation accounting entries associated with the contract in this screen.

You can invoke the 'Position Detail' screen by typing 'TLDPOSDT' in the field at the top right corner of the Application tool bar and clicking on the adjoining arrow button.

A position contract reference number gets automatically generated when a trade is booked for the first time. This reference number is generated for a combination of the position identifier and CUSIP. In this screen, you can only view the details of position contract and the events. The following details related to position contract are displayed:

- Position Identifier – defaults from the trade contract, but for Swap trades it is auto-generated by the system
- CUSIP/ISIN – defaults from trade contract
- Portfolio – defaults from trade contract
- Position Qualifier – defaults from contract
- SWAP counterparty - for all trades other than 'SWAP', this defaults to NULL. For swap trades, SWAP counterparty specified at the contract level gets defaulted here

The following details are defaulted from portfolio maintenance.

- Position Product
- Portfolio Costing Method
- Revaluation preferences
- Reserve calculation details

You can view the accounting entries related to revaluation by clicking 'Events' in the 'Position Detail' screen.

Note

Revaluation for HFS position is done for total position based on HFS cost basis and market price.

For more details on market price maintenance, refer the section 'Maintaining Market Price Details' in this user manual.

5.13 Maintaining CUSIP-Tranche Linkage

You can link a CUSIP to multiple tranches using the 'CUSIP-Tranche linkage' screen.

You can invoke the 'CUSIP-Tranche Linkage' screen by typing 'TLDCULNK' in the field at the top right corner of the Application tool bar and clicking on the adjoining arrow button.

The screenshot shows the 'CUSIP-Tranche Linkage' application window. At the top, there is a title bar with the text 'CUSIP-Tranche Linkage' and standard window controls. Below the title bar, there is a 'New Enter Query' button. The main area is divided into two sections: 'CUSIP/ISIN Detail' and 'Tranche Details'. The 'CUSIP/ISIN Detail' section has a text input field with the label 'CUSIP/ISIN *'. The 'Tranche Details' section contains a table with the following columns: 'Tranche Ref No *', 'Start Date *', 'End Date', 'Share %', and 'Facility Name'. The table is currently empty. At the bottom of the window, there are several fields: 'Maker', 'Checker', 'Date Time:', 'Mod No', 'Record Status', and 'Authorization Status'. There is also an 'Exit' button in the bottom right corner.

The system uses the CUSIP-Tranche linkage to accrue DCF for that CUSIP. Note that you can maintain records in this screen only if the box 'Allow CUSIP/ISIN Swing' is selected in the 'Loan Parameters' screen.

Specify the following details.

CUSIP/ISIN No

Specify the CUSIP for which you want to maintain linked tranche details. The adjoining option list displays all valid CUSIP/ISIN numbers maintained in the system. You can also select the appropriate one from it.

Tranche Details

Specify the following tranche details for the CUSIP/ISIN.

Tranche Ref no

Specify the tranche to which you want to link the CUSIP. The adjoining option list displays all active and liquidated tranches maintained in the system. If the specified CUSIP is linked to both lead and non lead (wrapper) tranches or with only lead tranches, then the option list displays only lead tranches. If the specified CUSIP is linked to non lead (wrapper) tranches,

then the option list displays only non lead tranches for which CUSIP amendment has been performed on a tranche contract.

You can also select the appropriate one from it.

Note that you have to maintain the Tranche which is currently associated in the agency for the CUSIP, if the tranche is active.

In addition, you cannot delete a tranche if it is linked to the CUSIP in the agency. The deleted tranche is not considered for DCF calculation.

Start Date

Specify the date from which the tranche should be linked to the CUSIP. This date should lie between the associated tranche value date and maturity date.

End Date

Specify the date until which the tranche should be linked to the CUSIP. This date must be greater than the start date. You should leave this field blank if the Tranche is active. Accrual is done till this date.

Share %

If the dates given for tranches overlap, then you have to provide the share percentage for those tranches. The sum of all share percentages should add up to 100.

If you mention the share percentage for multiple tranches, you should ensure that the start and end dates are the same for all those tranches.

Facility Name

The system displays the facility linked to the specified tranche.

Save the record after entering all details. The record have to be authorized in order to become effective. If an unauthorized record exists for a CUSIP in the 'CUSIP-Tranche Linkage' screen, then settlement of trade linked with the CUSIP fails as DCF catch up accrual will happen online during settlement. Such unauthorized maintenance is shown in EOD pending queue and EOD is not allowed until the maintenance is authorized.

Active commitments should be linked to all the self participants under the active tranche which is currently linked to the new CUSIP; otherwise the system does not allow you to save this record.

The system performs position validation for the new CUSIP between agency and trading. Self participant position under the tranche should match with the settled position for the CUSIP, portfolio and expense code combination in trading module. This validation is done for all the self participants associated with the active tranche which is currently linked to the new CUSIP.

You can perform the following operations on this screen only from the Head Office branch:

- New
- Save
- Delete (only before authorization)
- Authorize
- Unlock
- Close
- Reopen

5.14 Viewing CUSIP-Tranche Linkage Summary

You can view a summary of all CUSIP-Tranche linkage records in the system, using the 'CUSIP-Tranche Linkage Summary' screen. You can invoke the 'CUSIP-Tranche Linkage Summary' screen by typing 'TLSCULNK' in the field at the top right corner of the Application tool bar and clicking on the adjoining arrow button.

The screenshot shows a web application window titled "CUSIP-Tranche Linkage Summary". At the top, there are search options: "Search", "Advanced Search", "Reset", and "Clear All". Below this is a "Case Sensitive" section with two dropdown menus for "Authorization Status" and "Record Status", and a text input field for "CUSIP/ISIN" with a magnifying glass icon. A table control is visible with "Records per page" set to 15, "1 Of 1" records, and a "Go" button. The table has columns for "Authorization Status", "Record Status", and "CUSIP/ISIN". The table body is currently empty. An "Exit" button is located in the bottom right corner of the window.

The system displays the following details:

- CUSIP/ISIN No
- Tranche Ref No
- Start Date
- End Date
- Share Percentage
- Facility Name

You can query on records by clicking the 'Advanced Search' option

5.15 .Capturing Funding Memo Details

Funding memo is an advice sent to the trade counterparty, containing the trade details like counterparty, agency contract details, trade date, global commitment amount, drawdown details, fee details, settlement accounts, and so on.

This section contains the following topics:

- [Section 5.15.1, "Specifying Fee Details"](#)

- [Section 5.15.2, "Viewing Funding Memo Details"](#)
- [Section 5.15.2.1, "Viewing Pricing Details of Drawdowns"](#)
- [Section 5.15.2.3, "Viewing Fee Details"](#)
- [Section 5.15.2.4, "Viewing DCF Details"](#)
- [Section 5.15.3, "Viewing Break Funding Fee Details"](#)
- [Section 5.15.4, "Viewing Currency-wise Settlement Details"](#)

You can capture the funding memo details as well as the settlement details in the 'Trade Settlement/ Funding Memo Generation' screen. You can invoke the 'Trade Settlement' screen by typing 'TLDSETTL' in the field at the top right corner of the Application tool bar and clicking the adjoining arrow button.

The basic trade details are defaulted in this screen.

Note

ClearPar trade ID is view only during trade settlement. Oracle Banking Corporate Lending does not perform any validations (except special character validation) for the ClearPar trade ID value during trade booking and trade amendment.

You can specify the following details here:

Agency Id

Select the Id of the lead agent of the transaction, to whom the assignment fee needs to be sent.

Actual Settlement Date

Specify the date on which the actual settlement of the trade happens. You can also select the date by clicking positioned adjacently.

Assignment Fee Type

The assignment fee type is defaulted from the trade contract. You cannot modify this value.

Assignment Fee Remitter

The assignment fee remitter is defaulted from the trade contract. You can modify it, if required. Select the counterparty that remits the assignment fee to the lead agent. The options available are as follows:

- Buyer
- Seller

5.15.0.1 Specifying Fee Liquidation Details

You can indicate the fee types that you want to liquidate as part of the trade settlement. All the fee components associated with the trade contract are listed here.

Liquidate

All fee components are selected for liquidation, by default. You can deselect only the broker fee or amendment fee, if required. All other fees need to be liquidated mandatory during trade settlement.

5.15.0.2 Specifying Funding Memo Details

You can specify the preferences related to funding memo generation, here. You can indicate the following details:

Funding Memo Status

The current status of the funding memo gets displayed here. The following values are possible:

- Generated – indicates that the funding memo has been generated
- Not-Generated – indicates that the funding memo has not been generated
- Regenerate FMEM – indicates that the funding memo needs to be re-generated.

Funding Memo Source

Select the source of the funding memo from the drop-down list. If the CUSIP corresponds to an already existing agency in Oracle Banking Corporate Lending, you can select any of the following options:

- Agency
- Upload
- Manual

If the agency is not an existing agency in system, you can select the memo source as 'Manual' and specify the details manually. For an existing agency, the system defaults this option (manual). In addition, it defaults the tranche and drawdown details in 'Agency Details Input' screen based on the following:

- The borrower tranche amount is taken as it is and validations will be made to check if the transferors share amount of the tranche amount is greater than or equal to the trade amount. The system does not proceed further if this validation fails
- The borrower drawdown amount will be taken as it is for those drawdowns where the transferor is an active participant as on the trade settlement date.

The trade equivalent amount of such drawdown is derived based on the formula below:

- Trade equivalent of DD Amount = $(\text{Trade Amount} * (\text{DD Amount} * \text{Transferor's Share at DD})) / (\text{Total Tranche Amount} * \text{Transferor's Share at Tranche})$

Refer Agency Capturing details in this chapter

If the CUSIP does not exist, then the memo source gets defaulted to 'Upload', and it gets disabled. If the funding memo source is 'Upload' then you need to upload the data required for generating the funding memo.

Funding Memo Advice Required

Select this check box to indicate that funding memo needs to be automatically generated during the authorization of FMEM event.

If due to agency activity, any changes happen to the funding memo before trade settlement, then you can regenerate the funding memo. The system marks such trades for regeneration of funding memo and during trade settlement such trades are excluded from settlement.

If the payment message is already generated for the trade based on already existing funding memo, an override message is displayed while you try to regenerate the funding memo. If the payment message is already generated, you cannot modify the selection of fees to liquidate during funding memo re-generation.

You can maintain the static text part of the funding memo using Advice Format under Message Maintenance. The dynamic part in the funding memo advice is populated using the various advice tags.

For more details on advice formats, refer the section 'Maintaining Advice Formats' in Messaging user manual.

5.15.1 Specifying Fee Details

You can specify the assignment fee details during ticket settlement in the 'Assignment Fee Details' screen. To invoke this screen, click 'Fee' in the Ticket Settlement screen.

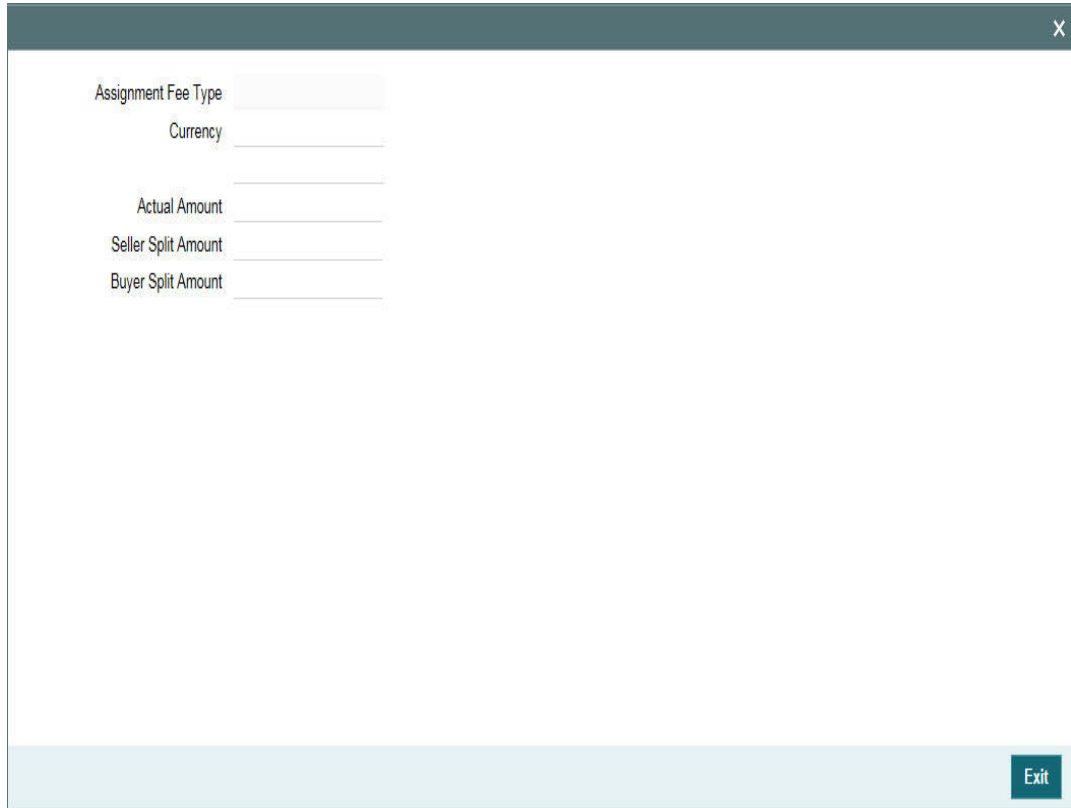

Assignment Fee Type

The system displays the assignment fee type.

Currency

Specify the currency for which you want to maintain. The adjoining option list displays all the currencies that are maintained in the system. You can select the appropriate one.

Amount

Specify the fee amount.

Buyer's Split Amount

Specify the buyer's split amount.

Seller's Split Amount

Specify the seller's split amount.

5.15.2 Viewing Funding Memo Details

You can view the funding memo details in 'Funding Memo Details' screen, which can be invoked by clicking 'Funding Memo' in 'Trade Settlement/ Funding Memo Generation' screen. You can also invoke this screen by clicking 'Funding Memo' in the SLT Trade Online screen. You cannot make any modifications to the funding memo details if you invoke this screen from the Trade Online screen.

Or

You can invoke the 'Funding Memo' screen by typing 'TLCFMEMO' in the field at the top right corner of the Application tool bar and clicking the adjoining arrow button.

Funding Memo

Trade Ref No _____ Trade User Reference Number _____

Branch _____ Desk Code _____

Portfolio _____ Expense Code _____

Portfolio Description _____ Position Qualifier _____

Position Identifier _____ Swap ID _____

CUSIP/ISIN _____ Funding Memo Source _____

Ticket ID _____ Trade Date YYYY-MM-DD _____

Agency ID _____ Facility Name _____

Settlement Date YYYY-MM-DD _____

Buy or Sell _____

Trade Details Fee Details Currency Details

Global Tranche Amount _____ Trade Price _____

Trade Currency _____ Trade Amount _____

Transfer Percentage _____

Pricing Details

1 Of 1 Go + - ☰

Drawdown Reference Number	Drawdown Amount	DD Amount in Tranche Ccy	Drawdown Currency	Rate Type
---------------------------	-----------------	--------------------------	-------------------	-----------

Ok Exit

System defaults value captured in the 'Agency Detail Input' screen here. You can view the following basic details related to the trade contract, which you cannot modify:

- Contract reference number and User reference number
- Branch, Desk, and Expense code details
- Portfolio and Position details
- CUSIP and Ticket Id
- Funding memo source
- Trade details like Global tranche amount, trade currency, trade price, trade amount and transfer percentage

Note

For Non-Lead agency contracts, where bank is the buyer of the trade with the external trade counter party, the system will not default the agency details in the 'Funding Memo Details' screen even if the details exist in the system. You need to capture the tranche and drawdown details related to such trades.

Note

The 'Interest Details' gets defaulted from 'Manual Funding Memo'. You cannot modify the details, you can only view the details. For more information on 'Alternative Risk-Free Rates Preferences', refer to *Interest User Manual*.

You can provide fee amount in negative during trade/ticket settlement.

5.15.2.1 Viewing Pricing Details of Drawdowns

For each drawdown under the tranche, you can view the details related to pricing. If the funding memo source is 'Agency', the basic funding memo details including the pricing details are fetched from the agency transactions. Otherwise, you need to provide the funding memo details in a predefined Excel format and upload it to the funding memo screen.

The following details are displayed for each drawdown:

- Drawdown reference number and drawdown amount
- Currency
- Rate Type
- Buyer's share computed as $(\text{Trade Amount} * \text{Global Amount}) / \text{Global Tranche Amount}$
- Tranche currency equivalent of buyer's share
- Funded and un-funded amounts
- Buyer's funded amount and buyer's unfunded amount

Market Rate

Specify the current market interest rate to calculate the break funding fee.

5.15.2.2 Specifying LOR Adjustments

LOR (Lender Of Record) Adjustments

In 'LOR Adjustment' section displays the till date accrual amount between the last liquidation date and settlement date component-wise for the funded amount portion for all to the drawdowns.

Manual LOR Adjustments

You can provide interest manually in specific cases (All types of Buy trade) and one Sell trade where deal type is assignment and agency is non lead. The settlement of interest is optional during any type of trade settlement (Trade/Ticket/Combined Ticket).

For information on accounting entries, refer to 'LOR Accounting Entries' section.

5.15.2.3 Viewing Fee Details

You can view the details related to the fee components in the 'Fee Details' tab.

You can view the following details here:

- Name and description of the fee component
- Currency
- Fee amount calculated by the system

Actual Fee Amount

The fee amount calculated by the system gets displayed here also. But you can modify this value, if required.

5.15.2.4 Viewing DCF Details

Delayed compensation fee is associated with trades for which the trade settlement date exceeds the expected settlement date. You can view the delayed compensation fee details related to a trade in the 'Delayed Compensation Fee Details' screen. To invoke this screen, click 'DCF Details' in 'Funding Memo Details' screen.

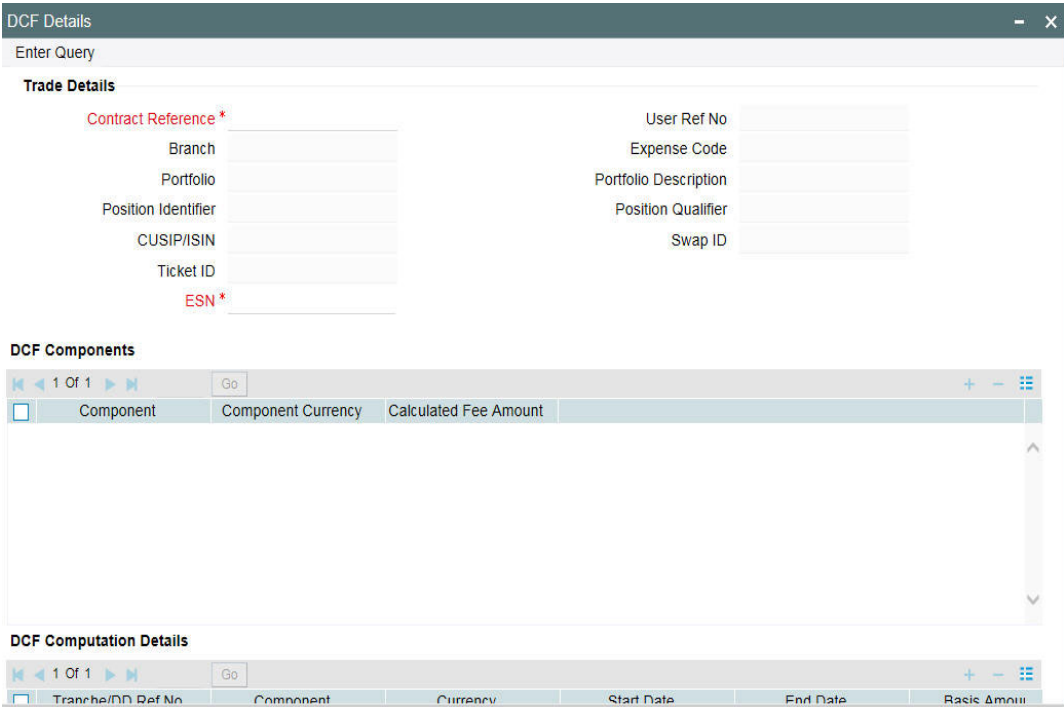

Delayed compensation fee is calculated for the DCF fee components at the tranche level individually. If the funding happens in different currencies, DCF is displayed for the fee or interest components along with the currency wise break ups.

Note

If the funding memo source is 'Agency', the DCF and Break funding fee will be computed based on the underlying agency data. Otherwise, you need to provide these details in a predefined excel format and upload it to the funding memo screen.

5.15.3 Viewing Break Funding Fee Details

You can view the details of the break funding fee in the 'Break Funding Fee Details' screen. To invoke this screen, click 'BFF' in 'Funding Memo Details' screen.

Break Fund Details

Enter Query

Trade Details

Contract Reference *

Branch

Portfolio

Position Identifier

CUSIP/ISIN

Ticket ID

ESN *

User Ref No

Expense Code

Portfolio Description

Position Qualifier

Swap ID

LBL_BFF_COMP

1 Of 1

<input type="checkbox"/>	Component	Component Currency	Calculated Fee Amount

LBL_BFF_COMOP

1 Of 1

<input type="checkbox"/>	Tranche/DD Ref No	Component	Currency	Start Date	End Date	Basis Amount

The break funding cost for each drawdown main components will be arrived at based on the drawdown base rate and the current market rate that you specified in 'Funding Memo Details' main screen.

5.15.4 Viewing Currency-wise Settlement Details

You can view the currency wise settlement details corresponding to a trade contract in the 'Currency Details' tab in the 'Funding Memo Details' screen. The details populated based on the agency data captured in the 'Agency Details Input' screen.

Funding Memo

Trade Ref No

Branch

Portfolio

Portfolio Description

Position Identifier

CUSIP/ISIN

Ticket ID

Agency ID

Settlement Date

Buy or Sell

Trade User Reference Number

Desk Code

Expense Code

Position Qualifier

Swap ID

Funding Memo Source

Trade Date

Facility Name

Trade Details | Fee Details | **Currency Details**

Currency wise Settlement Details

1 Of 1

<input type="checkbox"/>	Currency	Settlement Amount	DCF Amount	BFF Amount	Assign Fee Amount	Amend Fee Amount	Adhoc S

DCF Details | BFF

In this screen the settlement details corresponding to the different fee components are displayed. If the funding happens in different currencies, the outstanding amount and fee amounts get displayed for the various currencies involved.

5.16 Settling Trades Individually

The following activities take place during the settlement of a trade contract:

- The generation of funding memo during the save or authorization of the trade settlement, based on the advice generation parameter specified in product event advice screen for FMEM event.
- Generation of accounting entries linked to the event
- Generation of payment message upon authorization of trade settlement
- Update of LB infrastructure on authorization of the trade settlement, for trades having LB Infrastructure, mainly the bank-agency deals. For trades where bank is silently participating, the LB infrastructure gets created after the settlement.

You can initiate the settlement of a trade contract in the 'Trade Settlement Detailed' screen

Refer the section 'Capturing Funding Memo Details' for more details on this screen.

You need to manually initiate the settlement of a trade on, before or after the 'Expected Settlement date'. You need to specify the 'Actual Settlement Date', greater than or equal to the trade booking date.

The settlement of the trade happens as follows:

1. Funding memo details are extracted and payment messages are generated before the trade settlement.

If the actual settlement date is less than or equal to the system date, funding memo generation, payment message generation and trade settlement happens together. If the actual settlement date is a future date, then funding memo and payment messages are generated in advance and trade settlement happens as part of the BOD batch process on actual settlement date. Payment message can be generated either during trade settlement authorization or during the EOD batch process, depending on the number of settlement days maintained for the combination of branch and currency.

2. All fee components, except broker and amendment fees are liquidated as part of trade settlement.

3. Settlement amount is computed as follows:

$$\text{Settlement Amount} = \text{Funded Amount} - \text{Original trade amount} \times (1 - \text{price})$$

4. In case of multi currency funding, the settlement amount is computed as follows

For the trade currency,

$$\text{Settlement Amount} = F - F * (1 - \text{price}) - UF * (1 - \text{price}) - [CR1 * (CRP1 - \text{price}) + CR2 * (CRP2 - \text{price}) + \dots + CRn * (CRPn - \text{price})]$$

Where,

- F = Funded Amount
- UF = Unfunded Amount
- Price = Trade price
- CR1 = First Commitment Reduction
- CRP1 = First Commitment Reduction price
- CR2 = Second Commitment Reduction
- CRP2 = Second Commitment Reduction price

The settlement formula is further derived as follows:

$$\text{Settlement Amount} = F - F * (1 - \text{price}) - UF * (1 - \text{price}) - \text{Net_CR} * (\text{Avg_Cr_Price} - \text{price})$$

Where,

- Net_CR = (CR1 + CR2 + + CRn)
- Avg_Cr_Price = [(CR1*CRP1+CR2*CRP2+...+CRn*CRPn) / (CR1+CR2+...CRn)]

For the other funded currencies,

$$\text{Settlement Amount} = \text{Funded Amount} * \text{Price}$$

5. The difference between the Funded amount and the Settlement amount gets posted to the premium/discount account.

In case of any benefit that needs to be accrued in the event of commitment reduction, BCR (Benefit of commitment reduction) fees will be separately calculated and displayed in the funding memo. But it is not considered for settlement separately. Likewise, the upfront fee calculated and displayed in the funding memo also not considered for settlement separately.

The formula for BCR (Benefit of commitment reduction) fee is computed as follows:

$$\text{BCR Fee} = \text{Net_CR} * (\text{Avg_Cr_Price} - \text{price})$$

The formula for the upfront fee is computed as follows:

Upfront Fee = UnFunded Amount * (1-price)

Note

- Settlement Date can be back-valued but can not be less than the value date of the any agency activity of underlying agency contract.
 - If the Funding memo status is 'Regenerate FMEM' due to the agency operations, then you are not allowed to proceed with trade settlement until the funding memo regeneration happens.
-

5.16.1 Capturing External Counterparty Mnemonic Details

The system enables the 'Ext Part SSI' tab for the trade settlement if the trade is of participation sell type and an external counterparty is being added to the tranche as part of settlement. Click this tab to capture counterparty details, currency wise SSI mnemonic and customer entities.

The screenshot displays a software interface with two data tables. The top table has columns: Tranche Reference Number, Cusip No, and Counterparty. The bottom table is split into two sections. The left section has columns: Currency, SSI Mnemonic, and an empty column. The right section has columns: Entity ID, Entity Name, Remarks, and Pri. Both tables have navigation controls (back, forward, search) and a 'Go' button. At the bottom right, there are 'Ok' and 'Exit' buttons.

Specify the following details.

Counterparty Details

Specify the following counterparty details.

Tranche Ref No

The system displays the tranche reference number.

CUSIP/ISIN

The system displays the CUSP/ISIN.

Counterparty

The system displays the counterparty number.

Settlement Details

The SSI details are defaulted for the counterparty. However, you can modify them.

Currency

Specify the currency for which you want to maintain SSI mnemonic details. The adjoining option list displays all valid currency codes maintained in the system. You can also select the appropriate one from it.

SSI Mnemonic

Specify the SSI mnemonic value that should be linked to the currency. The adjoining option list displays all valid combinations available for the counterparties and SSI mnemonics maintained in the system. You can also select the appropriate one from it.

Entity Details

The entity details are defaulted for the counterparty. However, you can modify them.

Entity ID

Specify the entity that should be linked to the SSI mnemonic value and currency combination. The adjoining option list displays all entities maintained for the linked counterparty. You can also select the appropriate one from it.

Entity Name

The system displays the name of the specified entity.

Remarks

Specify remarks if any.

Primary Entity

Select this check box to indicate that the entity is a primary entity.

If the trade/ticket settlement for which SSI details are captured is pending processing from LT to LB, and another trade or ticket with the same CUSIP+Counterparty+Currency combination is settled in that interval, the latest SSI details captured will override all the other SSI details captured during the processing.

If settlement is performed to add a new external participant and subsequently if the settlement reversal is performed, the system will retain the SSI/Entity details captured during the settlement and will default the same during subsequent settlements.

5.17 Settling Trades at Ticket Level

A ticket is associated with multiple trades. Every trade contract have a ticket Id corresponding to the ticket to which it belongs. You can settle all trades corresponding to a ticket, together, by means of ticket settlement.

This section contains the following topics:

- [Section 5.17.1, "Viewing Currency Wise Settlement Details in Ticket Settlement"](#)
- [Section 5.17.2, "Handling Exceptions during Ticket Settlement"](#)

- [Section 5.17.3, "Viewing Settlement Instructions before Authorization"](#)
- [Section 5.17.4, "Specifying Fee Details"](#)
- [Section 5.17.6, "Capturing Currency-wise SSI Mnemonics"](#)
- [Section 5.17.7, "Capturing Mnemonic Details"](#)

You can perform the ticket settlement, which takes care of all trades corresponding to the ticket in the 'Ticket Settlement' screen. You can invoke the 'Ticket Settlement' screen by typing 'TLDTKSTL' in the field at the top right corner of the Application tool bar and clicking the adjoining arrow button.

You need to specify the following details in this screen:

Ticket Id

Specify the ticket Id for which you want to initiate settlement.

Actual Settlement Date

Specify the date on which the actual settlement should happen for all trades associated with the ticket.

Agency Id

The system displays the agency id.

Note

The agency id is displayed only if you have internally maintained the 'ASGNFEE_P-MNT_ATTKT' parameter value as 'Y'.

If the 'Agency id' is not maintained at trade level, then you need to do the following before proceeding with ticket settlement:

- A valid SSI Mnemonic should be maintained for the combination of assignment fee currency and either for the agent and/or for the trade counter party based on the assignment fee remitter and assignment fee Type.
- If the value of 'Agency ID' differs across trades under a ticket, the 'Agency ID' field remains blank and user is allowed to proceed with ticket settlement input. User can select the desired Agency ID from the list of values.
- In case if the assignment fee remitter is the trade counter party and if bank has to pay its contribution, the SSI Mnemonic for the assignment fee currency should be maintained for the trade counter party.
- If bank is the assignment fee remitter and if bank has to pay its contribution, the SSI Mnemonic for the fee currency should be maintained for the Agent.
- If bank is the assignment fee remitter and if both bank and the trade counter parties has to pay their contribution, the SSI Mnemonic for the fee currency should be maintained for the Agent as well as trade counter party
- During the ticket settlement the agency id and SSI mnemonic information is propagated to trade level
- The Agency ID selected in the ticket settlement screen overwrites the Agency ID captured at the individual trade level

If the 'Agency id' is maintained at trade level, then the system does the following validations before proceeding with ticket settlement:

- Even if the 'Agency id' is present for all trades under the ticket, the system allows you to amend agency ID in 'Ticket Settlement' screen during ticket settlement. You should manually control entering of the correct agency id and SSI Mnemonic.

Funding Memo Advice Reqd

Select this check box to extract funding memo details or the individual trades under the ticket before settlement processing.

You can suppress funding memo advice generation at the trade level

The following details related to individual trades under the ticket are displayed:

- Contract reference number
- Trade booking date
- Trade amount and trade currency
- Expected settlement date
- Buy/sell indicator and the funding memo source
- Trade counterparty
- Settlement status and Trade authorization status which get updated depending on the success or failure of individual trade settlements Status is updated as processed only when all the underlying trades are successfully settled.
- All fee components across the trades under the ticket are also displayed

During each trade under a ticket, system extracts the drawdown details if the agency contract exists. The DD amount is the actual DD balance under the Tranche. And if the agency contract does not exist, you can select the funding memo source as "Manual" and specify the Drawdown details for each trade.

Process Status

The status of the trade settlement gets displayed here. The status can be any of the following:

- Processed – settlement for the trade is carried out successfully
- Unprocessed – trade is pending for funding memo and settlement processing
- FMEM Extracted – funding memo data extraction either through agency or through upload has been completed successfully
- Exception – unable to complete the funding memo activity due to some error encountered
- Failed – settlement for the trade has failed due to some exception

Trade Auth Status

The status of trade authorization is displayed here. The status can be any of the following:

- Unauthorized – indicates that authorization of the trade is pending
- Failed – indicates that authorization of the trade has failed
- Authorized – indicates that the trade has been authorized successfully

Settlement Status

The actual status of the settlement gets displayed here. The status can be any of the following:

- Settled – indicates that trade settlement has happened successfully
- Unsettled – indicates that trade settlement has not happened or has failed
- Reversed – indicates that trade settlement has been reversed

Ticket settlement takes place as follows:

1. Click 'FMEMO' for each trade to invoke the 'Funding Memo Details' screen.
2. Save the ticket settlement details after completing the funding memo generation activity for each trade.
3. All fee components across the trades under the ticket get displayed in ticket settlement screen. You cannot deselect any of the components during ticket settlement.
4. Once you save the ticket settlement details, a background job process performs trade settlement for each trade under the ticket.
5. While settling individual trades under the ticket, system considers only the applicable fees for the trade and liquidates accordingly. Accounting entries are passed at trade level.
6. You can authorize a ticket settlement only after all the trades under the ticket are settled successfully. You cannot authorize individual trade settlements, if the settlement is done using ticket settlement.
7. Payment messages are generated during the authorization of the ticket if the settlement date is on or before the system date. If the actual settlement date is in the future, then the payment messages are generated in advance as per currency wise settlement days.
8. Payment message gets generated for the ticket if the 'payment message netting required' option is enabled at branch parameters screen. Else the payment messages will be sent for the trades, independently.

If any of individual trade settlement fails, then 'Settlement status' for the trade gets updated as 'Failed'. Failed trades need to be settled manually using the trade settlement screen.

You can delete ticket settlement details, if required, before it gets authorized. But you cannot perform a reversal for the ticket settlement. However, you can reverse trade settlements for individual trades using the trade settlement screen.

Note

Settlement for a ticket can happen only once. If a ticket has already been settled and a new trade comes from Loans QT with the same ticket Id, it needs to be settled individually. Ticket settlement is not possible in such scenarios.

5.17.1 **Viewing Currency Wise Settlement Details in Ticket Settlement**

DCF on the drawings/commitment/facility/utilization amount are computed only if the agency contract exists in the system. You have to capture the Agency Details and drawdown details, if the agency does not exist. System computes the DCF only for the DCF-FIX-MARGIN sub component using the Margin rate captured along with the drawdown details.

You can overwrite fee values in the FEE Details Tab for each trade. Market rate is captured for each drawdown to compute the Break funding FEE. After the drawdown details and FEE details are confirmed, system displays the currency wise settlement amount for each trade in the Funding Memo Details screen.

Drawdown details captured in the Agency details input screen can be modified only in the agency input screen. You have to confirm the currency wise settlement amounts for each trade under the ticket. After the confirmation, system displays the currency wise settlement amount for the ticket and you cannot overwrite any amounts at the ticket level. Click Payment details in the 'Payment details' button in the ticket settlement screen. The currency wise settlement details are displayed in the 'consolidated details' for each counter party individually for each drawdown currency across all the trades under the ticket and payment message related details for each currency counterparty combination.

In case of multi counter party Tickets, system captures the SSI mnemonic for each combination of counter party and currency. The cash flows is consolidated for the combination of Ticket, Counter Party and Currency and payment messages are generated for each of these combinations if they are associated with cash flows. The accounting entries are passed at the trade level for the trade counter party.

Note

The accounting entry should be reconciled with the ticket level payment message manually.

In case of multi counter party tickets, system internally creates separate contract numbers for each counter party and payment messages are generated for these new contract ref numbers. These contract numbers are displayed along with the counter party as Sub Ticket Ref No.

5.17.2 **Handling Exceptions during Ticket Settlement**

If any exception occurs during funding memo generation, you need to reverse the trade through trade online screen. During authorization of the trade reversal, the trade is removed from ticket settlement list. If all other trades are in 'FMEM Extracted' status then the ticket status also gets updated to 'FMEM Extracted' and all such trades under the ticket is picked up for further processing.

If any failure happens during the settlement process as background job, you need to settle the failed trades independently, using the trade settlement screen. After successful completion of the trade settlement the ticket status gets updated to 'Processed' if all other trades corresponding to the ticket are also in 'Processed' status. If you are unable to perform trade

settlement from the trade settlement screen, then you need to reverse the trade and then proceed with ticket settlement.

If any failure occurs during authorization of the ticket, you can authorize such trades independently from the trade settlement screen. On successful authorization, the trade authorization status gets updated as 'Authorized', and if all other trades are also authorized then ticket authorization status also gets updated as 'Authorized'.

5.17.3 Viewing Settlement Instructions before Authorization

During ticket settlement authorization, system enforces the authorizer to visit the settlement information to view and verify whether the SSI mnemonic selected is valid and the settlement details of the payment message are appropriate.

For authorizing ticket settlement, click 'Authorize' button in the 'Authorization' (TLDTKSAU) screen.

The screenshot shows the 'Authorization' window with the following search criteria:

- Ticket ID
- Contract Ref No
- Event Date
- Input By
- Trade Date
- Expt Settl Date
- Actual Settl Date

Below the search criteria are three data tables, each with a 'Go' button and navigation controls:

<input type="checkbox"/>	Settlement Visited?	Counterparty	Customer Name	Subticket/Trade Ref No	Settlement Info

<input type="checkbox"/>	Currency	Total Outstanding	Delayed Compensation Fee	Break Funding Fee	Assignment Fee	Amendment Fee	Adhc

<input type="checkbox"/>	Confirmed	Override Text	Auth Status	Auth By	Auth date

The below details are displayed for each sub-ticket reference number.

- Counterparty Number (Customer Number)
- Counterparty Name (Customer Short Name)
- Currency Wise Settlement amount

The below details are displayed for each currency when more than one currency is associated with the ticket/combined ticket settlement.

- Total Outstanding (Funded nominal considering premium/discount balance)
- Delayed Compensation Fee
- Break Funding Fee

- Assignment Fee
- Amendment Fee
- Adhoc Seller Fee
- Adhoc Buyer Fee
- Waiver Fee
- Total amount (To be remitted to seller)

During ticket settlement authorization, based on whether the 'Pmt Msg Netting at Ticket Level' is checked or unchecked at the branch level in Secondary Loan Trading - Branch Parameters Maintenance (TLDBRPRM), you have to visit the settlement information for all the sub ticket reference number available under the trade or the trade reference numbers available under the ticket respectively.

On clicking the 'Settlement Info' button, the following screen is invoked:

The authorizer is not allowed to proceed with authorization unless the 'Settlement Information' screen is visited for each and every trade reference number or sub ticket reference number.

Similarly, during trade settlement authorization too, you are enforced to visit the settlement information screen in order to proceed with the authorization.

5.17.4 Specifying Fee Details

You can specify the assignment fee details during ticket settlement in the 'Assignment Fee Details' screen. To invoke this screen, click 'Fees' in the Ticket Settlement screen.

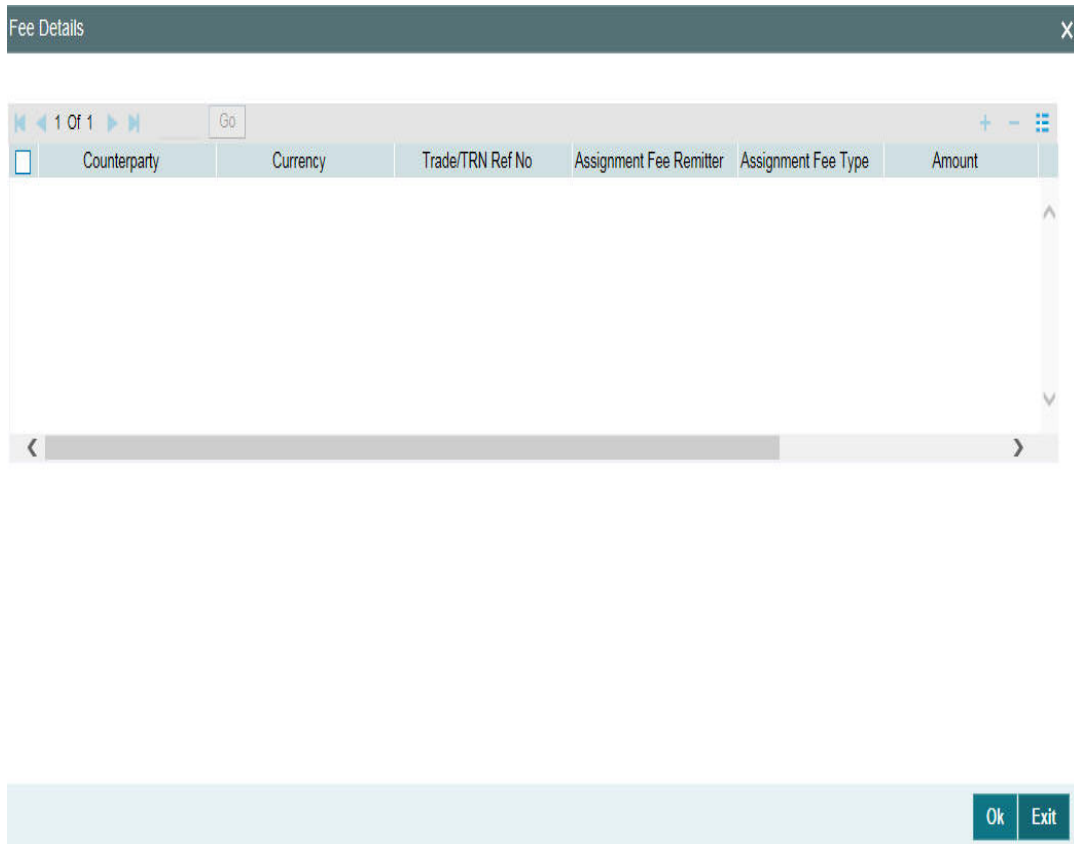

Specify the following details:

Counterparty

Specify the counterparty for which you want to maintain. The adjoining option list displays all the counterparties from all the trades under the ticket. You can select the appropriate one.

Currency

Specify the currency for which you want to maintain. The adjoining option list displays all the currencies that are maintained in the system. You can select the appropriate one.

If the selected currency for a particular trade and counterparty combination can be different from trade currency.

Example

Ticket ID: TIK1

Contract Ref No: TR1 (where trade currency is USD)

Counterparty: C1

Currency: GBP (selected in Fee sub-screen)

The same fee currency cannot be selected more than once for a given counterparty

Example

Consider Ticket ID TIK1 with two underlying trades TR1 and TR2, with the same Counterparty C1 and trade currency USD and GBP respectively

If you want to record two fee records one after the other, the system does not allow the second record to be captured unless a different currency is specified

Example

Ticket ID: TIK1

Contract Ref No: TR1 (where trade currency is USD)

Counterparty: C1

Currency : GBP (selected in Fee sub-screen)

Ticket ID: TIK1

Contract Ref No: TR2 (where trade currency is GBP)

Counterparty: C1

Currency : GBP (selected in Fee sub-screen)

For a combination of counterparty and currency, only one trade is allowed to select for posting Assignment fee currency. For a particular Contract Ref No that is. trade, only a single posting of Assignment Fee is allowed.

Example

Continuing the above example, if user defines a fee record as follows system does not allow Contract Ref No. TR1 to be selected for a subsequent record

Ticket ID: TIK1

Contract Ref No: TR1 (where trade currency is USD)

Counterparty: C1

Currency: USD (selected in Fee sub-screen)

Trade Reference no

Specify the trade reference number for which you want to maintain. The adjoining option list displays the list of trade reference numbers for the selected counterparty under the ticket. You can select the appropriate one.

Assignment fee remitter

The system defaults the value when you select the of trade reference number. However, you can change this value by choosing – Buyer or Seller.

Assignment Fee Type

Select the assignment fee remitter from the adjoining option list. The following are the options that get displayed:

- BUYER
- SELLER
- SPLIT
- PAID IN ADVANCE

Amount

Specify the fee amount.

Buyer's Split Amount

You can specify the amount for each counterparty, currency combination.

Seller's Split Amount

You can specify the amount for each counterparty, currency combination. Whereas if the assignment fee type is Buyer, Seller or SPLIT the following validations need to be followed:

- If the Assignment Fee Type is 'SPLIT', 'Amount' field is not enabled and the value will be defaulted as the sum of Buyer's and Seller's split
- If the assignment Fee type is Buyer or Seller, the fields – Buyer's Split Amount and Seller's Split Amount is disabled. In this case, amount is mandatory
- If the assignment Fee type is 'SPLIT', the fields Buyer's Split Amount and Seller's Split amount are mandatory

5.17.5 Specifying Payment Details

For information on payment details, refer to 'Processing Fee Details' chapter in this *User Manual*.

5.17.6 Capturing Currency-wise SSI Mnemonics

You can capture currency-wise SSI mnemonics for the counterparties as well as the agencies involved in trades associated with a ticket in the 'Ticket SSI Mnemonic' screen. To invoke this screen, click 'SSI' in the Ticket Settlement screen.

The screenshot shows the 'SSI' (Ticket SSI Mnemonic) screen. It features a title bar with the text 'SSI' and a close button. Below the title bar, there are two input fields: 'Ticket ID' and 'Ticket Ref No'. Below these fields, there are two data grids. The first grid has columns: 'Customer', 'Customer Name', and 'Type'. The second grid has columns: 'Ccy', 'Currency Description', 'SSI Mnemonic', and 'Remarks'. Both grids have a 'Go' button and navigation arrows. At the bottom right, there are 'Ok' and 'Exit' buttons.

The following details are displayed in this screen:

- Ticket Id and reference number

- Customer Id and name
- Customer type indicating whether it is agency or counterparty
- Pay / Receive account
- Counterparty
- Pay / Receive branch
- Account with Institution
- Beneficiary Institution
- Ultimate Beneficiary
- Customer Name
- Pay / Receive Currency

You can specify the following details:

Ccy

Select the currency for which you want to maintain the SSI mnemonic, from the option list provided.

SSI Mnemonic

Select the SSI mnemonic to be associated with the currency, from the option list provided.

The details specified in this screen are propagated to all trade contracts associated with the ticket.

Remarks

Specify any additional information about the SSI mnemonics details.

5.17.7 Capturing Mnemonic Details

If there is a participation sell deal trade that is not successfully handed over to the LB module, the system enables the 'Ext Part SSI' tab . Click this button to capture counterparty details, currency wise SSI mnemonic and customer entities.

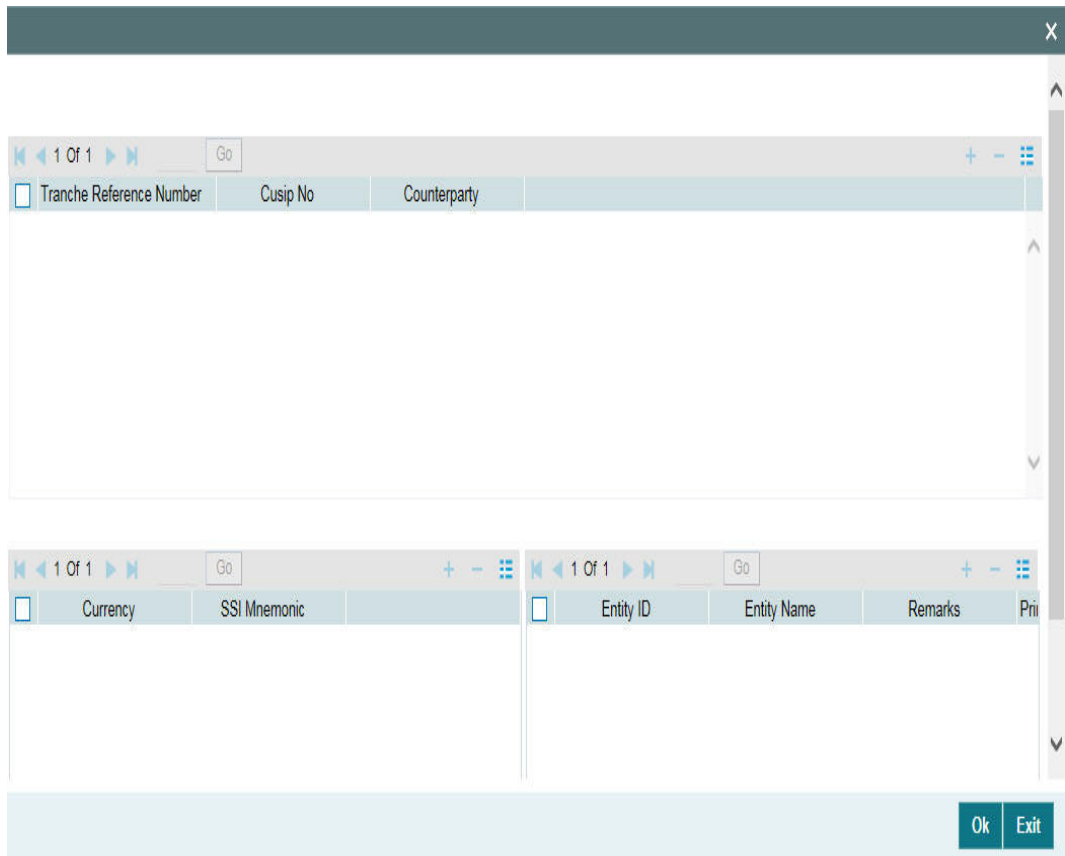

Specify the following details.

Counterparty Details

Specify the following counterparty details.

Tranche Ref No

The system displays the tranche reference number.

CUSIP/ISIN

The system displays the CUSP/ISIN.

Counterparty

The system displays the counterparty number.

Settlement Details

The SSI details are defaulted for the counterparty. However, you can modify them.

Currency

Specify the currency for which you want to maintain SSI mnemonic details. The adjoining option list displays all valid currency codes maintained in the system. You can also select the appropriate one from it.

SSI Mnemonic

Specify the SSI mnemonic value that should be linked to the currency. The adjoining option list displays all valid combinations available for the counterparties and SSI mnemonics maintained in the system. You can also select the appropriate one from it.

Entity Details

The entity details are defaulted for the counterparty. However, you can modify them.

Entity ID

Specify the entity that should be linked to the SSI mnemonic value and currency combination. The adjoining option list displays all entities maintained for the linked counterparty. You can also select the appropriate one from it.

Entity Name

The system displays the name of the specified entity.

Remarks

Specify remarks if any.

Primary Entity

Select this check box to indicate that the entity is a primary entity.

If the trade/ticket settlement for which SSI details are captured is pending processing from TL to LB, and another trade or ticket with the same CUSIP+Counterparty+Currency combination is settled in that interval, the latest SSI details captured will override all the other SSI details captured during the processing.

If settlement is performed to add a new external participant and subsequently if the settlement reversal is performed, the system retains the SSI/Entity details captured during the settlement and defaults the same during subsequent settlements.

5.17.8 Field 72 Population in Wire Messages

1. If the SSI mnemonic of the trade counterparty already contains field 72 details, the existing details are retained and the below information is added in the next available free line in the wire messages.
2. If the length of the line exceeds 35 characters after concatenating the below, then only the first 35 characters are populated.

Note

If there are no free lines in the already existing field 72 details, then the below information is not added.

- Trade / Ticket Settlement - ClearPar ID + Borrower Name (that is, tranche counterparty customer name)
 - Consolidated Ticket Settlement - NET + ClearPar ID + Borrower Name (that is, tranche counterparty customer name)
3. If the SSI mnemonic does not have field 72 details, the system adds the below information in line 1 of field 72 in the wire messages.
 4. If the length of the line 1 of field 72 exceeds 35 characters after concatenating the below, then line 1 of field 72 displays only the first 35 characters.
 - Trade / Ticket Settlement - /BNF/ClearPar ID + Borrower Name (that is, tranche counterparty customer name)
 - Consolidated Ticket Settlement - /BNF/NET+ ClearPar ID + Borrower Name (that is, tranche counterparty customer name)

This functionality is application for Trade, Ticket, Combined Ticket, and Automated Settlement.

5.18 Settling Combined Tickets

In the combined ticket settlement screen, you can perform the settlement for multiple buy trades and multiple sell trades under one or more tickets with various counterparty and currency combinations across CUSIPs as part of a single transaction. You can process the settlement if the option is selected at the bank level in the 'Loans Parameters' screen.

This section contains the following topics:

- [Section 5.18.1, "Specifying Fee Details"](#)
- [Section 5.18.2, "Capturing Mnemonic Details"](#)
- [Section 5.18.3, "Consolidated Interface Browser"](#)

You can invoke the 'Combined Ticket Settlement' screen by typing 'TLDMTSTL' in the field at the top right corner of the Application tool bar and clicking the adjoining arrow button.

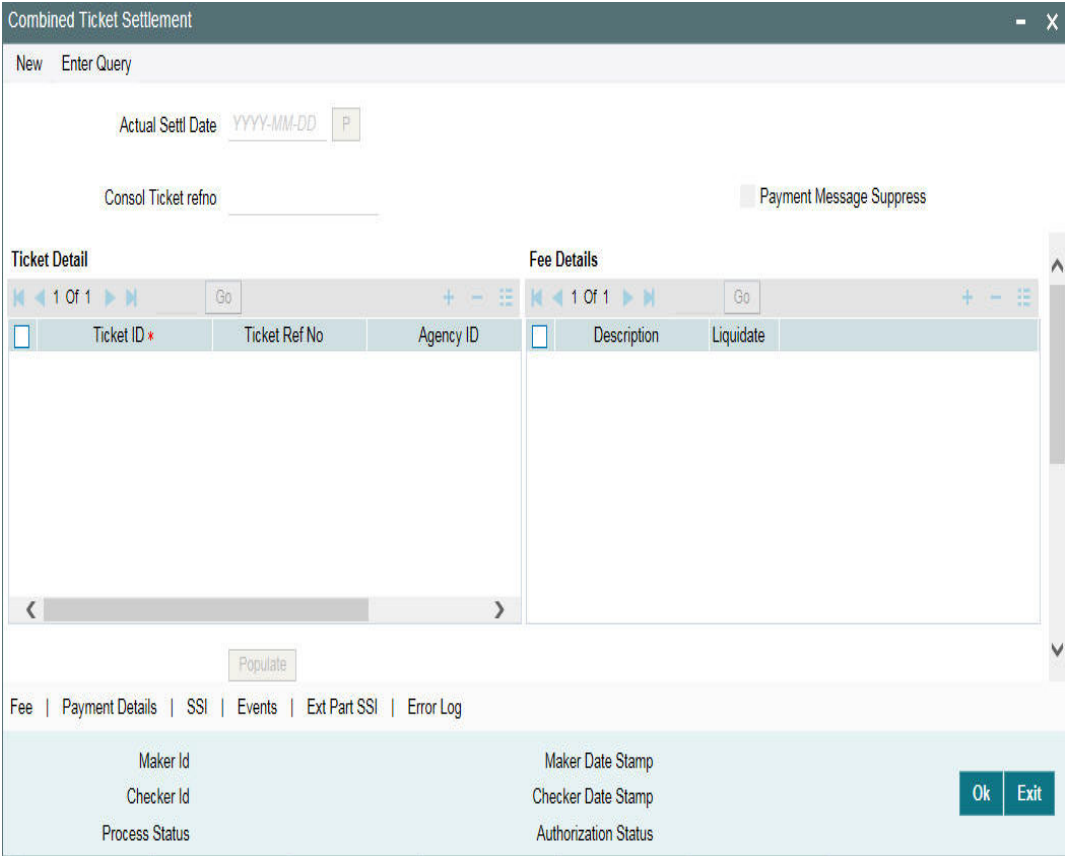

The system generates Consol Ticket Refno for a new combined ticket settlement.

Ticket ID

Select the multiple Ticket Ids for settlement under the generated consolidated ticket reference number.

Actual Settlement date

Specify the actual settlement date for all the tickets/trades settled under generated consolidated ticket reference number.

Payment Msg Suppress

Select the check box to indicate that the payment message should not be generated for each counterparty/agent and currency combination.

The system displays all the active trades under the ticket id selected.

Agency Id

Select the agency id from the adjacent list of agency id maintained in the system. If assignment fee is captured for any trade under a ticket then agency id maintenance is mandatory.

Select?

The check box against each trade for the selected ticket id gets selected for settlement. Deselect this check box to indicate that the trade in 'Trade Details' section is not selected for settlement. Deselected trades are allowed to be settled later in the combined ticket settlement screen with a new consol ticket ref no.

At least one trade should be selected for settlement under the generated ticket id, else you have to delete the generated ticket id. You can delete the ticket id before saving the details in the combined ticket settlement screen.

You can view the rest of the details under the Trade Details and Fee Detail section.

5.18.1 Specifying Fee Details

You can specify the assignment fee details during the combined ticket settlement. To invoke this screen, click 'Fee' in the Combined Ticket Settlement screen.

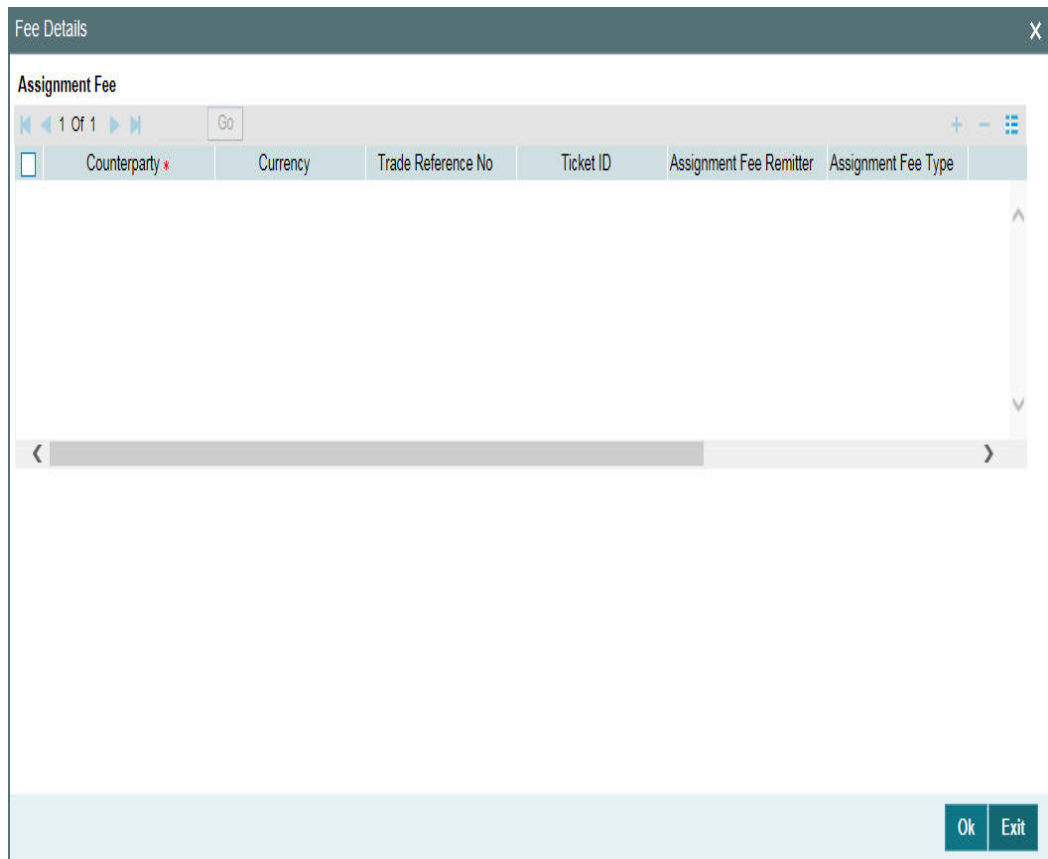

The screenshot shows a window titled "Fee Details" with a close button (X) in the top right corner. Below the title bar, there is a section labeled "Assignment Fee". At the top of this section, there is a navigation bar with a "Go" button and a "1 Of 1" indicator. Below the navigation bar is a table with the following columns: Counterparty (with a dropdown arrow), Currency, Trade Reference No, Ticket ID, Assignment Fee Remitter, and Assignment Fee Type. The table is currently empty. At the bottom right of the window, there are two buttons: "Ok" and "Exit".

You can select a trade under which the assignment fee to be settled for the combination of counterparty and currency.

Refer 'Specifying Fee Details' section in the current chapter for details in this screen.

Specifying SSI Mnemonics

You can capture currency-wise SSI mnemonics for the counterparties as well as the agencies involved in trades associated with a ticket in the 'Ticket SSI Mnemonic' screen. To invoke this screen, click 'SSI' in the 'Combined Ticket Settlement' screen.

The screenshot shows a window titled "SSI Mnemonic" with a search field for "Consol Ticket refno". Below the search field are two data tables. The first table has columns for "Customer", "Customer Name", and "Customer Type". The second table has columns for "Currency", "Currency Name", "SSI Mnemonic", and "Remarks". Both tables are currently empty. At the bottom right of the window are "Ok" and "Exit" buttons.

Refer 'capturing currency-wise SSI Mnemonics' section in the current chapter for details in this screen.

5.18.2 Capturing Mnemonic Details

If there is a participation sell deal trade that is not successfully handed over to the LB module, the system enables the 'Ext Part SSI' tab. Click this button to capture SSI details for external participants.

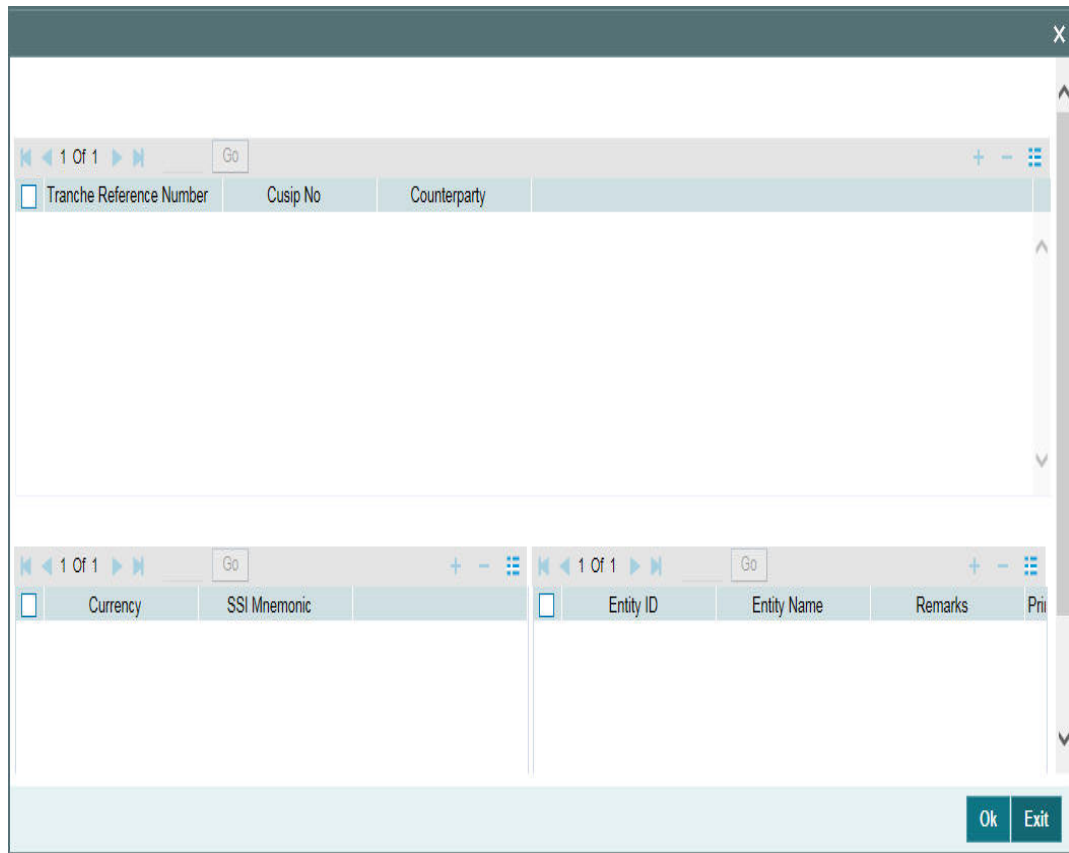

Refer 'capturing currency-wise SSI Mnemonics' section in the current chapter for details in this screen

5.18.2.1 **Saving and Authorizing Combined Ticket Settlement**

You can save the transaction and after the successful validations applicable for a trade during settlement, a background job assigned for each branch picks up the record and process the settlements. You can authorize the combined ticket settlement once settlement is processed for all the trades selected for settlement across all the tickets under a Consol ticket reference. The authorization is online for all the trades that are settled as part of combined ticket settlement.

You can invoke the 'Combined Ticket Settlement Authorization' screen by typing 'TLDMTSAU' in the field at the top right corner of the Application tool bar and clicking the adjoining arrow button.

If the settlement is failed for any trade under a consol reference number, the Consol Ticket status is updated as 'Failed'. Process status is updated as 'Failed' for the failed trade. You have to save the settlement for the failed trade in the trade settlement screen. Once the settlement is processed for all the failed trades, Consol Ticket Status is updated as 'Processed'.

If settlement authorization is failed for any trade under a consol reference number, you cannot authorize the combined ticket settlement. You have to authorize the trade in the trade settlement screen. After the authorization of the all the failed trades, combine ticket settlement can be authorized. Consol Auth Status gets updated as 'Authorized' after authorizing combined ticket settlement record. If authorization is failed for any trade during combined ticket settlement authorization then the trade should be authorized in the trade settlement screen.

You cannot delete any record in trade settlement screen when trade settlement processing or trade settlement authorization is failed for the trade in the combined ticket settlement screen. Combined ticket settlement reversal is not allowed. Reversal of trade settlement for individual trades is allowed from the trade settlement screen, after authorizing combined ticket settlement. The trade is allowed to be settled again in the combined ticket settlement screen after the settlement reversal provided all the validations are successful.

Trades under a ticket can be settled partially. For instance, if there are two trades under a ticket id, user can settle one trade first and then user can settle the second trade under the same ticket id later. Combined ticket settlement can be allowed with actual settlement date as back dated or current dated; provided all the existing validations for the actual settlement date is successful. Future dated settlement is not allowed in combined ticket settlement screen.

Below operations are allowed in the above screen:

- New

- Save
- Delete
- Authorize

If multiple buy and sell trades are getting settled under different tickets that belong to same CUSIP, portfolio, and expense code then buy and sell position for the CUSIP, portfolio and expense code is consolidated and is validated with the current Oracle Banking Corporate Lending position. Consolidation can result into any of the following:

- A net buy (sum of buy position is greater than sell position)
- A net sell (sum of sell position is greater than buy position)
- A net zero (sum of buy equals to sum of sell position)

Note: Net position validation for self participant is done against total position in TL. Net position validation for external participant is done against TRANSFER_AVL balance in LB.

Counterparty need not be the same for net position validation. The validation can be applicable for both lead and non lead tranches including desk to desk transfer.

If combined ticket settlement is unauthorized then settlement with the same ticket id which is unauthorized in the combined ticket settlement screen, is not allowed in the existing ticket or trade settlement screen. Combined ticket settlement is not allowed if any ticket is pending for authorization in trade or ticket settlement screen.

You can maintain assignment fee under a consol ticket reference for the combination of agent id, counterparty and currency. The system does not perform any validations if assignment fee is settled multiple times for the same combination of ticket id, counterparty, and currency and it should be operationally controlled.

You can choose a trade under which the assignment fee to be settled for the combination of counterparty and currency, which need not be the trade currency. Appropriate override is displayed if combined ticket settlement is saved without assignment fee details. If assignment fee is captured in multiple currencies for the same agent id/counterparty then SSI should be captured for all the currencies for the agent / counterparty. Assignment fee entries are posted at the trade level for the assignment fee currency.

During combined ticket settlement, if assignment fee is maintained for a trade (driver contract) and the trade settlement fails for the driver contract then, the settlement can be performed in the individual trade settlement screen. SSI should be maintained during trade settlement for the driver.

If settlement fails in the trade settlement screen, then user have to delete the combined ticket settlement and have to perform combined settlement again.

If 'Allow Combined Ticket Settlement' is selected then Desk to desk transfer functionality is allowed only from the combined ticket settlement screen and STP is done systematically in LB. Desk to Desk transfer functionality is applicable for both lead and non-lead tranches. The system considers inter-desk trades as normal SLT trades and accounting entries gets posted based on the maintenance at the product level.

If you don't want the accounting entries to be posted for desk to desk type of trades then it needs to be handled operationally with appropriate product maintenance

The system performs validation during desk to desk transfer that all the buy trades booked under one of the tickets with particular CUSIP, position identifier and counterparty combination should match with all the sell trades booked under another ticket by flipping position identifier and counterparty compared to buy trades under the same CUSIP.

The sum of all buy trade amounts for a particular CUSIP, position identifier and counterparty combination should match with the sum of all sell trade amounts for the mentioned combination. Multiple CUSIPs are allowed to be settled under a single desk to desk ticket. Position is updated systematically for each CUSIP individually in LB.

Desk to desk transfer is allowed only from combined ticket settlement screen. Desk to desk transfer is allowed to be clubbed with other SLT trades. However net position validation is done separately for desk to desk trades and SLT trades. Ticket id should be unique for each leg within a desk to desk transfer. Desk to Desk transfer is applicable only between Par and Distress desks. Origination desk and TRS desk are not allowed to be participated in desk to desk transfer. Desk to Desk transfer is applicable only for assignment type of trades.

Net position movement is processed from TL to LB only for the trades settled in combined ticket settlement screen by consolidating the position for the combination of CUSIP and Position identifier/self-participant across one or more tickets. Once ticket(s) is/are settled and authorized system will group all the trades under the ticket(s) based on CUSIP and position identifier.

All the trades settled under the ticket(s) are marked as 'Combined' in current TL-LB interface browser and the consolidated record is populated in the new TL-LB Consolidated browser. One row is populated for each net position for the combination CUSIP and position identifier with default status as 'Handoff'.

A job process either PRAM or NPVAMI STP for the net position and update the status as processed else failed with appropriate exception.

If Participation buy and sell trades are settled together under a consol reference number, the Consolidated TL LB browser gets populated with two events; one for buy and another for sell. Process status for participation buy is updated as 'Manual' by default in the Consolidated STP browser.

Net position movement is applicable only for Non lead tranches for SLT trades with assignment and participation and for lead and non lead tranches during desk to desk transfer only with assignment. Net position movement is not applicable for Non lead tranches for CLP trades and Lead tranches for CLP and SLT.

The message is populated in the forward processing browser with consolidated ticket reference number or consolidated sub ticket reference number. For single message, the payment message gets populated with consolidated ticket reference number and for multiple payment messages, each payment message gets populated with unique reference number.

The system generates the payment messages during the authorization of combined ticket settlement. If the settlement authorization fails for any trade, then you need to perform the authorization in the Trade Settlement screen.

If multiple counterparties exist under a ticket, then:

- The system allows you to capture the SSI mnemonic for each combination of counter party and currency. The cash flows are consolidated for the combination of counterparty, currency, and payment messages are generated for each of these combinations if they are associated with cash flows (if any).
- The system internally creates separate contract numbers (Payment reference number) for each counterparty and currency. The system generates the payment messages under payment reference number.

The Field 72 in the payment messages are populated with the following combination.

'NETTING + LQT TICKET ID + BORROWER FROM LQT TICKET ID'

Note

- The system generates the payment messages for all the counterparty or agent and currency combination when the last trade is getting authorized in the Trade Settlement screen.
- The system does not regenerate the payment messages as part of trade resettlement, if the ticket level payment message is already generated. However, the accounting entries are passed at the trade level.

During combined ticket settlement, system always sends the settlement acknowledgement message to LQT at the individual trade level irrespective of the flag value in SLT branch parameter screen. Message is sent to LQT only for the trades that are selected for settlement.

5.18.3 Consolidated Interface Browser

The system can process TL-LB, STP for net position for the combination of CUSIP and position identifier for the trades settled in combined ticket settlement screen. You can invoke the 'LB Consolidated Interface Detailed' screen by typing 'TLDLBCIB' in the field at the top right corner of the Application tool bar and clicking the adjoining arrow button.

LB Consolidated Interface Detailed

Enter Query

TL Details

Source Code *

Consol Ticket Ref No *

Value Date

CUSIP/ISIN *

Reprocess

LB Details

Contract Ref No

Processing Date

Event Code

Event Seq No

Processing Status

Trade Details Participant Details Exceptions

1 Of 1 Go

Ticket ID	Trade Ref No	Event Seq No	Position Identifier	Counterparty	Buy/Sell	Cur

Maker ID Checker ID Authorization Status Mod Number

Maker Date Stamp Checker Date Stamp Record Status

Exit

The system consolidates the position for the combination of CUSIP and portfolio under the Consol ticket reference and populates one event in the Consolidated TL-LB STP browser. Each row consists of PRAM or NPVAMI details that are processed in LB.

Trade details and participant details are available for each record.

Click 'Trade Details' tab to view the trade details that are consolidated across CUSIPs and Tickets.

Click 'Participant Details' tab to view the participant details for whom the update is required in LB.

All the records are in one of the following processing status:

- Handoff
- Processed
- Failed
- Manual
- Extraction

You can view the exceptions in the 'Exception' tab.

5.18.4 Specifying options in Loan Parameters screen

You can invoke the 'Loans Parameters' screen by typing 'OLDLNPRM' in the field at the top right corner of the Application tool bar and clicking on the adjoining arrow button.

ClearPar TradeID in Field72

By default, 'ClearPar TradeID in Field72' check box is not selected in 'Loan Parameters' screen.

The screenshot shows the 'Loans Parameters' window with the following parameters and options:

Parameter	Value	Option	Status
INTEREST SUPPRESSED	BORR_CRNT_ADV_W	<input type="checkbox"/>	
AUTO RATE SET JOB START TIME	10:00	<input type="checkbox"/>	
DISALLOW EVENTS TO INTELLECT		<input type="checkbox"/>	
CLEARING LINE GFRN IDENTIFIER		<input type="checkbox"/>	
BRIDGE ACCOUNT DEPARTMENTS	702	<input type="checkbox"/>	
CHINESE NAME IN CIF	Y	<input type="checkbox"/>	
CHINESE SUBJECT LIN	Y	<input type="checkbox"/>	
ALLOW ZERO INTEREST PERCENTAGE	Y	<input type="checkbox"/>	
Previous Rate Available		<input type="checkbox"/>	
Accrual Entry On Holiday		<input checked="" type="checkbox"/>	
TRADE INTEGRATION		<input checked="" type="checkbox"/>	
360 INTEGRATION		<input checked="" type="checkbox"/>	
CLEARPAR TRADEID IN FIELD72		<input checked="" type="checkbox"/>	
AUTO CONFIRM MESSAGES		<input checked="" type="checkbox"/>	
AUTOMATE TICKET SETTLEMENT		<input checked="" type="checkbox"/>	
Split Rollover Acc Entry		<input checked="" type="checkbox"/>	

At the bottom of the screen, the following information is displayed:

- Maker: ANUSHAMAK, Date Time: 2017-10-04 12:54:04, Mod No: 20, Record Status: Open
- Checker: ANUSHAUT, Date Time: 2017-10-04 12:54:20, Authorization Status: Authorized

- If the 'ClearPar TradeID in Field72' is selected and ClearPar trade ID presents for one of the trades under the ticket then ClearPar trade ID is displayed in the first row of field 72 in the payment message that is generated at the ticket level or trade level.
 - ClearPar trade ID is displayed in field 72 only when the value is present for at least one trade under the ticket. Note that ClearPar trade ID is displayed in field 72 though ClearPar trade ID is blank for the current trades being settled but present for the other active / settled trades under the same ticket.
 - ClearPar trade ID is displayed in 'Sender to Receiver Info' field in settlement details tab and ClearPar trade ID is sent in payment message as well for MT103 and MT 202.

- Field 72 is populated with ClearPar trade ID as mentioned above during trade settlement as well. ClearPar trade ID is populated in field 72 even if the value is blank for the current trade being settled but other trade(s) under the ticket has the ClearPar trade ID.
- If this check box is selected or cleared but ClearPar trade ID value is blank for all trades during settlement then the existing functionality of field72 population continues to work.
- During ticket settlement, the system picks up ClearPar trade ID in random from any trade being settled and displays in field 72. It is expected that you have to perform ticket settlement for trades having same ClearPar trade ID and this should be manually done.
- During ticket settlement, Field 72 is populated with ClearPar trade ID even if one trade is having ClearPar trade ID though the ClearPar trade ID is blank for the remaining trades being settled
- It is expected that CLP trades under a ticket have a same ClearPar trade ID and this should be manually done.
- Currently TRS trades are getting booked from LQT similar to Par trades; swap deals does not have allocations to swap counterparties. Considering this, Clearpar trade ID is consumed from LQT for the trade contract involving TRS desk.
- There is no processing change for ClearPar trade ID and the existing trade processing (booking, amendment and settlement) functionality remains the same.

Auto Confirm Messages

- The 'Auto Confirm Messages' check box is selected by default. If required you can clear this check box. If the check box is selected, the records are populated in the automated settlement queue with the 'Confirmation Status' as 'Confirmed' when the validations are successful. If the validations are failed, then the records are populated in the automated settlement queue with the 'Confirmation Status' as 'Unconfirmed' even if the 'Auto Confirm Messages' check box is selected.
- If 'Auto Confirm Messages' check box is cleared, the records are populated in the automated settlement queue with the 'Confirmation Status' as 'Unconfirmed' irrespective of the failure or success of the validations. You should manually mark the confirmation status of the record as 'Confirmed' by unlocking the same in the automated settlement queue to proceed with automated settlement.

Automate Ticket Settlement

The 'Automate Ticket Settlement' check box is selected by default. If required you can clear this check box. If the new flag 'Automate Ticket Settlement' is selected, then the system automates the trade settlement process. The system processes only the effective 'Settlement Details Notice' (SDN) where the tag value is 'True' for the tag list 'is Effective' received from Markit. If the tag value is 'False', the system does not process the SDN message.

The other notices mentioned below which are received from Markit are not processed.

- Trade Match Notification
- Syndicated Loan Trade Allocation
- Trade Update Notification
- Trade Closed Notice.

If the 'Automate Ticket Settlement' check box is cleared, that is, system processes all the notices received from Markit mentioned above and you have to manually initiate trade settlement after the trade closed notice is received.

The system processes 'Combined Ticket Settlement' as part of automated settlement based on trade ID, allocation ID and multi CUSIP combination. Refer the below table for processing based on multiple CUSIPs

SDN Message	Markit / ClearPar Trade ID	Allocation ID	CUSIP	Consolidated Ticket Settlement Reference	OBCL Trade Reference
MSG01	TR1	TR1001	A	ABC	FC01
MSG01	TR1	TR1001	B	ABC	FC02
MSG01	TR1	TR1001	C	ABC	FC03
MSG02	TR2	TR1002	X	XYZ	FC04
MSG02	TR2	TR1002	Y	XYZ	FC05
MSG02	TR2	TR1002	Z	XYZ	FC06

If there are multiple CUSIPs present in the SDN message and the validations fails for one of the CUSIPs, the confirmation status is updated as 'Unconfirmed' only for the failed CUSIP. The confirmation status for the other valid records within the same SDN message is updated as 'Confirmed' but systematic settlement is not processed for the same. Refer the below table for the details on processing multiple CUSIPs within the same SDN message with respect to confirmation status.

Trade ID	Allocation ID	CUSIP	Consolidated Ticket Settlement Reference	Confirmation Status	Processing in OBCL	Threshold Validation	Error Message
'Auto Confirm Messages' check box not selected							
TR1	001	A	XYZ1	Unconfirmed	Settlement is not processed	Successful	N/A
TR1	001	B	XYZ1	Unconfirmed	Settlement is not processed	Failed	Error details of threshold validation
TR1	001	C	XYZ1	Unconfirmed	Settlement is not processed	Failed	Error details of trade price mismatch
'Auto Confirm Messages' - Check box selected							

TR1	001	A	XYZ1	Confirmed	Settlement is not processed	Successful	N/A
TR1	001	B	XYZ1	Unconfirmed	Settlement is not processed	Failed	Error details of threshold validation
TR1	001	C	XYZ1	Unconfirmed	Settlement is not processed	Failed	Error details of trade price mismatch
'Auto Confirm Messages' - Check box selected							
TR1	001	A	XYZ1	Confirmed	Settlement is processed	Successful	N/A
TR1	001	B	XYZ1	Confirmed	Settlement is processed	Successful	N/A
TR1	001	C	XYZ1	Confirmed	Settlement is processed	Successful	N/A

5.18.5 Auto Creation of New Mnemonics

- The system tries to match the incoming effective SDN with existing settlement instructions available in Corporate Lending as below.
 - Currency from the settlement detail notice.
 - Counterparty
 - MEI code from the settlement detail notice to MEI of the counterparty in Corporate Lending. The counterparty from trade reference is used to locate a matching SSI in Corporate Lending.
- The system validates the following fields even for NULL values.
 - Field 56
 - Field 57
 - Field 58
 - Field 59
 - Field 72

System tries to match the SDN field with the Corporate Lending fields in the below order of preference under two levels.

Level 1:

Order	Primary SDN Tag	Secondary SDN Tag	OBCL Field
1	<qfn:correspondentInformation>	<qfn:abaNumber>	F56 or F57
2	<qfn:correspondentInformation>	<qfn:swift>	F56 or F57
3	<qfn:intermediaryInformation>	<qfn:swift>	F56 or F57

Level 2:

Order	Primary SDN Tag	Secondary SDN Tag	OBCL Field
1	<qfn:beneficiaryInformation>	<qfn:accountNumber>	F58 or F59
2	<qfn:beneficiaryInformation>	<qfn:iban>	F58 or F59
3	<qfn:forFurtherCredit>		F58, F59, or F72

5.19 Specifying Adjustment Rate

Margin paid by the participant to the sub-participant may be less or more whichever is applicable to the tranche. It can have both positive and negative value.

The rate given in 'Secondary Loan Trading – Draft Trade (TLDTDUPL)' can be viewed in 'Trade-Online', 'Ticket Settlement', and 'Combined Ticket Settlement' screens.

5.20 Settling DCF on First-time

On the settlement of the first trade for a first-time buy, following events occur:

1. Self participant is added to the tranche through a Non pro-rata VAMI (NPVAMI).
2. NPVAMI is executed on the tranche to reduce the first time buy investor position to zero and to reduce the tranche amount to the trade amount.
3. NPVAMI on the tranche to reduce the first time buy happens only when the tranche amount is not zero and is equivalent to the first-time buy investor amount before the trade settlement is STPed.

Note

- If settlement of trade for the first-time buy is prior to some agency activity, like Pro-rata VAMI or Payment, then cascading of NPVAMI happens to the agency activity as well.
 - STP from agency for the first time buy investor is blocked.
-

Consider the following example:

A Tranche TR1 is created with 10M with first-time buy investor's participation as 100% on 01-Jan-2011.

Pro-rata VAMI is executed on TR1 for 5M on 15-Jan-2011.

Trade for the first-time buy with 8M is settled on 05-Jan-2011.

This trade results in the following sequence of actions

1. NPVAMI is executed for 8M through the settlement of trade for the first-time buy.
2. NPVAMI executes for 10M on the trade settlement date.
3. As part of cascade of NPVAMI, another NPVAMI for 5M happens for first-time buy participant on 15-Jan-2011.

The net result is that, TR1 remains with 8M as the tranche amount with 0% participation for first-time buy investor and 100% participation for the participant who is added through settlement of trade for the first time buy.

Note

If the 'Non-Prorata / PIK settlement' flag is selected during the trade / ticket settlement, and if the existing self participant is not having 100% share, the system restricts the user from proceeding with the settlement. This is as per the existing functionality irrespective of zero tranches and non-zero tranches.

5.21 Reversing Trade Settlement

You can reverse a trade settlement in the by clicking the reversal button in the 'Trade Settlement/Funding Memo Generation' screen.

During reversal either of the following actions takes place:

- If trade settlement has not happened, the funding memo generation gets reversed.
- If trade settlement has happened, both the funding memo and the trade settlement get reversed.

You can regenerate the funding memo and resettle the trade, once the trade settlement is reversed. You need to mandatorily re-generate funding memo before re-settlement.

The accounting entries passed during trade settlement get reversed when you do a reversal of the trade settlement. During trade settlement reversal, an override message gets displayed informing to reverse all the fees that were manually liquidated. No advices are generated during trade settlement reversal.

Note

If any agency activities have happened for the CUSIP after the trade settlement, you cannot reverse that settlement.

5.22 Reversing Trade

You can perform reversal of a trade by clicking the reversal button in the Trade Online screen.

During trade reversal either of the following actions takes place:

- If trade settlement has not happened, the trade cancellation event updates the unsettled position and the PnL created due to the current trade. Reversal of the trade happens subsequently.
- If trade settlement has happened, the trade cancellation event updates the unsettled position and the PnL created due to the current trade followed by settlement reversal and trade reversal events. Reversal of the trade happens subsequently.

No advices are generated during reversal of trade. You are not allowed to perform any activities on a trade, once it gets reversed.

5.23 Calculating Reserve

Reserve allocation or provisioning needs to be done for buy trades that have not been sold for a period that exceeds a pre-defined number of days. Reserve calculation preferences are captured in the 'Portfolio maintenance' screen. If the number of days up to which a buy deal remains un-sold exceeds the 'Reserve Days' specified, reserve calculation gets activated.

The following maintenances need to be done for the calculation of reserve:

- CUSIP Rating maintenance
- Mapping of the ratings from different sources
- Bid/Ask factor maintenance
- Age factor maintenance

For more details on these maintenances, refer the section 'Maintaining details specific to SLT module' in this user manual.

For each buy deal booked in SLT, Oracle Banking Corporate Lending checks if the difference between the current system date and the trade booking date exceeds the 'Reserve days'. If it exceeds, then the system computes the reserve as follows:

Reserve = Trade Amount * Bid/Ask Factor * Age Factor

FIFO logic is used to identify trades for which the reserve computation is applicable i.e, buy deals are set off against the sell deals that happen, if any, in a FIFO manner, so that only the remaining buy trades are applicable for reserve calculation.

Reserve calculation happens as part of the EOD batch. For calculating number of days, Calendar days are considered and not working days.

Accounting entries for reserve calculation are posted during month-end as part of RESV event. If the month-end happens to be a holiday, the entries are posted on the previous working date. But the computation will be done for the period including the month-end.

5.24 Reclassification

Reclassification is applicable for Normal and CLP trades. During trade booking, the system checks whether CUSIP exists in the agency module or not. If it does not exist, the trade is marked for reclassification ('Reclass Required' is marked as 'Y' internally). This validation and marking the trade for re-classification is done only during trade booking

- If the trade is marked for re-classification, the system uses the trade counterparty for posting the entries for any subsequent events on the trade, until active tranche is available in the agency module for the associated CUSIP.

- Once the tranche is created in the agency module for the associated CUSIP, the balance is re-classed during the EOD batch. The subsequent events always record the borrower of the Agency tranche as related customer while posting the accounting entries.

If the flag 'SLT Borrower Reclass Required' is checked in the 'Loans Parameter' screen and the tranche exists at the time of booking the trade, the system passes accounting entries with tranche borrower as related customer and there is not any reclassification in such cases.

5.24.1 **SLT Batch Process for Reclassification**

The SLT batch performs the accounting entry reclassification. The system selects the open and liquidated trade contracts that are marked for reclassification.

If the CUSIP for the selected trade exists in Agency and the tranche is active, the system picks up the accounting entries posted till today for the trades where related customer is different from borrower of tranche contract against the accounts where the UDF 'Trade Reclass Required' at the chart accounts is marked as 'Y' for reclassification in the 'Chart of Accounts' screen

- For each trade, re-classification reverses out the entries of each balance by flipping the Dr/Cr indicator.
- New set of entries are posted for each balance under the same trade with the event code as RCLC' (Re-class customer), the related customer as Tranche borrower and the value date as application date.
- Reclassification is done only for the ledger (GL) accounts and customer accounts are ignored.

Example

Debit account is customer account and Credit account is ledger account that is marked for reclassification, then Credit account alone is reclassified and Debit account is ignored

Note

Reclassification of trading balance is done only once during the life cycle of the trade.

If CUSIP is not available during trade booking, the trade is marked for reclassification. Once the CUSIP becomes available, the balance is reclassified during the same day EOD and subsequent entries are posted with related customer as tranche borrower.

- Any changes in the agency module due to which the CUSIP becomes unavailable after reclassification, the subsequent trading entries are posted with trade counterparty and no further reclass happens in such cases
- The changes are done only for related customer in trade accounting entry during reclassification.

If there is any problem during reclassification in the batch, the exception details are logged in an internal exception table and does not stop the batch program. The value of 'Reclass Required' remains as 'Y' (internally).

- The system re-pickups and processes the failed trades in the subsequent end of day batch until the re-class is successful.
- The value of 'Reclass Required' is marked as 'N' (internally) for all the trade contracts for which reclassification is processed successfully.

Note

- In case of trades being reversed after customer reclassification, the system reverses all the accounting entries fired for the trades including those entries fired for the 'RCLC' event as well
 - If any trade is marked for reclassification but reversed manually/due to trade amendments before reclassification where tranche exists during trade reversal, the TBOK/TAMD/TCNC entries exist with trade counterparty but the 'TCNC' entries due to trade reversal is posted with tranche borrower. This should be operationally controlled, if required.
 - Reversed trades are not picked for reclassification. If any trade is marked for reclassification but reversed before reclassification, 'Reclass Required' is marked as 'N' (internally) during reversal.
 - Similarly, reclassification is not done for settled trades. If any trade that is marked for reclassification but gets settled before creating tranche, 'Reclass Required' is marked as 'N' (internally) during such settlement.
 - If a trade is marked for reclassification, but settlement has happened after creating tranche in agency module, reclass happens for the 'TBOK/TAMD' entries for the settled trades during EOD. Subsequently if settlement/trade is reversed or CUSIP becomes unavailable, there is no further reclass performed for such trades.
-

5.25 Agency Confirmation

Agency confirmation is applicable only for trades where bank is the lead agent. The trade settlement details for all trades that have been saved in the Trade settlement or Ticket settlement screen get displayed in the 'Agency Confirmation' screen. The agency needs to confirm or reject each trade that appears in this screen.

Agency confirmation always happens at trade level and for ticket settlements, all trades under the ticket should be confirmed by the agency.

You can invoke the 'Agency Confirmation' screen by typing 'TLDAGCON' in the field at the top right corner of the Application tool bar and clicking on the adjoining arrow button.

You need to specify the following in this screen:

Ticket Id

Select the ticket Id for which you want to view the trades available for settlement confirmation.

Once you select the Ticket Id, all saved trades pending for settlement are displayed. The following details related to the trades are displayed:

- Contract reference number
- Amount
- Currency
- CUSIP
- Counterparty
- Trade settlement date
- Trade date
- Buy/Sell indicator
- Authorization status

Confirmation Status

Select the confirmation status as 'Confirm' to register agency confirmation for the trade or select 'Reject' to indicate that you want to reject the settlement for the trade.

The trade settlement gets deleted if the agency does not confirm a trade.

While authorizing trade settlement, the system checks if the trade is confirmed by the agency. If it is confirmed, trade settlement gets authorized. If it is not confirmed or if it is rejected, the system forces you to obtain agency confirmation before proceeding with the authorization.

On authorization of the trade settlement, the trade details are transferred to the agency which in turn initiates participant transfer events corresponding to the trade.

Note

- If deletion or reversal of the trade settlement happens after agency confirmation, you need to reconfirm the trade before the actual trade settlement.
 - Agency confirmation is not required for inter company deals which are not being handed off to agency
-

5.26 Amending an SLT Contract

You can amend the details of a trade contract in the 'Secondary Loan Trading - Draft Trade' screen. You need to select 'Modify' from the menu

You also need to select the contract reference number of the trade contract you want to modify.

Click 'Ok' to save the details and display the 'Secondary Loan Trading – Draft Trade (TLDTDUPL)' screen.

In this screen, you can make the necessary modifications to the contract details. You need to select Submit option to save the modifications and process the record further.

You can make amendments on a trade, only before the trade gets settled. For trade amendments that happen before trade settlement, if the funding memo is already generated, then the funding memo gets regenerated after the amendment.

For amendments being carried out in Loans QT, any of the following actions can happen in Oracle Banking Corporate Lending, based on the nature of the amendment:

- **Normal Trade Amendment (TAMD)** – this type of amendment is carried out if the amendments in Loans QT do not impact the position, WAC, PNL, or trade settlement
- **Cancellation of the existing position and booking new position (TCNC and TAMD)** – this type of amendment is carried out if the amendments in Loans QT impact the position, WAC, PNL or trade settlements, but with no changes to the Trade product, CUSIP, Ticket Id and Position Identifier
- **Cancellation (TCNC) and reversal of the existing trade and rebooking the trade (TREV and TBOK)** – this type of amendment is carried out if the amendments in Loans QT impact the position, WAC, PNL, trade settlements, Trade product, CUSIP, Ticket Id or Position Identifier

If the amendment details flow in from Loans QT after trade settlement you need to manually reverse the trade settlement and fee settlements and reprocess the trade amendment.

If the trade amount amendment in Loans QT happens due to commitment reduction/increase or PIK, the new trade amount gets saved as a new version of the trade contract.

The following table lists the fields that can be received as amendment from Loans QT and the corresponding action that takes place in Oracle Banking Corporate Lending:

OBCL Field	Corresponding Loans QT Field	Remarks	Amendment Allowed Through Draft Trade	OBCL Process
External Ref No	Tradel	Should come from LQT, However in the absence of the Interface, Users will key in the unique value	NO	Reverse the existing trade and rebook the new trade
Contract Ref No		Oracle Banking Corporate Lending Generated Ref No	NO	Reverse the existing trade and rebook the new trade
User Ref No		User Input Ref No in Oracle Banking Corporate Lending	NO	Reverse the existing trade and rebook the new trade
Custom Ref No		Populated in Oracle Banking Corporate Lending	NO	Reverse the existing trade and rebook the new trade
Version		Oracle Banking Corporate Lending Version		
Ticket ID	Ticketl		NO	Reverse the existing trade and rebook the new trade
Desk	DeskC		NO	Reverse the existing trade and rebook the new trade
Legal Vehicle	LegalVehicleI		NO	Reverse the existing trade and rebook the new trade
Expense Code	FirmAcctI	Expense Code	YES	Reverse the existing trade and rebook the new trade

OBCL Field	Corresponding Loans QT Field	Remarks	Amendment Allowed Through Draft Trade	OBCL Process
CUSIP	MIAlt/Loan-Deal		YES	Reverse the existing trade and rebook the new trade
Position identifier			YES	
Firm Account Mnemonic			YES	
Trade Product		Will be populated in Oracle Banking Corporate Lending	NO	Reverse the existing trade and rebook the new trade
Deal Type	DistributionC	Assignment/Participation	YES	Reverse the existing trade and rebook the new trade
Trade Type	TradeTypeC	CUST/ACCM	YES	Cancellation of existing position and Trade amendment if the trade amended from CUST to ACCM. It Reverse the existing trade and rebook the new trade in case amended from ACCM to CUST.
Buy Sell indicator	TransTypeC	Buy or Sell	YES	Cancellation of existing position and Trade amendment
Counterparty	CptyAcctI		YES	Trade Amendment
TradeAmount	ProductQty		YES	Trade Amendment
Trade Currency	SettleCurrC		YES	Cancellation of existing position and Trade amendment

OBCL Field	Corresponding Loans QT Field	Remarks	Amendment Allowed Through Draft Trade	OBCL Process
Trade Price	TradeProdPriceA		YES	Cancellation of existing position and Trade amendment
Booking Date		Oracle Banking Corporate Lending System Date	No	
Trade Date	TradeD		YES	Cancellation of existing position and Trade amendment
Expected Settlement Date	ExpectedSettleD		YES	Trade Amendment
Settlement Date		Oracle Banking Corporate Lending will update it on actual Settlement	No	Actual Settlement date to be keyed in only during the funding memo generation / Trade settlement
BrokerID	SalesID		YES	Trade Amendment
Broker Fee Rate		Rate will be accepted for Brokerage Fee and Line Accommodation Fees.	YES	Trade Amendment or Fee Amendment
Swap ID		Details of SWAP upload table is provided later	YES	Cancellation of existing position and Trade amendment
Fee Type	FeeTypeC	ASSN/LINE. One instance of each fee is allowed. DCF does not come from LQT and it is populated during Trade upload based on the Prod Maintenance	YES	Trade Amendment or Fee Amendment

OBCL Field	Corresponding Loans QT Field	Remarks	Amendment Allowed Through Draft Trade	OBCL Process
Assignment Fee Type	Assignment-FeeC		YES	Trade Amendment or Fee Amendment
Assignment Fee Remitter		Needs to come from LQT	YES	Trade Amendment
Fee Amount			YES	Trade Amendment or Fee Amendment
Agency ID			YES	Trade Amendment
Quotation	InterestC	FLAT/SWOA. No processing diff b/n FLAT & SWOA except for the DCF applicability	YES	Trade Amendment until expected settlement date
Settlement Mnemonic details			YES	Trade Amendment
Remarks	Comments		YES	Trade Amendment

The fields with 'Amendment Allowed Through Draft Trade' value specified as 'Yes' can be amended in the 'Draft Trade' screen. For the other fields, you need to reverse the trade and re-book a new trade.

Any amendment which results in the change of position/ PnL/ WAC reverses and rebook the trade and system triggers the following events:

- TCNC – to cancel the position of the current version of the trade
- TREV – to reverse the existing trade with current reference number
- TBOK – to book the same trade again (with modifications) and a new reference number with the revised fields

The steps for the amendment of CUSIP/ ISIN and 'Firm Account Mnemonic' are as follows:

- Cancellation of position
 - System calculates the total commitment reduction applied on the trade and this impact is negated by internal amendment
 - The total PIK amount applied on the trade is identified and its impact is negated by internal amendment
 - After this, system triggers the TCNC event to cancel the position
- Reversal of the trade
 - System triggers the TREV event to reverse the trade with the old reference number

- Rebook of the trade
 - System triggers the TBOK event to reverse the trade with the old reference number. The new trade is created with the amended fields
 - The commitment reduction amount and the PIK amount previously the applied on the trade is re-applied on the new trade by internal amendment

If the CUSIP/ISIN is changed as part of the amendment, then, system does not automatically trigger the reversal and rebook of trade as the commitment reduction and PIK details for the new CUSIP/ISIN are not available. Therefore, you should apply the commitment reduction and PIK on the new trade through manual amendment.

Note

- You can change multiple fields as part of one amendment.
 - Trade amendment is not allowed on the reversed trade after trade settlement.
-

The following fields are sent as the trade settlement acknowledgement message to Loans QT as a tilde (~) separated list:

Field	Description
TransType	Default value 'SETTLEMENT'
TransID	LQT Transaction ID
TransActionCode	Default value 'ORIG'
OrigSys	Default value 'Oracle Banking Corporate Lending'
DestSys	Default value 'LQT'
Ticket	LQT Ticket ID
SettledDate	Actual settlement Date
UserID	User ID who settled the trade
UserSettledTimeStamp	Actual settlement Date & Timestamp
FlexSettledFlag	Default value 'P'
TradeID	LQT Trade ID
CUSIP	Internal CUSIP
FundMnemonic	LQT Counterparty mnemonic

5.26.1 Amending of CUSIP/ISIN and Firm Account Mnemonic

When a new trade reference number is created as part of the TBOK event, system does not consider the commitment reduction and PIK amount of the previous version and the new trade is booked with original trade amount. Hence, during CUSIP/ISIN amendment from Loans QT, system validates incoming trade amount with the original trade amount. If these two amounts do not match, system does not process that amendment and the process status is marked as

'Failed' in the Loans QT trade browser. You should manually mark this version of amendment as 'Processed' in the Loans QT trade browser and send the next version of amendment from Loans QT with the correct trade amount for successful processing.

On successful upload of the amendment from Loan QT, the latest version in the 'Draft Trade' screen displays the original trade amount as the trade amount and the commitment reduction and PIK amount as zero.

If the reason for CUSIP/ISIN amendment from loans QT is not 'ChangeCusipAfterCmtRed' and the box 'Amount change allowed during CUSIP\ISIN Amendment' is checked in the 'Loans Parameters' screen, the validation that the trade amount field of the previous CUSIP and New CUSIP should be same will be relaxed.

In such cases, the system proceeds with the CUSIP/ISIN amendment without any failure, even though there is a trade amount mismatch between the previous and new CUSIP/ISIN.

Note

If the CUSIP/ISIN amendment with different amount is received from LoansQT on a trade which is already having commitment reduction/PIK and the amendment reason is not 'ChangeCusipAfterCmtRed', the system does not process that amendment and the process status is marked as 'Failed'.

However, if you change CUSIP from the 'Draft Trade' screen, system displays an override and changes the trade amount to the original trade amount. In addition, the existing commitment reduction & PIK amount is changed to zero.

In this case, the original trade amount is computed as follows:

- Original Trade Amount = Previous Trade Amount – Commitment Reduction Amount – PIK Amount

If the box 'Apply Cmt Redn/PIK for CUSIP Amendment' is unchecked in the 'Draft Trade' screen and the box 'Amount change allowed during CUSIP\ISIN Amendment' is checked in the 'Loans Parameters' screen, the validation that trade amount should remain unchanged during CUSIP/ISIN amendment is relaxed.

In such cases, the system proceeds with the CUSIP/ISIN amendment without any failure and accepts a trade amount different than the amount in the previous version.

If the amendment reason from LQT is 'ChangeCusipAfterCmtRed', then system carry forwards the commitment reductions and PIK amount to the new trade. LQT sends this reason only during CUSIP amendment for which commitment reduction has already been applied for the trade.

If the new CUSIP does not exist in the agency, then the commitment reduction/PIK is not applied for the new trade even though the amendment reason from LQT is 'ChangeCusipAfterCmtRed'. In addition, the 'Apply Cmt Redn/PIK for CUSIP Amendment' box will be unchecked in the 'Draft Trade' and 'Trade Online' screens.

If the new CUSIP exists in agency, then system validates whether the following details between the old and new CUSIP are the same:

- The net commitment reduction amount
- The average commitment reduction price
- Net PIK amount
- The average PIK price

If any one of the above validation fails, then system does not process the trade amendment and marks the trade as 'Failed' in the Loans QT trade browser. However, if the above validations are successful, then system reverses the existing trade and rebooks a new trade by changing the CUSIP.

System always takes the processed commitment reduction/PIK amount from agency for the old and new CUSIPs and arrives at the net commitment reduction amount/PIK by summing it all. System takes the participant share for each commitment reduction/PIK and arrives at the net commitment reduction/PIK amount. Similarly, system also computes the average reduction price by taking the commitment reduction/PIK price for the old and new CUSIPs from the processed handoffs to LQT and compares the arrived average prices.

System does not process CUSIP amendment from Loans QT if commitment reduction or PIK does not exist for the old trade, though the reason code is valid. The trade is as 'Failed' in the Loans QT trade browser. If any trade with CUSIP amendment fails, then you can manually correct the required details to match the validations and reprocess the amendment.

Commitment Reduction/PIK is re-applied from old trade to the new trade based on the following steps:

- Cancellation of existing position
 - System identifies the total commitment reductions applied on the trade and negates the impact by internal amendment. Each commitment reduction can be associated with a different commitment reduction price. Hence, the net commitment reduction amount is considered at an average commitment reduction price for such cancellations.
 - The total PIK amount applied on the trade is identified and its impact is negated by internal amendment.
 - Once these two processes are completed, system triggers TCNC event to cancel the position.
- Reversing the existing trade
 - System triggers the TREV event to reverse the existing trade.
- Rebooking a new trade
 - System triggers the TBOK event to book the trade with the new reference number. The new trade created have the changes only in the CUSIP/Buy-Sell indicator
 - The commitment reduction and PIK amount applied to the old trade is re-applied on the new trade by internal amendment

The above validations are based on the commitment reduction/PIK in the agency for the old and new CUSIPs where as the application of commitment reduction/PIK to the new trade in SLT is based on the commitment reduction/PIK amount of the old SLT trade.

This above process is also followed during manual amendment in 'Draft Trade screen' if:

- 'Apply Cmt Redn/PIK for CUSIP Amendment' box is checked' for CUSIP amendment

Trade amendment is for changing the Buy/Sell indicator.

Note

Within a CUSIP, only one expense code can be used for a portfolio.

Any amendment to the firm account mnemonic through LQT upload may result in change of expense code, portfolio, position identifier, and so on. When the firm account mnemonic is amended through LQT upload, the expense code, portfolio, position identifier, and so on are

resolved and the respective values as per the changed firm account mnemonic are displayed in the latest version of the trade.

You can change the firm account mnemonic in the 'Draft Upload' screen by selecting a value from the adjoining option list, which displays only the firm account mnemonics linked to the selected expense code. While amending the expense code, if there is only one firm account mnemonic linked to it, then system defaults that firm account mnemonic. However, if multiple firm account mnemonics are linked, system gives an override message to select the appropriate firm account mnemonic. Also, the draft trade is not processed if the firm account mnemonic is not selected.

5.26.1.1 Amending Buy/Sell Indicator during Loans QT Upload

Any amendment of a trade from Sell to Buy or vice versa results in a PNL/WAC change. Therefore, system reverses the existing trade and books a new trade by changing the Buy/Sell indicator.

System triggers the following events while amending CUSIP/Buy-Sell indicator:

- TCNC - Cancelling existing positions
- TREV - Reversing existing trade
- TBOK -Rebook a trade with the new Buy/Sell

This process is applicable even when you manually amend the Buy/Sell indicator in the 'Draft Trade' screen. Since amendment of the Buy/Sell indicator is stand-alone, system does not amend other trade details along with the Buy/Sell indicator amendment. This is applicable for both Loans QT and manual trade amendment.

Note

You must amend only the buy-sell indicator. However, if you try to amend other details along with the buy-sell indicator, then the trade fails on save.

5.26.1.2 Amending Rejected Trades from Loans QT

You can successfully amend the previous latest version of the trade rejected in the Loans QT from the Loans QT trade browser when the trade is still in active status. However, no amendment is allowed for reversed and settled trades.

5.26.1.3 Amending Financial Centre Holiday Treatment

Financial center maintained at product level is defaulted in 'Secondary Loan Trading – Draft Trade' (TLDTDUPL) screen. If required, you can add or remove the financial center.

5.27 Processing Silent Participation

There are two possible ways in which a trade deal can be carried out. Assignment deals where bank is directly involved in the trade and silent participation deals where bank is not directly involved in a trade deal. In participation deals, bank silently participates in the trade deal.

Participations can belong to either of the following two types:

- Sell participation where bank sells the participation to a counterparty. In this case, bank represents the counterparty in the agency and all the activities for the counterparty flows through bank.

- Buy participation where bank buys the participation from a counterparty. Here the counterparty represents bank in the agency and carries out all the activities on behalf of bank.

Deals involving a silent participant also flow in from SLT like other normal buy/sell deals with the only difference being in the deal type, which changes to 'Participation'. In the LB module, the detail of each silent participant is captured and a corresponding participant contract is created.

This section contains the following topics:

- [Section 5.27.1, "Processing Sell Participation"](#)
- [Section 5.27.2, "Processing Buy Participation"](#)

5.27.1 Processing Sell Participation

The following example illustrates how sell participation deals are handled in SLT.

Example

Let us assume a tranche contract of \$1bn. Let there be a drawdown of 200mn.

Let the participant contributions for the tranche and drawdown be as follows:

Participant Contributions:

Participant	Participant %	Tranche Amount	Drawdown Amount
Desk1	20%	200mn	400T
Desk2	30%	300mn	600T
External Participant	50%	500mn	1mn

Assume that bank makes sell deals to three silent participants as shown below:

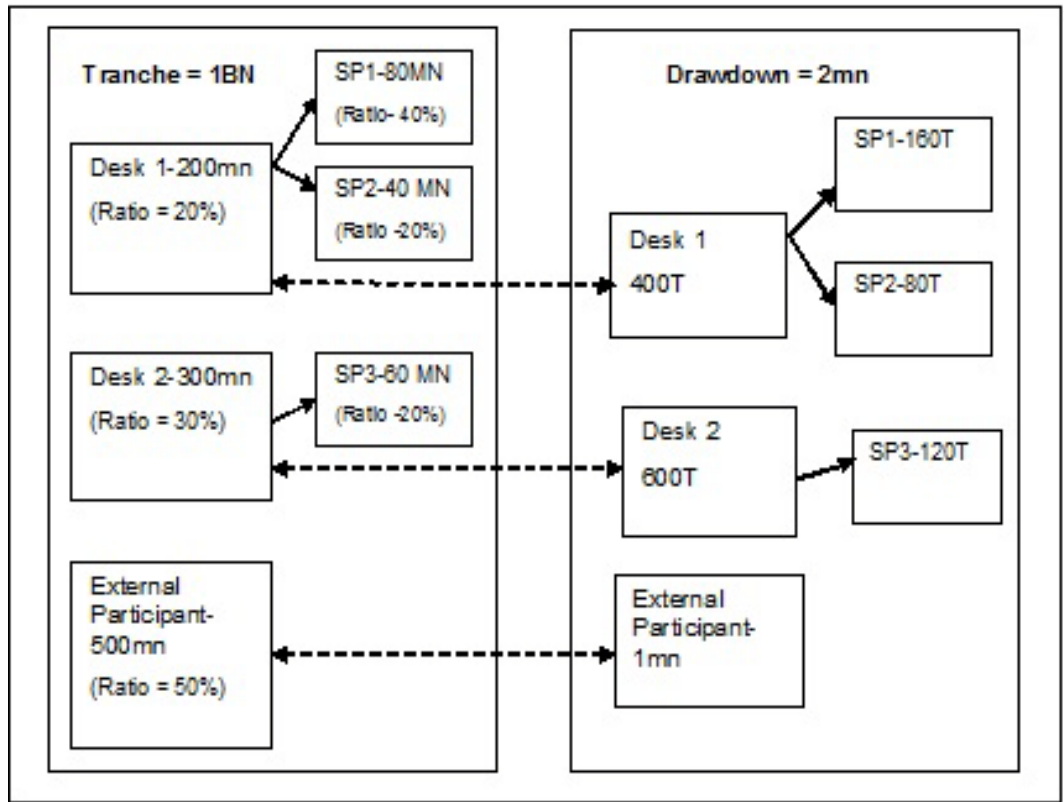

This silent sell deals get reflected in the LB module as follows:

Participant	Participation %	Tranche Amount	Drawdown Amount
Desk1	8%	80mn	160T
SP1	8%	80mn	160T
SP2	4%	40mn	80T
Desk2	24%	240mn	480T
SP3	6%	60mn	120T
External Participant	50%	500mn	1mn

Assuming that bank is the agent, the counterparties SP1, SP2, and SP3 are added as participants in the contract with 'silent participant' tags. Settlements from the agent to the silent participants are handled in the same way as handling normal participants.

5.27.1.1 Elevating Sell Participation - Bank as Lead agent

Elevation is the process where a silent participant becomes a normal participant in a trade with the agency. The following steps are involved in the elevation of a silent sell participant to normal status:

1. Loans QT send the trade amendment for elevation from 'Participation' to 'Assignment'.

2. The system considers this amendment as an exception and initiates the trade cancellation event, to cancel the participation positions.
3. Amendment of the trade happens for changing the deal type, followed by the elevation event which marks the elevation of the trade. If the bank as Lead agent, the trade elevation event for the origination line trade is handed off to LB module.
4. The system, internally, books assignment type of sell deals with the counterparties involved. Funding memo or trade settlements are not applicable for such trades.

You cannot perform any further operations on these trades.

If the bank is Lead agent, as part of agency handoff, the Silent participant position is reduced to the extent of the sell Participation amount and actual external party are added to the main agency contract. PRAM is triggered to indicate the participant transfer between the silent participant and the actual external participant.

If the bank is non - lead agent, on elevation of Participation trade, a negative NPVAMI will be triggered on non - lead agency wrapper contract to the extent of the participant position and the participant pro-rata share are changed.

5.27.2 Processing Buy Participation

The processing of participation buy deals can be illustrated as follows:

Example continued

Continuing on the previous example, let us assume that bank buys participation from the external participants as shown below:

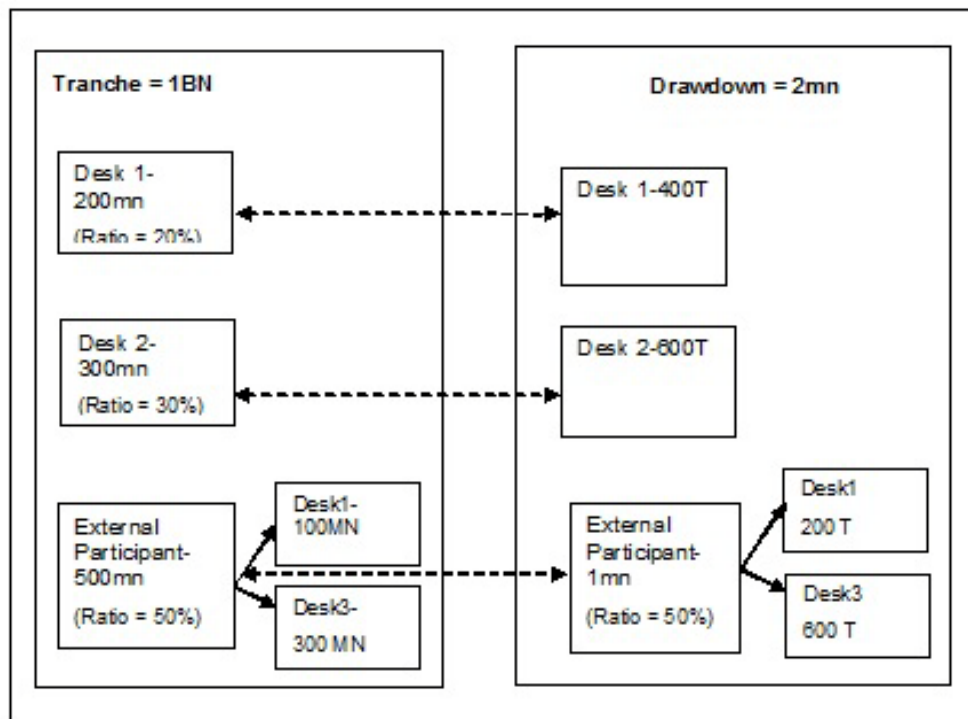

The SLT position and the agency activities need to be tracked independently for the normal participation and silent participation.

In the LB module the normal and silent participations are handles as follows:

Normal participation: Tranche 1, Drawdown 1

Participant	Participation %	Tranche Amount	Drawdown Amount
Desk1	20%	200mn	400T
Desk2	30%	300mn	600T
External Participant	50%	500mn	1mn

Silent Participation for Desk1 and Desk3: Tranche2, Drawdown 2

Participant	Participation %	Tranche Amount	Drawdown Amount
Desk1	25%	100mn	200T
Desk3	75%	300mn	600T

Two sets of LB transactions take place, in this case, as given below:

- Initial transaction with Desk1, Desk2, and External Participant as the participants where bank is the lead agent. Any settlement from the borrower gets propagated to Desk1, Desk2 and External Participant, in this case.
- In the second transaction, Desk1 and Desk 3 are the participants and bank acts as the dummy lead. All borrower side settlements happen from the External Party who represents Desk1 and Desk3 (silent participants) in the initial agency transaction.

5.27.2.1 Elevating Buy Participation

The following steps are involved in the elevation of a silent buy participant to normal status:

1. Loans QT send the trade amendment for elevation from 'Participation' to 'Assignment'.
2. The system considers this amendment as an exception and initiates the trade cancellation event, to cancel the participation positions.
3. Amendment of the trade happens for changing the deal type, followed by the elevation event which marks the elevation of the trade.
4. The system, internally, books assignment type of buy deals with the counterparties involved. Funding memo or trade settlements will not be applicable for such trades.

You cannot perform any further operations on these trades.

If bank buys participation from different counterparties, you need to create separate LB contracts (tranche/drawdown) for all counterparties representing bank participation. Any agency activity involved with the borrower needs to be performed for each of these LB contracts separately.

Multiple tranches can be created with the same CUSIP to support this activity. But there can be only one tranche for each CUSIP and settlement party combination.

5.28 Processing Swap Deals

A swap is an agreement between two parties to exchange sequences of cash flows for a set period of time. Total return swap is a swap agreement in which one party makes payments based on a set rate, either fixed or variable, while the other party makes payments based on the return of an underlying asset, which includes both the income it generates and any capital gains.

The following diagram illustrates the booking of a swap contract in SLT:

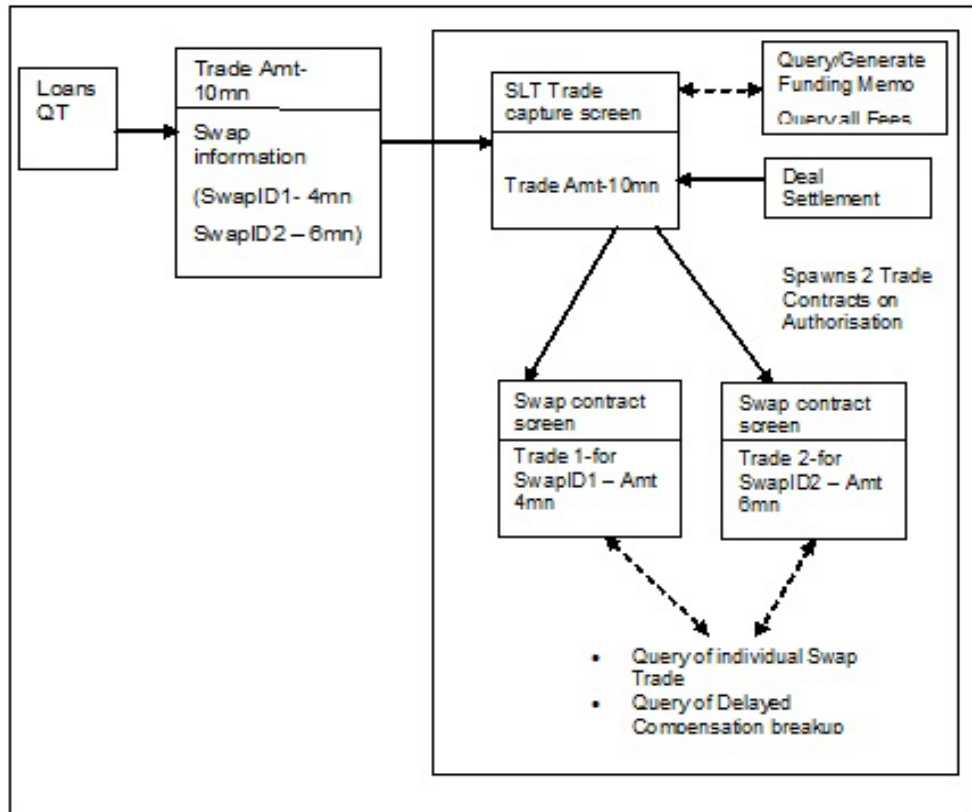

You can capture the trade details for swap trade also in the 'Draft Trade' screen, like normal trade deals. The Swap details for the trade can be captured in the 'Draft Swap Details' screen, which can be invoked by clicking 'Swap' in the Draft Trade screen.

The following details related to the trade contract are defaulted in this screen:

- Contract reference number and user reference number
- Branch, desk and expense code
- Portfolio details
- CUSIP
- Ticket Id

You can specify the following details in this screen:

Swap Id

Specify the Swap Id to be used to generate the swap contract.

Swap Counterparty

Specify the counterparty associated with the swap trade being performed.

Amount

Specify the amount associated with the swap trade.

The sum of the amounts allocated for all swap trades should be equal to the total trade amount.

Oasys Id

For swap trades originating in Loans QT, Oasys Id associated with the trade gets uploaded from Loans QT. For swap trades that are being captured in SLT, you need to specify the Oasys Id to be associated with the trade.

Swap Reference No.

The system automatically creates contracts for the Swap Ids specified here. The contract reference numbers of these swap level contracts get displayed here.

Like normal contracts, you can view the swap trade contract details also in the 'Trade Online' screen.

You can only view the details of the swap contract in this screen. The Parent reference number in this screen refers to the parent trade contract associated with this swap contract. System also defaults the Markit details (Trade Id and Allocation Id) in this screen.

During upload of data from Loans QT, the system checks if the corresponding desk is a Swap desk. If the desk is of 'Swap' type then during booking as well as amendment of the contract, either the complete swap details need to be sent or no swap details should be sent. You cannot send the swap details partially.

If no swap details are sent initially, the system uses 'UNIDENTIFIED' as the default swap Id with 100% allocation and tracks the position under this swap Id. The actual swap contracts are created under the parent trade, when the allocation details are sent by Loans QT.

The processing of swap trade contracts is carried out in a similar way as normal trades, except that most of the activities are performed at the parent trade contract level. The corresponding accounting entries are passed on, appropriately, to the swap contracts involved. All accounting entries corresponding to swap trades are posted at the swap Id level.

The major changes in the processing of swap trade deals are listed below:

- You can amend the swap details, if required, before the trade is settled. But the amendment is possible only for the parent contract and not for the swap contracts. A pro-rata share of the trade amendment is passed on to the swap contracts based on the swap allocation.
- The system maintains the unsettled position for a combination of branch, desk, expense code and swap Id, when a swap trade is booked. On trade settlement or during trade amendments for the parent contract, the settled and unsettled positions are updated for each swap contract under the parent contract.
- While calculating realized PnL during the booking of a trade, the PnL entries are posted for each swap contract associated with the parent contract.
- Funding memo generation, as part of trade settlement, can happen only at the parent trade contract level.
- The settlement for the swap deals are handled at the parent trade contract level, as in the case of normal trade deals. The actual settlement entries are passed for each swap contract and the settlement amount is arrived at by apportioning the trade settlement

amount according to the swap allocation. Payment messages are not generated for swap trades.

- Fees applicable for normal trades are applicable for swap trades also. The fee amount at trade level gets apportioned to individual swap level contracts based on the swap allocation. You cannot amend the fee details for individual swap contracts.

For swap deals, each combination of branch, desk, expense code, and swap Id is represented as a participant in Oracle Banking Corporate Lending. If the 'Auto-generate Position Identifier' option is enabled for the portfolio, position identifier is automatically generated for every instance of swap Id and portfolio combination, during upload of swap trade details.

5.28.1 Exchanging Information between SLT and LB modules

During settlement of the trade in SLT module, the details are handed-off to the LB module. In the LB module, any of the following processing can happen, depending on the availability of the swap details in LB:

- If no participant contract exists for the branch, desk, expense code, and swap Id combination then a new participant contract needs to be created before processing the trade handoff
- If a participant contract already exists for the branch, desk, expense code, and swap Id combination then a VAMI (Value dated amendment) is triggered in the LB module if bank is involved in a non-lead role. If bank is involved in a lead role, corresponding participant transfer is initiated.
- If the CUSIP does not exist in the LB module, you need to manually capture the CUSIP details in the LB module with each swap Id being represented as participants.

Note

For each combination of branch, desk, expense code, and swap Id, you need to maintain an asset in the Loans module.

5.29 Forward Processing of Events

You can view the details of contracts marked for forward processing through the 'Payment Browser' screen. You can invoke the 'Payment Browser' screen by typing 'LBDFWDPR' in the field at the top right corner of the Application tool bar and clicking on the adjoining arrow button.

Note

To carry out forward processing on an event, you have to select the Rollover Mode, Liquidation Mode and Initiation Mode as 'Semi-Auto' for tranche and drawdown. Similarly, for forward processing of fee components, the fee liquidation mode should be 'Semi-Auto' (in the 'Fee Components' sub-screen of the 'LB Tranche Contract Online' screen and the 'Drawdown Contract Online' screen). The processing for the events ROLL, LIQD, INIT, and FLIQ are processed semi-automatically.

Click the 'View' button to view the message that is sent out.

The system sends out a message depending on when the confirmation received from you. This is explained in the example given below:

Example

The following are the details of a contract booked:

Booking Date - 1st July 2005

Value Date – 5th July 2005

Currency – USD

Settlement Days – 2 days

If you confirm on the 1st or 2nd of July that the message needs to be generated, the message is sent on the 3rd of July (BOD).

If you confirm on the 3rd, 4th or 5th of July that the message needs to be generated, the message is released from the 'Outgoing Message Browser' immediately.

If you do not confirm before the 5th of July EOD that the message needs to be generated, the accounting entries are passed for the event, and the message is held in the Outgoing Message Browser.

This section contains the following topics:

- [Section 5.29.1, "Fetching the Contracts for Forward Processing"](#)
- [Section 5.29.2, "Confirming the Generation of Messages for an Event"](#)
- [Section 5.29.3, "Processing Contracts For Secondary Loan Trading"](#)

5.29.1 Fetching the Contracts for Forward Processing

In this screen, you can filter the contracts required for forward processing based on the following parameters:

Date Range

The 'From and 'To' dates consider Archive days and Limit days for forward processing. These dates will be automatically calculated by the system based on the application date considering the 'Limit Days' and 'Archive Days' maintained as part of branch parameters (in the 'Syndication Loans and Commitments – Branch Parameters' screen).

For more details on maintaining branch parameters, refer the heading titled 'Indicating branch parameters for loan syndication' in the 'Reference Information for Loan Syndication' chapter of this User Manual.

Processed Status

You can also filter the required contracts based on a processing status of the contracts. The available options are:

- All: If you select this option, system filters all the contracts, irrespective of the processing status.
- Processed: This option filters only those contracts that are already processed. For such contracts, the messages are released into the 'Outgoing Message Browser'.
- Partial Processed: Applicable if there are pending components for the contract (not all the components of a specific type – For example, fee, interest, tax - are processed). For instance, a contract may have four fee components associated with it and only two of them may be processed. In this case, the contract is said to be partially processed.
- Not Processed: This option displays only those contracts that are yet to be processed.

In Payment Browser Summary (LBSFWDPR) screen, after specifying the filter criteria, click the 'Refresh' from menu to fetch the contracts.

The following details will be displayed in the screen:

- Name of the borrower
- Description of the event to be processed
- User Reference Number of the contract
- Contract Currency
- Amount and Value Date
- Contract Reference Number
- Counterparty
- Event Code

- Process Status: Not, Partial, Full

5.29.2 Confirming the Generation of Messages for an Event

From the filtered contracts, you have to select the contracts that need to be processed. To do this, check the 'Confirmed to Auto' option against the respective events. This confirms that the messages for the selected events under the contract should be generated on the schedule date. However, the system does not automatically generate the messages on the schedule date. You have to manually confirm the events to generate the messages in the 'Outgoing Message Browser'.

In the Payment Browser Summary (LBSFWDPR) screen, when you double-click the contracts the screen 'Message Generated for the Event' is displayed.

Click the 'Save' from the menu of the screen to confirm that the messages should be generated. When you save the details, the 'Confirm' option (in the screen above) is automatically checked.

Click the 'Ok' button to proceed. The messages associated with the event is released into the 'Outgoing Message Browser' and the 'Hold' status is set to 'N' (No). This indicates that the messages have been released successfully and are no longer on hold.

For more details on the 'Outgoing Message Browser', refer the 'Processing Outgoing Messages' chapter of the MS (Messaging System) User Manual.

5.29.3 Processing Contracts For Secondary Loan Trading

If you have selected the 'Payment Browser' preference as part of the preferences for the branch for secondary loan trading (in the 'Secondary Loan Trading – Branch Parameters')

screen), then the system processes the payments meant for trading through the 'Payment Browser' screen. The payments that are processed through this browser are:

- Buy Trade payments
- Pay/Rec liquidation (applicable only for Lender of Record type of Trades)
- Fees on Trade 'Sells' for unfunded commitment.
- Rebooked trades due to reversal and rebooking of trades after settlement
- Transfer fees payable to Agents and Counterparties (where the transfer fee currency is different from the settlement currency)
- Buy Trade payments, Pay/Rec liquidation, fees on Trade Sells and transfer fees for agents and counterparties settled as part of EOD

The system displays details of a trade/ticket settlement or pay/rec liquidation only if authorization has been done. In case of a trade/ticket settlement, the system displays the reference number of the respective trade or ticket. In case of a multi-customer multi-currency trade, the system displays the respective sub-ticket.

For Pay/Rec liquidation, the system displays the reference number of the Funds Transfer contract that has been created for the liquidation.

If a reversal or rebooking is done after the trade (or ticket) settlement, the new message is displayed in the Payment Browser.

As part of the settlement reversal authorisation, the message generated as part of settlement is 'Cancelled' if it is not handed off. In addition, system does not generate any message during settlement reversal. If the message for the settlement is handed off, the system allows settlement reversal.

5.30 SLT Processing for LMA / LSTA Participation

1. The LQT upload processing is enhanced with the existing LQT feed for 'Doc Type'.
2. The LQT feed contains the below values for 'Doc Type'
 - LMA
 - LSTA
 - Non-Standard
3. The value consumed from the LQT feed is displayed in the 'Trade Standard' field in the 'Draft Trade Input' and 'Trade Online' screens as follows
 - If the field 'Doc Type' has the value as LMA, it is displayed as 'LMA'
 - If the field 'Doc Type' has the value as LSTA, it is displayed as 'LSTA'
 - If the field 'Doc Type' has the value as Non-Standard, it is displayed as 'Non-Standard'.

Note

Value from the LQT feed is taken as it is in the 'Draft Trade' screen. There is no validation to check the value of the 'LMA / LSTA Participation' check box at the LT product level or whether the trade is sell and participation.

4. Similarly, the 'Doc Type' field in the 'LQT Trade Browser' screen displays the values as 'LMA' / 'LSTA' / 'Non-Standard' based on the LQT feed.
5. When an amendment for the field 'Doc Type' is received from LQT, OBCL systematically reverses and rebooks the trade contract.

6. During LT-LS upload processing, the system processes the below (only for the sell and participation trades).

Note

No changes are envisaged in the LT processing of buy and participation trades as well as buy / sell and assignment trades and the same continues to work

- a. If the trade received from LQT has the value 'LMA' or 'LSTA' in the field 'Doc type', 'Sell' for 'Buy/Sell Indicator' and 'Participation' in the 'Deal Type' and the 'LMA / LSTA Participation' check box is selected at the LT product level, the system checks if the external participant is available in the 'Portfolio Maintenance' and 'Position Identifier Maintenance' screens and do the below processing. For all other items (non-standard, buys and assignment type activity), portfolio does not systematically created.
- i If the external participant is not available in both the maintenance screens mentioned above, then OBCL systematically uploads the external participant details in both the maintenance screens with the 'LMA / LSTA Participation' check box as selected
 - ii If the external participant is available in both or any of the maintenance screens mentioned above with the value of the new field 'LMA / LSTA Participation' as unchecked, then LT-LS handoff is failed with appropriate error message.
 - iii An external participant is added in the corresponding LS tranche and drawdown contracts once the trade is settled.
 - iv The value of the 'LMA / LSTA' Participation' check box is propagated from the trade standard value in the newly added external participant in the LS tranche and drawdown contracts with the 'Self Participant' check box selected.
- b. If the trade received from LQT has the value 'Non-Standard' in the field 'Doc type' or , 'Buy' for 'Buy/Sell Indicator' or 'Assignment' in the 'Deal Type' and the 'LMA / LSTA Participation' check box is selected at the LT product level or the field 'Doc type' has the value 'LMA' or 'LSTA' and the 'LMA / LSTA Participation' check box is cleared at the LT product level, system does the below processing.
- i The system does not populate the 'Portfolio Maintenance' and 'Position Identifier Maintenance' screens.
 - ii An external participant is added in the corresponding LS tranche and drawdown contracts once the trade is settled for non-standard participation. There is no LS update for external participant on buy participation or any assignment settlement,
 - iii The value of the 'Trade Standard' is propagated as 'Non-Standard' to the 'LMA / LSTA Participation' in the newly added external participant in the LS tranche and drawdown contracts with the 'Self Participant' check box unchecked.

Note

In the above scenario, if the external participant is available in both or any of the maintenance screens with the value of the 'LMA / LSTA Participation' as unchecked / checked, then system does not fail the LT-LS handoff.

4. An external participant have the same value for the field 'LMA Participation' or 'LSTA Participation' under one CUSIP. If two trades are received from LQT for same CUSIP with different values in the field 'Doc Type', the value of the first trade getting settled (as part of trade/ticket settlement) is defaulted in the external participant.

Refer the below example for the processing of trades with the LQT feed as LMA / Non-Standard for different trades under same CUSIP and same external participant.

Scenarios	Doc Type' for Trade 1 in LQT Feed for the external participant EP1 and CUSIP1	Trade 1 Settled ?	LT Product - LMA/LSTA Participation flag after Trade 1	Doc Type' for Trade 2 in LQT Feed for the same external participant EP1 and CUSIP1	Result
Scenario 1	LMA	Yes	Checked	Non-Standard	LT - LS handoff happens after Trade 1 settlement. EP1 is added in the tranche with flag as LMA and EP1 is auto populated in position & portfolio tables. After Trade 2 settlement, EP1 flag value at tranche / position / portfolio table are not be changed. Only the position is increased in the tranche. At the tranche level, the EP1 have the value as LMA
Scenario 2	LMA	Yes	Unchecked	LMA	LT - LS handoff happens after Trade 1 settlement. EP1 is added in the tranche with flag as LMA and EP1 is auto populated in position & portfolio tables. After Trade 2 settlement, EP1 flag value at tranche / position / portfolio table is not changed. Only the position is increased in the tranche. At the tranche level, the EP1 have the value as LMA
Scenario 3	LMA	No	Unchecked	LMA	LT - LS handoff happens after the settlement of Trade 1 / Trade 2. EP1 is added in the tranche with flag as Non-Standard but EP1 is not auto populated in position and portfolio tables.

Scenario 4	LMA	No	Checked	Non-Standard	<p>Trade Standard of the trade which gets settled first, is propagated to the counterparty at the tranche level. If trade 1 gets settled first, LT - LS handoff happens after Trade 1 settlement. EP1 is added in the tranche with flag as LMA and EP1 is auto populated in position and portfolio tables. After Trade 2 settlement, EP1 flag value at tranche / position / portfolio table will not be changed. Only the position is increased in the tranche. At the tranche level, the EP1 have the value as LMA.</p> <p>If trade 2 gets settled first, LT - LS handoff happens after the settlement of Trade 2. EP1 is added in the tranche with flag as Non-Standard but EP1 is not auto populated in position and portfolio tables.</p>
Scenario 5	Non-Standard	No	Unchecked	LMA	<p>LT - LS handoff happens after the settlement of Trade 1 / Trade 2. EP1 is added in the tranche with flag as Non-Standard but EP1 is not auto populated in position and portfolio tables.</p>
Scenario 6	Non-Standard	Yes	Checked	LMA	<p>LT - LS handoff happens after Trade 1 settlement. EP1 is added in the tranche with flag as Non-Standard. EP1 is not auto populated in position and portfolio tables. After Trade 2 settlement, EP1 flag value is not changed. Only the position is increased. At the tranche level, the external participant have the value as Non-Standard.</p>
Scenario 7	Non-Standard	Yes	Unchecked	LMA	<p>LT - LS handoff happens after Trade 1 settlement. EP1 is added in the tranche with flag as Non-Standard. EP1 is not auto populated in position & portfolio tables. After Trade 2 settlement, EP1 flag value is not changed. Only the position is increased. At the tranche level, the external participant have the value as Non-Standard.</p>

Scenario 8	Non-Standard	Yes	Unchecked	Non-Standard	LT - LS handoff happens after Trade 1 settlement. EP1 is added in the tranche with flag as Non-Standard. EP1 is not auto populated in position & portfolio tables. After Trade 2 settlement, EP1 flag value is not changed. Only the position is increased. At the tranche level, the external participant have the value as Non-Standard.
Scenario 9	Non-Standard	No	Checked	LMA	Trade Standard of the trade which gets settled first, is propagated to the counterparty at the tranche level. If trade 2 gets settled first, LT - LS handoff happens after Trade 1 settlement. EP1 is added in the tranche with flag as LMA and EP1 is auto populated in position & portfolio tables. After Trade 2 settlement, EP1 flag value at tranche / position / portfolio table is not changed. Only the position is be increased in the tranche. At the tranche level, the EP1 have the value as LMA. If trade 1 gets settled first, LT - LS handoff happens after the settlement of Trade 2. EP1 is added in the tranche with flag as Non-Standard but EP1 is not auto populated in position & portfolio tables.

Note

It is assumed that the LMA/LSTA Participation check box at the LT product is selected in all the scenarios before the LQT feed for Trade 1 is received.

It is also assumed that the 'Deal Type' is 'Participation' and the 'Buy/Sell Indicator' is 'Sell' for all the trades mentioned in the above scenarios. For assignment / buy trades, LMA / LSTA propagation to LS and auto-population in portfolio / position maintenance does not happen

1. If a trade is processed with the 'Trade Standard' value as 'LMA' / 'LSTA' and before LT - LS handoff, if the record status of either 'Portfolio Maintenance' or 'Position Identifier Maintenance' or both is closed then LT-LS upload processing is failed and exception is logged advising that the respective maintenance is closed.
2. If a trade is received with the 'Doc Type' value as 'LMA' and before it is settled, the 'LMA/ LSTA Participation' is not selected at the LT product level and an amendment is received for the trade to change the 'Doc Type' value as 'LSTA', system reverses and rebook the trade. The trade standard value is 'Non-Standard' since the check box is not selected at

the product level and the external participant is added in the tranche with the field value as 'Non-Standard'.

- When you reverse the trade settlement (RSTL) for a trade where LT – LS handoff is already happened, system reduces the position for the participant in the tranche. The system does not remove the participant from the tranche and the field value propagated to the participant as part of LT – LS handoff is not changed. In addition, system does not remove the maintenance uploaded as part of LT – LS upload processing from the position / portfolio screens. Hence, after RSTL, if you upload a trade amendment / correction with amended 'Doc_Type' value, the system does not propagate the amended value to LS participant / position / portfolio maintenance after settlement. The LS participant added as part of the initial trade settlement continues to exist and the only the position is increased in accordance with the amended trade. The field value remains the same in the LS participant in the tranche. This has to be operationally controlled.

5.31 SLT Processing for Primary Delayed Compensation

5.31.1 Portfolio Details screen

You can invoke the 'Portfolio Details' screen by typing 'TLDPOMNT' in the field at the top right corner of the Application tool bar and clicking the adjoining arrow button.

The screenshot displays the 'Portfolio Details' application window. At the top, there are 'New' and 'Enter Query' buttons. The main area is divided into several sections:

- Portfolio *:** Includes 'Default Portfolio' and 'Branch *' fields.
- Costing Method:** A dropdown menu.
- Interface Type:** A dropdown menu.
- Position Product:** Includes a radio button for 'LMA / LSTA Participation'.
- Portfolio Description:** A text field.
- Desk Code *:** A text field.
- Firm Account Mnemonic:** A text field.
- Revaluation Details:** Includes a 'Revaluation Required' checkbox, 'Reval Frequency' dropdown, 'Reval Start Month' dropdown, and 'Start Day' field.
- Reserve Details:** Includes a 'Reserve Calc Req'd' checkbox, 'Reserve Days' field, and 'Frequency' dropdown.
- Position Identifier Format Details:** Includes an 'Auto Generate Position identifier' checkbox and 'Position Identifier Format' field.
- Linked Unfronted Portfolio Details:** Includes an 'Unfronted' checkbox and 'Linked Unfronted Portfolio' field.

At the bottom, there is a status bar with fields for 'Maker', 'Checker', 'Date Time', 'Mod No', 'Record Status', and 'Authorization Status'. An 'Exit' button is located in the bottom right corner.

Unfronted

The 'Unfronted' check box is enabled only for the portfolios where the desk is 'ORIGINATIONS-PRM'. It is not selected by default. You are allowed to select the check box before the record is authorized once.

The LOV displays only the portfolios where the desk is 'ORIGINATIONS-PRM'.

Linked Unfronted Portfolio

The default value of the 'Linked Unfronted Portfolio' is null. You are allowed to select a value from the LOV.

The LOV displays only the active and authorized portfolios for which the 'Unfronted' check box is selected and the same should not be linked to any other portfolio. You need to create the un-fronted portfolio first, before linking the same to a fronted portfolio.

The system validates at the time of saving the portfolio that the MEICODE of the trading portfolio and the 'Linked Unfronted Portfolio' (if selected) should be same. Appropriate error messages are displayed if the validation is failed.

You are allowed to link only one 'Linked Unfronted Portfolio' with a fronted portfolio.

You are allowed to modify existing trading portfolios and maintain 'Linked Unfronted Portfolio' from the LOV only when 'Linked Unfronted Portfolio' is blank and the 'Unfronted' check box is not selected.

During copy action, the system copies the value of the 'Unfronted' to the newly created portfolio. However, the system does not copy the value of the new field 'Linked Unfronted Portfolio'.

You are allowed to maintain settlement instructions for the newly created 'Linked Unfronted Portfolio' even before portfolio maintenance. You are allowed to maintain position identifier for the newly created 'Linked Unfronted Portfolio'.

You are allowed to do the LS OL product component mapping maintenance for the newly created 'Linked Unfronted Portfolio'. You should maintain the same expense code for the fronted as well as un-fronted portfolios.

5.31.2 Position Identifier Screen

You can invoke the 'Position Identifier Detailed' screen by typing 'TLDPIMNT' in the field at the top right corner of the Application tool bar and clicking the adjoining arrow button.

Position Identifier Detailed

New Enter Query

Portfolio *

Position Qualifier

Branch

Desk

Silent Participant

First Buy Participant

LMA / LSTA Participation

Position Identifier *

Position Identifier Description

Firm Account Mnemonic

Type * Silent

Collateral Settlement Mnemonic

Collateral Online Mnemonic

Unfronted

Maker Date Time: Mod No Record Status

Checker Date Time: Authorization Status

Exit

- The 'Unfronted' check box indicates that the corresponding portfolio is un-fronted.
- This check box is view only.
- The value of the check box is defaulted to selected on selecting the portfolio from the LOV, if the value of the 'Unfronted' check box for the corresponding portfolio is checked and authorized in the 'Portfolio Details' screen.

- The value of the check box is defaulted to cleared on selecting the portfolio from the LOV, if the value of the 'Unfronted' for the corresponding portfolio is cleared and authorized in the 'Portfolio Details' screen.
- When a tranche contract is booked with the 'ORIGINATIONS-PRM' participant, an internal trade is systematically booked to create position in SLT module.

5.31.3 Trading on Lead Agent Deals

1. When a trade is received from ClearPar / Markit with the value of the field 'Primary Trade' as selected, the system checks if the portfolio resolved has any linked un-fronted portfolio.
2. If the resolved portfolio contains any linked un-fronted portfolio, the system creates two records in the agency confirmation browser based on the asset ratio of participant which is involved in trading along with the linked portfolio which is listed within the tranche.
3. Similarly, two records are populated in the 'Pending Trade Browser' screen based on the asset ratio of participant which is involved in trading along with the linked portfolio which is listed within the tranche during settlement.
4. You should submit PRAM for both the records for the trade to get settled and positions are updated in the tranche contracts.
5. Primary trades are applicable only for sell type of trades. The system does not validate that buy primary trades cannot be booked. The same should be operationally controlled.

Tranche (Agented)	Asset Ratio
P1 (Fronted Portfolio)	60%
P2 (Linked un-fronted portfolio)	30%
P3	10%

Tranche Amount / Position prior to settlement:

Tranche Amount	\$10,000
P1 Share (Fronted Portfolio)	\$6000
P2 Share (Linked un-fronted portfolio)	\$3000
P3 Share	\$1000

Trade received from ClearPar/Markit: Participant1 selling \$1000 to Participant3

Two records are populated in agency confirmation browser as below

Trade Amount	\$1000
Record1 (Fronted P1 selling to P3)	\$666.66 ((6000 / 9000) * 1000)
Record2 (Un-fronted P2 selling to P3)	\$333.33 ((3000 / 9000) * 1000)

Below is participant position after the trade is settled.

Tranche Amount	\$10,000
P1 Share (Fronted Portfolio)	\$ 5333.34 (\$6000-666.66)
P2 Share (Linked un-fronted portfolio)	\$ 2666.67 (\$3000-333.33)
P3 Share	\$2000

5.31.4 Trading on Non-Lead Agent Deals

1. When primary trades are received from LQT, OBCL books two trades systematically as below. Ticket id is same for both the trades.
 - First trade based on asset ratio of the fronted self-participant which is involved in trading. The amount for the trade is based on the position held by the fronted portfolio as of the application date. The portfolio for this trade is that of the fronted self-participant. The 'Primary Trade' check box is selected for this trade.
 - Second trade based on asset ratio of the un-fronted self-participant which is linked to the fronted self-participant. The amount for the trade is based on the position held by the un-fronted portfolio as of the application date. The portfolio for this trade is that of the linked un-fronted self-participant. The 'Primary Trade' check box is selected for this trade. The system appends '001' with the value of 'LQT Trade Id' for this trade and the same can be queried in the field 'Ext Contract Ref No' in the 'Draft Trade Input' screen as well as the field 'External Ref No' in the 'Trade Online' screen.
2. Double-click on a record related to the primary trade in the LQT trade browser, the system displays only the trade booked for the fronted portfolio. You are allowed to view the trade booked for the un-fronted portfolio by querying in the field 'Ext Contract Ref No' in the 'Draft Trade Input' screen as well as the field 'External Ref No' in the 'Trade Online' screen.
3. If amendments are received after the two trades are booked systematically, the system applies the changes on both the trades. Amendments leads to the reversal and re-book of the trade is applicable for both trades only if both the trades are booked initially.
4. In case of unavailability of the tranche contract when a primary trade is received, the trade is booked for full amount for the fronted portfolio. The 'Process Status' of the trade is 'Extracted' and the same is available in the origination queue. You are not allowed to confirm the same in the origination queue due to short sell. After creating the tranche and position in SLT module, you are allowed to confirm the trade in origination queue.
5. When LQT trade is received with the value of the field primary trade as 'Yes' and there is only one linked un-fronted self-participant present in the tranche, the system checks if the following maintenance is available.
 - Un-fronted portfolio should be linked to a fronted portfolio in 'Portfolio Maintenance' screen.
 - Fronted and un-fronted portfolio should be linked to the same firm account mnemonic.
6. If the above maintenance is available, the system books the trade with full amount for un-fronted portfolio. If the above maintenance is not available, system fails the trade.
7. If there is no linked un-fronted portfolio and only one fronted portfolio is present in the underlying tranche contract, the system books a trade for the entire trade amount received from LQT for the fronted portfolio.
8. During LQT trade upload, if the resolved portfolio belongs to the new desk 'ORIGINATIONS-PRM' but the value of the field 'Primary Trade' is N, the system fails the trade booking.

9. During settlement of primary trades received from ClearPar/Markit, the system validates the trading position held by the respective fronted portfolio and the linked un-fronted portfolio as of the application date. If the positions mismatch, trade settlement is failed with appropriate error messages. Trade is settled successfully if the positions match.

Example 1: (Both fronted as well as un-fronted portfolio available in tranche)

Fronted Portfolio - P1

Linked Un-Fronted Portfolio - P2

Tranche (Agented)	Asset Ratio
P1 (Fronted Portfolio)	60%
P2 (Linked un-fronted portfolio)	30%
P3	10%

Tranche Amount / Position prior to settlement:

Tranche Amount	\$10,000
P1 Share (Fronted Portfolio)	\$6000
P2 Share (Linked un-fronted portfolio)	\$3000
P3 Share	\$1000

Trade received from LQT: P1 selling \$1000 to P3

Two trades are booked in OBCL as below

Trade Amount (From LQT)	\$1000
Trade 1 (Fronted P1 selling to P3)	\$666.66 ((6000 / 9000) * 1000)
Trade 2 (Un-fronted P2 selling to P3)	\$333.33 ((3000 / 9000) * 1000)

Below is participant position after the trade is settled.

Tranche Amount	\$10,000
P1 Share (Fronted Portfolio)	\$ 5333.34 (\$6000-666.66)
P2 Share (Linked un-fronted portfolio)	\$ 2666.67 (\$3000-333.33)
P3 Share	\$2000

Example 2: (Only fronted portfolio available in tranche)

Fronted Portfolio – P4

Linked Un-Fronted Portfolio – P5 (Not available in tranche)

Tranche (CITI Agented)	Asset Ratio
P4 (Fronted Portfolio)	60%
P6	30%
P7	10%

Tranche Amount / Position prior to settlement:

Tranche Amount	\$10,000
P4 Share (Fronted Portfolio)	\$6000
P6 Share	\$3000
P7 Share	\$1000

Trade received from LQT: P4 selling \$1000 to P7

One trade booked for P4 in OBCL for the full amount as below

Trade Amount (From LQT)	\$1000
Trade 1 (Fronted P4 selling to P7)	\$1000

Below is participant position after the trade is settled.

Tranche Amount	\$10,000
P4 Share (Fronted Portfolio)	\$5000
P6 Share	\$3000
P7 Share	\$2000

Example 3: (Only un-fronted portfolio available in tranche. Portfolio maintenance is available)

Fronted Portfolio - P8 (Not available in tranche)**Linked Un-Fronted Portfolio - P9**

Tranche (CITI Agented)	Asset Ratio
P6	60%
P9 (Linked un-fronted portfolio)	30%
P7	10%

Note

The un-fronted portfolio (P9) is linked to a fronted portfolio (P8). However, the same participant is not available in the tranche contract.

Tranche Amount / Position prior to settlement:

Tranche Amount	\$10,000
P6 Share	\$6000
P9 Share (Un-fronted Portfolio)	\$3000
P7 Share	\$1000

Trade received from LQT: P9 selling \$1000 to P7

One trade is uploaded for P9 in Oracle Banking Corporate Lending for full amount as below

Trade Amount (From LQT)	\$1000
Trade 1 (Fronted P9 selling to P7)	\$1000

Below is participant position after the trade is settled.

Tranche Amount	\$10,000
P6	\$6000
P9 (Linked un-fronted portfolio)	\$2000
P7	\$2000

Example 4: (Only un-fronted portfolio is available in tranche. Portfolio maintenance is not available)

Un-Fronted Portfolio - P9

Tranche (Agented)	Asset Ratio
P6	60%
P9 (Un-fronted portfolio)	30%
P7	10%

Note

The un-fronted portfolio (P9) is not linked to a fronted portfolio.

Tranche Amount / Position prior to settlement:

Tranche Amount	\$10,000
P6 Share	\$6000
P9 Share (Un-fronted Portfolio)	\$3000
P7 Share	\$1000

Trade received from LQT: P9 selling \$1000 to P7. The trade received from LQT is failed.

10. When you create a tranche contract with participants which are linked to the new desk, the system creates position in SLT module systematically.
11. The position for the respective fronted and linked un-fronted portfolios are updated in the SLT module during the following events on the tranche/drawdown contracts.
 - Booking of tranche / drawdown contract.
 - Principal payment on drawdown contract.
12. The position is also be updated in SLT module, if the 'Update LT Position' check box is selected for the participant (only for portfolios with the desk 'ORIGINATIONS_PRM'/'ORIG'/'ORIGINATIONS_HFS')
 - Participant transfer on tranche contract.
 - Value dated amendment on tranche/drawdown contract.
13. You are not allowed to add an un-fronted / fronted portfolio to a tranche contract as part of participant transfer.
14. Delayed compensation fees are accrued on the primary trades like the secondary loan trades.
15. Primary trades are applicable only for sell type of trades. The system does not validate that buy primary trades cannot be booked. The same should be operationally controlled.
16. Automated ticket settlement by means of SDN messages from Markit is not applicable for the primary trades. Booking of internal trades for creation of position from LS to SLT module is not impacted.

5.31.5 Reduction of Un-Amortized Fees during trade

1. You should maintain the amortization fees in the existing 'Amortization Fee' screen for the fronted and un-fronted commitments.
2. Origination queue screen is populated for the primary trades as well, for both fronted and un-fronted portfolio.
3. Any fees associated with the primary trade is reduced based on the fees maintained in the 'Amortization Fee' screen for the commitment after the settlement of the sell trade like the CLP trades.

5.31.6 Placement Processing

1. This functionality is applicable for the match funded placement contracts linked to both Lead agented and non-Lead agented deals

2. After the trade settlement (sell trade) is STP'd to OL, at the time of OL negative VAMI processing, the system checks if any match funded placement contract is present for the associated loan.
3. If any match funded placement contract is identified, the contract amount of such placement contracts are reduced systematically for each sell trade to the extent of the amount of the trade and asset ratio at the tranche level for that participant.
4. Systematic reduction on the placement contracts is done as a prepayment. LIQD event is registered in the placement contract with value date as settlement date of the trade.

Example 1:

Tranche	Asset Ratio
P1 (Fronted Portfolio)	60%
P2 (Un-fronted Portfolio)	30%
P3	10%

Tranche Amount	\$10,000
P1 Share (Fronted Portfolio)	\$6000
P2 Share (Un-fronted Portfolio)	\$3000
P3Share	\$1000

Drawdown1 Amount	\$2000
P1 Share (Fronted Portfolio)	\$1200
P2 Share (Un-fronted Portfolio)	\$600
P3Share	\$200

Commitment1 (STP'd from Tranche P1)	\$6000
Commitment2 (STP'd from Tranche P2)	\$3000

Loan1 (STP'd from DD P1)	\$1200
Loan2 (STP'd from DD P2)	\$600

Placement1 (For Loan1)	\$1200
Placement2 (For Loan2)	\$600

Trade received: P1 Selling \$1000 to P3.

After settlement, positions at tranche / drawdown / commitment / loan / placement contracts are as below:

Tranche Amount	\$10,000
P1 Share (Fronted Portfolio)	\$5333.34 ($\$6000 - ((6000 / 9000) * 1000)$)
P2 Share (Un-fronted Portfolio)	\$2666.67 ($\$3000 - ((3000 / 9000) * 1000)$)
P3Share	\$2000

Drawdown1 Amount	\$2000
P1 Share (Fronted Portfolio)	\$1066.67 (53.33% of \$2000)
P2 Share (Un-fronted Portfolio)	\$533.33 (25.55% of \$2000)
P3Share	\$400 (10% of \$2000)

Commitment1	\$5333.34
Commitment2	\$2666.67

Amount to be reduced on Loan1	\$133.33 ($\$1200 - \1066.67)
Amount to be reduced on Loan2	\$66.67 ($\$600 - \533.33)
Pre-payment on Placement1	\$133.34
Pre-payment on Placement2	\$66.67

After systematic reduction in the placement contract, the new position will be as follows

Placement1 (For Loan1)	\$1066.67
Placement2 (For Loan2)	\$533.33

1. If there are multiple trade settlements on the same day, for each settlement system registers LIQD event and reduce the contract amount to the extent of the amount of the trade and asset ratio at the tranche level for that participant.
2. If trade settlement is received after the treasury cut off, then system processes the reduction as a future dated payment and the payment is processed in the next day's batch.
3. If the trade settlement on the primary trade is reversed (RSTL), the prepayment (LIQD) posted in the placement contract for amount reduction is not reversed. The same should be operationally controlled.

5.31.7 Trade Type Amendment

1. You are allowed to change the deal type (Assignment, Participation so on.) for all the active primary trades under the same LQT Ticket.

2. If the deal type is changed for primary trades, the system reverses and rebooks both the trades.
3. When the settlement is processed, the system considers the latest deal type.

Example 1:

- Ticket ID: 633304
 - Trade Type: Assignment
 - Trade 1: CP1 (Fronted)
 - Trade 2: CP2 (Linked un-fronted)
 - Trade Type changed to Participation in LQT
 - The system reverses and rebooks the trades as below.
 - Ticket ID: 633304
 - Trade Type: Participation
 - Trade 3: CP1 (Fronted)
 - Trade 4: CP2 (Linked un-fronted)
4. Both trades are settled as participation.

6. Processing Fee Details

This chapter contains the following sections:

- [Section 6.1, "Introduction"](#)
- [Section 6.2, "Amending Fee Details"](#)
- [Section 6.3, "Liquidating Fee Components"](#)

6.1 Introduction

Different types of fees are involved in the trading of a syndicated loan. The following are the various types of fees involved in trading:

- Assignment fee
- Amendment fee
- Line/Accommodation fee
- Delayed compensation fee
- Break funding fee
- Waiver Fee
- Benefit of commitment reduction fee
- Upfront fee

The following two adhoc fee components are also involved in the trading process:

- Buyer to seller fee
- Seller to Buyer fee

The different types of the fees and their significance in the trading process are explained in the subsequent sections.

This section contains the following topics:

- [Section 6.1.1, "Specifying Assignment Fee Details"](#)
- [Section 6.1.2, "Suppressing Wire Messages for Assignment Fees"](#)
- [Section 6.1.3, "LQT Trade Upload"](#)
- [Section 6.1.4, "Specifying Amendment Fee Details"](#)
- [Section 6.1.5, "Specifying Line/Accommodation Fee Details"](#)
- [Section 6.1.6, "SLT - Accounting for Amendment Fee"](#)
- [Section 6.1.7, "Specifying Delayed Compensation Fee Details"](#)
- [Section 6.1.8, "Specifying Break Fund Fee Details"](#)
- [Section 6.1.9, "Specifying Waiver Fee Details"](#)
- [Section 6.1.10, "Specifying Benefit of Commitment Reduction Fee \(BCR\) Details"](#)
- [Section 6.1.11, "Specifying Upfront Fee Details"](#)
- [Section 6.1.12, "Specifying Adhoc Fee Details"](#)
- [Section 6.1.13, "Specifying Brokerage Details"](#)

6.1.1 Specifying Assignment Fee Details

The assignment fee refers to the flat fee that needs to be paid to the agent facilitating the trade. This fee can be paid either by the buyer or the seller fully, or can be shared between the buyer and the seller.

Following steps are involved in capturing and processing the assignment fee associated with a trade contract:

1. The assignment fee component gets linked to the SLT product in the 'SLT Product Fee Details' screen.
2. The assignment fee details for a trade contract are specified in the 'Fee Components' screen associated with the contract.
3. The buyer's and the seller's contribution to the assignment fee is captured in this screen.
4. You can capture the customer number of the agent to whom the assignment fee is to be paid and also indicate the remitter of the assignment fee in the 'Draft Trade' screen and the 'Trade settlement' screen.
5. Based on the value of 'Assignment Fee Remitter', 'Assignment Fee Type', and the buy/sell attribute of the trade, the assignment fee gets remitted to the agent or the counterparty involved in the deal.

For 'Split' type of assignment fee payments, the split amounts get posted to the agent and counterparty accounts.

The accounting entries posted for different scenarios of assignment fee collection is given below:

Fee Type	Bank is Buyer	Bank is Seller
Assignment Fee Type =BUYER & 'BUYER WILL REMIT'	Dr Expense A/c Cr Agent A/c	No entries
Assignment Fee Type =BUYER & 'SELLER WILL REMIT'	Dr Expense A/c Cr Counterparty A/c	Dr Counterparty A/c Cr Agent A/c
Assignment Fee Type =SELLER & 'SELLER WILL REMIT'	No entries	Dr Expense A/c Cr Agent A/c
Assignment Fee Type =SELLER & 'BUYER WILL REMIT'	Dr Counterparty A/c Cr Agent A/c	Dr Expense A/c Cr Counterparty A/c

Assignment Fee Type =SPLIT & 'BUYER WILL REMIT'	Dr Counterparty A/c (for the specified fee amount for Seller) Dr Expense A/c (for the specified fee amount for Buyer) Cr Agent A/c (for the full Fee amount)	Dr Expense A/c (for the specified fee amount for Seller) Cr Counterparty A/c (for the specified fee amount for Seller)
Assignment Fee Type =SPLIT & 'SELLER WILL REMIT'	Dr Expense A/c (for the specified fee amount for Buyer) Cr Counterparty A/c (for the specified fee amount for Buyer)	Dr Counterparty A/c (for the specified fee amount for Buyer) Dr Expense A/c (for the specified fee amount for Seller) Cr Agent A/c (for the full Fee amount)

6.1.2 Suppressing Wire Messages for Assignment Fees

1. If the value is 'PAID IN ADVANCE', the wire messages that should be remitted to the agent with reference to assignment fee is suppressed.

Note

If the value of the field 'Assignment Fee Type' is other than 'PAID IN ADVANCE', the wire messages with reference to assignment fee are remitted to the agent.

2. The accounting entries related to assignment fee is posted and other wire messages to the external counterparty are remitted.
3. If the value of the field 'Assignment Fee Type' is 'PAID IN ADVANCE', but SDN message is received for settlement of the trade contract, the fee type is considered as 'Split' and wire message is generated for the assignment fee amount.
4. If the value of the field 'Assignment Fee Type' is 'PAID IN ADVANCE' and the trade contract is settled manually, the accounting entries are posted for the amount tag 'ASGNF_SPT1'.

6.1.3 LQT Trade Upload

- LQT trade upload processes the 'PAID IN ADVANCE' value in 'ASSIGNMENTFEE_TYPE' field from the LQT feed.
- Defaults the value of the field 'Assignment Fee Type' as 'PAID IN ADVANCE' in the Draft Trade Input, Trade Online and Settlement screens, if the value 'PAID IN ADVANCE' is received from the LQT feed.
- If you amend the value of the field 'ASSIGNMENTFEE_TYPE' through LQT trade upload, the system does not reverse and rebook the trade with the new value.

6.1.4 Specifying Amendment Fee Details

Amendment fee is the fee that needs to be paid for any changes in the agency between the trade date and the settlement of the trade. This fee is paid by the seller to the buyer.

You can capture the details of the amendment fee in the 'Amendment Fee Input' screen. You can invoke the 'Amendment Fee Input' screen by typing 'TLDAMFEE' in the field at the top right corner of the Application tool bar and clicking on the adjoining arrow button.

You can specify the following details in this screen:

CUSIP/ISIN

Select the CUSIP number of the facility associated with the trade you wish to amend, from the option list provided.

Amendment Date

Specify the date on which the amendments on the trade should become effective.

Click 'Populate' to display the details of all open trades under the CUSIP with trade date less than or equal to the amendment date.

You can also provide the following additional search values to select the trade for amendment.

Position Identifier

Select the position identifier associated with the trade you wish to amend, from the option list provided.

Position Qualifier

Select the position qualifier associated with the trade you wish to amend, from the option list provided.

Branch

Select the branch associated with the trade you wish to amend, from the option list provided.

Desk

Select the desk where trade you want to amend originated, from the option list provided.

Expense Code

Select the branch expense code with the trade you want to amend, from the option list provided.

Amendment Rate

Specify the amendment fee rate to be applied to all open trades under the CUSIP. Fee amount gets calculated automatically for all open trades listed.

Note

You can modify the auto calculated fee amount, if required.

Waive All

If this check box 'Waive All' is selected then amendment fee is waived for all the trades for an amendment date. You are allowed to clear 'Waive' check box for a specific trade after selecting 'Waive All' check box.

Waive

By default, the 'Waive' check box for each trade is not selected. If 'Waive' check box is selected for a trade, then the amendment fee is waived for the current amendment date.

Example:-

Amendment Fee for Trade 1	100.00
Trade Date	1-Apr-2015

Amendment fee is captured multiple times for trade1 in amendment fee input screen as below

Amendment Date	Fee Amount	Waive
1-May-2015	50.00	No
1-Jun-2015	30.00	No
1-Jul-2015	20.00	No

Another amendment fee input is processed for the amendment date 1-Aug-2015 for the fee amount of 25. If 'Waive' check box is cleared for 1-Aug-2015 then amendment fee for trade 1 is 125. If the 'Waive' check box is selected then trade continues to have the prior fee amount of 100 as the fee amount of 25 is waived for the amendment date 1-Aug-2015.

Fee Amount

Specify the amendment fee amount for each open trade listed for the CUSIP. You can also specify the fee rate, based on which the amount is calculated automatically.

After the details specified are authorized, the amendment fee gets updated for all open trades, correspondingly. If any amendment fee already exists for the trade, the new amount gets added to the existing amount to arrive at a consolidated amendment fee amount.

For a trade, if amendment fee needs to be applied for various days between the trade date and settlement date, the fee amount for each gets summed up and defaulted to the trade for its settlement.

The accounting entries posted for amendment fee is specified below.

Bank is Buyer	Bank is Seller
Dr Trade Counterparty A/c Cr Income a/c	Dr Expense a/c Cr Trade Counterparty A/c

Waiving amendment fees

You are allowed to unlock a record for a specific amendment date and waive amendment fee for one or more trades. Only 'Waive' and 'Waive All' check box are allowed to change during unlock operation. Remaining all fields are view only during unlock and you are not allowed to change fee rate or fee amount once the amendment fee record is saved for a given amendment date.

Example:-

Amendment fee for trade 1 before amendment - 100

Amendment Date	Fee Amount	Waive
1-May-2015	50.00	No
1-Jun-2015	30.00	No
1-Jul-2015	20.00	No

Amendment fee for trade 1 after amendment

Amendment Date	Fee Amount	Waive
1-May-2015	50.00	No
1-Jun-2015	30.00	Yes
1-Jul-2015	20.00	No

Amendment fee amount becomes 70 as the fee is waived for trade 1 for the amendment date 1-Jun-2015

1. Amendment fee is allowed to be waived or un-waived even after the liquidation of amendment fee. In such cases, the residual amendment fee amount is allowed to be liquidated in the existing fee liquidation screen as per the existing functionality.

Example:

Amendment fee is liquidated for 50.

Amendment Date	Fee Amount	Waive
1-May-2015	50.00	No
1-Jun-2015	30.00	Yes

2. Amendment fee is allowed to be un-waived for 30 and the total amendment fee amount becomes 80. The residual 30 can be liquidated in the 'Fee Liquidation' screen.
3. Amendment fee is allowed to be waived for 50 and the total amendment fee amount becomes 30. The residual (-50) can be liquidated in the 'Fee Liquidation' screen.
4. Currently, amendment fee can be amended or captured in 'Amendment Fee Input' screen for settled and unsettled trades having trade date lesser than or equal to the amendment date and actual settlement date greater than or equal to the amendment date.
 - After settlement, when amendment fee is waived for an amendment date then if the fee amount will be in negative; when amendment fee is un-waived for an amendment date then the fee amount will be in positive.
 - The differential fee amount can be liquidated in the existing fee liquidated screen.
5. Currently, amendment fee change is not allowed when the trade is captured (but not settled) in 'Ticket Settlement' or 'Combined Ticket Settlement' screen and the payment message is generated at the sub-ticket level (Payment message netting).
 - Since payment message is already generated, if amendment fee is changed before settlement then amendment fee amount during settlement is different than the amount that is sent in PMSG. Hence the fee amendment is blocked in such cases
 - Additionally, waiver or un-waiver also is not allowed in the 'Amendment Fee Input' screen.
6. Currently, modification is allowed in 'Amendment Fee Input' screen for the trades with Par, Distress and Origination desks.
7. All three legs of CLP trades are populated for modification as per the existing functionality. You are allowed to waive any leg (for example, PL trade, par selling/buying from origination) and this should be manually done.
8. You are allowed to close a specific amendment fee record. On save of 'Close' operation, system reduces the amendment fee amount that was applied for the specific amendment date from all the applicable trades.

Example:-

Amendment Date	Fee Amount	Waive	Open
1-May-2015	50.00	No	Yes
1-Jul-2015	20.00	No	Yes

Total amendment fee for trade 1 is 70.

Amendment Date	Fee Amount	Waive	Open
1-May-2015	50.00	No	Yes
1-Jul-2015	20.00	No	No

Total fee amount becomes 50 as 1-Jul-2015 record is closed.

9. Deletion of amendment fee record is allowed for a specific amendment date before authorization. FAMD event is deleted and fee amount associated with the amendment date is reduced appropriately for each trade.

6.1.4.1 Amendment Fee History

You can invoke the 'Amendment Fee Input' screen by typing 'TLDAMFEH' in the field at the top right corner of the Application tool bar and clicking on the adjoining arrow button.

- You can view amendment history for each trade
- You can view history details for a specific trade with prior amendments
- You can only view history details

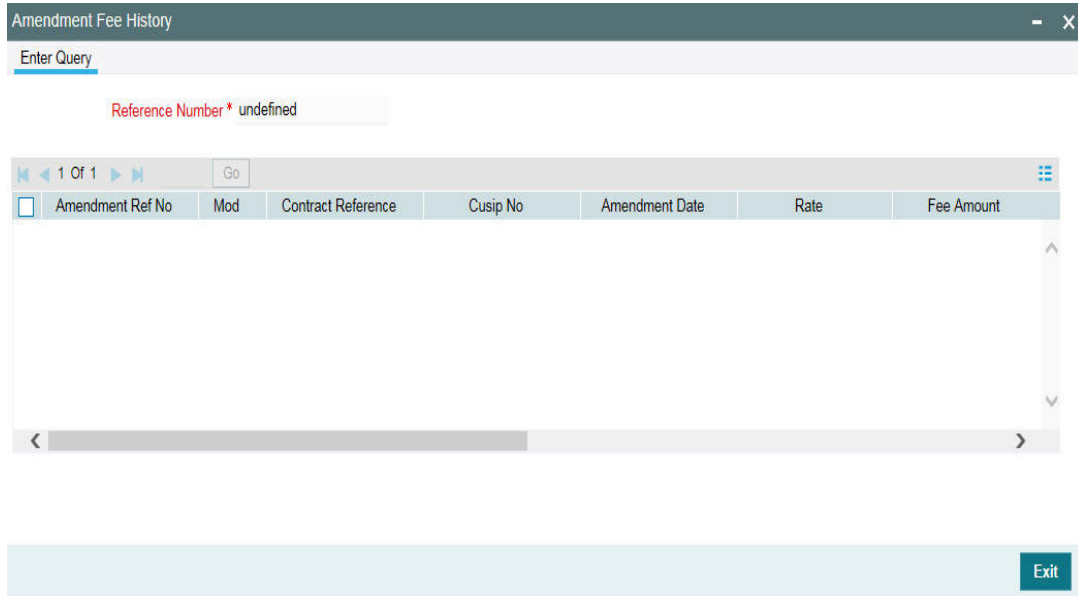

Example:-

You have performed multiple amendments for trade1 as below for the amendment date 1-Jun-2015.

Amendment Date	Fee Amount	Waive	Amendment #
1-May-2015	50.00	No	1
1-Jun-2015	30.00	Yes	1
1-Jun-2015	20.00	No	2
1-Jun-2015	10.00	Yes	3
1-Jul-2015	20.00	No	1

Amendment#3 for trade 1 is displayed in the main screen. Amendment#1 and 2 with appropriate audit trial details for trade 1 is displayed in the 'Amendment Fee History' screen.

1. Below validations are performed in the amendment fee input screen.

- Only one open record should exist for the combination of CUSIP, amendment date and query fields (branch, desk, expense code, position identifier, and position qualifier).
- If an open maintenance exists for the combination of CUSIP and amendment date with blank value for the query fields then you are not allowed to maintain one more record for the same combination of CUSIP and amendment date. However, you can maintain amendment fee record for a different amendment date for the same CUSIP with query fields as blank or with specific value.

Example1:-

Maintenance exists for the combination of CUSIP and amendment date with blank value for query fields.

CUSIP	Amendment Date	Branch	Desk	Expense Code	Position Identifier	Position Qualifier
CUSIP 1	1-Feb-16					

Maintenance as mentioned below is not allowed

CUSIP	Amendment Date	Branch	Desk	Expense Code	Position Identifier	Position Qualifier
CUSIP 1	1-Feb-16	001	PAR	04321	060083	12345

- If an open maintenance exists for the combination of CUSIP and amendment date with specific value for the query fields then you are not allowed to maintain one more record for the same combination of CUSIP and amendment date with blank value for the query fields.

Example2:-

Maintenance exists for the combination of CUSIP and amendment date with specific value for query fields.

CUSIP	Amendment Date	Branch	Desk	Expense Code	Position Identifier	Position Qualifier
CUSIP 1	1-Feb-16	001	PAR	04321	060083	12345

Maintenance as mentioned below is not allowed

CUSIP	Amendment Date	Branch	Desk	Expense Code	Position Identifier	Position Qualifier
CUSIP 1	1-Feb-16					

However, the below maintenance are allowed as the portfolio, expense code and position identifier are different

CUSIP	Amendment Date	Branch	Desk	Expense Code	Position Identifier	Position Qualifier
CUSIP 1	1-Feb-16	001	ORIG	00031	060086	12345

If specific value is maintained for one query field then all query field should have a specific value

Example3:-

Below maintenance is not allowed

CUSIP	Amendment Date	Branch	Desk	Expense Code	Position Identifier	Position Qualifier
CUSIP 1	1-Feb-16	001	ORIG	00031	060086	BLANK

Note

Maintenance have to be closed for the combination of CUSIP, amendment date and query fields and new maintenance have to be created for the same combination to apply different amendment fee rate for the trades under the CUSIP.

- Above mentioned validations are performed during
 - Amendment fee is captured manually in 'Amendment Fee Input' screen
 - Amendment fee record is reopened for a specific amendment date.
- At least one active or settled trade should be present for the combination of CUSIP and amendment date to save amendment fee input.
- Trade settlement fails if amendment fee input is unauthorized for the trade.
- Trade is not displayed in the 'Amendment Fee Input' screen when 'Populate' button is pressed during the below mentioned scenarios
 - Trade settlement is unauthorized for the trade
 - Ticket settlement is unauthorized with the trade
 - Combined ticket settlement is unauthorized with the trade
 - Fee liquidation is unauthorized for the trade

Currently, amendment fee can be captured in the 'Amendment Fee Input' screen though the fee is waived at the component level but settlement is not allowed for the amendment fee.

When actual settlement date is lesser than the amendment date and amendment fee exists for the trade with amendment date greater than actual settlement date then amendment fee is recomputed during settlement by excluding the fee amount associated with the amendment date which is greater than the actual settlement date. This can occur in two scenarios

- When future dated amendment fee input is captured and the trade is settled today
- When the trade is settled with actual settlement date in past and amendment fee input is captured for today or back dated.

6.1.4.2 Systematic (Re) Calculation of Amendment Fee

1. Oracle Banking Corporate Lending systematically recalculates the amendment fee amount for each amendment date during the below trade activities.
2. During trade amount amendment for the Par and Distressed desks, system recalculates amendment fee for all the amendment dates available for the trade. TAMM event is registered for such amendments and there are no accounting entries during TAMM.

Note

Currently, accounting entries are not posted for amendment fee if fee is captured or updated during trade booking, trade amendment and fee amendment.

3. The latest trade amount is considered for the amendment fee computation if there is no commitment reduction / PIK amendment for the trade. If commitment reduction / PIK amendment exists then trade amount as of the amendment date is considered for the calculation of amendment for each amendment date.

Example without PIK and Commitment Reduction:-

Activity for Trade1	Value Date	Trade Amount	Commitment Reduction/ Increase	PIK
Trade booked	1-Apr-15	100,000.00	-	-
Amount amendment On 20-May-2015	1-Apr-15	95,000.00	-	-

Note

Trade booked on 1-Apr-2015 with trade date as 1-Apr-2015

Amendment fee computation in amendment fee input screen for trade 1 after trade amount amendment

Amendment Date	Fee Rate	Trade Amount	Fee Amount	Waive
10-May-15	0.40%	95,000.00	380.00	No
1-Jun-15	0.30%	95,000.00	285.00	No
Amendment Fee for the trade			665.00	

Example with PIK and Commitment Reduction:-

Activity for Trade1	Value Date	Trade Amount	Commitment Reduction/ Increase	PIK
---------------------	------------	--------------	--------------------------------	-----

Trade booked	1-Apr-15	100,000.00	-	-
Commitment Reduction	9-May-15	95,000.00	(5,000.00)	-
PIK	20-May-15	96,000.00		1,000.00
Commitment Increase	30-May-15	98,000.00	2000.00	-
Commitment Reduction	10-Jun-15	88,000.00	(10,000.00)	-

Amendment fee computation in amendment fee input screen for trade 1

Amendment Date	Fee Rate	Trade Amount	Fee Amount	Waive
10-May-15	0.40%	95,000.00	380.00	No
1-Jun-15	0.30%	98,000.00	294.00	No
Amendment Fee for the trade			674.00	

- PIK and commitment reduction events processed with value date lesser than or equal to the amendment date is considered for re-calculation of the amendment fee amount.
 - In the above example, commitment reduction processed on 9-May-2015 has been considered for the amendment date 10-May-2015
- PIK and commitment reduction events processed with value date after the amendment fee date is not considered for re-calculation of the amendment fee amount.
 - In the above example, commitment reduction processed on 10-Jun-2015 has not been considered for the amendment fee calculation.
- When amendment fee is un-waived for a trade for a specific amendment date then amendment fee is recomputed for the trade amount as on the amendment date; trade amount is arrived based on the latest commitment reduction / PIK balance as on the amendment date.

Note

Original trade amount is not used for the amendment fee computation.

4. Records in amendment fee input screen will remain unchanged when user performs trade amendment and waive the amendment fee component. In such cases, amendment fee is not allowed to be settled.

If user performs trade amendment and un-waive the amendment fee component then the amendment fee is considered for settlement.

6.1.4.3 Other Fee related changes

1. You are not allowed to edit the amendment fee amount and rate from the trade Input screen ('Draft Trade' screen). However, you can waive amendment fee at the component level even if amendment fee exists for the contract. In such cases, system does not allow to settle amendment fee.

2. Amendment is allowed for the remaining fee components from the 'Draft Trade' screen.
3. For CUSIP swing, if a new trade is booked with a new CUSIP and there is no maintenance for the new CUSIP in 'Amendment Fee Input' screen then amendment fee will not be applied on the new trade. This should be manually done.
4. During CUSIP amendment, system reverses the existing trade and book a trade with a new CUSIP. Amendment fee is not applied on the new trade if maintenance is not available for the new CUSIP in 'Amendment Fee Input' screen.
5. Currently there are multiple fields to filter the population of trade reference number in 'Amendment Fee Input' screen (branch, position identifier, expense code, so on); if these fields are used for query during 'Amendment Fee Input' screen then amendment fee is calculated for the new/re-booked trades only if all the conditions are met.

Example:- Amendment fee maintenance exist in the 'Amendment Fee Input' screen for the below combination.

Branch	001
CUSIP	CUSIP1
Portfolio	060083

Trade booked with CUSIP1 under the branch 001 but portfolio is 179471 then amendment fee is not applied for the new trade.

6. Trade reversal does not remove the trade record(s) from 'Amendment Fee Input' screen..
7. Funding memo regeneration will be required when amendment fee is waived or un-waived in the 'Amendment Fee Input' screen after capturing future dated ticket or trade settlement. Funding memo status will be changed to 'Regenerate FMEM' in the trade settlement screen during authorization of amendment fee input in such cases.

6.1.5 Specifying Line/Accommodation Fee Details

Line or accommodation fee is involved for trades executed by a desk on behalf of some other desk. Line or accommodation fee is calculated based on the commission rate received from the external system, Loans QT.

Following steps are involved in capturing and processing the line/accommodation fee associated with a trade contract:

1. The line/accommodation fee component gets linked to the SLT product in the 'SLT Product Fee Details' screen.
2. The commission rate for the trade contract is captured as the 'Fee Rate' in the 'Fee Components' screen associated with the contract.
3. The line/accommodation fee is calculated as per the formula given below:

$$\text{Fee} = \text{Trade Nominal Amount} * \text{Commission Rate}$$

The account entries posted for line/accommodation fee posted for the trade booking event (TBOK) for the SLT trade products (Origination Line (OL) and Par Line (PL) trade) is given below:

For Origination buy/sell from Par (OL)	For Par Desk in the Line trade
Dr Line Fee GL	Cr Line Fee GL
Cr SLT Bridge Account	Dr SLT Bridge Account

Note

- After the Par desk Line Trade is booked using the department code, all accounting entries, including the line/accommodation fees that are posted for the line trade of par desk will be posted using the defaulted department code.
 - Line/Accommodation Fee GL should be maintained as part of the Accounting Role to Head mapping in the SLT Trade Product.
 - SLT Bridge Account is derived while posting the entries from the SLT Branch Parameters setup for the trade branch and trade currency.
 - Line or accommodation fee is not supported when 'ORIG desk to External Counterparty' check box is selected for Origination desk.
-

6.1.6 SLT - Accounting for Amendment Fee

During EOD Oracle Banking Corporate Lending post the accounting entries for an amendment fee for the trades booked in a day. This can due to following changes.

- Trade is waived or not waived in 'Amendment Input' screen
- Amendment fee transaction containing the trade is closed or re-opened in 'Amendment Input' screen
- Amendment fee is waived at component level in 'Trade -Draft' screen
- If amendment fee is changed and then settlement or fee liquidation happens on the same day
- Reverse the amendment fee accrual entries as part of trade reversal

6.1.6.1 Specifying Amendment Fee Accrual

You can select 'Amendment Fee Accrual Required' check box for trade products from 'Secondary Loan Trade -Product Preferences' (TLDPRMNT) screen. If this is check box is selected, then amendment fee accrual processing is applicable.

Note

Amendment fee accrual is not applicable for CLP trades.

6.1.6.2 Amendment Fee Accrual during Settlement and Fee Liquidation

1. Accrual entries are posted for amendment fee during settlement when
 - When actual amendment fee amount is changed in 'Funding Memo' screen
 - The trade is booked with amendment fee and settled on the same day.
 - Settlement is performed on the same day of trade amendment where the amendment fee is revised as part of trade amendment.
 - Settlement is performed on the same day of trade amendment where the amendment fee is waived at the component level.
 - Amendment fee record is closed or reopened in 'Amendment Fee Input' screen and settlement is performed on the same day.
 - Amendment fee record is waived or not-waived in 'Amendment Fee Input' screen and settlement is performed on the same day.

Note

The above changes will be done when a trade is settled in trade settlement or ticket settlement or combined ticket settlement screen.

2. Accrual entries are posted for amendment fee during fee liquidation when
 - Fee Liquidation is performed on the same day of trade amendment where amendment fee input record is created for the settled trade with amendment date between trade date and actual settlement date.

- Amendment fee record is closed or reopened in 'Amendment Fee Input' and fee liquidation is performed on the same day.
 - Amendment fee record is waived or un-waived in 'Amendment Fee Input' and fee liquidation is performed on the same day.
3. Amendment fee accrual entries are not reversed when trade settlement is reversed (RSTL) or fee liquidation is reversed (FREV). Amendment fee amount remains same after RSTL and FLIQ and it is not updated with the amendment fee amount that exists prior to the settlement.
 4. Amendment fee accrual entries are reversed for a trade when the trade is reversed.

For information accounting entries, refer to 'Accounting Entries for Amendment Fees' section in this User Manual.

6.1.7 **Specifying Delayed Compensation Fee Details**

Delayed compensation fee (DCF) is calculated for trades whose settlement gets delayed. If the settlement does not happen as on T+7/T+20, according to standards, a delayed compensation fee is calculated and applied for 'SWOA' type of quotations. DCF is not applicable if the trade quotation method is 'FLAT'.

The delayed compensation fee component is linked to the SLT product in the 'SLT Product Fee Details' screen. Calculation of DCF is triggered only if the actual settlement date exceeds the expected settlement date as specified in 'Draft Trade' screen.

There are various components associated with DCF which can be summarized as follows:

6.1.7.1 **DCF on Funded Amount**

DCF for the funded amount will be calculated for the period from expected settlement date till the actual settlement date.

Par and TRS Trades

For Par and TRS trades the following fee components are calculated for funded amount:

- Interest computed on Libor Funded Amount, exchanged from seller to buyer. The DCF category used is 'DCF-FIX-MARGIN' (DCF interest using margin for Fixed type drawdowns) calculated as follows:
 - Libor Funded amount * (Actual Settlement Date – Expected Settlement Date) * Margin/Denominator basis

Where,

Libor Funded amount is the sum of outstanding amount of all the Libor (Fixed) type drawdowns under the CUSIP

Margin = Spread + Oracle Banking Corporate Lending Margin

Denominator basis is arrived based on the value of *Fee calc Basis*.

- Interest computed on Prime Funded Amount, exchanged from seller to buyer. The DCF category used is 'DCF-FLT-INT' (DCF All-in-rate interest for Floating type drawdowns) calculated as follows:
 - Prime Funded amount * (Actual Settlement Date – Expected Settlement Date) * All-in Rate

Where,

Prime Funded amount is the sum of outstanding amount of all the Prime (Float) type drawdowns under the CUSIP

All-in Rate = Base rate+ Spread+ Oracle Banking Corporate Lending Margin

Denominator basis is arrived based on the value of *Fee calc Basis*

- Cost of Fund computed on Prime Funded Amount, exchanged from buyer to seller. The DCF category used is 'DCF-FLT-COF' (DCF Cost of Funds for Floating type drawdowns) calculated as follows:
 - Prime Funded amount on Expected settlement Date(T+7) * (Settlement Date – Expected Settlement Date)* Average Libor Rate/ Denominator basis

Where,

Prime Funded amount on Expected settlement Date (T+7) is the sum of outstanding amount of all the Prime (Floating) type drawdowns under the CUSIP on the expected settlement date (T+7).

Average Libor Rate is derived using data from 'Average Libor rate Maintenance' and is calculated from T+7 through settlement date.

Distressed Trades

For Distressed trades the following fee components are calculated for funded amount:

- Interest computed on Prime Funded Amount, exchanged from seller to buyer. The DCF category used is 'DCF-FLT-INT' (DCF All-in-rate interest for Floating type drawdowns) calculated as explained before.
- Interest computed on Libor Funded Amount, exchanged from seller to buyer. The DCF category used is 'DCF-FIX-INT' (DCF All-in-rate interest for Fixed type drawdowns) calculated as follows:
 - Libor Funded amount * (Actual Settlement Date – Expected Settlement Date) * All-in Rate

Where,

Libor Funded amount is the sum of outstanding amount of all the Libor (Fixed) type drawdowns under the CUSIP

All-in Rate = Base rate+ Spread+ Oracle Banking Corporate Lending Margin

Denominator basis is arrived based on the value of *Fee calc Basis*.

- Cost of Carry computed on Prime Funded Amount, exchanged from buyer to seller. The DCF category used is 'DCF-FLT-COC' (DCF Cost of Carry for Floating type drawdowns) calculated as follows:
 - Prime Funded amount on Expected settlement Date(T+7)*Trade Price * (Actual Settlement Date – Expected Settlement Date)* Average Libor Rate/ Denominator basis

Where,

Prime Funded amount on Expected settlement Date (T+7) is the sum of outstanding amount of all the Prime (Float) type drawdowns under the CUSIP on the expected settlement date (T+7)

Average Libor Rate is derived using data from 'Average Libor rate Maintenance' and is calculated from T+7 through settlement date.

- Cost of Carry computed on Libor Funded Amount, exchanged from buyer to seller. The DCF category used is 'DCF-FIX-COC' (DCF Cost of Carry for Fixed type drawdowns) calculated as follows:
 - Libor Funded amount on Expected settlement Date(T+7)*Trade Price * (Actual Settlement Date – Expected Settlement Date)* Average Libor Rate/ Denominator basis

Where,

Libor Funded amount on Expected settlement Date (T+7) is the sum of outstanding amount of all the Libor (Fixed) type drawdowns under the CUSIP on the expected settlement date (T+7)

Average Libor Rate is derived using data from 'Average Libor rate Maintenance' and is calculated from T+7 through settlement date.

6.1.7.2 **DCF on Unfunded Amount**

DCF for the unfunded amount is further sub-divided into different categories and are calculated as explained below:

- Commitment Fee = Commitment Amount * Commitment Fee rate * number of days delay / Fee basis.
The associated fee category is 'DCFCOMM'.
- Utilization Fee = Utilization Amount * Utilization Fee rate * number of days delay / Fee basis
The associated fee category is 'DCFUTILIZ'.
- Facility Fee = Facility Amount * Facility Fee rate * number of days delay / Fee basis
The associated fee category is 'DCFFACILITY'.
- Stand By LC Fee = Stand By LC Amount * Stand By LC Fee rate * number of days delay / Fee basis
The associated fee category is 'DCFSTBYLC'.
- Commercial LC Fee = Commercial LC Amount * Commercial LC Fee rate * number of days delay / Fee basis
The associated fee category is 'DCFCOMMLC'.

These fee components are calculated on their respective drawdown/tranche currencies and are displayed in the 'Funding Memo' screen. You can modify these, if required.

For tranches with drawdowns in multiple currencies, the Interest DCF is summed up for each currency across the drawdowns.

The currency wise fee accounting entries will be posted. The following table shows the basic accounting entries posted for DCF.

Bank is Buyer	Bank is Seller
Dr Trade Counterparty A/c	Dr Expense a/c
Cr Income a/c	Cr Trade Counterparty A/c

You need to capture the LIBOR rate for computing 'Cost of Fund' and 'Cost of Carry' components of delayed compensation fee.

For more details on LIBOR rates, refer the section titled 'Capturing LIBOR Rate Details' in this user manual.

6.1.7.3 Flat Fee Component Maintenance under DCF Categories

DCF flat unrealized components will track the traded portion of unpaid interest / fee amount and DCF flat realized components will track the traded portion of paid interest or fee amount.

DCF Flat Unrealized		DCF Flat Realized	
Category	Purpose	Category	Purpose
F_UNRLZ_INT	To perform accrual based on the interest rate of drawdowns	F_RLZ_INT	To track cash payment of interest
F_UNRLZ_COMFEE	To perform accrual based on rate of commitment fee at tranche level	F_RLZ_COMFEE	To track cash payment of commitment fee
F_UNRLZ_FACFEE	To perform accrual based on rate of facility fee at tranche level	F_RLZ_FACFEE	To track cash payment of facility fee
F_UNRLZ_SLCFEE	To perform accrual based on rate of Stand By LC fee at tranche level	F_RLZ_SLCFEE	To track cash payment of Stand by LC fees
F_UNRLZ_CLCFEE	To perform accrual based on rate of Commercial LC fee at tranche level	F_RLZ_CLCFEE	To track cash payment of Commercial LC fees

The following table shows the basic accounting entries posted for DCF Flat unrealized and Flat realized components:

Bank is Buyer	Bank is Seller
Dr Trade Counterparty A/c	Dr Expense a/c
Cr Income a/c	Cr Trade Counterparty A/c

6.1.7.4 Maintaining DCF Accrual Status Change

In Oracle Banking Corporate Lending, you can maintain preference to reverse/restart a DCF accrual. Based on this maintenance, accrual is carried out for all the active trades associated with the position contract. This can be done through the 'DCF Accrual Status Change' screen. You can invoke the 'DCF Accrual Status Change' screen by typing 'TLDPODCF' in the field at the top right corner of the Application tool bar and clicking on the adjoining arrow button.

The screenshot shows the 'DCF Accrual Status Change' application window. At the top, there is a header with 'New Enter Query' and a 'Version No' field with left and right navigation arrows. Below this is the 'Position Detail' section, which contains several input fields: 'Contract Ref No*' (marked with a red asterisk), 'Expense Code', 'Position Identifier', 'Cusip No', 'Portfolio', and 'Portfolio Description'. Underneath is the 'Accrual Status' section, which includes a 'Stop DCF Accrual' checkbox. The bottom of the window displays a grid of fields: 'Record Status', 'Authorization Status', 'Maker Id', 'Maker Date Stamp', 'Checker Id', and 'Checker Date Stamp'. An 'Exit' button is located in the bottom right corner.

Specify the following details:

Contract Ref No

Specify the position contract reference number. Alternatively, select the position contract reference number from the adjoining option list. The list displays all the values maintained in the system.

Based on the contract reference number selected/ specified, the system displays the following position details:

- Expense Code
- Position Identifier
- Cusip No
- Portfolio

Stop DCF Accrual

Select this check box to indicate that DCF accrual should be stopped.

Note

You can deselect this check box only if the 'Allow Amendment of Non Accrual' box is selected in the Product preferences sub-screen of the 'Secondary Loan Trade – Product Definition' screen.

When this check box is selected or deselected, the system defaults the application date as the Non Accrual Effective date. This date is used to derive the last liquidation date for interest components of drawdown when the associated loan is in performing status.

You can perform the following operations:

- New
- Save
- Unlock
- Delete
- Authorize

Note

- Unauthorized records can be deleted.
 - You can navigate to view the previous records to see when the 'Stop DCF Accrual' box is checked or unchecked.
 - Unauthorized maintenance records appear in the EOD pending query and the system does not allow the Day End Batch to run unless the maintenance is authorized. Also, DCF accrual status is not considered unless the maintenance is authorized
-

6.1.7.5 Accruing Delayed Compensation Fee

Delayed compensation fee is applicable for trades booked under SWOA quotation type, if the trade does not get settled on the expected settlement date. The DCF fee involved in such trades are accrued till the actual settlement date.

Currency-wise accounting entries are posted against each applicable DCF category. You can specify the preferences for DCF accrual in the 'Product Preferences' screen. You need to select the 'Accrual Required' option and specify the 'Accrual Frequency' as daily. You also need to select the 'Allow Amendment of Non Accrual' check box if you want to reverse/restart a DCF accrual. In addition, in the 'Product Fee Details' screen you need to select the check box 'Status Tracking Required'. The reversal or restarting of DCF accrual is based on whether the 'Stop DCF Accrual' box in the 'DCF Accrual Status Change' screen is enabled or disabled

Accrual starts during the EOD on expected settlement date, if the trade settlement does not happen on that date. Further accruals happen as part of the EOD batch. During trade settlement, if you waive off DCF, then all the accrual entries posted gets reversed.

The DCF Accrual batch process can reverse or catch up accrual for DCF components, based on whether the 'Status Tracking Required' box is selected or deselected. The processing is done as part of the EOD on the same day this check box is selected or deselected.

If 'Status Tracking Required' is checked for the trade product, the system checks the DCF accrual status at the associated position contract level.

- If the check box 'Stop DCF Accrual' is selected:

- The system derives the Non-Accrual Effective date and finds the greatest of the contract value date and the last liquidation date for each drawdown before the Non-Accrual Effective date.
- The basis amount for the DCF calculation is considered as '0' from the last liquidation/contract value date before the Non-Accrual Effective date till processing date of the batch.
- If the last liquidation date derived is not the application date, the system reverses the DCF amount which has been accrued from the last liquidation date/contract value date, till processing date - 1 of batch. No accrual is posted for the application date.
- If the check box 'Stop DCF Accrual' is not selected:
 - System derives the latest Non-Accrual Effective date as the application date on which the box 'Stop DCF Accrual' is checked and finds the greatest of the contract value date and the last liquidation date for each drawdown before the latest Non-Accrual Effective date.
 - The basis amount for the DCF calculation is considered as per the functionality when 'Status Tracking Required' is not checked for the trade product, but from the last liquidation date/contract value date before the latest Non-Accrual Effective date.
 - If the last liquidation date derived is not the application date, the system catch-ups the DCF amount from the last liquidation date/contract value date till processing date - 1 of batch. Daily accrual amount is added to the catch-up accrual amount and the total accrual amount is posted for the application date. One FACR event is registered for the catch up accrual till today

During ticket settlement, the system re-calculates the DCF amount and posts catch up accrual.

- If the box 'Stop DCF Accrual' is checked just before settlement and the last liquidation date arrived is not the application date, the system reverses the DCF accrual amount from the last liquidation date/contract value date till the actual settlement date - 1.
- If the box 'Stop DCF Accrual' is unchecked just before settlement and the last liquidation date is not the application date, the system catches-up the DCF amount from the last liquidation date/contract value date till actual settlement date - 1 and post the catch up accrual.

Note

- When the box 'Stop DCF Accrual' is unchecked in later stages, even if there is any interest payment for the loan after the status has been changed to non performing, the system still checks the last interest payment date/value date when contract was in performing status and will perform the catch-up accrual.
 - If you manually amend/specify the DCF amount during settlement, status tracking functionality for DCF accrual does not work. In such cases, catch-up accrual will be done based on the DCF amount specified by you.
-

If 'Status Tracking Required' is not checked for the trade product, the system continues the accrual process for the trade as follows:

- While passing the accounting entries during accrual, delayed compensation fee is calculated as the difference between the accrued value till date and the accrued value till the previous date. Hence, any changes in the outstanding amount or the spread is considered for the current date.

The following example illustrates the accrual of DCF and the corresponding accounting entries involved:

Assume that the Expected Settlement Date is 11-Dec-2006

Remarks	Date	DD LIBOR outstanding	Spread	Accrued amount	Accounting Entry	Balance in Deferred Fee Payable A/c
Accrual entry commences from 11th Dec EOD	11-Dec-06	1,000,000	3.50%	97.22	Dr Int exp - 97.22 Cr Def Fee Payable - 97.22	97.22
Spread is changed on 12-Dec, hence accrual from 12-Dec is computed using the new spread	12-Dec-06	1,000,000	4.00%	111.11	Dr Int exp - 111.11 Cr Def Fee Payable - 111.11	208.33
Payment performed on 13-Dec with VD 12-Dec, hence accrual is recomputed from 12-Dec and entry will be posted for the net amount	13-Dec-06	400,000	4.00%	-22.22	Dr Int exp - (22.22) Cr Def Fee Payable - (22.22)	186.11
Trade Settled on 14-Dec But user updates the Delayed Comp Fee = 190.00	14-Dec-06				FACR Dr Int exp - 3.89 Cr Def Fee Payable - 3.89 TSTL Dr Def Fee Payable - 190.00 Cr Trade Sett A/c - 190.00	0

6.1.8 Specifying Break Fund Fee Details

Break Fund Fee needs to be calculated only when there is a difference in LIBOR Base rate linked to the contract and LIBOR rate existing at the time of transfer. Break fund fee is calculated for the difference in these rates. This fee is settled between the counter party and bank taking into account the increase or decrease in LIBOR rate and the buy or sell attribute of the trade.

Following steps are involved in capturing and processing the break fund fee associated with a trade contract:

1. The break fund fee component is linked to the SLT product in the ‘SLT Product Fee Details’ screen.
2. The main interest component for each drawdown associated with the CUSIP is taken into consideration for calculating break fund fee.
3. Break funding fee for this interest component is computed as follows:

Funded trade amount* (Libor rate quoted- Libor rate on transfer date)*(Next Interest Schedule (rollover) date– Transfer Date) /Denominator basis

Where, Denominator basis is derived based on the value of ‘Fee Calc Basis’.

4. The sum of these amounts for all the drawdowns is taken as the ‘Break Fund’ fee and it gets displayed in the ‘Funding Memo’ screen.

The accounting entries posted for break funding fee is specified below:

Bank is receiving the break funding FEE from Counter Party	Bank is Paying the break funding FEE to Counter Party
Dr Trade Counterparty A/c Cr Income a/c	Dr Expense a/c Cr Trade Counterparty A/c

6.1.9 Specifying Waiver Fee Details

Waiver fee is an adhoc fee paid by the trade counterparty to Bank.

The waiver fee component is linked to the SLT product in the ‘SLT Product Fee Details’ screen. You can specify the waiver fee details in the ‘Fee Components’ screen associated with the contract. You can also specify the waiver fee amount in the ‘Funding Memo’ screen.

6.1.10 Specifying Benefit of Commitment Reduction Fee (BCR) Details

Benefit of Commitment Reduction (BCR) fee is calculated if there is a commitment reduction by the borrower between trade date and the settlement date, inclusive of both the dates. BCR fee is calculated as per the formula given below

$$BCR\ fee = (Principal\ paid\ between\ Trade\ date\ \&\ Settlement\ date) * (1-Price)$$

The following example illustrates BCR fee calculation:

Consider a trade performed on 1st Sept and assume that there is a principal payment on 1st Sept. The payment for 1st Sept is considered for BCR computation.

Note

There is no separate fee definition and settlement for BCR fee.

6.1.11 Specifying Upfront Fee Details

Upfront fee is collected for the undrawn amount of the trade. Upfront fee is calculated as follows.

Upfront fee = Unfunded Amount * (1-Price)

Note

There is no separate fee definition and settlement for upfront fee.

6.1.12 Specifying Adhoc Fee Details

Two types of adhoc fees are available to account for any adhoc fee exchanges that happen between the buyer and the seller. They are as follows:

- Adhoc Buyer Fee - paid by the buyer to the seller
- Adhoc Seller Fee - paid by the seller to the buyer

The fee types are linked to the SLT product in the 'SLT Product Fee Details' screen. The adhoc fee details for the contract are specified in the 'Fee Components' screen associated with the contract.

6.1.13 Specifying Brokerage Details

Secondary loan trading can involve brokers who charge a commission fee for their brokerage services. Brokerage is always calculated on the original trade amount. Any amendment in the trade amount as a result of commitment reduction does not affect the calculation of broker's commission, as it is calculated on the initial trade amount.

For line trades involving the origination desk, brokerage is applicable only for the Origination sell line trade and not for the other two Par trades linked to the line trade.

Following steps are involved in capturing and processing the brokerage fee associated with a trade contract:

1. Broker Id of the broker involved in the trade is captured in the 'Draft Trade' screen, while booking the SLT contract.
2. The brokerage fee component gets linked to the SLT product in the 'SLT Product Fee Details' screen.
3. The brokerage fee type, rate, and the fee amount are captured in the 'Fee Components' screen associated with the contract.
4. The brokerage fee gets displayed in the 'Funding Memo' screen, where it can be waived off, if required. You can waive off this fee in the 'Draft Trade' screen or 'Fee Amendment' screen also.

The accounting entries posted for brokerage as part of trade settlement or fee liquidation is specified below.

Dr	Expense A/c	Brokerage Amount
Cr	Brokerage Payable A/c	Brokerage Amount

The actual liquidation of brokerage is handled by the Brokerage module.

For more details on brokerage liquidation refer the section titled 'Liquidating Brokerage Manually' in Brokerage user manual.

6.2 Amending Fee Details

You can amend the fee details for the various components in the 'SLT Fee Amendment' screen.

You can invoke the 'TL Fee Amendment' screen by typing 'TLDFEAMD' in the field at the top right corner of the Application tool bar and clicking the adjoining arrow button.

The basic trade details are defaulted here. You can specify the following details for fee amendment:

Fee Amount

The fee amount associated with each fee component is listed here. You can modify the fee amount specified.

You can modify the amounts specified for Assignment Fee, Amendment Fee, Broker Fee, Waiver Fee, and Adhoc Fee. For DCF and Break-fund fee you can only modify the Fee Calc Basis and Fee Basis, but not the fee amount.

Waiver

Select this check box to indicate that you wish to waive off a fee component during fee amendment.

Note

You cannot waive off DCF during amendment. DCF can be waived only at Trade level.

Fee Calc Basis

The fee calculation basis associated with the contract is defaulted here. You can modify this, if required. Select the fee calculation basis from the following options:

- Agency - Fee Basis is arrived from LB Module for the respective component
- SLT – Fee Basis needs to be manually specified at the SLT product or contract level

This is enabled only for fee types 'DCF' and 'Break-fund Fee'.

Fee Basis

The fee basis associated with the contract is defaulted here. You can modify this, if required. Select the fee basis from the following options:

- 30(Euro)/360
- 30(US)/360
- Actual/360
- 30(Euro)/365
- 30(US)/365
- Actual/365
- 30(Euro)/Actual
- 30(US)/Actual
- Actual/Actual
- 30(Euro)/365.25
- 30(US)/365.25
- Actual/365.25
- Working Days/360

This gets enabled only if you have selected the fee calculation basis as 'SLT'.

For more information on fee basis, refer to Charges and Fees User Manual.

Assignment Fee Details

The assignment fee details associated with the contract are displayed here. You can modify the following details, if required.

Buyer's Split Amount

Specify the assignment fee amount that has to be booked against the buyer associated with the trade deal.

Seller's Split Amount

Specify the assignment fee amount that has to be booked against the seller associated with the trade deal.

You can amend the fee details before it gets liquidated. But for Amendment Fee and Broker Fee, amendment can be performed even after liquidation, though they are settled as part of trade settlement. In this case, the difference in the fee is posted as fee adjustment.

Broker fee payable booking happens during trade booking/trade amendment where in the brokerage fee is moved from expense to payable GL. Broker fee payable booking is zero-based on every amendment, thereby reversing the earlier payable booking and rebooking with the revised broker fees as part of the trade amendment. Broker fee payable liquidation happens only after the trade/ticket is settled successfully.

For more details on brokerage liquidation, refer section 'Liquidating Brokerage Manually' in the Brokerage User Manual.

Example

The following example explains the payable booking accounting entries during trade booking/ amendment:

	Action	OBCL Process	OBCL Event
Case 1	Trade booking with Broker amount of \$50,000	Debit expense GL for \$ 50,000 Credit payable GL for \$ 50,000	TBOK
Case 2	Trade booked without Broker amount and then Trade amendment with broker amount of \$50,000	Debit expense GL for \$ 50,000 Credit payable GL for \$ 50,000	TAMD
Case 3	Trade booking with Broker amount of \$40,000	Debit expense GL for \$ 40,000 Credit payable GL for \$ 40,000	TBOK
	Trade amendment with Broker amount of \$50,000	Reverse the existing entries Credit expense GL for \$40,000 Debit payable GL for \$40,000 Rebooking with the latest amount Debit expense GL for \$ 50,000 Credit payable GL for \$ 50,000	TAMD

Case 4	Trade booking with Broker amount of \$50,000	Debit expense GL for \$ 50,000 Credit payable GL for \$ 50,000	TBOK
	Trade amendment with Broker amount of \$50,000	No entries	TAMD

In all the above cases, the final amount of \$50,000 in payable is used for final payable liquidation for the trade. If any trade is reversed and rebooked systematically due to trade amendment, then the payable booking is cancelled on the old trade and re-applied on the new trade.

If Funding Memo was generated in advance and the fee components are amended before trade settlement, the funding memo gets regenerated.

6.2.1 Viewing Event Details

You can view the event details maintained in the 'User Defined Events' screen under 'Events' screen of a contract screen. You can invoke the 'Events' screen by typing 'OLDEVENT' in the field at the top right corner of the Application tool bar and clicking on the adjoining arrow button.

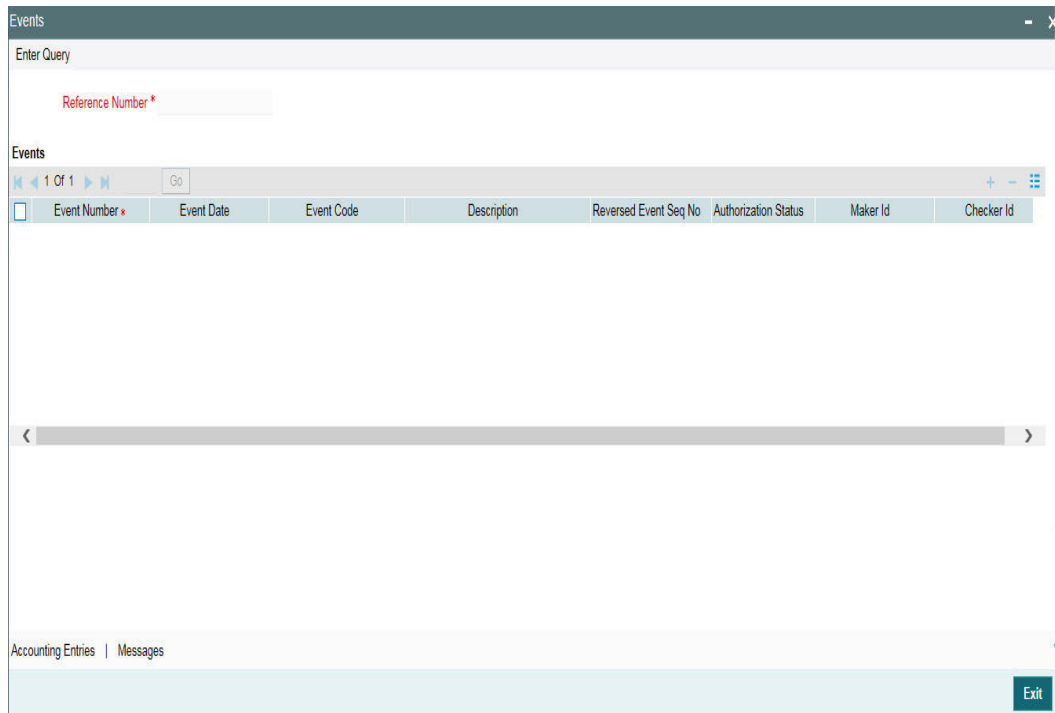

Reference Number

Specify the reference number.

The system displays the following details:

- Event Number
- Event code
- Description

- Event Date
- Authorization Status
- Maker Id
- Checker Id

Viewing Accounting Entries

You can view the accounting entries maintained for an event in the 'Accounting Entries' screen by selecting an event and clicking on 'Accounting Entries' button in the 'Events' screen. To invoke the screen type 'OLDACENT' in the field at the top right corner of the Application tool bar and clicking on the adjoining arrow button.

Reference Number

Specify the transaction reference number

See Position Entries

Check this box to view currency position of the entries.

Event

Specify the event.

Event Number

The system displays the event number.

The following details are displayed in the Accounting Entries:

- Event
- Branch
- Account
- Account Description
- Dr/Cr
- Amount Tag
- Account Ccy
- Foreign Currency Amount
- Rate
- Local Currency Amount
- Date
- Value Date
- Txn Code

The following details are displayed in the Accounting Under Process:

- Event
- Branch
- Account
- Dr/Cr
- Amount Tag
- Account Ccy
- Foreign Currency Amount
- Rate
- Local Currency Amount

- Date
- Value Date
- Txn Code

Override Details

Click on 'Overrides' button to view the override details of the accounting entries.

Accounting Entries

Execute Query

Reference Number *

Event Number *

Event * undefined

Accounting Entries **Overrides**

Overrides

1 Of 1 Go

Overrides	Override Status	Authorized By	Auth Date Stamp
-----------	-----------------	---------------	-----------------

Viewing Messages

You can view the messages by selecting an event and clicking on 'Messages' button in the 'Events' screen. To invoke the screen type 'OLDMSGVW' in the field at the top right corner of the Application tool bar and clicking on the adjoining arrow button.

Advice Message

Enter Query

Contract Reference * _____ ESN * _____ Event _____

Messages

<< 1 Of 1 >> Go

<input type="checkbox"/>	Message Type	SWIFT Message Type	Medium	Message Status	Authorization Status	Receiver	Receiver Name	DCN

Message Details

The system displays the following details:

- Contract Reference
- ESN
- Event
- Message Type
- SWIFT Message Type
- Medium
- Message Status
- Authorization Status
- Receiver
- Receiver Name
- DCN

Message Details

You can view the details of a message by selecting a message from the 'Message' screen and clicking on 'Message Details' button.

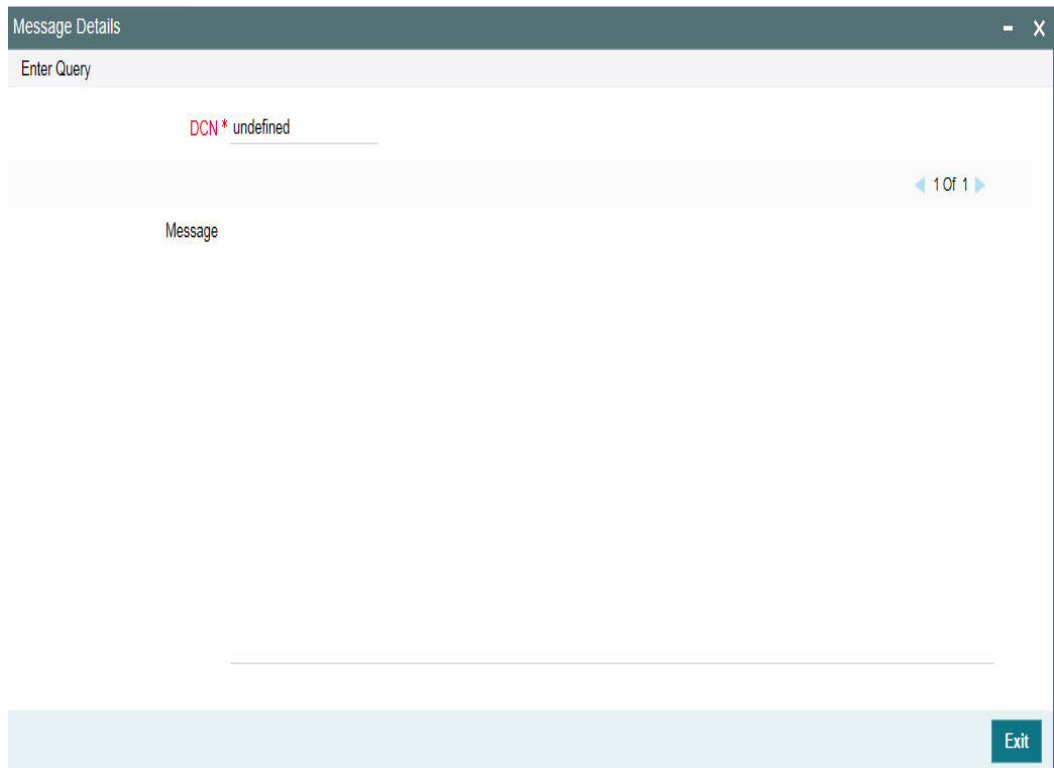

6.3 Liquidating Fee Components

You can liquidate the Brokerage Fee and Amendment Fee components, post trade settlement, in the 'SLT Fee Liquidation' screen. You can invoke the 'Liquidation' screen by typing 'TLDFEELQ' in the field at the top right corner of the Application tool bar and clicking on the adjoining arrow button.

The basic trade details are defaulted in this screen. You can specify the following details in this screen:

Value Date

The current system date gets defaulted as the value date for the liquidation.

Liquidate

Select this check box against 'Amendment Fee' or 'Broker Fee' to liquidate the corresponding fee component.

Note

- You cannot liquidate the fee components manually, before trade settlement.
 - You cannot liquidate the fee components partially.
-

6.3.1 DCF Flat Unrealized Liquidation

DCF flat realized components are settled during trade/ticket settlement to settle the trade portion of interest / fee payment amount. If interest / fee payment is processed in LB module after the trade is settled then the corresponding payment amount can be settled from the screen 'DCF Flat Unrealized Liquidation'

You can invoke the 'DCF Flat Unrealized Liquidation' screen by typing 'TLDDCFLQ' in the field at the top right corner of the Application tool bar and clicking on the adjoining arrow button.

You can perform payment for the trade counterparty under tranche reference number for cash fee payment and under drawdown reference number for cash interest payment.

Agency Ref No

Specify the drawdown or Tranche reference number from the adjacent list of values.

Payment Date

Specify the payment value date.

Counterparty

Select the counterparty from the adjacent list of values.

SSI Mnemonic

Select the SSI from the adjacent list of values.

On click of 'Populate' button, the system generates the Liquidation reference number which will be unique for the combination of contract reference number (drawdown/tranche reference) and counterparty. The system defaults the same liquidation reference number if payment is performed multiple times for the same combination of agency reference number and counterparty. The system displays all the settled trades for the combination of Drawdown/Tranche CUSIP and trade counterparty.

Component(s) gets defaulted with outstanding interest / fee accrued (amount due) in the 'Component Details' section.

You can choose the components for which the payment to be processed by selecting the check box against each component. It is not mandatory to settle all the components together but at least one component should be selected for payment. By default, the check box are not selected while populating the components.

You can specify the amount paid for each component which should be lesser than or equal to amount due. Amount paid can be zero for the components which are not selected for the liquidation. Liquidation of DCF flat unrealized components can be partial or full.

Click 'Sum' button to sum up the amount paid across all the components and currency and populate the total amount payable.

Payment message gets generated under liquidation reference number for the total amount payable (if bank have to pay to the counterparty). To compute total amount payable, paid amount is considered positive for sell trade and negative for buy trade. If total amount payable is negative then bank receives the payment else bank pays the amount to counterparty.

During DCF flat unrealized liquidation for drawdowns, If trade currency is different than the drawdown currency then accounting entries for trade are posted by appending currency with amount tag (only in case of foreign currency Drawdowns).

Settlement pick is based on counterparty and currency combination and the settlement instructions are used to post accounting entries for trade reference number.

You can suppress the advice in 'Advice Details' sub-screen that is launched on click of 'Advice' button.

Deletion of DCF flat liquidation deletes the DCLQ event and accounting entries for the trade reference number.

6.3.2 Trade Settlement Threshold Limit

You can maintain threshold limit for the fee components such as DCF, CoC and amendment fee for a product and currency combination.

The screenshot displays the 'Trade Settlement Threshold Limit' application interface. It features a title bar at the top, followed by a navigation bar with 'New' and 'Enter Query' buttons. The main content area is divided into two sections: 'Product Details' and 'Component Details'. The 'Product Details' section includes input fields for 'Product Code *', 'Currency *', 'Product Description', and 'Currency Name', along with a 'Populate Components' button. The 'Component Details' section contains a 'Threshold Limit for All Components' input field. At the bottom of the screen, there is a pagination bar showing '1 Of 1' and a 'Go' button, and a table with columns 'Component' and 'Threshold Limit'.

You can invoke the 'Trade Settlement Threshold Limit' screen by typing 'TLDCFTOL' in the field at the top right corner of the Application tool bar and clicking on the adjoining arrow button.

Product Code

Displays all the 'Active' and 'Authorized' of SLT products. You can select from the LOV.

Currency

Displays all the currencies which are available for the SLT product selected. You can select from the LOV.

Populate Components

Click 'Populate Components' to get the fee components which are available for a product.

Threshold Limit for All Components

You can enter a value in this field and click on the tab, the entered value is defaulted to all the fee components populated. If required you can modify the defaulted value for each individual component.

Component

The DCF fee and amendment fee components available for the SLT product selected are displayed in this field once you click on the 'P' button.

Note

The fee component for DCF interest comprises the fee amounts for DCF fixed interest, DCF floating interest and DCF fixed margin.

Threshold Limit

If you do not want to define threshold limit for a component, you can enter zero. You cannot enter negative value. You can enter more than 4 digits.

7. Interface between SLT and LB modules

This chapter contains the following sections:

- [Section 7.1, "Introduction"](#)
- [Section 7.2, "Deals Originated by Bank"](#)
- [Section 7.3, "Deals where Bank is not Lead Agent "](#)
- [Section 7.4, "Viewing Multiple Firm Account"](#)
- [Section 7.5, "Viewing Referential Data from Secure"](#)
- [Section 7.6, "Viewing the External Agency Interface Browser"](#)
- [Section 7.7, "Matching Process and Manual Linkage of SLT and Markit Trades"](#)
- [Section 7.8, "Settlement Queue for Markit Trades"](#)
- [Section 7.9, "Viewing LQT Mnemonic Browser Details"](#)

7.1 Introduction

The data captured in the SLT module needs to be passed on to the LB module which in turn interfaces with the OL module for processing the trade details and updating positions accordingly.

Different scenarios are possible where data needs to be exchanged between SLT and LB modules. The most common scenarios where data exchange takes place are explained in the subsequent sections.

7.2 Deals Originated by Bank

All deals having bank as the lead agent is captured initially in the LB module. The following activities are involved in this scenario:

1. Trade transaction originates in LB module.

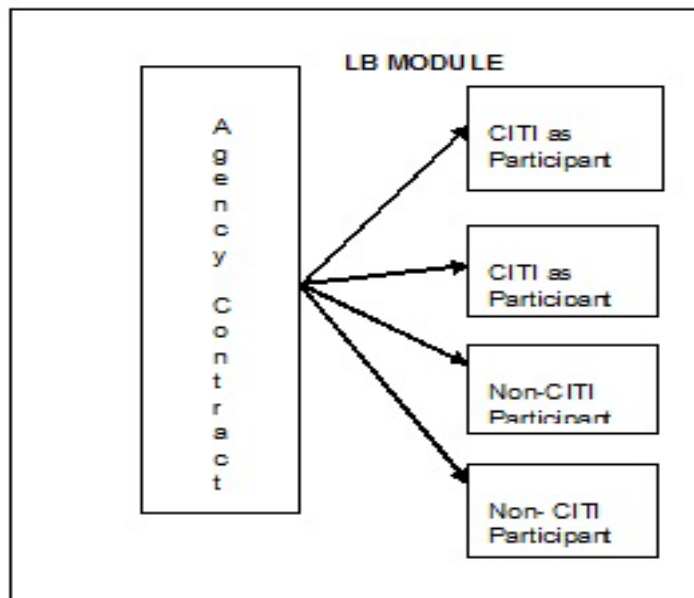

A trade contract is initiated in the SLT module origination desk, once the transaction in LB module gets authorized.

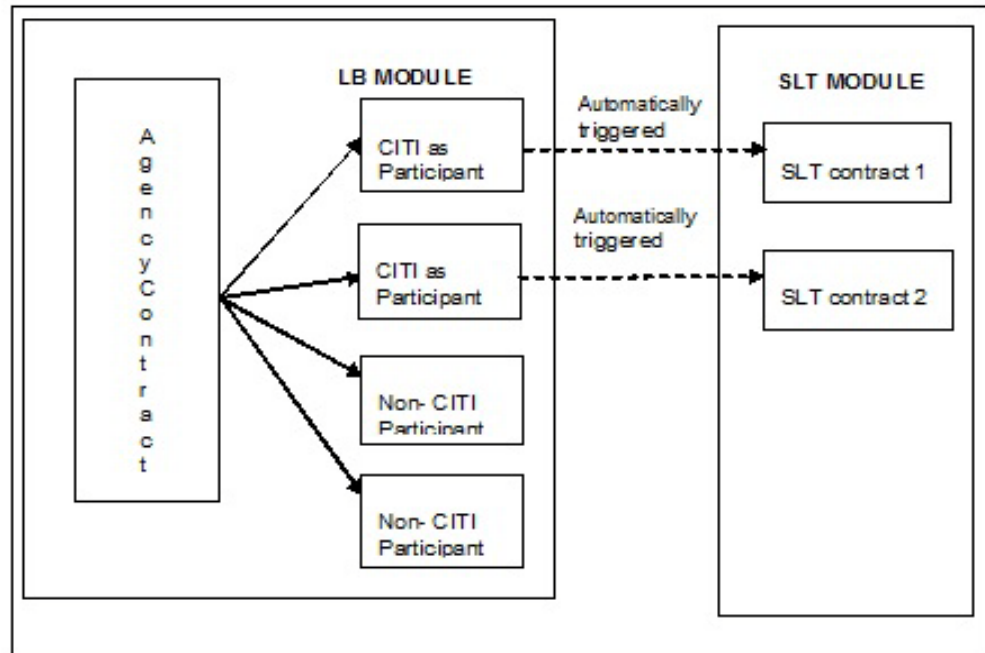

Internal contracts are created in SLT module for the purpose of updating positions and computing WAC for Originations desks. Internal trade contracts are created with settlement days as zero. Hence, the trade date and settlement date are the same for such contracts.

Fees are not collected for these contracts and also no accounting entries are posted since the accounting entries would have already been posted in the LB module.

For a future value dated tranche booked in the LB module, the corresponding SLT contract gets created on the value date of the tranche. You cannot perform any amendment or reversal on these SLT contracts.

Events like participant transfer in the LB module does not have a corresponding action/event happening in SLT module. If a tranche gets cancelled in the LB module, a warning message is displayed that there are active contracts in SLT module.

This section contains the following topics:

- [Section 7.2.1, "Viewing LB Handoff Details"](#)
- [Section 7.2.2, "Future Buy/Sell Deal with Bank as Lead Agent"](#)
- [Section 7.2.3, "Participation Sell where Bank as Lead Agent"](#)

7.2.1 Viewing LB Handoff Details

You can view the status of the hand-offs from LB to the SLT module in the 'LB-TL Interface Browser' screen. You can invoke the 'LB-TL Interface Browser' screen by typing 'LBDSLTI B' in the field at the top right corner of the Application tool bar and clicking on the adjoining arrow button.

The screenshot shows the 'LS-LT Interface' window. At the top is a header 'Enter Query'. Below it are two columns of input fields. The left column includes: Borrower Reference Number*, Participant Reference Number*, Ccy, Processing Date, Trade/TRN Ref No, Self Participant, Desk, and Cusip No. The right column includes: Event Seq No*, Process Seq No*, Event Code, Ext Trade Ref No, Processing Status (a dropdown menu), Branch, and Expense Code. Below the form is an 'Error Log' section with a table header containing 'Error Seq No' and 'Message'. At the bottom of the interface are fields for 'Maker', 'Checker', 'Date Time:', 'Mod No', 'Record Status', and 'Authorization Status', along with an 'Exit' button.

Following details are displayed in this screen:

- Borrower contract details like the contract reference number, currency, event sequence number, and event code
- Participant contract details like the contract reference number and processing date
- Corresponding SLT contract details like the external trade reference number, trade reference number and processing status

The processing status can have any of the following values:

- Extracted – indicating that handoff has failed
- Handoff – indicating successful handoff
- Failed - failed to create SLT trade from upload
- Reprocess – selected for reprocessing
- Processed - successfully created SLT trade from upload

You can unlock the 'Failed' records and change the processing status to 'Reprocess' to select the contract for re-processing. Once the details are saved and authorized, the status in LT upload table changes to 'Submit' for the record marked for 'Reprocess' in the Interface Browser screen. The records with 'Submit' status are picked up by SLT job to create the trade contracts.

Note

You can view the errors associated with a contract. The PRAM/NP VAMI gets fired internally for each of the underlying drawdown for both Pro-rata and Non Pro-rata tranches where the seller is the active participant.

If the bank is non - lead agent, external (non-bank) parties are allowed in the non-lead agency contract. This is applicable only for participation type of trades. PRAM is triggered on the non-lead agency contract to transfer the participation amount from bank entity to the buyer.

7.2.1.1 Processing in LB-TLT Interface Browser

PRAM for HFS transfer is updated into the LB-TL interface Browser. Two records are updated in the browser - one each for HFI and HFS portfolios. Transfer price is stored internally to compute HFS Transferred Cost Basis while processing internal trades in trading module. Note that the expense code should be unique for the combination of CUSIP and HFS/HFI portfolio.

The expense code is resolved from the associated commitment contract for the HFI originated internal trade and HFS originated internal trade. During HFS Transfer, expense code of HFI internal sell trade is defaulted to the HFS internal buy trade. If expense code is not resolved for the HFI trade and more than one expense code are mapped with the HFS portfolio, then you have to manually enrich the expense code in the LB-TL Interface Browser.

The expense code for HFS portfolio is same as the expense code mapped for the HFI portfolio, during HFI to HFS transfer under a CUSIP. Hence the expense code for the HFS internal buy trade is picked up from the associated internal HFI sell trade systematically. Processing status is 'Handoff' if all the details are resolved. The LB-TL job picks up and process the trades. However, this job does not process the HFS internal buy trade if commitment is not linked to the HFS participant (using the 'STP Relink' screen). The system logs an appropriate error message for not processing the trade. Commitment is required to upload Transfer Marks as an Amort fee during HFS internal buy trade processing.

In order to update the position, the system creates two trades - one internal sell trade to reduce the HFI position and one internal buy trade to create/update the HFS position. Both internal trades are booked and settled systematically. If HFS Buy trade fails in the LB-TL browser, then subsequent trade processing for the HFI or HFS portfolio under the CUSIP fails in the draft layer if the HFS position is not enough to cover the sale amount. This ensures that HFS position (in failed) is settled first prior to HFI position.

PRAM to reverse the HFS transfer is not updated in the browser. You have to manually reverse the internal trades after reversing the HFS transfer in agency as part of PRAM. New PRAM after the reversal is updated in the browser and internal trades are processed as explained above.

If there is no position in the HFI portfolio in trading module while processing the PRAM event from the browser, then trade processing fails for both buy and sell trades and the processing status is updated as 'Failed' with an appropriate exception message. You have to update the balances manually in the trading module and reprocess the PRAM event in the browser to process the internal trades.

The system does not validate commitment/loan/CoC balances from the origination module during internal trade processing. It performs validations during PRAM and these origination balances are stored for internal trade processing during HFS transfer (PRAM) in LB module.

Note

The aforementioned functionality is applicable to bank originated deals as well as deals where bank is not the lead agent.

7.2.1.2 Handing off Contracts for Reprocessing

You can repeat the handoff-for the contracts in 'Extracted' status in the LB-TL Interface Browser screen. 'Extracted' status indicates that the contracts have not been handed-off properly.

You can re-run the handoff for such contracts in the 'SLT Handoff Rerun' screen. You can invoke the 'SLT Handoff Rerun' screen by typing 'LBDLTHOF' in the field at the top right corner of the Application tool bar and clicking on the adjoining arrow button.

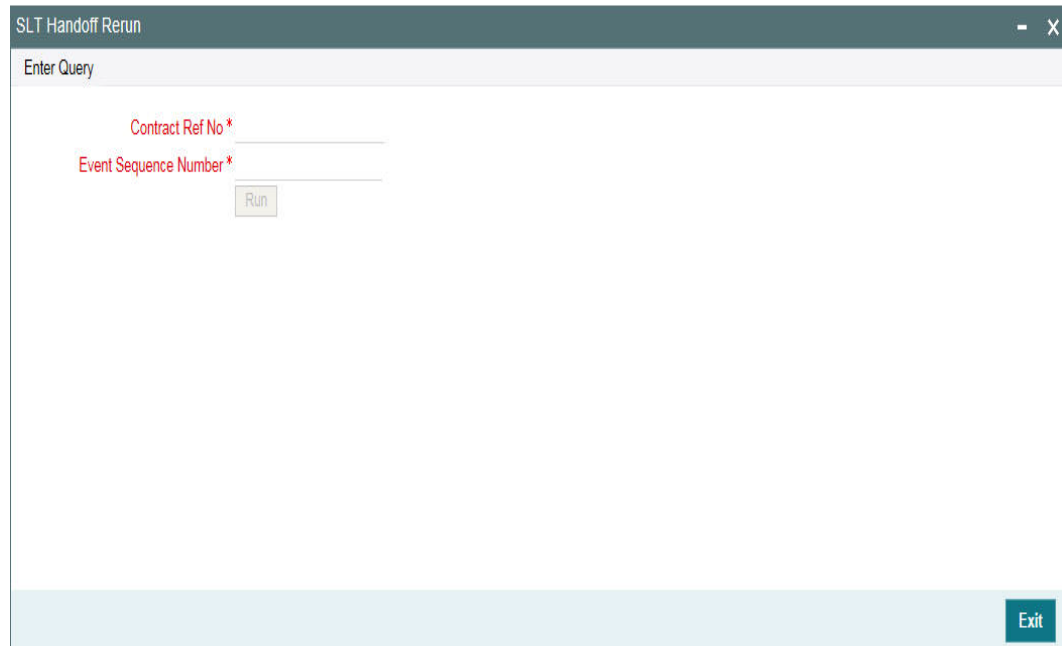

In this screen, you can re-process the handoffs that have failed by selecting the borrower contract reference number and borrower event sequence number of the contract for which handoff should be repeated.

You need to specify the following details here:

Contract Reference No.

Select the contract for which you wish to repeat the handoff process. All contracts in 'Extracted' status in the 'LB-TL Interface Browser' screen are displayed here.

Event Sequence No.

Select the event sequence number associated with the contract selected.

Click 'Run' to handoff the details of the selected contract.

7.2.2 Future Buy/Sell Deal with Bank as Lead Agent

When a sell deal is captured in SLT module, the system checks if a CUSIP corresponding to the Branch-Desk-Expense Code combination exists in the LB module.

When the deal is settled and authorized in SLT, the transaction details flow to the LB module which in turn initiates a participant transfer event in the LB module.

Note

You can perform settlements in the LB module only if CUSIP exists for the branch/desk/expense code combination.

The following diagram illustrates this scenario:

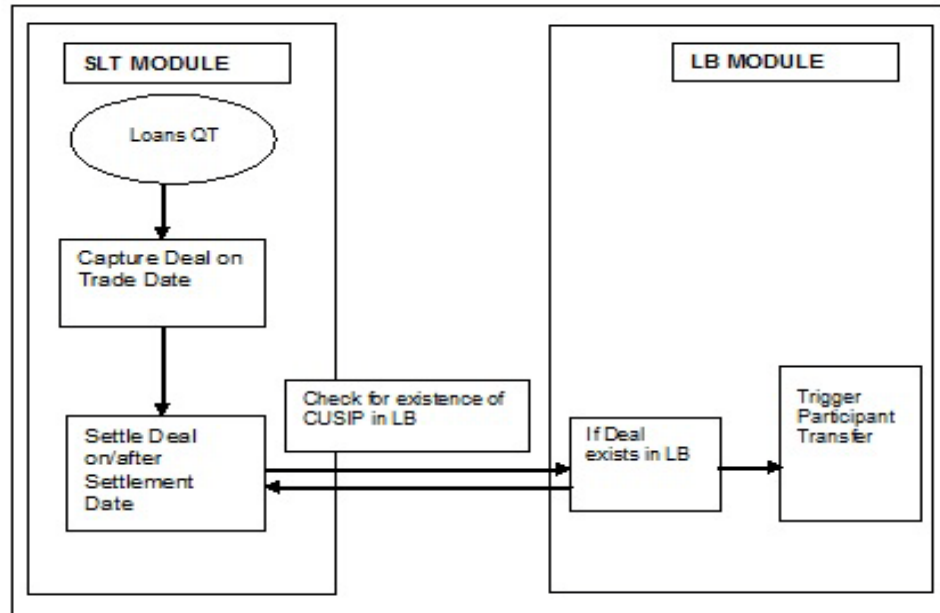

7.2.3 Participation Sell where Bank as Lead Agent

As part of STP processing from agency to agency wrapper, a new wrapper contract is created with the sell participation trade amount as on the sell participation settlement date for the first participation sell trade.

For a first time participation sell for a CUSIP, bank selling to external counterparty, system creates an agency wrapper tranche with the following inputs:

- The buyer of the Participation as the participant
- The trade amount as on the Participation sell settlement date as the Tranche amount.

It also creates a new facility contract for the Agency Facility amount where the Facility start date and end date is same as the agency facility start and end dates.

You have to maintain the product details to map the agency product to wrapper product. Otherwise, the agency wrapper contract uses the same product and expense code as of the main agency contract for Facility/Tranche/Drawdown.

Following details are displayed in TLS- LB Interface Browser (TLDLIFB) screen:

TLS-LB Interface Browser Detailed

Enter Query

LT Details

Trade/Tm Ref No * _____ CUSIP/ISIN * _____
 ESN * _____ Trade Source _____
 Value Date _____

Agency details | Exception Details | Transfer Details

Contract Reference No _____ Event Code _____
 Processing Status Processing Date _____

Ticket ID _____ Position Identifier _____
 Expense Code _____

Desk code _____ Branch _____
 Deal Type _____

Maker	Date Time:	Mod No	Record Status	<input type="button" value="Exit"/>
Checker	Date Time:		Authorization Status	

- Agency details like the agency reference number, currency, event sequence number, and event code
- Participant contract details like the contract reference number and processing date
- Corresponding agency wrapper details like the wrapper reference number, event sequence number, event code, expense code, product code, and processing status

During LB-wrapper Handoff, the processing status can have any of the following values:

- Extracted – indicating that handoff has not yet started
- Handoff – indicating that handoff is in progress
- Failed – Indicates that Handoff has been failed due to error which can be viewed in error log
- Processed - Indicates that Handoff has been successful
- Reprocess – Indicates the handoff has been marked for reprocess for the specified trade after doing the necessary correction at agency level

Using this screen, you can unlock the failed record and change the processing status from 'Failed' to 'Reprocess' and save for ones which have failed during Agency to wrapper handoff.

You can unlock the failed record and click 'Mark Handoff' to change the processing status from 'Failed' to 'Handoff'. This is applicable only for failed records.

You can view the exception log associated with a contract by using the 'Exception Details' section.

If the agency wrapper contract for the Silent participant and CUSIP combination is available with a positive tranche balance, then STP of the PRAM from the agency contract will be done

to the agency wrapper contract as a NPVAMI to increase the wrapper contract amount and add the buyer/increase the pro-rata share for the buyer of the silent sell participation.

Settlement party for the agency wrapper contract is the Silent participant id that has been used for the Trade processing in the Agency contract.

The STP processes are as follows:

- If the wrapper contract is not available, the system creates a drawdown contract, in addition to the wrapper tranche, under the agency wrapper for each of the active drawdown. The drawdown amount is the outstanding amount as per the pro rata share of the sell participation trade amount in the main drawdown as on the date of the participation sell.
- If there is any current dated principal payment/repayment on the agency drawdown contract, STP of principal payment is done on the agency drawdown wrapper contract. If the principal and interest are paid as part of single payment at drawdown level, only the principal payment is STPed to the wrapper contract and interest payment is handled manually
- If there are any current dated VAMI on drawdown and agency Tranche, STP of those events are done to the agency wrapper contract. Value dated amendment of amount change and maturity change is handled.
- If there are any future dated VAMI in the drawdown and agency tranche, the corresponding VAMI event is handed off to wrapper during the batch processing on the value date of the VAMI.
- If there are any back-dated activities beyond any other activity and other events, STP is not handled. Only STP of normal back-valued (which is not beyond any activity) is done to wrapper contract.

Before processing the STP to the wrapper, system performs the basic contract balance (Principal) validations. In case of any exceptions, system does not proceed and the event is in 'Failed' status. No validation is done for interest/fees.

Events prior to the current event of the same contract should be in processed status.

If there is any subsequent Participation sell after all the participations are elevated, you need to manually update the position in the existing wrapper contract by initiating the NP VAMI for the new trade amount at the tranche level and NP VAMI at the drawdown level based on the pro-rata share of the drawdown in the tranche.

If there are any subsequent sell Participation trade with the same external counterparty or with new external counterparty, system triggers Non pro rata VAMI to increase the wrapper contract amount on the wrapper tranche and wrapper drawdown.

7.3 Deals where Bank is not Lead Agent

For deals captured in the SLT module where bank is not the Agent also you need to capture the trade details in the LB module. On settlement date, system checks if the CUSIP for the branch/desk/expense code combination exists in LB. If the CUSIP does not exist, you need to upload the funding memo details in the predefined format.

For a first time buy, the CUSIP does not exist in the agency and the hence you need to create the agency contract corresponding to the trade that happens in SLT. In this agency contract that gets created in LB, the participant involved is the desk handling the buy trade in SLT. The participation percentage is taken to be 100% in this case.

When there is a subsequent trade deal related to the same CUSIP, the contract amounts are updated appropriately, as the contract already exists in LB.

The following diagram illustrates this scenario:

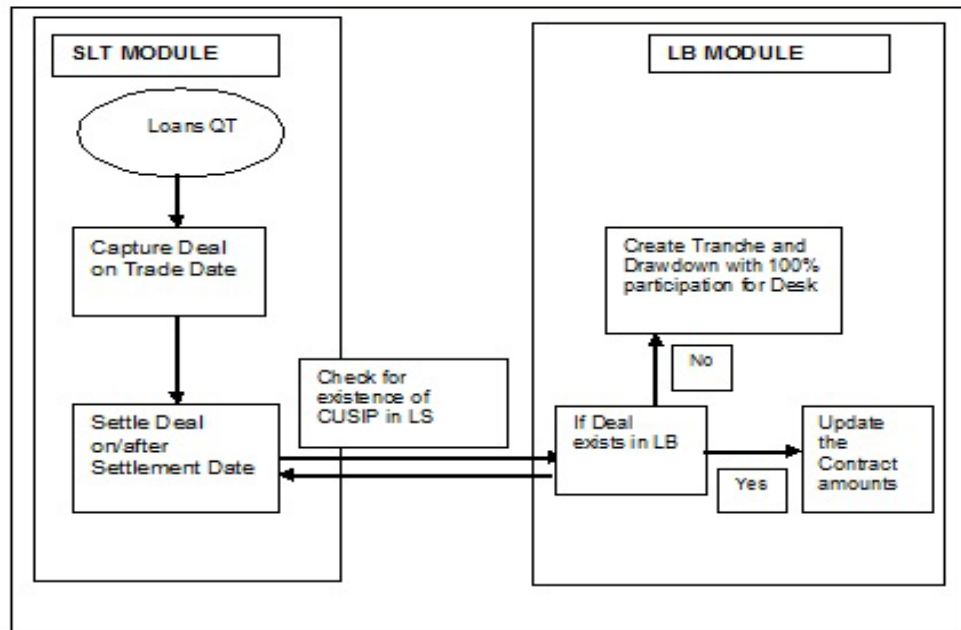

The following example demonstrates the contracts that are created in LB, in this scenario:

Example

Let us assume that on Day 1, a purchase of 100mn happens for a CUSIP, on behalf of Desk1 (in Branch Br001).

On the settlement date, in LB module, a tranche for 100mn gets created in Branch 001. A Participant contract also created with Desk1 as the participant with 100% participation.

Assume a second trade on Day 10, where 200mn of the same CUSIP is purchased on behalf of Desk2 (in Branch Br002).

On the settlement date of this trade,

The existing tranche maintained in Branch (Br001) is updated to 300mn.

A new Participant contract for Desk 2 for 200mn is created.

The ratio of the participants would be changed as follows: -

- Desk 1(Ratio 33.33%)
- Desk 2(Ratio 66.66%)

This section contains the following topics:

- [Section 7.3.1, "Handing-off Commitment Reduction Details"](#)
- [Section 7.3.2, "Viewing LQT Trade Browser Details"](#)

7.3.0.1 Viewing SLT Handoff Details

You can view the status of the hand-offs from SLT to the LB module in the 'SLT-LB Interface Browser' screen. You can invoke the 'TLS-LB Interface Browser' screen by typing 'TLDLDFB'

in the field at the top right corner of the Application tool bar and clicking on the adjoining arrow button.

The screenshot shows a web application window titled "TLS-LB Interface Browser Detailed". At the top, there is a search bar labeled "Enter Query". Below it, the "LT Details" section contains several input fields: "Trade/Tm Ref No *", "ESN *", "Value Date", "CUSIP/ISIN *", and "Trade Source". A tabbed interface below these fields has three tabs: "Agency details" (which is selected), "Exception Details", and "Transfer Details". The "Agency details" section includes fields for "Contract Reference No", "Processing Status" (with a dropdown menu), "Event Code", "Processing Date", "Ticket ID", "Position Identifier", "Expense Code", "Desk code", "Branch", and "Deal Type". There are two buttons, "Reprocess" and "Mark Handoff", located below the "Deal Type" field. At the bottom of the window, there is a summary section with fields for "Maker", "Date Time:", "Mod No", "Record Status", "Checker", "Date Time:", and "Authorization Status". An "Exit" button is located in the bottom right corner of this section.

Following details are displayed in this screen:

- SLT trade details like the trade reference number, event sequence number, settlement date, counterparty, ticket id, and buy/sell indicator.
- Corresponding agency contract details like contract reference number, processing date, event code and the processing status

The processing status can have any of the following values:

- Extraction – indicates that the upload tables to initiate appropriate events on agency contract, have not been populated successfully
- Handoff - indicates that the upload tables to initiate appropriate events on agency contract, have been populated successfully
- Failure - indicates that upload tables have been populated but event at agency has failed to execute, due to some error
- Processed - indicates that the SLT-LB handoff has been successful
- Reprocess - indicates that the handoff has been marked for reprocess after the necessary corrections at agency level
- Mark Handoff - You can unlock the failed record and click 'Mark Handoff' to change the processing status from 'Failed' to 'Handoff'. This is applicable only for failed records.

NoteThe agency contracts having status 'Handoff' or 'Reprocess are taken up for further processing as a background job process. For contracts in 'Extraction' status, you need to

make corrective actions according to the exception log that is displayed. You can view the exception log associated with the contract.

While processing, the system checks if the trade is a Pro-rata tranches or Non Pro-rata tranches. Then the system arrive the drawdown PRAM/ NP VAMI amounts based on the following:

- pro-rata basis (for pro-rata tranches)
 - buyer's share for the individual drawdowns (for the non pro-rata tranches)
-

The PRAM/NP VAMI amount for a Tranche/DD is Buyer's share amount available in 'Agency Details Input' screen.

After making necessary corrections, you need to unlock the concerned record in the 'SLT-LB Interface Browser' screen and change the status to 'Processed'.

For contracts in 'Failed' status, you need to make the necessary corrections in LB and then update the status in the browser screen as 'Reprocess'.

Note

For inter-desk trades, SLT to LB handoff will be done only for buy trades.

7.3.0.2 Processing of TL-LB

The status of the handoffs from SLT to LB module is viewed in 'SLT-LB Interface browser'. The SLT trade details and corresponding events on the agency contract are displayed in this screen

In the TL-LB processing, the following process happens after the drawdown details have been captured in the funding memo and when the settlement is captured:

- The Non Prorata -VAMI is performed on the tranche and drawdown. This is created as per the details mentioned in the funding memo for the Trade T1
- The Non Prorata-VAMI is performed on the tranche and as well as the drawdown for Trade T2 as per the details mentioned in the funding memo for trade T2
- In case the TL-LB browser processes the trade T2 first, then the Non Prorata-VAMI is performed on the tranche and drawdown is created. As part of T1, Non Prorata-VAMI is performed on the tranche and the drawdown is as per the details captured in the funding memo for trade T1.

In the 'TL-LB job browser', the drawdown which has created as part of the first trade and the second trade is in the failed status. If you perform an action on the drawdown in the Agency module that affects the outstanding balance, then the outstanding balance does not match the value captured in TL module. This has to be handled manually.

7.3.0.3 Handing off Trade Details for Reprocessing

If the data population of upload tables have failed, that is, when the status in the browser is 'Extraction', you can rerun the handoff to populate the upload tables.

You can re-run the handoff in the 'SLT Handoff Rerun' screen. You can invoke the 'SLT Handoff Rerun' screen by typing 'TLDREHOF' in the field at the top right corner of the Application tool bar and clicking on the adjoining arrow button.

The screenshot shows a software window titled "SLT LS Handoff Rerun". At the top, there is a header area with the text "Enter Query". Below this, there are three input fields, each with a red asterisk indicating a required field. The fields are labeled "Trade Ref No*", "Event Seq No*", and "Event Code*". A "Run" button is located below the "Event Code*" field. In the bottom right corner of the window, there is an "Exit" button.

In this screen, you can re-process the handoffs that have failed by selecting the trade reference number and event sequence number of the contract for which handoff should be repeated.

You need to specify the following details here:

Trade Reference No.

Select the trade contract for which you wish to repeat the handoff process. All contracts in 'Extraction' status in the 'LB-TL Interface Browser' screen are displayed here.

Event Sequence No.

Select the event sequence number associated with the trade selected.

Event Code

Specify the event code associated with the selected trade.

Click 'Run' to handoff the details of the selected contract.

7.3.1 **Handing-off Commitment Reduction Details**

Commitment reductions can happen in the agency due to events like value dated amendments for the tranche, capitalized rollover of non-revolving contracts or any action resulting in principal payment for non revolving contracts so on.

These commitment reductions details can be handed off to the external system Loans QT using the 'Commitment Reduction Handoff' screen.

You can invoke the 'LQT Commitment Reduction Handoff' screen by typing 'TLDCOMRH' in the field at the top right corner of the Application tool bar and clicking the adjoining arrow button.

In this screen you need to specify the following:

Borrower Reference No.

Select the reference number of the borrower tranche whose commitment reduction details you wish to hand-off.

Total commitment reduction for the borrower along with the break up for each of the position identifier and the facility name gets displayed, once you select the borrower reference number.

Commitment Reduction Price

Specify the commitment reduction discount/ premium price.

The commitment reduction (or increase) is triggered in the LB module when there is a payment of a non-revolving tranche or when there is a reduction (or increase) in the tranche amount. Upon commitment reduction/ increase in the agency, system will hand-off the details to Loans QT.

Note

Commitment reduction price is a mandatory input. If you click the 'Handoff' button without specifying the 'Commitment Reduction Price', system gives an error message and the data is not handed off to LQT. Also, commitment reduction price is disabled and no validation is done for commitment reduction due to PIK activity.

Click 'Handoff' to initiate the handoff process.

As part of commitment reduction handoff, the 'Commitment Reduction Price' is sent to the external system Loans QT as Commitment Reduction (CR) key. The CR key has the value of the 'Borrower Tranche Reference Number – Event Sequence Number' to uniquely identify a particular commitment reduction. The system will compute DCFCOG on the trades that are handed off successfully.

The CR key is sent from LQT to Oracle Banking Corporate Lending as part of trade amendment upload, to handle commitment reduction for open trades. Also, the CR key is sent as part of the internal deal upload from LQT to handle the commitment reduction for settled position. System refers to the CR key to resolve the respective commitment reduction price.

You can reject commitment reduction hand-off records that are failed and unprocessed, by clicking the 'Reject' button. On clicking this button, the system will mark the status of such failed and unprocessed records as 'Rejected.' The system will not send the rejected records to LQT.

This button is enabled only if the check box 'Allow CUSIP/ISIN Swing' is selected in the 'Loan Parameters' screen.

7.3.2 Viewing LQT Trade Browser Details

You can view the LQT trade browser details in the 'LQT Trade Browser' screen. You can invoke the 'LQT Trade Browser' screen by typing 'TLDTRDBW' in the field at the top right corner of the Application tool bar and clicking on the adjoining arrow button.

LQT Trade Browser

Enter Query

LQT Trade Details

Source Code *

Action

Trade Id

Trade Version

Transaction Id *

Market/ClearPar Trade ID

Market Allocation Id

Upload Status

Upload

Reject

Mark Processed

Send Reply

Details Fee Details Errors Message

Ticket ID

Trade Reference No

Firm Account Mnemonic

Counterparty Mnemonic

Customer IP Number

State

Ticket Version

Status

Execution Time

Liquidation Deal Id

Transaction Subject

Transaction Role

Distribution Type

Collateral %

Assignment Fee Type

Interest Type

Exit

The system displays the following details:

- Transaction Id
- Source Code
- Action
- Trade ID
- Markit/ClearPar Trade Id
- Markit Allocation Id
- Trade Version
- Upload Status
- Ticket Id
- Trade Reference Number
- Firm Amount Mnemonic
- Counter Party Mnemonic
- Customer ID Number
- State
- Ticket Version
- Status
- Trade Transaction Type
- Trade Type
- Participation of Details

Note

The 'Primary Trade' is a display only field. If the 'Primary Trade' is selected, the system identifies the trade as a primary trade. The value of the 'Primary Trade' is defaulted from the value of the field 'Primary Trade' from LQT.

7.4 Viewing Multiple Firm Account

You can view the MCC Firm Account Mapping details in the 'MCC - Firm Account Mapping' screen.

You can invoke the 'MCC Mapping' screen by typing 'TLDSTRCM' in the field at the top right corner of the Application tool bar and clicking on the adjoining arrow button.

Existing firm account mnemonic cannot be uploaded from MCC Upload.

The system displays the following details:

- Firm account mnemonic
- MCC
- Expense Code
- Strategy Code
- Sub Strategy Code
- Portfolio Creation Status
- Portfolio Id
- LB OL Mapping Status

Note

- If the status is 'Failed', then appropriate exception details are logged and is available for the user to view in this screen
 - If the Portfolio creation status is 'Failed', then system will not proceed to create the LB OL Product and Component mapping and it would be in Pending status
 - After the Portfolio is successfully created, system proceeds to create the LB OL Product and Component mapping systematically
 - Reprocess options are available for the failed Portfolio creation/failed LB OL Product and Component mapping creation
 - If the Portfolio is created successfully and if LB OL mapping is in Failed status, then the Reprocess option would retry creating only the LB OL mapping
-

7.5 Viewing Referential Data from Secure

You can view the data received from Secure in the 'Secure Data' screen.

You can invoke the 'Secure Data Mapping' screen by typing 'TLSECURE' in the field at the top right corner of the Application tool bar and clicking on the adjoining arrow button.

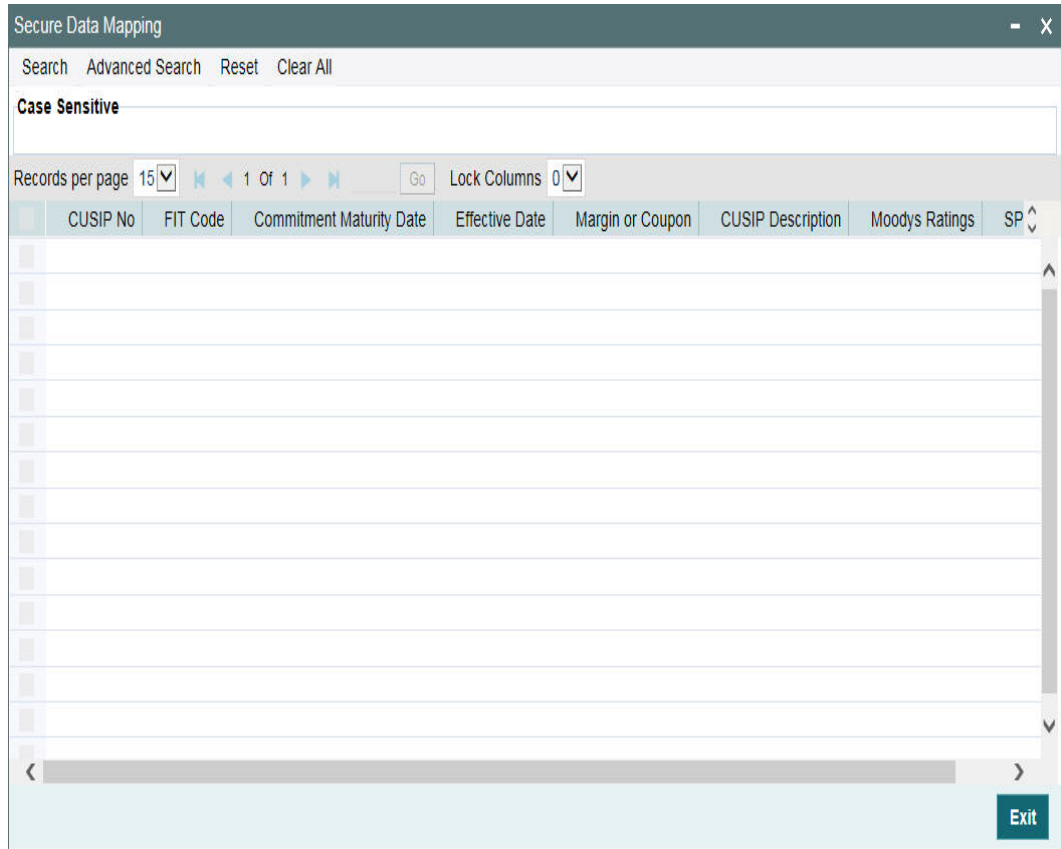

The system displays the following details:

- FIT CODE
- Commitment Maturity Date
- Effective Date of Commitment Date
- Margin/Coupon Float
- CUSIP NO
- CUSIP DESCR
- Moody's Ratings
- S&P Ratings

7.6 Viewing the External Agency Interface Browser

You can view all the incoming messages from Markit using the 'External Agency Interface Browser' screen. This section contains the following topics:

- [Section 7.6.1, "Viewing Trade Details"](#)
- [Section 7.6.2, "Viewing External Allocation Details"](#)
- [Section 7.6.3, "Viewing Currency-wise Settlement Details"](#)
- [Section 7.6.4, "Viewing the Error Messages"](#)
- [Section 7.6.5, "Viewing External Agency Interface Browser History"](#)

You can invoke the 'External Agency Interface Browser Detailed' screen by typing 'TLDMKTIF' in the field at the top right corner of the Application tool bar and clicking on the adjoining arrow button.

In this screen, the Markit details are populated without any translation/resolution. Each row is populated for a 'External Message ID'.

System displays the following details in this screen:

- Message Serial Number -If any message is repeated for a 'External Trade ID', then the Message Serial number is increased. Latest message has the maximum serial number. It is a running sequence number for the Markit messages for the day. It is reset every day and the format for Message Serial Number is 'YYYYMMDDMKTSSSSSS'.
- Message Name
- External Trade ID
- LQT Ticket ID
- Transaction Details
- Trade Completely Settled

Message Status

System updates the message status while processing the Markit messages or during settlement in Oracle Banking Corporate Lending. System displays only of the following values:

- Processed
- Rejected
- Unprocessed

External Trade Status

System updates the Markit trade status while processing the Markit messages or during settlement in Oracle Banking Corporate Lending. System displays only of the following values:

- Matched
- Settled
- Suspended
- Cancelled
- Removed

Message ID

Message ID from SDN appended with CUSIP is displayed in the field.

External Message ID

Message ID from SDN is displayed this field. You are allowed to query the records based on this field.

7.6.1 Viewing Trade Details

You can view the trade details of multiple tranches under a External Trade id in the 'Trade Details' screen. You can invoke this screen by clicking the 'Trade' tab in the 'External Agency Interface Browser' screen.

The screenshot displays the 'External Agency Interface Browser' window. At the top, there is a search bar labeled 'Enter Query'. Below it, several input fields are arranged in two columns: 'Message Serial No', 'Message Name', 'External Trade ID', and 'ClearPar Ticket ID' on the left; 'LQT Ticket Id', 'Message Status' (with a dropdown arrow), 'External Trade Status' (with a dropdown arrow), and 'Deal Type' on the right. A 'Reprocess' button is located below the left column of fields. Below the input fields, there is a navigation bar with tabs: 'Details' (highlighted in red), 'External Allocation Details', 'Currency wise Settlement Details', and 'Exception'. The 'Trade Details' section is active, showing a table with columns: 'Ext CUSIP/ ISIN', 'External Allocation ID', 'Original Trade Amount', 'Trade Amount', 'Trade Currency', and 'Trade Price'. The table currently shows '1 Of 1' records. A 'Go' button is next to the record count. At the bottom right of the window, there is an 'Exit' button.

7.6.2 Viewing External Allocation Details

You can view the allocation details for an allocation id using the 'External Allocation Details' tab. Each allocation can have trade details of multiple tranches under a Markit Trade. You can invoke this screen by clicking the 'External Allocation Details' tab in the 'External Agency Interface Browser' screen.

External Agency Interface Browser

Enter Query

Message Serial No _____ LQT Ticket Id _____
 Message Name _____ Message Status
 External Trade ID _____ External Trade Status
 ClearPar Ticket ID _____ Deal Type _____

Details | Trade | **External Allocation Details** | Currency wise Settlement Details | Exception

1 Of 1 | Go

Allocating Party	External Allocation ID	Allocated Party

7.6.3 Viewing Currency-wise Settlement Details

You can view the currency-wise net settlement amount across the tranches under a External Trade id using the 'Currency wise Settlement Details' screen. To invoke this screen, click the 'Currency wise Settlement Details' tab in the 'External Agency Interface Browser' screen.

External Agency Interface Browser

Enter Query

Message Serial No _____ LQT Ticket Id _____
 Message Name _____ Message Status
 External Trade ID _____ External Trade Status
 ClearPar Ticket ID _____ Deal Type _____

Details | Trade | External Allocation Details | **Currency wise Settlement Details** | Exception

1 Of 1 | Go

External Allocation ID	Settlement Currency	Settlement Amount	Payment Type	Payer	Receiver

7.6.4 Viewing the Error Messages

You can view the exception details for all the trades using the 'Exception' tab.

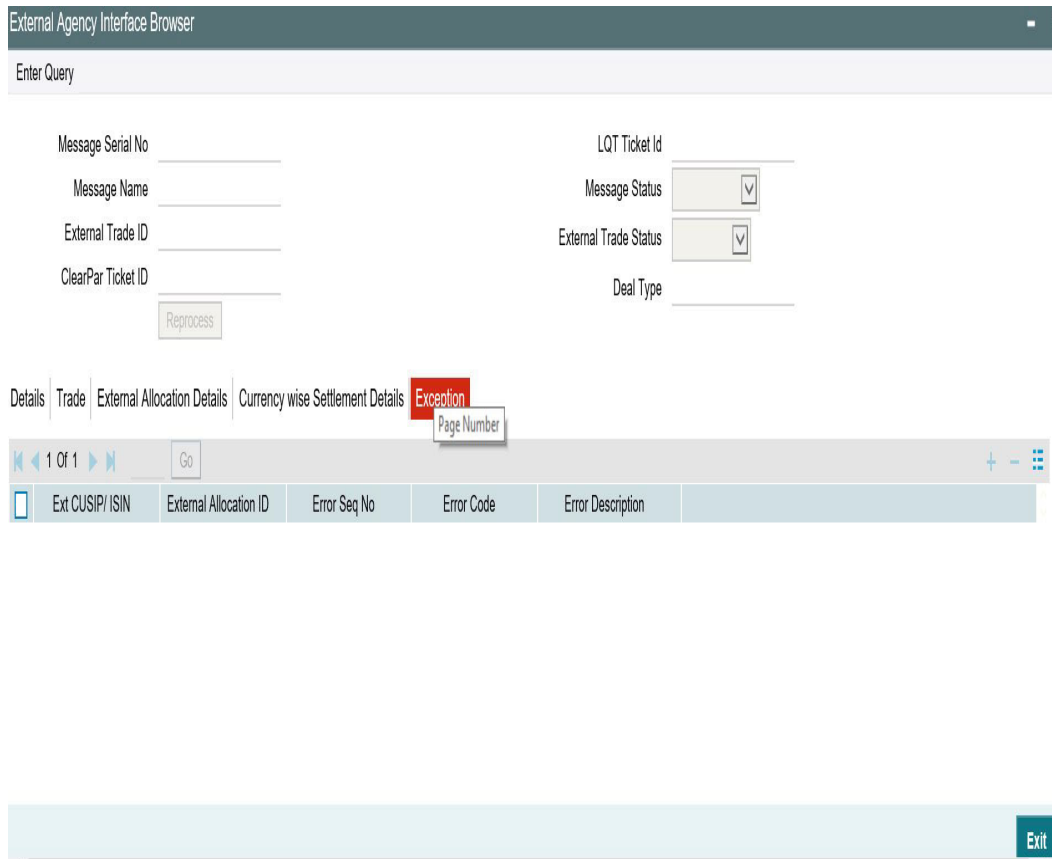

The exception details that are logged in the External Agency Interface Browser are as follows:

CUSIP/TradeID	Exception Details
TradeID-1	MEI code is not found in Oracle Banking Corporate Lending for CUSIP-2
	Invalid Accrual settlement type for CUSIP-3

7.6.5 Viewing External Agency Interface Browser History

The 'External Agency Interface Browser History' screen displays the records which gets archived from the 'External Agency Interface Browser' screen during the end of day batch.

You can invoke the 'External Agency Interface Browser History' screen by typing 'TLDMKIFH' in the field at the top right corner of the Application tool bar and clicking on the adjoining arrow button.

External Agency Interface Browser History

Enter Query

Message Serial No <input type="text"/>	LQT Ticket Id <input type="text"/>
Message Name <input type="text"/>	Message Status <input type="text" value="v"/>
External Trade ID <input type="text"/>	External Trade Status <input type="text" value="v"/>
ClearPar Ticket ID <input type="text"/>	Deal Type <input type="text"/>

Details
Trade
External Allocation Details
Currency wise Settlement Details

Transaction Details

Seller <input type="text"/>	Expt Settl Date <input type="text"/>
Buyer <input type="text"/>	Actual Settl Date <input type="text"/>
Trade Date <input type="text"/>	

Assignment Fee

Remitter <input type="text" value="v"/>	Fee Type <input type="text" value="v"/>
---	---

Other Details

You can review past trades in this screen. This is a view only screen.

The existing process LTBATCH is enhanced to archive the records from the external agency interface browser screen.

For SDN messages where the value is 'False' for the tag 'isEffective', is not processed by the system. These messages are not populated in the 'External Agency Interface Browser' screen. Hence archival process is not applicable for such messages.

7.7 Matching Process and Manual Linkage of SLT and Markit Trades

Matching is the process to uniquely identify the associated SLT trade in Oracle Banking Corporate Lending for each of the trade sent from Markit under a Markit Trade id. The matching process is initiated based on the following scenarios:

- While processing Trade Match Notice
- While processing Syndicated Loan Trade Allocation notice
- While processing Settlement Details Notice
- While processing Trade Closed Notice
- During End of Day batch
- When user initiates Match process manually
- When user initiates trade settlement from settlement queue

You can match the Oracle Banking Corporate Lending SLT trade with market trade using the following primary fields:

- Markit Trade ID/Allocation ID
- LQT Ticket ID

If the trade goes through Markit Settlement Process, then each LQT trade to Oracle Banking Corporate Lending should have a 'Markit Trade ID'. LQT should also send 'Markit Allocation ID' for the allocated Trades along with Markit Trade ID. If the Trade is not of type Allocation, then the Allocation ID is blank.

System does not allow you to change the Markit Trade ID and Allocation ID during manual trade amendment. Each message received from Markit comprises of a valid Trade ID and an associated LQT Ticket ID and each Trade ID/Allocation ID can have multiple tranche details.

During the matching process, the following fields are compared along with the primary fields between Oracle Banking Corporate Lending SLT Trade and the Markit trade:

- External CUSIP/ISIN
- Trade Amount
- Trade Currency
- Trade Price
- Trade Counterparty (buyer and seller)
- Buy/Sell Indicator
- Trade Type
- Trade Date
- Expected Settlement Date
- Form of Purchase

If the above listed fields do not match, then the match status is updated as 'Unmatched'. The exception details are logged and the Trade Reference Number will be blank. If Match status is 'Unmatched', then you can manually link a SLT Trade reference number to a Markit Trade in the settlement queue.

Enriching Trade reference number is possible only if the following criteria are met:

- The above listed fields are match between Markit Trade and the SLT Trade.
- SLT trade is active
- Markit Trade ID/Allocation ID is blank for the SLT Trade or it is the same as Markit trade
- Ticket id is same for LQT and Markit Trade id

In case of manual linking, if the value is null, then the Markit Trade ID/Allocation ID of the Markit trade is updated for the SLT Trade in Oracle Banking Corporate Lending.

If there is any trade amendment/settlement which leads to TAMD/TCNC/TREV/TSTL events for the trade, then system automatically changes the match status from 'Matched' to 'Unmatched' for the unsettled trades in the Settlement Queue. If the Match status is 'Unmatched', then you can manually initiate the matching process from Trade settlement queue. Matching is also done during manual trade settlement processing from trade settlement queue.

If there are any unauthorized transactions pending for Markit trades in the trade settlement queue, you cannot close the EOD batch in Oracle Banking Corporate Lending.

7.8 Settlement Queue for Markit Trades

You can view the settlement details for Markit trades as well as query details based on the status and the various Markit and Oracle Banking Corporate Lending identifiers using the 'Automated Settlement Queue' screen. This section contains the following topics:

- [Section 7.8.1, "Viewing the SSI Mnemonic Details"](#)
- [Section 7.8.2, "Viewing the Funding Memo Details"](#)
- [Section 7.8.3, "Viewing the Funding Memo Reconciliation Details"](#)
- [Section 7.8.4, "Funding Memo Status"](#)
- [Section 7.8.5, "Viewing the Exception Log"](#)
- [Section 7.8.6, "Viewing Automated Settlement Queue History"](#)

You can invoke the 'Automated Settlement Queue' screen by typing 'TLDTRDSQ' in the field at the top right corner of the Application tool bar and clicking on the adjoining arrow button.

The screenshot shows the 'Automated Settlement Queue' application window. At the top, there is a header bar with the title 'Automated Settlement Queue'. Below the header, there is a search bar labeled 'Enter Query'. The main area is divided into two columns of input fields. The left column contains: 'External Trade ID *', 'Ext CUSIP/ ISIN *', 'External Allocation ID *', 'Settlement Status' (dropdown), 'Initiate Matching process' (button), 'Reprocess' (button), and 'Mark As Processed' (button). The right column contains: 'LQT Ticket Id *', 'Match Status' (dropdown), 'External Trade Status' (dropdown), 'Message Status' (dropdown), and 'Confirmation Status' (dropdown). Below these fields is a tabbed interface with tabs for 'Details', 'SSI Mnemonic', 'Fmemo reconciliation', 'Funding Memo Status', and 'Exceptions'. The 'Details' tab is active. Under the 'Details' tab, there are several input fields: 'Suppress Funding Memo' (checkbox), 'Suppress Payment Message' (checkbox), 'Process Settlement' (checkbox), 'Message ID', 'Buyer Name', 'Seller Name', and 'Expense Code'. At the bottom, there is a table with columns: 'Maker Id', 'Checker ID', 'Mod Number', 'Authorization Status', 'Release Time', 'Checker Date Stamp', and 'Record Status'. An 'Exit' button is located in the bottom right corner of the table area.

In this screen, each row is populated for a SLT trade reference number.

Each Markit message is split into one/many trades to match the Oracle Banking Corporate Lending SLT Trade Reference numbers, based on the number of allocations/CUSIP's in the message. This screen has a row for each allocation/trade, so that each row is mapped to one SLT Trade reference number in Oracle Banking Corporate Lending.

System displays the following details in this screen:

- External Trade Id
- External Allocation Id

- LQT Ticket Id
- Buyer
- Seller
- External CUSIP/ISIN
- Tranche Ref No
- Trade Ref No
- Trade Details
- Expected Settlement Date
- Actual Settlement Date
- Original Trade Amount
- Trade Amount
- Trade Currency
- Ticket Number
- Counterparty Number
- Counterparty Name
- Counterparty MEI Code
- Trade Price
- Buy/Sell
- Match Status
- Settlement Status
- Message Status
- Confirmation Status
- Buyer Name
- Seller Name
- Branch
- Desk
- CUSIP/ISIN
- Expense Code
- Trade Type
- Deal Type
- Oracle Banking Corporate Lending Trade Status
- Process Settlement
- Fmemo Status
- Message Id

Specify the following details:

Process settlement

Select this check box to manually initiate trade settlement for the trade. This box is enabled only after the final closure message is received from Markit.

Suppress Payment Message

Select this check box if you want to suppress the payment message during trade settlement. This check box is selected based on the product setup. However, you can edit this check box.

Suppress Funding Memo

Select this check box if you want to suppress the funding memo during trade settlement. This check box is selected based on the product setup. However, you can edit this check box.

Click the 'Initiate Matching Process' button to force the matching process for resolving the trade reference number. This is done in view mode, and SLT trade reference number is populated with the match status as 'Matched' after successful matching; else the match status is marked as 'Unmatched' and the trade reference number is set to blank.

Note

The check boxes 'Process Settlement', 'Suppress Payment Message' and 'Suppress Funding Memo' are disabled in the 'Automated Settlement Queue' if the 'Automate Ticket Settlement' check box is selected and authorized in the 'Loans Parameters' screen.

Settlement Status

Failed – This status implies that the validation during automated settlement process is failed. As part of the new automated settlement process below validations can lead to failure.

- Threshold limit violation for fee components.
- The difference between Markit and Oracle Banking Corporate Lending values for BCR, funded and unfunded should be within the tolerance of 1 unit, irrespective of currency.
- Trade price should match between Markit and Oracle Banking Corporate Lending.

Reprocess

You can reprocess the trades where the 'Settlement Status' is 'Failed'.

Mark as Processed

It allows you to update the settlement status as 'Settled' when the associated trade is liquidated in Oracle Banking Corporate Lending. The system validates that the matching trade reference cannot be null when you click 'Mark as Processed' button and display appropriate error messages.

Note

The 'Reprocess' and Mark as Processed works only if the 'Markit Trade Settlement Allowed' check box and the 'Automate Ticket Settlement' check box are selected and authorized in the 'Loans Parameters' screen

Confirmation Status

- Confirmed – This status implies that the DCF component threshold validation between SDN and Oracle Banking Corporate Lending fields are successful and the 'Auto Confirm Messages' check box is selected in the 'Loans Parameters' screen.
- Unconfirmed – This status implies that either the DCF component threshold validation between SDN and Oracle Banking Corporate Lending fields are failed or that the 'Auto Confirm Messages' is check box is not selected in the 'Loans Parameters' screen.
- Rejected – This status implies that the user has manually rejected the record by changing the confirmation status to 'Rejected' in the 'Automated Settlement Queue' screen.

7.8.1 Viewing the SSI Mnemonic Details

You can view the Oracle Banking Corporate Lending settlement details of the trade counterparties and Agent using the 'SSI Mnemonic' screen. To invoke this screen, click the 'SSI Mnemonic' tab in the 'Automated Settlement Queue Detailed' screen.

Automated Settlement Queue

Enter Query

External Trade ID *

Ext CUSIP/ISIN *

External Allocation ID *

Settlement Status

Initiate Matching process

Reprocess

Mark As Processed

LQT Ticket Id *

Match Status

External Trade Status

Message Status

Confirmation Status

Details **SSI Mnemonic** Fmemo reconciliation Funding Memo Status Exceptions

Customer Details

1 Of 1 Go

Customer	Customer Name	Type

Funding Memo | DCF

Maker Id	Checker ID	Mod Number	Authorization Status
Release Time	Checker Date Stamp	Record Status	

Exit

7.8.2 Viewing the Funding Memo Details

You can view the final settlement amount in the 'Funding Memo Details' screen. To invoke this screen, click the 'Funding Memo' button in the 'Automated Settlement Queue' (TLDTRDSQ) screen.

7.8.3 Viewing the Funding Memo Reconciliation Details

You can view the funding memo details of Markit and Oracle Banking Corporate Lending for manual reconciliation using the 'Automated Settlement Queue' screen. To invoke this screen, click the 'Fmemo Reconciliation' tab in the 'Automated Settlement Queue' (TLDTRDSQ) screen.

Tranche Amount Details

Automated Settlement Queue

Enter Query

External Trade ID*

Ext CUSIP/ISIN*

External Allocation ID*

Settlement Status

Initiate Matching process

Reprocess

Mark As Processed

LQT Ticket Id*

Match Status

External Trade Status

Message Status

Confirmation Status

Details

SSI Mnemonic

Fmemo reconciliation

Funding Memo Status

Exceptions

External Commitment Reduction Amount

Flexcube Commitment Reduction Amount

Currency wise Settlement Details

1 Of 1

Funding Memo | DCF

Maker Id	Checker ID	Mod Number	Authorization Status
Release Time	Checker Date Stamp	Record Status	

All the borrower currencies applicable for the tranche are displayed.

Fee Amount Details

Both the Markit and Oracle Banking Corporate Lending values currency wise for the fee components are displayed in this section.

Trade reference number is the primary field under which the following details are provided:

Oracle Banking Corporate Lending	Markit
Commitment reduction amount	The difference between TradedCommitmentAmount and RevisedCommitmentAmount under MultiFacilitySettlementDetails-->facilitySettlementDetails. This will be trade portion of commitment reduction amount
Buyer's share of Funded amount for each drawdown	Traded portion of the funded amount sent from Markit in contract -> participationAmount -> shareAmount
DCF amount for each draw-down	As summarized in DCF reconciliation table

The following DCF reconciliation table given below provides the details of the various Fee Categories associated with Delayed Compensation Fee and the resolution process in Oracle Banking Corporate Lending for each category:

DCF Computation	Category	Description	Settle ment	OBCL resolution from Markit message
DCF Compu- tation on interest type category	Margin Rate for Fixed type Drawdowns	Margin Rate is applied on the Draw- down(amt) which has Fixed interest	Seller to Buyer	The expected business process is that there is always be one funded DCF category for each drawdown. So Markit match can be done one to one, based on the Con- tract Id and Oracle Bank- ing Corporate Lending Drawdown Ref match
	All-in-rate inter- est for Fixed type Drawdowns	All-in-Rate is applied on the Draw- down(amt) which has Fixed interest	Seller to Buyer	The expected business process is that there is always be one funded DCF category for each drawdown. So Markit match can be done one to one, based on the Con- tract Id and Oracle Bank- ing Corporate Lending Drawdown Ref match
	All-in-rate inter- est for Floating type Drawdowns	All-in-Rate is applied on the Draw- down(amt) which has floating interest	Seller to Buyer	The expected business process is that there is always be one funded DCF category for each drawdown. So Markit match can be done one to one, based on the Con- tract Id and Oracle Bank- ing Corporate Lending Drawdown Ref match
	DCF Cost of Funds for Float- ing type Draw- downs	Average Libor Rate is applied on the Draw- down which has float- ing interest	Buyer to Seller	The expected business process is that there is always be one funded DCF category for each drawdown. So Markit match can be done one to one, based on the Con- tract Id and Oracle Bank- ing Corporate Lending Drawdown Ref match
DCF Compu- tation on both Funded/ unfunded Amount	DCF for Cost of Carry	The computation is based on Rule of 25		This is not reconciled ,as its applicable only for Dis- tressed, and Markit scope is for PAR & TRS only

DCF Computation on Fee type category	Commitment Fee	Commitment Fee Rate applied on unutilized Commitment amount	Seller to Buyer	Sum of all these four fees for the tranche is compared with the DCF fee amount received for the contractid that Oracle Banking Corporate Lending had sent in the ongoing fee msg as part of the agency messages, based on the Contract Id and Oracle Banking Corporate Lending Drawdown Ref match.
	Utilization Fee	Utilization Fee Rate applied on Total outstanding amount	Seller to Buyer	
	Facility Fee	Facility Fee Rate applied on the Transfer_avl(available+outstanding) balance for a tranche	Seller to Buyer	
	Letter of Credit (LC) Fee	LC Fee Rate applied on LC outstanding	Seller to Buyer	

Markit can send a record for a contract Id with the total DCF fees (for all the 4 fee type DCF categories and any of the Interest type DCF categories), since Oracle Banking Corporate Lending could have sent that contract id in the ongoing fee notice. In this case, the amount of all the 4 fee type of DCF categories and any of the 4 interest type DCF categories are summed up and reconciled with the amount sent from Markit.

The fee types given below are not part of the Funding Memo Reconciliation as Markit does not send these fee details in the Settlement Details Notice message:

Fee Type	LQT Sent	OBCL Computed
Adhoc Fees	Yes	No
Amendment Fee	Yes	No
Assignment Fee	Yes	No
Broker Fee	Yes	No
Waiver Fee	Yes	No
Break-Funding Fee	No	Yes
Upfront Fee	No	Yes
Benefit of Commitment Reduction Fee(BCR Fee)	No	Yes

For a combination of payment type, payment amount currency, payer and receiver, Markit sends the 'settlementAmount'. The 'settlementAmount' from Markit is at a Markit Trade Id level; therefore it is the sum of settlement amounts of all underlying Tranche/CUSIP/ISIN's of the Trade Id. Details are displayed by arriving at the sum of all the settlement amounts, excluding fee, for all underlying SLT Trades for the trade id/allocation id and displayed with Markit's settlement amount for the Trade Id.

The 'settlementAmount → paymentAmount' received from Markit are displayed along with each of the currency settlement details against the Oracle Banking Corporate Lending settlement amount.

The funding Memo reconciliation is a manual process done by the user. System only displays the funding memo details of Oracle Banking Corporate Lending and Markit in this screen.

Markit can also send the origination trade (CLP trades) which is the PO trade (Par settling to the counterparty). System identifies the associated line trades under the CUSIP/ticket id. On manual initiation of settlement, system settles all the three trades on the settlement of the PO trade. System validations ensure that the PL/OL trades are in place and the amounts for each match, will be done prior to initiating the settlement.

The buyer's share of funded amount for each drawdown is processed as follows:

- Markit sends the DCF computation details including fee amount for each drawdown under a tranche.
- Each drawdown (contract) in the message has the contract id as the reference number that was sent from Oracle Banking Corporate Lending to Markit as part of the message from the agency module.
- Oracle Banking Corporate Lending displays the Buyer's Share of Oracle Banking Corporate Lending and Markit funded amount under the drawdown based on this reference number.
- Buyer's Share in Oracle Banking Corporate Lending is equal to the buyer's share of each drawdown multiplied by the trade price.
- DCF Reconciliation on funded tranche amount is derived as follows:
 - Each drawdown, irrespective of the Prime or LIBOR, is associated with only one type of DCF Category.
 - Hence, the display of funded delayed compensation fee is always for each drawdown.

7.8.4 Funding Memo Status

In 'Funding Memo Status' tab you are allowed to view the funding memo document status of the buyer and seller. The possible values for 'Action Status' are 'Complete' or 'Incomplete'.

The system validates that the funding memo / pricing letter review should be completed by the buyer and seller for the combination of 'Trade Standard' as well as 'Buy/Sell Indicator' for the matched trade as mentioned in the below scenarios.

If the validations fail, system does not process the SDN messages and appropriate error messages are displayed.

Trade Standard	Buy / Sell Indicator	Funding Memo Status	Processing in OBCL
LSTA	Buy	Reviewer incomplete for buyer	Reject
LSTA	Buy	Reviewer complete for buyer	Process
LSTA	Sell	Reviewer incomplete for seller	Reject
LSTA	Sell	Reviewer complete for seller	Process

LMA	Buy / Sell	Signatory incomplete for both buyer and seller	Reject
LMA	Buy / Sell	Signatory complete for both buyer and seller	Process

Note

For the trades with 'Trade Standard' as 'Non-Standard', the system does not validate the document status of the funding memo / pricing letter.

7.8.5 Viewing the Exception Log

You can view the exception details for any trades in Rejected/Failed status using the 'Error Messages' screen. To invoke this screen, click the 'Exceptions' tab in the 'Automated Settlement Queue Detailed' screen.

The screenshot shows the 'Automated Settlement Queue' interface. At the top, there is a header 'Automated Settlement Queue'. Below it is an 'Enter Query' section with several input fields: 'External Trade ID *', 'Ext CUSIP/ISIN *', 'External Allocation ID *', 'Settlement Status' (with a dropdown arrow), 'LQT Ticket Id *', 'Match Status' (with a dropdown arrow), 'External Trade Status' (with a dropdown arrow), 'Message Status' (with a dropdown arrow), and 'Confirmation Status' (with a dropdown arrow). Below these fields are three buttons: 'Initiate Matching process', 'Reprocess', and 'Mark As Processed'. A navigation bar contains tabs: 'Details', 'SSI Mnemonic', 'Fmemo reconciliation', 'Funding Memo Status', and 'Exceptions' (which is highlighted in red). Below the tabs is a pagination bar showing '1 Of 1' and a 'Go' button. A table header is visible with columns: 'Ext CUSIP/ISIN', 'Error Seq No', 'Error Code', and 'Error Message'. At the bottom, there is a 'Funding Memo | DCF' section with a table containing fields: 'Maker Id', 'Checker ID', 'Mod Number', 'Authorization Status', 'Release Time', 'Checker Date Stamp', and 'Record Status'. An 'Exit' button is located in the bottom right corner of this section.

The exception details that are logged in 'Automated Settlement Queue Detailed' screen are as follows:

CUSIP/Trade ID	Exception Details
CUSIP-1	MEI code is not found in Oracle Banking Corporate Lending for CUSIP-2
	Invalid Accrual settlement type for CUSIP-3

CUSIP-2	MEI code is not found in Oracle Banking Corporate Lending for CUSIP-2
	Invalid Accrual settlement type for CUSIP-3
CUSIP-3	MEI code is not found in Oracle Banking Corporate Lending for CUSIP-2
	Invalid Accrual settlement type for CUSIP-3

7.8.6 Viewing Automated Settlement Queue History

You can review the past trades in this screen. This is view only screen.

You can invoke the 'Automated Settlement Queue History' screen by typing 'TLDTRDQH' in the field at the top right corner of the Application tool bar and clicking on the adjoining arrow button.

Archival of records is performed in 'Automated Settlement Queue' screen during the end of day batch where the 'Contract Status' of the corresponding trade in Oracle Banking Corporate Lending is 'Liquidated'.

The details archived from the 'Automated Settlement Queue' screen is available in the 'Automated Settlement Queue History' screen respectively.

The SDN messages where the value is 'False' for the tag 'is Effective', is not processed by the system at all. These messages are not populated in the automated settlement queue.

Hence archival process is not applicable for such messages.

7.9 Viewing LQT Mnemonic Browser Details

You can view the trade details which are not settled with the process status as 'Unprocessed' in the 'LQT Mnemonic Browser' screen for trade for which counterparty mnemonic is amended. You can invoke the 'LQT Mnemonic Browser' screen by typing 'TLDCPMND' in the field at the top right corner of the Application tool bar and clicking on the adjoining arrow button.

The screenshot shows the 'LQT Mnemonic Browser' application window. It features a search bar at the top labeled 'Enter Query'. Below this, there are two columns of input fields. The left column includes 'Counterparty Mnemonic*' (with a red asterisk), 'Trade Id*' (with a red asterisk), 'Amendment Seq No*' (with a red asterisk), 'Trade Ref No', and 'Trade Esn'. The right column includes 'Process Status' (a dropdown menu currently set to 'Processed'), 'New Counterparty', 'Trade Version', and 'Old Counterparty'. An 'Exit' button is positioned in the bottom right corner of the window.

The system displays the following details:

- Counterparty Mnemonic
- Trade Id
- Amendment Seq No
- Trade Reference Number
- Trade Esn
- New Counter Party
- Old Counter Party
- Process Status

During authorization of the counterparty mnemonic and GFCID mapping, the system identifies the trades from LQT browser based on the counterparty mnemonic and checks the settled trade status.

The system pick up the open trades to update the counterparty and TAMD event are registered. SSI mnemonic is re-picked up based on the new counterparty. Once successfully processed, the system updates the process status as 'Processed'

If the processing is failed for any reason, the system marks the process status as 'Failed', and the exception can be viewed from the error log button of trade draft screen.

Amendment is allowed but you are not be allowed to reprocess the failed version, if the latest amendment exists for the trade

To reprocess, you need select the trades which need to be re-processed and click on 'Reprocess' button which changes the process status for the trades to 'Reprocess' and the job pickups trade to reprocess.

8. Annexure – Accounting Entries

8.1 Introduction

This section contains details of the suggested accounting entries that can be set up, for the SLT module of Oracle Banking Corporate Lending. The details of the suggested accounting entries are given event-wise.

This section contains the following topics:

- [Section 8.1.1, "Accounting Roles"](#)
- [Section 8.1.2, "Events"](#)
- [Section 8.1.3, "Amount Tags"](#)
- [Section 8.1.4, "Advices"](#)
- [Section 8.1.5, "Error Codes"](#)
- [Section 8.1.6, "Event-wise Accounting Entries "](#)

8.1.1 Accounting Roles

The following table lists the accounting roles that can be used in the SLT module:

Accounting Role	Description	Remarks
SLT_ASSETGL	Asset GL for SLT	
SLT_ASSET_OFFGL	Trade Payable	Entry is passed on the Trade date and reversed on Settlement Date
SLT_PREM_DISC	Premium/Discount	Deal Premium/Discount is parked here
SLT_BRIDGE_GL	SLT Bridge GL	
SLT_RLZD_PROFIT	SLT Realized Profit	The Realized P&L Account is defined here
SLT_RLZD_LOSS	SLT Realized Loss	
DCFEXP	Delayed Comp Fees Expense	
DCFINC	Delayed Comp Fees Income	
DCFPAY	Delayed Comp Fees Payable	
DCFREC	Delayed Comp Fees Receivable	
<Component>EXP	Assignment FEE Expense	Assignment FEE - bank contribution

<Component>PAY	Assignment FEE payable	Assignment FEE - Payable to Agent or CPARTY
<Component>EXP	Amendment Fee Expense (for Sell)	
<Component>INC	Amendment Fee Income (for Buy)	
<Component>EXP	Line/Accommodation Fees Expense	
<Component>INC	Line/Accommodation Fees Income	
<Component>PAY	Line/Accommodation Fees Payable	
<Component>REC	Line/Accommodation Fees Receivable	
<Component>EXP (PAID)	Brokerage Fee Expense	If brokerage applicable, its always paid by the bank entity to broker through Payable GLs
<Component>PAY (Payable)	Brokerage Fee Payable	
<Component>INC	Break Funding Fees Income	
<Component>EXP	Break Funding Fees Expense	
SLT_RES_EXP	Reserve Expense	
SLT_RES_LBY	Reserve Liability	
UNREAL_MTM_OFF	Unrealized MTM Offset	The Unrealized P&L Offset account is defined here
UNREAL_MTM_INC	Unrealized MTM Income	The Unrealized P&L account is defined here
UNREAL_MTM_EXP	Unrealized MTM Expense	
<Component>EXP <Component>INC	Adhoc fees expense Adhoc fees income	
<Component>REC <Component>INC	Waiver fees receivable Waiver fees income	
SLT_RESRV_BRIDGE_GL	SLT Reserve Bridge GL	
SLT_CONTRA_BRIDGE_GL	SLT Contra Bridge GL	

UNSETL-PNL-BS	SLT Unrealized Profit	Posting the unsettled realized Profit/Loss entries into Unsettled PNL BS instead of Premium discount GL during trade booking, amendment, and cancellation.
DWRITEOFFGL	DIRECT WRITEOFF GL	
WRITEOFFEXP	SLT writeoff expense GL	
SLT-LD-BRIDGE	SLT LD Bridge GL	
MARKS_FEEPAY	SLT MARKS FEEPAY	
SLTCONCOGGL	SLT CONTRA BRIDGE GL FOR COC	
SLTWOFFCOCGL	SLT Writeoff Cost of Credit GL	
UNAMORTCOCGL	SLT Unamort Cost of Credit GL	
CONRECOGL	CONTRA RECOVERY GL FOR COC	
WOFFRECOGL	WRITEOFF RECOVERY GL FOR COC	
MARKSRECOGL	MARKS FEE RECOVERY GL FOR COC	
UNAMORTRECOGL	UNAMORT FEE RECOVERY GL FOR COC	
SLT-PREM-DISC	Premium/Discount GL	

8.1.2 Events

The following table lists the events that can be linked to an SLT product.

Event	Remarks
TBOK	This event would be triggered on the date the SLT contract is booked
TSTL	This event would be triggered on the Settlement Date that is, the date on which the user manually initiates Liquidation of the contract.
FMEM	This event would be triggered whenever funding memo is to be generated
SGEN	This event would be triggered when Payment message needs to be generated settlement days before the payment date
RSTL	Reversal of Trade Settlement (TSTL) event

TAMD	This event would be triggered whenever a SLT deal (contract) is amended
TCNC	This event would be triggered to offset the position and PNL. Any user initiated activity requiring the offsetting of the position and PNL based on the current trade details will fire the TCNC event TCNC event occurs on the following instances Reversal of the trade Trade amendment for certain fields such as Buy/Sell, Trade Type, Trade date, Trade price, and so on. In these cases the existing trade position and PNL details should be offset before considering the revised trade details for the position and PNL tracking
TREV	This event would be triggered whenever a SLT deal (contract) is Reversed
FLIQ	Fee Liquidation in case of any FEE settlement after the trade settlement
FACR	This event would be triggered as part of the Accrual event for Fees (The accrual of Delayed Compensation Fees is triggered in this event)
FAMD	FEE amendment to allow the FEE component details before its liquidation
REVL	Revaluation (EOD)
RRVL	Reversal of Revaluation (BOD)
RESV	This event is triggered on the month-end (or the day preceding the month-end if month-end is a holiday)
RMEM	Reversal of Funding memo (before trade settlement)
TCKT	This event is triggered during ticket settlement save
FREV	Reversal of fee liquidation event
TELV	This event is triggered on elevation of trade (deal type) from participation of to assignment.

8.1.3 Amount Tags

The following are some of the amount tags available for the module:

Amount Tags	Remarks
DWOFF_AMT	Direct Write-off
MARKS-FEE	Marks
SLT-CON-COC	Contra
SLT-WOFF-COC	Write-off
UNAMORT-FEE	Unamort fee (FAS91 fees)
COC-CON-RECO	Contra Recovery
COC-WOFF-RECO	Write-off Recovery

MARKS-FEE-RECO	Marks Recovery
UNAMORT-RECO	Unamort Recovery
COC-CON-NET	Contra Net
COC-WOFF-NET	Write-off Net
MARKS-FEE-NET	Marks Net
UNAMORT-NET	Unamort Net
UNFND-DIS-SEL	Unfunded Discount Sell Amount
UNFND-PRM-SEL	Unfunded Premium Sell Amount

8.1.4 Advices

The following advices can be linked to an SLT product.

Advice	Event	Remarks
Payment Message	TSTL/SGEN	This advice would be generated on the Settlement Date
Funding Memo	FMEM	The Funding Memo is always generated on or before the Settlement Date. The Funding Memo can be generated for Buy as well as Sell Deals.

8.1.5 Error Codes

The following error codes are available for assignment fee details:

Error Code	Message
TL-SETTL-12	Agency id is different for one of the trades under the ticket \$1
TL-SETTL-13	Assignment Fee Remitter is different for one of the trades under the ticket \$1
TL-SETTL-14	Assignment fee type is different for one of the trades under the ticket \$1

The following error code is available for line/accommodation fee details:

Error Code	Error Description
TL-C0160	User input department code not matching with the maintained department code \$1
TL-C0167	Trade Portfolio and Trade Counterparty are same

The following error codes are available for amending CUSIP/Buy-Sell Indicator:

Error Code	Error Description
IF-ENT-054	Unable to resolve Default Customer for the counterparty mnemonic
IF-ENT-055	Amendment Reason (ChangeCusipAfterCmtRed) is not applicable for New
IF-ENT-056	Amendment Reason (ChangeCusipAfterCmtRed) is Invalid as there is no change in CUSIP
TL-C0161	Apply Commitment Reduction/PIK for CUSIP Amend Flag is selected only for CUSIP Amendment
TL-C0162	Commitment Reduction/PIK does not exist for the old trade
TL-C0163	Commitment Reduction Amount and Avg. Commitment reduction Price/PIK amount are not EQUAL between CUSIP IDs
TL-C0164	No other amendment is allowed with buy sell indicator amendment

The following error codes are available for validating and handling exceptions for Markit Trade Settlement:

Error Code	Error Description
TL-MKT-01	Tax maintenance does not exist for participant(s) involved in Trade for Markit Trade ID\$1
TL-MKT-02	Invalid Accrual Settlement Type
TL-MKT-03	Both Buyer and Seller are bank counterparties
TL-MKT-04	Markit Trade closure message processing failed
TL-MKT-05	Settled trades cannot be unlocked
TL-MKT-06	Deletion/Authorization of Trade settlement cannot be done from this screen
TL-MKT-07	Suspended/Cancelled/Removed trades cannot be unlocked
TL-MKT-08	Both buyer and Seller are not bank counterparties
TL-MKT-09	Failed in Markit message matching process
TL-MKT-10	Failed in Markit message processing
TL-MKT-11	Allocation details not found
TL-MKT-12	Failed to fetch details for \$1
TL-MKT-14	TradeMatchNotice message not received. Cannot process \$ message
TL-MKT-15	Markit Buyer/ Seller validation fails

TL-MKT-16	Cannot process TradeUpdateNotification message, as Matching record(s) not exists in Trade settlement queue
TL-MKT-17	Allocating party is not a Buyer or Seller in Parent Trade

The following error codes are available for LC Sublimit balance (HFI) update:

Error_Code	Description
TL-TRD27	LC Sublimit HFS Balance Update failed

The following error code is available for trade dated CFPI accounting:

Error Code	Error Description	Error Type
TL-TRD-05	Failed To Process Trade Date Entries	E

The following error code is available for Counterparty mnemonic amendment:

Error Code	Error Description	Error Type
TL-CPM-01	Reprocessing cannot be done as the earlier version of the trade is in Failed/Unprocessed status	E
TL-CPM-02	Record is marked as Reprocess	E
TL-CPM-03	Only Failed records can be marked for reprocess	E
TL-CPM-04	Reprocessing cannot be done as the latest version of the trade \$1 is in Reversed status or Elevated	E

The following error code is available during ticket or trade settlement for DD creation as part of TL-LB STP:

Error Code	Error Description	Error Type
TL-FMEM-056	Please select the existing drawdowns or provide the information for new drawdown booking, combination is not allowed	E
TL-FMEM-057	Auto booking of new drawdowns are not allowed where fund sighting is applicable for the CUSIP	E
TL-FMEM-058	Drawdown Original Start Date should be less than or equal to drawdown Value date	E
TL-FMEM-059	Drawdown Maturity Date should be greater than drawdown Value date	E
TL-FMEM-060	Drawdown Value Date should be in between Tranche value date and maturity date	E

TL-FMEM-061	Please input Interest Details for each draw-down	E
TL-FMEM-062	Non Prorata/PIK Settlement is not allowed as self participant \$1 of CUSIP \$2 is not having 100% share	E
TL-FMEM-063	Mandatory field \$1 cannot be null	E
TL-FMEM-064	Please enter drawdown details	E
TL-FMEM-065	Value date cannot be less than the vami date of a tranche \$1	E
TL-FMEM-066	Value date of the Drawdown cannot be less than maximum actual settlement dates of all the trades under the tranche	E
TL-FMEM-067	Borrower margin and the margin given are different	E
TL-FMEM-068	Settlement cannot be done as the future dated settlement is already existing	E

The following error codes are available during ticket or trade settlement for external counterparty SSI Mnemonic mapping:

Error Code	Error Description	Error Type
TL-TKSTL-68	SSI Mnemonic captured for currency \$1 and counterparty \$2 is of default type	E
TL-TKSTL-69	SSI and Entity details for external participant has to be entered	E
TL-TKSTL-70	Please Revisit External party SSI details screen	O
TL-TKSTL-71	Ext Party SSI details already captured for Cusip-Counterparty combination is overwritten	O

The following error codes are available for CUSIP swing.

Error Code	Error Description
TL-CSW-001	Use of special characters in CUSIP No. is not allowed
TL-CSW-002	Tranche Ref No is mandatory
TL-CSW-003	Share percentage is not 100
TL-CSW-004	End Date cannot be NULL
TL-CSW-005	Unauthorized CUSIP-Tranche linkage exists
TL-CSW-006	CUSIP-Tranche linkage exists. The trade cannot be reversed

TL-CSW-007	More than one record of active tranche exist
TL-CSW-008	Actual settlement date is lesser than the max end date of the CUSIP-Tranche linkage. settlement is not allowed
TL-CSW-009	Non- Lead Tranche is allowed to maintain, only if new CUSIP/ISIN has been updated in the tranche contract.
TL-CSW-010	Input of Zero Share Percentage is not allowed
TL-CSW-011	Start date and End Date of the tranches overlap so Share percentage is mandatory
TL-CSW-012	CUSIP amendment. Manual intervention is required
TL-CSW-013	Tranche is Inactive. Only maturity date amendment is allowed
TL-CSW-014	Allow CUSIP Swing is not checked at loan parameter level
TL-CSW-015	Active Tranche linked to the CUSIP No. is not maintained
TL-CSW-016	End Date can be NULL only for the active tranche currently associated with CUSIP No.
TL-CSW-017	End Date should be NULL for the active tranche currently associated with CUSIP No.
TL-CSW-018	Start date and End Date of the tranches should be same if share percentage is entered
TL-CSW-019	Share Percentage should be NULL for the active tranche
TL-CSW-020	CUSIP No. is mandatory
TL-CSW-021	Start date and End Date of the tranches overlap
TL-CSW-022	Start date is lesser than the value date of tranche

The following error codes are available for loan sale from HFS.

Error Code	Error Description
TL-HFS-005	Position of the portfolio is lesser than the Trade amount
TL-HFS-006	Multiple HFS portfolio available for a single CUSIP
TL-HFS-007	Unprocessed/Failed Record exist in LB-TL Browser for the given portfolio
TL-HFS-008	Position already exists for the CUSIP with different expense code
TL-HFS-009	Failed in Portfolio Validation

8.1.6 Event-wise Accounting Entries

In the subsequent sections you can find the suggested accounting entries and advices for each of the events in the life-cycle of a syndicated loan trade deal.

8.1.6.1 **TBOK: Contract Booking**

Accounting Role	Amount Tag	Dr/ Cr	Remarks
SLT-ASSETGL	SLT-NOM-BUY	D	These two entries relate to Booking Asset on the Trade Date in SLT module for Buy
SLT-ASSET-OFFGL	SLT-NOM-BUY	C	
SLT-ASSET-OFFGL	SLT-NOM-SEL	D	These two entries relate to Booking Asset on the Trade Date in SLT module for Sell
SLT-ASSETGL	SLT-NOM-SEL	C	
UNSETL-PNL-BS	SLT-RLZD-PRFT	D	Trade Date P&L entries posted on Trade Booking
SLT-RLZD-PROFIT	SLT-RLZD-PRFT	C	Profit Entries are not applicable for Origination Sell on the trade date
SLT-RLZD-LOSS	SLT-RLZD-LOSS	D	
UNSETL-PNL-BS	SLT-RLZD-LOSS	C	

8.1.6.2 **Additional Entries for Origination Trade**

Accounting Role	Amount Tag	Dr/ Cr	Remarks
SLT_UNAMORT_FEE-PAY	UNAMORT-FEE	D	Portion of the Unamort FEE
SLT_PREM_DISC	UNAMORT-FEE	C	
SLT_RES-RV_BRIDGE_GL	SLT-RES-SEL	D	Portion of the Reserve settlement
SLT-PREM-DISC	SLT-RES-SEL	C	
SLT_CONTRA_BRIDGE_GL	SLT-CON-SEL	D	Portion of the Contra settlement
SLT-PREM-DISC	SLT-CON-SEL	C	

Line Trade

Accounting Role	Amount Tag	Dr/ Cr	Remarks
<component>EXP	<component>_EXP	D	Passed in the Origination Line Sell trade

SLT-BRIDGE-GL	<component>_EXP	C	
SLT-BRIDGE-GL	<component>_INC	D	Passed in the Par Line Buy Trade
<component>INC	<component>_INC	C	

Additional entries for cost of credit

Accounting Role	Amount Tag	Dr/ Cr	Remarks
DWRITEOFFGL	DWOFF_AMT	D	Direct Write-off
SLT-PREM-DISC	DWOFF_AMT	C	Direct Write-off
SLT-LD-BRIDGE	MARKS-FEE	D	Marks
MARKS_FEE-PAY	MARKS-FEE	C	Marks
SLT-LD-BRIDGE	SLT-CON-COC	D	Contra
SLTCONCOCGL	SLT-CON-COC	C	Contra
SLT-LD-BRIDGE	SLT-WOFF-COC	D	Write-off
SLTWOFF-COCGL	SLT-WOFF-COC	C	Write-off
SLT-LD-BRIDGE	UNAMORT-FEE	D	Unamort fee (FAS91 fees)
UNAMORT-COCGL	UNAMORT-FEE	C	Unamort fee (FAS91 fees)

CFPI Accounting Entries for Buy Trade

Accounting Role	Amount Tag	Dr/ Cr	Remarks
TRDT-BUY	TRDT-NOM-BUY	Dr	Funded Percentage Amount
TRDT-PAY	TRDT-NOM-BUY	Cr	
TRDT-PREM-DISC	TRDT-DIS-BUY	Cr	In case trade is at discount
TRDT-PAY	TRDT-DIS-BUY	Dr	
TRDT-PREM-DISC	TRDT-PRM-BUY	Dr	In case trade is at premium
TRDT-PAY	TRDT-PRM-BUY	Cr	
TRDT-UNFUND	TRDT-UNFND-BUY	Dr	For Unfunded amount
TRDT-MEMO	TRDT-UNFND-BUY	Cr	

CFPI Accounting Entries for Sell Trade

Accounting Role	Amount Tag	Dr/ Cr	Remarks
TRDT-SELL	TRDT-NOM-SELL	Dr	Funded Percentage Amount
TRDT-REC	TRDT-NOM-SELL	Cr	
TRDT-PREM-DISC	TRDT-DIS-SELL	Cr	In case trade is at discount
TRDT-REC	TRDT-DIS-SELL	Dr	
TRDT-PREM-DISC	TRDT-PRM-SELL	Dr	In case trade is at premium
TRDT-REC	TRDT-PRM-SELL	Cr	
TRDT-UNFUND	TRDT-UNFND-SELL	Dr	For Unfunded amount
TRDT-MEMO	TRDT-UNFND-SELL	Cr	

Trade dated CFPI Accounting Entries for Sell Trade

Accounting Role	Amount Tag	Dr/ Cr	Comment
TRDT-FND-BUY	TRDT-FND-BUY	Dr	Trade portion of funded amount
TRDT-FND-PAY	TRDT-FND-BUY	Cr	Trade portion of funded amount
TRDT-UNFND	TRDT-UNFND-BUY	Dr	Trade portion of unfunded amount
TRDT-MEMO	TRDT-UNFND-BUY	Cr	Trade portion of unfunded amount

TRDT-DISC-PAY	TRDT-DIS-BUY	Dr	Discount amount
TRDT-PREM-DISC	TRDT-DIS-BUY	Cr	Discount amount
TRDT-PRM-PAY	TRDT-PRM-BUY	Cr	Premium amount
TRDT-PREM-DISC	TRDT-PRM-BUY	Dr	Premium amount

Trade dated CFPI Accounting Entries for Sell Trade

Accounting Role	Amount Tag	Dr/ Cr	Comment
TRDT-FND-SELL	TRDT-FND-SELL	Cr	Trade portion of funded amount
TRDT-FND-REC	TRDT-FND-SELL	Dr	Trade portion of funded amount
TRDT-UNFND	TRDT-UNFND-SELL	Cr	Trade portion of unfunded amount
TRDT-MEMO	TRDT-UNFND-SELL	Dr	Trade portion of unfunded amount
TRDT-DISC-REC	TRDT-DIS-SELL	Cr	Discount amount
TRDT-PREM-DISC	TRDT-DIS-SELL	Dr	Discount amount
TRDT-PRM-REC	TRDT-PRM-SELL	Dr	Premium amount
TRDT-PREM-DISC	TRDT-PRM-SELL	Cr	Premium amount

Brokerage

Accounting Role	Amount Tag	Dr/Cr	Remarks
<component>EXP (PAID)	<component>_PAY	D	If brokerage applicable, its always paid by the bank entity to broker through Payable GLs
<component>PAY (Payable)	<component>_PAY	C	

8.1.6.3 TAMM: Contract Amendment

Accounting Role	Amount Tag	Dr/Cr	Remarks
SLT-ASSETGL	SLT-NOM-BUY	D	These two entries relate to Booking Asset on the Amendment Date in SLT module for Buy. It is applicable only if the cancellation is followed an amendment
SLT-ASSET-OFFGL	SLT-NOM-BUY	C	
SLT-ASSET-OFFGL	SLT-NOM-SEL	D	These two entries relate to Booking Asset on the Amendment Date in SLT module for Sell. It is applicable only if the cancellation is followed an amendment
SLT-ASSETGL	SLT-NOM-SEL	C	
UNSETL-PNL-BS	SLT-RLZD-PRFT	D	Trade Date P&L entries posted on Amendment of the Contract amount
SLT-RLZD-PROFIT	SLT-RLZD-PRFT	C	Not applicable for Origination Line trade
SLT-RLZD-LOSS	SLT-RLZD-LOSS	D	
UNSETL-PNL-BS	SLT-RLZD-LOSS	C	

Amendment of Customer Trade to Line Trade

Accounting Role	Amount Tag	Dr/Cr	Remarks
<component>EXP	<component>_EXP	D	Passed in the Origination Line Sell trade
SLT-BRIDGE-GL	<component>_EXP	C	These entries are applicable only for the amendment of Customer trade to Line trade
SLT-BRIDGE-GL	<component>_INC	D	Passed in the Par Line Buy Trade

<component>INC	<component>_INC	C	
----------------	-----------------	---	--

CFPI Accounting Entries for Increase in Trade Amount of Buy

Accounting Role	Amount Tag	Dr/ Cr	Remarks
TRDT-BUY	TRDT-NOM-BUY	Dr	Funded Percentage Amount
TRDT-PAY	TRDT-NOM-BUY	Cr	
TRDT-PREM-DISC	TRDT-DIS-BUY	Cr	In case trade is at discount
TRDT-PAY	TRDT-DIS-BUY	Dr	
TRDT-PREM-DISC	TRDT-PRM-BUY	Dr	In case trade is at premium
TRDT-PAY	TRDT-PRM-BUY	Cr	
TRDT-UNFUND	TRDT-UNFND-BUY	Cr	For Unfunded amount
TRDT-MEMO	TRDT-UNFND-BUY	Dr	

CFPI Accounting Entries for Decrease in Trade Amount of Buy

Accounting Role	Amount Tag	Dr/ Cr	Remarks
TRDT-BUY	TRDT-AMD-BUY	Dr	Funded Percentage Amount
TRDT-PAY	TRDT-AMD-BUY	Cr	
TRDT-PREM-DISC	TRDT-AMDIS-BUY	Cr	In case trade is at discount
TRDT-PAY	TRDT-AMDIS-BUY	Dr	
TRDT-PREM-DISC	TRDT-AMPRM-BUY	Dr	In case trade is at premium
TRDT-PAY	TRDT-AMPRM-BUY	Cr	
TRDT-UNFUND	TRDT-AMUNFD-BUY	Cr	For Unfunded amount
TRDT-MEMO	TRDT-AMUNFD-BUY	Dr	

CFPI Accounting Entries for Increase in Trade Amount of Sell

Accounting Role	Amount Tag	Dr/ Cr	Remarks
TRDT-SELL	TRDT-NOM-SELL	Cr	Funded Percentage Amount
TRDT-REC	TRDT-NOM-SELL	Dr	
TRDT-PREM-DISC	TRDT-DIS-SELL	Dr	In case trade is at discount
TRDT-REC	TRDT-DIS-SELL	Cr	

TRDT-PREM-DISC	TRDT-PRM-SELL	Cr	In case trade is at premium
TRDT-REC	TRDT-PRM-SELL	Dr	
TRDT-UNFUND	TRDT-UNFND-SELL	Cr	For Unfunded amount
TRDT-MEMO	TRDT-UNFND-SELL	Dr	

CFPI Accounting Entries for Decrease in Trade Amount of Sell

Accounting Role	Amount Tag	Dr/ Cr	Remarks
TRDT-SELL	TRDT-AMD-SELL	Dr	Funded Percentage Amount
TRDT-REC	TRDT-AMD-SELL	Cr	
TRDT-PREM-DISC	TRDT-AMDIS-SELL	Cr	In case trade is at discount
TRDT-REC	TRDT-AMDIS-SELL	Dr	
TRDT-PREM-DISC	TRDT-AMPRM-SELL	Dr	In case trade is at premium
TRDT-REC	TRDT-AMPRM-SELL	Cr	
TRDT-UNFUND	TRDT-AMUNFD-SEL	Dr	For Unfunded amount
TRDT-MEMO	TRDT-AMUNFD-SEL	Cr	

Trade Dated CFPI Accounting Entries for Buy Trade

Accounting Role	Amount Tag	Dr/ Cr	Remarks
TRDT-FND-BUY	TRDT-FNDINC-BUY	Dr	Increase in Funding
TRDT-FND-PAY	TRDT-FNDINC-BUY	Cr	Increase in Funding
TRDT-MEMO	TRDT-UFNDEC-BUY	Dr	Increase in Funding (Unfund decreases)
TRDT-UNFND	TRDT-UFNDEC-BUY	Cr	Increase in Funding (Unfund decreases)
TRDT-DISC-PAY	TRDT-DISINC-BUY	Dr	Increase in Discount
TRDT-PREM-DISC	TRDT-DISINC-BUY	Cr	Increase in Discount
TRDT-PRM-PAY	TRDT-PRMINC-BUY	Cr	Increase in Premium
TRDT-PREM-DISC	TRDT-PRMINC-BUY	Dr	Increase in Premium
TRDT-FND-PAY	TRDT-FNDDEC-BUY	Dr	Decrease in Funding
TRDT-FND-BUY	TRDT-FNDDEC-BUY	Cr	Decrease in Funding
TRDT-MEMO	TRDT-UFNINC-BUY	Cr	Decrease in Funding (Unfund increases)
TRDT-UNFND	TRDT-UFNINC-BUY	Dr	Decrease in Funding (Unfund increases)

TRDT-DISC-PAY	TRDT-DISDEC-BUY	Cr	Decrease in Discount
TRDT-PREM-DISC	TRDT-DISDEC-BUY	Dr	Decrease in Discount
TRDT-PRM-PAY	TRDT-PRMDEC-BUY	Dr	Decrease in Premium
TRDT-PREM-DISC	TRDT-PRMDEC-BUY	Cr	Decrease in Premium

Trade Dated CFPI Accounting Entries for Sell Trade

Accounting Role	Amount Tag	Dr/ Cr	Remarks
TRDT-FND-SELL	TRDT-FNDDEC-SEL	Cr	Decrease in Funding
TRDT-FND-REC	TRDT-FNDDEC-SEL	Dr	Decrease in Funding
TRDT-MEMO	TRDT-UFNINC-SEL	Dr	Decrease in Funding (Unfund increases)
TRDT-UNFND	TRDT-UFNINC-SEL	Cr	Decrease in Funding (Unfund increases)
TRDT-DISC-REC	TRDT-DISINC-SEL	Cr	Increase in Discount
TRDT-PREM-DISC	TRDT-DISINC-SEL	Dr	Increase in Discount
TRDT-PRM-REC	TRDT-PRMINC-SEL	Dr	Increase in Premium
TRDT-PREM-DISC	TRDT-PRMINC-SEL	Cr	Increase in Premium
TRDT-FND-REC	TRDT-FNDINC-SEL	Cr	Increase in Funding
TRDT-FND-SELL	TRDT-FNDINC-SEL	Dr	Increase in Funding
TRDT-UNFND	TRDT-UFNDEC-SEL	Dr	Increase in Funding (Unfund decreases)
TRDT-MEMO	TRDT-UFNDEC-SEL	Cr	Increase in Funding (Unfund decreases)
TRDT-DISC-REC	TRDT-DISDEC-SEL	Dr	Decrease in Discount
TRDT-PREM-DISC	TRDT-DISDEC-SEL	Cr	Decrease in Discount
TRDT-PRM-REC	TRDT-PRMDEC-SEL	Cr	Decrease in Premium
TRDT-PREM-DISC	TRDT-PRMDEC-SEL	Dr	Decrease in Premium

Trade Dated CFPI Accounting Entries for Settled Position

Accounting Role	Amount Tag	Dr/ Cr	Remarks
STDT-FUND	TRDT-FND-INC	Dr	Increase in Funding
STDT-FUND-CTL1	TRDT-FND-INC	Cr	Increase in Funding
STDT-FUND-CTL1	TRDT-FND-DEC	Dr	Decrease in Funding

STDT-FUND	TRDT-FND-DEC	Cr	Decrease in Funding
-----------	--------------	----	---------------------

Brokerage

Accounting Role	Amount Tag	Dr/Cr	Remarks
<component>EXP (PAID)	<component>_PAY	D	If brokerage applicable, its always paid by the bank entity to broker through Payable GLs
<component>PAY (Payable)	<component>_PAY	C	

8.1.6.4 TCNC: Contract Cancellation

Accounting Role	Amount Tag	Dr/Cr	Remarks
SLT-ASSET-OFFGL	SLT-NOM-BUY	D	These two entries relate to Offsetting Asset on the Cancellation Date in SLT module for the Cancellation amount on a Buy trade
SLT-ASSETGL	SLT-NOM-BUY	C	
SLT-ASSETGL	SLT-NOM-SEL	D	These two entries relate to Offsetting Asset on the Cancellation Date in SLT module for the Cancellation amount on a Sell trade
SLT-ASSET-OFFGL	SLT-NOM-SEL	C	
UNSETL-PNL-BS	SLT-RLZD-PRFT	D	Trade Date P&L entries posted on Cancellation of the Contract amount
SLT-RLZD-PROFIT	SLT-RLZD-PRFT	C	Not applicable for Origination Line trade
SLT-RLZD-LOSS	SLT-RLZD-LOSS	D	
UNSETL-PNL-BS	SLT-RLZD-LOSS	C	

During trade cancellation (TCNC) of Buy Trade, the following set of CFPI accounting entries is posted which nullifies the TBOK entries:

Accounting Role	Amount Tag	Dr/Cr	Remarks
TRDT-BUY	TRDT-NOM-BUY	Cr	Funded percentage amount
TRDT-PAY	TRDT-NOM-BUY	Dr	

TRDT-PREM-DISC	TRDT-DIS-BUY	Dr	In case trade is at discount
TRDT-PAY	TRDT-DIS-BUY	Cr	
TRDT-PREM-DISC	TRDT-PRM-BUY	Cr	In case trade is at premium
TRDT-PAY	TRDT-PRM-BUY	Dr	
TRDT-UNFUND	TRDT-UNFND-BUY	Cr	For unfunded amount

During trade cancellation (TCNC) of sell Trade, the following set of CFPI accounting entries are posted:

Accounting Role	Amount Tag	Dr/ Cr	Remarks
TRDT-SELL	TRDT-NOM-SELL	Dr	Funded percentage amount
TRDT-REC	TRDT-NOM-SELL	Cr	
TRDT-PREM-DISC	TRDT-DIS-SELL	Cr	In case trade is at discount
TRDT-REC	TRDT-DIS-SELL	Dr	
TRDT-PREM-DISC	TRDT-PRM-SELL	Dr	In case trade is at premium
TRDT-REC	TRDT-PRM-SELL	Cr	
TRDT-UNFUND	TRDT-UNFND-SELL	Dr	with unfunded amount
TRDT-MEMO	TRDT-UNFND-SELL	Cr	

In case TCNC after an amendment (TAMD) of the trade amount increase for a buy trade, then the following set of CFPI accounting entries are posted along with above mentioned TBOK entries:

Accounting Role	Amount Tag	Dr/ Cr	Remarks
TRDT-BUY	TRDT-NOM-BUY	Cr	Funded percentage amount
TRDT-PAY	TRDT-NOM-BUY	Dr	
TRDT-PREM-DISC	TRDT-DIS-BUY	Dr	In case trade is at discount
TRDT-PAY	TRDT-DIS-BUY	Cr	

TRDT-PREM-DISC	TRDT-PRM-BUY	Cr	In case trade is at premium
TRDT-PAY	TRDT-PRM-BUY	Dr	
TRDT-UNFUND	TRDT-UNFND-BUY	Dr	For unfunded amount
TRDT-MEMO	TRDT-UNFND-BUY	Cr	

During cancellation (TCNC) after trade amendment (TAMD) of decrease in trade amount of BUY trade, the following set of accounting entry is posted:

Accounting Role	Amount Tag	Dr/ Cr	Remarks
TRDT-BUY	TRDT-AMD-BUY	Dr	Funded percentage amount
TRDT-PAY	TRDT-AMD-BUY	Cr	
TRDT-PREM-DISC	TRDT-AMDIS-BUY	Cr	In case trade is at discount
TRDT-PAY	TRDT-AMDIS-BUY	Dr	
TRDT-PREM-DISC	TRDT-AMPRM-BUY	Dr	In case trade is at premium
TRDT-PAY	TRDT-AMPRM-BUY	Cr	
TRDT-UNFUND	TRDT-AMUNFD-BUY	Dr	For unfunded amount
TRDT-MEMO	TRDT-AMUNFD-BUY	Cr	

During cancellation (TCNC) after trade amendment (TAMD) of increase in trade amount of SELL trade, the following set of accounting entry are posted:

Accounting Role	Amount Tag	Dr/ Cr	Remarks
TRDT-SELL	TRDT-NOM-SELL	Dr	Funded percentage amount
TRDT-REC	TRDT-NOM-SELL	Cr	
TRDT-PREM-DISC	TRDT-DIS-SELL	Cr	In case trade is at discount
TRDT-REC	TRDT-DIS-SELL	Dr	
TRDT-PREM-DISC	TRDT-PRM-SELL	Dr	In case trade is at premium
TRDT-REC	TRDT-PRM-SELL	Cr	

TRDT-UNFUND	TRDT-UNFND-SELL	Dr	with unfunded amount
TRDT-MEMO	TRDT-UNFND-SELL	Cr	

During cancellation (TCNC) after trade amendment (TAMD) of decrease in trade amount of SELL trade, the following set of accounting entry is posted:

Accounting Role	Amount Tag	Dr/ Cr	Remarks
TRDT-SELL	TRDT-AMD-SELL	Cr	Funded percentage amount
TRDT-REC	TRDT-AMD-SELL	Dr	
TRDT-PREM-DISC	TRDT-AMDIS-SELL	Dr	In case trade is at discount
TRDT-REC	TRDT-AMDIS-SELL	Cr	
TRDT-PREM-DISC	TRDT-AMPRM-SELL	Cr	In case trade is at premium
TRDT-REC	TRDT-AMPRM-SELL	Dr	
TRDT-UNFUND	TRDT-AMUNFD-SEL	Cr	with unfunded amount

8.1.6.5 TSTL: Trade Settlement

Accounting Role	Amount Tag	Dr/ Cr	Remarks
SLT-ASSET-OFFGL	SLT-NOM-BUY	D	Entries posted into Asset GL on the Trade Date are reversed for Buy
SLT-ASSETGL	SLT-NOM-BUY	C	
SLT-ASSETGL	SLT-NOM-SEL	D	Entries posted into Asset GL on the Trade Date are reversed for Sell
SLT-ASSET-OFFGL	SLT-NOM-SEL	C	
SLT-RLZD-PROFIT	SLT-SETL-PRFT	D	Entries posted during trade settlement to move the realized profit from one accounting head to another
SLT- SETL -PROFIT	SLT-SETL-PRFT	C	
SLT-SETL-LOSS	SLT-SETL-LOSS	D	Entries posted during trade settlement to move the realized loss from one accounting head to another
SLT-RLZD-LOSS	SLT-SETL-LOSS	C	
UNSETL-PNL-BS	PNL_PRMDIS_SWG	C	Entries posted during the trade settlement (Swing between Unsettled PNL BS and Premium Discount GL
Premium Discount GL	PNL_PRMDIS_SWG	D	

8.1.6.6 Buy Settlement

Accounting Role	Amount Tag	Dr/Cr	Remarks
SLT-BRIDGE-GL	SLT-NOMINAL-FUND-BUY	D	Entries posted to record Settlement of Buy
SLT_SETTLEMENT	SLT-NOMINAL-FUND-BUY	C	These entries are split further based on fund/unfunded, buy/sell break ups
SLT-PREM-DISC	SLT-PREMDISC-BUY	C	These three entries are the consolidated entries for the sake of understanding. The actual entries are mentioned below
SLT-BRIDGE-GL	NOM-FND-BUY	D	Asset booking through Bridge for Buy
CUSTOMER	NOM-FND-BUY	C	
CUSTOMER	FND-PRM-BUY	C	Premium Price factor on fund amount for BUY
SLT-PREM-DISC	FND-PRM-BUY	D	

CUSTOMER	FND-DIS-BUY	D	Discount Price factor on fund amount for BUY
SLT-PREM-DISC	FND-DIS-BUY	C	
CUSTOMER	UNFND-PRM-BUY	C	Premium Price factor on unfunded amount for BUY
SLT-PREM-DISC	UNFND-PRM-BUY	D	
CUSTOMER	UNFND-DIS-BUY	D	Discount Price factor on unfunded amount for BUY
SLT-PREM-DISC	UNFND-DIS-BUY	C	

Sell Settlement

Accounting Role	Amount Tag	Dr/Cr	Remarks
SLT_SETTLEMENT	SLT-NOMINAL-FUND-SEL	D	Entries posted to record Settlement of Sell
SLT-BRIDGE-GL	SLT-NOMINAL-FUND-SEL	C	These entries are split further based on fund/unfunded, buy/sell break ups
SLT-PREM-DISC	SLT-PREMDISC-SEL	D	These three entries are the consolidated entries for the sake of understanding. The actual entries are mentioned below
SLT-BRIDGE-GL	NOM-FND-SEL	C	Asset booking through Bridge for Sell
CUSTOMER	NOM-FND-SEL	D	
CUSTOMER	FND-PRM-SEL	D	Premium Price factor on fund amount for Sell
SLT-PREM-DISC	FND-PRM-SEL	C	
CUSTOMER	FND-DIS-SEL	C	Discount Price factor on fund amount for Sell
SLT-PREM-DISC	FND-DIS-SEL	D	
CUSTOMER	UNFND-PRM-SEL	D	Premium Price factor on unfunded amount for Sell
SLT-PREM-DISC	UNFND-PRM-SEL	C	
CUSTOMER	UNFND-DIS-SEL	C	Discount Price factor on unfunded amount for Sell
SLT-PREM-DISC	UNFND-DIS-SEL	D	

Additional Entries for Origination Sell

Accounting Role	Amount Tag	Dr/Cr	Remarks
SLT_PREM_DISC	UNAMORT-FEE	C	
SLT_RES-RV_BRIDGE_GL	SLT-RES-SEL	D	Portion of the Reserve settlement
SLT-PREM-DISC	SLT-RES-SEL	C	
SLT_CONTRA_BRIDGE_GL	SLT-CON-SEL	D	Portion of the Contra settlement
SLT-PREM-DISC	SLT-CON-SEL	C	
SLT-PREM-DISC	SLT-RLZD-PRFT	D	Trade Profit (COC)
SLT-RLZD-PROFIT	SLT-RLZD-PRFT	C	

Assignment Fee

Accounting Role	Amount Tag	Dr/ Cr	Remarks
<component>EXP	<component>_SPT1	D	Assignment FEE - bank contribution
<component>PAY	<component>_SPT1	C	
CUSTOMER	<component>_SPT2	D	Assignment FEE - CPARTY contribution
<component>PAY	<component>_SPT2	C	
<component>PAY	<component>_LIQD	D	Assignment FEE - Settlement to Agent
AGENT	<component>_LIQD	C	
<component>PAY	<component>_CPTY	D	Assignment FEE - Settlement to CPARTY
CUSTOMER	<component>_CPTY	C	

Delayed Compensation Fee

Accounting Role	Amount Tag	Dr/Cr	Remarks
CUSTOMER	<component>_REC-CCY	D	Prime all in rate Interest for Buy transaction
DCFREC	<component>_REC-CCY	C	
			Always paid from seller to buyer
DCFPAY	<component>_PAY-CCY	D	Prime all in rate Interest for Sell transaction
CUSTOMER	<component>_PAY-CCY	C	
DCFPAY	<component>_PAY-CCY	D	Prime Average Libor Interest for Buy transaction (Cost of Funds)
CUSTOMER	<component>_PAY-CCY	C	
			Always paid from buyer to seller
CUSTOMER	<component>_REC-CCY	D	Prime Average Libor Interest for Sell transaction (Cost of Funds)
DCFREC	<component>_REC-CCY	C	

DCFPAY	<component>_PAY-CCY	D	Cost of carry for Buy Transaction for Prime
CUSTOMER	<component>_PAY-CCY	C	Always paid from buyer to seller. Its applicable for distress trades
CUSTOMER	<component>_REC-CCY	D	Cost of carry for Sell Transaction for prime
DCFREC	<component>_REC-CCY	C	
DCFPAY	<component>_PAY-CCY	D	Cost of carry for Buy Transaction for Libor
CUSTOMER	<component>_PAY-CCY	C	
			Always paid from buyer to seller. Its applicable for distress trades
CUSTOMER	<component>_REC-CCY	D	Cost of carry for Sell Transaction for Libor
DCFREC	<component>_REC-CCY	C	
CUSTOMER	<component>_REC-CCY	D	Libor Margin for Buy transaction
DCFREC	<component>_REC-CCY	C	
			Always paid from seller to buyer.
DCFPAY	<component>_PAY-CCY	D	Libor Margin for Sell transaction
CUSTOMER	<component>_PAY-CCY	C	
CUSTOMER	<component>_REC-CCY	D	Libor all in rate Interest for Buy transaction
DCFREC	<component>_REC-CCY	C	
			Always paid from seller to buyer. Its applicable for distress trades
DCFPAY	<component>_PAY-CCY	D	Libor all in rate Interest for Sell transaction
CUSTOMER	<component>_PAY-CCY	C	
CUSTOMER	<component>_REC-CCY	D	Commitment FEE DCF for Buy transaction

DCFREC	<component>_REC- CCY	C	
			Always paid from seller to buyer
DCFPAY	<component>_PAY- CCY	D	Commitment FEE DCF for Sell transaction
CUSTOMER	<component>_PAY- CCY	C	
CUSTOMER	<component>_REC- CCY	D	Facility FEE DCF for Buy transaction
DCFREC	<component>_REC- CCY	C	
			Always paid from seller to buyer
DCFPAY	<component>_PAY- CCY	D	Facility FEE DCF for Sell transaction
CUSTOMER	<component>_PAY- CCY	C	
CUSTOMER	<component>_REC- CCY	D	Standby LC DCF for Buy transaction
DCFREC	<component>_REC- CCY	C	
			Always paid from seller to buyer
DCFPAY	<component>_PAY- CCY	D	Standby LC DCF for Sell transaction
CUSTOMER	<component>_PAY- CCY	C	
CUSTOMER	<component>_REC- CCY	D	Commercial LC DCF for Buy transaction
DCFREC	<component>_REC- CCY	C	
			Always paid from seller to buyer
DCFPAY	<component>_PAY- CCY	D	Commercial LC DCF for Sell transaction
CUSTOMER	<component>_PAY- CCY	C	

Break Funding Fee

Accounting Role	Amount Tag	Dr/ Cr	Remarks
<component>EXP	<component>_PAY-CCY	D	Break funding to be paid by BANK
CUSTOMER	<component>_PAY-CCY	C	
CUSTOMER	<component>_REC-CCY	D	Break funding to be received by BANK
<component>INC	<component>_REC-CCY	C	

Amendment Fee

Accounting Role	Amount Tag	Dr/ Cr	Remarks
<component>PAY	<component>_PAY	D	Amendment Fees for Sell
CUSTOMER	<component>_PAY	C	
			Always paid from seller to buyer
CUSTOMER	<component>_REC	D	Amendment Fees for Buy
<component>REC	<component>_REC	C	

Adhoc Fee

Accounting Role	Amount Tag	Dr/ Cr	Remarks
<Component>EXP	<Component>_PAY	D	Fee type=ADHOC SELLER and SELL trade Fee type=ADHOC BUYER and BUY trade
CUSTOMER	<Component>_PAY	C	Fee type=ADHOC SELLER and SELL trade Fee type=ADHOC BUYER and BUY trade
CUSTOMER	<Component>_REC	D	Fee type=ADHOC SELLER and BUY trade Fee type=ADHOC BUYER and SELL trade
<Component>INC	<Component>_REC	C	Fee type=ADHOC SELLER and BUY trade Fee type=ADHOC BUYER and SELL trade

Trade Dated CFPI Accounting Entries for Buy Trade

Accounting Role	Amount Tag	Dr/ Cr	Remarks
TRDT-FND-PAY	TRDT-FND-BUY	Dr	Trade portion of funded amount
STDT-FUND-CTL1	TRDT-FND-BUY	Cr	Trade portion of funded amount
TRDT-MEMO	TRDT-UNFND-BUY	Dr	Trade portion of unfunded amount
TRDT-UNFND	TRDT-UNFND-BUY	Cr	Trade portion of unfunded amount
STDT-PMDSC-CTL3	TRDT-DIS-BUY	Dr	Discount amount
TRDT-DISC-PAY	TRDT-DIS-BUY	Cr	Discount amount
STDT-PMDSC-CTL3	TRDT-PRM-BUY	Cr	Premium amount
TRDT-PRM-PAY	TRDT-PRM-BUY	Dr	Premium amount

Trade Dated CFPI Accounting Entries for Sell Trade

Accounting Role	Amount Tag	Dr/ Cr	Remarks
TRDT-FND-REC	TRDT-FND-SELL	Cr	Trade portion of funded amount
STDT-FUND-CTL1	TRDT-FND-SELL	Dr	Trade portion of funded amount
TRDT-MEMO	TRDT-UNFND-SELL	Cr	Trade portion of unfunded amount
TRDT-UNFND	TRDT-UNFND-SELL	Dr	Trade portion of unfunded amount
STDT-PMDSC-CTL3	TRDT-DIS-SELL	Cr	Discount amount
TRDT-DISC-REC	TRDT-DIS-SELL	Dr	Discount amount
STDT-PMDSC-CTL3	TRDT-PRM-SELL	Dr	Premium amount
TRDT-PRM-REC	TRDT-PRM-SELL	Cr	Premium amount

Additional entries for cost of credit valuation

Accounting Role	Amount Tag	Dr/ Cr	Remarks
SLTCONCOGGL	COC-CON-RECO	D	Contra Recovery
CONRECOGL	COC-CON-RECO	C	Contra Recovery
SLTWOFFCOGGL	COC-WOFF-RECO	D	Write-off Recovery
WOFFRECOGL	COC-WOFF-RECO	C	Write-off Recovery
MARKS_FEEPAY	MARKS-FEE-RECO	D	Marks Recovery
MARKSRECOGL	MARKS-FEE-RECO	C	Marks Recovery
UNAMORT-COCGL	UNAMORT-RECO	D	Unamort Recovery
UNAMORT-TRECOGL	UNAMORT-RECO	C	Unamort Recovery
SLTCONCOGGL	COC-CON-NET	D	Contra Net
SLT-PREM-DISC	COC-CON-NET	C	Contra Net
SLTWOFFCOGGL	COC-WOFF-NET	D	Write-off Net
SLT-PREM-DISC	COC-WOFF-NET	C	Write-off Net
MARKS_FEEPAY	MARKS-FEE-NET	D	Marks Net
SLT-PREM-DISC	MARKS-FEE-NET	C	Marks Net
UNAMORT-COCGL	UNAMORT-NET	D	Unamort Net
SLT-PREM-DISC	UNAMORT-NET	C	Unamort Net

8.1.6.7 REVL: Revaluation

Accounting Role	Amount Tag	Dr/Cr	Remarks
UNREAL_MTM_OFF	UNRLZD-PRFT	D	
UNREAL_MTM_INC	UNRLZD-PRFT	C	
UNREAL_MTM_EXP	UNRLZD-LOSS	D	
UNREAL_MTM_OFF	UNRLZD-LOSS	C	
UNREAL_MTM_EXP	UNRLZD-SH-LOSS	D	Existing P&L GL Mark to Market –Loss
UNREAL_SMTM_BAL	UNRLZD-SH-LOSS	C	New Liability GL Mark to Market –Loss
UNREAL_SMTM_BAL	UNRLZD-SH-PRFT	D	New Liability GL Mark to Market - Profit
UNREAL_MTM_INC	UNRLZD-SH-PRFT	C	Existing P&L GL Mark to Market - Profit

8.1.6.8 RRVL: Revaluation Reversal

No accounting entries are involved.

8.1.6.9 PRCL - Position Reclass

Accounting Role	Amount Tag	Dr/Cr	Remarks
TRDT-FND-BAL	TRDT-INV-RCL	D	Existing Asset GL Funded Inventory
TRDT-SPOS-INV	TRDT-INV-RCL	C	New Liability GL Funded Inventory
TRDT-PRMDSC-BAL	TRDT-PRMRCL-INC	D	Existing Asset GL Premium/ Discount Increase

TRDT-SH-PRMDSC	TRDT-PRMRCL-INC	C	New Liability GL Premium/Discount Increase
TRDT-SH-PRMDSC	TRDT-PRMRCL-DEC	D	New Liability GL Premium/ Discount Decrease
TRDT-SH-PRMDSC	TRDT-PRMRCL-DEC	C	Existing Asset GL Premium/Discount Decrease

FACR: DCF Accrual

Accounting Role	Amount Tag	Dr/Cr	Remarks
DCFREC	<component>_RFCR-CCY	D	Prime all in rate Interest for Buy transaction
DCFINC	<component>_RFCR-CCY	C	
			Always paid from seller to buyer
DCFEXP	<component>_PFCR-CCY	D	Prime all in rate Interest for Sell transaction
DCFPAY	<component>_PFCR-CCY	C	
DCFEXP	<component>_PFCR-CCY	D	Prime Average Libor Interest for Buy transaction (Cost of Funds)
DCFPAY	<component>_PFCR-CCY	C	
			Always paid from buyer to seller
DCFREC	<component>_RFCR-CCY	D	Prime Average Libor Interest for Sell transaction (Cost of Funds)
DCFINC	<component>_RFCR-CCY	C	
DCFEXP	<component>_PFCR-CCY	D	Cost of carry for Buy Transaction (for both prime and Libor)
DCFPAY	<component>_PFCR-CCY	C	
			Always paid from buyer to seller. Its applicable for distress trades
DCFREC	<component>_RFCR-CCY	D	Cost of carry for Sell Transaction (for both prime and Libor)
DCFINC	<component>_RFCR-CCY	C	
DCFREC	<component>_RFCR-CCY	D	Libor Margin for Buy transaction
DCFINC	<component>_RFCR-CCY	C	
			Always paid from seller to buyer.
DCFEXP	<component>_PFCR-CCY	D	Libor Margin for Sell transaction
DCFPAY	<component>_PFCR-CCY	C	

DCFREC	<component>_RFCR- CCY	D	Libor all in rate Interest for Buy transaction
DCFINC	<component>_RFCR- CCY	C	
			Always paid from seller to buyer. Its applicable for distress trades
DCFEXP	<component>_PFCR- CCY	D	Libor all in rate Interest for Sell transaction
DCFPAY	<component>_PFCR- CCY	C	
DCFREC	<component>_RFCR- CCY	D	Commitment FEE DCF for Buy transaction
DCFINC	<component>_RFCR- CCY	C	
			Always paid from seller to buyer
DCFEXP	<component>_PFCR- CCY	D	Commitment FEE DCF for Sell transaction
DCFPAY	<component>_PFCR- CCY	C	
DCFREC	<component>_RFCR- CCY	D	Facility FEE DCF for Buy transaction
DCFINC	<component>_RFCR- CCY	C	
			Always paid from seller to buyer
DCFEXP	<component>_PFCR- CCY	D	Facility FEE DCF for Sell transaction
DCFPAY	<component>_PFCR- CCY	C	
DCFREC	<component>_RFCR- CCY	D	Standby LC DCF for Buy transaction
DCFINC	<component>_RFCR- CCY	C	
			Always paid from seller to buyer
DCFEXP	<component>_PFCR- CCY	D	Standby LC DCF for Sell transaction
DCFPAY	<component>_PFCR- CCY	C	
DCFREC	<component>_RFCR- CCY	D	Commercial LC DCF for Buy transaction

DCFINC	<component>_RFCR- CCY	C	
			Always paid from seller to buyer
DCFEXP	<component>_PFCR- CCY	D	Commercial LC DCF for Sell transaction
DCFPAY	<component>_PFCR- CCY	C	

FACR: Ammendment Fee Accrual

Event	Dr/Cr	Amount Tag	Accounting Role	Buy/Sell	Remarks
FACR	Dr	AMENDF_PACR	AMENDEXP	Sell	Accrual for the payable portion of amendment fee
FACR	Cr	AMENDF_PACR	AMENDPAY	Sell	
FACR	Dr	AMENDF_RACR	AMENDREC	Buy	Accrual for the receivable portion of amendment fee
FACR	Cr	AMENDF_RACR	AMENDINC	Buy	

8.1.6.10 RESV: Reserve Calculation

Accounting Role	Amount Tag	Dr/Cr	Remarks
SLT-RES-EXP	SLT-RESV-OFFSET	Cr	Entries to be posted for reversal of previous Reserve data
SLT-RES-LBY	SLT-RESV-OFFSET	Dr	
SLT-RES-EXP	SLT-RESV	Dr	Entries to be posted for Reserve calculation
SLT-RES-LBY	SLT-RESV	Cr	

8.1.6.11 FLIQ: Fee Liquidation

Amendment Fee

Accounting Role	Amount Tag	Dr/Cr	Remarks
<component>PAY	<component>_PAY	D	Amendment Fees for Sell
CUSTOMER	<component>_PAY	C	
			Always paid from seller to buyer
CUSTOMER	<component>_REC	D	Amendment Fees for Buy
<component>REC	<component>_REC	C	
<component>PAY	<component>_PADJ	D	Amendment Fees for Sell (delta increase)
CUSTOMER	<component>_PADJ	C	
<component>PAY	<component>_PADJ	C	Amendment Fees for Sell (delta decrease)
CUSTOMER	<component>_PADJ	D	
			Always paid from seller to buyer
CUSTOMER	<component>_RADJ	D	Amendment Fees for Buy (delta increase)
<component>REC	<component>_RADJ	C	
CUSTOMER	<component>_RADJ	C	Amendment Fees for Buy (delta decrease)
<component>REC	<component>_RADJ	D	

Brokerage

Accounting Role	Amount Tag	Dr/Cr	Remarks
<component>EXP (PAID)	<component>_PAY	D	If brokerage applicable, its always paid by the bank entity to broker through Payable GLs
<component>PAY (Payable)	<component>_PAY	C	
<component>EXP (PAID)	<component>_PADJ	D	In case of any increase in amount after the initial liquidation
<component>PAY (Payable)	<component>_PADJ	C	
<component>EXP (PAID)	<component>_NADJ	C	In case of any decrease in amount after the initial liquidation
<component>PAY (Payable)	<component>_NADJ	D	

8.1.7 Maintaining SLT Accounting Entries

- You can reclass the below mentioned balances from the existing long position GL to the new short position GL for CBNA/CNAI and CFPI positions.
 - Funded Inventory
 - Premium / Discount
 - Mark to Market
 - You can create conversion process for the below.
 - To bifurcate single trade receivable-payable account into separate receivable and payable accounts for CFPI positions.
 - To replace existing payable and receivable accounts with new GL accounts for CBNA and CNAI positions.
1. Changes are done in trading module to move the below mentioned balances under new liability ledger accounts.

Balance Type	Amount to be Reclassed/Moved to the Liability GL
Funded Inventory	Total short position* Funded% as of system date
Premium/Discount	(1 – WAC) * Total short position
Mark to Market	(Market Price – WAC) * Total short position

- During end of day, Oracle Banking Corporate Lending reclass the short positions for each balance and post the accounting entries under position contract in the below events.

Balance Type	Event
Funded Inventory	PRCL - Position Reclass (new event)
Premium/Discount	PRCL
Mark to Market	REVL (Existing revaluation event)

- A new process is introduced in SLT end of day batch (LTAUTDLY). The new process posts the new set of entries for PRCL and REVL under position contract as mentioned below, if the position is short for the CUSIP.

If funded balance exists in LB then reclass entries are posted for funded inventory under PRCL event.

- [Absolute of short position* funded% as of system date] debits the existing asset GL and credit the new liability GL.
 - Funded % is computed as [(Total Drawdown Outstanding / Transfer available amount) * Trade amount].
 - Total Drawdown outstanding is the sum of all outstanding drawdown balances including LC drawdowns in tranche currency as of the system date.
 - Transfer available amount = [Tranche available amount + Drawdown outstanding amount] as of system date.
- If WAC is not 100, then premium / discount entries are posted under PRCL event as part of reclass.
 - If WAC < 100 then [absolute of short position * (1-WAC)] is credited to the existing P/D GL and new P/D GL will be debited
 - If WAC > 100 then [absolute of short position * (1-WAC)] debits the existing P/D GL and new P/D GL is credited
- Entries of PRCL are reversed next day as part of RPCL (Reversal of Position Reclass) event with negative amount.
- RPCL event can be configured in Oracle Banking Corporate Lending such that the reversal can happen in Beginning of Day or End of Day (in EOTI).

PRCL Example for Funded Inventory and Premium Discount

Date	Trade Activity	Total Position	Trade Price	WAC	Market Price
Day 1	Trade1: Buy 1M	1,000,000.00	98	98	98
Day 2	Trade2: Sell 2M	-1,000,000.00	98.2	98.2	98.2

- Day 1 EOD – No entries are posted as the position is positive; not short
- Day 2 EOD – PRCL entries are posted as below.

Transfer Available	Tranche Outstanding	Funded %
1,000,000.00	800,000.00	80%

D/C	Amount Tag	Accounting Role	Amount
Dr	TRDT-INV-RCL	TRDT-FND-BAL	800,000.00
Cr	TRDT-INV-RCL	TRDT-SPOS-INV	800,000.00
Dr	TRDT-PRMRCL-INC	TRDT-PRMDSC-BAL	18,000.00
Cr	TRDT-PRMRCL-INC	TRDT-SH-PRMDSC	18,000.00

If position is not short then the existing REVL entries are posted; otherwise REVL entries are posted for the short position based on the new proposed accounting entries.

Example for MTM

Date	Trade Activity	Total Position	Trade Price	WAC	Market Price
Day1	Trade1: Buy 1M	1,000,000.00	98	98	98
Day2	Market price change			98	98.15
Day3	Trade2: Sell 2M	-1,000,000.00	98.2	98.2	98.2
Day4	Market price change	-1,000,000.00	98.2	98.2	98.5
Day5	Market price change			98.2	97.8

Day 2 EOD - Existing REVL entries are posted as below; the entries are reversed on day 3 BOD. Amount is in negative during RRVL

D/C	Amount Tag	Accounting Role	Amount
Dr	UNRLZD-PRFT	UNREAL_MTM_OFF	1,500.00
Cr	UNRLZD-PRFT	UNREAL_MTM_INC	1,500.00

Day 3 EOD – MTM entries are not posted as WAC and market price are same. Price change also happened on day 3.

- Day 4 EOD - New proposed MTM entries are posted as the position is short. Loss entries are posted though market price is greater than WAC because of short position. Entries are reversed in Day 5 BOD. Amount is in negative during RRVL

D/C	Amount Tag	Accounting Role	Amount
Dr	UNRLZD-SH-LOSS	UNREAL_MTM_EXP	3,000.00
Cr	UNRLZD-SH-LOSS	UNREAL_SMTM_BAL	3,000.00

Day 5 EOD - New proposed MTM entries are posted for profit as market price is lesser than WAC and the position is short.

D/C	Amount Tag	Accounting Role	Amount
Dr	UNRLZD-SH-PRFT	UNREAL_SMTM_BAL	4,000.00
Cr	UNRLZD-SH-PRFT	UNREAL_MTM_INC	4,000.00

- During beginning of day, previous day entries are reversed for PRCL and REVL events. RPCL (Reversal of position reclass) is the reversal event for PRCL. Existing RRVL is used to post reversal entries for MTM position. Accounting entries are not required to be maintained for the reversal events.
- CUSIP currency is used for PRCL, REVL, RRVL and RPCL events.
- The changes are applicable only for the SLT trades involving Par and Distress desks.

Note

CLP trades are not applicable.

8.1.8 LOR Accounting Entries

Participant case (Sell type Deal type Assignment)

- During trade settlement the system populates LOR adjustment data in the funding memo.
- If you select the 'Settled Interest' check box, the buyer pays the seller on the 'Settlement Date' an amount equal to interest or fees accrued to the 'Settlement Date'.
- During trade settlement the system posts the accounting entries during TSTL event.

Accounting Role	Amount Tags	Dr/Cr. Indicator	Description
CUSTOMER	LOR_INT-ADJ-BUY	Cr	These entries relate to Buy trade for an Participant case with Deal type as Assignment
LOR_INT-ADJ	LOR_INT-ADJ-BUY	Dr	

CUS-TOMER	LOR_INT-ADJ-SELL	Dr	These entries relate to Sell trade for an Participant case with Deal type as Assignment
LOR_INT-ADJ	LOR_INT-ADJ-SELL	Cr	

Participant case (Buy type Deal type Assignment)

- During trade settlement the system does not populate the LOR adjustment data in the funding memo.
- You can input manually any amount in interest and fee fields as part of manual LOR Adjustment.
- During trade settlement the system posts the accounting entries during TSTL event.

Accounting Role	Amount Tags	Dr/Cr. Indicator	Description
CUS-TOMER	LOR_INT-ADJ-BUY	Cr	These entries relate to Buy trade for an Participant case with Deal type as Assignment
LOR_IN TADJ	LOR_INT-ADJ-BUY	Dr	
CUS-TOMER	LOR_INT-ADJ-SELL	Dr	These entries relate to Sell trade for an Participant case with Deal type as Assignment
LOR_IN TADJ	LOR_INT-ADJ-SELL	Cr	

9. Jobs and EOD Batches

Following are the jobs and EOD batch operations for SLT module.

Module	Job Name	Type	Description
TL	CLTLSHOFF	PLSQL	To process the settlement data from Secondary Loan Trading module to Loan syndication module after the Combined Ticket settlement
TL	LQTTRDUP	PLSQL	To enrich and process the trade received from external system LQT
TL	LTLQTMNB	PLSQL	The system identifies the trades from LQT browser based on the counterparty mnemonic and will check the settled trade status. SSI mnemonic is re-picked up based on the new counterparty. Once successfully processed, the system updates the process status as Processed
TL	LTLSHOFF	PLSQL	To process the settlement data from Secondary Loan Trading module to Loan syndication module after the trade settlement
TL	LTMTSTL	PLSQL	On save of Combined ticket settlement a background job process performs the trade settlement for each of the trades under the ticket.
TL	LTKTSTL	PLSQL	On save of ticket settlement a background job process performs the trade settlement for each of the trades under the ticket.
TL	MKLTTTRDSTL	PLSQL	Processing data which is inserted in OBCL table for processing message director
TL	MKTTRDCON	PLSQL	Processing incoming message from Message director interface into OBCL
TL	TRADEUPD	PLSQL	<p>1. LS-SLT -After creation of the LS Tranche Contract, if there are any self participants, for those participants a Handoff is given to SLT side and a corresponding trade record is populated in upload master with source as 'LSORIG' and process status with 'S'. Job picks the contract and proceeds for new trade contract creation.</p> <p>2. SLT Trade - Job is running to fetch the unprocessed draft trade records and process them into actual SLT trade</p>
TL	TLAUTSTL	PLSQL	It enable the automated settlement process.

10. Function ID Glossary

L

LBDDKMNT	3-4
LBDFWDPR	5-104
LBDLTHOF	7-5
LBDSL TIB	7-2

O

OLDACENT	6-30
OLDEVENT	6-29
OLDLNPRM	5-79
OLDMSGVW	6-31

T

TLCFMEMO	5-51
TLDAFMNT	3-20
TLDAGCON	5-87
TLDAMFEE	6-4
TLDAMFEH	6-8
TLDBDMNT	3-20
TLDBRPRM	3-1, 5-64
TLDCFTOL	6-36
TLDCOMRH	7-13
TLDCPMND	7-34
TLDCULNK	5-44
TLDCUMNT	3-18
TLDDCFLQ	6-34
TLDFEAMD	6-26
TLDFEECL	3-24
TLDFEELQ	6-33
TLDICMNT	3-23
TLDLBCIB	5-78
TLDLDIFB	7-9

TLDMKIFH	7-21
TLDMKTIF	7-18
TLDMTSAU	5-74
TLDMTSTL	5-71
TLDORGQU	5-33
TLDPEMAP	3-22
TLDPIMNT	3-11, 5-115
TLDPODCF	6-20
TLDPOMNT	3-6, 5-114
TLDPOSBL	5-37
TLDPOSDT	5-42
TLDPRCMT	3-16
TLDPRDMP	3-21
TLDPRMNT	3-5, 4-1, 6-14
TLDREHOF	7-11
TLDRTMCH	3-18
TLDRTMNT	3-15
TLDSETTL	5-47
TLDSTRCM	3-14, 7-15
TLDTDONL	5-2, 5-14
TLDTKSAU	5-63
TLDTKSTL	5-59
TLDTRDBW	7-14
TLDTRDQH	7-33
TLDTRDSQ	7-24, 7-27
TLSCULNK	5-46
TLSECURE	7-17
TLSERONL	5-10
TLSPQB	5-39
TLSTDONL'	5-25
TLSTDUPL	5-11