PeopleSoft ELM 9.2: Application Integration Framework

September 2023

This software and related documentation are provided under a license agreement containing restrictions on use and disclosure and are protected by intellectual property laws. Except as expressly permitted in your license agreement or allowed by law, you may not use, copy, reproduce, translate, broadcast, modify, license, transmit, distribute, exhibit, perform, publish, or display any part, in any form, or by any means. Reverse engineering, disassembly, or decompilation of this software, unless required by law for interoperability, is prohibited.

The information contained herein is subject to change without notice and is not warranted to be error-free. If you find any errors, please report them to us in writing.

If this is software, software documentation, data (as defined in the Federal Acquisition Regulation), or related documentation that is delivered to the U.S. Government or anyone licensing it on behalf of the U.S. Government, then the following notice is applicable:

U.S. GOVERNMENT END USERS: Oracle programs (including any operating system, integrated software, any programs embedded, installed, or activated on delivered hardware, and modifications of such programs) and Oracle computer documentation or other Oracle data delivered to or accessed by U.S. Government end users are "commercial computer software," "commercial computer software documentation," or "limited rights data" pursuant to the applicable Federal Acquisition Regulation and agency-specific supplemental regulations. As such, the use, reproduction, duplication, release, display, disclosure, modification, preparation of derivative works, and/or adaptation of i) Oracle programs (including any operating system, integrated software, any programs embedded, installed, or activated on delivered hardware, and modifications of such programs), ii) Oracle computer documentation and/or iii) other Oracle data, is subject to the rights and limitations specified in the license contained in the applicable contract. The terms governing the U.S. Government's use of Oracle cloud services are defined by the applicable contract for such services. No other rights are granted to the U.S. Government.

This software or hardware is developed for general use in a variety of information management applications. It is not developed or intended for use in any inherently dangerous applications, including applications that may create a risk of personal injury. If you use this software or hardware in dangerous applications, then you shall be responsible to take all appropriate fail-safe, backup, redundancy, and other measures to ensure its safe use. Oracle Corporation and its affiliates disclaim any liability for any damages caused by use of this software or hardware in dangerous applications.

Oracle®, Java, MySQL, and NetSuite are registered trademarks of Oracle and/or its affiliates. Other names may be trademarks of their respective owners.

Intel and Intel Inside are trademarks or registered trademarks of Intel Corporation. All SPARC trademarks are used under license and are trademarks or registered trademarks of SPARC International, Inc. AMD, Epyc, and the AMD logo are trademarks or registered trademarks of Advanced Micro Devices. UNIX is a registered trademark of The Open Group.

This software or hardware and documentation may provide access to or information about content, products, and services from third parties. Oracle Corporation and its affiliates are not responsible for and expressly disclaim all warranties of any kind with respect to third-party content, products, and services unless otherwise set forth in an applicable agreement between you and Oracle. Oracle Corporation and its affiliates will not be responsible for any loss, costs, or damages incurred due to your access to or use of third-party content, products, or services, except as set forth in an applicable agreement between you and Oracle.

Documentation Accessibility

For information about Oracle's commitment to accessibility, visit the Oracle Accessibility Program website at <https://docs.oracle.com/pls/topic/lookup?ctx=acc&id=docacc>.

Access to Oracle Support

Oracle customers that have purchased support have access to electronic support through My Oracle Support. For information, visit <https://docs.oracle.com/pls/topic/lookup?ctx=acc&id=info> or visit <https://docs.oracle.com/pls/topic/lookup?ctx=acc&id=trs> if you are hearing impaired.

Contents

- Preface: Preface.....vii**
- Understanding the PeopleSoft Online Help and PeopleBooks..... vii
- Hosted PeopleSoft Online Help..... vii
- Locally Installed Help..... vii
- Downloadable PeopleBook PDF Files..... vii
- Common Help Documentation..... vii
- Field and Control Definitions..... viii
- Typographical Conventions..... viii
- ISO Country and Currency Codes..... viii
- Region and Industry Identifiers..... ix
- Translations and Embedded Help..... ix
- Using and Managing the PeopleSoft Online Help..... x
- PeopleSoft Enterprise Components Related Links..... x
- Contact Us..... x
- Follow Us..... x
- Chapter 1: Getting Started with Application Integration Framework..... 11**
- Understanding the Application Integration Framework..... 11
- Application Integration Framework Implementation..... 11
- Define Value Maps..... 11
- Create Application Engine Transform Programs..... 11
- Update Service Operation Routing..... 12
- Chapter 2: Understanding Application Integration Framework..... 13**
- Application Integration Framework..... 13
- Use Cases for Application Integration Framework..... 14
- Maps..... 15
- Domain Value Map..... 15
- Cross-Reference Map..... 16
- Functions to Populate and Maintain the Cross-Reference and DVMS..... 16
- Use Case: Integration Broker Transformation Without AIA Middleware..... 18
- Use Case: Integration Broker Point-to-Point Transformation..... 22
- Use Case: Integration Broker Transformation in Which a Third Party Uses AIA Middleware..... 25
- Chapter 3: Defining and Populating Value Maps..... 31**
- Understanding Value Maps..... 31
- Defining Map Options..... 35
- Page Used to Define Value Map Options..... 35
- Value Map Options Page..... 35
- Defining Value Maps..... 38
- Pages Used to Define Value Maps..... 38
- Define Value Maps search Page..... 38
- Define Value Map - Elements Page..... 39
- Define options for a value map Page..... 41
- Define Value Maps - Domains Page..... 42
- Populating a Domain Value Map..... 44
- Page Used to Populate a Domain Value Map..... 44
- Domain Value Map Page..... 44
- Importing Value Maps..... 44

Page Used to Import Value Map.....	45
Understanding Import File Types Used with Value Maps.....	45
Import Value Maps Page.....	47
Exporting Value Maps.....	48
Understanding Export Schemas.....	48
Exporting a Value Map.....	49
Chapter 4: Creating Transform Programs and Updating Service Operations.....	51
Understanding Transform Programs.....	51
Creating a Transform Program.....	51
Updating Service Operation Routing.....	52
Chapter 5: Accessing Maps Using XSLT Extension.....	55
Understanding XSLT Extension Functions.....	55
Cross-Reference Functions.....	55
xref:BulkPopulateDomainData.....	55
xref:BulkPopulateElementData.....	56
xref:populateXRefRow.....	57
xref:populateXrefRowNVP.....	59
xref:markForDelete.....	62
xref:markForDeleteNVP.....	63
xref:lookupXRef.....	64
xref:lookupXRefNVP.....	65
Domain Value Map Functions.....	66
dvm:lookupValue.....	66
dvm:lookupValueNVP.....	68
dvm:lookup-dvm.....	69
Generate-Guid Function.....	70
generate-guid.....	70
SetID Functions.....	71
SetID:lookupSetCtrlValues.....	71
Chapter 6: Accessing Maps Using PeopleCode.....	75
Understanding Application Integration Framework Classes.....	75
How to Import Application Integration Framework Type Classes.....	75
DVM Utility Class Methods.....	76
ExtractData.....	76
LookupValue.....	77
LookupValue1M.....	78
LookupValueNVP.....	79
DVM Utility Class Properties.....	80
exceptionCaught.....	80
exceptionDetails.....	80
SetId Utility Class Methods.....	80
lookupSetCtrlValues.....	80
lookupSetID.....	82
Xref Utility Class Methods.....	83
BulkPopulateDomainData.....	83
BulkPopulateElementData.....	84
ExtractData.....	86
LookupValue.....	87
LookupValue1M.....	88
LookupValueNVP.....	89
MarkForDelete.....	90

MarkForDeleteNVP.....	91
PopulateData.....	92
PopulateValue.....	93
PopulateValueNVP.....	95
Xref Class Properties.....	96
exceptionCaught.....	97
exceptionDetails.....	97
Chapter 7: Accessing Maps Using Web Services.....	99
Understanding Application Integration Framework Web Services.....	99
EOTF_DVM Service.....	99
EOTF_DVM_LOOKUP.....	100
EOTF_DVM_IMPORT.v2.....	101
EOTF_DVM_IMPORT.v1.....	103
EOTF_XREF Service.....	104
EOTF_XREF_ADD.....	104
EOTF_XREF_LINK.....	105
EOTF_XREF_UPDATE.....	106
EOTF_XREF_DELETE.....	108
EOTF_XREF_LOOKUP.....	109
EOTF_XREF_IMPORT.v2.....	110
EOTF_XREF_IMPORT.v1.....	111
Cross-Reference Lookup Web Service Example.....	112
Chapter 8: Application Integration Framework Example.....	117
Example Overview.....	117
Defining a Dynamic Value Map.....	118
Defining and Populating a Static Value Map.....	119
Using the XSLT Extension Function in the Transformation Program.....	122
Key Value Transformation.....	122
Domain Value Transformation.....	124
Updating the Service Operation Routing.....	124

Preface

Understanding the PeopleSoft Online Help and PeopleBooks

The PeopleSoft Online Help is a website that enables you to view all help content for PeopleSoft applications and PeopleTools. The help provides standard navigation and full-text searching, as well as context-sensitive online help for PeopleSoft users.

Hosted PeopleSoft Online Help

You can access the hosted PeopleSoft Online Help on the [Oracle Help Center](#). The hosted PeopleSoft Online Help is updated on a regular schedule, ensuring that you have access to the most current documentation. This reduces the need to view separate documentation posts for application maintenance on My Oracle Support. The hosted PeopleSoft Online Help is available in English only.

To configure the context-sensitive help for your PeopleSoft applications to use the Oracle Help Center, see [Configuring Context-Sensitive Help Using the Hosted Online Help Website](#).

Locally Installed Help

If you're setting up an on-premise PeopleSoft environment, and your organization has firewall restrictions that prevent you from using the hosted PeopleSoft Online Help, you can install the online help locally. See [Configuring Context-Sensitive Help Using a Locally Installed Online Help Website](#).

Downloadable PeopleBook PDF Files

You can access downloadable PDF versions of the help content in the traditional PeopleBook format on the [Oracle Help Center](#). The content in the PeopleBook PDFs is the same as the content in the PeopleSoft Online Help, but it has a different structure and it does not include the interactive navigation features that are available in the online help.

Common Help Documentation

Common help documentation contains information that applies to multiple applications. The two main types of common help are:

- Application Fundamentals
- Using PeopleSoft Applications

Most product families provide a set of application fundamentals help topics that discuss essential information about the setup and design of your system. This information applies to many or all applications in the PeopleSoft product family. Whether you are implementing a single application, some combination of applications within the product family, or the entire product family, you should be familiar with the contents of the appropriate application fundamentals help. They provide the starting points for fundamental implementation tasks.

In addition, the *PeopleTools: Applications User's Guide* introduces you to the various elements of the PeopleSoft Pure Internet Architecture. It also explains how to use the navigational hierarchy, components, and pages to perform basic functions as you navigate through the system. While your application or implementation may differ, the topics in this user's guide provide general information about using PeopleSoft applications.

Field and Control Definitions

PeopleSoft documentation includes definitions for most fields and controls that appear on application pages. These definitions describe how to use a field or control, where populated values come from, the effects of selecting certain values, and so on. If a field or control is not defined, then it either requires no additional explanation or is documented in a common elements section earlier in the documentation. For example, the Date field rarely requires additional explanation and may not be defined in the documentation for some pages.

Typographical Conventions

The following table describes the typographical conventions that are used in the online help.

<i>Typographical Convention</i>	<i>Description</i>
Key+Key	Indicates a key combination action. For example, a plus sign (+) between keys means that you must hold down the first key while you press the second key. For Alt+W , hold down the Alt key while you press the W key.
... (ellipses)	Indicate that the preceding item or series can be repeated any number of times in PeopleCode syntax.
{ } (curly braces)	Indicate a choice between two options in PeopleCode syntax. Options are separated by a pipe ().
[] (square brackets)	Indicate optional items in PeopleCode syntax.
& (ampersand)	When placed before a parameter in PeopleCode syntax, an ampersand indicates that the parameter is an already instantiated object. Ampersands also precede all PeopleCode variables.
⇒	This continuation character has been inserted at the end of a line of code that has been wrapped at the page margin. The code should be viewed or entered as a single, continuous line of code without the continuation character.

ISO Country and Currency Codes

PeopleSoft Online Help topics use International Organization for Standardization (ISO) country and currency codes to identify country-specific information and monetary amounts.

ISO country codes may appear as country identifiers, and ISO currency codes may appear as currency identifiers in your PeopleSoft documentation. Reference to an ISO country code in your documentation does not imply that your application includes every ISO country code. The following example is a country-specific heading: "(FRA) Hiring an Employee."

The PeopleSoft Currency Code table (CURRENCY_CD_TBL) contains sample currency code data. The Currency Code table is based on ISO Standard 4217, "Codes for the representation of currencies," and also relies on ISO country codes in the Country table (COUNTRY_TBL). The navigation to the pages where you maintain currency code and country information depends on which PeopleSoft applications you are using. To access the pages for maintaining the Currency Code and Country tables, consult the online help for your applications for more information.

Region and Industry Identifiers

Information that applies only to a specific region or industry is preceded by a standard identifier in parentheses. This identifier typically appears at the beginning of a section heading, but it may also appear at the beginning of a note or other text.

Example of a region-specific heading: "(Latin America) Setting Up Depreciation"

Region Identifiers

Regions are identified by the region name. The following region identifiers may appear in the PeopleSoft Online Help:

- Asia Pacific
- Europe
- Latin America
- North America

Industry Identifiers

Industries are identified by the industry name or by an abbreviation for that industry. The following industry identifiers may appear in the PeopleSoft Online Help:

- USF (U.S. Federal)
- E&G (Education and Government)

Translations and Embedded Help

PeopleSoft 9.2 software applications include translated embedded help. With the 9.2 release, PeopleSoft aligns with the other Oracle applications by focusing our translation efforts on embedded help. We are not planning to translate our traditional online help and PeopleBooks documentation. Instead we offer very direct translated help at crucial spots within our application through our embedded help widgets. Additionally, we have a one-to-one mapping of application and help translations, meaning that the software and embedded help translation footprint is identical—something we were never able to accomplish in the past.

Using and Managing the PeopleSoft Online Help

Select About This Help in the left navigation panel on any page in the PeopleSoft Online Help to see information on the following topics:

- Using the PeopleSoft Online Help.
- Managing hosted Online Help.
- Managing locally installed PeopleSoft Online Help.

PeopleSoft Enterprise Components Related Links

[PeopleSoft Information Portal](#)

[My Oracle Support](#)

[PeopleSoft Training from Oracle University](#)

Contact Us

Send your suggestions to psft-infodev_us@oracle.com.

Please include the applications update image or PeopleTools release that you're using.

Follow Us

<i>Icon</i>	<i>Link</i>
	Watch PeopleSoft on YouTube
	Follow @PeopleSoft_Info on X.
	Read PeopleSoft Blogs
	Connect with PeopleSoft on LinkedIn

Chapter 1

Getting Started with Application Integration Framework

Understanding the Application Integration Framework

This product documentation describes using Application Integration Framework to create integrations between diverse systems using a common framework.

Application Integration Framework Implementation

Application Integration Framework uses PeopleSoft Integration Broker framework. These implementation steps assume PeopleSoft Integration Broker is configured and service operations have been created for the integration.

To implement Application Integration Framework, you will:

- Define value maps.
- Populate domain value maps.
- Create application engine transform programs.
- Update service operation routing.

See *PeopleTools: PeopleSoft Integration Broker*

Define Value Maps

To define value maps, perform the following steps:

Step	Reference
Define value maps	See Define Value Maps .

For more details, refer *Viewing Application Engine Programs* under *Development Tools*

Create Application Engine Transform Programs

To create the application engine transform program, perform the following steps:

Step	Reference
Create application engine program	See <i>PeopleTools: PeopleSoft Integration Broker</i> , Applying Filtering, Transformation and Translation, Defining Transform Programs.
Code the XSLT step	See <i>PeopleTools: PeopleSoft Integration Broker</i> , Creating Transform Programs and Updating Service Operations, Adding XSLT Steps to Transformation Programs.

Update Service Operation Routing

To update the service operation routing, perform the following steps:

Step	Reference
Update the routing	See <i>PeopleTools: PeopleSoft Integration Broker</i> , Creating Transform Programs and Updating Service Operations, Updating Service Operation Routing.

Chapter 2

Understanding Application Integration Framework

Application Integration Framework

Application Integration Framework extends PeopleSoft Integration Broker (IB) functionality to provide a standard way to represent, classify, store, query, publish, acquire, and invoke data that maps element names, structures, and values between PeopleSoft Application Business Messages (ABMs) and other applications. PeopleSoft Integration Broker provides the framework to send and receive messages with other PeopleSoft systems or third-party systems. If the message structure differs between systems, transformation programs are used to transform the incoming or outgoing message to a message format that the PeopleSoft system understands.

Each application that you are integrating with may use different data values or identifiers to represent the same information. For example, for a new customer in a PeopleSoft application, a new row is inserted in its customer database with a unique identifier such as *PS1001*. When the same information is propagated to an Oracle E-Business Suite application and a Siebel application, a new row should be inserted with different identifiers, such as *EBS1001* and *SBL1001*. The application integration framework enables you to transform this data.

Application Integration Architecture

Application Integration Architecture (AIA) is built on Oracle's Service Operation Architecture (SOA) as a unified approach for integrating business processes across applications, including third-party applications, based on a common architecture and common definition of business objects called Enterprise Business Objects (EBOs). These applications were designed using different technologies and use different names and structures to represent the same business object. AIA is the foundation for creating transformations on messages sent between diverse systems to integrate multiple applications without the need to create separate point-to-point integrations for each system involved.

AIA middleware can be used to transform business objects to a common object. Oracle's Fusion middleware includes AIA as well as prebuilt integrations for Oracle products.

Application Integration Framework Integrations

Application Integration Framework is designed to assist developers with the tasks required to produce integrations that are architected to be AIA-supportive. The integration produces ABMs with the same semantic content and approximately the same shape as the canonical (AIA) EBMs, thus minimizing transformation requirements. Each AIA-supportive integration that PeopleSoft applications delivers includes a sample transformation to enable the integrations to map as closely as possible to the EBOs. This strategy enables PeopleSoft customers to utilize IB to complete partner integrations without the need for middleware to perform transformations. Of course, customers who choose to purchase Oracle AIA middleware or who already own it can use the features of the EBS for transformations instead of or in addition to using the delivered IB samples.

Note: PeopleSoft-delivered integrations transform messages to the EBM format for direct integration with other Oracle products.

This diagram illustrates a PeopleSoft message transformed to a common value.

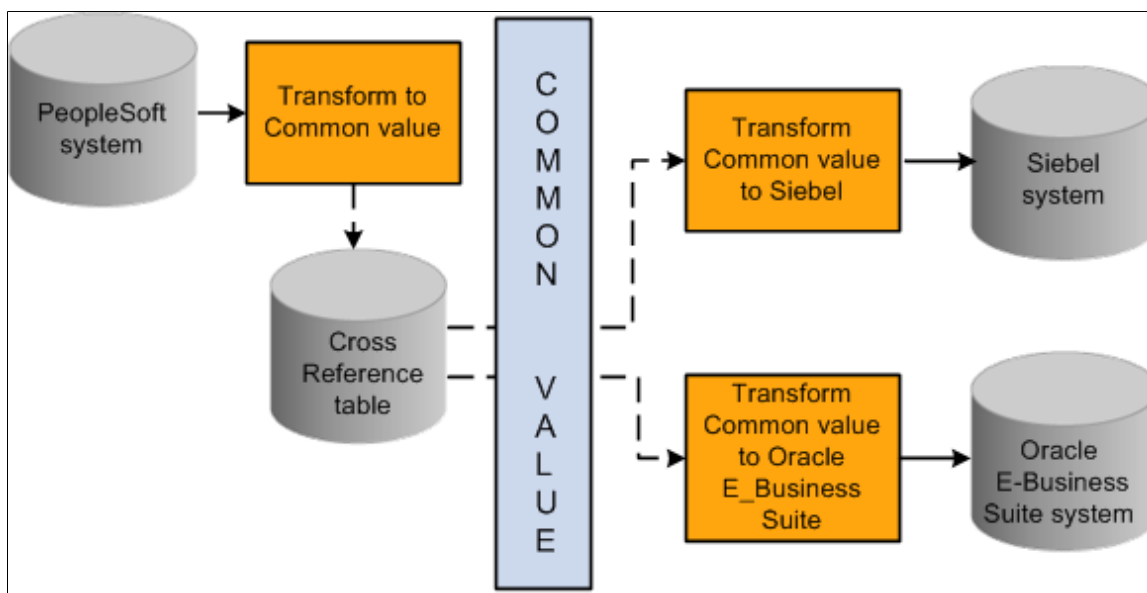

Use Cases for Application Integration Framework

Use cases fall into two categories:

- Key-mapping transforms using the dynamic cross-reference framework
- Static value transforms using the domain value map framework

These two frameworks are assumed to be separate; however, they in fact share common elements. The values of keys are open-ended and are usually extended; thus they are created programmatically during the transformation process, not in advance of the transform. Static value transforms generally have all values entered into the maps prior to the transformation process, and are less frequently extended.

In addition to these two categories, the integration use case depends on whether the third party is using AIA middleware.

This table shows where the transformations take place depending on whether AIA middleware is used:

Use Case	PeopleSoft Integration Broker	AIA Middleware	Third Party
Integration Broker Transformations without AIA middleware	Transform PeopleSoft ABM to EBM for outbound Transform EBM to PeopleSoft ABM for inbound	not used	Transform EBM to third-party ABM for inbound Transform third-party ABM to EBM for outbound

<i>Use Case</i>	<i>PeopleSoft Integration Broker</i>	<i>AIA Middleware</i>	<i>Third Party</i>
Integration Broker Point-to-Point transformation	Transform PeopleSoft ABM to third-party ABM for outbound Transform third-party ABM to PeopleSoft ABM for inbound	not used	No transformations are necessary Optionally, the third party can do the outbound transformation to PeopleSoft ABM.
Integration Broker Transformation in which third party uses AIA middleware	Transform PeopleSoft ABM to EBM for outbound Transform EBM to PeopleSoft ABM for inbound	Transform EBM to third-party ABM for outbound from PeopleSoft application Transform third-party ABM to EBM for inbound to PeopleSoft application	No transforms are performed

Maps

Two different kinds of maps are available, domain values maps (DVM) and cross-reference maps (XREF). The maps are similar in that both maps group elements by domain name and are composed of elements that map specific values from one domain to another. The difference from a technical perspective is that XREF values are constantly being created, whereas DVM values are relatively static.

<i>XREF</i>	<i>DVM</i>
Usually keys	Usually attributes
Data maintained programmatically	Data maintained manually through the user interface

Map cardinality provides an independent classification of the mapping functions. Maps are based on single values (1:1) or multivalued (N:N).

Domain Value Map

A Domain Value Map (DVM) is used for values that are relatively static and are relatively limited in total number, such as country codes and states. DVMs generally have all values entered into the maps prior to the transformation process, and are less frequently extended compared to cross-reference maps.

The DVM consists of domains, maps, and elements.

Term	Definition
Domain	A participating integrating system, for example, Siebel or Oracle E-Business Suite. <hr/> Note: Multiple domains can be maintained for a map. <hr/>
Maps	A static object for which the mapping needs to be maintained, for example, currency code or country code.
Element	The unit of data in the local or remote message upon which an irreducible transanimation operates. An irreducible transanimation is one that cannot be broken into smaller transformations. Most elements contain a single data value, but that may not always be the case. For example, an address could be represented as a single string, or it could be composed of separate strings representing city, state, street, and house number. Examples of DVM elements are country code and common value.

Cross-Reference Map

A cross-reference map is used for values that are dynamic in nature, such as key elements used to identify an instance. These are referred to as key maps or cross-references. The values are the names of larger data entities.

Cross-references consist of domains, maps, and elements.

Term	Definition
Domain	A participating integrating system, for example, Siebel or E-Business Suite. <hr/> Note: Multiple domains can be maintained for a map. <hr/>
Maps	A transaction object where the cross-reference for the keys is maintained, for example, voucher or vendor.
Element	An individual element captured as part of the key information, for example, SETID, VENDOR_ID.

Functions to Populate and Maintain the Cross-Reference and DVMs

Three types of functions are available to query and maintain the DVM and cross-reference data during the transformation process.

Term	Definition
Application Class methods	Application class methods are used in PeopleCode. These classes are typically used in cases in which the transformations are implemented as a PeopleCode step in an application engine program. These PeopleCode classes are used internally by the XPATH extension functions and by the web services.
XPath extension functions	XPath extension functions are used in the XSLT steps in application engine transform programs to invoke XSLT transforms using the TransformEx PeopleCode API.
Web services	Used by external systems to perform cross-reference lookups.

These functions enable you to query, manipulate, and delete cross-reference (XREF) and DVM data during transforms. The cardinality of the function is incorporated into the API naming convention. Each set of functions can be further broken down into three activities: lookup, populate, and delete.

The provided functions by class, activity, and form are:

Class	Activity	Form	Description
XREF	Populate	populateValue	Populate a transform item for a single valued element.
XREF	Populate	populateValue1M	Populate a transform element for a 1 to many mapping.
XREF	Populate	populateValueNVP	Populate a transform item for a multivalued element.
XREF	Delete	markForDelete	Mark for deletion a transform element for a single valued element. Items marked for delete can be reactivated later.
XREF	Delete	markForDeleteNVP	Mark for deletion a transform element for a multivalued element (name value pair).
XREF	Lookup	lookupValue	Look up a cross-reference value.
XREF	Lookup	lookupValue1M	Look up a cross-reference element for multiple values corresponding to a specific value in a reference element (1 to many).

Class	Activity	Form	Description
XREF	Lookup	lookupValueNVP	Look up a cross-reference value for a multivalued element.
DVM	Lookup	lookupValue	Look up a domain value.
DVM	Lookup	lookupValue1M	Look up multiple domain values corresponding to a specific value in a reference element.
DVM	Lookup	lookupValueNVP	Look up a domain value for a multivalued element.
DVM	Lookup	lookup-dvm	Look up a domain value.

Use Case: Integration Broker Transformation Without AIA Middleware

This section discusses the use case in which both the PeopleSoft and third-party map transformations take place within the PeopleSoft Integration Broker through Application Integration Framework. In this use case, PeopleSoft applications can take advantage of a canonical integration model without the need to purchase AIA middleware.

Use case includes:

- Outbound request or post to a third party.
- Inbound request or post from a third party.

Outbound Request or Post to a Third Party

This diagram illustrates an outbound request or post to a third party.

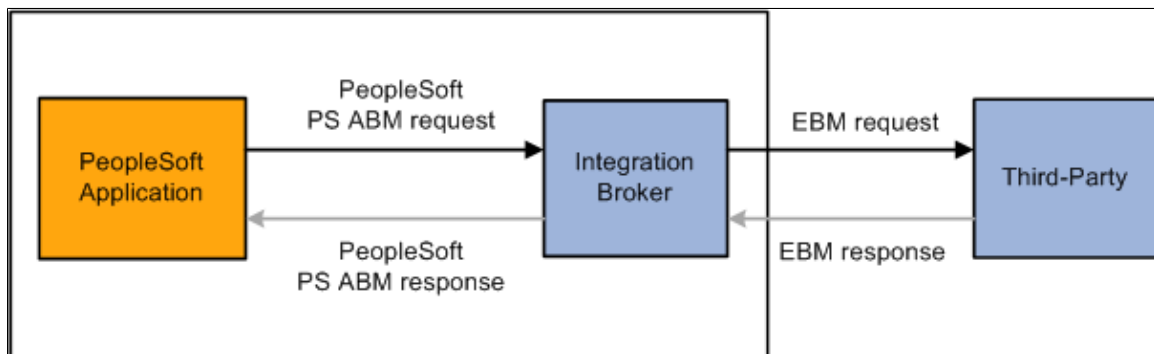

The following steps are performed in this scenario:

1. A user in the PeopleSoft system triggers publishing of an AIA supportive integration to a third-party system.
2. Within PeopleSoft Integration Broker, a transform on the outbound routing generates the EBM. The method used to translate the data values depends on the transaction. This table lists the transaction types and the necessary transformation action.

<i>Transaction</i>	<i>Action</i>
Dynamic key add-request	If the transaction is an add-request, the transform creates a new common key (GUID) and uses the appropriate form of the populate XRef XPath extension function to put the new common key and the corresponding PeopleSoft keys into the PeopleSoft cross-reference framework.
Dynamic key lookup	If the transaction is not an add-request, the transform looks up the common key using the appropriate form of the lookup XRef XPath extension function with the PeopleSoft keys as input. If a common key does not exist, the developer determines whether to create a new common key, generate an error, or return an error message in the reply message if the integration supports it.
Dynamic key delete request	For asynchronous notification (request-only) integrations that delete a keyed entity, developers may choose to leave the cross-reference values in place for historical purposes or, if desired, they may choose to delete the cross-reference values. To mark the PeopleSoft keys for deletion, the transform uses the appropriate form of the deleteXRef XPath extension function with the PeopleSoft keys as input.
Static value lookup	If the transaction uses a domain value map, the transform looks up the PeopleSoft values using the appropriate form of the lookupDVM XPath extension function with the PeopleSoft values as input. If a value is not found, the developer determines whether the transform supplies the PeopleSoft values by default, leaves them blank, throws an error, or returns an error message in the reply message if the integration supports it.

3. The EBM is routed to the third-party system for processing.

Integrations supporting response messages have these additional steps:

1. The third-party system processes the request, formats the reply message, and then returns it along with the common key or value.
2. Within PeopleSoft Integration Broker, asynchronous request-reply operations have a transform to look up the PeopleSoft keys using the appropriate form of the **lookupXref** XPath extension function with the common key as input. The PeopleSoft keys are then put into the PeopleSoft ABM.

Synchronous operations do not require this lookup because the PeopleSoft application already knows the PeopleSoft keys from the initial request.

Transaction	Action
Asynchronous request-reply operation using dynamic key value	Requires a transform program to look up the PeopleSoft keys using the appropriate form of the lookupXRef XPath extension function with the common key as input. The PeopleSoft keys are then put into the PeopleSoft ABM.
Synchronous operations using dynamic key value	Lookup is not required because the PeopleSoft application already knows the PeopleSoft keys from the initial request.
Asynchronous request-reply operation using DVM value	Requires a transform program to look up the PeopleSoft values using the appropriate form of the lookupDVM XPath extension function with the common value as input. The PeopleSoft keys are then put into the PeopleSoft ABM.

3. The PeopleSoft ABM reply is then returned to the originating PeopleSoft application.

Inbound Request or Post from a Third Party

This diagram illustrates an inbound request or post from a third party.

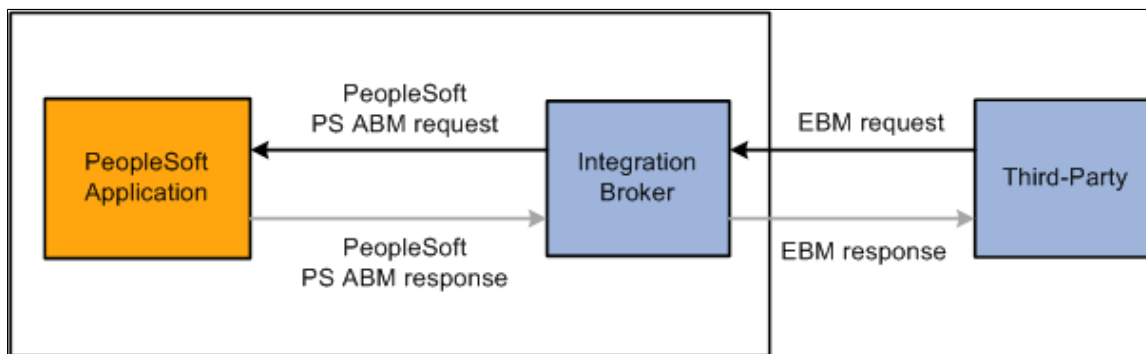

1. A user in the third-party system triggers publishing of an integration to a PeopleSoft system.
2. The EBM is routed to the PeopleSoft system for processing.
3. Within PeopleSoft Integration Broker, a transform on the inbound routing performs the following actions based on transaction type:

Transaction	Action
Dynamic key add request	If the transaction is an add-request, the transform leaves the PeopleSoft keys blank in the ABM and passes the common key along for use in the handler.

Transaction	Action
Dynamic key lookup	If the transaction is not an add-request, the transform looks up the PeopleSoft keys using the appropriate form of the lookup XRef XPath extension function with the common key in the EBM as input. Optionally, this can be done in the PeopleSoft inbound handler through the appropriate PeopleSoft lookup XRef API with the common key as input.
DVM lookup	The transform on the inbound routing looks up the PeopleSoft values using the appropriate form of the lookupDVM XPath extension function with the common value from the EBM. If a value is not found, the developer determines whether the transform supplies the PeopleSoft values, omits them, throws an error, or returns an error message in the reply message if the integration supports it.

4. The PeopleSoft inbound handler processes the message.

Transaction	Action
Dynamic key add request	If the transaction is an add-request, it creates the PeopleSoft keys and then uses the appropriate form of the populate XRef API to add the PeopleSoft keys and the corresponding common key to the PeopleSoft cross-reference framework. If the keys cannot be created or added to the framework, an error occurs or an error message is returned in the reply message if the integration supports it.
Dynamic key lookup	If the transaction is not an add-request, the message is processed with the PeopleSoft keys from the ABM. If the PeopleSoft key values are not found, an error occurs or a message is returned in the reply message if the integration supports it.

Integrations supporting response messages have these additional steps:

1. The PeopleSoft application processes the request and returns the ABM reply to the PeopleSoft inbound handler.
2. The PeopleSoft inbound handler formats the EBM reply and returns it to the third-party system with the common key.
3. Optionally, if the third-party system uses the PeopleSoft cross-reference framework to persist their key mappings, asynchronous request-reply operations need to look up the third-party keys using the appropriate form of the **lookup XRef** web service with the common key from the EBM reply as input.

Use Case: Integration Broker Point-to-Point Transformation

This section discusses the use case in which PeopleSoft Integration Broker performs all of the transformations with a third party. In the previous use case, the messages were transformed to the EBM format; in this use case, the message is transformed into the third-party ABM. If the third party is another PeopleSoft system, no transform is necessary.

Use case includes:

- Outbound request or post to a third party.
- Inbound request or post from a third party.

Outbound Request or Post to a Third Party

This diagram illustrates an outbound point-to-point request or post to a third party.

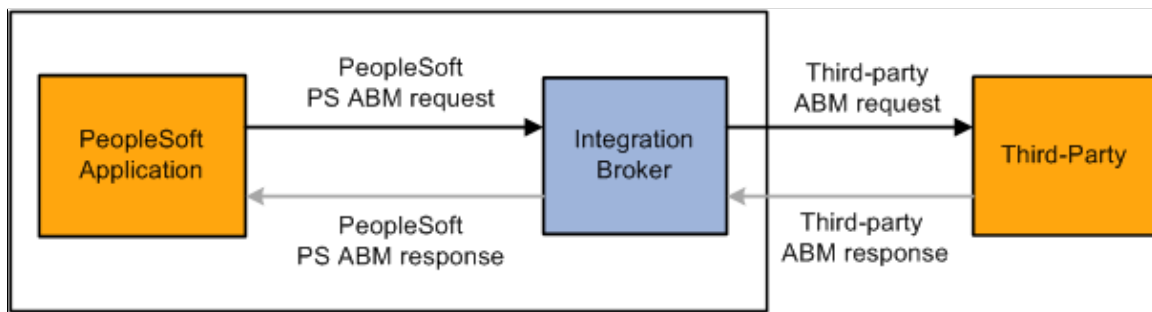

The following steps are performed in this scenario:

1. A user in the PeopleSoft system triggers publishing of a point-to-point integration to a third-party system.
2. Within PeopleSoft Integration Broker, a transform on the outbound routing generates the third-party ABM. The method used to translate the data values depends on the transaction. This table lists the transaction types and the necessary transformation action.

Transaction	Action
Dynamic key add-request	If the transaction is an add-request, the transform creates a new common key (GUID) and uses the appropriate form of the populate XRef XPath extension function to put the new common key, corresponding PeopleSoft key, and third-party key in the PeopleSoft cross-reference framework.

Transaction	Action
Dynamic key lookup	If the transaction is not an add-request, the transform looks up the key using the appropriate form of the lookup XRef XPath extension function with the PeopleSoft keys as input. If a common key does not exist, the developer determines whether to create a new common key, generate an error, or return an error message in the reply message if the integration supports it.
Dynamic key delete request	For asynchronous notification (request-only) integrations that delete a keyed entity, developers may choose to leave the cross-reference values in place for historical purposes or, if desired, they may choose to delete the cross-reference values. To mark the PeopleSoft keys for deletion, the transform uses the appropriate form of the deleteXRef XPath extension function with the PeopleSoft keys as input.
Static value lookup	If the transaction uses a domain value map, a transform on the outbound routing looks up the common value using the appropriate form of the lookupDVM XPath extension function with the PeopleSoft value as input. If a value is not found, the developer determines whether the transform supplies the PeopleSoft values by default, omits them, throws an error, or returns an error message in the reply message if the integration supports it.

3. The third-party ABM is routed to the third-party system for processing.

Integrations supporting response messages have these additional steps.

1. The third-party system processes the request, formats the reply message, and then returns it along with the common key or value.
2. Within PeopleSoft Integration Broker, asynchronous request-reply operations have a transform to look up the PeopleSoft keys using the appropriate form of the **lookup XRef** XPath extension function with the third-party key as input. The PeopleSoft keys are then put into the PeopleSoft ABM. Synchronous operations do not require this lookup because the PeopleSoft application already knows the PeopleSoft keys from the initial request.

Transaction	Action
Asynchronous request-reply operation using dynamic key value	Requires a transform program to look up the PeopleSoft keys using the appropriate form of the lookupXRef XPath extension function with the third-party key as input. The PeopleSoft keys are then put into the PeopleSoft ABM.

<i>Transaction</i>	<i>Action</i>
Synchronous operations using dynamic key value	Lookup is not required because the PeopleSoft application already knows the PeopleSoft keys from the initial request.
Asynchronous request-reply operation using DVM value	Requires a transform program to look up the PeopleSoft value using the appropriate form of the lookupDVM XPath extension function with the third-party value as input. The PeopleSoft keys are then put into the PeopleSoft ABM.

3. The PeopleSoft ABM reply is returned to the originating PeopleSoft application.

Inbound Request or Post from a Third Party

This diagram illustrates an inbound point-to-point request or post from a third-party.

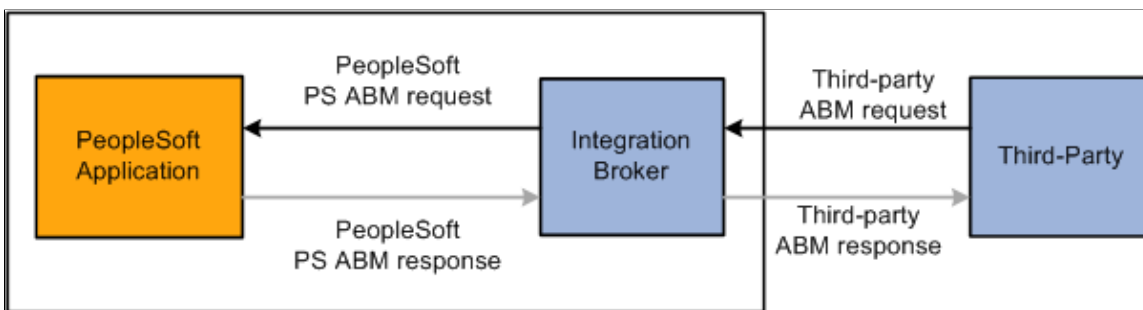

1. A user in the third-party system triggers publishing an integration to a PeopleSoft system.
2. In this example, the request is sent in the third-party ABM format.

Note: In many instances, the third-party may be aware of the PeopleSoft ABM format and perform a transformation before sending the message; in this case, no transform is required.

3. Within PeopleSoft Integration Broker, a transform on the inbound message performs the following actions based on transaction type:

<i>Transaction</i>	<i>Action</i>
Dynamic key add request	If the transaction is an add-request, the transform leaves the PeopleSoft keys blank in the ABM and passes the third-party key along for use in the handler.
Dynamic key lookup	If the transaction is not an add-request, the transform looks up the PeopleSoft keys using the appropriate form of the lookup XRef XPath extension function with the reference key in the third-party ABM as input.

Transaction	Action
DVM lookup	The transform on the inbound routing looks up the PeopleSoft values using the appropriate form of the lookupDVM XPath extension function with the reference key from the third-party ABM. If a value is not found, the developer determines whether the transform supplies the PeopleSoft values, omits them, throws an error, or return an error message in the reply message if the integration supports it.

4. Within PeopleSoft Integration Broker, a transform on the inbound message performs the following actions based on transaction type.
5. The PeopleSoft Inbound handler processes the message.

Transaction	Action
Dynamic key add request	If the transaction is an add-request, it creates the PeopleSoft keys and then uses the appropriate form of the populateXRef API to add the PeopleSoft keys and the corresponding UniqueGUID to the PeopleSoft cross-reference framework. If the keys cannot be created or added to the framework, an error occurs or a message is returned in the reply message if the integration supports it.
Dynamic key lookup	If the transaction is not an add-request, the message is processed with the PeopleSoft key values from the ABM. If the PeopleSoft key values not found, an error occurs or a message is returned in the reply message if the integration supports it.

Integrations supporting response messages have these additional steps:

1. The PeopleSoft application processes the request and the PeopleSoft inbound handler formats the ABM reply and returns it along with the common key or value.
2. No key translation is required in the transform, so the EBM reply is then returned to the third-party system along with the common key from the ABM reply.

Use Case: Integration Broker Transformation in Which a Third Party Uses AIA Middleware

From a PeopleSoft perspective, this use case has an identical flow to the transformation without the AIA middleware. From a third-party perspective, however, it is similar in flow, but not in implementation. In this case, the third-party system integrates with the AIA using their ABM instead of with PeopleSoft

software using an EBM. All of the third-party value maps and transforms between the EBM and the third-party ABM are done on the AIA layer using the EBS graphical-mapper and XPath extension functions instead of being done on the third-party system.

Note: This is the model used with AIA PIPs.

Use cases include:

- Outbound request or post to a third party.
- Inbound request or post from a third party.

Outbound Request or Post to a Third Party

In this use case, a request is sent from the PeopleSoft application to a third party that uses their own AIA middleware to perform message transformation.

This diagram illustrates an outbound request or post to a third party that uses AIA middleware.

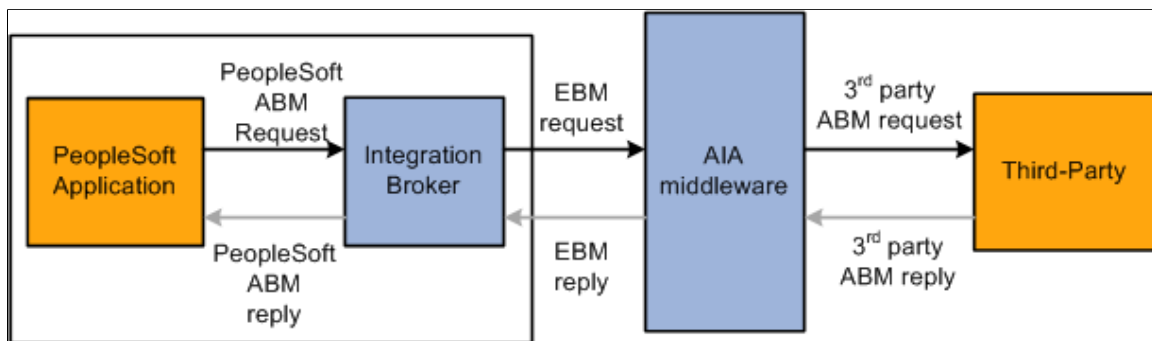

1. A user in the PeopleSoft system triggers publishing of an AIA supportive integration to a third-party system through the AIA.
2. Within PeopleSoft Integration Broker, a transform on the outbound routing occurs, generating the EBM. The method used to translate the data values depends on the transaction. This table lists the transaction types and the necessary transformation action.

<i>Transaction</i>	<i>Action</i>
Dynamic key add request	If the transaction is an add-request, the transform creates a new common key (GUID) and uses the appropriate form of the populateXRef XPath extension function to put the new common key and the corresponding PeopleSoft keys in the PeopleSoft cross-reference framework.

Transaction	Action
Dynamic key lookup	If the transaction is not an add-request, the transform looks up the common key using the appropriate form of the lookupXRef XPath extension function with the PeopleSoft keys as input. If a common key does not exist, the developer determines whether to create a new common key, generate an error, or return an error message in the reply message if the integration supports it.
Dynamic key delete request	For asynchronous notification (request-only) integrations that delete a keyed entity, developers may choose to leave the cross-reference values in place for historical purposes or, if desired, they may choose to delete the cross-reference values. To mark the PeopleSoft keys for deletion, the transform uses the appropriate form of the deleteXRef XPath extension function with the PeopleSoft keys as input.
DVM lookup	If the transaction uses a domain value map, the transform looks up the PeopleSoft values using the appropriate form of the lookupDVM XPath extension function with the common value from the EBM. If a value is not found, the developer determines whether the transform supplies the PeopleSoft values by default, omits them, throws an error, or returns an error in the reply message if the integration supports it.

3. The EBM is routed to the AIA.
4. Upon receiving the EBM request, the AIA transforms the common key to the third-party key and sends the transformed request to the third party using their ABM.

Integrations supporting response messages use these additional steps:

1. The third party processes the request, formats the reply message, and returns it to the AIA middleware.
2. The AIA transforms the third-party key in the reply to the common key and returns the EBM reply to PeopleSoft software.
3. Within PeopleSoft Integration Broker, asynchronous request-reply operations have a transform program to transform the common key or value and place it into the PeopleSoft ABM. Synchronous operations do not require this lookup because the PeopleSoft application already knows the PeopleSoft keys or values from the initial request.

Transaction	Action
Dynamic key lookup	Transform looks up the PeopleSoft keys using the appropriate form of the lookup XRef XPath extension function with the common key as input.
Dynamic key delete	(Optional) For integrations that delete a keyed entity, developers may choose to leave the cross-reference values in place for historical purposes or, if desired, they may choose to delete the cross-reference values. To mark the PeopleSoft keys for deletion, the transform uses the appropriate form of the deleteXRef XPath extension function with the PeopleSoft keys as input.
DVM lookup	The transform looks up the common value using the appropriate form of the lookup DVM XPath extension function with the PeopleSoft values as input.

4. The PeopleSoft ABM reply is returned to the originating PeopleSoft application.

Inbound Request or Post from a Third Party

In this use case, a third-party application creates a request that is transformed using the third-party AIA middleware and sent to the PeopleSoft application.

This diagram illustrates an inbound request or post from a third party using AIA middleware.

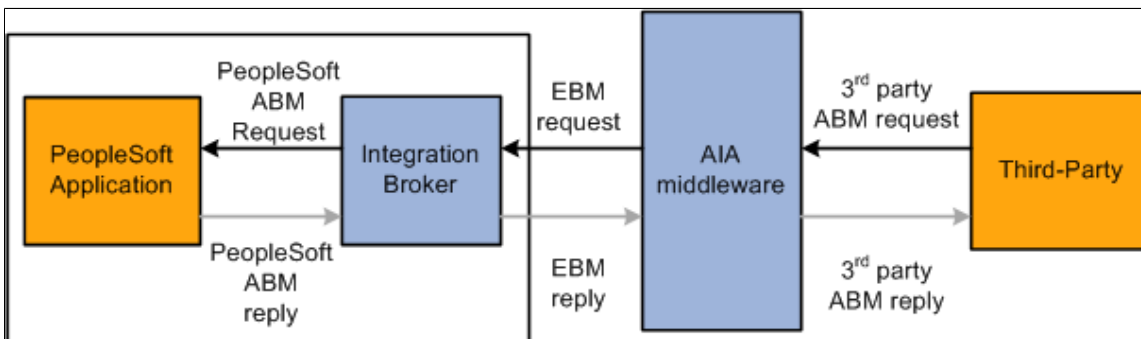

1. A user in the third-party system triggers publishing of an integration to a PeopleSoft system through the AIA.
2. The AIA transforms the third-party ABM key and values to the common key and values and routes the EBM request to the PeopleSoft system for processing.
3. Within PeopleSoft Integration Broker, a transform on the inbound routing transforms the EBM to PeopleSoft ABM using one or more of the following methods depending on the transaction.

Transaction	Action
Dynamic key add	If the transaction is an add-request, the transform leaves the PeopleSoft keys blank in the ABM and passes the common key along for use in the handler.
Dynamic key lookup	If the transaction is not an add-request, the transform looks up the PeopleSoft key using the appropriate form of the lookupXRef XPath extension function with the common key in the EBM as input. Optionally, this can be done in the PeopleSoft inbound handler using the appropriate PeopleSoft lookup XRef API with the common key as input.
DVM lookup	A transform on the inbound routing looks up the PeopleSoft values using the appropriate form of the lookup DVM XPath extension function with the common value from the EBM. If a value is not found, the developer determines whether the transform supplies the PeopleSoft values by default, leaves them blank, throws an error, or returns an error message in the reply message if the integration supports it.

For synchronous and asynchronous request-reply messages, the following additional steps are performed:

1. The PeopleSoft application processes the request and the PeopleSoft inbound handler formats the ABM reply and returns it along with the common key or value.
2. No key translation is required in the IB transform, so the EBM reply is returned to the AIA for routing back to the third-party system.
3. The AIA transforms the common key and values to the third-party ABM key and values and routes the third-party ABM reply back to the third-party system.

Chapter 3

Defining and Populating Value Maps

Understanding Value Maps

The Define Value Maps component enables users to define and classify value maps and elements. Each value map must be defined as either dynamic (cross-reference) or static (DVM).

Value maps support the following types of maps:

- One-to-one
- One-to-many
- Multiple elements per domain

One-to-One Cross-Reference

Cross-reference maps support a one-to-one relationship between two systems. For example, the PeopleSoft system uses one ID for customer A, the enterprise business object (EBO) or common value uses a GUID, and the external system uses another ID for the same customer.

The cross-reference map would be defined like this:

<i>PeopleSoft</i>	<i>UniqueGUID</i>	<i>External System</i>
PS	UniqueGUID	EXT
PS100	<guid1>	EXT-100
PS102	<guid2>	EXT-102

In this scenario, when a PeopleSoft application creates a new customer and sends the create customer message to the external system, the routing includes a transformation program that uses the cross-reference map to translate the data.

One-to-Many Cross-Reference

Cross-reference maps support a one-to-many relationship between two systems. Two or more values in a system may correspond to a single value in another system. For example, three different job codes might exist in the PeopleSoft system that correspond to one job code in the external system.

The cross-reference map would be defined like this:

<i>PeopleSoft</i>	<i>UniqueGUID</i>	<i>External System</i>
PS	UniqueGUID	EXT
AS01	<guid1>	ASST
AS02	<guid2>	
AS03	<guid3>	
MG01	<guid4>	MNGR

In this scenario, when the PeopleSoft application assigns or changes a job code and sends the message to the external system, the routing includes a transformation program that uses the cross-reference map to translate the data. If the integration requires translation from the external system value to a PeopleSoft value, the developer is responsible for determining how to handle the multiple PeopleSoft values returned from the lookup. Options include replicating the source data for each value, implementing a method of choosing a default value, and generating an error for the transaction.

Cross-Reference with Multiple Domains

Many times a system implements functionality using compound keys. This is supported in the cross-reference framework by means of multiple elements to identify the value set. For example, item integrations from a PeopleSoft application to an external system would use a cross-reference map to translate SetID/ItemID on the PeopleSoft system to Product on the external system.

The cross-reference map would be defined like this:

<i>PeopleSoft</i>	<i>PeopleSoft</i>	<i>UniqueGUID</i>	<i>External System</i>
SETID	ITEMID	UniqueGUID	Product
SHARE	1001	<guid1>	RP001
SHARE	1002	<guid2>	RP002
SHARE	1003	<guid3>	RP003
SHR03	1000	<guid4>	RP006

In this scenario, when the PeopleSoft application creates an item and sends the message to the external system, the routing includes a transformation program that maps the setID and itemID to a common element (UniqueGUID) and the external system receives the translated data.

One-to-One DVM

In a domain value map, the one-to-one relationship contains the actual data values. For example, the PeopleSoft application uses the short name for the state code, the EBO defines state code using the full name as the common value, and the external application uses an abbreviated name for state code.

The DVM would be defined like this:

<i>PeopleSoft</i>	<i>Common</i>	<i>External System</i>
Short	Full	Abbrev
MA	Massachusetts	Mass
CA	California	Calif

In this scenario, when a PeopleSoft application creates an outbound message to the external system that includes the state code, the routing includes a transformation program mapping the short name to the full name and the external system requires a transformation from the full name to the abbreviated name. The transformation for the external system can be done by means of the AIA middleware or a proprietary transformation on the external system.

One-to-Many DVM

In the domain value map, a one-to-many relationship is created by entering multiple values for one domain mapping to a single value in another domain. For example, in the PeopleSoft application, multiple person types can map to a single person type in the external application.

The DVM would be defined like this:

<i>PeopleSoft</i>	<i>UniqueGUID</i>	<i>External System 2</i>
PS	UniqueGUID	EXT2
PS001 PS002	<guid1>	SB001
PS003	<guid2>	SBL002

In this scenario, when a PeopleSoft application creates an outbound message to an external system that includes the person type, the routing includes a transformation program to translate the data values.

DVM with Multiple Elements Per Domain

In the DVM, you can map multiple elements to define a value set. For example, in the PeopleSoft application, the Business Unit/Chartfield combination could map to a Ledger/Segment combination in an external application.

In this scenario, when a PeopleSoft application creates an outbound message to the external system that includes the person type, the routing includes a transformation program providing the data translation.

The DVM would be defined like this:

<i>PeopleSoft</i>	<i>PeopleSoft</i>	<i>UniqueGUID</i>	<i>External System 1</i>	
Business Unit	Chartfield	UniqueGUID	Segment	Ledger
US001	ACCOUNT	<guid1>	SEGMENT1	Ledger1
US001	DEPARTMENT	<guid2>	SEGMENT2	Ledger1
US001	PRODUCT	<guid3>	SEGMENT3	Ledger1
US002	ACCOUNT	<guid4>	SEGMENT1	Ledger2

In this scenario, when a PeopleSoft application creates an outbound message to an external system that includes the Business Unit/Chartfield, the routing includes a transformation program to translate the data values for the multiple elements to a single UniqueGUID. The external system would then need to transform the UniqueGUID to the equivalent Segment/Ledger.

DVM with Qualifiers

Qualifiers provide additional context to uniquely identify mapping values. A mapping may not be valid unless qualified with additional contextual information. For example, a domain value map containing city code to city name mapping may have multiple mappings for a city based on the country. For example, Kensington is a city in Canada as well as the United States.

The DVM would be defined like this:

<i>EXT (Qualifier 1)</i>	<i>EXT (Qualifier 2)</i>	<i>Common</i>	<i>EXT</i>	<i>PSFT</i>
<i>PSFT (Qualifier 1)</i>	<i>PSFT (Qualifier 2)</i>			
Country	State	Common	CityCode	CityName
USA	Minnesota	BELG_MN	BELG	Belgrade
USA	North Carolina	BELG_NC	BELG	Belgrade

<i>EXT (Qualifier 1)</i>	<i>EXT (Qualifier 2)</i>	<i>Common</i>	<i>EXT</i>	<i>PSFT</i>
<i>PSFT (Qualifier 1)</i>	<i>PSFT (Qualifier 2)</i>			
USA	Kansas	KN_KS	KN	Kensington
Canada	Prince Edward Island	KN_PEI	KN	Kensington

In this scenario, when the PeopleSoft application creates an outbound message to an external system that includes the Business Unit/Chartfield, the routing includes a transformation program mapping city name, country, and state to a common value.

Defining Map Options

This section discusses how to define value map options.

Page Used to Define Value Map Options

<i>Page Name</i>	<i>Definition Name</i>	<i>Usage</i>
Value Map Options Page	EOTF_MAP_OPTIONS	Use this page to select default values for the options available on value map definitions.

Value Map Options Page

Use the Value Map Options page (EOTF_MAP_OPTIONS) to use this page to select default values for the options available on value map definitions.

Navigation:

Enterprise Components > Integration Definitions > Transformation Framework > Define Map Options

This example illustrates the fields and controls on the Value Map Options page. You can find definitions for the fields and controls later on this page.

Value Map Options

Cache Minutes:

Concatenation Separator:

Import Options

***Import Mode:** ▼

Error When Map Exists

Delete Map/Data Before Import

Export Options

***Export Mode** ▼

Export UniqueGUID to DVM.V1

<i>Field or Control</i>	<i>Description</i>
Cache Minutes	The cache for map definitions and DVM data uses this value to determine the stale datetime. Once this time is exceeded, the cache is refreshed before use.
Concatenation Separator	Indicates the separator for concatenation when importing or exporting data. For V1 (Fusion Middleware FMW) schemas, if values are concatenated from multiple element domains into a single column during export or unconcatenated during an import of data then this separator value is used.

Import Options

These options are defaulted into the import component and any maps that are created. The import process uses the map specific options.

Field or Control	Description
Import Mode	<p>Allows a user to import a definition, alter the definition via the define value maps component, and subsequently import data only. This gives users the ability to rename elements, or perhaps specify multiple elements for a domain prior to importing data.</p> <p>Valid values are:</p> <ul style="list-style-type: none"> • Definition Only <p>Allows users to move definitions from one environment to another without the data.</p> • Definition and Data <p>Imports both the definition and associated data.</p> • Values Only <p>Allows users to import data using the map definition in the database and not the definition in the file.</p>
Error When Map Exists	<p>Select this check box to prevent maps from being wiped out accidentally if a user tries to import a map with an existing name. The default value is selected.</p>
Delete Map/Data Before Import	<p>Select this check box to delete existing definition and data prior to import (default). If this check box is cleared, append/merge is used. Append/merge allows a user to add elements, domains or data to an existing map without deleting existing data.</p> <hr/> <p>Note: This option is for advanced users only as they must understand the implications.</p> <hr/>

Export Options

These options are defaulted into maps that are created. The export process uses map specific options.

Field or Control	Description
Export Mode	<p>Valid options are:</p> <ul style="list-style-type: none"> • Definition Only <p>Allows users to move definitions from one environment to another without the data.</p> <p>This is the default for XREF.</p> <ul style="list-style-type: none"> • Definition and Data <p>Exports both the definition and associated data.</p> <p>This is the default for DVM.</p>
Export UniqueGUID to DVM.V1	Select to remove PeopleSoft required UniqueGUID domain from the DVM when moving maps to Fusion Middleware (FMW).

Defining Value Maps

This section discusses how to define value maps.

Pages Used to Define Value Maps

Page Name	Definition Name	Usage
Define Value Map - Elements Page	EOTF_DEFINE_MAPS	Assign elements to the map.
Define options for a value map Page	EOTF_MAP_OPT_SEC	Set the map level options. For new maps, the option values will default to the defined system level option values.
Define Value Maps - Domains Page	EOTF_DEFINE_MAPS2	Assign elements to domains.

Define Value Maps search Page

Use the Define Value Maps search page to add a new value.

Navigation:

Enterprise Components > Integration Definitions > Transformation Framework > Define Value Maps

This example illustrates the fields and controls on the Define Value Maps search page: Add a New Value tab. You can find definitions for the fields and controls later on this page.

Define Value Maps

Enter any information you have and click Search. Leave fields blank for a list of all values.

Find an Existing Value
Add a New Value

Maximum number of rows to return (up to 300):

Map Name: begins with

Map Type: begins with Domain Value Map (static) ▼

Description: begins with

Search
Clear
[Basic Search](#)
[Save Search Criteria](#)

To add a value map:

1. Select the Add a New Value tab.
2. In the **Map Name** field, enter a name for the map.
3. In the **Map Type** field, select the map type.
4. Click the **Add** button.

The Elements page appears, where you can define the elements for the map.

Note: After you save the map, you can not change the map type.

Map Types

Maps are either static or dynamic.

<i>Field or Control</i>	<i>Description</i>
Domain Value Map (static)	Static map to which values are provided by means of the Populate Domain value component.
<i>Field or Control</i>	<i>Description</i>
Cross Reference (dynamic)	Dynamic map to which values are provided based on key information.

Define Value Map - Elements Page

Use the Define Value Maps - Elements page (EOTF_DEFINE_MAPS) to assign elements to the map.

Navigation:

Enterprise Components > Integration Definitions > Transformation Framework > Define Value Maps > Elements

This example illustrates the fields and controls on the Define Value Maps - Elements page. You can find definitions for the fields and controls later on this page.

The screenshot shows the 'Define Value Maps - Elements' page. At the top, there are tabs for 'Elements' and 'Domains'. The 'Map Name' is 'StateCodeDVM' and the 'Type' is 'Static'. The '*Description' is 'State & Country Table DVM' and there is an 'Options' link. Below this is a 'Comments' text area. The main part of the page is a table titled 'Assign Elements to Maps' with columns: Order, Element Name, Data Type, Length, and Required. The table contains four rows of elements. At the bottom right, there are 'Export' and 'Delete' buttons.

Order	*Element Name	*Data Type	Length	Required
1	UniqueGUID	String	36	<input checked="" type="checkbox"/>
2	COUNTRY	String	3	<input checked="" type="checkbox"/>
3	STATE	String	6	<input checked="" type="checkbox"/>
4	COMMON	String	32	<input checked="" type="checkbox"/>

Field or Control	Description
Description	Enter a description for the value map.
Options	<p>Use this link to modify the options for this map. The link will take you to the Define options for a value map page, where you can set up the options, as well as delete the existing cache for the map. When you click OK, the options will be applied to the map.</p> <p>For new maps, the option values will default to the defined system level option values.</p> <p>See Value Map Options Page.</p>
Comments	Enter comments for the value map.
Order	The common element is always assigned order 1. All other elements must be assigned an order of 2 or higher.

Field or Control	Description
Element Name	<p>Enter the element name. Select one and only one element as the common element. The common element must always contain a unique value for each row of data entered into both dynamic and static value maps.</p> <p>For dynamic maps, the common element must be a unique guid.</p> <p>For static maps, the common element can be assigned as required.</p>
Data Type	<p>Values are:</p> <ul style="list-style-type: none"> • <i>String</i> • <i>Numeric</i> <p>The data type is used for validation when you are entering data values.</p>
Length	<p>Enter the length of the element.</p> <p>The length is used for validation when you are entering data values.</p>
Required	Select to indicate that this is a required element.
Export	<p>This button allows the user to publish the map definition and data in an XML format using the options defined for the value map.</p> <p>See Exporting Value Maps.</p>
Delete	Use this button to delete the value map.

Define options for a value map Page

Use the Define options for a value map page (EOTF_MAP_OPT_SEC) to set the map level options. For new maps, the option values will default to the defined system level option values.

Navigation:

Click the Options link on the Define Value Maps - Elements page.

This example illustrates the fields and controls on the Define options for a value map page for a specific map. You can find definitions for the fields and controls later on this page.

This page is similar to Define options for a value map used to define the default options, the difference is:

- The options apply to this specific map.
- A **Delete Cache** button is available to delete the existing cache for the map.

When you click the **OK** button, the options will be applied to the map and you will be returned to the Define Value Maps page.

See [Value Map Options Page](#).

Define Value Maps - Domains Page

Use the Define Value Maps - Domains page (EOTF_DEFINE_MAPS2) to assign elements to domains.

Navigation:

Enterprise Components > Integration Definitions > Transformation Framework > Define Value Maps > Domains

This example illustrates the fields and controls on the Define Value Maps - Domains page. You can find definitions for the fields and controls later on this page.

The screenshot shows the 'Define Value Maps - Domains' page with three domain configurations:

- Domain 1:** Map Name: StateCodeDVM, Type: Domain Value Map (static). Domain Name: AIA. Is Unique: checked. One element assigned: COMMON.
- Domain 2:** Domain Name: PSFT. Is Unique: checked. Two elements assigned: COUNTRY and STATE.
- Domain 3:** Domain Name: UniqueGUID. Is Unique: checked. One element assigned: UniqueGUID.

Each element in a value map must be assigned to at least one domain.

Field or Control	Description
Domain Name	Enter the domain name for the participating system.
Is Unique	Select to indicate that elements within the domain make up a unique instance.
Element Name	Select the element to assign.

Note: Domain name “UniqueGUID” will be automatically generated as it is required to maintain a unique value for each row of data in a map. Elements may be shared across multiple domains, as long as users understand the data value in the element is unique to the map, not the domain. In general, it is expected most DVM domains will contain a single element, and most PeopleSoft XREF domains will contain multiple elements, though this is not a rule.

Populating a Domain Value Map

This section discusses how to populate a domain value map.

Page Used to Populate a Domain Value Map

<i>Page Name</i>	<i>Definition Name</i>	<i>Usage</i>
<u>Domain Value Map Page</u>	EOTF_POPULATE_DVMS	Populate a domain value map.

Domain Value Map Page

Use the Domain Value Map page (EOTF_POPULATE_DVMS) to populate a domain value map.

Navigation:

Enterprise Components > Integration Definitions > Transformation Framework > Populate Domain Value Maps

This example illustrates the fields and controls on the Domain Value Map page. You can find definitions for the fields and controls later on this page.

The screenshot shows the 'Domain Value Map' page for a map named 'StateCodeDVM' with the description 'State & Country Table DVM'. The page title is 'Assign Data to Value Maps'. The table below lists the data entries:

	COUNTRY	STATE	COMMON		
1	USA	CA	California	+	-
2	USA	NY	New York	+	-
3	USA	MD	Maryland	+	-
4	USA	MI	Michigan	+	-
5	CAN	NF	Newfoundland	+	-
6	USA	AK	Alaska	+	-

You use domain value maps to enter and maintain data in static value maps. The elements that you define for the value map make up the columns displayed on the page. Elements are ordered and validated as specified in the map definition.

A unique value must be entered for each row of data in every DVM. When you save the page, the component looks for a cached rowset and destroys it. The cache is reloaded the next time it is called.

Importing Value Maps

This section provides an overview of the import file types used with value maps and describes how to import value maps.

Page Used to Import Value Map

<i>Page Name</i>	<i>Definition Name</i>	<i>Usage</i>
Import Value Maps Page	EOTF_MAP_IMPORT	Import a DVM or XREF from a specified file.

Understanding Import File Types Used with Value Maps

There are 2 import file types supported in the Transformation Framework:

- XML Files
- CSV Files

Importing XML Files

There are 2 types of schemas supported in the Transformation Framework:

- V1 Fusion Middleware (FMW)

This is the schema used with FMW using 11g format. The associated service operation is `EOTF_DVM_IMPORT.v1`. This is not the default version of the service operation, therefore a version transformation program is executed when a value map is imported in this format.

See [EOTF_DVM_IMPORT.v1](#), [EOTF_XREF_IMPORT.v1](#).

- PeopleSoft Format

This is the schema used for PeopleSoft. The associated service operation is `EOTF_DVM_IMPORT.v2`, which is the default service operation.

See [EOTF_DVM_IMPORT.v2](#), [EOTF_XREF_IMPORT.v2](#).

When the specified file contains XML, the XML must conform to one of the schemas supported by the import web service. When the file contains XML, users may choose to import a map definition, map data, or both. When importing using the FMW (V1) schema, users may desire to have the import process break composite values into element values. To do so, users need to import the definition, then alter the definition to specify multiple elements for one or more of the domains using the Value Map Definition component, then go back and import data values only. In this scenario, the process will unconcatenate the values using the specified separator. An error will be thrown if a required element is not valued.

Importing CSV Files

When the file contains CSV data, the following rules apply:

- The first row in the file must contain the type of the value map (*DVM* or *XREF*) in the first column, and the name of the value map to be imported in the second column.
- Each column in the second row of the file must identify either domain names or element names to import into (no mixing allowed), or reference data. When importing into an existing map, domain and element names will be validated against the map definition. An error will be thrown if not found, or if

all required elements for a domain are not included in the file. To define a reference data column that will be ignored by the import process, prefix the name with an asterisk, or leave the name blank.

- Subsequent rows in the file identify the data values to be imported, and must contain the same number of columns as the second row.
- When the data values in a column are composite (concatenated) values identifying the value of each element in the domain, and the second row in the file identifies domain names, the import process will unconcatenate the values using the specified separator for each domain defined with multiple elements. An error will be thrown if a required element is not valued.
- If the value map already contains data for other domains, and the user wishes to add this domain’s values to the existing rows of data, the domain referenced in the first column of data will be used to locate an existing row of data. If a row of data is not found, a new row of data will be created. If multiple rows are found and the additional domain(s) in the file do not allow duplicates, an error will occur. Otherwise, the existing rows of data will be updated with the data values for the other domain(s) in the file.
- If UniqueGUID is blank or not specified in the file, a value will be generated for each new row of data.
- When importing a map definition, each column will be treated as a domain with a single element by the same name. Users may import definition only, then use the Define Value Maps component to alter the definition, then import data only to allow importing composite (concatenated) values or domains with multiple elements.

This is an example of the cross-reference value map csv file in MicroSoft Excel:

This example illustrates a sample csv file to import a cross reference value map. You can find definitions for the fields and controls later on this page.

XrefTest2.csv					
	A	B	C	D	
1	XREF	XrefTest			
2	UniqueGUID	PSFT	*FusionValue	FusionGUID	
3	asdf1	US001::VEND000001	V0101		1
4	asdf2	US002::VEND000002	V0202		2
5	asdf3	US003::VEND000003	V0303		3
6	asdf4	US004::VEND000004	V0404		4
7	asdf5	US005::VEND000005	V0405		5
8	asdf6	US006::VEND000006	V0406		6
9	asdf7	US007::VEND000007	V0407		7
10					

This is an example of the DVM value map csv file in MicroSoft Excel:

This example illustrates a sample csv file to import a DVM value map. You can find definitions for the fields and controls later on this page.

DVMTest.csv			
	A	B	C
1	DVM	StateCodes	
2	PeopleSoft	*Description	ExternalSystem
3	MA	Massachusetts	Mass
4	CA	California	Calif
5	NV	Nevada	Nev
6	OR	Oregon	Oreg
7			

Import Value Maps Page

Use the Import Value Maps page (EOTF_MAP_IMPORT) to import a DVM or XREF from a specified file.

Navigation:

Enterprise Components > Integration Definitions > Transformation Framework > Import Value Maps

This example illustrates the fields and controls on the Import Value Maps page. You can find definitions for the fields and controls later on this page.

Import Value Maps

File Name:

***Import Mode:** Definition and Data ▼

Delete Map/Data Before Import

Column Separator: (use \t for tab)

Concatenation Separator:

The import value maps component provides users the ability to import a DVM or XREF from a specified file. The import file must be formatted as XML or comma separated values (CSV). If the import may result in data loss, a confirmation dialog will be displayed. Option defaults will be pulled from the system defaults set up by the user in the Value Map Options component.

Field or Control	Description
File Name	The name of the file including the path. Files must be XML or CSV format and must contain a map name.
Import Mode	Allows a user to import a definition, alter the definition via the define value maps component, and subsequently import data only. This gives users the ability to import a definition and then rename elements, or perhaps specify multiple elements for a domain prior to importing data. Valid values are: <ul style="list-style-type: none"> • Definition Only • Definition and Data • Values Only
Delete Map/Data Before Import	Select to delete existing definition and data prior to import (default). If this check box is cleared, append/merge is used. Append/merge allows a user to add elements, domains or data to an existing map without deleting existing data. <hr/> <p>Note: This option is for advanced users only as they must understand the implications.</p> <hr/>
Column Separator	CSV files allow characters other than a comma to be utilized for delimiting column values. The value entered here is the delimiter value that will be used when reading the specified file. To specify a tab character, enter <code>\t</code> as the separator value.
Concatenation Separator	For V1 (FMW) schemas, if values are concatenated from multiple element domains into a single column during export or unconcatenated during an import of data only, this is the separator value to be used.
Import	Verifies the options and initiates the import process.

Exporting Value Maps

This section provides an overview of export schemas and discusses how to export a value map.

Understanding Export Schemas

Value maps can be exported from the Define Value Maps page using the Export button. The map definition and data is published in an XML format using the options defined for the value map. The XML will conform to the schemas specified in the active version of the EOTF_DVM_EXPORT service operation.

- FMW format (V1)

To export using the FMW schema, you must activate and supply a valid routing for the service operation EOTF_DVM_EXPORT.v1.

Domain names are used as column names when exporting to a V1 schema. If multiple element domains are exported to the V1 schema, the element values are concatenated to form a compound value for each domain.

- PeopleSoft

To export using the PeopleSoft schema, you must activate and supply a valid routing for the service operation EOTF_DVM_EXPORT.v2.

- Both

Activate and provide a routing for both EOTF_DVM_EXPORT.v1 and EOTF_DVM_EXPORT.v2.

See *PeopleTools: PeopleSoft Integration Broker*, Managing Service Operations, Configuring Service Operation Definitions

Exporting a Value Map

To export a value map:

1. Select **Enterprise Components > Integration Definitions > Transformation Framework > Define Value Maps**.
2. Select the map you want to export.
3. Click the Export button.

Creating Transform Programs and Updating Service Operations

Understanding Transform Programs

A transform program is a type of PeopleSoft Application Engine program. After you create a new transform application engine program, you add steps and actions to the program, and then add code to the steps and actions that performs data transformation and translation.

To develop a transform program, you must know the initial structure and possibly the content of the message with which you are working, as well as the structure (and content) of the result that you want to achieve.

You specify which transform program to apply within a routing definition for a service operation.

Transformation Programming Languages

You can use PeopleCode or Extensible Stylesheet Language Transformation (XSLT) as a programming language for creating transformation logic. XSLT is a recognized standard language that is well-suited to manipulating XML structures, so it is highly recommended for transformations.

PeopleSoft applications provide XSLT extension functions and PeopleCode APIs to perform value map lookups, deletes, and population.

Note: When programming using XSLT, you can manually code the XSLT or use the Oracle XSL Mapper to graphically associate records and fields. The Oracle XSL Mapper then automatically generates the XSLT code.

See *PeopleTools: PeopleSoft Integration Broker, Applying Filtering, Transformation and Translation, Developing Transform Programs*.

Creating a Transform Program

Create a new application engine program in Application Designer. On the toolbar, click the **Properties** button and select the Advanced tab.

This example illustrates the fields and controls on the Application Engine program properties for a transform program. You can find definitions for the fields and controls later on this page.

The screenshot shows the 'Program Properties' dialog box with the 'Advanced' tab selected. The dialog contains the following fields and controls:

- Disable Restart
- Application Library
- Batch Only
- Message Set: 0 (dropdown)
- Program Type: Transform Only (dropdown)
- Input Message Name: AP_CREATE_PAY_TERM_SYNC_EI (dropdown)
- Input Message Version: V1 (dropdown)
- Input Root Element: (text field)
- Output Message Name: AP_CREATE_PAY_TERM_SYNC_EI (dropdown)
- Output Message Version: V1 (dropdown)
- Output Root Element: (text field)

The application engine program must be defined as program type *Transform Only*. Optionally, you can indicate the input and output message name and version. The input and output message name and version are required if you want to use the Oracle Graphical Mapper to create the XSLT for the transform program.

Note: Refer to *PeopleTools: PeopleSoft Integration Broker, Applying Filtering, Transformation and Translation, Developing Transform Programs* for details on creating a transform program using Oracle Graphical Mapper.

Refer to the [Understanding XSLT Extension Functions](#) topic for the syntax to use for your cross-references and domain value maps.

Note: Snippets of code are provided in the appendix, “Application Integration Framework Example.”

Updating Service Operation Routing

A routing definition contains routing parameters for each inbound request, inbound response, outbound request, and outbound response associated with a service operation. For each request or response, you define the routing alias, message names before and after transformation, and transformation program names.

Your transform program is invoked by PeopleSoft Integration Broker if you specify its name in the a routing definition for a service operation.

Adding Routing Parameters

To access the Routing Definition page to add routing parameters:

1. Select **PeopleTools > Integration Broker > Integration Setup > Service Operations**.
2. Select the Routings page.
3. Either click the link for an existing routing or add a new routing.
4. If it is a new routing, add the routing information.
5. Select the Parameters page.

This example illustrates the fields and controls on the Routing Parameters page for asynchronous one-way service operation. You can find definitions for the fields and controls later on this page.

Routing Definitions		Parameters	Routing Properties
Routing Name:	SCM_CONTACT1_TO_CONTACT_RB1		
Service Operation:	CONTACT_SYNC_EFF		
Service Operation Version:	VERSION_RB_1		
Sender Node:	PSFT_EP		
Receiver Node:	CR910TS1		
Parameters			
Type:	Inbound Request		
External Alias:	<input type="text" value="CONTACT_SYNC_EFF.VERSION_1"/>		
	Alias References		
Message.Ver into Transform 1:	<input type="text" value="CONTACT_SYNC_EFF.VERSION_1"/>		
Transform Program 1:	<input type="text" value="RB_CONT_IN"/>		
Transform Program 2:	<input type="text"/>		
Message.Ver out of Transforms:	<input type="text" value="CONTACT_SYNC_EFF.VERSION_RB_1"/>		
<input type="button" value="Save"/>		<input type="button" value="Return"/>	

If the application engine transform program includes the messages into and out of the transformation, the messages are automatically populated with these values. If the application engine program does not include the message names, enter the appropriate message names and save the page.

Note: For synchronous service operations, you can define transformation on both the outbound and inbound messages.

See *PeopleTools: PeopleSoft Integration Broker; Managing Routing Definitions, Creating Routing Definitions*.

Chapter 5

Accessing Maps Using XSLT Extension

Understanding XSLT Extension Functions

When you have created your value maps, you need to write a transformation program that will map the elements in the message and use the value maps for data translation.

PeopleSoft applications provide XSLT extension functions to perform value map lookups, deletes, and population. Two nearly identical sets of functions are available, one for cross-references and one for DVMs.

Cross-Reference Functions

This section describes the cross-reference XSLT extension functions in alphabetical order.

xref:BulkPopulateDomainData

Syntax

```
xref:BulkPopulateDomainData(mapName, domainList, dataRowsPath, dataValuesPath, mode⇒  
)
```

Description

The XREF bulk populate domain data function populates cross-reference data from XML. It sequences through the rows of data provided in the XML nodeset and uses the supplied domain list and data values path to access the values for each domain in each row. Each row of data is then inserted into the XREF framework for the specified map utilizing bulk insert to maximize performance. This function is expected to be used for processing large volumes of data. It provides an abstraction layer from the physical data persistence layer of the XREF framework. because inserts are done using bulk mode, duplicates are not looked for until the end of the insert sequence. If a duplicate is encountered, none of the rows of data will be inserted. When a domain contains multiple elements, each value for the domain must contain a compound value consisting of a value for each element in the domain separated by the concatenation string specified in the value map options. In this scenario, this function will unconcatenate the domain element values before inserting the data into the transformation framework.

Parameters

<i>Parameter</i>	<i>Description</i>
mapName	The name of a dynamic (cross reference) value map, as string.
domainList	A comma separated list of domain names identifying the order of the data values to be imported.
dataRowsPath	An XPath expression resulting in a series of XML nodes where each node represents one row of data.
dataValuesPath	An XPath expression (relative to each row of data) used to identify each node containing a data value within a row of data. The nodeset returned when this path is evaluated must contain the same number of nodes as there are domains in the specified domainList.
mode	Only <i>ADD</i> mode is supported.

Returns

Boolean indicating success or failure of the process.

xref:BulkPopulateElementData

Syntax

```
xref:BulkPopulateElementData(mapName, elementList, dataRowsPath, dataValuesPath, mode)
```

Description

The XREF bulk populate element data function populates cross-reference data from XML. It sequences through the rows of data provided in the XML nodeset and uses the supplied pairs of elements and XPath expressions to access the values for the elements in each row. Each row of data is then inserted into the XREF framework for the specified map utilizing bulk insert to maximize performance. This function is expected to be used for processing large volumes of data. It provides an abstraction layer from the physical data persistence layer of the XREF framework. because inserts are done using bulk mode, duplicates are not looked for until the end of the insert sequence. If a duplicate is encountered, none of the rows of data will be inserted.

Parameters

<i>Parameter</i>	<i>Description</i>
mapName	The name of a dynamic (cross reference) value map, as string.
elementList	A comma separated list of element names identifying the order of the data values to be imported.
dataRowsPath	An XPath expression resulting in a series of XML nodes where each node represents one row of data.
dataValuesPath	An XPath expression (relative to each row of data) used to identify each node containing a data value within a row of data. The nodeset returned when this path is evaluated must contain the same number of nodes as there are domains in the specified domainList.
mode	Only <i>ADD</i> mode is supported.

Returns

Boolean indicating success or failure of the process.

xref:populateXRefRow

Syntax

```
xref:populateXRefRow(mapName, referenceElementName, referenceValue, elementName, elementValue, mode)
```

Description

Use the populateXRefRow function to populate a cross-reference element with a value.

Parameters

<i>Parameter</i>	<i>Description</i>
mapName	The name of the cross-reference map, as string.
referenceElementName	The name of the reference element, as string.
referenceValue	The value corresponding to the reference element name, as string.

Parameter	Description
elementName	The name of the element to be populated, as string.
elementValue	The value with which to populate the element, as string.
mode	The mode in which the function populates the element. You can specify any of the following values: ADD, LINK, or UPDATE. The mode parameter values are case-sensitive and must be specified in the uppercase only.

Returns

This function returns the cross-reference value being populated as a string.

This table lists the results for the Xref:populateXRefRow function.

Mode	Reference Value	Value to Be Added	Result
ADD	Absent	Absent	Success
	Present	Absent	Exception
	Present	Present	Exception
LINK	Absent	Absent	Exception
	Present	Absent	Success
	Present	Present	Exception
UPDATE	Absent	Absent	Exception
	Present	Absent	Exception
	Present	Present	Success

Example

This table lists examples of the modes with their descriptions and exception reasons:

Mode	Description	Exception Reasons
ADD	<p>Adds the reference value and the value. For example:</p> <pre>xref:populateXRefRow("customers", "PS", "PS101", "Common", "CM001", "ADD⇒ ")</pre> <p>adds the reference value <i>PS101</i> in the <i>PS</i> element and the value <i>CM001</i> in the <i>Common</i> element of the <i>customers</i> cross-reference map.</p>	<p>Exceptions can occur for the following reasons:</p> <ul style="list-style-type: none"> • The specified cross-reference map is not found. • The specified elements are not found. • The values provided are empty. • The value being added is not unique across that element for that map. • The element for that row already contains a value. • The reference value exists.
LINK	<p>Adds the cross-reference value corresponding to the existing reference value. For example:</p> <pre>xref:populateXRefRow("customers", "Common", "CM001", "SBL", "SB-101", "LINK")</pre> <p>adds the value <i>SB-101</i> in the <i>SBL</i> element of the <i>customers</i> cross-reference map and links it to the value <i>CM001</i> in the <i>Common</i> element.</p>	<p>Exceptions can occur for the following reasons:</p> <ul style="list-style-type: none"> • The specified cross-reference map is not found. • The specified elements are not found. • The values provided are empty. • The reference value is not found. • The value being linked exists in that element for that map.
UPDATE	<p>Updates the cross-reference value corresponding to an existing reference element-value pair. For example:</p> <pre>xref:populateXRefRow("customers", "⇒ PS", "PS100", "PS", "PS1001", "UPDATE")</pre> <p>updates the value <i>PS100</i> in the <i>PS</i> element of the <i>customers</i> cross-reference map to value <i>PS1001</i>.</p>	<p>Exceptions can occur for the following reasons:</p> <ul style="list-style-type: none"> • The specified cross-reference map is not found. • The specified elements are not found. • The values provided are empty. • The value being updated is not unique across that element for that map. • Multiple values are found for the element being updated. • The reference value is not found. • The element for that row does not have a value.

xref:populateXrefRowNVP

Syntax

```
xref:populateXRefRowNVP(mapName, referenceDomain, referenceNVP, targetDomain, targetNVP, mode)
```

Description

Use the `xref:populateXrefRowNVP` function to populate multiple elements in the cross-reference map with values.

Parameters

<i>Parameter</i>	<i>Description</i>
mapName	The name of the cross-reference map, as string.
referenceDomain	The name of the reference domain, as string.
referencesNVP	NVP list of reference elements and values, as string.
targetDomain	The name of the domain to be populated, as string.
targetNVP	NVP list of elements and values to be populated in the elements, as string.
mode	The mode in which the function populates the element. You can specify any of the following values: ADD, LINK, or UPDATE. The mode parameter values are case-sensitive and must be specified in the uppercase only.

Returns

This table lists the results for the `populateXrefRowNVP` function.

<i>Mode</i>	<i>Reference Value</i>	<i>Value to Be Added</i>	<i>Result</i>
ADD	Absent	Absent	Success
	Present	Absent	Exception
	Present	Present	Exception
LINK	Absent	Absent	Exception
	Present	Absent	Success
	Present	Present	Exception
UPDATE	Absent	Absent	Exception
	Present	Absent	Exception
	Present	Present	Success

Example

This table lists the modes with their descriptions and exception reasons:

Mode	Description	Exception Reasons
ADD	<p>Adds the reference value and the value to be added. For example:</p> <pre>xref:populateXRefRowNVP("Items", "PeopleSoft", "<Setid>SHARE</Setid>=> <ItemID>1005</ItemID>", "Common", "<Common>" generate-guid() "</Common>", "ADD")</pre> <p>adds the reference values <i>SHARE/1005</i> in the <i>PeopleSoft</i> domain and the value <i><guid1></i> in the <i>Common</i> domain.</p>	<p>Exceptions can occur for the following reasons:</p> <ul style="list-style-type: none"> • The specified cross-reference map is not found. • The specified domains are not found. • The specified elements are not found. • The values provided are empty. • The values being added are not unique across that domain for that map. • The element for that row already contains a value. • The reference value exists.
LINK	<p>Adds the cross-reference value corresponding to the existing reference value. For example:</p> <pre>xref:populateXRefRowNVP("Items", "PeopleSoft", "<Setid>SHARE</Setid> <ItemID>1005</ItemID>", "Retail", "<Product>RP0005</Product>", "LINK")=></pre> <p>adds value <i>RP005</i> to the <i>Retail</i> domain and links it to reference values <i>SHARE/1005</i> in the <i>PeopleSoft</i> domain.</p>	<p>Exceptions can occur due for following reasons:</p> <ul style="list-style-type: none"> • The specified cross-reference map is not found. • The specified domains are not found. • The specified elements are not found. • The values provided are empty. • The reference value is not found. • The value being linked exists in that domain for that map.
UPDATE	<p>Updates the cross-reference value corresponding to an existing reference element-value pair. For example:</p> <pre>xref:populateXRefRowNVP("Items", "PeopleSoft", "<Setid>SHARE</Setid> <ItemID>1000</ItemID>", "PeopleSoft"=> ' "<Setid>SHARE</Setid> <ItemID>10000</ItemID>", "UPDATE")</pre> <p>updates the value <i>1000</i> in the <i>ItemID</i> element of the <i>PeopleSoft</i> domain to value <i>10000</i>.</p>	<p>Exceptions can occur for the following reasons:</p> <ul style="list-style-type: none"> • The specified cross-reference map is not found. • The specified domains are not found. • The specified elements are not found. • The values provided are empty. • The values being updated are not unique across that domain for that map. • Multiple values are found for the domain being updated. • The reference value is not found. • The element for that row does not have a value.

xref:markForDelete

Syntax

`xref:markForDelete` (*mapName*, *elementName*, *elementValue*)

Description

Use the `xref:markForDelete` function to delete a value in a cross-reference map when the element specified is the only element for a single domain. The value in the element is marked as deleted. If multiple domains reference the element or the domain the element is referenced by has multiple primary elements, use the `xref:markForDeleteNVP` function instead.

A cross-reference map row should have at least two mappings. Therefore, if you have only two mappings in a row and you mark one value for delete, then the value in another element is also deleted.

Any element value marked for delete is treated as if the value does not exist. Therefore, you can populate the same element with the `xref:populateXRefRow` function in ADD mode. However, if the element value is marked for delete as a reference, it cannot be used in the LINK mode of `xref:populateXRefRow` function.

Parameters

<i>Parameter</i>	<i>Description</i>
mapName	The cross-reference map name, as string.
elementName	The name of the element from which you want to delete a value, as string.
elementValue	The value to be deleted, as string.

Returns

This function returns true if deletion was successful; otherwise, it returns false.

An exception can occur for the following reasons:

- The cross-reference map with the given name is not found.
- The specified element name is not found.
- The specified element name is not unique to a domain.
- The specified value is empty.
- The specified value is not found in the element.
- Multiple values are found.

Example

The following code deletes the *PS001* value in the **PS** element of the *customers* cross-reference map:

```
xref:markForDelete("customers","PS","PS001")
```

xref:markForDeleteNVP

Syntax

```
xref:markForDeleteNVP(mapName, referenceDomain, referenceNVP)
```

Description

Use the `xref:markForDeleteNVP` function to delete a set of values in a cross-reference map for a specified domain. The values in the elements are marked as deleted.

A cross-reference map row should have at least two mappings. Therefore, if you have only two mappings in a row and you mark one value for delete, then the value in the other domain is also deleted.

Any values marked for delete are treated as if they do not exist. Therefore, you can populate the same elements with the `xref:populateXRefRowNVP` function in **ADD** mode. However, if the element value is marked for delete as a reference, it cannot be used in the **LINK** mode of `xref:populateXRefRowNVP` function.

Parameters

<i>Parameter</i>	<i>Description</i>
mapName	The cross-reference map name, as string.
referenceDomain	The name of the reference domain, as string.
referenceNVP	NVP list of reference elements and values that you want to delete, as string.

Returns

This function returns true if deletion was successful; otherwise, it returns false.

An exception can occur for the following reasons:

- The cross-reference map with the given name is not found.
- The specified element name is not found.
- All primary elements in this domain have not been specified.
- The specified value is empty.
- The specified value is not found in the element.

- Multiple values are found.

Example

The following code deletes the specified values in the **Setid** and *ItemID* elements of the *PeopleSoft* domain from the *Items* cross-reference map:

```
xref:markForDeleteNVP ("Items", "PeopleSoft", "<Setid>SHARE</Setid><ItemID>1000</ItemID>")
```

xref:lookupXRef

Syntax

```
xref:lookupXRef (mapName, referenceElementName, xrefReferenceValue, elementName, needAnException)
```

Description

Use the lookupXRef function to look up a cross-reference element for a value that corresponds to a specific value in a reference element.

Parameters

<i>Parameter</i>	<i>Description</i>
mapName	The name of the cross-reference map, as string.
referenceElementName	The name of the reference element, as string.
referenceValue	The value corresponding to the reference element name, as string.
elementName	The name of the element to be looked up for the value, as string.
needAnException	Specify true or false. If the needAnException parameter is set to true, an exception occurs if the value being looked up in the map is not found. If the needAnException parameter is set to false, an empty value is returned if the value being looked up in the map is not found.

Returns

The value of the requested element.

An exception can occur for the following reasons:

- The cross-reference map with the given name is not found.
- The specified element names are not found.
- The specified reference value is empty.
- Multiple target values are found.

Example

The following code looks up the *Common* element of the *customers* cross-reference map for a value corresponding to the *PS001* value in the *PS* element:

```
xref:lookupXRef("customers","PS","PS001","Common",true())
```

xref:lookupXRefNVP

Syntax

```
xref:lookupXRefNVP (mapName, referenceDomain, referenceNVP, targetDomain, needAnExc→  
option)
```

Description

Use the lookupXRefNVP function to look up cross-reference values that correspond to a specified set of values in a reference domain. All primary elements in the reference domain must be included in the reference NVP list, but any qualifier elements are optional.

Parameters

<i>Parameter</i>	<i>Description</i>
mapName	The name of the cross-reference map, as string.
referenceDomain	The name of the reference domain, as string.
referenceNVP	NVP list of reference elements and values, as string.
targetDomain	The name of the domain to be looked up for the values, as string.

Parameter	Description
needAnException	Specify true or false. If the needAnException parameter is set to true, an exception occurs if the value being looked up in the map is not found. If the needAnException parameter is set to false, an empty value is returned if the value being looked up in the map is not found.

Returns

The return string includes values for all primary and qualifier elements in the target domain as an NVP list.

An exception can occur for the following reasons:

- The cross-reference map with the given name is not found.
- The specified domain names are not found.
- The specified element names are not found.
- The specified reference value is empty.
- Multiple target values are found.

Example

The following code looks up the values of all elements in the *Common* domain of the *Items* cross-reference map that correspond to values *SHARE/1000* in the *PeopleSoft* domain:

```
xref:lookupXRefNVP("Items","PeopleSoft","<Setid>SHARE</Setid><ItemID>1000</ItemID>"&
,"Common",true())
```

Domain Value Map Functions

This section describes the domain value map functions.

dvm:lookupValue

Syntax

```
dvm:lookupValue(mapName, referenceElementName, referenceValue, elementName, default=>
Value, needAnException)
```

Description

The `dvm:lookupValue` function finds the reference element value in a domain value map and returns the equivalent value of the specified element name as a string. This form of DVM lookup is used to find a single reference element and return a single element value. Lookups involving multiple elements in a reference or return domain need to be done using the `dvm:lookupValueNVP` function.

Parameters

<i>Parameter</i>	<i>Description</i>
<code>mapName</code>	The domain value map name, as string.
<code>referenceElementName</code>	The source element name, as string.
<code>referenceValue</code>	The source value (an XPath expression bound to the source document of the XSLT transformation), as string.
<code>elementName</code>	The target element name, as string.
<code>defaultValue</code>	If the value is not found, then the default value is returned, as string.
<code>needAnException</code>	Specify true or false. If the <code>needAnException</code> parameter is set to true, an exception occurs if the value being looked up in the map is not found. If the <code>needAnException</code> parameter is set to false, an empty value is returned if the value being looked up in the map is not found.

Returns

The `dvm:lookupValue` returns a string containing the value of the element.

An exception can occur for the following reasons:

- The DVM map with the given name is not found.
- The specified elements are not found.
- The specified source value is empty.

Example

The following code looks up the value of the *Short* element in the *StateCodes* DVM map corresponding to the *California* value in the *Long* element:

```
dvm:lookupValue("StateCodes","Long","California","Short","CouldNotBeFound",True)
```

dvm:lookupValueNVP

Syntax

```
dvm:lookupValueNVP(mapName, referenceDomain, referenceNVP, targetDomain, defaultNVP⇒  
, needAnException)
```

Description

The `dvm:lookupValueNVP` function finds the reference domain element values in a DVM and returns the equivalent values of all elements in the specified domain as an NVP list. This form of DVM lookup should be used when multiple elements exist in either the reference or return domain. All required elements in the reference domain must be included in the reference NVP list, but optional elements (qualifiers perhaps) do not have to be included. The return string will include values for all elements in the target domain as an NVP list regardless of whether they are required.

Parameters

<i>Parameter</i>	<i>Description</i>
<code>mapName</code>	The domain value map name, as string.
<code>referenceDomain</code>	The source domain name, as string.
<code>referenceNVP</code>	NVP list of source elements and values, as string.
<code>targetDomain</code>	The target domain name, as string.
<code>defaultNVP</code>	If the value is not found, then the default values specified are returned, as string.
<code>needAnException</code>	Specify true or false.

Returns

The return string will include values for all elements in the target domain as an NVP list regardless of whether they are required.

An exception can occur for one of the following reasons:

- The DVM map with the given name is not found.
- The specified domains are not found.
- The specified elements are not found.
- The specified source values are empty.

Example

The following code looks up the specified values of the *BusinessUnit* and *Chartfield* elements in the *PeopleSoft* domain of the *ChartElements* DVM and returns the value of the *UniqueGUID* element:

```
dvm:lookupValueNVP ("ChartElements", "PeopleSoft", "<BusinessUnit>US100</BusinessUnit>=>
<Chartfield>ACCOUNT</Chartfield>", "UniqueGUID", "<UniqueGUID>CouldNotBeFound</Unique=>
GUID>", True)
```

dvm:lookup-dvm

Syntax

```
dvm:lookup-dvm (mapName, referenceElementName, referenceValue, elementName, default=>
Value, needAnException)
```

Description

The `dvm:lookup-dvm` function finds the reference element value in a domain value map and returns the equivalent value of the specified element name as a string. This form of DVM lookup is used to find a single reference element and return a single element value. Lookups involving multiple elements in a reference or return domain need to be done using the `dvm:lookupValueNVP` function. This function is identical in purpose and function to the `dvm:lookupValue` function. It exists to mimic the function names defined in the ESB implementation of DVM.

Parameters

Parameter	Description
mapName	The domain value map name, as string.
referenceElementName	The name of the source element in the DVM, as string.
referenceValue	The source value (an XPath expression bound to the source document of the XSLT transformation), as string.
elementName	The name of the target element in the DVM, as string.
defaultValue	A default value to assign to the target element if no value is found, as string.

Parameter	Description
needAnException	Specify true or false. If the needAnException parameter is set to true, an exception occurs if the value being looked up in the map is not found. If the needAnException parameter is set to false, an empty value is returned if the value being looked up in the map is not found.

Returns

This function returns a string by looking up the value for the target element in the DVM, where the value for the source element is equal to the source value. The source value is an XPath expression bound to the source document of the XSLT transformation. The expression is evaluated during the transformation and the result value is passed as the source value for lookup.

An exception can occur for the following reasons:

- The DVM map with a given name is not found.
- The specified elements are not found.
- The specified source value is empty.

Example

The following code looks up the value of the *Short* element in the *StateCodes* DVM map corresponding to the *Calif* value in the *Abbrev* element:

```
dvm:lookup-dvm("StateCodes", "Abbrev", "Calif", "Short", "CouldNotBeFound", True)
```

Generate-Guid Function

This section discuss the generate-guid function.

generate-guid

Syntax

```
generate-guid()
```

Description

Use this function to generate a guid.

Parameters

none

Returns

This function returns a string containing a randomly generated globally unique identifier (GUID).

Example

The following code generates a random GUID that could be used as a new common key value:

```
generate-guid()
```

SetID Functions

This section describes the SetID XSLT extension function.

SetID:lookupSetCtrlValues

Syntax

```
SetID:lookupSetCtrlValues (SetId, LookupType, dvmTranslate, dvmMapName, SourceElementName, TargetElementName, needAnException)
```

Description

Use the lookupSetCtrlValues function to look up the list of set control values associated with the setID in the context of a record group or record. Optionally, each set control value can be translated through a DVM map if a map name, source element name, and target element name are provided.

Parameters

<i>Parameter</i>	<i>Description</i>
SetId	The SetId value interested in lookup.
LookupType	The lookup type is used to indicate the type of lookup. You can specify either <i>1</i> for the record group name or <i>2</i> for the record name.
LookupValue	Value should be either a record name or record group ID as determined by LookupType.
dvmTranslate	Specify <i>True</i> if translation to Common ID using DVM Name supplied is desired. Specify <i>False</i> if no translation is needed.
dvmMapName	DVM map to be used in translation if requested.

Parameter	Description
SourceElementName	The source element name to be used in DVM translation if requested.
TargetElementName	The target element name to be used in DVM translation if requested.
needAnException	Specify true or false to indicate whether an exception should occur if set control values are not found.

Returns

This function returns a list of set control values or a list of translated set control values as a concatenated string that could be parsed in XSLT.

Example

This example looks up the set control values (representing PeopleSoft business units in this example) associated with the setID *SHARE* for the record group *VENDOR* and translates them to the common IDs for Business Unit by means of the DVM mapping *BusinessUnit*. An exception is requested if set control values are not found:

```
xref:lookupSetCtrlValues("SHARE","1", "VENDOR",true(),"BusinessUnit","PSFT_BU","COM⇒
MON",true())
```

Exceptions can occur for the following reasons:

- The DVM map name specified is not valid.
- The source element name specified is not associated with the DVM map.
- The target element name specified is not associated with the DVM map.
- No translated value is found for the set control value in the DVM map.
- If needAnException is set to true, an exception will occur if the set control values cannot be found for the given SETID/Record or record group ID.

This example looks up the set control values (representing PeopleSoft Business Units in this example) associated with the SETID *SHARE* for the record *VENDOR_LOC* and translates them to the common IDs for Business Unit by means of the DVM mapping *BusinessUnit*. An exception is not requested if set control values are not found:

```
xref:lookupSetCtrlValues("SHARE","2", "VENDOR_LOC",true(),"BusinessUnit","PSFT_BU",⇒
"COMMON",false())
```

This example looks up the set control values (representing PeopleSoft Business Units in this example) associated with the setID *SHARE* for the record group *VENDOR*. An exception is requested if set control values are not found:

```
xref:lookupSetCtrlValues("SHARE","1", "VENDOR",false(),"","",true())
```

An exception can occur if the set control values cannot be found for the given SETID/Record or record group ID.

Chapter 6

Accessing Maps Using PeopleCode

Understanding Application Integration Framework Classes

Application Integration Framework classes provide functions to perform value map lookups, deletes, and population. The following functions mirror the functionality of the XPath extension functions provided for XSLT transformation.

<i>Term</i>	<i>Definition</i>
DVM Utility Class	Functions for PeopleCode developers to access the data for a domain value map (DVM) during transformations. These functions mirror the functionality of the XPath extension functions provided for XSLT transformations.
SetId Utility Class	Functions for PeopleCode developers to access SetId data stored in a DVM during transformations.
Xref Utility Class	Functions for PeopleCode developers to access the data for a dynamic (cross-reference) value map during transformations.

How to Import Application Integration Framework Type Classes

The Application Integration Framework type classes are not built-in classes, like Rowset, Field, Record, and so on. They are application classes. Before you can use these classes in your PeopleCode program, you must import them to your program.

An import statement names either all the classes in a package or one particular application class. For importing Application Integration Framework classes, Oracle recommends that you import the functions class in the application package that is specific to your needs.

The function classes are stored in the following application packages:

- EOTF_CORE:DVM
- EOTF_CORE:SetId
- EOTF_CORE:Xref

You should use one of the following import statements:

```
import EOTF_CORE:DVM:Functions;  
import EOTF_CORE:Setid:Functions;  
import EOTF_CORE:Xref;
```

DVM Utility Class Methods

This section describes the DVM utility class methods. The methods are discussed in alphabetical order.

ExtractData

Syntax

```
ExtractData (mapName, domainList, tempRecName, instance)
```

Description

You can use the DVM extract data function to generate and execute set-based SQL to extract DVM data into a specified table. Prior to data extraction, all data is removed from the temp table for the specified process instance. Element values are mapped to fields in the temp record using the order of the specified domain list followed by the element order specified in the value map definition. If no domains are specified, element values are mapped to fields in the temp record using only the element order specified in the value map definition. This function is expected to be used for processing large volumes of data. It provides an abstraction layer from the physical data persistence layer of the DVM framework.

The temp table has the following design constraints:

1. The first column will be PROCESS_INSTANCE.
2. The second column will be used for UniqueGUID (EOTF_COMMONELEMENT).
3. The remaining columns correspond to the elements in the specified domain list.
4. The temp table column names do not have to match the element names in the DVM.
5. The table should be keyed by ProcessInstance, UniqueGUID.
6. There may be a performance benefit from having an index on the elements of each specified domain.

Parameters

Parameter	Description
mapName	The name of static value map definition (DVM), as sting.
domainList	The name of the value map domain(s) to extract data for. Provide null or an empty array in this parameter to extract data for all domains in the map.
tempRecName	The name of the temp table to extract data into, as string.
instance	The number to use when qualifying process instance, as integer.

Returns

Boolean indicating success or failure of the process.

Example

```
Local EOTF_CORE:DVM:Functions &dvm = create EOTF_CORE:DVM:Functions();
Local string &mapName = "States";
Local array of string &domainList = CreateArray("PS");
Local string &tempRecName = Record.HR_STATES_TAO;
Local boolean &success =
&dvm.ExtractData(&mapName, &domainList, &tempRecName, &instance);
```

LookupValue

Syntax

LookupValue (*mapName*, *referenceElementName*, *referenceValue*, *elementName*, *defaultValue*, *needAnException*)

Description

Locate the reference element value in a domain value map, and return the equivalent value for the specified element name. This form of DVM lookup is used to find a single reference element and return a single element value.

Parameters

<i>Parameter</i>	<i>Description</i>
mapName	Name of a static value map definition (DVM), as string.
referenceElementName	Name of an element in the DVM in which to look for a value, as string.
referenceValue	Value of an element in the DVM to look for, as string.
elementName	Name of the element in the DVM to return an equivalent value for, as string.
defaultValue	Default value to be returned if needAnException is false and an error occurs, as string.
needAnException	<i>True</i> to return error messages, <i>false</i> to return the default value.

Returns

The equivalent value of elementName in the DVM, or the default value.

Example

This example is used to look up the value *&guid1* in the *UniqueGUID* element of the *&TestName* DVM and return the equivalent value of element *&EBS1*.

```
Local string &returnValue = &dvm.LookupValue(&TestName, &UniqueGUID, &guid1, &EBS1, =>
    "Value not found.", True);
```

This example will look up a value that does not exist in element *&EBS1* of the *&TestName* DVM to verify that the default value is returned when the *NeedAnException* parameter is false.

```
&returnValue = &dvm.LookupValue(&TestName, &EBS1, "NotFound", &UniqueGUID, &ValueNo=>
    tFound, False);
```

LookupValue1M

Syntax

```
LookupValue1M (mapName, referenceElementName, referenceValue, elementName, needAnE=>
xception)
```

Description

Locate the reference element value in a domain value map, and return the equivalent values of the specified element name as an NVP list. This form of DVM lookup is used to find a single reference element and return one to many equivalent values for the specified element.

Parameters

<i>Parameter</i>	<i>Description</i>
mapName	Name of a static value map definition (DVM), as string.
referenceElementName	Name of an element in the DVM in which to look for a value, as string.
referenceValue	Value of an element in the DVM to look for, as string.
elementName	Name of the element in the DVM to return equivalent values for, as string.
needAnException	<i>True</i> to return error messages, <i>false</i> to return the default values.

Returns

An array of string containing the equivalent values of *elementName* in the DVM.

Example

This example will look up value *&guid1* in the *UniqueGUID* element of the *&TestName* DVM and return the equivalent value of element *&EBS1* :

```
&returnValue = &dvm.LookupValue1M(&TestName, &UniqueGUID, &guid1, &EBS1, True);
```

This example will look up a value that does not exist in the *UniqueGUID* element of the *&TestName* DVM to verify that no value is returned when the *NeedAnException* parameter is false:

```
&returnValue = &dvm.LookupValue1M(&TestName, &UniqueGUID, "NotFound", &EBS1, False=>
);
```

LookupValueNVP

Syntax

```
LookupValueNVP (mapName, referenceDomain, referenceNVP, targetDomain, defaultNVP, needAnException)
```

Description

Locate the reference domain element values in a DVM, and return the equivalent values of all elements in the specified domain as an NVP list. This form of DVM lookup should be used when multiple elements exist in either the reference or return domain. All required elements in the reference domain must be included in the reference NVP list, but optional elements (qualifiers perhaps) do not have to be included. The return string will include values for all elements in the target domain as an NVP list regardless of whether they are required.

Parameters

Parameter	Description
mapName	Name of a static value map definition (DVM), as string.
referenceDomain	Name of a domain in the DVM in which to look for a value, as string.
referenceNVP	Name value pairs of elements and values in the DVM domain to look for, as an array of DataElement.
targetDomain	Name of the domain to return equivalent values for, as string.
defaultNVP	Default values (NVPs) to be returned if needAnException is false and an error occurs, as an array of DataElement.
needAnException	<i>True</i> to return error messages, <i>false</i> to return an NVP with the default values.

Returns

An array of `DataElement`. Name value pairs containing the equivalent values for the elements in the target domain, or the default values.

Example

This example is used to look up value *&guid1* in the *UniqueGUID* domain of the *&TestName* DVM and return the equivalent values for the *&RTK* domain:

```
Local array of EOTF_CORE:Common:DataElement &UniqueGUIDrequestValues = CreateArray(⇒
create EOTF_CORE:Common:DataElement(&UniqueGUID));

&UniqueGUIDrequestValues [1].value = &guid1;
Local array of EOTF_CORE:Common:DataElement &returnValue = &dvm.LookupValueNVP(&Tes⇒
tName, &UniqueGUID, &UniqueGUIDrequestValues, &RTK, &DefaultRTKValues, True);
```

DVM Utility Class Properties

This section describes the DVM utility class properties.

exceptionCaught

Description

Value true when a lookup method suppresses an exception because the `needAnException` parameter was false.

exceptionDetails

Description

Exception object containing the detail of the exception that was caught.

SetId Utility Class Methods

This section describes the `SetId` Utility class methods. The methods are discussed in alphabetical order.

lookupSetCtrlValues

Syntax

```
lookupSetCtrlValues (SetId, LookupType, LookupName, dvmTranslate, dvmMapName, PsftE⇒
lementName, CommonElementName, needAnException)
```

Description

You can use the `lookupSetCtrlValues` function to look up the set control values associated with a `setId` in the context of a record or record group. Furthermore, you can request that the set control value be translated through a specified DVM map from the element in the PeopleSoft domain to an element in the common domain. In a typical PeopleSoft implementation the set control values represent PeopleSoft Business Unit. In such case, you would have a DVM defined for Business Unit mapping for translation.

Parameters

<i>Parameter</i>	<i>Description</i>
<code>setId</code>	The <code>setId</code> value interested in lookup, as string.
<code>lookupType</code>	The type of lookup to perform. Valid values are <i>1</i> for record group ID and <i>2</i> for record name.
<code>lookupName</code>	Record group ID or record name, as string. The value should correspond to the <code>lookupType</code> specified.
<code>dvmTranslate</code>	Specify <i>True</i> if translation of set control values using the static value map (DVM) supplied is desired.
<code>dvmMapName</code>	The name of the static value map (DVM) to be used in translation, as string.
<code>psftElementName</code>	The name of the element belonging to the PeopleSoft domain in the DVM to use in lookup, as string.
<code>commonElementName</code>	The name of the element belonging to the Common domain in the DVM for which to return an equivalent value, as string.
<code>needAnException</code>	<i>True</i> to cause exception to occur in case set control values are not found. <i>False</i> to request an empty string in such case instead.

Returns

The equivalent values in array of string.

Example

This example looks up the set control values (representing PeopleSoft Business Units in this example) associated with the `setId` *SHARE* for the record group *VENDOR* and translates them to the common IDs for Business Unit by means of the DVM mapping *BusinessUnit*. An exception is requested if set control values are not found:

```
&oSetIdUtil = create EOTF_CORE:SetId:Functions();
```

```

Local array of string &arrReturnValue = CreateArrayRept("", 0);

try

    &arrReturnValue = &oSetIdUtil.lookupSetCtrlValues("SHARE", "1", "VENDOR", true,
e, "BusinessUnit", "PSFT_BU", "COMMON", true);

    catch Exception &exReturn
    . . .
        {Your Exception Handling Logic Here}
    . . .
end-try;
    
```

lookupSetID

Syntax

lookupSetID (*LookupValue, dvmTranslate, dvmMapName, PsftElementName, CommonElementName, LookupType, LookupName, needAnException*)

Description

You can use the lookupSetID function to look up the setID corresponding to a set control value in the context of a record or record group. Furthermore, you can request that the set control value to use for lookup be translated through a specified DVM map from an element in a common domain to the element in the PeopleSoft domain. In a typical PeopleSoft implementation the set control values represent PeopleSoft Business Units. In this case, you would have a DVM defined for Business Unit mapping translation.

Parameters

Parameter	Description
LookupValue	Value to use in setID lookup, as string. Value should either be a set control value if dvmTranslate is false or a common element value if dvmTranslate is true.
dvmTranslate	Specify <i>True</i> if translation of set control values using static value map (DVM) supplied is desired.
dvmMapName	The name of the static value map (DVM) to be used in translation, as string.
PsftElementName	Name of the element belonging to the PeopleSoft domain in the DVM for which to retrieve the equivalent set control value, as string.
CommonElementName	Name of the element belonging to the Common domain in the DVM to use in lookup, as string.

Parameter	Description
LookupType	The type of lookup to perform. Valid values are <i>1</i> for record group ID and <i>2</i> for record name.
LookupName	Record group ID or record name, as string. The value should correspond to the LookupType specified.
needAnException	<i>True</i> to cause exception to occur in case setID is not found. <i>False</i> to request an empty string in such case instead.

Returns

The equivalent value as string.

Example

The following code looks up the setID associated with the common ID for Business Unit *BUID001* in the DVM mapping *BusinessUnit* for the record group *VENDOR*. No exception is requested if setID is not found (empty string will be returned):

```
&oSetIdUtil = create EOTF_CORE:SetId:Functions();
Local string &ReturnValue;
&ReturnValue = &oSetIdUtil.lookupSetId("BUID001", "BusinessUnit", "PSFT_BU", "COMMO→
N", "1", "VENDOR", false);
```

Xref Utility Class Methods

This section describes the Xref class methods. The methods are discussed in alphabetical order.

BulkPopulateDomainData

Syntax

```
BulkPopulateDomainData (mapName, domainList, dataRows, dataValuesPath, mode)
```

Description

The XREF bulk populate domain data function populates cross-reference data from XML. It sequences through the rows of data provided in the XML nodeset and uses the supplied domain list and data values path to access the values for each domain in each row. Each row of data is then inserted into the XREF framework for the specified map utilizing bulk insert to maximize performance. This function is expected to be used for processing large volumes of data. It provides an abstraction layer from the physical data persistence layer of the XREF framework. Because inserts are done using bulk mode, duplicates are not looked for until the end of the insert sequence. If a duplicate is encountered, none of the rows of data

will be inserted. When a domain contains multiple elements, each value for the domain must contain a compound value consisting of a value for each element in the domain separated by the concatenation string specified in the value map options. In this scenario, this function will unconcatenate the domain element values before inserting the data into the transformation framework.

Parameters

<i>Parameter</i>	<i>Description</i>
mapName	The name of a dynamic (cross reference) value map, as string.
domainList	An array of domain names identifying the order of the data values to be imported.
dataRows	An array of XML nodes where each node in the array is one row of data.
dataValuesPath	An XPath expression (relative to each row of data) used to identify each node containing a data value within a row of data. The nodeset returned when this path is evaluated must contain the same number of nodes as there are domains in the specified domainList.
mode	Only <i>ADD</i> mode is supported.

Returns

Boolean indicating success or failure of the process.

Example

```
Local EOTF_CORE:Xref:Functions &xref = create EOTF_CORE:Xref:Functions();
Local string &mapName = "VendorIDs";
Local array of string &domainList = ...;
Local array of XmlNode &dataRows = ...;
Local string &dataValuesPath = "...";
Local string &mode = "ADD";
Local boolean &success =
&xref.BulkPopulateDomainData(&mapName, &domainList, &dataRows, &dataValuesPath, &mode);
```

BulkPopulateElementData

Syntax

```
BulkPopulateElementData (mapName, elementList , dataRows, dataValuesPath, mode)
```

Description

The XREF bulk populate element data function populates cross-reference data from XML. It sequences through the rows of data provided in the XML nodeset and uses the supplied pairs of elements and XPath expressions to access the values for the elements in each row. Each row of data is then inserted into the XREF framework for the specified map utilizing bulk insert to maximize performance. This function is expected to be used for processing large volumes of data. It provides an abstraction layer from the physical data persistence layer of the XREF framework. because inserts are done using bulk mode, duplicates are not looked for until the end of the insert sequence. If a duplicate is encountered, none of the rows of data will be inserted.

Parameters

<i>Parameter</i>	<i>Description</i>
mapName	The name of a dynamic (cross reference) value map, as string.
elementList	An array of element names identifying the order of the data values to be imported.
dataRows	An array of XML nodes where each node in the array is one row of data.
dataValuesPath	An XPath expression (relative to each row of data) used to identify each node containing a data value within a row of data. The nodeset returned when this path is evaluated must contain the same number of nodes as there are elements in the specified elementList.
mode	Only <i>ADD</i> mode is supported.

Returns

Boolean indicating success or failure of the process.

Example

```
Local EOTF_CORE:Xref:Functions &xref = create EOTF_CORE:Xref:Functions();
Local string &mapName = "VendorIDs";
Local array of string &elementList = ...;
Local array of XmlNode &dataRows = ...;
Local string &dataValuesPath = "...";
Local string &mode = "ADD";
Local boolean &success = &xref.BulkPopulateElementData(&mapName, &elementList, &dataRows, &dataValuesPath, &mode);
```

ExtractData

Syntax

ExtractData (*mapName*, *domainList*, *tempRecName*, *instance*)

Description

You can use the XREF extract data function to generate and execute set-based SQL to extract cross-reference data into a specified table. Prior to data extraction, all data is removed from the temp table for the specified process instance. Element values are mapped to fields in the temp record using the order of the specified domain list followed by the element order specified in the value map definition. If no domains are specified, element values are mapped to fields in the temp record using only the element order specified in the value map definition. This function provides an abstraction layer from the physical data persistence layer of the XREF framework, and is expected to be used for processing large volumes of data.

The temp table has the following design constraints:

1. The first column will be PROCESS_INSTANCE.
2. The second column will be used for UniqueGUID (EOTF_COMMONELEMENT).
3. The remaining columns correspond to the elements in the specified domain(s).

Note: If the third column is named EOTF_IMPORT_FLG, it will be valued with *N* during the export.

4. The temp table column names do not have to match the element names in the map.
5. The temp table should be uniquely keyed by ProcessInstance, UniqueGUID.
6. There may be a performance benefit from having an index on the elements of each specified domain.

Parameters

<i>Parameter</i>	<i>Description</i>
mapName	The name of the dynamic cross reference map, as string.
domainList	The name of the value map domain(s) to extract data for. Provide null or an empty array in this parameter to extract data for all domains in the map.
tempRecName	The name of the temp table to extract data into, as string.
instance	The number to use when qualifying process instance, as integer.

Returns

Boolean indicating success or failure of the process.

Example

```
Local EOTF_CORE:Xref:Functions &xref = create EOTF_CORE:Xref:Functions();
Local string &mapName = "VendorIDs";
Local array of string &domainList = CreateArray("PS");
Local string &tempRecName = Record.HR_VENDOR_TAO;
Local boolean &success =
&xref.ExtractData(&mapName, &domainList, &tempRecName, &instance);
```

LookupValue

Syntax

LookupValue (*mapName*, *referenceElementName*, *referenceValue*, *elementName*, *needAnException*)

Description

Locate the reference element value in a cross-reference value map, and return the equivalent value for the specified element name. This form of lookup is used to find a single reference element and return a single element value.

Parameters

<i>Parameter</i>	<i>Description</i>
mapName	Name of a dynamic (cross-reference) value map definition, as string.
referenceElementName	Name of an element in the Xref in which to look for a value, as string.
referenceValue	Value of an element in the Xref to look for, as string.
elementName	Name of the element in the Xref for which to return equivalent values, as string.
needAnException	<i>True</i> to return error messages, <i>false</i> to return blank.

Returns

An array of string containing the equivalent values of elementName in the Xref.

Example

This example will look up value *&guid1* in the *UniqueGUID* element of the *&TestName* cross-reference map and return the equivalent value of element *&EBS1*:

```
Local string &returnValue = &xref.LookupValue(&TestName, &UniqueGUID, &guid1, &EBS1⇒
, True);
```

This example will look up a value that does not exist in element *&EBS1* of the *&TestName* cross-reference map to verify that the default value (blank) is returned when the *NeedAnException* parameter is false:

```
&returnValue = &xref.LookupValue(&TestName, &EBS1, "NotFound", &UniqueGUID, False);⇒
```

LookupValue1M

Syntax

```
LookupValue1M ( mapName, referenceElementName, referenceValue, elementName, needAn⇒
Exception)
```

Description

Locate the reference element value in a cross-reference value map, and return the equivalent values of the specified element name as a named value pair (NVP) list. This form of lookup is used to find a single reference element and return one to many equivalent values for the specified element.

Parameters

<i>Parameter</i>	<i>Description</i>
mapName	Name of a dynamic (cross-reference) value map definition, as string.
referenceElementName	Name of an element in the Xref in which to look for a value, as string.
referenceValue	Value of an element in the Xref to look for, as string.
elementName	Name of the element in the Xref for which to return equivalent values, as string.
needAnException	<i>True</i> to return error messages, <i>false</i> to return blank.

Returns

An array of string containing the equivalent values of *elementName* in the cross-reference.

Example

This example will look up value *&guid1* in the *UniqueGUID* element of the *&TestName* cross-reference map and return the equivalent value of element *&EBS1*:

```
Local array of string &returnValue;
&returnValue = &xref.LookupValue1M(&TestName, &UniqueGUID, &guid1, &EBS1, True);
```

This example will look up a value that does not exist in the *UniqueGUID* element of the *&TestName* cross-reference map to verify that no value is returned when the *NeedAnException* parameter is false:

```
&returnValue = &xref.LookupValue1M(&TestName, &UniqueGUID, "NotFound", &EBS1, False);
```

LookupValueNVP

Syntax

```
LookupValueNVP (mapName, referenceDomain, referenceNVP, targetDomain, needAnException)
```

Description

Locate the reference domain element values in a cross-reference map, and return the equivalent values of all elements in the specified domain as an NVP list. This form of lookup should be used when multiple elements exist in either the reference or return domain. All required elements in the reference domain must be included in the reference NVP list, but optional elements (qualifiers perhaps) do not have to be included. The return string will include values for all elements in the target domain as an NVP list regardless of whether they are required.

Parameters

Parameter	Description
mapName	Name of a dynamic (cross-reference) value map definition, as string.
referenceDomain	Name of a domain in the XREF in which to look for a value, as string.
referenceNVP	Name value pairs of elements and values in the reference domain to look for, as an array of DataElement.
targetDomain	Name of the domain to return equivalent values for, as string.
needAnException	<i>True</i> to return error messages, <i>false</i> to return an NVP with the default values.

Returns

An array of DataElement for name value pairs containing the equivalent values for the elements in the target domain, or the default values.

Example

This example will look up value *&guid1* in the *UniqueGUID* domain of the *&TestName* cross-reference map and return the equivalent values for the *&RTK* domain:

```
Local array of EOTF_CORE:Common:DataElement &returnValue = &xref.LookupValueNVP(&T⇒
estName, &UniqueGUID, &UniqueGUIDrequestValues, &RTK, True);
```

MarkForDelete

Syntax

```
MarkForDelete (mapName, elementName, elementValue)
```

Description

Delete a value in a cross-reference map when the element specified is the only element for a single domain. If multiple domains reference the element, or the element is used in a domain containing multiple primary elements, the `xref.markForDeleteNVP` function should be used instead. The values in the elements are marked as deleted. If only two mappings are in a row and one of them is marked for deletion, then the value in the other domain will also be deleted. Any element value marked for delete is treated as if the value does not exist. Therefore, you can populate the same element with the `xref.populateXRefRow` function in ADD mode. However, using the element value marked for delete as a reference value in the LINK mode of the `xref.populateXRefRow` function would cause an error.

Parameters

<i>Parameter</i>	<i>Description</i>
mapName	Name of a dynamic (cross-reference) value map definition, as string.
elementName	Name of the element in the Xref from which to delete a value, as string.
elementValue	Value of the element in the Xref to be deleted, as string.

Returns

True if the delete succeeds.

Example

This example will delete the *PS001* value in the *PS* element of the *Customers* cross-reference map:

```
&return=&xref.MarkForDelete("Customers", "PS", "PS001")
```

MarkForDeleteNVP

Syntax

```
MarkForDeleteNVP (mapName, referenceDomain, referenceNVP)
```

Description

Delete a set of values in a cross-reference map for a specified domain. The values in the elements are marked as deleted. If only two mappings are in a row and one of them is marked for deletion, then the value in the other domain will also be deleted. Any values marked for delete are treated as if they do not exist. Therefore, you can populate the same elements with `xref:populateXRefRowNVP` function in ADD mode. However, using the values marked for delete as a reference value in the LINK mode of the `xref:populateXRefRowNVP` function would cause an error.

Parameters

<i>Parameter</i>	<i>Description</i>
mapName	Name of a dynamic (cross-reference) value map definition, as string.
referenceDomain	Name of a domain in the Xref from which to delete values, as string.
referenceNVP	Name value pairs of elements and values in the reference domain to be deleted, as an array of DataElement.

Returns

True if the delete succeeds.

Example

This example deletes the specified values in the EBS domain from the Items cross-reference map:

```
Local array of EOTF_CORE:Common:DataElement &ebsNVP1 = CreateArrayRept(create EOTF_→
CORE:Common:DataElement(&EBS1), 1);
&ebsNVP1 [1].value = &value1;
Local boolean &return = &xref.MarkForDeleteNVP("Items", &EBS1, &ebsNVP1);
```

PopulateData

Syntax

PopulateData (*mapName, domainName, tempRecName, recName, instance*)

Description

You can use the XREF populate data function to generate and execute set-based SQL to populate cross-reference data from a specified source record (table or view). This function provides an abstraction layer from the physical data persistence layer of the XREF framework, and is expected to be used for processing large volumes of data.

The following steps are generated and executed in this function:

1. All data is removed from the temp table for the specified process instance.
2. Existing XREF data for the specified domain is extracted to the temp table with the import flag set to *N*.

Note: Element values are mapped to fields in the record based on map element order (not on name).

3. Distinct rows of stage data are inserted into the temp table if they do not already exist, with the update flag set to *Y*.

Note: Fields are mapped from temp to stage based on matching field names.

4. GUIDs are generated on the temp table where they are blank.
5. XREF data is inserted from the temp table where the import flag set to *Y*.
6. The stage data is updated with GUIDs from the temp table.

The temp table has the following design constraints:

1. The first column will be PROCESS_INSTANCE.
2. The second column will be used for UniqueGUID (EOTF_COMMONELEMENT).
3. The third column must be EOTF_IMPORT_FLG (for internal use by this function).
4. The remaining columns correspond to the elements in the specified domain.
5. The temp table column names do not have to match the element names in the maps.
6. The temp table column names must match the corresponding fields on the stage table.
7. The temp table should be keyed by ProcessInstance, UniqueGUID allowing for duplicates (blanks).
8. There may be a performance benefit from having an index on the elements of each specified domain.

Note: This function does not validate any of the data, therefore, users should be sure the data being populated does not violate any of the constraints defined in the value map definition. If the data rules are violated, future usability of the map may be impacted. This function is not responsible for protecting against the potential for truncation of existing data values caused by defining temp table fields shorter than the existing data values. If this occurs, no error will then be thrown, but existing values will not be matched properly to stage values, potentially resulting in unintended data redundancy.

Parameters

<i>Parameter</i>	<i>Description</i>
mapName	The name of a dynamic (cross reference) value map, as string.
domainName	The name of the value map domain to populate data for, as string.
tempRecName	The name of the temp table to extract existing XREF data to, as string.
recName	The name of the stage record to populate data from, as string.
instance	The number to use when qualifying process instance, as integer.

Returns

Boolean indicating success or failure of the process.

Example

```
Local EOTF_CORE:Xref:Functions &xref = create EOTF_CORE:Xref:Functions();
Local string &mapName = "VendorIDs";
Local string &domainName = "PS";
Local string &tempRecName = Record.HR_VENDOR_TAO;
Local string &recName = Record.HR_VENDOR_STG;
Local boolean &success =
&xref.PopulateData(&mapName, &domainName, &tempRecName, &recName, &instance);
```

PopulateValue

Syntax

```
PopulateValue (mapName, referenceElementName, referenceValue, elementName, elementValue, mode)
```

Description

Locate a reference element value in a cross-reference map and populate another element in the same data row with an equivalent value. This form of populate is used to find a single reference element and populate a single element value.

Parameters

<i>Parameter</i>	<i>Description</i>
mapName	Name of a dynamic (cross-reference) value map definition, as string.
referenceElementName	Name of an element in the Xref in which to look for a value, as string.
referenceValue	Value of an element in the Xref to look for, as string.
elementName	Name of the element in the Xref in which to supply an equivalent value, as string.
elementValue	The equivalent value to be supplied to the element, as string.
mode	The mode in which the function populates the element. You can specify any of the following values: ADD, LINK, or UPDATE. The mode parameter values are case-sensitive and must be specified in uppercase only.

Returns

The UniqueGUID value of the Xref row where the data was populated.

Example

This example will locate value *&guid1* in the *UniqueGUID* element of the *&TestName* cross-reference map, and update the equivalent value of element *EBS1* to *&value1*:

```
&value1 = &value1 | "0";
&returnValue = &xref.PopulateValue(&TestName, &UniqueGUID, &guid1, &EBS1, &value1 =>
, &UPDATE);
```

This example will add values *&guid3* in the *UniqueGUID* element and *&value3* in the *EBS1* element to the *&TestName* cross-reference map data:

```
Local string &guid3 = UuidGen();
Local string &value3 = "00003";
&returnValue = &xref.PopulateValue(&TestName, &EBS1, &value3, &UniqueGUID, &guid3, =>
&ADD);
```

This example will add value *&value4* in the *EBS1* element to the *&TestName* cross-reference map data, and let the code generate a random *UniqueGUID*:

```
Local string &value4 = "00004";
&returnValue = &xref.PopulateValue(&TestName, &EBS1, &value4, &UniqueGUID, "", &AD⇒
D);
```

PopulateValueNVP

Syntax

```
PopulateValueNVP (mapName, referenceDomain, DataElement referenceNVP, targetDomain⇒
, targetNVP, mode)
```

Description

Locate the reference domain element values in a cross-reference map, and populate another domain's elements in the same data row with an equivalent value. This form of populate should be used when multiple elements exist in either the reference or target domain. All required elements in the reference domain must be included in the reference NVP list, but optional elements such as qualifiers do not have to be included.

Parameters

Parameter	Description
mapName	Name of a dynamic (cross-reference) value map definition, as string.
referenceDomain	Name of a domain in the Xref in which to look for a value, as string.
referenceNVP	Name value pairs of elements and values in the reference domain to look for, as an array of DataElement.
targetDomain	Name of the domain in which to populate equivalent values, as string.
targetNVP	Element names and their equivalent values (NVPs) to be populated in the Xref map, as an array of DataElement.
mode	The mode in which the function populates the element. You can specify any of the following values: ADD, LINK, or UPDATE. The mode parameter values are case-sensitive and must be specified in uppercase only.

Returns

The UniqueGUID value of the Xref row where the data was populated.

Example

This example will locate value *&guid1* in the *UniqueGUID* element of the *&TestName* cross-reference map, and update the equivalent value of element *EBS1* to *&value1*:

```
&value1 = &value1 | "0";
&ebsNVP1 [1].value = &value1;
&returnValue = &xref.PopulateValueNVP(&TestName, &UniqueGUID, &guidNVP1, &EBS, &ebsNVP1, &UPDATE);
```

This example will add values *&guid3* in the *UniqueGUID* element and *&value3* in the *EBS1* element to the *&TestName* cross-reference map data:

```
Local string &guid3 = UuidGen();
Local array of EOTF_CORE:Common:DataElement &guidNVP3 = CreateArrayRept(create EOTF_CORE:Common:DataElement(&UniqueGUID), 1);
&guidNVP3 [1].value = &guid3;
Local string &value3 = "00003";
Local array of EOTF_CORE:Common:DataElement &ebsNVP3 = CreateArrayRept(create EOTF_CORE:Common:DataElement(&EBS1), 1);
&ebsNVP3 [1].value = &value3;
&returnValue = &xref.PopulateValueNVP(&TestName, &EBS, &ebsNVP3, &UniqueGUID, &guidNVP3, &ADD);
```

This example will add value *&value4* in the *EBS1* element to the *&TestName* cross-reference map data, and let the code generate a random UniqueGUID:

```
Local array of EOTF_CORE:Common:DataElement &guidNVP4 = CreateArrayRept(create EOTF_CORE:Common:DataElement(&UniqueGUID), 1);
Local string &value4 = "00004";
Local array of EOTF_CORE:Common:DataElement &ebsNVP4 = CreateArrayRept(create EOTF_CORE:Common:DataElement(&EBS1), 1);
&ebsNVP4 [1].value = &value4;
&returnValue = &xref.PopulateValueNVP(&TestName, &EBS, &ebsNVP4, &UniqueGUID, &guidNVP4, &ADD);
&requestValues = CreateArrayRept(create EOTF_CORE:Common:DataElement(&EBS1), 1);
&requestValues [1].value = &value4;
```

Xref Class Properties

This section discusses the Xref class properties.

exceptionCaught

Description

Value true when a lookup method suppresses an exception because the needAnException parameter was false.

exceptionDetails

Description

Exception object containing the detail of the exception that was caught.

Accessing Maps Using Web Services

Understanding Application Integration Framework Web Services

Application Integration Framework web services provide external applications a web-service-based means of accessing Application Integration Framework map information. Web services are implemented by means of the PeopleTools Integration Broker (IB) framework. The Integration Gateway web application receives all the web service requests and forwards them to the Integration Engine (application server) for processing.

This diagram illustrates an external application using the cross-reference lookup web service to look up values in an Application Integration Framework cross-reference map.

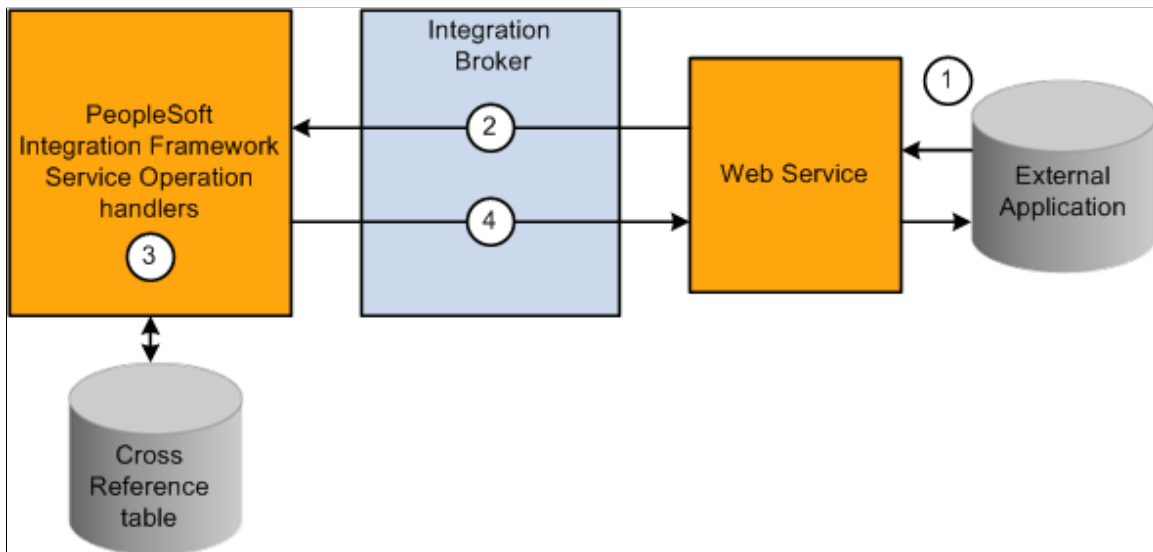

1. The external application invokes one of the web service operations.
2. PeopleSoft Integration Broker receives the service operation and validates the WS security credentials.
3. The request is passed to the application server for processing. The application server authenticates the service operation and routes it to the respective handler. The handler runs the PeopleCode and sends the response to the Integration Gateway.
4. Integration Broker sends the response to the external application.

EOTF_DVM Service

This section describes the Service Operations available as web services for DVM:

- EOTF_DVM_LOOKUP
- EOTF_DVM_IMPORT.v2
- EOTF_DVM_IMPORT.v1

EOTF_DVM_LOOKUP

This service operation is used to lookup values from a DVM.

Alias: dvmLookupValue

Type: Synchronous

Request Message: EOTF_DVM_LOOKUP_REQ.V1

This is an example of the soap body for the request:

```
<soapenv:Body>
  <dvm:dvmLookupValue>
    <dvm:mapname?></dvm:mapname>
    <!--2 or more repetitions:-->
    <dvm:Values>
      <dvm:domain?></dvm:domain>
      <!--1 or more repetitions:-->
      <dvm:element name="?" />
    </dvm:Values>
    <dvm:Values>
      <dvm:domain?></dvm:domain>
      <!--1 or more repetitions:-->
      <dvm:element name="?" />
    </dvm:Values>
    <dvm:targetDomain?></dvm:targetDomain>
  </dvm:dvmLookupValue>
</soapenv:Body>
```

Element Name	Description
mapname	The name of the domain value map to lookup values in.
<i>Values</i>	<i>This element holds the elements and values to be found in the DVM.</i>
domain	The name of the target domain provided on the lookup request.
element	Represents a DVM element and its value.
targetDomain	The name of the domain the lookup request should return values for.

Response Message: EOTF_DVM_RESPONSE.V1

Element Name	Description
status	The status of the operation. Returns <i>Success</i> or <i>Exception</i> .
reason	If there is an exception, the reason will be returned.
<i>requestValues</i>	<i>This element hold the reference values used for a lookup operation. For partially qualified lookups these values may differ from the values provided in the request.</i>
domain	The name of the reference domain provided on the lookup request.
element	The DVM element and its value.
<i>responseValues</i>	<i>The values returned for the lookup operation.</i>
domain	The name of the target domain provided on the lookup request.
element	The DVM element in the target domain and its value.

EOTF_DVM_IMPORT.v2

Use this service operation to import a Domain Value Map definition and values into the Enterprise Transformation Framework, based on the PeopleSoft schema.

Type: Asynchronous-One Way.

Alias: import_dvm

Default: Yes

Request Message: EOTF_DVM.V2

This is an example of the soap body for an import request using PeopleSoft schema:

```
<soapenv:Body>
  <dvm:dvm>
    <dvm:name>?</dvm:name>
    <!--Optional:-->
    <dvm:description>?</dvm:description>
    <!--Optional:-->
    <dvm:comments>?</dvm:comments>
    <dvm:elements>
      <!--2 or more repetitions:-->
      <dvm:element name="" order="" dataType="string" dataLength="" isComm=
on="false"/>
```

```

        <dvm:element name="?" order="?" dataType="string" dataLength="?" isComm=
on="false"/>
    </dvm:elements>
    <dvm:domains>
        <!--1 or more repetitions:-->
        <dvm:domain name="?">
            <!--1 or more repetitions:-->
            <dvm:element name="?" qualifier="false"/>
        </dvm:domain>
    </dvm:domains>
    <!--Optional:-->
    <dvm:rows>
        <!--1 or more repetitions:-->
        <dvm:row>
            <!--2 or more repetitions:-->
            <dvm:cell?</dvm:cell>
            <dvm:cell?</dvm:cell>
        </dvm:row>
    </dvm:rows>
</dvm:dvm>
</soapenv:Body>

```

Element Name	Description
description	The DVM description. Optional
comments	Comments about the DVM. Optional
<i>elements</i>	<i>This element holds the DVM's element list.</i>
element	Represents a DVM element.
<i>domains</i>	<i>This elements holds the DVM's domain list.</i>
domain	This element represents a domain in a DVM.
element	This represents an element in the DVM domain.
<i>rows</i>	<i>This represents all the rows of data in the DVM.</i>
row	Each DVM row of values.
cell	This is the value for this row and the for each element in the same order as defined in elements.

EOTF_DVM_IMPORT.v1

Use this service operation to import a Domain Value Map definition and values into the Enterprise Transformation Framework, based on the FMW schema.

Type: Asynchronous-One Way.

Alias: import_dvm

Default: No

Request Message: EOTF_DVM.V1

This is an example of the soap body for an import request using FMW schema:

```
<soapenv:Body>
  <dvm:dvm name="?">
    <!--Optional:-->
    <dvm:description?</dvm:description>
    <dvm:columns>
      <!--2 or more repetitions:-->
      <dvm:column name=?" qualifier="false" order=?"/>
      <dvm:column name=?" qualifier="false" order=?"/>
    </dvm:columns>
    <!--Optional:-->
    <dvm:rows>
      <!--1 or more repetitions:-->
      <dvm:row>
        <!--2 or more repetitions:-->
        <dvm:cell?</dvm:cell>
        <dvm:cell?</dvm:cell>
      </dvm:row>
    </dvm:rows>
  </dvm:dvm>
</soapenv:Body>
```

Element Name	Description
description	The DVM description. Optional
columns	<i>This element holds the DVM's column list.</i>
column	Represents a DVM column.
rows	<i>This represents all the rows of data in the DVM.</i>
row	Each DVM row of values.
cell	This is the value for this row and the for each column in the same order as defined in columns.

EOTF_XREF Service

This section lists the service operations available for cross references:

- EOTF_XREF_ADD
- EOTF_XREF_LINK
- EOTF_XREF_UPDATE
- EOTF_XREF_DELETE
- EOTF_XREF_LOOKUP
- EOTF_XREF_IMPORT.v2
- EOTF_XREF_IMPORT.v1

EOTF_XREF_ADD

Use this service operation to add values to a cross-reference map.

Alias: add_xref_value

Type: Synchronous

Request Message: EOTF_XREF_ADD_REQ.V1

This is an example of the soap body for the request:

```
<soapenv:Body>
  <xref:xrefAddValue>
    <xref:mapname?></xref:mapname>
    <!--2 or more repetitions:-->
    <xref:Values>
      <xref:domain?></xref:domain>
      <!--1 or more repetitions:-->
      <xref:element name=""/>
    </xref:Values>
    <xref:Values>
      <xref:domain?></xref:domain>
      <!--1 or more repetitions:-->
      <xref:element name=""/>
    </xref:Values>
  </xref:xrefAddValue>
</soapenv:Body>
```

Element Name	Description
mapname	The name of the cross-reference map to add values to.
<i>Values</i>	<i>This element holds the cross-reference elements and values to be populated.</i>

<i>Element Name</i>	<i>Description</i>
domain	The name of the domain the elements are a part of.
element	This represents an element and its value.

Response Message: EOTF_XREF_RESPONSE.V1

<i>Element Name</i>	<i>Description</i>
status	The status of the operation. Returns <i>Success</i> or <i>Exception</i> .
reason	If there is an exception, the reason will be returned.
<i>responseValues</i>	<i>The values returned for the lookup operation.</i>
domain	The name of the target domain provided on the lookup request.
element	Represents an element in the target domain and its value.

EOTF_XREF_LINK

Use this service operation to link values to a cross-reference map.

Alias: link_xref_value

Type: Synchronous

Request Message: EOTF_XREF_LINK_REQ.V1

This is an example of the soap body for the request:

```
<soapenv:Body>
  <xref:xrefLinkValue>
    <xref:mapname?></xref:mapname>
    <xref:ReferenceValues>
      <xref:domain?></xref:domain>
      <!--1 or more repetitions:-->
      <xref:element name="?" />
    </xref:ReferenceValues>
    <!--1 or more repetitions:-->
    <xref:TargetValues>
      <xref:domain?></xref:domain>
      <!--1 or more repetitions:-->
      <xref:element name="?" />
    </xref:TargetValues>
  </xref:xrefLinkValue>
</soapenv:Body>
```

Element Name	Description
mapname	The name of the cross-reference map to add values to.
<i>ReferenceValues</i>	<i>This element holds the existing elements and values in a cross-reference to link target values with.</i>
domain	The name of the domain the reference elements are a part of.
element	This represents a cross-reference element and its value.
<i>targetValues</i>	This element holds the cross-reference elements and values to be added.
domain	The name of the domain the target elements are a part of.
element	This represents a cross-reference element and its value.

Response Message: EOTF_XREF_RESPONSE.V1

Element Name	Description
status	The status of the operation. Returns <i>Success</i> or <i>Exception</i> .
reason	If there is an exception, the reason will be returned.
<i>responseValues</i>	<i>The values returned for the lookup operation.</i>
domain	The name of the target domain provided on the lookup request.
element	Represents an element in the target domain and its value.

EOTF_XREF_UPDATE

Use this service operation to update values in a cross-reference map.

Alias: update_xref_value

Type: Synchronous

Request Message: EOTF_XREF_UPDATE_REQ.V1

This is an example of the soap body for the request:

```
<soapenv:Body>
  <xref:xrefUpdateValue>
    <xref:mapname>?</xref:mapname>
    <xref:ReferenceValues>
      <xref:domain>?</xref:domain>
      <!--1 or more repetitions:-->
      <xref:element name="?" />
    </xref:ReferenceValues>
    <!--1 or more repetitions:-->
    <xref:TargetValues>
      <xref:domain>?</xref:domain>
      <!--1 or more repetitions:-->
      <xref:element name="?" />
    </xref:TargetValues>
  </xref:xrefUpdateValue>
</soapenv:Body>
```

Element Name	Description
mapname	The name of the cross-reference map to update values to.
<i>ReferenceValues</i>	<i>This element holds the existing cross-reference elements and values to locate the row to be updated.</i>
domain	The name of the domain the reference elements are a part of.
element	This represents a cross-reference element and its value.
<i>targetValues</i>	<i>This element holds the cross-reference elements to be updated and the new values.</i>
domain	The name of the domain the target elements are a part of.
element	This represents a cross-reference element and its value.

Response Message: EOTF_XREF_RESPONSE.V1

Element Name	Description
status	The status of the operation. Returns <i>Success</i> or <i>Exception</i> .
reason	If there is an exception, the reason will be returned.
<i>responseValues</i>	<i>The values returned for the lookup operation.</i>

Element Name	Description
domain	The name of the target domain provided on the lookup request.
element	Represents an element in the target domain and its value.

EOTF_XREF_DELETE

Use this service operation to delete values from a cross-reference map.

Alias: delete_xref_value

Type: Synchronous

Request Message: EOTF_XREF_DELETE_REQ.V1

This is an example of the soap body for the request:

```
<soapenv:Body>
  <xref:xrefDeleteValue>
    <xref:mapname?></xref:mapname>
    <!--2 or more repetitions:-->
    <xref:Values>
      <xref:domain?></xref:domain>
      <!--1 or more repetitions:-->
      <xref:element name="?" />
    </xref:Values>
    <xref:Values>
      <xref:domain?></xref:domain>
      <!--1 or more repetitions:-->
      <xref:element name="?" />
    </xref:Values>
  </xref:xrefDeleteValue>
</soapenv:Body>
```

Element Name	Description
mapname	The name of the cross-reference map to delete values from.
<i>Values</i>	<i>This element holds the cross-reference elements and values to be deleted.</i>
domain	The name of the domain the elements are a part of.
element	This represents an element and its value.

Response Message: EOTF_XREF_RESPONSE.V1

Element Name	Description
status	The status of the operation. Returns <i>Success</i> or <i>Exception</i> .
reason	If there is an exception, the reason will be returned.
<i>responseValues</i>	<i>No response values are returned.</i>

EOTF_XREF_LOOKUP

Use this service operation to lookup values from a cross-reference map.

Alias: lookup_xref_value

Type: Synchronous

EOTF_XREF_LOOKUP_REQ.V1

This is an example of the soap body for the request:

```
<soapenv:Body>
  <xref:xrefLookupValue needFault="true">
    <xref:mapname?></xref:mapname>
    <xref:Values>
      <xref:domain?></xref:domain>
      <!--1 or more repetitions:-->
      <xref:element name="?"></xref:element>
    </xref:Values>
    <xref:targetDomain?></xref:targetDomain>
  </xref:xrefLookupValue>
</soapenv:Body>
```

Element Name	Description
mapname	The name of the cross-reference map to lookup values in.
<i>Values</i>	<i>This element holds the cross-reference elements and values to lookup.</i>
domain	The name of the domain the reference elements are a part of.
element	This represents a cross-reference element and its value.
targetDomain	The name of the domain the lookup request should return elements and values for.

Response Message: EOTF_XREF_RESPONSE.V1

Element Name	Description
status	The status of the operation. Returns <i>Success</i> or <i>Exception</i> .
reason	If there is an exception, the reason will be returned.
<i>responseValues</i>	<i>The values returned for the lookup operation.</i>
domain	The name of the target domain provided on the lookup request.
element	Represents an element in the target domain and its value.

EOTF_XREF_IMPORT.v2

Use this service operation to import a cross-reference map definition and values in using PeopleSoft schema.

Alias: xref

Type: Asynchronous - One Way

Default: Yes

Request Message: EOTF_XREF.V2

This is an example of the soap body for the request:

```
<soapenv:Body>
  <xref:xref>
    <xref:name?></xref:name>
    <!--Optional:-->
    <xref:description?></xref:description>
    <!--Optional:-->
    <xref:comments?></xref:comments>
    <xref:elements>
      <!--2 or more repetitions:-->
      <xref:element name="?" order="?" dataType="string" dataLength="?" isCom⇒
mon="false"/>
      <xref:element name="?" order="?" dataType="string" dataLength="?" isCom⇒
mon="false"/>
    </xref:elements>
    <xref:domains>
      <!--1 or more repetitions:-->
      <xref:domain name="?">
        <!--1 or more repetitions:-->
        <xref:element name="?"/>
      </xref:domain>
    </xref:domains>
    <!--Optional:-->
    <xref:rows>
      <!--1 or more repetitions:-->
```

```

<xref:row>
  <!--2 or more repetitions:-->
  <xref:cell>?</xref:cell>
  <xref:cell>?</xref:cell>
</xref:row>
</xref:rows>
</xref:xref>
</soapenv:Body>

```

Element Name	Description
description	The cross-reference description. Optional
comments	Comments about the cross-reference. Optional
elements	<i>This element holds the cross-reference element list.</i>
element	Represents a cross-reference element.
domains	<i>This elements holds the cross-reference domain list.</i>
domain	This element represents a domain in a cross-reference map.
element	This represents an element in the cross-reference domain.
rows	<i>This represents all the rows of data in the cross-reference map.</i>
row	Each cross-reference row of values.
cell	This is the value for this row and the for each element in the same order as defined in elements.

EOTF_XREF_IMPORT.v1

Use this service operation to import a cross-reference map definition and values in using PeopleSoft schema.

Alias: xref

Type: Asynchronous - One Way

Default: No

Transform: To v2

Request Message: EOTF_XREF.V1

This is an example of the soap body for the request:

```
<soapenv:Body>
  <xref:xref>
    <xref:table name="?">
      <!--Optional:-->
      <xref:description?</xref:description>
      <!--Optional:-->
      <xref:columns>
        <!--1 or more repetitions:-->
        <xref:column name="?"/>
      </xref:columns>
      <!--Optional:-->
      <xref:rows>
        <!--1 or more repetitions:-->
        <xref:row>
          <!--1 or more repetitions:-->
          <xref:cell colName="?"/>
        </xref:row>
      </xref:rows>
    </xref:table>
  </xref:xref>
</soapenv:Body>
```

Element Name	Description
<i>table</i>	<i>This element hold the table elements.</i>
description	The DVM description. Optional
<i>columns</i>	<i>This element holds the DVM's column list.</i>
column	Represents a DVM column.
<i>rows</i>	<i>This represents all the rows of data in the DVM.</i>
row	Each DVM row of values.
cell	This is the value for this row and the for each column in the same order as defined in columns.

Cross-Reference Lookup Web Service Example

The service operation EOTF_XREF_LOOKUP.v1 is used by external systems to look up a cross-reference value. For the external system to have access to the web service, it must be published on the PeopleSoft application.

See *PeopleTools: PeopleSoft Integration Broker, Providing Services*.

Example: Cross-Reference Map Definition

In this example, the third-party system requests a cross-reference lookup for payment terms. This page shows elements in the value map PaymentTermsGUID:

This example illustrates the fields and controls on the Domain value map used in example. You can find definitions for the fields and controls later on this page.

The screenshot shows a web interface for defining a domain value map. At the top, there are tabs for 'Elements' and 'Domains'. The 'Domains' tab is active. Below the tabs, the following information is displayed:

- Map Name:** PaymentTermGUID
- Type:** Cross-reference (dynamic)
- *Description:** Payment Terms Cross-Reference
- Comments:** (Empty text area)
- Delete:** (Button)

Below the form is a table titled 'Assign Elements to Maps'. The table has the following columns: Order, *Element Name, *Data Type, Length, Required, and two empty columns with '+' and '-' icons. The table contains three rows of data:

Order	*Element Name	*Data Type	Length	Required		
1	UniqueGUID	String	36	<input checked="" type="checkbox"/>	+	-
2	SETID	String	5	<input checked="" type="checkbox"/>	+	-
3	PYMNT_TERMS_CD	String	5	<input checked="" type="checkbox"/>	+	-

Three elements are defined: UniqueGUID, SETID, and PYMNT_TERMS_CD.

This page shows the domains that are defined for the domain value map:

This example illustrates the fields and controls on the Value Map - Domains page used in this example. You can find definitions for the fields and controls later on this page.

The screenshot shows the 'Value Map - Domains' configuration page. At the top, there are tabs for 'Elements' and 'Domains'. Below the tabs, the 'Map Name' is 'PaymentTermGUID' and the 'Type' is 'Cross-reference (dynamic)'. The page is divided into two main sections for domain configuration.

The first section is for the domain 'UniqueGUID'. It has a checkbox for 'Is Unique' which is checked. Below this is a table titled 'Assign Elements to the Domain' with one row containing the element 'UniqueGUID'.

The second section is for the domain 'PSFT'. It also has a checked 'Is Unique' checkbox. Below this is a table titled 'Assign Elements to the Domain' with two rows: '1 SETID' and '2 PYMNT_TERMS_CD'. Each row has a dropdown arrow and '+' and '-' buttons.

Two domains are defined for this map:

1. *UniqueGUID* is the domain used by the third party; it contains the UniqueGUID element.
2. *PSFT* represents the PeopleSoft application which contains the elements SETID and PYMNT_TERMS_CD.

Example: Web Service Request and Response

This is a sample request to obtain the PeopleSoft values for a common GUID value:

```
<soapenv:Envelope xmlns:soapenv="http://schemas.xmlsoap.org/soap/envelope/" xmlns:x=
ref="http://xmlns.oracle.com/Enterprise/tools/schema/xrefLookupValue.v1">
  <soapenv:Header/>
  <soapenv:Body>
    <xref:xrefLookupValue needFault="true">
      <xref:mapname>PaymentTermGUID</xref:mapname>
      <xref:Values>
        <xref:domain>UniqueGUID</xref:domain>
        <!--1 or more repetitions:-->
        <xref:element name="UniqueGUID">9d266732-90e2-11dd-a062-96c8921a7858</x=
ref:element>
      </xref:Values>
      <xref:targetDomain>PSFT</xref:targetDomain>
    </xref:xrefLookupValue>
  </soapenv:Body>
</soapenv:Envelope>
```

This is the response:

```
<soapenv:Envelope xmlns:soapenv="http://schemas.xmlsoap.org/soap/envelope/" xmlns:s=
oapenc="http://schemas.xmlsoap.org/soap/encoding/" xmlns:xsd="http://www.w3.org/200=
```

```
1/XMLSchema" xmlns:xsi="http://www.w3.org/2001/XMLSchema-instance">
  <soapenv:Body>
    <xrefResponse xmlns="http://xmlns.oracle.com/Enterprise/tools/schema/xrefResp→
onse.v1">
      <status>Success</status>
      <responseValues>
        <domain>PSFT</domain>
        <element name="SETID">SHARE</element>
        <element name="PYMNT_TERMS_CD">CD01</element>
      </responseValues>
    </xrefResponse>
  </soapenv:Body>
</soapenv:Envelope>
```

Application Integration Framework Example

Example Overview

This diagram represents the scenario for this application.

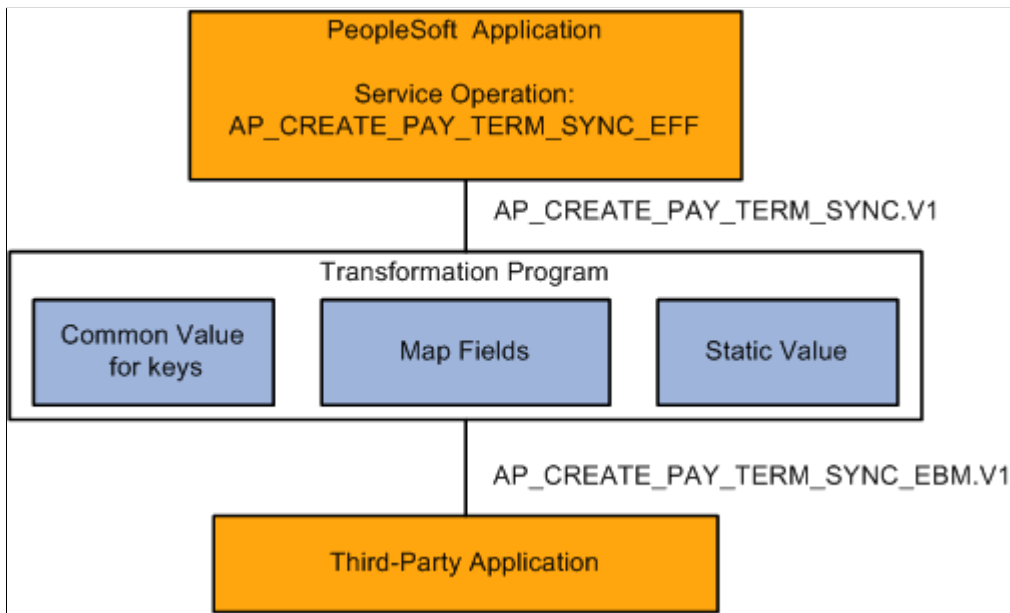

In this example, the PeopleSoft application updates the third-party application every time a new payment term is added. This transformation requires mapping the PeopleSoft ABM elements to the EBM elements, as well as mapping keys and static values. This example covers the following data translations within Application Integration Framework:

- The combination of the fields SETID and PYMNT_TERMS_CD is used as the key in the PeopleSoft application. This value needs to be assigned a common GUID for the EBM.
- The PeopleSoft application uses a 3-character code for language. The third-party system uses a numeric code.

This integration requires a transformation that:

- Maps the message structure.
- Creates a common value for the key fields.
- Translates the data values for static fields that differ.

Defining a Dynamic Value Map

To create a new dynamic value map:

1. Select **Enterprise Components > Integration Definitions > Transformation Framework > Define Value Maps.**
2. Select the Add a New Value page.
3. Enter *PaymentTermsGUID* for the map name.
4. Select *Cross-reference (Dynamic)* for the map type.
5. Click **Add.**

The map will contain the element UniqueGUID.

6. Add two additional elements SETID and PYMNT_TERMS_CD.

This example illustrates the fields and controls on the Domain value map used in example. You can find definitions for the fields and controls later on this page.

Elements Domains

Map Name: PaymentTermGUID **Type:** Cross-reference (dynamic)

***Description:** Payment Terms Cross-Reference

Comments:

Delete

Assign Elements to Maps						Customize	Find	First	1-3 of 3	Last
Order	*Element Name	*Data Type	Length	Required						
1	UniqueGUID	String	36	<input checked="" type="checkbox"/>	<input type="checkbox"/>	<input type="checkbox"/>				
2	SETID	String	5	<input checked="" type="checkbox"/>	<input type="checkbox"/>	<input type="checkbox"/>				
3	PYMNT_TERMS_CD	String	5	<input checked="" type="checkbox"/>	<input type="checkbox"/>	<input type="checkbox"/>				

Three elements are defined: UniqueGUID, SETID, and PYMNT_TERMS_CD.

To add the domains:

1. Select the Domains page.

The UniqueGUID domain appears.
2. Click the **Add a new row** icon to create another domain.
3. Enter *PSFT* for the domain name.
4. Select *SETID* for the first element.
5. Click the **Add a new row** icon to add another row.

6. Select *PYMNT_TERMS_CD* for the second element.
7. Save the page.

This example illustrates the fields and controls on the Value Map-Domains page used in this example. You can find definitions for the fields and controls later on this page.

The screenshot shows the 'Value Map-Domains' configuration page. At the top, there are tabs for 'Elements' and 'Domains'. The 'Map Name' is 'PaymentTermGUID' and the 'Type' is 'Cross-reference (dynamic)'. Below this, there are two domain configuration sections.

The first domain is 'UniqueGUID' with the 'Is Unique' checkbox checked. Below it is a table titled 'Assign Elements to the Domain' with one row: '1 UniqueGUID'.

The second domain is '*Domain Name: PSFT' with the 'Is Unique' checkbox checked. Below it is a table titled 'Assign Elements to the Domain' with two rows: '1 SETID' and '2 PYMNT_TERMS_CD'. Each row has a dropdown arrow and '+' and '-' buttons.

Two domains are defined for this map:

- *UniqueGUID* is the domain used by the third party; it contains the UniqueGUID element.
- *PSFT* represents the PeopleSoft application and contains the elements SETID and PYMNT_TERMS_CD.

Defining and Populating a Static Value Map

To create a new domain value map:

1. Select **Enterprise Components** > **Integration Definitions** > **Transformation Framework** > **Define Value Maps**.
2. Select the Add a New Value page.
3. Enter *LanguageCodeDVM* for the map name.
4. Select *Domain Value Map (static)* for the map type.
5. Click **Add**.

The map will contain the element UniqueGUID.

6. Add two additional elements, LANGUAGE_CD and COMMON.

This example illustrates the fields and controls on the Domain value map for language code. You can find definitions for the fields and controls later on this page.

Elements
Domains

Map Name: LanguageCodeDVM **Type:** Domain Value Map (static)

***Description:**

Comments:

Assign Elements to Maps
Customize | Find | First 1-3 of 3 Last

Order	*Element Name	*Data Type	Length	Required	
1	<input type="text" value="UniqueGUID"/>	String <input type="button" value="v"/>	36	<input checked="" type="checkbox"/>	<input type="button" value="+"/> <input type="button" value="-"/>
2	<input type="text" value="LANGUAGE_CD"/>	String <input type="button" value="v"/>	3	<input checked="" type="checkbox"/>	<input type="button" value="+"/> <input type="button" value="-"/>
3	<input type="text" value="COMMON"/>	String <input type="button" value="v"/>	32	<input checked="" type="checkbox"/>	<input type="button" value="+"/> <input type="button" value="-"/>

To add the domains:

1. Select the Domains page.
The UniqueGUID domain appears.
2. Click the **Add a new row** icon to create another domain.
3. Enter *PSFT* for the domain name.
4. Select *LANGUAGE_CD* for the first element.
5. Click the **Add a new row** icon in the header to add another domain.
6. Enter *AIA* for the domain name.
7. Select *COMMON* for the first element.
8. Save the page.

This example illustrates the fields and controls on the Domain value map domains for language code. You can find definitions for the fields and controls later on this page.

The screenshot displays the configuration for the 'LanguageCodeDVM' Domain Value Map (static). It is divided into three sections, each representing a domain:

- Domain 1: UniqueGUID**
 - Domain Name: UniqueGUID
 - Is Unique:
 - Assign Elements to the Domain table:

Element Name		
1 UniqueGUID		
- Domain 2: PSFT**
 - Domain Name: PSFT
 - Is Unique:
 - Assign Elements to the Domain table:

*Element Name		
1 LANGUAGE_CD		
- Domain 3: AIA**
 - Domain Name: AIA
 - Is Unique:
 - Assign Elements to the Domain table:

*Element Name		
1 COMMON		

Three domains are defined: AIA, PSFT and UniqueGUID.

To populate the DVM:

1. Select **Enterprise Components > Integration Definitions > Transformation Framework > Populate Domain Value Maps**.
2. Select *LanguageCodeDVM*.
3. In the LANGUAGE_CD column, enter a data value as defined in the PeopleSoft (PSFT) domain.
4. In the corresponding COMMON column, enter the value to be used for the AIA domain.
5. Add as many rows as necessary to map all of the static values.
6. Save the page.

This example illustrates the fields and controls on the Domain Value Map page. You can find definitions for the fields and controls later on this page.

Domain Value Map	
Map Name: LanguageCodeDVM	Description: Language Code DVM
Assign Data to Value Maps	
LANGUAGE_CD	COMMON
1 ENG	500

Using the XSLT Extension Function in the Transformation Program

Create a transformation program that maps the fields in the PeopleSoft ABM message to the corresponding fields in the EBM message. You will then use the XSLT functions to map the data values.

This section provides sample coding for sections of the transform application engine program for:

- Key value transformation
- Domain value transformation

Key Value Transformation

This example shows the elements in XML in the ABM that need to be translated, the code for the translation, and the resulting elements in the EBM.

Key Elements for Translation in PeopleSoft ABM

Elements in XML message:

```
<MsgData>
  <Transaction>
    <PYMT_TRMS_HDR class="R">
      <SETID IsChanged="Y">SHARE</SETID>
      <PYMNT_TERMS_CD IsChanged="Y">DIT91</PYMNT_TERMS_CD>
```

XSLT Code

This snippet of the XSLT code shows the transform XSLT in the application engine program:

1. Create a new variable by concatenating SETID and PYMT_TERMS_CD:

```
<corecom:ApplicationObjectKey>
  <corecom:ID>
    <xsl:attribute name="schemeID">
      <xsl:text disable-output-escaping="no">PSFT</xsl:text>
    </xsl:attribute>
    <xsl:attribute name="schemeAgencyID">
      <xsl:text disable-output-escaping="no">PSFT_COMMON</xsl:text>
    </xsl:attribute>
    <xsl:variable name="NamedValuePair"select='concat("&lt;SETID&gt;"; PYMT_T=>
RMS_HDR/SETID, "&lt;/SETID&gt;&lt;&lt;PYMNT_TERMS_CD&gt;"; PYMT_TRMS_HDR/PYMNT_TERMS=>
```

```
_CD,"&lt;/PYMNT_TERMS_CD&gt;")' />
```

2. Use the generate-guid utility to generate a unique GUID:

```
<xsl:variable name="CommonGuid" select='concat("&lt;UniqueGUID&gt;","util=&gt;
ity:generate-guid(),"&lt;/UniqueGUID&gt;")' />
```

Note: This step is not necessary. If the GUID does not exist, the appropriate xref:populate function automatically generates the unique GUID.

3. Use the xref:populateValueNVP function to add the new GUID to the cross-reference:

```
<xsl:variable name="GUIDAdd" select='xref:populateValueNVP("PaymentTermGUID","&gt;
PSFT",$NamedValuePair,"UniqueGUID",$CommonGuid,"ADD")' />
<xsl:call-template name="Process-GUID">
  <xsl:with-param name="returnValue">
    <xsl:value-of select="$GUIDAdd"/>
  </xsl:with-param>
  <xsl:with-param name="statusDelimiter"></xsl:with-param>
</xsl:call-template>
</corecom:ID>
```

4. Insert the values in the EBM message:

```
<corecom:ContextID>
<xsl:attribute name="schemeID">
  <xsl:text disable-output-escaping="no">SETID</xsl:text>
</xsl:attribute>
<xsl:attribute name="schemeAgencyID">
  <xsl:text disable-output-escaping="no">PSFT</xsl:text>
</xsl:attribute>
<xsl:value-of select="PYMT_TRMS_HDR/SETID"/>
</corecom:ContextID>
<corecom:ContextID>
  <xsl:attribute name="schemeID">
    <xsl:text disable-output-escaping="no">Payment Terms Code</xsl:text>
  </xsl:attribute>
  <xsl:attribute name="schemeAgencyID">
    <xsl:text disable-output-escaping="no">PSFT</xsl:text>
  </xsl:attribute>
  <xsl:value-of select="PYMT_TRMS_HDR/PYMNT_TERMS_CD"/>
</corecom:ContextID>
```

Transformed Elements in EBM Message

The transformed EBM message contains the common GUID value:

```
<corecom:ApplicationObjectKey>
  <corecom:ID schemeAgencyID="PSFT_COMMON" schemeID="PSFT">b15f3c34-72bc-11d&gt;
d-b7dd-aaf7c4308a71</corecom:ID>
  <corecom:ContextID schemeAgencyID="PSFT" schemeID="SETID">SHARE</corecom:&gt;
ContextID>
  <corecom:ContextID schemeAgencyID="PSFT" schemeID="Payment Terms Code">DI&gt;
T91</corecom:ContextID>
```

Domain Value Transformation

This example shows the domain value elements in XML in the ABM that need to be translated, the code for the translation, and the resulting elements in the EBM.

Domain Value Elements for Translation in PeopleSoft ABM

Here is the element for language in PeopleSoft ABM message:

```
<<PSCAMA class="R">
  <LANGUAGE_CD>ENG</LANGUAGE_CD>
```

XSLT Code

This snippet of the XSLT code shows the dvm lookup in the transform application engine program:

```
<xsl:variable name="MsgLang" select='dvm:lookup-dvm ("LanguageCodeDVM", "LANGUAGE_CD⇒
", //MsgData/Transaction/PSCAMA/LANGUAGE_CD, "COMMON", //MsgData/Transaction/PSCAMA/LA⇒
NGUAGE_CD, false())' />
<xsl:variable name="BaseLang" select='dvm:lookup-dvm("LanguageCodeDVM", "LANGUAGE_CD⇒
", //MsgData/Transaction/PSCAMA/BASE_LANGUAGE_CD, "COMMON", //MsgData/Transaction/PSCA⇒
MA/BASE_LANGUAGE_CD, false())' />
<xsl:attribute name="languageCode">
  <xsl:value-of select="substring-after($MsgLang, ';' )" />
</xsl:attribute>
```

Transformed Elements in EBM Message

Here is the translated elements in the resulting EBM message:

```
<?xml version="1.0"?>
<paytermcreate:CreatePaymentTermEBM languageCode="500" xmlns:corepaymenttermcust="h⇒
ttp://xmlns.oracle.com/EnterpriseObjects/Core/Custom/EBO/PaymentTerm/V1" xmlns:payt⇒
ermcreate="http://xmlns.oracle.com/EnterpriseObjects/Core/EBO/CreatePaymentTermEBM/⇒
V1">
  <corecom:EBMHeader languageCode="500" xmlns:corecom="http://xmlns.oracle.com/Ente⇒
priseObjects/Core/Common/V2">
    <corecom:Sender>
      <corecom:ID>E900B20</corecom:ID>
    </corecom:Sender>
  </corecom:EBMHeader>
```

Updating the Service Operation Routing

To update the service operations routing:

1. Select **PeopleTools > Integration Broker > Integration Setup > Service Operations**.
2. Select the service operation that you need to update.
3. Select the Routing page.

4. Either enter a new routing or click the link for an existing routing.
5. If it is a new routing, enter the routing information.
6. Access the Parameters page.

Field or Control	Description
Message.Ver into Transform 1	This is the PeopleSoft ABM message.
Transform Program 1	This is the transformation program created for this integration.
Message.Ver out of Transforms	This is the EBM message that will be sent to the third party.

7. Save the routing.

This example illustrates the fields and controls on the Service Operations Routing - Parameters page. You can find definitions for the fields and controls later on this page.

Routing Definitions
Parameters
Routing Properties

Routing Name: SCM_CONTACT1_TO_CONTACT_RB1

Service Operation: CONTACT_SYNC_EFF

Service Operation Version: VERSION_RB_1

Sender Node: PSFT_EP

Receiver Node: CR910TS1

Parameters

Type: Inbound Request

External Alias:

[Alias References](#)

Message.Ver into Transform 1:

Transform Program 1:

Transform Program 2:

Message.Ver out of Transforms:

Save
Return

