PeopleSoft FSCM 9.2: PeopleSoft Asset Management

July 2024

This software and related documentation are provided under a license agreement containing restrictions on use and disclosure and are protected by intellectual property laws. Except as expressly permitted in your license agreement or allowed by law, you may not use, copy, reproduce, translate, broadcast, modify, license, transmit, distribute, exhibit, perform, publish, or display any part, in any form, or by any means. Reverse engineering, disassembly, or decompilation of this software, unless required by law for interoperability, is prohibited.

The information contained herein is subject to change without notice and is not warranted to be error-free. If you find any errors, please report them to us in writing.

If this is software, software documentation, data (as defined in the Federal Acquisition Regulation), or related documentation that is delivered to the U.S. Government or anyone licensing it on behalf of the U.S. Government, then the following notice is applicable:

U.S. GOVERNMENT END USERS: Oracle programs (including any operating system, integrated software, any programs embedded, installed, or activated on delivered hardware, and modifications of such programs) and Oracle computer documentation or other Oracle data delivered to or accessed by U.S. Government end users are "commercial computer software," "commercial computer software documentation," or "limited rights data" pursuant to the applicable Federal Acquisition Regulation and agency-specific supplemental regulations. As such, the use, reproduction, duplication, release, display, disclosure, modification, preparation of derivative works, and/or adaptation of i) Oracle programs (including any operating system, integrated software, any programs embedded, installed, or activated on delivered hardware, and modifications of such programs), ii) Oracle computer documentation and/or iii) other Oracle data, is subject to the rights and limitations specified in the license contained in the applicable contract. The terms governing the U.S. Government's use of Oracle cloud services are defined by the applicable contract for such services. No other rights are granted to the U.S. Government.

This software or hardware is developed for general use in a variety of information management applications. It is not developed or intended for use in any inherently dangerous applications, including applications that may create a risk of personal injury. If you use this software or hardware in dangerous applications, then you shall be responsible to take all appropriate fail-safe, backup, redundancy, and other measures to ensure its safe use. Oracle Corporation and its affiliates disclaim any liability for any damages caused by use of this software or hardware in dangerous applications.

Oracle®, Java, MySQL, and NetSuite are registered trademarks of Oracle and/or its affiliates. Other names may be trademarks of their respective owners.

Intel and Intel Inside are trademarks or registered trademarks of Intel Corporation. All SPARC trademarks are used under license and are trademarks or registered trademarks of SPARC International, Inc. AMD, Epyc, and the AMD logo are trademarks or registered trademarks of Advanced Micro Devices. UNIX is a registered trademark of The Open Group.

This software or hardware and documentation may provide access to or information about content, products, and services from third parties. Oracle Corporation and its affiliates are not responsible for and expressly disclaim all warranties of any kind with respect to third-party content, products, and services unless otherwise set forth in an applicable agreement between you and Oracle. Oracle Corporation and its affiliates will not be responsible for any loss, costs, or damages incurred due to your access to or use of third-party content, products, or services, except as set forth in an applicable agreement between you and Oracle.

Documentation Accessibility

For information about Oracle's commitment to accessibility, visit the Oracle Accessibility Program website at <https://docs.oracle.com/pls/topic/lookup?ctx=acc&id=docacc>.

Access to Oracle Support

Oracle customers that have purchased support have access to electronic support through My Oracle Support. For information, visit <https://docs.oracle.com/pls/topic/lookup?ctx=acc&id=info> or visit <https://docs.oracle.com/pls/topic/lookup?ctx=acc&id=trs> if you are hearing impaired.

Contents

- Preface: Preface.....xix**
 - Understanding the PeopleSoft Online Help and PeopleBooks..... xix
 - Hosted PeopleSoft Online Help..... xix
 - Locally Installed PeopleSoft Online Help..... xix
 - Downloadable PeopleBook PDF Files.....xix
 - Common Help Documentation.....xix
 - Field and Control Definitions..... xx
 - Typographical Conventions..... xx
 - ISO Country and Currency Codes.....xxi
 - Region and Industry Identifiers..... xxi
 - Translations and Embedded Help.....xxii
 - Using and Managing the PeopleSoft Online Help.....xxii
 - PeopleSoft FSCM Related Links..... xxii
 - Contact Us.....xxii
 - Follow Us.....xxiii
- Chapter 1: Common Elements in Asset Management.....25**
 - Common Elements Used in Asset Management..... 25
- Chapter 2: Getting Started With PeopleSoft Asset Management..... 29**
 - PeopleSoft Asset Management Overview..... 29
 - PeopleSoft Asset Management Business Processes..... 30
 - PeopleSoft Asset Management Integration Touchpoints..... 30
 - Enabling ChartField Security for PeopleSoft Asset Management..... 32
 - Implementing PeopleSoft Asset Management..... 33
- Chapter 3: Navigating in PeopleSoft Asset Management.....41**
 - Using Custom Navigation Center Pages in PeopleSoft Asset Management..... 41
 - Pages Used to Navigate in PeopleSoft Asset Management..... 41
 - Using the Fluid User Interface to Access Frequently Used Asset Management Pages..... 52
 - Page Used to Access Frequently Used Asset Management Pages..... 52
 - Asset Management Tile..... 52
 - Asset Management Page..... 53
- Chapter 4: Implementing Asset Management..... 57**
 - Understanding Asset Management..... 57
 - Understanding the Asset Management Implementation Process..... 57
- Chapter 5: Converting to PeopleSoft Asset Management..... 61**
 - Understanding Conversion to PeopleSoft Asset Management..... 61
 - Prerequisites..... 62
 - Converting with a Customized SQR..... 62
 - Running the Transaction Loader Edit Program..... 64
 - Pages Used to Run the Transaction Loader Edit Program..... 64
 - Edit Page..... 64
 - Viewing the Results of the Transaction Edit Program..... 65
 - Previewing and Approving Results..... 66
 - Populating Asset Management Tables with Asset Data..... 66
 - Using Transaction Loader Conversion Dates Options..... 66
 - Depreciating Converted Assets..... 67
 - Closing the Conversion Process..... 68

Page Used to Close the Conversion Process.....	68
Verifying the Conversion.....	68
Receive Conversion Data Page.....	68
Updating Security.....	69
Loading Retired Assets.....	69
Considerations for Retiring Assets.....	70
Populating Loader Tables.....	70
Reviewing Retired Asset Data.....	71
Converting Lease Information.....	72
Pages Used to Convert Lease Information.....	73
Load Preview - Lease Page.....	74
Load Approval - Lease Page.....	74
Chapter 6: Adding and Maintaining Assets.....	75
Understanding Adding and Maintaining Assets.....	75
Adding Assets.....	75
Capitalization Thresholds.....	76
Document Sequencing.....	76
Financials Audit Framework (Audit Logging).....	77
Component Changeout.....	77
Meters and Warranties.....	77
Setting Up and Managing Capitalization Thresholds.....	78
Pages Used to Set Up and Manage Capitalization Thresholds.....	78
Understanding Capitalization Thresholds.....	78
Understanding Capitalization Threshold Validation.....	81
Capitalization Limits Page.....	81
Capitalization Thresholds Page.....	82
Capitalization Threshold Validation Page.....	85
Capitalization Threshold Summary Report Page.....	87
Adding and Maintaining Asset Information.....	88
Pages Used to Add or Change Asset Information.....	88
General Information Page.....	91
Cost History Page.....	104
Operation/Maintenance Page.....	105
Asset Acquisition Detail Page.....	112
Asset Acquisition Detail Page – Entering Multiple Cost Adjustments.....	118
Tax Page.....	121
Doc Sequencing Page.....	122
Location/Comments/Attributes Page.....	123
Manufacture/License/Custodian Page.....	125
Asset Property Page.....	128
Record Property Taxes Page.....	131
Asset Supplemental Data Page.....	132
IoT (Internet of Things) Page.....	133
External Funding Source Page.....	134
Maintaining Asset Meters.....	135
Pages Used to Maintain Asset Meters.....	135
Understanding Asset Meters.....	136
Asset Meters Page.....	136
Entering Meter Readings Page.....	138
Meter Readings History Page.....	140
Maintaining Warranties.....	142

Pages Used to Maintain Asset Warranties.....	142
Understanding Asset Warranties.....	142
Maintaining Asset Book Information.....	142
Pages Used to Maintain Asset Book Information.....	143
Book - Depreciation Page.....	143
Depreciation Method Information Page.....	151
Book - Tax Page.....	153
Adding Assets with the Asset ExpressAdd Component.....	157
Pages Used to Add Assets with the Asset ExpressAdd Component.....	158
Cost/Asset Information Page.....	158
Depreciation Information Page.....	166
Importing Asset Transaction Data by Spreadsheet.....	167
Pages Used to Import Asset Transaction Data by Spreadsheet.....	167
Understanding the Import Data by Spreadsheet Process.....	167
Steps to Import Asset Transaction Data into Asset Management Using the Import Data by Spreadsheet Process.....	179
Define Spreadsheet Template Page.....	180
Upload Spreadsheet Data Page.....	184
Financial Transaction Page.....	187
Physical Transaction Page.....	188
Adding Assets with the Excel to Component Interface Utility.....	190
Pages Used to Add Assets with the Excel to Component Interface Utility.....	190
Understanding How to Import Asset Information with the Excel to Component Interface Utility.....	191
Import Data Via Spreadsheet Page.....	191
Previewing the Data to Be Imported Through a Spreadsheet.....	193
Copying an Asset.....	193
Page Used to Copy an Asset.....	194
Create Asset Copies Page.....	194
Viewing and Managing the Component Asset Hierarchy.....	196
Pages Used to View and Manage the Asset Component Hierarchy.....	196
Understanding Component Asset Hierarchies.....	196
Asset Component Hierarchy Page.....	197
Asset Component Hierarchy Page.....	198
Creating Parent-Child Asset Relationships.....	202
Pages Used to Create Parent-Child Asset Relationships.....	202
Understanding Parent-Child Asset Relationships.....	203
Asset Parent Page.....	203
Create Parent - Child Assets Page.....	204
Adding Parent and Child Component Assets.....	204
Using the Child Inherits Life of Parent Feature.....	204
Updating Parent-Child Basic Information.....	205
Child Assets Page.....	206
Review Parent-Child Page.....	207
Calculating Asset Replacement Costs.....	208
Page Used to Calculate Replacement Cost.....	208
Understanding Asset Replacement Cost.....	208
Defining Asset Operational Information.....	209
Pages Used to Add and Maintain Asset Operational Information.....	209
Define Asset Operational Information - Asset Information Page.....	210
Define Asset Operational Information - Customize Page Layout Page.....	214

Searching for Asset Information.....	214
Page Used to Search for Asset Information.....	214
Search for an Asset Page.....	215
Printing Asset Information.....	219
Page Used to Print Asset Information.....	219
Working with Related Content in Asset Management.....	219
Pages Used to Work with Asset Management Related Content.....	220
Understanding Related Content.....	220
Define Related Content Service Page.....	221
Manage Related Content for Content References Page.....	221
Configure Layout Page.....	222
Verifying Data in the Loader Tables.....	223
Pages Used to Verify Data in the Loader Tables.....	223
Review Page.....	223
Approving Changes.....	227
Pages Used to Approve Changes.....	227
Approve Page.....	228
Exporting PeopleSoft Assets into Oracle Internet of Things Asset Monitoring Cloud Service.....	229
Page Used to Export PeopleSoft Assets into Oracle Internet of Things Asset Monitoring Cloud Service.....	229
Upload Assets to IoT (Oracle Internet of Things) Page.....	229
Errored Asset Details Page.....	232
Chapter 7: Using Asset Management WorkCenter and Dashboard.....	235
Understanding the Asset Management WorkCenter and Dashboard.....	235
Asset Management WorkCenter.....	235
Using the Asset Management WorkCenter - My Work Pagelet.....	237
Pending Transactions.....	238
AP/PO Transactions Page.....	239
Business Unit AP/PO Transactions Page.....	240
Load Transactions into AM.....	244
Business Unit Transaction Loader Page.....	245
Exceptions.....	247
Pre-Interface Lines in Error.....	248
Interface Lines in Error.....	249
Pending Depreciation Calculation.....	249
Depreciation Process Log.....	251
Pending Depreciation Report.....	251
Pending Accounting Entry Creation.....	253
Pending Journal Generator Page.....	254
Using the Asset Management WorkCenter - Links Pagelet.....	257
Using the Asset Management WorkCenter – Queries Pagelet.....	259
Queries.....	259
Pivot Grids.....	260
Using the Asset Management WorkCenter - Reports and Processes Pagelet.....	261
Using the Asset Management WorkCenter - Dashboard.....	262
WorkCenter Dashboard and Pivot Grids.....	263
Chapter 8: Using the PeopleSoft Fluid Asset Management WorkCenter.....	265
Understanding the PeopleSoft Fluid Asset Management WorkCenter.....	265
Setting Up and Personalizing the PeopleSoft Fluid Asset Management WorkCenter.....	265
Using the PeopleSoft Fluid Asset Management WorkCenter.....	266
Pages Used with the PeopleSoft Fluid Asset Management WorkCenter.....	266

Asset Management WorkCenter Tile.....	266
Asset Management WorkCenter page.....	266
Using the Fluid Asset Management WorkCenter – My Work.....	270
Pending AP/PO Transactions By.....	270
Pending Processes.....	271
Exceptions.....	277
Using the Fluid Asset Management WorkCenter – Links Pagelet.....	281
Using the Fluid Asset Management WorkCenter – Queries Pagelet.....	282
Queries.....	282
Pivot Grids.....	283
Using the Fluid Asset Management WorkCenter – Reports and Processes Pagelet.....	284
Chapter 9: Working with Asset Budgeting.....	285
Understanding Asset Budgeting.....	285
Understanding Capital Acquisition Planning.....	285
Defining New Capital Acquisition Plans.....	286
Pages Used to Define New Capital Acquisition Plans.....	286
Capital Acquisition Planning - Details Page.....	286
Adjusting Capital Acquisition Plans.....	289
Linking Assets to Existing Capital Acquisition Plans.....	289
Viewing Capital Acquisition Plans.....	289
Pages Used to View Capital Acquisition Plans.....	290
Running Capital Acquisition Plan Reports.....	290
Page Used to Run Capital Acquisition Plan Reports.....	291
Chapter 10: Working With Leased Assets.....	293
Understanding Leased Assets.....	293
Pre-Migration Leased Asset Functionality.....	293
Post-Migration Leased Asset Functionality.....	295
Defining Payment Schedules.....	298
Page Used to Define Payment Schedules.....	298
Payment Schedules Page.....	298
Adding Capital and Operating Leases.....	300
Pages Used to Add Capital and Operating Leases.....	300
Express Add – Definition and Update Lease Information – Definition Pages.....	301
Express Add – Cost Page.....	313
Express Add – Step Lease Payment and Update Lease Information – Step Lease Payment Pages.....	314
Express Add – Payment Schedule and Update Lease Information – Payment Schedule Pages.....	315
Creating Lease Expense Schedules.....	317
Page Used to Run the Lease Expense Schedule Process.....	318
Create Expense Schedule Page.....	318
Integrating Lease Payments with PeopleSoft Payables.....	319
Page Used to Integrate Asset Management Lease Payments with PeopleSoft Payables.....	319
Asset Management Definition - Interface Options Page.....	320
Setting Up Clearing Accounts.....	321
Payables Integration Page.....	322
Review Payments Page.....	324
Approve Payments Page.....	326
Lease Payments to Payables Page.....	327
AP/AM Payment Reconciliation Page.....	328
Transferring Operating Leases.....	329

Page Used to Transfer Operating Leases.....	329
Operating Lease Chartfields Page.....	330
Retiring or Reinstating Leases.....	330
Generating Lease Reports.....	331
Pages Used to Generate Lease Reports.....	331
Chapter 11: Adjusting, Transferring, Reversing, and Evaluating Assets.....	333
Understanding Adjusting, Transferring, Reversing, and Evaluating Assets.....	333
Adjusting Cost and Transferring Assets.....	334
Pages Used to Adjust Cost and Transfer Assets.....	334
Understanding Cost Adjustments and Asset Transfers.....	335
Understanding Federal Funds Transfers.....	336
Main Transaction Page.....	337
Cost Information Page.....	341
Asset Cost IU Book Transfer page.....	349
InterUnit Proceeds page.....	352
Child Assets Page.....	353
Child Asset TRF/RCT Overrides Page.....	354
Parent Asset Advanced Transaction Details Page.....	355
Update Asset Profile Page.....	356
Transferring Parent-Child Assets to Other Business Units (Interunit Transfers) In Mass.....	356
Page Used to Transfer Parent-Child Assets to Other Business Units In Mass.....	357
Parent-Child IU Transfer Page.....	357
Revaluing Assets Using the Revaluation Worksheet.....	358
Page Used to Revalue Assets Using the Revaluation Worksheet.....	359
Revaluation Worksheet Page.....	359
Revaluing Assets En Masse.....	369
Page Used to Revalue Assets En Masse.....	370
Revaluation en Masse Page.....	370
Capturing and Maintaining Asset Fair Value.....	371
Page Used to Capture and Maintain Asset FV.....	372
Fair Value Page.....	372
Updating Non capitalized Costs.....	373
Page Used to Update Non capitalized Costs.....	374
Viewing Cost History and Summarizing Cost Rows.....	374
Pages Used to View Cost History and Summarize Cost Rows.....	374
Understanding Cost History.....	374
Understanding Cost Summarization.....	375
Cost History List Page.....	376
Cost Summarization Page.....	377
Updating the General Ledger with Adjustments and Transfers.....	378
Modifying or Deleting Pending Asset Transactions.....	378
Pages Used to Modify or Delete Pending Asset Transactions.....	379
Pending Trans Update/Delete Page.....	379
Asset Addition Page.....	379
Transaction Information Page.....	381
Adjusting for Asset Impairment.....	381
Pages Used to Make Impairment Adjustments.....	381
Understanding Impairment Testing.....	382
Impairment Worksheet Page.....	383
CGU Impairment Page.....	390
View and Report Impairment Losses and Reversals.....	395

Reversing Asset Transactions.....	397
Pages Used to Reverse Asset Transactions.....	397
Understanding Transaction Reversals.....	397
Reversal Reason Codes Page.....	399
Transaction Reversal Page.....	399
Review Reversal Transaction Page.....	402
Chapter 12: Approving Assets Using the PeopleSoft Fluid User Interface.....	405
Approving Assets Using the PeopleSoft Fluid User Interface.....	405
Pages Used to Approve Asset Transactions in the PeopleSoft Fluid User Interface.....	405
Understanding Asset Approvals Using the Fluid User Interface.....	407
Understanding Fluid Approval Set Up.....	409
Common Elements Used in This Topic.....	412
Pending Approvals - Asset Adjustment Page.....	412
Asset Adjustment - Approval Header Detail Page.....	413
Pending Approvals - Asset Inter Unit Transfer Page.....	415
Asset Inter Unit Transfer - Approval Header Detail Page.....	416
Pending Approvals - Asset Transfer Page.....	417
Asset Transfer - Approval Header Detail Page.....	418
Pending Approvals - Asset Physical Transfer page.....	419
Asset Physical Transfer - Header Detail page.....	420
Pending Approvals - Asset Retire Page.....	421
Asset Retire - Header Detail page.....	421
Pending Approvals - Asset Disposal Page.....	422
Asset Disposal - Approval Header Detail Page.....	423
Pending Approvals - Asset Self Service Page.....	425
Asset Self Service - Approval Header Details Page.....	425
Pending Approvals - Asset Addition Reversal Page.....	426
Asset Addition Reversal - Approval Header Detail Page.....	427
Pending Approvals - Asset Adjustment Reversal Page.....	428
Asset Adjustment Reversal - Approval Header Detail Page.....	429
Pending Approvals - Asset InterUnit Reversal Page.....	430
Asset InterUnit Reversal - Approval Header Detail Page.....	431
Pending Approvals - Asset Transfer Reversal Page.....	432
Asset Transfer Reversal - Approval Header Detail Page.....	433
Pending Approvals - Asset Mass Transaction Page.....	434
Asset Mass Transaction - Approval Header Detail Page.....	435
Pending Approvals - Asset Upload Spreadsheet Data.....	436
Asset Upload Spreadsheet Data - Approval Header Detail Page.....	437
Chapter 13: Managing Asset Maintenance, Repair, Warranties, and Insurance.....	439
Understanding Asset Maintenance, Repair, Warranties, and Insurance.....	439
Checking Out Assets.....	440
Page Used to Check Out Assets.....	441
Asset Checkout Page.....	441
Entering Asset Inspection Information.....	442
Page Used to Enter Asset Inspection Information.....	442
Entering Asset Maintenance Service and Repairs.....	443
Pages Used to Enter Asset Service and Repair.....	443
Asset Service/Repair - Event Page.....	444
Track Service and Repairs - Statistics Page.....	446
Track Service and Repairs - Payment Page.....	447
Tracking Asset Maintenance Contracts.....	448

Pages Used to Track Asset Maintenance Contracts.....	448
Understanding Asset Maintenance Contracts.....	448
Maintenance Contracts - Detail Page.....	448
Maintenance Contracts - Coverage Page.....	449
Entering Warranty Information.....	449
Pages Used to Enter Warranty Information.....	449
Prerequisites.....	449
Asset Warranty Page.....	449
Search for Asset Warranty Templates Page.....	451
Entering Asset Insurance Information.....	451
Page Used to Set Up Asset Insurance Information.....	452
Prerequisites.....	452
Asset Insurance Page.....	452
Generating the Asset Warranties Report.....	455
Page Used to Generate the Asset Warranty Report.....	455
Reviewing Asset Maintenance History.....	456
Page Used to View Asset Maintenance History Summaries.....	456
Chapter 14: Using Group Asset Processing.....	457
Understanding Group Asset Processing.....	457
Asset Transactions.....	457
Depreciated Group Assets.....	457
Retired Group Members.....	458
Strategy for Asset Grouping.....	458
Prerequisites.....	459
Adding Group Member Assets.....	460
Adding Group Member Assets with Background Processing.....	460
Adding Group Member Assets Online.....	461
Adding Group Asset IDs with Background Processing.....	461
Performing Transactions on Group Member Assets.....	463
Transferring Group Members Among Group Assets.....	464
Consolidating Group Member Assets.....	464
Pages Used to Consolidate Group Member Assets.....	464
Understanding Consolidation of Group Member Assets.....	465
Consolidate Page.....	465
Calculating Depreciation for Group Assets.....	471
Page Used to Calculate Depreciation for Group Assets.....	471
Group Asset Depreciation Page.....	471
Running the Group Member Estimated Net Book Value Report.....	472
Page Used to Run the Group Member Estimated Net Book Value Report.....	472
Understanding the Estimated Net Book Value Calculation.....	472
Group Member Estimated NBV Page.....	472
Changing Rates Retroactively.....	473
Pages Used to Change Rates Retroactively.....	474
Processing Retroactive Rate Changes.....	474
Reviewing Asset Book History.....	474
Pages Used to Review Asset Book History.....	475
Chapter 15: Using Composite Asset Processing.....	477
Understanding Composite Asset Processing.....	477
Adding a Composite Asset.....	478
Adding Composite Member Assets.....	478
Capitalizing Composite Members into Composite Assets.....	479

Retiring Composite Members from Composite Assets.....	479
Loading Composite Asset Transactions.....	479
Understanding the Effect of Capitalization into Composite.....	479
Understanding the Effect of Retirement from Composite.....	480
Performing Transactions on Composite Assets.....	480
Adjustments to Cost/Quantity.....	480
Recategorizations and Transfers.....	481
Chapter 16: Performing Asset Physical Inventory.....	483
Understanding Physical Inventories.....	483
Physical Inventory Terminology.....	483
Mobile Physical Inventory and Classic Physical Inventory.....	484
Mobile Physical Inventory.....	485
Hardware and Software Requirements for Mobile Physical Inventory.....	488
Classic Physical Inventory.....	488
Hardware and Software Requirements for Classic Physical Inventory.....	489
Configuring Physical Inventory.....	491
Pages Used to Configure Physical Inventory.....	492
Physical Inventory Control Page.....	492
Mass Transaction Definition - Mass Transactions List Page.....	493
Mass Transaction Definition – Transaction Definition Page.....	494
Mass Transaction Configuration Page.....	495
Mass Transaction Criteria Page.....	496
Defining the Extract Scope, the Scan Scope, and the Physical Inventory Parameters.....	497
Pages Used to Define Extract Scopes, Scan Scopes, and Physical Inventory Parameters.....	498
Understanding Extract Scopes and Scan Scopes for Classic Physical Inventory.....	498
Understanding Scan Scopes for Mobile Physical Inventory.....	499
Define Inventory Occurrence - Definition Page.....	499
Define Inventory Occurrence – Enter Criteria Page.....	502
Define Inventory Occurrence - Transaction Defaults Page.....	503
Create Schedules Page.....	506
Processing a Physical Inventory.....	507
Pages Used to Process Physical Inventory.....	507
Understanding Mobile Physical Inventory Processing.....	508
Understanding Classic Physical Inventory Processing.....	509
Load/Match/Reconcile PI Info Page (Mobile Physical Inventory).....	510
Physical Inventory Page.....	515
Edit Scan Record Page.....	517
New Asset Scan Record Page.....	519
Find Asset Page.....	520
Load/Match/Reconcile PI Info Page (Classic Physical Inventory).....	521
Review Extracted Data Page (Classic Physical Inventory Only).....	529
Verify Duplicate Tags Page.....	530
Verify Duplicate Serial ID Page.....	531
Verify Scanned Data Page.....	532
Results Page.....	533
Viewing Physical Inventory History and Reports.....	536
Pages Used to View Physical Inventory History.....	536
Review Inventory History Page.....	537
Run Physical Inventory Reports Page.....	537
Tracking Assets with the Asset Tracking Homepage.....	538
Pages Used to Track Assets.....	541

Scan Options Page.....	541
Field Display Setup Page.....	545
Scan Asset Page.....	547
Scan By Location Page.....	550
Find Asset Page.....	554
Scan Scope List Pivot Grid.....	555
Scan Duplicate Tag Pivot Grid.....	556
Scan Results Pivot Grid.....	557
Scan History Pivot Grid.....	557
Asset Transactions Page.....	558
Chapter 17: Working with Joint Venture Asset Processing.....	561
Understanding Joint Venture Processing.....	561
Prerequisites for Joint Venture Processing.....	563
Adding and Maintaining Joint Venture Assets.....	563
Changing Ownership Allocations for Existing Joint Ventures.....	564
Defining a Mass Transaction for Joint Venture Processing.....	564
Loading Joint Venture Transactions.....	566
Chapter 18: Processing Asset Depreciation.....	567
Prerequisites.....	567
Understanding Depreciation Processing.....	567
Steps for Processing Depreciation.....	568
Understanding Depreciation of Group Assets.....	570
Processing Depreciation.....	570
Pages Used to Process Depreciation.....	570
Understanding Depreciation Processing.....	571
Depreciation Calculation Page.....	571
Open Transaction Detail Page.....	572
Changing Depreciation Attributes.....	574
Depreciation Process Log Page.....	575
Expanding Depreciation by Period.....	575
Page Used to Expand Depreciation by Period.....	576
Expand Depreciation by Period Page.....	576
Creating Pending Depreciation Transactions.....	576
Page Used to Create Pending Depreciation Transactions.....	577
Open Transactions - Create Page.....	577
Viewing Depreciation-Related Information.....	577
Pages Used to View Depreciation-Related Information.....	578
Asset Depreciation - Asset Page.....	578
Asset Depreciation - Depreciation Page.....	579
Asset Depreciation - Period Depreciation Page.....	581
Child Assets Page.....	583
Adjusting Accumulated Depreciation.....	584
Page Used to Adjust Accumulated Depreciation.....	584
Adjust Accumulated Depreciation page.....	584
Running Depreciation Reports.....	586
Pages Used to Run Depreciation Reports.....	586
Understanding Depreciation Reports.....	586
Depreciation Reporting Table Page (Depr Reporting Table Page).....	587
Chapter 19: Using User-Defined Asset Depreciation.....	589
Understanding User-Defined Depreciation.....	589
Creating or Selecting Variables.....	589

Page Used to Create or Select Variables.....	592
User Defined Variables Page.....	592
Creating a User-Defined Depreciation Method.....	593
Pages Used to Create a User-Defined Depreciation Method.....	593
User-Defined Methods – Definition Page.....	594
Generating a User-Defined Depreciation SQC Program.....	596
Page Used to Generate a User-Defined Depreciation SQC Program.....	596
Generate User Defined Methods Page.....	596
Copying a User-Defined Depreciation Method.....	597
Page Used to Copy a User-Defined Depreciation Method.....	597
User Defined Method Copy Page.....	598
Selecting a User-Defined Depreciation Method for an Asset.....	599
Chapter 20: Reviewing Asset Depreciation Calculation Results.....	601
Understanding What If Depreciation.....	601
Performing What If Depreciation.....	601
Pages Used to Perform What If Depreciation.....	601
What If Depreciation Page.....	602
What If Depreciation Results Page.....	603
Loading the Net Book Value Table for Reporting.....	604
Page Used to Load the Asset Net Book Value Reporting Table.....	604
Net Book Value Table Page.....	604
Chapter 21: Allocating Asset Depreciation Expenses.....	607
Understanding the Depreciation Allocation Business Process.....	607
Processing Allocations With Fund Accounting.....	607
Prerequisites.....	608
Setting Up the Depreciation Allocation Business Process.....	608
Pages Used to Set Up the Depreciation Allocation Business Process.....	608
Allocation Basis Definition - Definition Page.....	608
Allocation Basis Definition - Allocations Page.....	610
Asset Allocations Page.....	610
Performing the Depreciation Allocation Business Process.....	612
Page Used to Run the Depreciation Allocation Business Process.....	612
Process Allocation Page.....	612
Chapter 22: Creating PeopleSoft Asset Management Accounting Entries.....	615
Prerequisites.....	615
Understanding Asset Information Flow.....	615
Understanding Accounting Entry Setup.....	617
Business Unit and Book Accounting Entry Options.....	617
Accounting Entry Templates.....	617
Depreciation Close Status.....	628
Creating Accounting Entries.....	628
Pages Used to Create Accounting Entries.....	629
Understanding the Depreciation Close Process.....	630
Common Elements Used in This Section.....	632
Create Accounting Entries Page.....	633
Run Depreciation Close Process Page.....	634
Closing Accounting Period Page.....	637
Clearing Reconciliation Page.....	637
Creating Memorandum Accounting Entries for Federal Reporting.....	638
Pages Used to Create Memorandum Accounting Entries.....	638
Understanding Memorandum Account Posting.....	638

Steps to Set up and Create Memorandum Accounting Entries.....	640
Federal Posting Rules Page.....	641
Manage Current Year Assets Page.....	642
ChartField Search Criteria Page.....	646
Review Current Year Assets Page.....	647
Create Federal Entries Page.....	648
Chapter 23: Retiring Assets.....	649
Understanding Asset Retirement.....	649
Retirement Types.....	649
Retiring Financial Assets.....	650
Understanding Traded-In Asset Processing.....	650
Understanding Asset Retirement Using the Disposal Worksheet.....	650
Pages Used to Retire Financial Assets.....	651
Retire Assets Page.....	653
Retire/Reinstate Assets - Other Options Page.....	667
Retire/Reinstate Assets - By ChartField Page.....	669
Retire/Reinstate Asset - Child Assets Page.....	670
Capital Gain Page.....	675
Bill Information Page.....	675
VAT Page.....	679
Auto-Retire Fully Depr Assets Page.....	690
Disposal Worksheet Page.....	691
Approving Disposals.....	696
Approval Map Page.....	699
Putting Assets up for Auction.....	700
Retiring Non-Financial Assets.....	701
Pages Used to Retire Non-Financial Assets.....	701
Non-Financial Retire Page.....	701
Reinstating Assets.....	702
Pages Used to Reinstate Assets.....	702
Understanding Reinstatement of Assets.....	702
Retire Assets Page.....	703
Accounting for Asset Retirement Obligations.....	703
Understanding Accounting for Asset Retirement Obligations (ARO).....	703
Accounting for Asset Retirement Obligations.....	705
Generating ARC.....	708
Pages Used to Account for Asset Retirement Obligations.....	708
Enabling Assets for ARO Processing.....	709
Capturing Asset Retirement Obligations.....	709
ARO Cash Flows Page.....	710
Measuring Asset Retirement Obligations.....	711
ARO Measurement Page.....	711
Accretion Schedule Page.....	717
Depreciating the Asset Retirement Cost.....	718
Accreting the Asset Retirement Obligation.....	719
ARO Measurement en Masse – Selection Criteria Page.....	719
ARO Measurement en Masse – Process Parameters Page.....	720
ARO Measurement en Masse – Accretion Schedule Page.....	721
Reviewing ARO Processing Results.....	722
Expense Schedule Page.....	722
Expense Schedule by Period Page.....	723

Settling the Asset Retirement Obligation.....	725
Reporting for Asset Retirement Obligations.....	726
ARO Reports Page.....	726
Running the Tax Retirement Capital Gains Report (AMTX3210).....	727
Pages Used to Run the Tax Retirement Capital Gains Report.....	727
Prerequisites.....	728
Chapter 24: Processing Asset Mass Transactions.....	729
Understanding Mass Transaction Manager.....	729
Benefits of Mass Transaction Manager.....	729
Setting Up and Processing Mass Transactions.....	729
Reviewing PeopleSoft-Delivered Mass Transactions.....	733
Defining Mass Transactions.....	746
Pages Used to Define Mass Transactions.....	746
Mass Transactions List Page.....	746
Transaction Definition Page.....	750
Mass Transaction Configuration Page.....	754
Mass Transaction Criteria Page.....	756
Mass Transaction Security Page.....	758
Running Mass Transactions.....	759
Page Used to Run Mass Transactions.....	759
Run Mass Transactions Page.....	760
Populating Asset Management Tables with Mass Transaction Data.....	765
Page Used to Populate Asset Management Tables with Mass Transaction Data.....	765
Load into AM Page.....	766
Chapter 25: Using Asset Management Reporting Options.....	769
Understanding Asset Management Reporting Options.....	769
Prerequisites.....	770
Using Flexible Reporting and Formats.....	770
Pages Used to Run Reports With Format Templates.....	771
Parameters Page.....	771
Using Online Reporting.....	776
Page Used to Generate Online Reports.....	776
Cost and Depreciation Page.....	776
Charting Financial Data.....	779
Page Used to Chart Financial Data.....	779
Selection Criteria Page.....	779
Chapter 26: Analyzing Asset Management Using PeopleSoft Insights.....	783
Analyzing Asset Management Using PeopleSoft Insights.....	783
Pages Used to Analyze Asset Management Using PeopleSoft Insights.....	783
Accessing Asset Management Insights Dashboards.....	783
Asset Analytics Dashboard.....	784
Year-Over-Year Asset Analytics Dashboard.....	786
Chapter 27: Using Asset Management Self Service Web Components.....	789
Understanding Self Service Components in Asset Management.....	789
Security.....	789
Asset Management Roles.....	790
Prerequisites to Using Self Service Web Components.....	790
Using Self Service Application Pages.....	791
Pages Used to Use Self Service Application Pages.....	791
My Assets Page.....	792
Chapter 28: Using the Global Features of PeopleSoft Asset Management.....	793

Understanding PeopleSoft Asset Management in Global Settings.....	793
Prerequisites.....	795
(AUS) Using PeopleSoft Asset Management Options to Meet Australian Requirements.....	799
Pages Used to Meet Australian Requirements.....	799
Defining Asset R&D Categorization.....	800
Using the Australian Tax Credit Allowance.....	801
Tracking Changes in CCP.....	803
Reporting Changes in CCP.....	804
Calculating CGT.....	805
Calculation of CGT.....	805
Generating Asset Revaluation (Net Method).....	806
(CAN) Using Asset Management Options to Meet Canadian Requirements.....	807
Pages Used to Meet Canadian Requirements.....	807
CCA Year End CAN Page.....	808
Update CCA Year End Page.....	808
(FRA) Using PeopleSoft Asset Management Options to Meet French Requirements.....	809
Pages Used to Meet French Requirements.....	809
Business Tax Report Page.....	809
Depreciating Assets by Using the Derogatory Method.....	810
Revaluing Assets.....	811
2054 2055 Reports Page.....	811
(DEU) Using PeopleSoft Asset Management Options to Meet German Requirements.....	812
Pages Used to Meet German Requirements.....	812
Staffel Depreciation Method.....	813
Using a Half-Year Prorate Convention.....	815
Using Geometric Digressive Depreciation.....	815
Capitalization Limits Page.....	815
Terms Definition Page.....	816
(IND) Using PeopleSoft Asset Management Options to Meet Indian Requirements.....	817
Pages Used to Meet Indian Requirements.....	818
Understanding Asset Depreciation Processing for India.....	818
Processing India Tax Depreciation.....	819
(ITA) Using PeopleSoft Asset Management Options to Meet Italian Requirements.....	823
Page Used to Meet Italian Requirements.....	823
Fixed Asset Register Page for Italy.....	823
(JPN) Using PeopleSoft Asset Management Options to Meet Japanese Requirements.....	824
Pages Used to Meet Japanese Requirements.....	824
Prerequisites.....	826
Using Japanese Depreciation Methods.....	827
Extended Depreciation Worksheet Page.....	834
Using Special Depreciation and Increased Depreciation.....	835
Using Advanced Depreciation.....	836
Run Mass Transactions.....	836
Identifying Collateral Assets.....	838
Using Currency Rounding Options.....	838
Processing Local Tax Reports.....	838
Entering Consumption Tax.....	844
Chapter 29: Archiving Asset Information.....	845
Understanding Archiving.....	845
Archiving Inactive Assets.....	846
Page Used to Archive Data.....	846

Archive Cost/Depreciation Page.....	846
Viewing Archived Data.....	847
Pages Used to View Archived Data.....	848
Restoring Archived Data.....	848
Page Used to Restore Archived Data.....	849
Restore Cost/Depreciation Page.....	849
Archiving From Transaction Table Details.....	849
Chapter 30: Understanding the Loader Table Data Dictionary.....	851
Understanding the Loader Tables.....	851
Loader Table INTFC_FIN.....	851
Loader Table INTFC_PHY_A.....	891
Loader Table INTFC_PHY_B.....	925
Transaction Loader Inserts.....	934
From INTFC_FIN.....	934
From INTFC_PHY_A.....	936
From INTFC_PHY_B.....	937
Interface Types (Load Types).....	938
Chapter 31: Understanding Depreciation Calculations.....	943
Understanding How PeopleSoft Asset Management Calculates Depreciation.....	943
Salvage Value.....	943
Tax Credits.....	943
Listed Property Assets.....	944
The Depreciation Calculation Process.....	945
Calculating the Begin Depreciation Date.....	946
Overriding the Begin Depreciation Field.....	946
Calculating Remaining Value.....	946
Remaining Value Calculation for Add Transactions.....	946
Life to Date Calculation for Add Transactions.....	947
Calculating Yearly Depreciation.....	948
Remaining Value Calculation for Add Transactions.....	949
Life to Date Calculation for Add Transactions.....	950
Calculating Period Allocation.....	951
Remaining Value Calculation for Add Transactions: Depreciate When In Service Off.....	951
Remaining Value Calculation for Add Transactions: Depreciate When In Service On.....	952
Life to Date Calculations for Add Transactions: Depreciate When in Service Off.....	954
Life to Date Calculation for Add Transactions: Calculate When in Service On.....	955
Calculating Prior Period Depreciation.....	956
Case 1: Add Transactions.....	956
Case 2: Add Transactions.....	958
Case 3: Add Transactions.....	960
Case 4: Add Transactions.....	961
Case 5: Add Transactions.....	963
Formula-Based Depreciation Methods.....	964
Straight Line.....	965
(IND) Straight Line Percent.....	966
Declining Balance with a Switch to Straight Line.....	972
Declining Balance with Depreciation Limit.....	973
Declining Balance.....	975
Flat Rate.....	976
Sum of the Years' Digits.....	978
Calculating Depreciation When Salvage Value Exceeds Net Book Value (NBV).....	980

Stop Depreciation When Salvage Value Exceeds NBV.....	980
Allow Negative Depreciation.....	982
Chapter 32: PeopleSoft Asset Management Reports.....	987
PeopleSoft Asset Management Reports.....	987
Asset Set Up Lists.....	987
Transaction Reports.....	988
Capital Acquisition Planning Reports.....	989
Depreciation Reports.....	989
Impairment Reports.....	991
Account Activity Reports.....	991
Accounting Entry Reports.....	992
Physical Inventory Reports.....	993
Lease Reports.....	994
Retirement Reports.....	995
U.S. Tax Reports.....	995
Global Reports.....	997
Using Oracle Business Intelligence (BI) Publisher Reports to Support Configured ChartFields.....	1001

Preface

Understanding the PeopleSoft Online Help and PeopleBooks

The PeopleSoft Online Help is a website that enables you to view all help content for PeopleSoft applications and PeopleTools. The help provides standard navigation and full-text searching, as well as context-sensitive online help for PeopleSoft users.

Hosted PeopleSoft Online Help

You can access the hosted PeopleSoft Online Help on the [Oracle Help Center](#). The hosted PeopleSoft Online Help is updated on a regular schedule, ensuring that you have access to the most current documentation. This reduces the need to view separate documentation posts for application maintenance on My Oracle Support. The hosted PeopleSoft Online Help is available in English only.

To configure the context-sensitive help for your PeopleSoft applications to use the Oracle Help Center, see [Configuring Context-Sensitive Help Using the Hosted Online Help Website](#).

Locally Installed PeopleSoft Online Help

If you're setting up an on-premises PeopleSoft environment, and your organization has firewall restrictions that prevent you from using the hosted PeopleSoft Online Help, you can install the online help locally. Installable PeopleSoft Online Help is made available with selected PeopleSoft Update Images and with PeopleTools releases for on-premises installations, through the [Oracle Software Delivery Cloud](#).

Your installation documentation includes a chapter with instructions for how to install the online help for your business environment, and the documentation zip file may contain a README.txt file with additional installation instructions. See *PeopleSoft 9.2 Application Installation* for your database platform, "Installing PeopleSoft Online Help."

To configure the context-sensitive help for your PeopleSoft applications to use a locally installed online help website, see [Configuring Context-Sensitive Help Using a Locally Installed Online Help Website](#).

Downloadable PeopleBook PDF Files

You can access downloadable PDF versions of the help content in the traditional PeopleBook format on the [Oracle Help Center](#). The content in the PeopleBook PDFs is the same as the content in the PeopleSoft Online Help, but it has a different structure and it does not include the interactive navigation features that are available in the online help.

Common Help Documentation

Common help documentation contains information that applies to multiple applications. The two main types of common help are:

- Application Fundamentals

- Using PeopleSoft Applications

Most product families provide a set of application fundamentals help topics that discuss essential information about the setup and design of your system. This information applies to many or all applications in the PeopleSoft product family. Whether you are implementing a single application, some combination of applications within the product family, or the entire product family, you should be familiar with the contents of the appropriate application fundamentals help. They provide the starting points for fundamental implementation tasks.

In addition, the *PeopleTools: Applications User's Guide* introduces you to the various elements of the PeopleSoft Pure Internet Architecture. It also explains how to use the navigational hierarchy, components, and pages to perform basic functions as you navigate through the system. While your application or implementation may differ, the topics in this user's guide provide general information about using PeopleSoft applications.

Field and Control Definitions

PeopleSoft documentation includes definitions for most fields and controls that appear on application pages. These definitions describe how to use a field or control, where populated values come from, the effects of selecting certain values, and so on. If a field or control is not defined, then it either requires no additional explanation or is documented in a common elements section earlier in the documentation. For example, the Date field rarely requires additional explanation and may not be defined in the documentation for some pages.

Typographical Conventions

The following table describes the typographical conventions that are used in the online help.

<i>Typographical Convention</i>	<i>Description</i>
Key+Key	Indicates a key combination action. For example, a plus sign (+) between keys means that you must hold down the first key while you press the second key. For Alt+W , hold down the Alt key while you press the W key.
... (ellipses)	Indicate that the preceding item or series can be repeated any number of times in PeopleCode syntax.
{ } (curly braces)	Indicate a choice between two options in PeopleCode syntax. Options are separated by a pipe ().
[] (square brackets)	Indicate optional items in PeopleCode syntax.
& (ampersand)	When placed before a parameter in PeopleCode syntax, an ampersand indicates that the parameter is an already instantiated object. Ampersands also precede all PeopleCode variables.

Typographical Convention	Description
⇒	This continuation character has been inserted at the end of a line of code that has been wrapped at the page margin. The code should be viewed or entered as a single, continuous line of code without the continuation character.

ISO Country and Currency Codes

PeopleSoft Online Help topics use International Organization for Standardization (ISO) country and currency codes to identify country-specific information and monetary amounts.

ISO country codes may appear as country identifiers, and ISO currency codes may appear as currency identifiers in your PeopleSoft documentation. Reference to an ISO country code in your documentation does not imply that your application includes every ISO country code. The following example is a country-specific heading: "(FRA) Hiring an Employee."

The PeopleSoft Currency Code table (CURRENCY_CD_TBL) contains sample currency code data. The Currency Code table is based on ISO Standard 4217, "Codes for the representation of currencies," and also relies on ISO country codes in the Country table (COUNTRY_TBL). The navigation to the pages where you maintain currency code and country information depends on which PeopleSoft applications you are using. To access the pages for maintaining the Currency Code and Country tables, consult the online help for your applications for more information.

Region and Industry Identifiers

Information that applies only to a specific region or industry is preceded by a standard identifier in parentheses. This identifier typically appears at the beginning of a section heading, but it may also appear at the beginning of a note or other text.

Example of a region-specific heading: "(Latin America) Setting Up Depreciation"

Region Identifiers

Regions are identified by the region name. The following region identifiers may appear in the PeopleSoft Online Help:

- Asia Pacific
- Europe
- Latin America
- North America

Industry Identifiers

Industries are identified by the industry name or by an abbreviation for that industry. The following industry identifiers may appear in the PeopleSoft Online Help:

- USF (U.S. Federal)

- E&G (Education and Government)

Translations and Embedded Help

PeopleSoft 9.2 software applications include translated embedded help. With the 9.2 release, PeopleSoft aligns with the other Oracle applications by focusing our translation efforts on embedded help. We are not planning to translate our traditional online help and PeopleBooks documentation. Instead we offer very direct translated help at crucial spots within our application through our embedded help widgets. Additionally, we have a one-to-one mapping of application and help translations, meaning that the software and embedded help translation footprint is identical—something we were never able to accomplish in the past.

Using and Managing the PeopleSoft Online Help

Select About This Help in the left navigation panel on any page in the PeopleSoft Online Help to see information on the following topics:

- Using the PeopleSoft Online Help.
- Managing hosted Online Help.
- Managing locally installed PeopleSoft Online Help.

PeopleSoft FSCM Related Links

[Oracle Help Center](#)

[Hosted Online Help](#)

[PeopleSoft Information Portal](#)

[My Oracle Support](#)

Financial and Supply Chain Management information for Search Framework search engine can be found in PeopleSoft Application Fundamentals documentation. For application specific information, see the “Understanding Keyword Search within Components” (Application Fundamentals) topic.

[PeopleSoft Training from Oracle University](#)

[PeopleSoft Video Feature Overviews on YouTube](#)

[PeopleSoft Business Process Maps \(Microsoft Visio format\)](#)

[PeopleSoft Spotlight Series](#)

Contact Us

Send your suggestions to psoft-infodev_us@oracle.com.

Please include the applications update image or PeopleTools release that you're using.

Follow Us

<i>Icon</i>	<i>Link</i>
	Watch PeopleSoft on YouTube
	Follow @PeopleSoft_Info on X.
	Read PeopleSoft Blogs
	Connect with PeopleSoft on LinkedIn

Chapter 1

Common Elements in Asset Management

Common Elements Used in Asset Management

<i>Field or Control</i>	<i>Description</i>
Account	ChartField that identifies the nature of a transaction for corporate accounts.
Accounting Date	Date for accounting entries for an activity.
Affiliate	ChartField used to map transactions between business units when using a single interunit account.
Alt Acct (alternate account)	ChartField that identifies the nature of a transaction for statutory accounts. This field appears only if you enable the Alternate Account option for your organization and for the general ledger business unit.
As of Date	The last date for which a report or process includes data.
Business Unit	An identification code that represents a high-level organization of business information. You can use a business unit to define regional or departmental units within a larger organization.
Category	ChartField value that represents the category for a project transaction in Project Costing. A category further defines a source type. For example, if you have a source type of labor, you might have categories for architect labor, carpenter labor, and plumber labor. This field is available only if you have Project Costing.
Chartfield 1 to Chartfield 3	ChartFields that you configure to meet your organization's requirements.
Class	<p>ChartField that identifies a particular appropriation when you combine it with a Fund, Department, Program Code, and Budget Reference.</p> <p>Group of customers in a trade, such as grocers or mass merchandisers.</p>

Field or Control	Description
Currency	Code that identifies the type of currency for an amount, such as USD or EUR.
Dept (department)	ChartField that indicates who is responsible for or affected by the transaction.
Description	Freeflow text up to 30 characters.
Document Sequence or Document Sequencing	Click to open a page where you can enter document sequencing information. This option is available only if you enable the document sequencing feature for the PeopleSoft General Ledger business unit.
Effective Date	Date on which a table row becomes effective; the date that an action begins. For example, if you want to close out a ledger on June 30, the effective date for the ledger closing would be July 1. This date also determines when you can view and change the information. Pages or panels and batch processes that use the information use the current row.
EmplID (employee ID)	Unique identification code for an individual associated with your organization.
Exchange Rate	Rate that is used for currency conversion.
Fund	ChartField that represents structural units for education and government accounting. Can also represent a divisional breakdown in your organization.
Journal	Created when you edit journal lines (accounting entries) online in PeopleSoft General Ledger or you run the Journal Generator process for subsystem, imported, or batch accounting entries.
Language or Language Code	The language in which you want the field labels and report headings of your reports to print. The field values appear as you enter them. Language also refers to the language spoken by an employee, applicant, or non-employee.
Oper Unit (operating unit)	ChartField that is used to identify a location, such as a distribution warehouse or sales center.

Field or Control	Description
Process Frequency	Designates the appropriate frequency in the Process Frequency group box: <i>Once</i> executes the request the next time the batch process runs. After the batch process runs, the process frequency is automatically set to Don't Run. <i>Always</i> executes the request every time the batch process runs. <i>Don't Run</i> ignores the request when the batch process runs.
Process Monitor	This link takes you to the Process List page, where you can view the status of submitted process requests.
Product	ChartField that captures additional information that is useful for profitability and cash flow analysis by product sold or manufactured.
Program	ChartField that identifies groups of related activities, cost centers, revenue centers, responsibility centers, and academic programs. Tracks revenue and expenditures for programs.
Project	ChartField that captures information for project or grants accounting.
Report ID	The report identifier.
Report Manager	This link takes you to the Report List page, where you can view report content, check the status of a report, and see content detail messages (which show you a description of the report and the distribution list).
Request ID	A request identification that represents a set of selection criteria for a report or process.
Run	This button takes you to the Process Scheduler request page, where you can specify the location where a process or job runs and the process output format.
Run Control ID	A request identification that represents a set of selection criteria for a report or process.
SetID	An identification code that represents a set of control table information or TableSets. A TableSet is a group of tables (records) necessary to define your company's structure and processing options.
Short Description	Freeflow text up to 15 characters.

Field or Control	Description
Source Type	ChartField value that represents the source type for a project transaction in Project Costing. A source type identifies the purpose of the transaction, for example labor. This field is available only if you have Project Costing.
Statistics Code	ChartField that identifies nonmonetary statistical amounts.
Status	Indicates if a row in a table is active or inactive. You cannot display inactive rows or pages or use them for running batch processes. Use inactive rather than delete data you no longer use in order to maintain an audit trail.
User ID	The system identifier for the individual who generates a transaction.

See the product documentation for *PeopleTools Process Scheduler*, “Understanding PeopleSoft Process Scheduler”.

See the product documentation for *PeopleTools Applications User’s Guide*, “Working with Pages, Using Effective Dates”.

Chapter 2

Getting Started With PeopleSoft Asset Management

PeopleSoft Asset Management Overview

This product documentation discusses the following functionality and business processes:

- Navigating in PeopleSoft Asset Management.
- Implementing PeopleSoft Asset Management.
- Converting to PeopleSoft Asset Management.
- Adding and maintaining assets.
- Working with asset budgeting.
- Working with leased assets.
- Adjusting, transferring and evaluating assets.
- Managing asset maintenance, warranties, repairs, and insurance.
- Using group asset processing.
- Using composite asset processing.
- Performing asset physical inventory.
- Working with joint venture assets.
- Processing depreciation.
- Using user-defined depreciation.
- Reviewing depreciation calculation results.
- Allocating depreciation expenses.
- Creating asset accounting entries.
- Retiring assets.
- Processing asset mass changes.
- Using PeopleSoft Asset Management reporting options.
- Using self-service web components.

- Using global features for asset management.
- Archiving asset information.
- Understanding depreciation calculations.
- Understanding the Loader Table Data Dictionary.
- PeopleSoft Asset Management reports.

PeopleSoft Asset Management Business Processes

The following graphic lists the PeopleSoft Asset Management business processes:

You can find more information about these business processes in the business process topics in this documentation.

The following graphic lists the PeopleSoft Asset Management business processes:

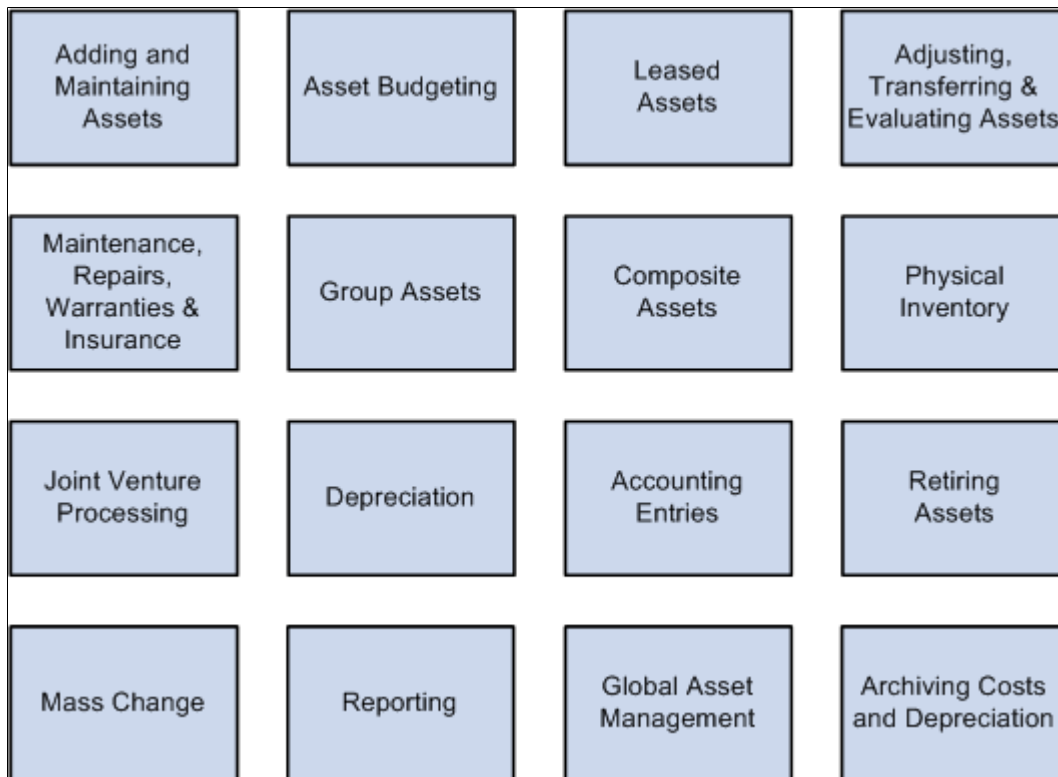

PeopleSoft Asset Management Integration Touchpoints

Asset Management is the core product of the PeopleSoft Asset Lifecycle Management suite, which also includes:

- PeopleSoft IT Asset Management

- PeopleSoft Maintenance Management
- PeopleSoft Lease Administration

To use PeopleSoft Asset Management to full advantage, it is also important to understand the points of integration between PeopleSoft Asset Management and the other PeopleSoft applications that you have purchased, such as:

- PeopleSoft General Ledger.
- PeopleSoft Billing.
- PeopleSoft Budgeting.
- PeopleSoft Purchasing.
- PeopleSoft Project Costing.
- PeopleSoft Payables.
- PeopleSoft Strategic Sourcing.
- Third-party applications for computer-aided facilities management, tax provider systems applications.

Because applications share information, you must plan to work closely with the implementation teams that install other PeopleSoft applications to ensure that PeopleSoft provides the full functionality and efficiency that your company requires.

You can find more information about integration considerations in the implementation topics in this documentation. Supplemental information about third-party application integrations is on Oracle's My Oracle Support web site:

PeopleSoft Asset Management integrates with these PeopleSoft applications:

This graphic illustrates the applications with which PeopleSoft Asset Management integrates.

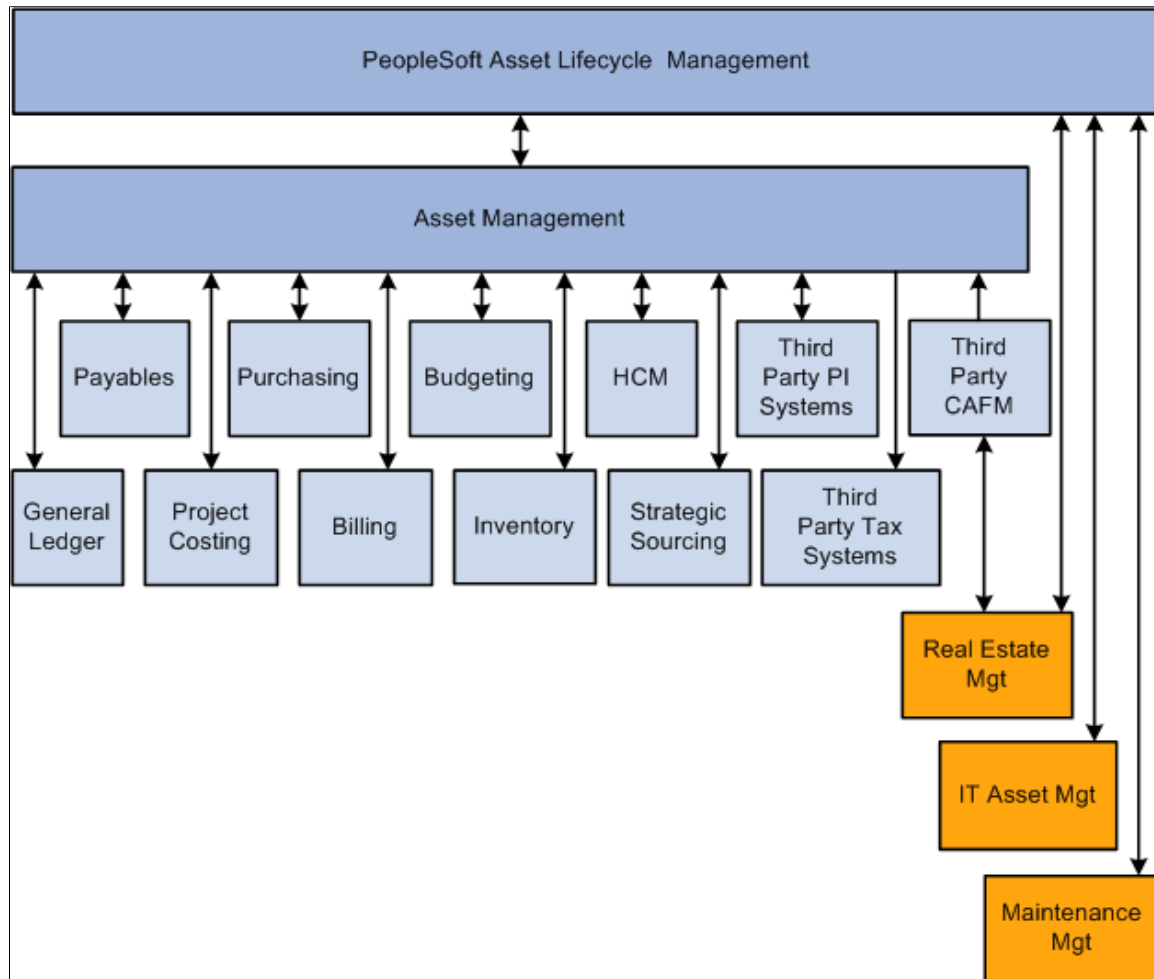

Enabling ChartField Security for PeopleSoft Asset Management

PeopleSoft ChartField security provides a flexible, rule-based approach to administer security at a data level. ChartField security is supported in PeopleSoft Asset Management and across other PeopleSoft Financials and Supply Chain Management (FSCM) applications. The ChartField security feature prevents unauthorized employees and contractors from viewing and editing sensitive financial data by restricting access to data stored with specific ChartField values.

The primary features for ChartField security are:

- Enforce security rules by user, role, or permission list.
- Enable ChartField security for all products or selectively by product.
- Enable or disable ChartField security selectively by component.
- Define rules to accommodate end-user areas of responsibility.
- Refine access rules by product feature or component.

- Support super user access to minimize setup
- Define components as exceptions to override security rules.

See , “Understanding ChartField Security” (Application Fundamentals).

Implementing PeopleSoft Asset Management

PeopleSoft Setup Manager enables you to review a list of setup tasks for your organization for the products that you are implementing. The setup tasks include the components that you must set up, listed in the order in which you must enter data into the component tables, and links to the corresponding documentation.

PeopleSoft Financials also provides component interfaces to help you load data from your existing system into PeopleSoft tables. Use the Excel to Component Interface utility with the component interfaces to populate the tables.

Component	Component Interface	Reference
Agencies (AGENCY_DEFN)		See “Defining Asset Attributes” (Asset Lifecycle Management Fundamentals).
Define AM Allocation Basis (ALLOC_BASIS_GRP)		See “Understanding Depreciation Processing” (Asset Lifecycle Management Fundamentals).
Area Definition (AM_AREA_TBL)		See “Defining Asset Attributes” (Asset Lifecycle Management Fundamentals).
Define Criticality Code (AM_CRIT_LEVEL)		See “Criticality Codes Page” (Asset Lifecycle Management Fundamentals).
Asset Indexes (AM_INDEX_TBL)		See “Defining Financial Processing for PeopleSoft Asset Management” (Asset Lifecycle Management Fundamentals).
AM Location Definition (AM_LOCATION)		See “Defining Asset Attributes” (Asset Lifecycle Management Fundamentals).
Asset Owners (AM_OWNER_COMP)		See “Establishing Asset Ownership” (Asset Lifecycle Management Fundamentals).
Asset Owner Operators (AM_OWNER_OPR_COMP)		See “Establishing Asset Ownership” (Asset Lifecycle Management Fundamentals).

Component	Component Interface	Reference
Accounting Entry Template IDs (AMAE_TMPL_ID_PNL)		See “Defining Accounting Entries” (Asset Lifecycle Management Fundamentals).
Asset Class (ASSET_CLASS)	ASSET_CLASS_CI	See “Asset Classes Page” (Asset Lifecycle Management Fundamentals).
Asset Hazardous Code (ASSET_FSC_DFN)	ASSET_FSC_DEFN_CI	See “Hazardous Codes Page” (Asset Lifecycle Management Fundamentals).
Bus Tax Rate for Asset/Location (ASSET_LOC_RATE)		See “(FRA) Defining Business Tax by Location” (Asset Lifecycle Management Fundamentals).
Asset Thresholds (ASSET_THRESHOLDS)		See “(AUS) Defining VAT Thresholds” (Asset Lifecycle Management Fundamentals).
Define Asset Management Books (BOOK_DEFN1)		See “Business Unit/Book Definition Page” (Asset Lifecycle Management Fundamentals).
BU Aggregate R&D Expenditure (BU_AGG_RD)		See Defining Asset R&D Categorization .
Asset Management Business Unit (BU_DEFN)		See “Creating PeopleSoft Asset Management Business Units” (Asset Lifecycle Management Fundamentals).
Capital Acquisition Plan Type (CAP_TYPE)		See “Defining Financial Processing for PeopleSoft Asset Management” (Asset Lifecycle Management Fundamentals).
Asset Category (CATEGORY_DEFN)	CATEGORY_DEFN_CI	See “Categories Page” (Asset Lifecycle Management Fundamentals).
Depr Convention Builder (CONV_BLDR_PNLG)		See “Setting Up Depreciation Conventions” (Asset Lifecycle Management Fundamentals).
Copy All Depr Conventions (CONV_COPY_ALL_COMP)		See “Setting Up Depreciation Conventions” (Asset Lifecycle Management Fundamentals).
Copy Depreciation Conventions (CONV_COPY_PNLG)		See “Setting Up Depreciation Conventions” (Asset Lifecycle Management Fundamentals).

Component	Component Interface	Reference
Cost Types (COST_TYPE_DEFN)		See “Defining Financial Processing for PeopleSoft Asset Management” (Asset Lifecycle Management Fundamentals).
Capitalization Limits Codes (DEPR_CAP_LIMIT)		See Capitalization Limits Page .
Capitalization Thresholds (CAP_THR_DEFN)		See Capitalization Thresholds Page .
Combination Editing Options (AM_CEDT_SSRC)		See “Enabling Combination Editing” (Asset Lifecycle Management Fundamentals).
Depreciation Conventions (DEPR_CONVENTION)		See “Setting Up Depreciation Conventions” (Asset Lifecycle Management Fundamentals).
Depreciation Limits (DEPR_LIMIT_DEFN)		See “Defining Depreciation Limits” (Asset Lifecycle Management Fundamentals).
Depreciation Schedules (DEPR_SCHEDULE_DEFN)	DEPR_SCHEDULE_DEFN_CI	See “Setting Up Depreciation Schedules” (Asset Lifecycle Management Fundamentals).
Depreciation Terms Definition (DEPR_TERMS_DEFN)	DEPR_TERMS_DEFN_CI	See “Defining Depreciation Terms and Rates” (Asset Lifecycle Management Fundamentals).
Accounting Entry Templates (DIST_TEMPLATE_DEFN)		See “Defining Accounting Entries” (Asset Lifecycle Management Fundamentals).
Fair Value Valuation Methods (AM_FV_METHOD_DEFN)		See “Enabling Combination Editing” (Asset Lifecycle Management Fundamentals).
Fair Value Groups (AM_FV_GROUP_DEFN)		See “Enabling Combination Editing” (Asset Lifecycle Management Fundamentals).
Fair Value Templates (AM_FV_TEMPLAT_DEFN)		See “Enabling Combination Editing” (Asset Lifecycle Management Fundamentals).

Component	Component Interface	Reference
FERC Code Definition (FERC_CD_DEFN)		See “Defining Additional Common Information” (Application Fundamentals).
Financing Codes (FINANCE_CD)		See “Defining Financial Processing for PeopleSoft Asset Management” (Asset Lifecycle Management Fundamentals).
Insurance Types (INSURANCE_TYPE)		See “Defining Asset Attributes” (Asset Lifecycle Management Fundamentals).
Inter Unit Transfer Definition (IU_TRF_DEFN_TBL)	IU_TRF_DEFN_TBL_CI	See “Defining Accounting Entries” (Asset Lifecycle Management Fundamentals).
Joint Venture BU Allocations (JV_BUS_ALLOC)		See “Joint Venture Allocation Page” (Asset Lifecycle Management Fundamentals).
Define Maintenance Types (MAINT_TYPE_DEFN)		See “Maintenance Types Page” (Asset Lifecycle Management Fundamentals).
Multi-Shift Definition (MULTI_SHIFT_DEFN)		See “(DEU) Setting Up Multi-shift Codes” (Asset Lifecycle Management Fundamentals).
Owner Information (OWNER_INFO_DEFN)		See “Establishing Asset Ownership” (Asset Lifecycle Management Fundamentals).
Physical Inventory Scheduling (PI_SCHEDULE)		See Configuring Physical Inventory .
Physical Inventory Sys Setup (PI_SYSTEM_SETUP)		See Configuring Physical Inventory .
Define Asset Profiles (PROFILE)	PROFILE_CI	See “Setting Up Asset Profiles” (Asset Lifecycle Management Fundamentals).
Lease Schedule (PYMNT_SCHED_TBL)		See “Payment Schedules page” (Asset Lifecycle Management Fundamentals).
Qualified Investments (QIV)		See “(USA) Defining Qualified Investment Codes” (Asset Lifecycle Management Fundamentals).

Component	Component Interface	Reference
Return Information (RETURN_INFO_DEFN)		See Processing Local Tax Reports .
Define Report Drilldown (RPT_DRILL_FLD_G)		See “Reporting Drilldown Fields Page” (Asset Lifecycle Management Fundamentals).
Book Class Security (SEC_BUBOOK_CLS)		See “Understanding PeopleSoft Application Security” (Application Fundamentals).
Book Operator Security (SEC_BUBOOK_OPR)		See “Understanding PeopleSoft Application Security” (Application Fundamentals).
Asset Tax Classes (TAX_CLASS_DEFN)		See “(CAN, IND, and USA) Defining and Maintaining Tax Classes” (Asset Lifecycle Management Fundamentals).
Tax Credit Status (TAX_CR_STATUS)		See “Defining Tax Credits” (Asset Lifecycle Management Fundamentals).
Tax Credits (TAX_CREDITS)		See “Defining Tax Credits” (Asset Lifecycle Management Fundamentals).
Retirement Basis Reduction (TRAN_EXCLUDE_TBL)		See “Setting Up Retirement Basis Reduction Codes” (Asset Lifecycle Management Fundamentals).
Transaction Groups (TRANS_PNL_GRP)		See “Defining Accounting Entries” (Asset Lifecycle Management Fundamentals).
Define Transaction Codes (TRANSACTION_CODE)		See “Transaction Codes Page” (Asset Lifecycle Management Fundamentals).
User Defined Depreciation Rate (UD_DEPR_RATE)	UD_DEPR_RATE_CI	See “Defining Depreciation Terms and Rates” (Asset Lifecycle Management Fundamentals).
User Defined Methods (UD_METHOD)		See Creating a User-Defined Depreciation Method .
User Defined Methods - Copy (UD_METHOD_COPY)		See Creating a User-Defined Depreciation Method .

Component	Component Interface	Reference
User Defined Variables (UD_VARIABLE_DEFN)		See Creating or Selecting Variables .
Define Units of Production (UOP_DEFN)		See “Units of Production Page” (Asset Lifecycle Management Fundamentals).
Account (GL_ACCOUNT)	ACCOUNT_CF	See “Account Page” (Application Fundamentals).
Alternate Account (ALTACCT)	ALTACCT_CF	See “Alternate Account Page” (Application Fundamentals).
Operating Unit (OPERATING_UNIT)	OPER_UNIT_CF	See “Operating Unit Page” (Application Fundamentals).
Department (DEPARTMENT)	DEPT_CF	See “Department Page” (Application Fundamentals).
Project ID (PROJECT)	PROJECT_CF	See “Project Page” (Application Fundamentals).
Product (PRODUCT)	PRODUCT_CF	See “Product Page” (Application Fundamentals).
Fund Code (FUND_DEFINITION)	FUND_CF	See “ChartField 1 Page” (Application Fundamentals).
Chartfield 1 (CHARTFIELD1)	CHARTFIELD1	See “ChartField 1 Page” (Application Fundamentals).
Chartfield 2 (CHARTFIELD2)	CHARTFIELD2	See “ChartField 1 Page” (Application Fundamentals).
Chartfield 3 (CHARTFIELD3)	CHARTFIELD3	See “ChartField 1 Page” (Application Fundamentals).
InterUnit Template (IU_INTER_TMPLT)	IU_INTER_TMPLT	See “InterUnit Template Page” (Application Fundamentals).
IntraUnit Template (IU_INTRA_TMPLT)	IU_INTRA_TMPLT	See “Intraunit Template Page” (Application Fundamentals).
InterUnit Pair Maintenance (IU_INTER_PR_BASIC)	IU_INTER_PR_BASIC	See “Using Mass Maintenance for Interunit Pairs” (Application Fundamentals).

Component	Component Interface	Reference
Market Rates (RT_RATE_PNL)		See “Establishing Market Rates” (PeopleSoft Global Options and Reports).
Market Rate Definition (MARKET_RATE_DEF)		See “Defining Market Rates” (PeopleSoft Global Options and Reports).
Currency Quotation Method (CURR_QUOTE_PNL)		See “Defining Currency Quotations” (PeopleSoft Global Options and Reports).
Ledgers for a Unit (BUSINESS_UNIT_LED)	EM_BUS_UNIT_LED	See “Defining Ledgers for a Business Unit” (Application Fundamentals).
Value Added Tax Code (TAX_CODE_VAT)	TAX_CODE_VAT	See “Setting Up VAT Authorities, and Tax Codes” (PeopleSoft Global Options and Reports).
VAT Accounts by Business Unit (TAX_BU_CODE_VAT)	TAX_BU_CODE_VAT	See “VAT Accounts by Business Unit Page” (PeopleSoft Global Options and Reports).
VAT Entity (VAT_ENTITY_ID)	VAT_ENTITY_ID	See “Setting Up VAT Entities” (PeopleSoft Global Options and Reports).
Vat Defaults CI Component (VAT_DEF_CI)	VAT_DEF_CI	See “Establishing VAT Defaults” (PeopleSoft Global Options and Reports).
Customer Group Table (CUST_GROUP_TBL)		See “Customer Group Table Page” (PeopleSoft Order to Cash Common Information).
Contact Info (CONTACT_INFO)		See “Understanding Contact Information” (PeopleSoft Order to Cash Common Information).
General Information (CUSTOMER_GENERAL)		See “Understanding the Primary Customer Roles” (PeopleSoft Order to Cash Common Information).
User Preferences (OPR_DEFAULT)	OPR_DEFAULT_FIN	See “Understanding User Preferences” (Application Fundamentals).

Other Sources of Information

In the implementation planning phase, take advantage of all PeopleSoft sources of information, including the installation guides, data models, business process maps, and troubleshooting guidelines.

See the product documentation for *PeopleTools: PeopleSoft Setup Manager*, and *PeopleTools: PeopleSoft Component Interfaces*.

Chapter 3

Navigating in PeopleSoft Asset Management

Using Custom Navigation Center Pages in PeopleSoft Asset Management

PeopleSoft Asset Management provides custom navigation center pages that contain groupings of folders that support a specific business process, task, or user role.

Note: In addition to the custom navigation center pages, PeopleSoft Asset Management provides menu navigation, standard navigation pages, and PeopleSoft Navigator.

Pages Used to Navigate in PeopleSoft Asset Management

This table lists the custom navigation Asset Definitions Center pages that are used to navigate implementation tasks in PeopleSoft Asset Management:

<i>Page Name</i>	<i>Navigation</i>	<i>Usage</i>
Asset Management	Main Menu > Asset Management	Access primary PeopleSoft Asset Management menu options and activities.
Asset Definitions Center	Main Menu > Asset Management	Access primary PeopleSoft Asset Management Center menu options and activities.
Asset Transactions	Click Asset Transactions on the Asset Management menu page.	Access the Asset Transaction folder to administer financial and nonfinancial asset transactions, including adds, adjustments, transfers, and retirements.
Owned Assets	Click Owned Assets on the Asset Transactions menu page.	Access the Owned Assets folder to enter, copy, update, and display owned asset information.
Express Add	Click Express Add on the Owned Assets page.	Access the Express Add page to create a new asset with only financial data.

Page Name	Navigation	Usage
Basic Add	Click Basic Add on the Owned Assets page.	Access the Basic Add page to enter or update financial assets with physical and financial details.
View Component Hierarchy	Click View Component Hierarchy on the Owned Assets page.	Access the Asset Component Hierarchy page to display an asset hierarchy in a grid.
Manage Component Hierarchy	Click Manage Component Hierarchy on the Owned Assets page.	Access the Asset Component Hierarchy page to display an asset hierarchy in a grid as well as to insert and remove assets from the hierarchy.
Copy Existing Asset	Click Copy Existing Asset on the Owned Assets page.	Access the Copy Existing Asset page to copy existing asset information to a new asset ID.
Calculate Replacement Cost	Click Calculate Replacement Cost on the Owned Assets page.	Access the Calculate Replacement Cost page to calculate and update indexed replacement costs.
Define Asset Operational Information	Click Define Asset Operational Info on the Owned Assets page.	Access the Define Asset Operational Information page to enter nonfinancial assets or update physical details of existing assets.
Maintain Property Occupants	Click Maintain Property Occupants on the Owned Assets page.	Access the Maintain Property Occupants page to enter property occupant information.
Leased Assets	Click Leased Assets on the Asset Transactions menu page.	Access the Leased Assets folder to enter and update leased asset information.
Express Add	Click Express Add on the Leased Assets page.	Access the Lease Express Add page to create capital or operating leases with appropriate payment and depreciation schedules.
Update Lease Information	Click Update Lease Information on the Leased Assets page.	Access the Update Lease Information page to enter or update leased assets with physical and financial details.
Create Expense Schedule	Click Create Expense Schedule on the Leased Assets page.	Access the Lease Expense Schedule page to generate new lease expense schedules.
Transfer Operating Lease	Click Transfer Operating Lease on the Leased Assets page.	Access the Transfer Operating Lease page to transfer an operating lease to a new ChartField.

Page Name	Navigation	Usage
Acquisition Details	Click Acquisition Details on the Asset Transactions menu page.	Access the Acquisition Details folder to review acquisition details from vouchers, purchase orders, and receipts.
Review Purchase Orders	Click Review Purchase Orders on the Acquisition Details page.	Access the Review Purchase Orders page to review purchase order data such as business unit, PO ID, and related contracts.
Review Receivers	Click Review Receivers on the Acquisition Details page.	Access the Review Receivers page to review receiving details such as business unit, item ID, or vendor receipt quantities.
Review Vouchers	Click Review Vouchers on the Acquisition Details page.	Access the Review Vouchers page to review acquisition details from vouchers.
Asset Book Information	Click Asset Book Information on the Asset Transactions menu page.	Access the Asset Book Information component to review, add, or update asset books.
Define Tax/Depr Criteria	Click Define Tax/Depr Criteria on the Asset Book Information page.	Access the Define Tax/Depr Criteria page to define asset book and tax depreciation attributes.
Add/Copy Asset Book	Click Add/Copy Asset Book on the Asset Book Information page.	Access the Add/Copy Asset Book page to copy to a new book or convert book currency in mass.
Parent-Child Relationship	Click Parent-Child Relationship on the Asset Transactions menu page.	Access the Parent-Child Relationship folder to review parent-child relationships.
Create Parent	Click Create Parent on the Parent-Child Relationship page.	Access the Create Parent page to create umbrella parent asset; description only asset.
Parent-Child Basic Information	Click Parent-Child Basic Information on the Parent-Child Relationship page.	Access the Parent-Child Basic Information page to enter and update basic physical and financial data for parent or child assets.
Review Parent-Child	Click Review Parent-Child on the Parent-Child Relationship page.	Access the Review Parent-Child page to review parent assets and the associated child asset information.

Page Name	Navigation	Usage
Review Parent-Child NBV	Click Review Parent-Child NBV on the Parent-Child Relationship page.	Access the Review Parent-Child NBV page to view parent-child net book value; select and deselect included children.
InterUnit Parent-Child Trans	Click InterUnit Parent-Child Trans on the Parent-Child Relationship page.	Access the InterUnit Parent-Child Trans page to run the process for interunit parent-child transfers.
Capital Acquisition Planning	Click Capital Acquisition Planning on the Asset Transactions menu page.	Access the Capital Acquisition Planning folder to create and administer Capital Acquisition Plans (CAP).
Create (CAP) Plan	Click Create (CAP) Plan on the Capital Acquisition Planning page.	Access the Create (CAP) Plan page to define and update capital acquisition plans (CAP).
Load Budgeting Asset Catalog	Click Load Budgeting Asset Catalog on the Capital Acquisition Planning page.	Access the Load Budgeting Asset Catalog page to load the budgeting asset catalog.
Send to Budgeting	Click Send to Budgeting on the Capital Acquisition Planning page.	Access the Send to Budgeting page to configure the interface for PeopleSoft Budgeting.
Run Report	Click Run Report on the Capital Acquisition Planning page.	Access the Run Report page to create capital acquisition plan (CAP) reports.
Financial Transactions	Click Financial Transactions on the Asset Transactions menu page.	Access the Financial Transactions folder to perform financial asset maintenance transactions like adjustments and transfers.
Cost Adjust/Transfer Asset	Click Cost Adjust/Transfer Asset on the Financial Transactions page.	Access the Cost Adjust/Transfer Asset page to perform cost additions/ adjustments, transfers, recategorizations, revaluations, markups, and interunit transfers.
CGU Impairment	Click CGU Impairment on the Financial Transactions page.	Access the CGU Impairment page to process CGU impairments.
Impairment WorkSheet	Click Impairment Worksheet on the Financial Transactions page.	Access the Impairment Worksheet page to process impairments.
Revaluation WorkSheet	Click Revaluation Worksheet on the Financial Transactions page.	Access the Revaluation Worksheet page to revalue assets using different methods.

Page Name	Navigation	Usage
Fair Value	Click Fair Value on the Financial Transactions page.	Access the Fair Value page to assign the fair value for individual assets.
Revaluation en Masse	Click Revaluation en Masse on the Financial Transactions page.	Access the Revaluation en Masse page to collectively revalue assets.
Change/Delete Pending Trans	Click Change/Delete Pending Trans on the Financial Transactions page.	Access the Change/Delete Pending Trans page to update transactions in the Pending Transaction table before running depreciation processing.
Cost Summarization	Click Cost Summarization on the Financial Transactions page.	Access the Cost Summarization page to process cost summarization.
Update Non-Capitalized Cost	Click Update Non-Capitalized Cost Asset on the Financial Transactions page.	Access the Update Non-Capitalized Cost page to update non capitalized cost.
Cap Threshold Validation	Click Cap Threshold Validation on the Financial Transactions page.	Access the Capitalization Threshold Validation page to check if an asset still belongs to the appropriate capitalization category after upcoming adjustments.
Capitalization Summary Report	Click Capitalization Summary Report on the Financial Transactions page.	Access the Capitalization Summary Report page to review trackable assets originated due to the threshold limit.
Asset Disposal	Click Asset Disposal on the Asset Transactions menu page.	Access the Asset Disposal folder to dispose of assets.
Retire/Reinstate Asset	Click Retire/Reinstate Asset on the Asset Disposal page.	Access the Retire/Reinstate Asset page to retire and reinstate financial assets.
Disposal Worksheet	Click Disposal Worksheet on the Asset Disposal page.	Access the Disposal Worksheet page to submit selected assets for disposal.
Approve Disposals	Click Approve Disposals on the Asset Disposal page.	Access the Approve Disposals page to approve pending asset disposal requests.
Auto-Retire Fully Depr Assets	Click Auto-Retire Fully Depr Assets on the Asset Disposal page.	Access the Auto-Retire Fully Depr Assets page to define auto-retire criteria to collectively retire fully depreciated assets.
Retire/Reinstate Non-Fin Asset	Click Retire/Reinstate Non-Fin Asset on the Asset Disposal page.	Access the Retire/Reinstate Non-Fin Asset page to retire and reinstate nonfinancial assets.

Page Name	Navigation	Usage
History	Click History on the Asset Transactions page.	Access the History folder to review book and cost history.
Review Book	Click Review Book on the History page.	Access the Review Book page to review book change history.
View Parent Component	Click View Parent Component on the History page.	Access the View Parent Component to view the Parent component.
Review Cost	Click Review Cost on the History page.	Access the Review Cost page to review capitalized and non capitalized asset cost transactions.
Review Inflation	Click Review Inflation on the History page.	Access the Review Inflation page to review asset inflation history.
Archive Cost/Depreciation	Click Archive Cost/Depreciation on the History page.	Access the Archive Cost/Depreciation page to archive asset cost and depreciation information from production tables.
Restore Cost/Depreciation	Click Restore Cost/Depreciation on the History page.	Access the Restore Cost/Depreciation page to restore archived asset cost and depreciation data to production tables.
Depreciation	Click Depreciation on the Asset Management menu page	Access the Depreciation folder to process and review regular and group asset depreciation.
Open Transactions	Click Open Transactions on the Depreciation page.	Access the Open Transactions page to create, review, and purge open transaction data.
Processing	Click Processing on the Depreciation page.	Access the Processing page to calculate depreciation and run depreciation-related processes.
Group Asset Depreciation	Click Group Asset Depreciation on the Depreciation page.	Access the Group Asset Depreciation page to consolidate, apply, and calculate group asset depreciation.
What-If Scenarios	Click What-If Scenarios on the Depreciation page.	Access the What-If Scenarios page to request and review what-if depreciation scenarios.
Review Depreciation Info	Click Review Depreciation Info on the Depreciation page.	Access the Review Depreciation Info page to review depreciation information.

Page Name	Navigation	Usage
Depreciation Process Log	Click Depreciation Process Log on the Depreciation page.	Access the Depreciation Process Log page to review depreciation processing results for errors.
Accounting Entries	Click Accounting Entries on the Asset Management menu page.	Access the Accounting Entries folder to process and close accounting activities.
Create Accounting Entries	Click Create Accounting Entries on the Accounting Entries page.	Access the Create Accounting Entries page to create asset accounting entries.
Close Depreciation	Click Close Depreciation on the Accounting Entries page.	Access the Close Depreciation page to close period depreciation by generating accounting entries for the ledger.
Review Financial Entries	Click Review Financial Entries on the Accounting Entries page.	Access the Review Financial Entries page to review accounting entries.
Review Operating Leases	Click Review Operating Leases on the Accounting Entries page.	Access the Review Operating Leases page to review accounting entries for operating leases.
Close Accounting Period	Click Close Accounting Period on the Accounting Entries page.	Access the Close Accounting Period page to close an accounting period to prevent accounting entries in that period.
Review Asset Journals	Click Review Asset Journals on the Accounting Entries page.	Access the Review Asset Journals page to review asset journal information.
Calculate Inflation	Click Calculate Inflation on the Accounting Entries page.	Access the Calculate Inflation page to run the process to calculate inflation amounts for assets.
Revalue AUS	Click Revalue AUS on the Accounting Entries page.	Access the Revalue AUS page to revalue assets (Australia).
Review Expense Entries	Click Review Expense Entries on the Accounting Entries page.	Access the Review Expense Entries page to display accounts created by the Clearing Reconciliation process .
Allocate Depreciation Expense	Click Cost and Depreciation Summary on the Accounting Entries page.	Access the Allocate Depreciation Expense component to allocate depreciation expense.
Financial Reports	Click Financial Reports on the Asset Management menu page.	Access the Financial Reports folder to produce reports and load reporting tables.

Page Name	Navigation	Usage
Cost and Depreciation Summary	Click Cost and Depreciation Summary on the Financial Reports page.	Access the Cost and Depreciation Summary page to review summarized depreciation activity, cost activity, and net book value.
Load Reporting Tables	Click Load Reporting Tables on the Financial Reports page.	Access the Load Reporting Tables folder to load PeopleSoft Asset Management reporting tables.
Asset Details	Click Asset Details on the Financial Reports page.	Access the Asset Details folder to create asset information reports.
Leased Assets	Click Leased Assets on the Financial Reports page.	Access the Leased Assets folder to create lease asset reports.
Accounting Entries	Click Accounting Entries on the Financial Reports page.	Access the Accounting Entries folder to generate account activity summaries, alternate account activity, reverse and reserve amounts, and statutory reports.
Cost and Depreciation	Click Cost and Depreciation on the Financial Reports page.	Access the Cost and Depreciation folder to create asset depreciation reports.
Retirement	Click Retirement on the Financial Reports page.	Access the Retirement folder to create asset retirement reports.
Generate AM Charts	Click Generate AM Charts on the Financial Reports page.	Access the Generate AM Charts folder to generate PeopleSoft Asset Management charts.
Send/Receive Information	Click Send/Receive Information on the Asset Management menu.	Access the Send/Receive Information folder to send and receive PeopleSoft Asset Management data and transactions.
Preview AP/PO Information	Click Preview AP/PO Information on the Send/Receive Information page.	Access the Preview AP/PO Information page to review the PeopleSoft Purchasing/Payables interface tables.
Retrieve Info from AP/PO	Click Retrieve Info from AP/PO on the Send/Receive Information page.	Access the Retrieve Info from AP/PO page to run preinterface tables into the transaction loader.
Interface Transactions	Click Interface Transactions on the Send/Receive Information page.	Access the Interface Transactions folder to review and edit interface table transactions.

Page Name	Navigation	Usage
Review	Click Review on the Interface Transactions page.	Access the Review page to view data in the interface tables.
Consolidate	Click Consolidate on the Interface Transactions page.	Access the Consolidate page to consolidate assets.
Unitize	Click Unitize on the Interface Transactions page.	Access the Unitize page to unitize (divide a load line into many) assets.
Edit	Click Edit on the Interface Transactions page.	Access the Edit page to run the Transaction Edit process.
Approve	Click Approve on the Interface Transactions page.	Access the Approve page to view and approve interface transaction data.
Load into AM	Click Load into AM on the Interface Transactions page.	Access the Load into AM page to run the Transaction Loader process.
Load Interface	Click Load Interface on the Send/Receive Information page.	Access the Load Interface folder to send data to and receive data from PeopleSoft Asset Management tables.
Import Data via Spreadsheet	Click Import Data via Spreadsheet on the Send/Receive Information page.	Access the Import Data via Spreadsheet folder to import new assets from a spreadsheet using a Component Interface utility.
Approve Lease Information	Click Approve Lease Information on the Send/Receive Information page.	Access the Approve Lease Information folder to review and approve lease interface table transactions.
Computer Aided Facility Mgmt	Click Computer Aided Facility Mgmt on the Send/Receive Information page.	Access the Computer Aided Facility Mgmt folder to integrate department, property, and employee information.
Taxes	Click Taxes on the Asset Management menu.	Access the Taxes folder to process and produce tax reports.
Update CCA	Click Update CCA on the Taxes page.	Access the Update CCA folder to update capital cost allowance balances.
Calculate Local Taxes	Click Calculate Local Taxes on the Taxes page.	Access the Calculate Local Taxes folder to update local tax information in local tax returns (Japan).

Page Name	Navigation	Usage
Depreciation	Click Depreciation on the Taxes page.	Access the Depreciation folder to calculate and update tax balances (India).
Reports	Click Reports on the Taxes page.	Access the Reports folder to create tax-related asset reports.
Asset Property Tax	Click Asset Property Tax on the Taxes page.	Access the Asset Property Tax page to enter asset property taxes.
Service and Maintenance	Click Service and Maintenance on the Asset Management menu.	Access the Service and Maintenance folder to create and maintain insurance and service/repair information.
Asset Insurance	Click Asset Insurance on the Service and Maintenance page.	Access the Asset Insurance page to define asset insurance information.
Asset Warranties	Click Asset Warranties on the Service and Maintenance page.	Access the Asset Warranties page to maintain asset warranty and service coverage information.
Maintenance Contract Terms	Click Maintenance Contract Terms on the Service and Maintenance page.	Access the Maintenance Contract Terms page to enter or update terms and coverage in maintenance contracts.
Review Maintenance History	Click Review Maintenance History on the Service and Maintenance page.	Access the Review Maintenance History page to review maintenance history.
Track Service and Repairs	Click Track Service and Repairs on the Service and Maintenance page.	Access the Track Service and Repairs page to enter or update asset service and repair information.
Asset Inspection	Click Asset Inspection on the Service and Maintenance page.	Access the Asset Inspection page to maintain asset inspection, cost, and coverage information.
Asset Checkout	Click Asset Checkout on the Service and Maintenance page.	Access the Asset Checkout page to check out assets for service and repair.
Asset Meter Information	Click Asset Meter Information on the Service and Maintenance page.	Access the Asset Meter Information folder to enter and update asset meter reading and to review meter reading history.
Reports	Click Reports on the Service and Maintenance page.	Access the Reports folder to create warranties and license information reports.

Page Name	Navigation	Usage
Physical Inventory	Click Physical Inventory on the Asset Management menu.	Access the Physical Inventory folder to access asset physical inventory processing.
Create Schedules	Click Create Schedules on the Physical Inventory page.	Access the Create Schedules page to create a physical inventory schedule.
Define Inventory Occurrence	Click Define Inventory Occurrence on the Physical Inventory page.	Access the Define Inventory Occurrence page to establish physical inventory (PI) control ID and default PI asset transactions.
Load/Match/Reconcile PI Info	Click Load/Match/Reconcile PI Info on the Physical Inventory page.	Access the Load/Match/Reconcile PI Info page to export or import asset data to or from a bar code scanning device.
Process CSV Files	Click Process CSV Files on the Physical Inventory page.	Access the Process CSV Files page to create a comma-separated values (CSV) file.
Verify Duplicate Tags	Click Verify Duplicate Tags on the Physical Inventory page.	Access the Verify Duplicate Tags page to identify duplicate asset tags scanned by physical inventory counts.
Verify Duplicate Serial ID	Click Verify Duplicate Serial ID on the Physical Inventory page.	Access the Verify Duplicate Serial ID page to identify duplicate asset tags scanned during physical inventory counts.
Verify Scanned Data	Click Verify Scanned Data on the Physical Inventory page.	Access the Verify Scanned Data page to enter search criteria for physical inventory.
Review Matching Results	Click Review Matching Results on the Physical Inventory page.	Access the Review Matching Results page to review discrepancies between asset data and scanned physical inventory data.
Review Inventory History	Click Review Inventory History on the Physical Inventory page.	Access the Review Inventory History page to review assets' physical inventory history.
Review Extracted Data	Click Review Extracted Data on the Physical Inventory page.	Access the Review Extracted Data page to review asset extract information.
Run Physical Inventory Reports	Click Run Physical Inventory Reports on the Physical Inventory page.	Access the Run Physical Inventory Reports page to create the Physical Inventory report.

<i>Page Name</i>	<i>Navigation</i>	<i>Usage</i>
Print an Asset	Click Print an Asset on the Asset Management menu page.	Access the Print an Asset page to print asset detail information.
Search for an Asset	Click Search for an Asset on the Asset Management menu page.	Access the Search for an Asset page to locate an asset and view with drill down detail functions.
Asset Definitions Center	Click Asset Definitions Center on the Asset Management menu.	Access the Asset Definitions Center folder to administer asset setup and configuration.

Related Links

[PeopleSoft Asset Management Overview](#)

“Pages Used to Navigate in Asset Lifecycle Management” (Asset Lifecycle Management Fundamentals)

Using the Fluid User Interface to Access Frequently Used Asset Management Pages

Page Used to Access Frequently Used Asset Management Pages

<i>Page Name</i>	<i>Definition Name</i>	<i>Usage</i>
Asset Management Tile	EP_ASSET_MANAGEMENT_FL_GBL	Access a collection of frequently used Asset Management components from a single location.

Asset Management Tile

Asset Management administrators use the Asset Management tile to access a collection of Asset Management components.

Navigation:

Fluid Home > Asset Management(You can add the Asset Management tile to the Fluid home page using the Personalize HomePage function).

This example illustrates the Asset Management tile for the tablet.



Asset Management Page

Click the Asset Management tile to access the Asset Management navigation collection.

This example illustrates the Asset Management page for the tablet.

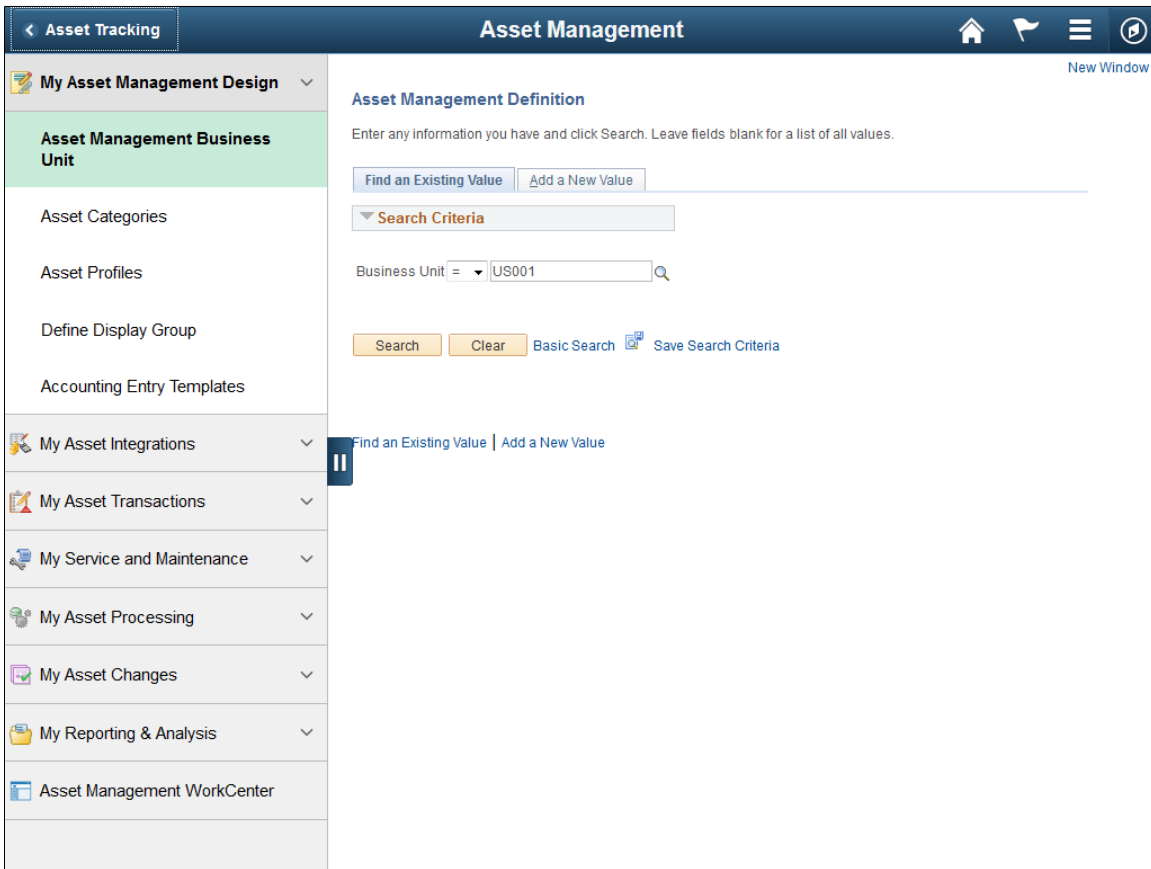

This example illustrates the Asset Management page for the smartphone.

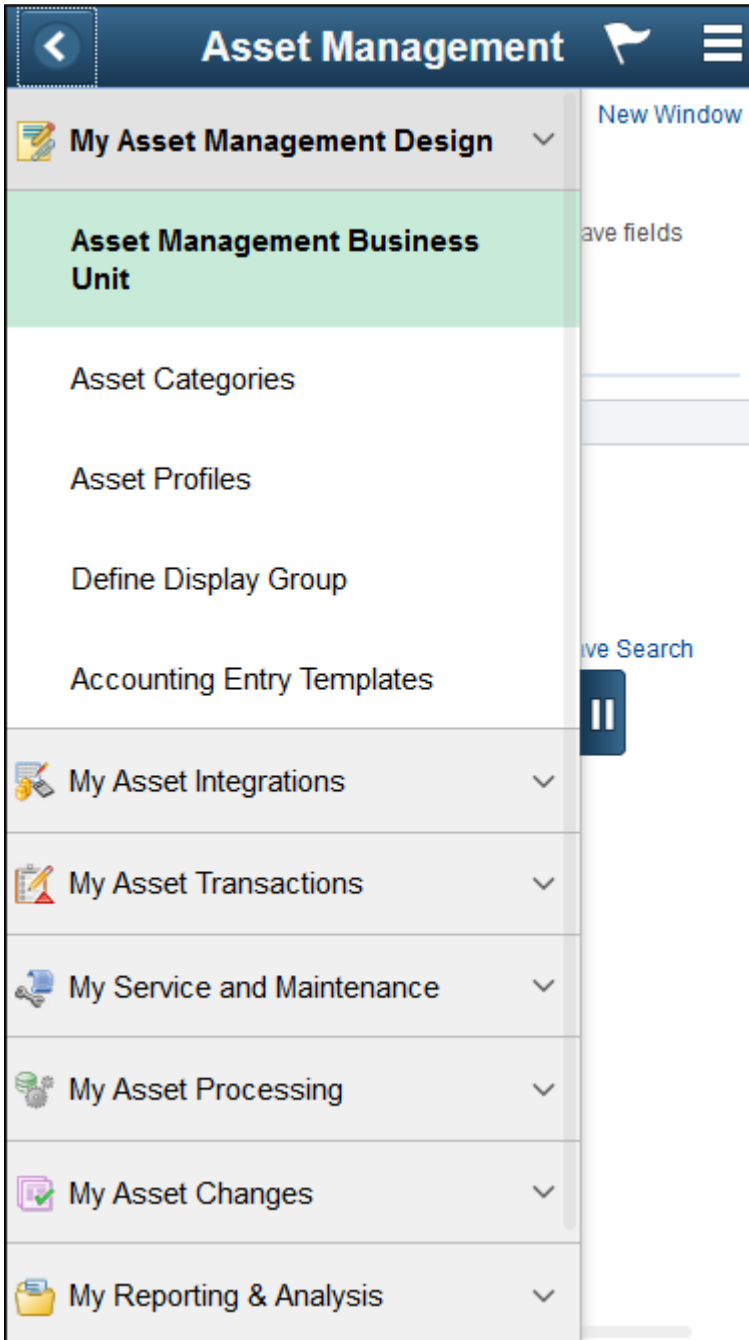

This navigation collection enables administrators to access frequently used Asset Management components from a single location. The left panel of this page lists the components collected under eight categories:

- My Asset Management Design
- My Asset Integrations
- My Asset Transactions
- My Service and Maintenance

- My Asset Processing
- My Asset Changes
- My Reporting and Analysis
- Asset Management WorkCenter

The right panel displays the component selected in the left panel.

Chapter 4

Implementing Asset Management

Understanding Asset Management

PeopleSoft provides a set of documentation components that complement each other to present all the information you need to implement Asset Management. Before you do, it is helpful to understand the various elements used in tandem with Asset Management.

Asset Management is the core financial product of the PeopleSoft Asset Lifecycle Management (ALM) Solution. The other products that compose the ALM product suite are:

- PeopleSoft IT Asset Management.
- PeopleSoft Maintenance Management.
- PeopleSoft Lease Administration.

The Asset Repository Manager (ARM) is the central feature used in common by these products. The asset repository is essentially the asset database, the core of asset processing. From the asset repository, assets are made available to other products in pursuance of their respective business processes.

See “Understanding the Asset Repository” (Asset Lifecycle Management Fundamentals).

The products included in the ALM product suite also integrate directly with PeopleSoft Human Capital Management.

Finally, Asset Management integrates with other Financials and Supply Chain Management products, including:

- PeopleSoft Billing.
- PeopleSoft Budgeting.
- PeopleSoft General Ledger.
- PeopleSoft Project Costing.
- PeopleSoft Payables.
- PeopleSoft Purchasing.
- PeopleSoft Strategic Sourcing.

Understanding the Asset Management Implementation Process

To implement Asset Management, you will find the information required to set up the tables and options used by Asset Management and the other ALM products in the following resources:

- PeopleSoft Application Fundamentals .
- PeopleSoft Asset Lifecycle Management Fundamentals
- PeopleSoft IT Asset Management
- PeopleSoft Maintenance Management
- PeopleSoft Lease Administration

Because the information you may need to fully implement Asset Management involves more than one PeopleSoft product, you need to refer to the *Getting Started* topic in the product documentation for each product for specific implementation and integration information.

Use the *PeopleSoft Application Fundamentals* to find detailed information about the following functionality and processes:

- Defining Financials and Supply Chain Management common definitions.
- Setting installation options for PeopleSoft applications.
- Defining user preferences.
- Securing your system.
- Defining and using ChartFields.
- Editing ChartField combinations.
- Configuring ChartFields.
- Summarizing ChartFields using trees.
- Using entry events.
- Using alternate accounts.
- Defining accounting calendars.
- Setting up ledgers.
- Using journal generator.
- Using interunit and intraunit accounting and ChartField inheritance.
- Processing allocations.
- Setting up on-demand processing.

Use the *Asset Lifecycle Management Fundamentals* to find detailed information about the following functionality and processes:

- Establishing asset business units and cash generating units
- Establishing asset processing, including defining asset attributes, profiles, ownership and reporting options.
- Setting up accounting entry and financial processing.

- Setting up depreciation processing.
- Setting up tax processing and tax reporting.
- Integrating with other products.
- Using delivered workflows for assets.
- Configuring background processing for assets.
- Working with the Loader Table Data Dictionary.

See the product documentation for:

- *PeopleSoft Application Fundamentals*
- *PeopleSoft Global Options and Reports*
- *PeopleSoft Asset Lifecycle Management Fundamentals*
- *PeopleSoft IT Asset Management*
- *PeopleSoft Maintenance Management*
- *PeopleSoft Lease Administration*
- *PeopleSoft Financials, Enterprise Service Automation, Asset Lifecycle Management Portal Packs*
- *PeopleSoft Billing*
- *PeopleSoft General Ledger*
- *PeopleSoft Payables*
- *PeopleSoft Project Costing*
- *PeopleSoft Purchasing*
- *PeopleSoft Strategic Sourcing*

Converting to PeopleSoft Asset Management

Understanding Conversion to PeopleSoft Asset Management

You can convert data using any number of methods that are available to you. You may want to generate a custom program after mapping records and fields from the existing database to the new PeopleSoft database; or you can perform the steps that are outlined in this topic, using the application engine processes that are available from Oracle to convert the data.

The general tasks are:

1. Set up the database tables that will store accounting structure and asset information.
2. Transfer data from the existing system to PeopleSoft Asset Management.

No strict rules exist for performing these tasks. The pace and flow of the implementation will be guided by the requirements of your business environment, available personnel resources, and any unexpected events that you may encounter during the process.

If you use the PeopleSoft application engine processes that are described in this topic to convert your data, Asset Management business units and books must be established before you transfer data into the loader tables. The sequence of other table setups are more flexible. You may want to partially complete the conversion before doing some table setup. For example, as you set up the Location table, you can refer to the record layout from your conversion file to determine how many different locations you need to establish and what they should be called. In general, however, you should complete the table setup that provides your system structure to begin building your asset management database. Your table setup must be complete before you can finish converting your asset data. The final conversion step, depreciating converted assets, cannot be carried out until all PeopleSoft Asset Management tables are set up. Setting up the database tables that provide your accounting structure and store asset information is discussed in other topics. Please refer to these for more details of the tasks involved.

Data validation is an important step as you plan and implement the conversion. Before you begin converting asset data from the current system, look closely at the existing data. Depending on the integrity of the source data, your first step should be to validate the existing data before you begin converting. At various intervals of the data conversion process, you will have the opportunity to examine the data. Create checks and balances as part of your conversion plan to test data that is being loaded into the PeopleSoft database.

Note: The Excel to CI PeopleTools spreadsheet utility enables you to use a PeopleSoft Asset Management template to upload asset data from another source to the PeopleSoft database. *You should not plan to use this utility to convert your initial database.* This utility is designed to assist in situations in which manual data entry would be tedious. Because the Excel to CI utility is limited to importing 65K rows of data at a time, large volumes of data cannot be uploaded. Because this utility has no automatic error checking, you should carefully review all rows of data being uploaded and correct any problems as you discover them. Finally, the Asset Management template that is used for Excel to CI does not populate the INTFC_PHY_B tables. Data uploaded by this method may require additional manual data entry. Given these constraints, using the Excel to CI utility to convert legacy data to new PeopleSoft records is not recommended.

Related Links

[Understanding the Loader Tables](#)

Prerequisites

Before proceeding with the data conversion, you must set up your business units and tables.

PeopleSoft strongly recommends that you add and depreciate some assets online *before* beginning the conversion process.

Performing these actions is a good test of your table setup. They enable you to test your Asset Profiles to ensure that they are working the way you intended, and you can see how the depreciation program works and how it is affected by different variables and conventions. Knowing what to expect from the PeopleSoft Asset Management application before you begin the conversion will assist you in making decisions for planning and carrying out the conversion.

Converting with a Customized SQR

To transfer data from an existing system into PeopleSoft Asset Management loader tables, you can write a custom SQR and use the delivered Asset Management application engines in this way:

1. Write and run a program that transfers data from the existing system into the Asset Management loader tables.

The following table describes the interim tables in Asset Management:

Table	Description
INTFC_FIN	Contains financial asset data.
INTFC_PHY_A	Contains physical asset data.
INTFC_PHY_B	Contains physical asset data.

Note: When writing this SQR, note that for load types of CN1 that use NEXT in the **ASSET_ID** field, each load line should have a unique INTFC_ID. This unique value ensures that Asset IDs are generated correctly. In all other cases, you should use one INTFC_ID for each set of transactions with the same load type.

Note: The sample conversion program, AMCV1000.SQR, and its SQC links are not supported.

2. Run the Transaction Edit program (AMIFEDIT) to perform edit checks on the specified data fields to ensure that the information you load into PeopleSoft Asset Management is correct. The data fields that are edited include ChartFields, business units, and books.
3. Preview and approve data in the loader tables.

Use the Financials Transactions page, Physical Transactions A page, and Physical Transactions B page to see which data was loaded into the loader tables.

4. Use the Transaction Loader process (AMIF1000) to transfer information from the loader tables into your Asset Management tables.

This process reads data in the INTFC_FIN, INTFC_PHY_A and INTFC_PHY_B tables and then populates the Asset Management tables with the asset data. This data appears in Asset Management as open transactions.

The AMIF1000 process has two options for populating open transaction accounting and transaction date fields with respect to how costs and accumulated depreciation are loaded. Search for RJS2-34 in AMIF1000 and choose the option that matches your business needs before running the program.

See [Using Transaction Loader Conversion Dates Options](#).

5. Convert and depreciate the assets.

Note: When converting data from another system to PeopleSoft Asset Management, you should convert data as of the period *before* you want the system effective. You should calculate depreciation as of the *first period* that the system is effective.

For example, if you want the system to be effective on January 1, 2006, you should convert all your data as of December 31, 2005. The fiscal year, START_PD, and END_PD on the depreciation table should be 2005, 12, 12. The TRANS_DT and DTTM_STAMP should be December 31, 2005. However, you should calculate depreciation with OPEN_TRANS accounting and transaction dates of January 1, 2006.

The following diagram shows the Asset conversion process:

Asset conversion process

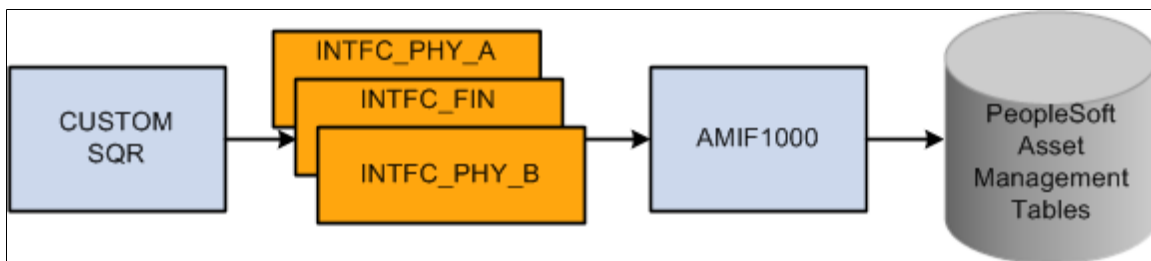

See also *PeopleSoft Asset Management*, “Understanding the Loader Table Data Dictionary”.

Running the Transaction Loader Edit Program

Before running the Transaction Loader (AMIF1000) program, you must run the Transaction Loader Edit (AMIFEDIT) program to check for valid values. The Transaction Loader Edit program edits the fields you specify, validates values, and marks those values that are in error. Using one or both of two available queries, you can check the results and view messages for those fields that are in error. This process helps ensure that the data is correct when it is entered by the Transaction Loader into PeopleSoft Asset Management tables.

Pages Used to Run the Transaction Loader Edit Program

<i>Page Name</i>	<i>Definition Name</i>	<i>Usage</i>
Edit Page	RUN_AMIFEDIT1	Run the Transaction Edit program.
BU Book Chartfields Summarize Page	AMIFEDIT_CF_SEC	Select ChartField summary options for the transaction loader edit process. See Edit Page

Edit Page

Use the Edit page (RUN_AMIFEDIT1) to run the Transaction Edit program.

Navigation:

Asset Management > Send/Receive Information > Interface Transactions > Transaction Loader Edit

This example illustrates the fields and controls on the Edit page. You can find definitions for the fields and controls later on this page.

Interface Edit Options

Select all the fields on which you want to perform the edit valuation. Deselect those fields that will have no values because you do not use the field (that is, optional fields **Category** and **Tax Class**).

Note: The default condition is to run edit checks on all of these fields. They are all selected when you first display the page. To prevent an edit check on a particular field, deselect that check box.

Find Trans Load ID (transaction load ID)

<i>Field or Control</i>	<i>Description</i>
System Source	Generates the transactions that you want to edit.
Load Type	A more detailed version of Trans Type . One trans type can generate several different load types.

Note: Whenever you rerun the Transaction Edit program, old message files from the previous run are deleted.

Viewing the Results of the Transaction Edit Program

To view results from the Transaction Edit program, run the following two queries:

- AM_INTFC_PHY_A_MSG (Interface Physical A Edit Messages) to see physical records.

- `AM_INTFC_FIN_MSG` (Interface Financial Edit Messages) to see financial records.

Previewing and Approving Results

After the asset data is in the loader tables, you will need to verify that the information in the loader tables is correct and approve all the load lines that you want to load into PeopleSoft Asset Management. This review and approval process is designed to prevent you from inadvertently loading massive amounts of invalid data into the system.

Use the Review page to see which data was loaded into the financial and physical interface tables. The Approve page allows the user to review and approve the interface transaction data.

Related Links

[Verifying Data in the Loader Tables](#)

[Approving Changes](#)

Populating Asset Management Tables with Asset Data

This data conversion step populates PeopleSoft Asset Management database tables with the data that you just loaded into `INTFC_FIN`, `INTFC_PHY_A`, and `INTFC_PHY_B` by running the Transaction Loader Application Engine, `AMIF1000`.

The Transaction Loader is also used for mass transactions. After performing a mass change, run this Application Engine to create entries in Asset Management tables.

Note: You must run the Transaction Edit program (`AMIFEDIT`) before running the Transaction Loader, especially at conversion time. The Transaction Edit program performs edit checks on the data fields that you specify to help ensure that the information you load into PeopleSoft Asset Management is correct. Review the data that is loaded into `INTFC_FIN`, `INTFC_PHY_A`, and `INTFC_PHY_B` and look carefully at the Transaction Loader Application Engine (`AMIF1000`) before you run it. You may need to change some of the data defaults that it contains.

Related Links

“Running the Transaction Loader” (Asset Lifecycle Management Fundamentals)

Using Transaction Loader Conversion Dates Options

At conversion, you have two options when you use the Transaction Loader to populate open transaction accounting and transaction dates:

- Make the open transaction accounting and transaction dates the first day of the following period of the specified accounting date.
- Make the open transaction accounting and transaction date the same as the date that is specified in the Financial Interface table (`INTFC_FIN`).

First Day of the Following Accounting Period

To populate the open transaction accounting and transaction dates with the first day of the following accounting period, perform these steps.

1. Sign in to the Application Design.
2. Open Application Engine AMIF_FIN_PHY.
3. Scroll down to section 200120 and click the plus sign to expand the section.
4. Make sure that Step 100 and Step 120 are *Inactive* and Step 130 is *Active*.

Populate Dates as Specified in INTFC_FIN

To populate the open transaction accounting and transaction dates with the date that is specified in the INTFC_FIN table, perform these steps:

1. Sign in to the Application Design.
2. Open Application Engine AMIF_FIN_PHY.
3. Scroll down to section 200120 and click the plus sign to expand the section.
4. Make sure that Step 100 and Step 120 are *Active* and Step 130 is *Inactive*.

Depreciating Converted Assets

The final step in converting to PeopleSoft Asset Management is to process all the open transactions that were created by the Transaction Loader. You will run the programs to:

- Calculate depreciation (AM_DEPR_CALC).
- Create accounting entries (AM_AMAEDIST).
- Close depreciation (AM_DPCLOSE).

Note: When converting data from the current system to PeopleSoft Asset Management, you should convert data as of the period *before* you want the system effective. You should calculate depreciation as of the *first period* that the system is effective.

For example, if you want the system to be effective on 01/01/06, you should convert all of the data as of 12/31/05. The fiscal year, **START_PD** and **END_PD** on the depreciation table, should be 2005, 12, 12, respectively. The **TRANS_DT** and **DTTM_STAMP** should be 12/31/05. However, you should calculate depreciation with **OPEN_TRANS** accounting and transaction dates of 01/01/06.

For converted assets and assets that are loaded through the Transaction Loader, the default is to book accumulated depreciation to the *previous* period. However, any accumulated depreciation is booked to the *current* period:

1. If you populate the **START_PD**, **END_PD** and **FISCAL_YEAR** fields in the Financial Loader table (INTFC_FIN) with values for the current period.

2. If the amount in the **DEPR** field is not 0.

Closing the Conversion Process

At this point, the conversion has created all the data in the system, and all assets are depreciated. Before you can move into full production, you must now close the conversion process by completing these steps:

- Verify the conversion to approve conversion results.
- Restore disk space by removing unnecessary tables from the system.
- Update security to restrict access to the conversion SQRs now that they are no longer needed.

Page Used to Close the Conversion Process

<i>Page Name</i>	<i>Definition Name</i>	<i>Usage</i>
<u>Receive Conversion Data Page</u>	RUN_AMCV2000	Run the Interface Loader program to delete data from the loader tables.

Verifying the Conversion

You must run implementation checks to make sure that all the calculations used the correct values, followed the methods that you intended, and so forth. By balancing the conversion, you verify that the currency amounts in the system are those that you expect to see. If they are not, you need to verify your source system data and check the SQRs to determine where you might have inadvertently used the wrong depreciation method, an invalid date, or some other variable that affects calculations.

Receive Conversion Data Page

Use the Receive Conversion Data page (RUN_AMCV2000) to run the Interface Loader program to delete data from the loader tables.

Navigation:

Asset Management > Send/Receive Information > Load Interface > Receive Conversion Data > Receive Conversion Data

This example illustrates the fields and controls on the Receive Conversion Data page. You can find definitions for the fields and controls later on this page.

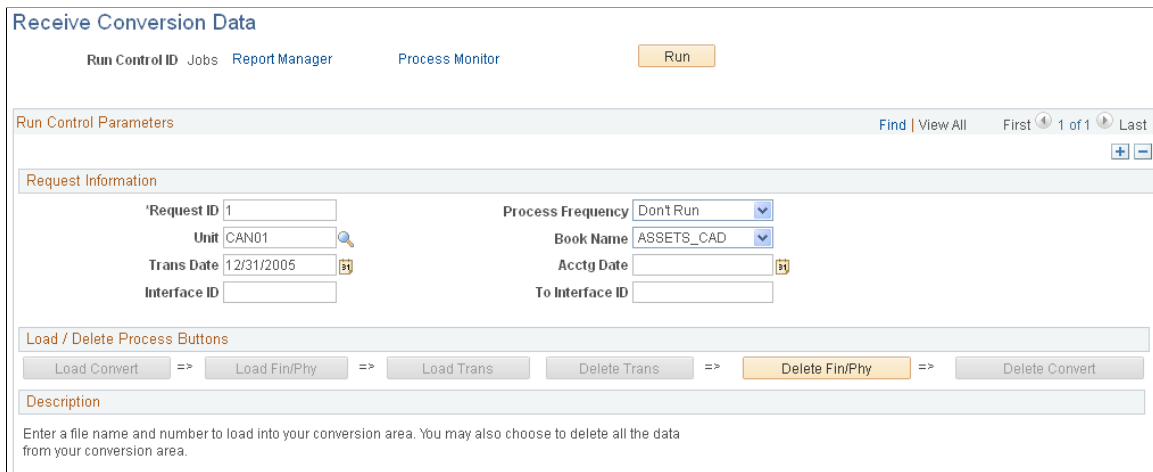

When the conversion is complete, you will want to release the disk space that is occupied by all the interim tables that you used in the process. Working backwards, you can delete data from the tables that were populated by using the Interface Loader.

Load/Delete Process Buttons

Select **Delete Fin/Phy** and run this request. Process Scheduler runs the AMCV2000 process at user-defined intervals.

Updating Security

You may want to restrict access to the Interface Loader and Transaction Loader after the conversion is completed and approved. Review the system security page settings and make changes as warranted.

See also the product documentation for *PeopleTools: Security Administration*.

Loading Retired Assets

You can add retired assets and asset history to the database. The load type *ARA* is used specifically for loading historical information for assets that are already retired.

For this load type, the Transaction Loader inserts records into the **Asset** field and, if applicable, **Asset Custodian**, **Asset Location**, **Warranty**, **Attribute**, **License**, **Comments**, **PI Asset History**, **Parent Asset**, and **Acquisition Detail** fields. It creates Book and Cost rows, as well as one row of accumulated depreciation for each book, all using the transaction type *ADD*. After modifying some of the values in **INTFC_FIN** and changing the transaction type to *RET*, the Transaction Loader inserts Cost and Retirement rows. The status of the assets is set to *D* (Disposed) for retired assets.

To load retired assets:

- Consider prerequisites for retiring assets.
- Populate loader tables.

- Review the retired asset data.

Considerations for Retiring Assets

Before loading retired assets, note these considerations:

- Assets should be fully depreciated and retired.

You can add partially retired assets, but the remaining cost basis will not be depreciated or processed in any way.

- The depreciation process (AM_DEPR_CALC) need not be run after the retired assets are loaded.
- After you add retired assets, you can reinstate them.

Note: The *ARA* interface type was designed to load fully depreciated, retired, or historical assets in cases for which AM_DEPR_CALC would never run and the assets would never be reinstated. To accommodate reinstatement of historical assets in this case, change the *ARA* interface type as needed.

Populating Loader Tables

To load retired assets using the *ARA* load type, follow these instructions to populate the loader tables:

- If you have a valid asset profile that is effective-dated correctly and the assets have the same amounts for cost, depreciation, gain/loss, and so on for each book (use the same depreciation conventions), you can load the retired assets with the **DEFAULT_PROFILE_SW** set to *Y*.

In this case, you should set **DEFAULT_PROFILE_SW** to *Y* on INTFC_FIN and INTFC_PHY_A, enter the valid profile ID in INTFC_PHY_A, and make only one entry in INTFC_FIN for each asset. Leave the **BOOK** field blank.

- *If this is not the case*, set the **DEFAULT_PROFILE_SW** to *N* and load one record for each book for each asset into INTFC_FIN. Consequently, if one asset reports to two books, you will load two records for the asset into INTFC_FIN.

Enter the accumulated depreciation into INTFC_FIN.DEPR, one entry for every ChartField combination. Each entry in INTFC_FIN corresponds to a row in PS_DEPRECIATION.

To simplify populating the load tables, one entry in INTFC_FIN is used to create both an *ADD* and a *RET* cost row for each book.

The key difference between the *ADD* and the *RET* rows is the **DTTM_STAMP**. The Transaction Loader loads the *ADD* row first, and then it increments the **DTTM_STAMP** by one day, sets the **RETIRE_SW** to *1*, and multiplies **COST** and **QUANTITY** by negative 1 (-1). It then loads this as the *RET* row.

Note that when the Transaction Loader finishes successfully, values in all the INTFC_FIN rows for *ARA* INTFC_TYPE and INTFC_ID will have changed. If you want to rerun the transaction using the same INTFC_ID entries:

- Subtract one day from **DTTM_STAMP**.
- Set **RETIRE_SW** back to *0*.
- Set the **LOAD_STATUS** to *New* (pending).

- Multiply the **COST** and **QUANTITY** by negative 1 (-1).

These actions restore the rows to their original values.

Reviewing Retired Asset Data

After you load retired assets, pay close attention to these **INTFC_FIN** fields:

INTFC_FIN Field Name	Value
DEPR	<i>Accumulated depreciation.</i>
<i>INTFC_TYPE</i>	<i>ARA.</i>
RETIREMENT_DT	The asset historical retirement date.
DTTM_STAMP	Although you can set this to any value, PeopleSoft recommends that you set it to the earliest date/time stamp used for any of the assets that you are loading. This setting will ensure that it is earlier than all the retirement dates.
RETIRE_QUANTITY	Make sure it is a negative number.
RETIREMENT_AMT	Make sure it is a negative number.
FISCAL_YEAR	Represents the fiscal year (FY) of the accumulated depreciation.
START_PD	Starting period.
END_PD	Ending period.
GAIN_LOSS	Gain or loss.
END_DEPR_DT	Ending depreciation date.
BEGIN_DEPR_DT	Beginning depreciation date.
ACTIVITY_SW	0
RETIRE_SW	0 (AMIF1000 handles the switch to 1 for the RET cost row).
RETIREMENT_RSV	Accumulated depreciation.

Also pay close attention to these **INTFC_PHY_A** fields:

INTFC_PHY_A Field Name	Value
CAPITALIZATION_SW	2
PROFILE_ID	Must be valid in PROFILE_DET_TBL if you set DEFAULT_PROFILE_SW = Y in INTFC_FIN and INTFC_PHY_A.

When using the Transaction Loader, you need not populate those fields that contain data in the PROFILE_DET_TBL if you provide a valid PROFILE_ID and set **DEFAULT_PROFILE_SW** to *Y* on both INTFC_FIN and INTFC_PHY_A.

Converting Lease Information

The interface load table INTFC_LEASE contains leased asset information for lease schedules that were already calculated. This lease interface table is used to add leases to PeopleSoft Asset Management tables using the Transaction Loader interface type *LAD* (Leased Asset Addition). The lease payment schedule information should be populated in the INTFC_LEASE table; it is not calculated by the Transaction Loader.

Before running the Transaction Loader, the INTFC_LEASE, INTFC_FIN and INTFC_PHY_A tables must be loaded with leased asset information. The new ASSET_IDs are calculated if the interface table ASSET_ID fields are set to *NEXT*. If *NEXT* ASSET_ID is used, each INTFC_LINE_NUM should represent one ASSET_ID, and the same INTFC_LINE_NUM should be used for all three interface tables.

These fields are required in INTFC_LEASE:

- **PYMNT_DT**
- **PYMNT_SCHED_ID** (Do not populate this field with *NEXT*; it will not be assigned automatically.)
- **LEASE_TERM**
- **LEASE_TYPE**
- **IMPLICIT_RATE**
- **PV_MLP**
- **CAP_LEASE_AMT**
- **LEASE_DT**
- **MRP**
- **INTEREST_EXPENSE**
- **OBLIGATION_REDUCE**
- **EST_LIFE**

These fields can have values of *zero* or *N*, or the default value from the profile (if you are using default profile switch = "Yes"):

- **FV**
- **BPO**
- **BPO_PAYMENT**
- **BORROW_RATE**
- **ACTUAL_RESIDUAL**
- **GUAR_RESIDUAL**
- **TSFR_OWNERSHIP_FLAG**
- **RENEWAL_OPTION**
- **ITC_AMT**
- **EXECUTORY_COSTS**

If LEASE_TYPE = O (Operating Lease), then DEFAULT_PROFILE_SW must equal *N*. If it is an operating lease asset, then the **BOOK** field in the LEASE_OPER record will be populated with the DEFAULT_BOOK in the BUS_UNIT_TBL_AM record.

All of the preceding fields affect the LEASE_BOOK. The INTFC_FIN.LIFE on the LEASE_BOOK should be calculated as FREQUENCY × LEASE_TERM. For example, if the PYMNT_SCHED_ID is monthly and LEASE_TERM = 24, then LIFE = 24 and ESTIMATED LIFE = 24. The preceding data is needed for lease adjustments in Asset Management.

When the INTFC_LEASE table is populated, you can use the Load Preview-Lease page to review and correct lease data before uploading to the PeopleSoft Asset Management tables.

Note: If you have migrated your Asset Management lease data into Lease Administration (per PeopleSoft's compliance with ASC 842 and IFRS 16 lease accounting standards), this topic does not apply.

Pages Used to Convert Lease Information

<i>Page Name</i>	<i>Definition Name</i>	<i>Usage</i>
Load Preview-Lease	INTFC_LEASE	Review and, if necessary, correct lease data before uploading it to PeopleSoft Asset Management tables.
Load Approval - Lease	INTFC_LEASE_APPR	Approve lease data before uploading to PeopleSoft Asset Management tables.

Load Preview - Lease Page

Use the Load Preview - Lease page (INTFC_LEASE) to review and, if necessary, correct lease data before uploading it to PeopleSoft Asset Management tables.

Navigation:

Asset Management > Send/Receive Information > Approve Lease Information > Review Lease Information

Load Approval - Lease Page

Use the Load Approval - Lease page (INTFC_LEASE_APPR) to approve lease data before uploading to PeopleSoft Asset Management tables.

Navigation:

Asset Management > Send/Receive Information > Approve Lease Information > Approve Lease Information

Chapter 6

Adding and Maintaining Assets

Understanding Adding and Maintaining Assets

PeopleSoft Asset Management stores the following types of asset information:

- *Financial information* includes details about cost, books, depreciation method and convention, and useful life.
- *Physical information* includes asset tag numbers, specifications, location, custodian, and manufacturer.

Oracle's PeopleSoft Asset Lifecycle Management (ALM) solution provides complete access to the entire asset portfolio, regardless of asset class, and featuring visibility into total cost of ownership by enabling cost tracking associated with acquisition as well as lifetime maintenance and performance.

Working with other products within the PeopleSoft ALM solution, including PeopleSoft IT Asset Management, PeopleSoft Maintenance Management, and PeopleSoft Lease Administration, PeopleSoft Asset Management provides functionality for the complete *plan to retire* business process, from the initial planning and acquisition of assets to the end-of-life disposal of assets.

PeopleSoft Asset Management provides a common Asset Repository Manager (ARM), accessible to all PeopleSoft ALM products and other PeopleSoft integrated products, which stores all asset data. The repository provides a single source for all physical, financial, or operational asset data.

Adding Assets

After you establish PeopleSoft Asset Management foundation tables, you can add assets. This section discusses the different ways to add assets. The approach that you use depends on the needs of your organization and how much information is available when the assets are added.

To add assets, you can:

- Use **Express Add** to add assets using an asset profile for default book and depreciation information.

When assets are capitalized, most of the critical information is derived from the asset profile by default, and detailed physical information can be entered later.

- Use **Basic Add** when much of the physical information is readily available at the start.

You can capitalize the asset immediately or later using the appropriate asset profile.

- Use **Define Asset Operational Info** to add nonfinancial assets.
- Use the **Import Data via Spreadsheet** component to enter asset transaction data offline using a spreadsheet application and then import the data into Asset Management tables.

- Use **Excel to CI** to add assets by uploading asset information from PeopleSoft's integrated Excel spreadsheet component interface.

This process enables you to add multiple assets to generate PeopleSoft-formatted data from a predefined Excel asset template.

The PeopleSoft system enables asset receiving when you use PeopleSoft Purchasing, PeopleSoft Payables, or PeopleSoft Project Costing. You can initially add an asset with only its physical information and then capitalize the asset when you receive financial information from the invoice. Conversely, you can initially add the asset's financial information when you order it and then add the physical information once it is received; or you can enter all of the information at once.

You can also add assets through PeopleSoft Project Costing, along with all of the pertinent project information.

See “Setting Up and Using Express Capitalization” (PeopleSoft Project Costing).

PeopleSoft Asset Management allows you to use transaction currencies for multinational transactions. This enables you to maintain a base or local currency and conduct transactions with foreign entities by selecting a transaction currency for individual transactions. By establishing an exchange rate to convert the currencies, you can complete transactions in multiple currencies and convert them back to the base currency as needed.

Capitalization Thresholds

PeopleSoft Asset Management can determine the capitalization status of an asset based on its total cost or unit cost, according to limits that you define. This can be accomplished by enabling the Capitalization Threshold feature. Capitalization Threshold is an optional feature that enables the system to automatically classify assets into one of the following categories: non-capital assets, capital assets, or expenses.

See [Setting Up and Managing Capitalization Thresholds](#)

Document Sequencing

Statutory requirements in some countries require that all financial transactions (documents) be classified into different transaction types, and that within each transaction type, all documents entered be numbered sequentially. The document sequencing feature helps you maintain established business practices by meeting both of these requirements.

Document sequencing is available for transactions that you create either online or through background (batch) processing. When you activate document sequencing, the system automatically assigns a sequence number to each document (invoice, voucher, journal, and so on) that you create. You can also enter sequence numbers manually. When you delete, change, or unpost a document, the system may generate additional document sequence numbers, as appropriate.

The document sequence page (AM_DOC_SEQ) is used throughout the PeopleSoft Asset Management application where a financial transaction occurs: Express Add, Basic Add, Cost Adjustment and Transfer, Leases, Copy Assets, Adjust Accumulated Depreciation, Update/Delete Pending Transactions, Impairment, and Retirement. Each page displays a document sequencing tab for the entry and enables you to view, enter, or override document sequence information.

See “Defining Document Sequencing” (Asset Lifecycle Management Fundamentals).

Financials Audit Framework (Audit Logging)

The introduction of the Financial Audit Framework (audit logging) enables improved audits and controls for transactions related to the AM_ASSET document. You can enable Asset Management to create audit trails for events ranging from asset adds, cost adjustments and transfers, depreciation, retirements and reinstatements, interunit transfers, recategorizations, asset copy, and revaluation. You can enable audit logging for Asset Management using the Enable Audit Logging page.

See “Setting Up Financials Audit Framework (Audit Logging)” (Application Fundamentals).

Once you have enabled audit logging for Asset Management and selected the events that you want to track, you can access the audit log for a given asset by clicking the Audit Logs link on the corresponding transaction pages, such as the Basic Add - General Information page.

Component Changeout

When you integrate PeopleSoft Asset Management with PeopleSoft Maintenance Management, component changeout functionality (swapping of older or broken components for newer replacement components) is enabled. The component changeout feature enables you to manage asset component swapping when failure or replacement is required to maintain an asset. A component is replaced with a "like-component" and the characteristics and attributes of the new component are associated with the overall larger asset. A component can be removed from one asset and marked for reuse in another asset. A component can also be served by parts. PeopleSoft Asset Management enables you to maintain an equipment parts list and associate it with an asset.

The Asset Repository manages the complete setup for component changeout functionality with predefined defaulting component hierarchy, and makes this information available to the work order operator to facilitate completion of the tasks associated with component changeout transactions.

The component changeout transaction installs, replaces, removes, and disposes component assets within the Asset Repository. The process allows asset transfer and disposal transactions, which are then passed to PeopleSoft Asset Management through the Transaction Loader process.

When the option to remove assets for reuse is selected, you map the ChartField accounts to be used for the transfer by entering the information on the Warehouse Mapping page through the Transaction Loader process. When the option to replace assets is selected, the transferred assets are updated with new replacement asset information through the Transaction Loader.

Meters and Warranties

Some assets are delivered with warranties or other maintenance contracts. As well, some assets may be insured where replacement of parts or service is covered under the insurance contract. PeopleSoft Asset Management enables you to track warranty, maintenance, and insurance information associated with assets.

Some assets make use of meters to track usage for maintenance or billing purposes. Asset Management provides meter types and meter reading pages to monitor asset usage for these purposes.

See [Understanding Asset Maintenance, Repair, Warranties, and Insurance](#).

Setting Up and Managing Capitalization Thresholds

This topic provides an overview of Capitalization Thresholds and threshold validation, and describes the pages necessary to set up and manage Capitalization Thresholds.

Use the Capitalization Limits (DEPR_CAP_LIMIT) component to define and manage capitalization thresholds in PeopleSoft Asset Management.

Pages Used to Set Up and Manage Capitalization Thresholds

<i>Page Name</i>	<i>Definition Name</i>	<i>Usage</i>
<u>Capitalization Limits Page</u>	DEPR_CAP_LIMIT	Set up capitalization limit codes by business unit by book, as necessary, especially Germany.
<u>Capitalization Thresholds Page</u>	CAP_THR_DEFN	Establish capitalization thresholds by asset profile to be used in automatic classification of capital asset, non capital asset or expense asset.
<u>Capitalization Threshold Validation Page</u>	AM_CAPVAL_RQST	Run the process to validate whether an asset still meets conditions to remain in the capitalization status that it was originally catalogued upon asset addition based on the capitalization threshold process.
<u>Capitalization Threshold Summary Report Page</u>	AM_CAPSUM_RQST	Run a report to show the capitalization status of assets based upon criteria selection.

Understanding Capitalization Thresholds

PeopleSoft Asset Management can determine the capitalization status of an asset based on its total cost or unit cost, according to limits that you define. This can be accomplished by enabling the Capitalization Threshold feature. Capitalization Threshold is an optional feature that enables the system to automatically classify assets into one of the following categories: non-capital assets, capital assets, or expenses.

When setting up capitalization thresholds, you can further specify whether the threshold should be based on the asset itself or based on book. When you define capitalization threshold by asset, the capitalization status of an asset is determined using the cost parameters you define for the asset. Using this method, the asset can be classified as non-capital, capital, or expense.

When you define capitalization threshold by book, the asset will be capitalized according to the book's capitalization status. Using this method, the asset is recognized as a regular financial asset. Using the capitalization threshold by book method, an asset can be capitalized in one book (for example, your primary book) and non-capitalized in another book (for example, your secondary book).

Capitalization threshold by book is useful for tangible property management and the ‘*de minimis safe harbor*’ election defined in Treasury Department regulation 9636. For example, assume you have a policy for your primary book that requires you to capitalize all items greater than \$2500. The purchase of a piece of IT equipment for \$3000 meets the capitalization criteria, so the asset will be capitalized in your primary book. However, Treasury Department regulation 9636 enables you to expense items under \$5000. Thus, the asset will be non-capitalized in your secondary book.

With the Capitalization Threshold feature, assets are classified into one of the following categories:

- **Capital Assets** - The system generates an asset ID and stores physical and financial information. Financial information is stored in the Cost table (COST). The system also stores acquisition details. Therefore, these assets are trackable from both a physical and financial standpoint. This term is interchangeable with Financial Assets. Assets using the capitalization threshold by asset and by book method may be placed into this category.
- **Non capital Assets** - The system generates an asset ID and stores only physical information. The cost information is stored in the Non capitalized Cost table, (COST_NON_CAP). The system also stores acquisition details. Therefore, these assets are trackable from a physical standpoint only. This term is synonymous with Trackable Assets or Nonfinancial Assets.

Assets using the capitalization threshold by asset method may be placed into this category, will store physical information only and are tracked from a physical standpoint only. Assets using the capitalization threshold by book method are stored in tables normally designated as financial, but the system designates it as a physical cost, rather than financial.

- **Expense Assets** - The system does not generate an asset ID. Assets using the capitalization threshold by asset method may be placed into this category. However, assets using the capitalization threshold by book method cannot be placed into this category. If an asset is entered online that does not meet the capitalization threshold, an error message appears saying that the asset has been catalogued as an expense due to its cost amount and could not be considered as an asset. If the asset is entered in batch, the system stores a message in an audit table that explains why that interface line was not processed. Because of their low cost, these assets are considered an expense when acquired and there is no interest to track them within the Asset Repository.

Note: You can review whether costs are physical or financial using the Review Cost component.

See [Pages Used to View Cost History and Summarize Cost Rows](#)

PeopleSoft Asset Management automatically catalogues the capitalization status for batch and online asset additions, provides processes to deal with adjustments to the original cost, balances out any potential clearing account with other feeder systems, and provides reports and audit trails to facilitate control of these transactions.

Adjustment transactions (ADJ) from feeder systems are also assessed for capitalization. The adjustments are not compared individually against the capitalization threshold to assess the capitalization action; rather, they follow the existing capitalization status that is assigned when the asset is added. For example, if an asset was catalogued as trackable, all of its adjustments, regardless of costs, are treated as non-capital adjustments. Adjustments processed in conjunction with its corresponding FAD, CAP is considered for the total cost of the asset as the preferred approach. Although, if this approach had a large impact in performance, it is acceptable to process the adjustments without checking the capitalization threshold. Subsequent negative adjustments and retirements coming from other sources follow the capitalization status of the asset.

Defining and Using Capitalization Thresholds

To define and use capitalization thresholds:

1. Select the ‘Cap Threshold Processing’ option on the Installation Options - Asset Management page.
See “Installation Options - Asset Management Page” (Application Fundamentals)
2. Select the ‘Use Cap Threshold’ option on the AM Business Unit Definition page.
See “AM Business Unit Definition Page” (Asset Lifecycle Management Fundamentals)
3. Create capitalization threshold definitions using the Capitalization Thresholds page.
See [Capitalization Thresholds Page](#)

4. *For capitalization threshold by asset:* Specify the Threshold ID and related information on the Asset Profile – Definition page.

For capitalization threshold by book: Specify the Threshold ID and related information on the Asset Profile – Depreciation page.

See:

“Asset Profiles – Definition Page” (Asset Lifecycle Management Fundamentals)

“Asset Profiles - Depreciation Page” (Asset Lifecycle Management Fundamentals)

5. *For capitalization threshold by asset:* Add an asset using the Express Add – Cost/Asset Information page or the Basic Add – General Information page. If you defined threshold information for the asset profile, the asset will inherit the Threshold ID from the profile. You can override the Threshold ID if needed. If no threshold was defined for the profile, you must select an asset based threshold ID.

For capitalization threshold by book: Add an asset using the Express Add – Depreciation Information page. If you defined threshold information for the asset profile, the asset will inherit the Threshold ID from the profile. You can override the Threshold ID if needed. If no threshold was defined for the profile, you can select an asset based threshold ID. If you need to modify an existing asset to use the capitalization threshold by book method, use the Book – Depreciation page to do so.

See:

[General Information Page](#)

[Cost/Asset Information Page](#)

[Depreciation Information Page](#)

[Book - Depreciation Page](#)

6. *For capitalization threshold by asset:* Use the Non-Capitalized Cost components in the application to perform adjustments, transfers, retirements, and other financial transactions to assets that use this capitalization method. The Non-Capitalized Cost components include the Update Non-Capitalized Cost and Retire/Reinstate Non-Fin Asset pages.

For capitalization threshold by book: Use the Financial components in the application to perform adjustments, transfers, retirements, and other financial transactions to assets that use this capitalization method. This applies to capitalized and non-capitalized books.

Understanding Capitalization Threshold Validation

The Capitalization Threshold Validation process validates whether assets still belong to the capitalization brackets to which they were initially catalogued after adjustments are made to the original cost. If an asset is in the same bracket as originally classified, then this process takes no further action; however, if it is not, the asset is moved to its respective capitalization bracket.

The following graphic represents the process flow for the capitalization threshold validation process:

Capitalization Threshold validation process flow:

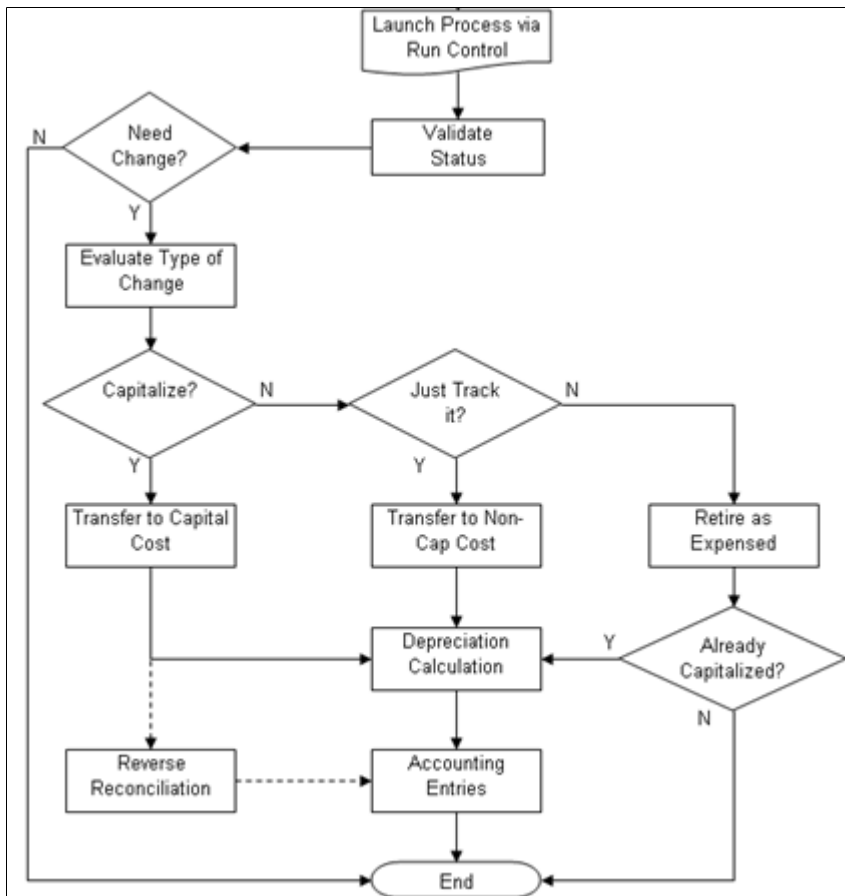

Capitalization Limits Page

Use the Capitalization Limits page (DEPR_CAP_LIMIT) to set up capitalization limit codes by business unit by book, as necessary, especially Germany.

Navigation:

Set Up Financials/Supply Chain > Product Related > Asset Management > Financials > Capitalization Limit

This example illustrates the fields and controls on the Capitalization Limits page. You can find definitions for the fields and controls later on this page.

Capitalization Limits

SetID **SHARE**

Cost Limit Code **GERMANY** *Currency Code **EUR** **euro**

Description

Limits	Personalize Find	First 1-2 of 2 Last		
	Amount	Low Value Switch	Message Severity	
1	<input style="width: 80%;" type="text" value="100.00"/>	<input type="checkbox"/>	Error	<input type="button" value="+"/> <input type="button" value="-"/>
2	<input style="width: 80%;" type="text" value="800.00"/>	<input checked="" type="checkbox"/>	Warning	<input type="button" value="+"/> <input type="button" value="-"/>

Create a cost limit code, complete the applicable fields, and select the **Low Value Switch** check box to identify which limit amount triggers low value asset reporting. This is used only in certain countries.

For example, you might set up capitalization limits for Germany. Using the Cap Limit table, you can set up your system so that assets with a cost less than 800.00 EUR could be added, but the system would generate a warning that the cost was below the capitalization limit; likewise, assets with a cost less than 100.00 EUR could *not* be added and would generate an error message.

Related Links

[Capitalization Limits Page](#)

Capitalization Thresholds Page

Use the Capitalization Thresholds page (CAP_THR_DEFN) to establish capitalization thresholds by asset profile to be used in automatic classification of capital asset, non capital asset, or expense asset.

Navigation:

Set Up Financials/Supply Chain > Product Related > Asset Management > Financials > AM Capitalization Thresholds > Capitalization Thresholds

This example illustrates the fields and controls on the Capitalization Thresholds page. You can find definitions for the fields and controls later on this page.

Capitalization Thresholds

SetID SHARE

Threshold ID CT_001

*Basis Amount

Book Threshold

*Currency Code USD

*Description Capitalization on Amount

Detail Find | View All First 1 of 1 Last

Effective Date 01/01/1900

Thresholds Personalize | Find | First 1-2 of 2 Last

Active	Action	Amount
<input checked="" type="checkbox"/>	Expense	500.00
<input checked="" type="checkbox"/>	Physical	5,000.00

This example illustrates the fields and controls on the Capitalization Thresholds page. You can find definitions for the fields and controls later on this page.

Field or Control	Description
Threshold ID	Supply a meaningful threshold ID when creating capitalization thresholds to assign them to asset profiles or assets.
Basis	Select the basis to be used for calculating the appropriate capitalization action to take. Select from the following options: <ul style="list-style-type: none"> <i>Amount</i>: The capitalization threshold is based on the total cost of an asset (cost x quantity). <i>Quantity</i>: The capitalization threshold is based on the unit costs per asset.
Book Threshold	Select this option to define capitalization threshold by book. When you select this option, only the Physical Action option is available in the Thresholds group box.
Currency Code	Enter the currency code of the amounts reflected in the Amount fields.
Effective Date	Enter the date when the threshold becomes applicable.

Field or Control	Description
Active	Activate each threshold bracket. When deselected, the amount becomes unavailable.
Action	<p>Select to activate and set thresholds for the following brackets:</p> <ul style="list-style-type: none"> • Physical: If this action is active and an asset falls within the threshold for this bracket, the system creates the asset ID but does not capitalize it. Any asset added that has an amount above this bracket is capitalized if this bracket is active. • Expense: If this action is active and falls within the threshold for this bracket, the asset is excluded from asset generation. If however, the Physical bracket is not active and an asset amount is above the Expense limit, the asset is capitalized. <hr/> <p>Note: If you select the Book Threshold option, this option is not available.</p> <hr/>
Amount	Enter the ceiling amount for each bracket. Amounts that are less than or equal to the amount entered are included in that bracket.

Capitalization Threshold Validation Page

Use the Capitalization Threshold Validation page (AM_CAPVAL_RQST) to run the process to validate whether an asset still meets conditions to remain in the capitalization status that it was originally catalogued upon asset addition based on the capitalization threshold process.

Navigation:

Asset Management > Asset Transactions > Financial Transactions > Cap Threshold Validation

This example illustrates the fields and controls on the Capitalization Threshold Validation page. You can find definitions for the fields and controls later on this page.

Capitalization Threshold Validation

Run Control ID 169 Report Manager Process Monitor Run

Selection Criteria Find | View All First 1 of 1 Last

<p>*Request ID <input type="text" value="1"/></p> <p>System Source <input type="text"/></p> <p>*Business Unit <input type="text" value="US001"/></p> <p>Asset Category <input type="text" value="FF"/></p> <p>Profile ID <input type="text" value="BKFURNITUR"/></p> <p>Asset Class <input type="text" value="DESK"/></p> <p>Threshold ID <input type="text" value="BK_CT_001"/></p> <p>From Acq Dt <input type="text"/></p>	<p>Process Frequency <input type="text" value="Always"/></p> <p><input checked="" type="checkbox"/> Book Threshold</p> <p>Book Name <input type="text"/></p> <p>Location <input type="text"/></p> <p>Area ID <input type="text"/></p> <p>Cost Type <input type="text"/></p> <p>Chartfield Search Criteria</p> <p>To Acq Dt <input type="text"/></p>
From Asset ID <input type="text" value="00000000169"/>	To Asset ID <input type="text" value="00000000169"/>
Trans Date <input type="text" value="10/10/2014"/>	Trans Code <input type="text"/>
Acctg Date <input type="text" value="10/10/2014"/>	

Supply the selection criteria for assets to be evaluated for capitalization threshold validation.

Field or Control	Description
Book Threshold	<p>Select this option to process capitalization validation for asset book.</p> <p>When you select this option, the Validation Basis field is unavailable and only Threshold IDs associated with asset books are available for selection.</p>
Chartfield Search Criteria link	<p>Access the Chartfield Search Criteria page to supply ChartField filter information for those assets that have particular ChartFields active.</p>
Trans Code (transaction code)	<p>Select this criteria, which is useful for assets that are converted from trackable to capitalized. If you want to identify them or perform a different accounting entry, you can define and utilize a transaction code for that purpose.</p>

Field or Control	Description
Validation Basis	<p>Select the criteria to use in order to evaluate the total cost of the asset against the threshold. The following options are available:</p> <ul style="list-style-type: none"> • <i>Capitalized Cost</i> : The system sums only the amounts stored on the cost table. • <i>Total Cost</i>: The system sums up the amounts stored in both the cost and non capital cost tables. <hr/> <p>Note: This field is unavailable when the Book Threshold option is selected.</p>

Capitalization Threshold Summary Report Page

Use the Capitalization Threshold Summary Report page (AM_CAPSUM_RQST) to run a report to show the capitalization status of assets based upon criteria selection.

Navigation:

Asset Management > Financial Reports > Capitalization Summary Report

This example illustrates the fields and controls on the Capitalization Threshold Summary Report page. You can find definitions for the fields and controls later on this page.

The screenshot shows the 'Capitalization Threshold Summary Report' interface. At the top, it displays 'Run Control ID 169' and 'Report Manager Process Monitor' with a 'Run' button. Below this is a 'Selection Criteria' section with a search bar and navigation controls (Find, View All, First, 1 of 1, Last). The criteria include:

- Report Type: All
- System Source: [Dropdown]
- *Business Unit: US001
- Asset Category: FF
- Profile ID: FURNITURE
- Asset Class: DESK
- Threshold ID: BK_CT_001
- From Acq Dt: [Date Picker]
- From Asset ID: 00000000169
- Book Name: [Text Box]
- Location: [Text Box]
- Area ID: [Text Box]
- Cost Type: [Text Box]
- Chartfield Search Criteria:
 - To Acq Dt: [Date Picker]
 - To Asset ID: 00000000169

Select criteria to report assets as they are classified according to the Capitalization Threshold process. The report displays the acquisition date, asset ID, description, quantity, tag number, serial ID, capitalized cost and non capitalized cost.

<i>Field or Control</i>	<i>Description</i>
Book Threshold	Select this option to process the capitalization status report for asset book. When you select this option, the Validation Basis field is unavailable and only Threshold IDs associated with asset books are available for selection.
Report Type	Select to report only the assets that are candidates for recategorization or select to report all assets.
Validation Basis	Select to report assets that are capitalized (from the cost table) or select to report both capital and non capital assets. Note: This field is unavailable when the Book Threshold option is selected.

Adding and Maintaining Asset Information

This topic discusses how to maintain Asset Information.

Pages Used to Add or Change Asset Information

<i>Page Name</i>	<i>Definition Name</i>	<i>Usage</i>
<u>General Information Page</u>	ASSET_GENERAL_01	Add asset basic information manually, or modify existing asset information.
<u>Cost History Page</u>	COST_HISTORY2	To view complete asset cost history information.
Asset R&D Information (asset research and development information) Page	ASSET_RD_SP	Enter information about R&D assets. In Australia, this information is used for tax reporting purposes; otherwise, it is informational only. See <u>General Information Page</u>

Page Name	Definition Name	Usage
Warehouse Mapping Page	AM_WH_MAP_ASSET	Enter transfer information defaults for assets used in component changeout for PeopleSoft Maintenance Management. This page is used by PeopleSoft IT Asset Management and PeopleSoft Maintenance Management to transfer assets to a defined warehouse. Custodian, Location, and Employee ID are also available. Custodian will inherit the ChartFields defined for the warehouse. See General Information Page
Asset Management - Attachments Page	AM_ADD_ATTACH_SEC	Add relevant supporting documents to an asset transaction. See General Information Page
Fair Value Page	AM_FMV_DEFN	Update fair value (FV) information for each asset. The data is stored on the AM_FMV record and is used for revaluation of the asset in accordance with statutory requirements. See General Information Page
(JPN) Local Tax Return Page	LTAX_ADD_INFO_SEC	Enter local tax information when you acquire depreciable fixed assets. Report local tax return information for Japan. See General Information Page
Operation/Maintenance Page	ASSET_GENERAL_02	Enter detailed physical information
Work Order Management Page	AM_WOM_OPT_ASSET	Enter Work Order–related information relevant to the asset. Operation/Maintenance Page
Operation/Maintenance Page	ASSET_FSC	When an asset is defined as hazardous, describe it by selecting at least one hazardous code from the list.

Page Name	Definition Name	Usage
<u>Asset Acquisition Detail Page</u>	ASSET_ACQ_DETAIL	<p>Store information about how the asset was acquired and keep track of the separate costs and acquisition details of components that make up an asset.</p> <p>If PeopleSoft Asset Management is integrated with PeopleSoft Payables, PeopleSoft Receivables, PeopleSoft Purchasing, or PeopleSoft Project Costing, these source systems will enter the information automatically.</p>
Acquisition Details Page	ASSET_ACQ_DET_AP	<p>View or enter information about assets acquired through other PeopleSoft applications. If Asset Management is integrated with other PeopleSoft applications, the source systems send the asset information through delivered interfaces. If not, you can add the information here.</p> <p>See Asset Acquisition Detail Page</p>
Acquisition Detail Chartfields Page	ASSET_ACQ_DET_CF	<p>Enter acquisition ChartField details for the asset.</p> <p>See Asset Acquisition Detail Page</p>
<u>Doc Sequencing Page</u>	AM_DOC_SEQ	Enter document sequencing information.
<u>Tax Page</u>	ASSET_ACQ_DET_VAT	Enter tax information for the asset. This feature is available only if the business unit is activated for value-added tax (VAT) processing.
<u>Location/Comments/Attributes Page</u>	ASSET_IMAGE	Record the location and physical properties of the asset (such as color, height, and weight) and store comments about it; view a stored image of the asset.
Assets by Location - Parameters	RUN_AMAS2200	Generate a report of assets sorted by location.
<u>Manufacture/License/Custodian Page</u>	ASSET_CUSTODIAN	Record custodial information, maintain license information, and store manufacturer-related information.

Page Name	Definition Name	Usage
License Address Page	ASSET_LIC_ADDR_SEC	Enter address information associated with an asset license. See Manufacture/License/Custodian Page
License Information - Parameters	RUN_AMAS1700	Generate a report of asset licenses.
Asset Property Page	ASSET_PROPERTY	Enter details to manage property assets and to maintain property-specific attributes such as identifying information, asset hierarchy, area and occupancy, and legal descriptions. This page tab appears when the asset type of <i>Property</i> is selected; however, if Lease Administration is not a selected product within Installation Options and Space Management Installed is not selected within the Asset Management Installation Options, the Property page is disabled.
Record Property Taxes Page	ASSET_PROP_TAX	Enter property tax details including due dates, taxing authorities, and payments.
Asset Supplemental Data Page	AM_ASSET_SD	Record additional data based upon asset business unit, asset type, subtype, manufacturer, and model.
IoT (Internet of Things) Page	AM_IOT	Assign Oracle Internet of Things attributes to your asset.
External Funding Source Page	ASSET_EFS	Associate an asset with an external funding source.

General Information Page

Use the General Information page (ASSET_GENERAL_01) to add asset basic information manually or modify existing asset information.

Navigation:

Asset Management > Asset Transactions > Owned Assets > Basic Add > General Information

This example illustrates the fields and controls on the General Information page. You can find definitions for the fields and controls later on this page.

General Information | Operation/Maintenance | Asset Acquisition Detail | Location/Comments/Attributes | Manufacture/License/Custodian >

Unit: US001 | Asset ID: 000000000233 | Leased Car | Tag: | In Service

Asset Information

Description: Leased Car | Short Desc: Leased Car

CAP #: | Seq #:

Taggable Asset | Tag Number:

Asset Class: | Auction Status: Allowed to be Auctioned

Asset Type: Fleet | Capitalized Asset

Asset Subtype: | New Asset

*Asset Status: In Service | Available For Use

Acquisition Date: 01/01/2024 | In Physical Use

Placement Date: 01/01/2024

Collateral Asset:

*Acquisition Code: Leased | Lease Number: 0000000146

FERC Code: | Lease Asset ID:

Financing Code:

Fair Value: 0.000 | Appraisal Date:

Replacement Cost: | Last Update:

Index Name:

SubIndex Name:

Parent/Child: None | Parent ID:

Profile ID: LEASED CAR | Region Code:

Composite Asset | Composite Asset ID:

[Book Page](#) | [Set R and D Info...](#)
[Asset Warehouse Mapping](#) | [Attachments \(0\)](#)
[Fair Value Details](#) | [External Funding Source...](#)

Field or Control	Description
Related Content	<p>Click to view the asset cost history for this asset. For more information, see Cost History Page.</p> <p>This button appears next to the main screen (upper right corner of every page within the Basic Add component). PeopleSoft Asset Management delivers the Related Content functionality as enabled for the Basic Add component. To manage related content, see Working with Related Content in Asset Management.</p>
Unit	Displays the business unit in which the asset is defined.

Field or Control	Description
Asset ID	<p>Select the default value <i>Next</i> to have the system automatically assign the next available number. You can also enter an alphanumeric value of your own.</p> <hr/> <p>Note: When entering joint venture assets that are shared among several business units, it is recommended that you assign a unique asset ID. This ensures that the assets created at the participant level all have the same ID as the assets created at the joint venture business unit level. For example, you might use the prefix <i>JV</i>, which would generate an asset ID such as JV000022.</p> <hr/>
Tag	Displays the tag number for assets already entered.
Asset Status	Displays of the current status of the asset, such as <i>In Service</i> .
Description and Short Description	Enter identifying and descriptive information about the asset. The short description can be an abbreviated description.
CAP # (capital acquisition plan number) and Seq # (sequence number)	Enter a capital acquisition plan number and associated sequence number, if applicable. The capital acquisition plan number ties the asset to a capital acquisition plan. Only valid numbers set up in the Capital Acquisition Plan table are accepted. The sequence number defines the detailed elements of the capital acquisition plan.
Taggable Asset and Tag Number	<p>If you use tags to track assets, enter the tag number assigned to the asset. This automatically selects the Taggable Asset check box. Asset Management performs physical inventory using the asset tag number. If the business unit for this asset is set up to allow a default tag number based on the asset ID, the default tag number appears here.</p> <hr/> <p>Note: You must use tag numbers to perform physical inventory with the Asset Management physical inventory application.</p> <hr/> <p>See Understanding Physical Inventories.</p>
Asset Class	If you use classifications to define assets within categories, enter the asset class code here. The asset class enables you to identify assets for reporting purposes. The asset class is also used as a VAT driver.
Auction Status	Displays the status of an asset that has been submitted to Strategic Sourcing for auction.

Field or Control	Description
<p>Asset Type</p>	<p>Select a value to indicate a type of asset. The available options are:</p> <p><i>Equipment</i></p> <p><i>Facility</i></p> <p><i>Fleet</i></p> <p><i>Furniture</i></p> <p><i>Hardware</i></p> <p><i>Intangible</i></p> <p><i>Machinery</i></p> <p><i>Other</i></p> <p><i>Property</i></p> <p><i>Software</i></p>
<p>Asset Subtype</p>	<p>Select a value to indicate a subset of asset type. Subtypes are optionally user-defined and directly related to the asset type. Only asset subtypes of the selected asset type are available when defining the asset.</p>
<p>Asset Status</p>	<p>Select the appropriate asset status from the following options:</p> <ul style="list-style-type: none"> • <i>Budgeted</i>: Asset is budgeted but not placed in service. • <i>Work in Progress</i>: Asset is acquired for a project under way. • <i>Requisitioned</i>: Necessary paperwork has been completed for acquisition. • <i>Commitment</i>: Budget has been approved and the asset is being acquired. • <i>Received (not in service)</i>: Asset has been received but not yet placed in service. • <i>In Service</i>: Indicates the date the asset is available for use. The transaction date is the default. • <i>Disposed</i>: Asset has been disposed of. • <i>Transferred</i>: The asset has been transferred from one business unit to another. • <i>Suspended</i>: Depreciation has been suspended for the asset.

Field or Control	Description
Acquisition Date	Enter the date when the asset was acquired. This field is automatically populated if the asset was added from a feeder system, such as Purchasing or Payables.
Placement Date	Enter the date that the asset is placed in service for physical purposes.
(JPN) Collateral Asset	<p>Japanese accounting principles require that assets offered as collateral be treated according to financial reporting regulations under the commercial law. If this asset is such a collateral asset, select one of the available options that comply with Japanese requirements.</p> <p>See (JPN) Using PeopleSoft Asset Management Options to Meet Japanese Requirements.</p>
Capitalized Asset	Indicates whether the asset has been capitalized. This check box is display-only.
New Asset	Select this option if the asset is new.
Available For Use	Select this option if the asset is available to be used.
In Physical Use	<p>Select this option to resolve discrepancies between the asset repository and IT asset discovery. Changes made to this page are incorporated in the main asset record within the asset repository. The physical use indicator is affected when adding, transferring, retiring or reinstating hardware assets within PeopleSoft Asset Management. Only those assets that have the physical use indicator selected are included in the ITAM comparison process.</p> <p>See “Understanding the Compare Asset Repositories Process” (PeopleSoft IT Asset Management).</p>
IoT Asset (Internet of Things Asset)	<p>Select this option to synchronize the asset with Oracle Internet of Things (IoT) Asset Monitoring Cloud Service.</p> <p>In addition, the fields in the IoT page become available for editing.</p> <p>This field is only available if you select the <i>IoT Installed</i> option on the “Installation Options - Asset Management Page” (Application Fundamentals).</p> <p>See:</p> <p>“Understanding the Integration with Oracle Internet of Things Asset Monitoring Cloud Service” (Asset Lifecycle Management Fundamentals)</p> <p>IoT (Internet of Things) Page</p>

Field or Control	Description
Acquisition Code	<p>The acquisition code indicates how you acquired the asset. Select one of the following options:</p> <ul style="list-style-type: none"> • <i>Donated</i>: Use for donated assets. • <i>Constructed</i>: Use for constructed assets. • <i>Leased</i>: Use to tie an asset to a capital or operating lease. You must also specify the capital or operating lease asset ID. • <i>Like Exchange</i>: This option is not valid for this page. You must add like exchanges in the Asset Express Add component. • <i>Purchased</i>: This option is used for purchased assets. This is the default value. • <i>Trade In</i>: This option is not valid for this page. You must add traded-in assets in the Asset Express Add component. • <i>Transferred</i>: Transferred, either within the same business unit or to another business unit.
Lease Number	Select to access the Maintain Lease component on the General Information page.
FERC Code (Federal Energy Regulatory Commission code)	The FERC Code is used to identify depreciation according to FERC guidelines. This field is used in the U.S., usually to identify group assets, such as telephone poles, highway signs, or other assets used in mass quantities.
Financing Code	Enter the code as you have defined it. Financing codes enable you to analyze debit and credit relationships for capital-intensive and government projects.
Fair Value	<p>This display-only field indicates the FV of the asset as updated from the Fair Value page. The FV is used in the calculation of asset revaluation.</p> <p>See Capturing and Maintaining Asset Fair Value.</p>
Appraisal Date	This display-only field indicates the date when the current FV was updated. When the asset is added to the database, the appraisal date is the same as the acquisition date by default.

Field or Control	Description
Replacement Cost	<p>Indicates how much it would cost to replace the asset. When the asset is added to the database, the replacement cost is equal to the total base cost of the asset by default. The replacement cost can be derived by associating the asset to a cost index, such as the consumer price index (CPI) or inflation index.</p> <p>The association of the replacement cost index can be applied by default from the asset profile; the replacement cost is then calculated considering the base cost and the index amounts. The result is displayed here.</p>
Last Update	<p>If you are calculating the replacement cost using an index, the date that you performed the last update appears here. When the asset is added, this date is the accounting date.</p>
Index Name and Subindex Name	<p>Enter the adjustment of the replacement cost using an index, such as the consumer price index. When you calculate the replacement cost, the original replacement cost is adjusted by the index and subindex that you specify. Enter valid codes. These are established on the Indexes page during implementation.</p>
Parent/Child and Parent ID	<p>For a parent or child asset, select the appropriate option in the Parent/Child field. If it is a child asset, enter the parent ID with which it is associated. The default value is <i>None</i>. Parent and child assets cannot also be composite or group assets.</p>
Profile ID	<p>Enter a profile ID. Asset profiles are set up in the Asset Profile component.</p>
Region Code	<p>Select a region to categorize property assets by regions. Used for reporting.</p>
Composite Asset and Composite Asset ID	<p>Composite asset processing enables you to group assets so that their total cost is carried by one asset and depreciated that way. By selecting this option, you indicate that this single asset is a composite asset, and associated assets are known as composite members. This feature is frequently used by utility companies, and it meets the requirements to use the Japanese <i>Composite Depreciation Method</i>.</p> <p>When you select the Composite Asset check box on the Asset Information page, an Asset ID field appears. Associate the composite member by selecting the asset ID of a composite asset.</p> <p>See Understanding Composite Asset Processing.</p>

Field or Control	Description
Threshold ID	<p>If you want to define capitalization thresholds based on asset, select the Threshold ID to use as the default value for the assets within the selected profile.</p> <p>This field is available for editing only when:</p> <ul style="list-style-type: none"> • the Capitalization Threshold feature is enabled from the Installation Options - Asset Management page. • the Threshold ID on the Book - Depreciation page is unpopulated. • the business unit where the asset is added uses it.
Asset Retirement Obligations	<p>Select to identify an asset that is subject to asset retirement obligation (ARO) treatment in accordance with Financial Accounting Standards. This field appears only when you have enabled ARO on the Installation Options – Asset Management page and enabled ARO at the business unit level.</p> <p>If you created an asset profile with ARO defaults, you can select that Profile ID value for the asset. In addition to the other defaults associated with the profile, the Asset Retirement Obligation check box is automatically selected if you select an ARO Profile ID when adding an asset. When you select this check box, the ARO Identification field appears.</p>
ARO Identification (asset retirement obligation identification)	<p>Once you identify an asset as being subject to ARO treatment (Asset Retirement Obligations check box selected), the ARO Identification field appears. The system assigns this identification number sequentially, beginning with the number following the one that is designated on the AM Business Unit Definition page within the Last ARO Id field.</p> <p>See “AM Business Unit Definition Page” (Asset Lifecycle Management Fundamentals)</p>
(JPN) Reporting Life	<p>Enter the reporting life for Japanese composite assets. This life is used for calculating average life of the composite asset.</p>
(JPN) Local Tax Information	<p>Click to access the Local Tax Return page. This link is visible when establishing setup options for Japan tax reporting.</p> <p>See (JPN) Using PeopleSoft Asset Management Options to Meet Japanese Requirements.</p>
(AUS) Schedule Type Code	<p>If this is an Australian business unit, select a schedule type code.</p>

Field or Control	Description
(AUS) Calculate Last Date of Review	<p>Click to generate the last date of mandatory review for the asset.</p> <hr/> <p>Note: You cannot access the Schedule Type Code field, the Calculate Last Date of Review button, or the Last Date of Mandatory Review field if the last date of mandatory review has already been calculated, <i>unless</i> you are in correction mode.</p> <hr/>
(AUS) Last Review DT	<p>Displays the last date of mandatory review for the asset. The last date of mandatory review is stored at the asset level.</p> <p>See (AUS) Using PeopleSoft Asset Management Options to Meet Australian Requirements.</p>
Book Page	Click to save the component and access the Book (ASSET_BOOK_01) page.
Set R and D Info (set research and development information)	Click to access the Asset R&D Information page, where you can enter identifying information for the asset.
Asset Warehouse Mapping	Click to access the Warehouse Mapping page.
Attachments	Click to view or add relevant supporting documents to an asset.
Fair Value Details	Click to update fair value information for each asset.
External Funding Source	Click to access the External Funding Source Page and associate the asset with an external funding source.

(AUS) Asset R&D Information Page

Use the Asset R&D Information (asset research and development information) page (ASSET_RD_SP) to enter information about R&D assets.

In Australia, this information is used for tax reporting purposes; otherwise, it is informational only.

Navigation:

Click the **Set R and D Info** link on the General Information page.

Asset Management enables you to identify assets for the purpose of calculating research and development deductions.

Field or Control	Description
R and D Plant (research and development plant)	Select to identify the asset as specifically allocated for research and development.
R and D Start Date (research and development start date)	Enter the start date for the asset.
Use NBV (use net book value)	Select to use net book value for your tax reporting purposes. Click the OK button to return to the Asset Information page.

See [\(AUS\) Using PeopleSoft Asset Management Options to Meet Australian Requirements](#).

(JPN) Local Tax Information Page

Use the (JPN) Local Tax Return page (LTAX_ADD_INFO_SEC) to enter local tax information when you acquire depreciable fixed assets.

Navigation:

Click the **Local Tax Return** link on the General Information page.

This example illustrates the fields and controls on the Local Tax Information page. You can find definitions for the fields and controls later on this page.

Local Tax Information

Local Tax Add Information

New/Used ▼

Local Tax Office 🔍

Asset Return Type ▼

Return Year

Exception Rate

Numerator Denominator

Theoretical Net Book Value

Assessment Value

Asset Management enables you to calculate and run reports as required by Japanese local tax laws, including all required information for the local depreciable asset tax return. When the **Localization Country** field on the User Preferences - Overall Preferences page is set to *JPN*, the Establish Business Units component for PeopleSoft Asset Management includes the Business Unit Info for Japan page. If you select **Use JPN Local Tax** from the AM Business Unit Definition page (JPN Info link) , you enable access to the Local Tax Return page from the General Information page.

Complete the fields as necessary to generate the Japanese local tax return.

See [\(JPN\) Using PeopleSoft Asset Management Options to Meet Japanese Requirements](#).

Warehouse Mapping Page

Use the Warehouse Mapping page (AM_WH_MAP_ASSET) to enter transfer information defaults for assets used in component changeout for PeopleSoft Maintenance Management.

This page is used by PeopleSoft IT Asset Management and PeopleSoft Maintenance Management to transfer assets to a defined warehouse. Custodian, Location, and Employee ID are also available. Custodian will inherit the ChartFields defined for the warehouse.

Navigation:

Click the **Asset Warehouse Mapping** link on the General Information page.

This example illustrates the fields and controls on the Warehouse Mapping page. You can find definitions for the fields and controls later on this page.

Warehouse Mapping

Default Mapping from Asset

Operating Unit 

Fund Code 

Department 

Program Code 

Class Field 

Budget Reference 

Product 

Project 

Location Code 

Custodian

Empl ID 

<i>Field or Control</i>	<i>Description</i>
Default Mapping from Asset	Select to apply the asset ChartFields, location and custodian from the asset ID. The option displays as not selected (unchecked) by default. If the option is not selected, the system will use the ChartFields mapped at the business unit level.
Operating Unit, Fund Code, Department, Program Code, Class Field, Budget Reference, Product, and Project	Displays the ChartField account codes to be used for the transferred component (asset). Only the active ChartFields for your system appear.

Field or Control	Description
Location Code	Select the location code where the replaced or transferred asset will be physically stored.
Custodian	Select the custodian or physical "owner" of the asset.
EmpID (employee ID)	Enter the employee ID assigned to the asset.

Basic Add – Attachments Page

Use the Basic Add - Attachments page (AM_ADD_ATTACH_SEC) to view or add relevant supporting documents to an asset.

Navigation:

Click the **Attachments** link on the General Information page.

This example illustrates the fields and controls on the Basic Add - Attachments page.

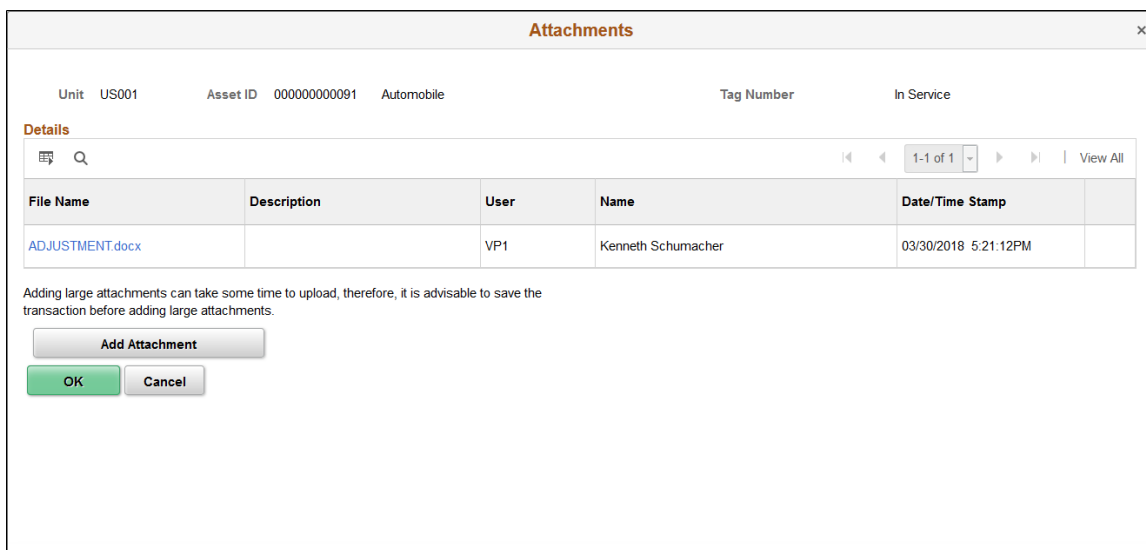

Field or Control	Description
Add Attachment	Click this button to attach files as supporting documentation for an asset. Supply a description of the file or files that you attach.
File Name	Displays the attached file. Click the file-link to access the file.
User, Name, and Date/Time Stamp	Displays the user ID, name, and date/time stamp related to the user who added the attachment.

Fair Value Page

Use the Fair Value page (AM_FM_V_DEFN) to update fair value (FV) information for each asset.

The data is stored on the AM_FM_V record and is used for revaluation of the asset in accordance with statutory requirements.

Navigation:

Click the **Fair Value Details** link on the General Information page.

This example illustrates the fields and controls on the Fair Value page. You can find definitions for the fields and controls later on this page.

The screenshot displays the 'Fair Value' page with the following details:

- Unit:** US001
- Asset ID:** 000000000007
- Tag:** P000041715
- In Service:** Yes
- Fair Value Detail:**
 - *Effective Date: 05/01/2000
 - Appraisal Date: 05/01/2000
 - Fair Value: 7500
 - Effective Sequence: 0
 - *Rate Type: CRRNT
 - Currency: USD
- Valuation Method:**
 - Valuation Method: (empty)
 - Valuation Premise: (dropdown)
 - Input Level: (dropdown)
 - Group By: (dropdown)
 - FV Group ID: (text field)
- Comment:** (text area)

Fair value is used in establishing revaluation of assets. PeopleSoft Asset Management stores this information for each asset and allows you to add a new fair value (FV) on a regular basis, leave it blank, or let it stay as original cost, depending upon your business requirements.

See [Capturing and Maintaining Asset Fair Value](#).

Search Audit Logs Page

Navigation:

Access the Search Audit Logs page (click the **Audit Logs** link on the General Information page).

This example illustrates the fields and controls on the Search Audit Logs page. You can find definitions for the fields and controls later on this page.

Search Audit Logs

Application Name: Asset Management Document Name: AM ASSETS

Search Criteria

* Business Unit is equal to

* Asset Identification is equal to

Event Code is equal to

Event Date is equal to

User ID is equal to

Process Instance is equal to

Include Archive

Include Batch Changes

Include Purge Logs

Search Results Personalize | Find | | First 1-2 of 2 Last

Business Unit	Asset Identification	Event Code	Event Name	Event Date Time	User ID	Process Instance	Message Text
US001	000000000141	ASSET_ADD	Asset Basic Addition	12/13/2012 2:29:30.000000PM	VP1		This asset was added online through Basic Add. Its Asset Status is In Service having profile and its Acquisition was on 2012-12-13
US001	000000000141	ASSET_ADD	Asset Basic Addition	12/13/2012 2:30:56.000000PM	VP1		This asset was updated online through Basic Add on 2012-12-13. Asset Status is In Service having profile and its Acquisition was on 2012-12-13

The **Audit Logs** link on the General Information page appears only if you have enabled audit logging for Asset Management and after you have saved the asset. Click the link to access the audit logs that pertain to this particular asset. The search results present all events for this asset that you have selected for tracking when you enabled audit logging.

See “Setting Up Financials Audit Framework (Audit Logging)” (Application Fundamentals).

Cost History Page

PeopleSoft delivers the ability to view complete asset cost history information for an asset from the Basic Add and Review Depreciation components.

Navigation:

Access any page of the Basic Add or Review Depreciation component and select the **Related Content** drop-down. Select the **Cost History** link.

This example illustrates the fields and controls on the Related Content Cost History Page. You can find definitions for the fields and controls later on this page.

Asset Cost Information		Personalize Find [?] [X]							First	1-2 of 2	Last
Cost	Charfields										
Acctg Date	Trans Type	In/Out	Quantity	Total Cost	Trans Code	Convention	Asset Category	Cost Type			
1 09/09/2003	ADD		0.5000	5,000.00	FM	OFFCE					
2 09/09/2003	ADD		0.5000	5,000.00	FM	OFFCE					

For more information regarding these pages, see [Viewing Archived Data](#)

To manage related content, see [Working with Related Content in Asset Management](#)

See also PeopleTools documentation: *PeopleTools Portal Technologies*, Developing and Configuring Related Content Services.

Operation/Maintenance Page

Use the Operation/Maintenance page (ASSET_GENERAL_02) to add or update:

- Manufacturer information
- Resource information
- Maintenance information
- Hazardous materials information

Navigation:

Asset Management > **Asset Transactions** > **Owned Assets** > **Basic Add** > **Operation/Maintenance**

This example illustrates the fields and controls on the Operation/Maintenance page. You can find definitions for the fields and controls later on this page.

General Information Operation/Maintenance Asset Information Asset Acquisition Detail Location/Comments/Attributes Manufacture/License/Custodian	
Unit US001	Asset ID 000000000001 SOLARIS WORKSTATION
Tag	In Service
Asset Structure Asset Type IT Hardware <input type="checkbox"/> Clustered Asset Asset Subtype Component of <input type="text"/>	Manufacturer Information Serial ID 000000000001 Mfg ID <input type="text"/> Model <input type="text"/> Version <input type="text"/>
Asset Resource Information <input type="checkbox"/> Schedulable Charge Back Default <input type="checkbox"/> Allow Overbooking WO Unit <input type="text"/> <input type="checkbox"/> Use As Tool Shop <input type="text"/> Crew <input type="text"/>	Maintenance Information <input type="checkbox"/> Repairable Repair Status None Parts List <input type="text"/> WO Location <input type="text"/> <input type="checkbox"/> Offline Criticality 02 Medium
Other Information <input type="checkbox"/> Hazardous Asset Hazardous Code Info... <input type="checkbox"/> Non-Owned Asset <input type="checkbox"/> Replacement Asset Asset ID <input type="text"/> <input type="checkbox"/> Asset is Available Contact <input type="text"/> <input type="checkbox"/> Linear Asset Phone # <input type="text"/>	IT Asset Related information IP Address <input type="text"/> CPU <input type="text"/> 1

Asset Structure

This section discusses how to define the asset structure. Assets can be catalogued as assets of a certain type, with sequential subtypes, assets that are components of a higher level asset, or clustered assets, multiple assets that combine to establish a whole asset.

Field or Control	Description
Asset Type	Displays the asset type for this asset from a list of valid definitions.
Asset Subtype	Displays the asset subtype to this asset type. Only one asset subtype can be applied to an asset type.
Component Of	Enter the asset ID that this asset is a component of.
Begin Date	Enter the date when the relationship begins. This field is only visible when a component is assigned or updated.
Clustered Asset	Select to indicate that the asset is part of a larger entity or cluster. A clustered asset is similar to a group asset. This field is used for reporting purposes only.
Work Order Options for Components	Go to the Work Order Options for Components page to define options for work orders.

Manufacturer Information

This section provides information to define asset manufacturer information.

Field or Control	Description
Serial ID	Enter the asset serial number ID, if available. The serial ID is required for asset type hardware.
Mfg ID (manufacturing ID)	Enter the asset manufacturing ID, if available.
Model	Enter the asset model information or ID, if available.
Version	Enter the asset version information or ID, if available.
More Manufacturer Info (more manufacturer information)	Click this link to go to the Asset Manufacture/License/Custodian (ASSET_CUSTODIAN) page.

Asset Resource Information

This section provides information to define the asset as a resource.

Field or Control	Description
Schedulable	Select if the asset can be scheduled by users. For example, a crane extension can be used on multiple cranes at multiple project sites. It may require separate inspections and certifications from the crane. It could be used to replace a similar extension in use on another crane that must be taken out of service for repairs or inspection. Because it can be used on more than one crane, it may be considered a schedulable asset. Only schedulable assets can be checked out using the asset checkout feature.
Allow Overbooking	Select if the asset schedule of the asset can be overbooked.
Use As Tool	Select if the asset is used as a tool in another event. This requires that an asset subtype be associated with the asset.
Charge Back	Select if the asset can be charged back to a department, operating unit, project or other cost expensing entity.

Field or Control	Description
WO Unit (work order unit)	Enter the associated work order business unit accessing the asset. This option is available if PeopleSoft Maintenance Management is installed.
Shop	This option is available if PeopleSoft Maintenance Management is installed. It is used for defaulting the location where the asset needs to be worked on during repair.
Crew	Select the crew name from the list of crews associated with the work order unit and shop that you previously selected. Note: This option is available if PeopleSoft Maintenance Management is installed.

Maintenance Information

This section provides maintenance information about the assets.

Field or Control	Description
Repairable	Select if the asset can be repaired as needed.
Repair Status	Select a repair status of the asset. This field is available when the Repairable option is selected. Values are <i>Needs Repair</i> , <i>In Repair</i> , and <i>None</i> . Repair status can be updated from PeopleSoft Maintenance Management if the Repairable option is selected.
Parts List	Select a corresponding equipment parts lists (EPL) established for this asset. It is important to be sure that all the criteria match in order to assign an EPL template to the asset (Asset Type, Subtype, Manufacturer ID, Model, and Product Version.)
WO Location (work order location)	Select the work order location for the asset. This location designates where the repair will take place. The values are <i>Asset</i> , <i>Shop</i> or <i>Other</i> .

Field or Control	Description
Criticality	<p>Select the appropriate level of criticality for the asset. Criticality levels are defined on the Asset Criticality page (AM_CRIT_LVL). Select Set up Financials/Supply Chain > Product Related > Asset Management > Service and Repair > Criticality Code. You can establish meaningful levels of criticality for your organization when defining the criticality code and associated description.</p> <p>See “Defining Asset Attributes” (Asset Lifecycle Management Fundamentals).</p>
Offline	Designate whether the asset is available or offline. (The field is informational only.)

Other Information

Field or Control	Description
Hazardous Asset	<p>Select if the asset is considered a predominant or significant hazardous material.</p> <hr/> <p>Note: The federal government of the United States defines hazardous materials and waste to include: "Solid, liquid, or gaseous waste, or combination of these wastes, which because of its quantity, concentration or physical, chemical, or infectious characteristics may cause significantly to an increase in mortality or an increase in serious irreversible or incapacitating illness or pose a substantial present or potential hazard to human health or the environment when improperly treated, stored, transported, disposed of, or otherwise managed."</p> <hr/>
Hazardous Code Info (hazardous code information)	<p>Click to access the Hazardous Code Information page, where you can indicate hazardous material information by selecting assigned codes. The PeopleSoft system is delivered with the U.S. Federal Supply Class (FSC) codes, or you can select from codes that are created during implementation to suit your specific needs.</p> <p>See “Hazardous Codes Page” (Asset Lifecycle Management Fundamentals).</p>
Non-Owned Asset	Select if this asset is not owned.

Field or Control	Description
Replacement Asset and Asset ID	<p>Select if this is a replacement asset. When an asset (or asset component) has been replaced by another in PeopleSoft Maintenance Management, this field automatically displays the associated new asset ID.</p> <hr/> <p>Note: The asset ID displayed here shows the replaced asset ID. The new asset that replaced this asset has a new asset ID on the General Information page.</p> <hr/>
Asset is Available, Contact, and Phone # (phone number)	Select and complete contact information if the asset is available for reassignment to another person.
Linear Asset	<p>Identify an asset as linear within the Asset Repository. These are assets that have coordinates for their start and end points, such as a pipeline, train track, or a highway. You can identify linear assets at the asset subtype level when defining subtypes. In this way, when you select a subtype for the asset, the Linear Asset check box automatically inherits the designation that was made for the asset subtype. You can, however, override the subtype linear designation here at the individual asset level.</p> <hr/> <p>Note: Identification of linear assets facilitates potential integrations with third-party products.</p> <hr/>

IT Asset Related Information

This section discusses how to define IT asset–related information.

Field or Control	Description
IP Address	Enter the IP address of the asset.
CPU	Enter the CPU identifier.

Work Order Management Page

Use the Work Order Management page (AM_WOM_OPT_ASSET) to enter Work Order–related information relevant to the asset.

Navigation:

Click the **Work Order Options for Components** link on the Operation/Maintenance page.

This example illustrates the fields and controls on the Work Order Management page. You can find definitions for the fields and controls later on this page.

Work Order Management Options

Default Rules from Asset

Retire Assets Components

TRF Out Components for Reuse

Transfer In Components

[Asset Warehouse Mapping](#)

InterUnit Transfer Options

<input type="checkbox"/> Asset Acquisition Info	<input type="checkbox"/> Asset Attributes Info	<input type="checkbox"/> Asset License/Register Info
<input type="checkbox"/> Asset Lease Info	<input type="checkbox"/> Asset Non Capitalized Cost	<input type="checkbox"/> Asset Maintenance Info
<input type="checkbox"/> Asset Comments	<input type="checkbox"/> Asset Warranty Info	<input type="checkbox"/> Asset Insurance Info
<input type="checkbox"/> Asset Inspection Info	<input type="checkbox"/> Asset Component History	<input type="checkbox"/> Asset Attribute Groups Info

This page defines the transfer include and exclude rules for components swapped out and interunit transfer options. It is available when PeopleSoft Maintenance Management is installed. It is also available on the business unit, asset type, and subtype pages. You can define the rules at this level as an exception. If the **Default Rules from Asset** check box is not selected, the options are unavailable for selection as the options will be taken from other levels unless you specifically select the option to use it at the asset level.

<i>Field or Control</i>	<i>Description</i>
Default Rules from Asset	Check to enable rules from asset. If you leave this check box deselected, the system will take the default from a higher level and the other two fields will be unavailable for selection.
Retire Assets Components	Select to allow asset subcomponent disposal when the asset component is retired.
Transfer Out Asset Components for Reuse	Select to allow transfer of subcomponents when the asset component is transferred.
Asset Warehouse Mapping	Click to view the Warehouse Mapping page.

<i>Field or Control</i>	<i>Description</i>
InterUnit Transfer Defaults Options	Select the asset information to include with the transfer when there is an interunit transfer.

Hazardous Asset Codes Page

Use the Hazardous Asset Codes page (ASSET_FSC) to when an asset is defined as hazardous, describe it by selecting at least one hazardous code from the list.

Navigation:

Click the **Hazardous Code Info** link on the Operation/Maintenance page.

This example illustrates the fields and controls on the Hazardous Asset Codes page. You can find definitions for the fields and controls later on this page.

Hazardous Asset Codes				
Hazardous Asset Codes Personalize Find View All First 1-3 of 3 Last				
	Hazardous Code	Hazardous Type	Items Contained	
1	1375	S	DEMOLITION MATERIALS	
2	1370	S	PYROTECHNICS	

When an asset is defined as hazardous, describe it by selecting at least one hazardous code from the list. This feature supports U.S. FSC codes, which are delivered with PeopleSoft Asset Management. When you mark an asset as hazardous and associate a descriptive code with it, you can also provide additional information about its location and custodian and other pertinent data (in the Basic Add component). You can use this information to generate a report to monitor or track hazardous assets.

<i>Field or Control</i>	<i>Description</i>
Hazardous Code	Select a code number.
Hazardous Type and Items Contained	These fields display the values contained in the definition for the code from the Hazardous Codes table established at implementation.

Asset Acquisition Detail Page

Use the Asset Acquisition Detail page (ASSET_ACQ_DETAIL) to store information about how the asset was acquired and keep track of the separate costs and acquisition details of components that make up an asset.

You can enter costs before they have been approved for capitalization. Once they are approved, you can then capitalize them. The total capitalizable costs entered here appear by default in the Capitalize Information collapsible section.

You can enter multiple transactions and adjustments for an asset without exiting the component. When you enter the first acquisition line, the page displays the **Capitalize button** once the *To be Capitalized* field value is selected as the Capitalize option. Click the **Capitalize button** and save. Without leaving the page, click the **Add a New Row button** (plus button) to add the next transaction: You may also add a non capital transaction for the next row. Once you select the *Never Capitalize* field value, the **Non-Capitalize button** appears. Click the **Non-Capitalize button** and save the transaction.

For additional information on entering multiple adjustments for an asset, see [Entering Multiple Cost Adjustments. Understanding Adjusting, Transferring, Reversing, and Evaluating Assets](#), “Entering Multiple Cost Adjustments”.

Navigation:

Asset Management > Asset Transactions > Owned Assets > Basic Add > Asset Acquisition Detail.

This example illustrates the fields and controls on the Asset Acquisition Detail page. You can find definitions for the fields and controls later on this page.

Use the Asset Acquisition Detail page to enter costs before they have been approved for capitalization. Once they are approved, you can then capitalize them. The total capitalizable costs entered here appear by default in the Capitalize Information collapsible section.

You can enter multiple transactions and adjustments for an asset without exiting the component. When you enter the first acquisition line, the page displays the **Capitalize** button once the *To be Capitalized* field value is selected as the Capitalize option. Click the Capitalize button and save. Without leaving the page, click the **Add a New Row** button (plus sign) to add the next transaction: You may also add a non capital transaction for the next row. Once you select the *Never Capitalize* field value, the Non-Capitalize button appears. Click the Non-Capitalize button and save the transaction.

See For more information on entering multiple adjustments for an asset, see Note ID 1357360.1 on My Oracle Support website (<https://support.oracle.com>).

Enter the following information for *each* acquisition detail line:

Field or Control	Description
Asset ID	This is the asset value that was entered on the General Information page (or Express Add page) when adding the asset.

Field or Control	Description
System Source	<p>This field indicates the source system from which the acquisition detail was derived for PeopleSoft Asset Management. The default system source value when entering assets manually is AM Online Entry Page. This applies to the Express Add component, the Define Asset Operational Information component, as well as the Basic Add component . that you enter must be valid in the PeopleSoft Financials and Distribution Source table, and is typically Purchasing (PO), Payables (AP), or Project Costing (PC).</p>
Incentive ID	<p>Enter an investment incentive ID. This field is informational only.</p>
Capitalize	<p>Select the capitalization status of a new asset, or modify the status of an existing asset. The possible values are:</p> <ul style="list-style-type: none"> • Already Capitalized • Already Non Capitalized • Consolidated • Never Capitalize • To Capitalize Later • To be Capitalized <p>If an asset has not already been capitalized, you can assign it a status of <i>To be Capitalized</i> or <i>Never Capitalize</i>. PeopleSoft Asset Management enables you to associate books with non capitalized assets with the <i>Never Capitalize</i> status.</p> <p>If the status of an asset is set to <i>Disposed</i>, this field is unavailable for editing and you cannot capitalize the asset.</p> <hr/> <p>Note: Based on the option that you select, either the Capitalization Information section or the Non Capitalization Information section appears on the page.</p> <hr/>
Interfaces Info (interfaces information)	<p>Click to access a separate page where you can enter acquisition details information.</p>
Acquisition Detail Chartfields	<p>Click to access a separate page for storing ChartField information. Enter the operating unit, department, product, and project ID that you want to associate with the acquisition detail line.</p>

Acquisition Details Page

Use the Acquisition Details page (ASSET_ACQ_DET_AP) to view or enter information about assets acquired through other PeopleSoft applications.

If Asset Management is integrated with other PeopleSoft applications, the source systems send the asset information through delivered interfaces. If not, you can add the information here.

Navigation:

Asset Management > Asset Transactions > Owned Assets > Basic Add > Asset Acquisition Detail. Click the **Interfaces Info** link.

This example illustrates the fields and controls on the Acquisition Details Page. You can find definitions for the fields and controls later on this page.

Acquisition Details		
Payables Acquisition		
AP Unit <input type="text"/>	PS/Accounts Payable Drilldown	
Voucher ID <input type="text"/>	Invoice Number <input type="text"/>	
Vchr Line <input type="text"/>	Invoice Date <input type="text"/>	
Distrib Line <input type="text"/>		
Supplier ID <input type="text"/>		
Purchasing		Receiving
PO Unit <input type="text"/>	BU Recv <input type="text"/>	
PO No. <input type="text"/>	Receipt No <input type="text"/>	
PO Line <input type="text"/>	Receipt Line <input type="text"/>	
Sched Num <input type="text"/>	Ship Seq <input type="text"/>	
Distrib Line <input type="text"/>	Distrib Ln <input type="text"/>	
PS/Purchasing Drilldown		PS/PO Receiving Drilldown
Procurement Group		
Procurement Group ID	Seq	Primary Unit
Project Cost Acquisition		
PC Bus Unit <input type="text"/>	PS/Projects Drilldown	
Project <input type="text"/>		
Activity <input type="text"/>		
Source Type <input type="text"/>		

Procurement Group

Field or Control	Description
Procurement Group ID	Displays the Procurement Group ID for the asset. A procurement group ID is an identifier that is used to associate multiple related purchased items for an asset. The Procurement Group ID can be assigned to a group of procurement transaction lines on a single purchase order or across multiple purchase orders. See “Consolidating Requisition and Purchase Order Lines for Asset Components” (Asset Lifecycle Management Fundamentals).

Field or Control	Description
Seq (sequence)	Displays the Procurement Group Sequence number. Each transaction within a procurement group ID is assigned a procurement group sequence number.
Primary Unit	Displays the item that is the designated primary unit for the asset. The primary unit for the procurement group ID is assigned on the Procurement Group page. When an item is flagged as a primary item, a separate transaction is inserted into INTFC_PRE_AM in increments of the unit allocation quantity or amount and has its own sequence number.

Acquisition Detail Chartfields Page

Use the Acquisition Detail Chartfields page (ASSET_ACQ_DET_CF) to enter acquisition ChartField details for the asset.

Navigation:

Click the **Acquisition Detail Chartfields** link on the Asset Acquisition Detail page.

Capitalization Information and Non Capitalization Information

Use the Capitalization Information section to capitalize assets using the book information provided by the asset profile. Enter cost information into asset books. This section only displays when adding an asset.

Use the Non Capitalization Information section to add non capitalized costs associated with an asset at book level. This group box displays only when selecting the *Never Capitalize* option for the **Capitalize** field.

Local tax legislation may require capital gains tax in relation to the disposal of assets. Non capitalized costs may need to be included in resultant capital gain (or loss) calculations.

Field or Control	Description
Profile ID	Identifies a profile that is set up in the Asset Profile table. The current asset automatically displays all financial and tax depreciation information defined in that profile. You must enter a profile ID for each asset that you capitalize.
Accum Depr in Current Pd (accumulated depreciation in current period)	Select and add accumulated depreciation for the asset to be booked to the current period. Otherwise, accumulated depreciation is booked to the previous period. This check box appears only if you are capitalizing an asset.

Field or Control	Description
Transaction Date and Accounting Date	By default, these fields display the current date or the dates specified as user defaults. Transactions in Asset Management are entered after they have occurred. The Transaction Date field reflects the accrual date that the event took place, while the Accounting Date field reflects when it was booked or sent to accounting in the system. The transaction date must be earlier than or equal to the accounting date. For capitalized assets, note that any difference between accounting and transaction dates affects depreciation as well as posting or booking.
Transaction Code	Identifies which accounting entry template is used for the asset. The system accepts only a valid combination of asset category, transaction code, cost type, and transaction type for which accounting entry templates exist.
Capitalize	<p>Click the Capitalize button to capitalize the asset and add cost rows for all books in the profile ID. The cost rows that appear by default equal the total of all capitalizable acquisition detail rows. You can change this amount. The Capitalize button is no longer present once all of the To be Capitalized lines are capitalized.</p> <p>If one of the To be Capitalized lines is not yet capitalized, the Capitalize button is still visible and available. If you try to save the asset when there are amounts that have not yet been capitalized, you receive a warning; you can save anyway and capitalize the amount remaining to be capitalized at a later time.</p>
Non-Capitalize	<p>Click the Non-Capitalize button to add rows for all books in the profile ID. The cost rows that appear by default equal the total of all non capitalizable acquisition detail rows. This button appears only when the <i>Never Capitalize</i> field value is selected from the Capitalize options.</p> <p>If one of the non capital lines still has a status of <i>Never Capitalize</i>, the Non-Capitalize button is still visible and available.</p>
Left to Capitalize	After capitalization, all capitalizable cost rows on the Asset Acquisition Detail page are marked as capitalized. Therefore, the amount left to be capitalized is 0 until you add more capitalizable cost rows to the Asset Acquisition Detail page.

Field or Control	Description
Left to Non Capitalize	After capitalization, all non-capitalizable cost rows on the Asset Acquisition Detail page are marked as non capitalized. Therefore, the amount left to be non capitalized is 0 until you add more non-capitalizable cost rows to the Asset Acquisition Detail page.
Accum Depr (accumulated depreciation)	For capitalized assets, enter the amount of depreciation already recognized. If you are adding assets that have depreciation from prior years or prior periods, enter that amount in this field.

Note: As long as all acquisition detail lines are for the same set of ChartFields (Product, Project, Department) and for the same category and cost type, you can enter them all at once and capitalize them later by clicking the **Capitalize** button. However, if you enter acquisition detail lines for more than one set of ChartFields and for more than one category and cost type, you must enter and capitalize the acquisition detail lines for each set of ChartFields and for each category and cost type separately.

Related Links

“Setting Up Asset Profiles” (Asset Lifecycle Management Fundamentals)

Asset Acquisition Detail Page – Entering Multiple Cost Adjustments

To enter multiple transactions and adjustments for an asset without exiting the component, access the Asset Acquisition Detail Page.

Navigation:

Asset Management, Asset Transactions, Owned Assets, Basic Add, Asset Acquisition Detail.

This example illustrates the fields and controls on the Asset Acquisition Detail (1 of 6). You can find definitions for the fields and controls later on this page.

The screenshot shows the 'Asset Acquisition Detail' page for Unit US001, Asset ID 00000000115, Tag 575757, In Service. The 'Acquisition Details' section includes fields for Description (ACQ1), System Source (AM Online Entry Page), Incentive ID, Quantity (1.0000), Amount (10,000.00), Sales Tax (0.00), Use Tax (0.00), Freight (0.00), Misc Charge (0.00), and Total Amount (\$10,000.00). The '*Capitalize' dropdown is set to 'To be Capitalized'. The 'Capitalization Information' section shows Profile ID (MACHINERY), Rate Type (CRRNT), Default Book (CORP), Trans Date (10/02/2012), Acctg Date (10/02/2012), and a 'Capitalize' button. A table below shows 'Left to Capitalize' with Quantity 1.0000 and Amount 10,000.00 USD.

In the example pictured, the first acquisition line is entered (ACQ1 in this example). The page displays the Capitalize button once the **To be Capitalized** field value is selected as the Capitalize option.

Click the **Capitalize** button and save. Without leaving the page, click the Add a New Row button to add the next transaction:

This example illustrates the fields and controls on the Asset Acquisition Detail (2 of 6). You can find definitions for the fields and controls later on this page.

The screenshot shows the 'Asset Acquisition Detail' page for Unit US001, Asset ID 00000000113, Drill Press 5, Tag 595959, In Service. The 'Acquisition Details' section includes fields for Description (ACQ1), System Source (AM Online Entry Page), Incentive ID, Quantity (1.0000), Amount (10,000.00), Sales Tax (0.00), Use Tax (0.00), Freight (0.00), Misc Charge (0.00), and Total Amount (\$10,000.00). The '*Capitalize' dropdown is set to 'Already Capitalized'. The 'Capitalization Information' section shows Profile ID (MACHINERY), Rate Type (CRRNT), Default Book (CORP), Trans Date (10/02/2012), Acctg Date (10/02/2012), and a 'Capitalize' button. A table below shows 'Left to Capitalize' with Quantity 1.0000 and Amount 10,000.00 USD.

Add a non-capital acquisition line for the asset (ACQ2 in this example) as follows:

This example illustrates the fields and controls on the Asset Acquisition Detail (3 of 6). You can find definitions for the fields and controls later on this page.

The screenshot shows the 'Asset Acquisition Detail' page for Unit US001, Asset ID 00000000115, Drill Press 4, Tag 575757, In Service. The 'Acquisition Details' section includes fields for Description (ACQ2), System Source (AM Online Entry Page), Incentive ID, Quantity (1.0000), Amount (20,000.00), Sales Tax (0.00), Use Tax (0.00), Freight (0.00), Misc Charge (0.00), Total Amount (\$20,000.00), and *Capitalize (Never Capitalize). The 'Non Capitalization Information' section shows Profile ID (MACHINERY), Rate Type (CRRNT), Default Book (CORP), and a table for 'Left to Non Capitalize' with Quantity 1.0000 and Amount 20000.00 USD. A 'Non-Capitalize' button is visible.

Once you select the **Never Capitalize** field value, the **Non-Capitalize** button appears. Click the **Non-Capitalize** button and save the transaction:

This example illustrates the fields and controls on the Asset Acquisition Detail (4 of 6). You can find definitions for the fields and controls later on this page.

The screenshot shows the 'Asset Acquisition Detail' page for Unit US001, Asset ID 00000000115, Drill Press 4, Tag 575757, In Service. The 'Acquisition Details' section is identical to the previous screenshot, but the *Capitalize field is now 'Already Non Capitalized'. The 'Capitalization Information' section shows Profile ID (MACHINERY), Rate Type (CRRNT), Default Book (CORP), and a table for 'Left to Capitalize' with Quantity 1.0000 and Amount 0.00 USD. A 'Capitalize' button is visible.

Add a third transaction row, to be capitalized. Stay on the page and click the **Add a New Row button**. For the third row (ACQ3 in this example), select the **To be Capitalized** field value. Note that the **Capitalize** button is available, and the Left to Capitalize amount correctly reflects the amount remaining to capitalize for the asset:

This example illustrates the fields and controls on the Asset Acquisition Detail (5 of 6). You can find definitions for the fields and controls later on this page.

Click the **Capitalize** button and save:

This example illustrates the fields and controls on the Asset Acquisition Detail (6 of 6). You can find definitions for the fields and controls later on this page.

In this example, if one of the *To be Capitalized* lines were not yet capitalized, the **Capitalize** button is visible and available. If you proceed to save, you are presented with a warning reminding you that you have amounts to be capitalized that have not yet been capitalized. You can choose to save anyway or go back and capitalize those amounts.

If one of the non capital lines still has a status of *Never Capitalize*, the Non-Capitalize button is visible and available.

Tax Page

Use the Tax page (ASSET_ACQ_DET_VAT) to enter tax information for the asset.

This feature is available only if the business unit is activated for value-added tax (VAT) processing.

Navigation:

Click the **Tax** link on the Asset Acquisition Detail page.

Note: This link appears only when the business unit is activated for value-added tax (VAT) processing.

This example illustrates the fields and controls on the Tax page. You can find definitions for the fields and controls later on this page.

Tax

Transaction Type: Adjustment Date:

Currency: Base Currency:

Merch amt <input type="text" value="0.00"/>	Merchandise Base Amount <input type="text" value="0.00"/>
Recoverable VAT <input type="text" value="0.00"/>	VAT Recovery Base Amount <input type="text" value="0.00"/>
Non-Recoverable <input type="text" value="0.00"/>	Non-Recoverable Base Amount <input type="text" value="0.00"/>
Total Tax <input type="text" value="0.00"/>	Total VAT Base Amount <input type="text" value="0.00"/>

Optional

Tax Code Use Type

Tax Percent VAT Taxable Activity Percent

Enter tax information for the asset.

Note: This information is optional except where VAT is applied. The system only validates the tax amounts entered; it does not store them.

Related Links

- “VAT Defaults Setup Page” (Asset Lifecycle Management Fundamentals)
- “Understanding VAT” (PeopleSoft Global Options and Reports)

Doc Sequencing Page

Use the Doc Sequencing (document sequencing) page (AM_DOC_SEQ) to enter document sequencing information.

Navigation:

Asset Management > Asset Transactions > Owned Assets > Basic Add > Doc Sequencing

This example illustrates the fields and controls on the Doc Sequencing page. You can find definitions for the fields and controls later on this page.

General Information | Operation/Maintenance | Asset Acquisition Detail | **Doc Sequencing** | Location/Comments/Attributes

Unit: DEUE1 Asset ID: 00000000001 Building: German Tag: In Service

Doc Sequence Info Personalize | Find | | First 1-3 of 3 Last

#	Asset Book Name	Document Type	Journal Code	Doc Sequence #	Doc Seq Date
1	ASSETS_EUR	AM-ADD	ASSETS	NEXT	
2	ASSETS_DEM			NEXT	
3	ASSETS_USD			NEXT	

Document sequencing is enabled at the general ledger business unit level. Rows are editable or not depending upon the **Keep Ledgers in Sync** option defined at the ledger group level. If it is enabled, then only the primary ledger is editable; if it is not enabled, all the books that post entries to General Ledger are editable.

Related Links

“Defining Document Sequencing” (Asset Lifecycle Management Fundamentals)

Location/Comments/Attributes Page

Use the Location/Comments/Attributes page (ASSET_IMAGE) to record the location and physical properties of the asset (such as color, height, and weight) and store comments about it; view a stored image of the asset.

Navigation:

Asset Management > Asset Transactions > Owned Assets > Basic Add > Location/Comments/Attributes

This example illustrates the fields and controls on the Location/Comments/Attributes page. You can find definitions for the fields and controls later on this page.

The screenshot displays the 'Location/Comments/Attributes' page for an asset. The top navigation bar includes tabs for 'General Information', 'Operation/Maintenance', 'Asset Acquisition Detail', 'Location/Comments/Attributes' (which is active), and 'Manufacture/License/Custodian'. Below the tabs, the asset details are shown: Unit US001, Asset ID 00000000091, Automobile, Tag, and In Service. The 'Location' section is expanded, showing a search bar and a list of location details. Fields include Effective Date (09/19/2003), Effective Sequence, Location (US001), Area ID, Address 1 (144 North Street), City (New York), County, State (NY), Country (USA), Geo Code, Document, Building, Floor #, Room# (845), Jurisdiction, Sector, and Postal (10168). There are also fields for Latitude (40.510000) and Longitude (73.700000). At the bottom, an 'Authorization' section contains fields for Status, Name, and Date.

This example illustrates the fields and controls on the Location/Comments/Attributes page. You can find definitions for the fields and controls later on this page.

This example illustrates the fields and controls on the Location/Comments/Attributes page. You can find definitions for the fields and controls later on this page.

Attribute	Attribute Name	Value	UOM
<input type="text"/>		<input type="text"/>	<input type="text"/>

Record an asset's location and physical properties (such as color, height, and weight), enter comments, a detailed description, and associate user-defined custom attributes. You can also use this page to attach and view an image of the asset.

Field or Control	Description
Map It	<p>Click the Map It button from the Location/Comments/Attributes page to view the location of the asset on a map.</p> <p>This button appears on this page when you select the GIS Integration Enabled check box from the “Installation Options - Overall Page” (Application Fundamentals) and enable the integration at the Asset Management business unit level from the Asset Management Definition - Interface Options Page. Once enabled you can map assets using the Asset Map Dashboard and from the Basic Add component.</p>

Note: PeopleSoft does not automatically update the Latitude or Longitude fields in the location definition. These must be entered manually.

Map It - Asset Location Map

Visual assistants, such as maps, significantly improve the performance of locating and viewing assets for planning maintenance and deployment. Integration with ESRI ArcGIS Online enables the display of assets on a map from the Basic Add - Location/Comments/Attributes page. Access the Asset Location Map by clicking the Map It button:

This example illustrates the fields and controls on the Map It - Asset Location Map. You can find definitions for the fields and controls later on this page.

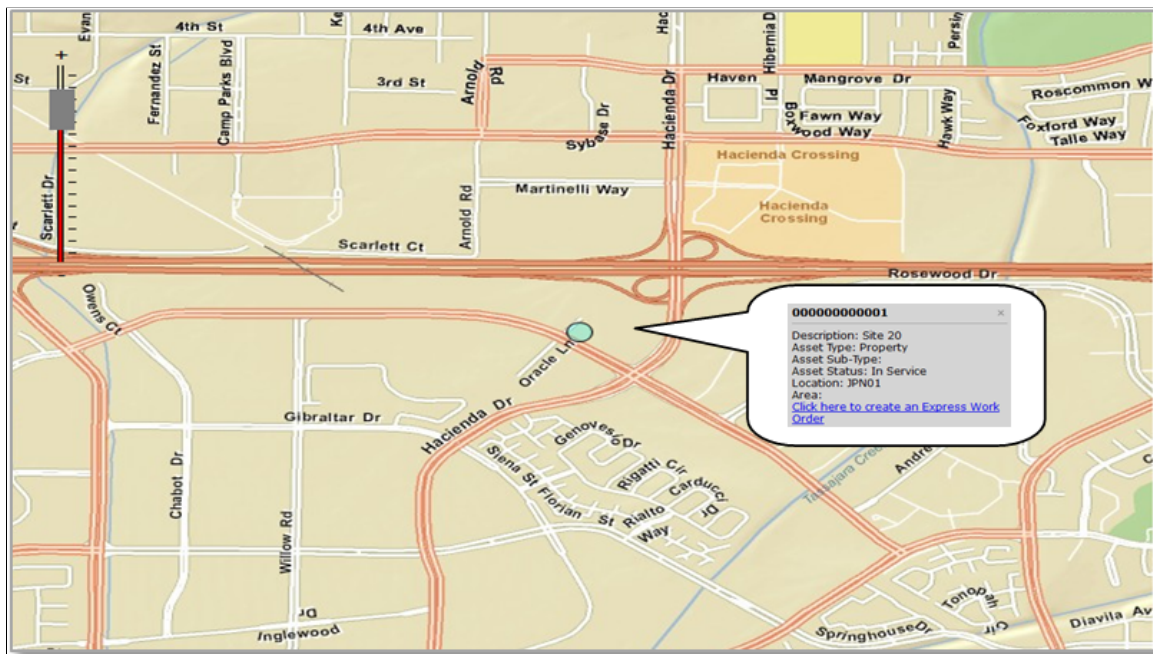

A callout box appears when you click the location dot in the modal window (once you click the Map It button). This callout shows asset information and a link where you can access the Express Work Order page to create an express work order for the asset, if needed.

To enable the map functionality, see the **Map It** field description on the [Location/Comments/Attributes Page](#). The GIS integration uses ArcGIS Web Mapping JavaScript APIs to embed maps in PeopleSoft. The ArcGIS JavaScript API is owned by ESRI and is subject to Terms of Use.

Manufacture/License/Custodian Page

Use the Manufacture/License/Custodian page (ASSET_CUSTODIAN) to record custodial information, maintain license information, and store manufacturer-related information.

Navigation:

Asset Management > Asset Transactions > Owned Assets > Basic Add > Manufacture/License/Custodian

Or click the **More Manufacturer Info** link on the Operation/Maintenance page.

This example illustrates the fields and controls on the Manufacture/License/Custodian page (1 of 2). You can find definitions for the fields and controls later on this page.

General Information | Operation/Maintenance | Asset Acquisition Detail | Location/Comments/Attributes | **Manufacture/License/Custodian** >

Unit US001 Asset ID 00000000001 SOLARIS WORKSTATION Tag SW1234 In Service

Manufacturer Information

Serial ID 00000000001

Manufacturer ID

Manufacturer Name

Model

Product Version Production Date

Plant Contact

VIN SKU

Physical Life Information

In Service Date 05/01/2000

Life Expectancy Yrs 45.00 Life Expectancy Note Average life expectancy for this asset type

End of Support 01/01/2000 End of Support Note Support has ended

End of Life End of Life Reason Scrap

Replacement 05/01/2045

Life Expectancy % 44.77

License Information

This example illustrates the fields and controls on the Manufacture/License/Custodian page (2 of 2). You can find definitions for the fields and controls later on this page.

Custodian Information | 1 of 1 | View All

Effective Date 05/01/2000 Effective Sequence 0 + -

Custodian This Asset is Offsite

Empl ID

Authorization

Status Not Authorized Date

Name

Chartfields

Operating Unit

Fund Code

Department

Program Code

Class Field

Budget Reference

Product

Project

Record custodial information, maintain license information, and keep track of manufacturer-related information.

Physical Life Information

Use this section to track the physical life of an asset, determine the life expectancy of equipment, and plan for equipment replacement.

The fields in this section are physical asset attributes only and are not used to calculate and record the accounting of asset cost or depreciation.

Field or Control	Description
In Service Date	<p>Displays the in-service date from the asset record.</p> <p>This date is used in the life expectancy and replacement date calculations, and is defined using the General Information Page. It is labeled as Placement Date.</p>
Life Expectancy Yrs (Life Expectancy Years)	<p>Enter the life expectancy of the asset in years. This is the physical life expectancy, not the depreciation (accounting) expectancy.</p>
End of Life	<p>Enter the end of life date for the asset.</p>
End of Life Reason	<p>Select a reason for the end of life.</p> <p>Values for this field are defined on the “End of Life Reason Definition Page” (Asset Lifecycle Management Fundamentals).</p>
Replacement (Date)	<p>Displays the estimated date in which the asset should be replaced.</p> <p>Replacement date is determined in this way:</p> <ul style="list-style-type: none"> • When End of Life date is provided, replacement date is the end of life date. • When End of Life date is not provided, replacement date is <i>In Service Date + Life Expectancy Years</i>.
Life Expectancy % (Life Expectancy Percent)	<p>Displays the current age expressed as a percent of life expectancy.</p> <p>Life Expectancy Percent is determined in this way:</p> $\text{Asset Age (Current Date - In Service Date) / Life Expectancy Years} * 100$ <p>For example, asset age 2.5 years / life expectancy 7 years * 100 = 35.71% of total life expectancy.</p>

Note: The Define Asset Operational Information - Asset Information Page has the same physical life fields included on this page. When you make an update to the physical life fields on that page, the changes are reflected here.

Asset Property Page

Use the Asset Property page (ASSET_PROPERTY) to enter details to manage property assets and to maintain property-specific attributes such as identifying information, asset hierarchy, area and occupancy, and legal descriptions.

This page appears when:

- the *Property* asset type is selected.
- the **Enter Property Details** option is selected on the Installation Options - Asset Management page for users licensed for Asset Management only.

Navigation:

Asset Management > Asset Transactions > Owned Assets > Basic Add > Asset Property

This example illustrates the fields and controls on the Asset Property page. You can find definitions for the fields and controls later on this page.

Property Information

This page appears when the asset type of *Property* is selected; however, if Lease Administration is not a selected product within Installation Options or **Space Management Installed** is not selected within the Asset Management Installation Options, the Property page does not appear.

<i>Field or Control</i>	<i>Description</i>
Property ID	The property asset ID is displayed after the record is saved.
Property Class	Select the property class from the available options. PeopleSoft delivers the following hierarchy of property classes: <i>Site</i> <i>Building</i> <i>Floor</i> <i>Area</i> <i>Space</i>
Property Subclass	Select the property subclass from the available user-defined options, if any.
Property Name and Description	Enter the property name and descriptions. If these are entered on the General Information page, they will follow to this page.

Hierarchy

<i>Field or Control</i>	<i>Description</i>
Parent Property	Select the parent property ID. Only the property asset IDs within this business unit are available.
Site ID	Enter the site property ID.
Building ID	Enter the building property ID. The field is available when the site property ID has been populated. The system performs an edit to check that higher level hierarchical fields are populated.
Floor ID	Enter the floor property ID. The field is available when the site property ID and the building property ID have been populated. The system performs an edit to check that higher level hierarchical fields are populated.

Field or Control	Description
Area ID	Enter the area property ID. The field is available when the site property ID, building property ID, and floor property ID have been populated. The system performs an edit to check that higher level hierarchical fields are populated.

Note: The last hierarchical definition for a property is *Space*. The space property ID is the same as the Property ID and is not displayed at this level.

Attributes

Field or Control	Description
Total Area	Enter the total measurement of the area of the property.
Unit of Measure	Enter the unit of measure for the total area. If this field is unavailable for selection, the unit of measure is populated by default from the information selected when the asset was entered.
Occupancy	Select the occupancy status of the property from the available values: <i>Occupied</i> or <i>Vacant</i> .
Current Occupancy	Enter the current number of occupants for the property.
Ownership	Select the ownership status of the property from the available options: <i>Owned</i> or <i>Leased</i> .
Maximum Occupancy	Enter the maximum number of occupants for the property. This may be a legal definition.
Occupants Information	Click this link to access the Maintain Property Occupants page. On this page, you can add property occupant details such as occupant type, occupant ID, move in and move out dates, as well as asset components.

When no hierarchy is established, the default values for **Unit of Measure** is *Feet*, for **Occupancy**, *Occupied*, and for **Ownership** is *Owned*.

When a parent property ID is established, then unit of measure, occupancy, and ownership values are inherited from the parent property.

When the parent property ID changes, however, only the unit of measure is inherited from the parent. This is because ownership and occupancy values do not usually change from parent to parent asset. For

example, if Property A is leased but the parent ID changes, the property does not change ownership. It is still leased. Similarly, if a parent property changes, it does not automatically change from occupied to vacant.

Note: If you have defined custom attributes on the Asset Attributes page to be associated with an asset, the asset attributes will display with a unit of measure field. You can select the appropriate attributes from your user-defined attributes for this property as needed.

Description

This section is available only if the asset is a property defined as a site or building.

<i>Field or Control</i>	<i>Description</i>
Parcel Number	Enter the parcel number, usually provided within the grant or deed of trust.
Lot Number	Enter the lot number, usually provided within the grant or deed of trust.
Block Number	Enter the block number, usually provided within the grant or deed of trust.
Legal Description	Enter the legal description, usually provided within the grant or deed of trust.

Record Property Taxes Page

Use the Record Property Taxes page (ASSET_PROP_TAX) to Enter property tax details including due dates, taxing authorities, and payments.

Navigation:

Click the **Enter Property Taxes** link on the Asset Property page.

This example illustrates the fields and controls on the Record Property Taxes page. You can find definitions for the fields and controls later on this page.

Record Property Taxes

Unit US001 Asset ID 00000000098 Tag In Service

Property ID 0000000318

Property Description Site NO 2344/89

Property Name Site NO 2344/89

Parcel Number

Lot Number

Block Number

Legal Description

Property Taxes

*Tax Year	*Tax Due Date	*Delinquent	*Authority	*Tax	*Installation	*Amount	*Tax Basis	*Curr
2003	06/30/2003	07/31/2003	NYS	Miscellaneous Property Ta	1	350.00	1.00	USD
2004	06/30/2004	07/31/2004	NYS	Miscellaneous Property Ta	1	350.00	1.00	USD

If the asset property is defined as *Site* or *Building*, the **Enter Property Taxes** link is available on the Asset Property page. Click the link to display the Record Property Taxes page where informational data can be entered for taxes applicable to the property.

Asset Supplemental Data Page

Use the Asset Supplemental Data page (AM_ASSET_SD) to record additional data based upon asset business unit, asset type, subtype, manufacturer, and model.

Navigation:

Asset Management > Asset Transactions > Owned Assets > Basic Add > Asset Supplemental Data

This example illustrates the fields and controls on the Asset Supplemental Data page. You can find definitions for the fields and controls later on this page.

Asset Acquisition Detail | Location/Comments/Attributes | Manufacture/License/Custodian | **Asset Supplemental Data**

Unit US001 Asset ID 000000000001 SOLARIS WORKSTATION Tag In Service

Hardware Information

ADSL Modem Processor Pentium I

Cable Modem RAM Memory 32.00

Bluetooth Type of Sound Card Offboard

Disk Space 12.00 Sound Card

Type of Media

Maintenance Information

Company PEOPLESOFT Last Maint. Date 05/01/2000

Contact SMITH,JOHN

Supplemental data is used within PeopleSoft Maintenance Management for additional asset attribute details. The attribute groups displayed for each asset depend upon the values that are selected for the asset type, asset subtype, manufacturer, model, and business unit. The attributes displayed are user-defined and reflect how the attribute groups work.

See “Defining Asset Attributes” (Asset Lifecycle Management Fundamentals).

See “Understanding Supplemental Data” (PeopleSoft Maintenance Management).

IoT (Internet of Things) Page

Use the IoT (Internet of Things) page (AM_IOT) to assign Internet of Things attributes to your asset and monitor changes to the asset. This page only displays when you select the IoT Installed option on the Installation Options - Asset Management page.

Navigation:

Asset Management > Asset Transactions > Owned Assets > Basic Add > IoT

This example illustrates the fields and controls on the IoT (Internet of Things) page.

Field or Control	Description
Organization	Select an IoT organization attribute to assign to this asset. Note: You can also specify IoT organization using the Upload Assets to IoT (Oracle Internet of Things) Page .
Asset Name	Displays IoT asset name assigned to this asset. IoT asset name is not the same as the PeopleSoft asset name. The IoT asset name is derived using PS + business unit name + asset ID.
Place Name	Select an IoT place name attribute to assign to this asset. When an asset move is detected by IoT, this field automatically updates with the correct effective-dated IoT location. Note: You can also specify IoT place name using the Upload Assets to IoT (Oracle Internet of Things) Page .

Field or Control	Description
Asset Type	<p>Select an IoT asset type attribute to assign to this asset.</p> <hr/> <p>Note: IoT asset type is not the same as PeopleSoft asset type.</p> <hr/> <p>Note: You can also specify IoT asset type using the Upload Assets to IoT (Oracle Internet of Things) Page.</p> <hr/>
Description	<p>You can edit the IoT description for this asset if you wish to do so.</p> <hr/> <p>Note: This description defaults from the Basic Add - General Information page. You can also specify IoT asset description using the Upload Assets to IoT (Oracle Internet of Things) Page.</p> <hr/>

See also:

“Understanding the Integration with Oracle Internet of Things Asset Monitoring Cloud Service” (Asset Lifecycle Management Fundamentals)

“Installation Options - Asset Management Page” (Application Fundamentals)

[Upload Assets to IoT \(Oracle Internet of Things\) Page](#)

External Funding Source Page

Use the External Funding Source page (ASSET_EFS) to associate an asset with an external funding source. In this way you can identify and closely monitor assets that must meet specific sponsor requirements and internal policies.

Navigation:

Click the External Funding Source link on the General Information page.

This example illustrates the fields and controls on the External Funding Source page.

The screenshot shows a web application window titled "External Funding Source". At the top right, there is a "Help" link. Below the title bar, there is a search bar with a magnifying glass icon and a "View All" link. The main content area contains a table with the following columns: "External Funding Source", "Description", and "Comment". The first row of the table has a search input field under the "External Funding Source" column, and plus and minus buttons under the "Comment" column. At the bottom of the window, there are "OK" and "Cancel" buttons.

<i>Field or Control</i>	<i>Description</i>
External Funding Source	Select an external funding source to associate with the asset. External funding sources are defined on the “External Funding Source (Setup) Page” (Asset Lifecycle Management Fundamentals).

Maintaining Asset Meters

This topic provides an overview of asset meters and discusses how to maintain Asset Meters.

Pages Used to Maintain Asset Meters

<i>Page Name</i>	<i>Definition Name</i>	<i>Usage</i>
<u>Asset Meters Page</u>	ASSET_METER	Define asset meter by assigning meter types and associate the meter to assets.
<u>Entering Meter Readings Page</u>	AM_METER_READ1	Enter meter readings for an asset.
Prior Reading	AM_METER_READ2	Enter prior meter reading information.
Update Meter Readings	AM_MTR_RD_UPD	You can use the Update Meter Readings page to correct prior meter readings.
Meter Reading Comments	AM_MTR_RD_CMT	Enter comments relevant to meter reading updates.

Page Name	Definition Name	Usage
Meter Readings History Page	AM_MTR_RD_HIS	View meter reading history for an asset.
Meter Reading Details Page	AM_MTR_RD_HID	View details about the meter reading history for an asset including the date/time, source operator ID, and daily average. Meter Readings History Page

Understanding Asset Meters

Meters associated with assets are used to monitor asset usage and can trigger maintenance tasks based on the statistical units, such as mileage, measured by the meter. For example, a common asset meter is the odometer installed in a company vehicle that measures the number of miles the vehicle has traveled. For this type of asset, it is common for certain maintenance activities to be performed on it based on the number of miles traveled by the vehicle since the last maintenance event.

A less common, but familiar application, involves public utilities. State and local agencies use asset monitoring devices such as a water or electric meters attached to a home or commercial entity to measure the amount of water or electricity consumed by the entity. The units consumed are measured on a routine basis and the occupant is usually billed for the units consumed. The maintenance events associated with these types of meters may not have anything to do with the number of units measured since the meter was last read and other maintenance plans will have to be affected.

PeopleSoft uses meters to both measure asset usage and to trigger preventive maintenance tasks. Asset meter activities are performed within PeopleSoft Asset Management and PeopleSoft Maintenance Management applications. To enable meters, you must first define asset meter types. The meter types are associated with specific asset IDs.

Asset Meters Page

Use the Asset Meters page (ASSET_METER) to define asset meter by assigning meter types and associate the meter to assets.

Navigation:

Asset Management > Service and Maintenance > Asset Meter Information > Establish Meter Reading > Asset Meters

This example illustrates the fields and controls on the Asset Meters. You can find definitions for the fields and controls later on this page.

Asset Meters									
Unit US001									
Asset ID 000000000004 Gas/elec hybrid - fleet vehicl					Tag P00000009003 In Service				
Meters									
Meter Type	Status	Copy to Comp.	Est. Daily Avg.	Override Avg.	Act. Daily Avg.	Required for Work Order	Primary		
1 ODOMETER	Active	<input checked="" type="checkbox"/>	10.0000	<input type="checkbox"/>	10.0000	<input type="checkbox"/>	<input type="checkbox"/>	<input type="button" value="+"/>	<input type="button" value="-"/>
2 THICKNESS	Active	<input type="checkbox"/>	0.0000	<input type="checkbox"/>		<input type="checkbox"/>	<input type="checkbox"/>	<input type="button" value="+"/>	<input type="button" value="-"/>

Field or Control	Description
Meter Type	Select the meter type to be associated to this asset.
Copy to Comp. (copy to component)	<p>Select if this meter should also be associated with any asset components associated with this asset (optional). This enables the component asset to use the same meter reading variations entered for its higher-level component assets.</p> <p>The meter reading inheritance rules are as follows:</p> <ul style="list-style-type: none"> • The subcomponent inherits the reading from its immediately higher level component. <p>If the higher component is also enabled to copy readings, the asset continues escalating to higher levels until finding the asset that is not enabled to inherit readings, or the parent asset. The inherited reading is derived from this asset.</p> <ul style="list-style-type: none"> • The inherited reading is recorded in the component when it is saved at the higher asset level. • Components cannot inherit readings from upper levels if any intermediate level has its inherit reading option turned off. <p>For example, assume three levels of components: grandparent, parent, child. All use an odometer as the meter ID type but the parent asset has the copy option deselected. In this example, the child cannot inherit its grandparent's odometer reading.</p> <hr/> <p>Note: The example is used to describe the physical inheritance rules of meter readings and has no relationship to the Parent-Child financial transaction in Asset Management.</p> <hr/> <ul style="list-style-type: none"> • Components cannot inherit readings from upper levels if any intermediate level does not have the same meter type defined across the different levels. <p>For example, an asset has three levels of components, <i>A</i>, <i>B</i>, and <i>C</i>. A meter type is associated with asset <i>A</i> and <i>C</i>, but not <i>B</i>; in this case, <i>C</i> would not inherit its meter reading from <i>A</i>. As assets <i>B</i> and <i>C</i> are both components of asset <i>A</i>, then <i>B</i> must also inherit readings from <i>A</i>, or neither asset <i>B</i> nor <i>C</i> may inherit readings from <i>A</i>.</p>
Est. Daily Avg. (estimated daily average)	Displays the estimated average based on the actual readings taken when the number of readings specified to calculate the daily average has not been reached. The field is available when the meter type is enabled to maintain daily average. Estimated daily average is always a positive value.

Field or Control	Description
Override Avg. (override average)	Select to override the actual daily average. The field is available when the meter type is enabled to override the actual daily average.
Act. Daily Avg. (actual daily average)	Displays the system-calculated actual daily average. It can be zero or greater than zero. You can edit the value if the Override Avg. option is selected, but a new average is calculated when a new meter reading is entered. The field is available when the Maintain Average option is enabled for the meter type.
Required for Work Order	Select to override a meter as required for any kind of work order as a condition to change its status to complete. This option defaults from the Meter Type Definition page and can be overridden here on the Asset Meters page. This field displays only if PeopleSoft Maintenance Management is installed.
Primary	Designate the primary meter type for the asset. This is used in the Asset Maintenance Cost Analysis online component in PeopleSoft Maintenance Management.

Entering Meter Readings Page

Use the Enter Meter Readings page (AM_METER_READ1) to enter meter readings for an asset.

Navigation:

Asset Management > Service and Maintenance > Asset Meter Information > Enter Meter Reading

This example illustrates the fields and controls on the Enter Meter Readings page. You can find definitions for the fields and controls later on this page.

Current Reading		Personalize Find First 1-3 of 3 Last										
	Activate	Date	Time	Meter Type	Reading	Variation	Rollover	Replaced	Accum. Reading	UOM	Comments	
1	<input checked="" type="checkbox"/>	12/18/2012	9:24:49AM	ODOMETER	0.000000	0.0000	<input type="checkbox"/>	<input type="checkbox"/>		MIL	Comments	+ -
2	<input checked="" type="checkbox"/>	12/18/2012	9:24:49AM	THICKNESS	0.000000	0.0000	<input type="checkbox"/>	<input type="checkbox"/>		IN	Comments	+ -

Enter current reading information in the work area.

Field or Control	Description
Activate	Select this check box to activate entries for the row.

Field or Control	Description
Date and Time	Enter the date and time of the meter reading. The system current date and time displays by default.
Meter Type	(Required) Select a valid meter type for this asset ID. Valid meter types are those that are associated with the asset and active.
Reading and Variation	(Required) Record the current meter reading. Enter either the actual reading or variation from the last reading. If you had a reading of 12,000 km for an odometer and now you have 12,450 km, you can enter 450 in the variation field or 12,450 km in the Reading field above. The system automatically calculates the value for one field based on the entry made to the other field. The variation is used for the Copy to Components function. Variation is validated so that the reading does not fall outside the low and high limits established for the meter when the Reading field is automatically calculated. The Variation and Reading fields are both required when you have selected the Replaced option.
Rollover	Check this option if rollover is enabled <i>and</i> should only be selected when the meter surpasses the upper limit. When selected, the meter resets to zero on the Assets Meters page once this reading is saved. When the meter passes its established upper limit and begins a new cycle, the system keeps track of the accumulated usage. This applies only to <i>increasing</i> and <i>decreasing</i> meter types that also have enabled the Allow Rollover option.
Replaced	Select this option when the meter tool has been replaced. Both the Reading and Variation fields must be completed in this instance. This enables the system to calculate the total accumulated reading for the selected meter type. In the Reading field, enter the actual reading measured in terms of the new meter. In the Variation field, enter the difference between the last reading and the new one. These entries will be the basis to recalculate the accumulated meter reading when the page is saved.
Accum. Reading (accumulated reading)	The last accumulated reading displays. If the Replaced option is selected, or if this is the first reading of the asset, this field is enabled for edit. Enter the new accumulated reading or complete the Reading and Variations fields to recalculate accumulated reading.
UOM (units of measure)	Displays the units of measure for this type of meter.

The following validations occur when the page is saved:

- The meter type entered cannot be duplicated for the same date and time or the system generates an error message.
- The reading/variation field must be completed or the system generates an error message.
- The accumulated reading or variation and the reading fields must be completed when the replaced option is selected or the system generates an error message.
- Readings must fall into the lower and upper limit range established at the meter type definition level or the system generates an error message.
- If the meter type is increasing or decreasing and the user enters a lower or greater reading than the prior reading, the system will generate an error message.

If the meter type is increasing or decreasing *and* defined to allow rollover, the message warns that the rollover option must be selected before saving.

When you save the page, the meter readings entered become part of the meter history.

Using the Prior Reading tab, you can view the last entry made for the meter type. It also displays rollover or replacement activity from the prior meter reading.

You can enter comments related to a meter reading by using the **Comments** link.

Updates to meter readings can be entered to modify existing readings. When making changes to meter readings, the change impacts not only the variation/reading of the changed meter reading but also the variation of the immediately following reading. You can modify the meter reading dates; this may cause meter readings that do not follow the rules of variations for increasing type of readings and conversely for decreasing type of readings as this documentation outlines on the enter readings page. Daily average will only be recalculated if the change affects the last *n* numbers of readings, where *n* is the number of readings established at the meter type definition level. Modifying meter reading dates could end up in having meters out of sequence that is, not entered and listed from the oldest to the newest). For auditing purposes, select the option to keep track of that out-of-sequence entries.

Meter Readings History Page

Use the Meter Readings History page (AM_MTR_RD_HIS) to view meter reading history for an asset.

Navigation:

Asset Management > Service and Maintenance > Asset Meter Information > Meter Reading History

This example illustrates the fields and controls on the Meter Readings History page. You can find definitions for the fields and controls later on this page.

Meter Readings History

Business Unit US001

Asset ID 000000000002

Meter Type

Date From

To Date

Search

Readings										
	As of Date/Time	Meter Type	System Source	Rollover	Replaced	Reading	Variation	Accum. Reading	UOM	Detail
1	06/29/09 7:55AM	ODOMETER	AM	<input type="checkbox"/>	<input type="checkbox"/>	116234.000000	68845.0000	116234.0000	MIL	Detail
2	03/15/03 3:47PM	ODOMETER	AM	<input type="checkbox"/>	<input type="checkbox"/>	47389.000000	77.0000	47389.0000	MIL	Detail
3	03/13/03 12:00PM	ODOMETER	AM	<input type="checkbox"/>	<input type="checkbox"/>	47312.000000	307.0000	47312.0000	MIL	Detail
4	02/28/03 11:42AM	ODOMETER	AM	<input type="checkbox"/>	<input type="checkbox"/>	47005.000000	607.0000	47005.0000	MIL	Detail
5	02/02/03 5:28PM	ODOMETER	AM	<input type="checkbox"/>	<input type="checkbox"/>	46398.000000	414.0000	46398.0000	MIL	Detail
6	01/15/03 4:53PM	ODOMETER	AM	<input type="checkbox"/>	<input type="checkbox"/>	45984.000000	45984.0000	45984.0000	MIL	Detail
7	06/29/09 7:55AM	THICKNESS	AM	<input type="checkbox"/>	<input type="checkbox"/>	1.070000	-0.4900	4.9300	IN	Detail
8	06/03/03 9:22AM	THICKNESS	AM	<input type="checkbox"/>	<input type="checkbox"/>	1.560000	-0.4200	4.4400	IN	Detail
9	03/13/03 11:43AM	THICKNESS	AM	<input type="checkbox"/>	<input type="checkbox"/>	1.980000	-4.0200	4.0200	IN	Detail

Search for and review meter readings history by business unit and asset ID. You can further refine the results by entering a meter type and date range. The results display the following information.

Field or Control	Description
As of Date/Time	Displays the date and time of the meter reading listed.
Meter Type	Displays the type of meter associated to the asset and reading.
Rollover	If selected, indicates that a meter rollover occurred.
Replaced	If selected, indicates that a replaced reading was entered, usually due to a rollover.
Reading	Displays the meter reading entered for the meter reading listed.
Variation	Displays the calculated change from the prior meter reading.
Accum. Reading (accumulated reading)	Displays the accumulated readings.
UOM (units of measure)	Displays the units of measure for the meter type.

Maintaining Warranties

This topic provides an overview of asset warranties and lists the pages used to maintain asset warranties.

Pages Used to Maintain Asset Warranties

Page Name	Definition Name	Usage
Asset Warranty Page	ASSET_WARRANTY	Associate warranties to an asset ID and store warranty information including effective date, end date, coverage and contact information. Multiple warranties can be applied to a single asset.
Search for Asset Warranty Templates Page	AM_WTMPL_SRH	Search for warranty templates to apply to the asset. Templates are created by SetID. Search parameters include asset type, asset subtype, supplier ID, model, and item ID.

Understanding Asset Warranties

Many assets are acquired with a standard manufacturer's warranty that the asset is free of defects and what remedies are available to you if the asset manifests a warranted defect during normal use, such as eligibility for a replacement asset, or a loaner while the warranted asset is repaired. The warranty often defines the period for which the asset is warranted, the maintenance and repair responsibilities of the owner, and the procedures for making a claim in the event a defect in the asset is discovered.

Warranties are sometimes available for extension. This may involve the issuance of a separate warranty that becomes active when the original warranty expires. Or it may warrant components of the asset that the standard warranty excludes. A warranty may contain different expiry dates for different components of the asset. It may provide for on-site repairs, may require return material authorizations (RMA), and may or may not be transferable.

PeopleSoft provides the ability to set up standard warranties and associate a warranty to an individual asset and provides warranty templates to apply a standard warranty to multiple assets at one time.

Maintaining Asset Book Information

Add books to assets either by entering the assets through the Asset Express Add component or capitalizing them on the Asset Information page of the Asset Basic Information component.

The pages in the Asset Book Definition component enable you to enter book information that is *different* from that in your asset profile IDs.

This topic discusses how to maintain Asset Book information.

Pages Used to Maintain Asset Book Information

<i>Page Name</i>	<i>Definition Name</i>	<i>Usage</i>
<u>Book - Depreciation Page</u>	ASSET_BOOK_01	Identify the asset's books and some of the information needed for calculating depreciation. An asset can be linked to any number of books. Typically, separate books are required for financial and tax purposes.
<u>Depreciation Method Information Page</u>	ASSET_DEPR_DETAILS	Set special depreciation terms and select an accounting method for them. These are commonly used to meet depreciation requirements for specific countries.
<u>Book - Tax Page</u>	ASSET_BOOK_02	Specify property type, tax depreciation criteria, and tax credit options. If the fields on this page are not available, the book was not set up as a tax book on the Business Unit/Book Definition page.

Book - Depreciation Page

Use the Book - Depreciation page (ASSET_BOOK_01) to identify the asset's books and some of the information needed for calculating depreciation.

An asset can be linked to any number of books. Typically, separate books are required for financial and tax purposes.

Navigation:

Asset Management > Asset Transactions > Asset Book Information > Define Tax/Depr Criteria

This example illustrates the fields and controls on the Book - Depreciation page. You can find definitions for the fields and controls later on this page.

This example illustrates the fields and controls on the Book - Depreciation page. You can find definitions for the fields and controls later on this page.

Field or Control	Description
In Service Date	Enter the date that the asset was made available for use from a financial standpoint. This date and the depreciation convention determine when depreciation starts for this book. This date is reflected in the Begin Depr Date field.
Depreciate When In Service	Select to allocate annual depreciation as of the date that you placed the asset in service. If you do not select this option, PeopleSoft Asset Management allocates annual distribution as of the date determined by the depreciation convention. This option is valid only in the year that the asset was acquired.

Field or Control	Description
Convention	Enter the convention that the system uses to prorate depreciation for the asset. Asset Management is delivered with most standard depreciation conventions set up in the Depreciation Conventions table. The system derives the beginning depreciation date from the convention and the placed-in-service date. For example, if you began using an asset on May 3, 2006, and selected <i>Actual Month</i> as the depreciation convention, PeopleSoft Asset Management would begin depreciating this asset on May 1, 2006. If you selected <i>Following Month</i> as the convention, depreciation would begin on June 1, 2006.
Adjust Convention	Enter the adjustment convention that the system uses to prorate cost adjustments for the asset.
Retirement Convention	Enter the retirement convention that the system uses to prorate retirement for the asset.
Retire Option	Select the retirement calculation option to be processed for assets within a given book. These retirement options are available at the profile, book and asset levels. See Retire Assets Page .

Select a depreciation method in the **Depreciation Method** field. Some depreciation methods require you to enter additional information. Depending on the method that you select, additional fields will display as needed, and as described in the following table:

Asset Depreciation Method	Additional Fields
<i>Declining Balance w/SL by Limit %</i>	DB Pct (declining balance percent) and Limit Pct (limit percent)
<i>Declining Balance</i>	Percent , Low Limit , and Monthly
<i>Declining Balance w/SL</i>	DB Pct
<i>Depreciation Schedule</i>	Schedule
<i>Flat Rate %</i>	Percent , Low Limit , and Avg Option (averaging option)
<i>France Derogatory Balance</i>	DB Pct , Percent , Low Limit , and Depr Pass Life (depreciate past life)
<i>Germany Staffel Method</i>	DB Pct , Percent , Low Limit , and Depr Pass Life

Asset Depreciation Method	Additional Fields
<p><i>Japan - Changes 200/250 DB to SL</i> (J9 - Changes 200/250 Declining Balance to Straight Line)</p>	<p>No additional fields display. However, for this method you must select the Special Depreciation option and input the year of change on the Special Terms - Depreciation Method Information page.</p> <p>Used for assets that were added using the following methods:</p> <ul style="list-style-type: none"> • (J6) Japanese - Changes DB (Declining Balance) to SL (Straight Line) 250 • (J8) Japanese - Changes DB (Declining Balance) to SL (Straight Line) 200.
<p><i>Japan - Changes DB to SL 200</i> (J8 - Changes Declining Balance to Straight Line 200)</p>	<p>DB Pct, Percent, Low Limit, Depr Pass Life</p> <p>Used for assets acquired on or after April 1, 2012.</p>
<p><i>Japan - Changes DB to SL 250</i> (J6 - Changes Declining Balance to Straight Line 250)</p>	<p>DB Pct, Percent, Low Limit, Depr Pass Life</p> <p>Used for assets acquired on or after April 1, 2007.</p>
<p><i>Japan - Extended/Strt Line</i> (JE - Extended Straight Line)</p>	<p>DB Pct, Percent, Low Limit, Depr Pass Life</p> <p>Used for fully depreciated assets under the Tangible / Strt Line and Tangible / Declining Balance methods that are subject to an extended depreciation useful life of five years using a Straight Line depreciation method starting from the first period of the following fiscal year.</p>
<p><i>Japan - Lease Depreciation</i> (J4 - Lease Depreciation)</p>	<p>No additional fields display.</p>
<p><i>Japan - Intangible/Strt Line</i> (J3 - Intangible/Straight Line)</p>	<p>DB Pct, Percent, Low Limit, and Depr Pass Life</p>
<p><i>Japan - Tangible/Declining Bal</i> (J1 - Tangible/Declining Balance)</p>	<p>DB Pct, Percent, Low Limit, and Depr Pass Life</p> <p>Used for assets acquired before April 1, 2007.</p>
<p><i>Japan - Tangible/Strt Line</i> (J2 - Tangible/Straight Line)</p>	<p>DB Pct, Percent, Low Limit, and Depr Pass Life</p> <p>Used for assets acquired before April 1, 2007.</p>
<p><i>Japan - Changes DB to SL</i> (J5 - Changes Declining Balance to Straight Line)</p>	<p>DB Pct, Percent, Low Limit, Depr Pass Life</p>

Asset Depreciation Method	Additional Fields
<i>Japan - Tangible/Strt Line Rev</i> (J7 - Tangible/Straight Line Revenue)	DB Pct, Percent, Low Limit, Depr Pass Life Used for assets acquired on or after April 1, 2007.
<i>Manual Depreciation</i>	No additional fields display. The manual depreciation method enables you to adjust depreciation amounts using different method. To use manual depreciation, you must first create depreciation entries using another method. Once this has been done, you can make your adjustments.
<i>Straight Line</i>	No additional fields appear.
<i>Straight Line Percent</i>	Percent
<i>Sum of the Years</i>	No additional fields appear.
<i>Units of Production</i>	UOP ID (units of production ID)
<i>User Defined Method</i>	Method ID, DB Pct, Percent, Low Limit, and Depr Pass Life

The following table defines the additional fields:

Field or Control	Description
Limit Pct (limit percent)	Enter to specify a limit for depreciation as a percentage of cost.
UOP ID (units of production ID)	Enter the units-of -production ID, production information, and transaction information to use for the asset.
DB Pct (declining balance percent)	Enter the percentage of declining balance depreciation to be taken each year until the amount calculated by the straight line method is greater.
Percent	Enter the percentage of original basis to be taken in depreciation each year.
Low Limit	Enter an amount. When the asset basis reaches this limit, the remaining basis is taken in depreciation and the asset is fully reserved. Low limit is specific to group assets and flat rate.

Field or Control	Description
Depr Pass Life (depreciate past useful life)	Select this if you want to continue to depreciate this asset past its useful life. This option is used for certain countries' governmental regulations and in utilities industries to depreciate an asset to the end of a depreciation calendar.
Method ID	Enter the user-defined method to use.
Schedule	Enter a schedule to use for depreciation.
Avg Option (average option)	Generally, this field is used by utility companies to depreciate composite assets. The averaging options are expressly designed to work with the flat rate depreciation method.

Field or Control	Description
Monthly	Monthly averaging takes an average monthly asset balance and multiplies it by the annual depreciation rate. The result is then applied against a period allocation (1/12, 2/12, 3/12, and so on) to derive a year-to-date (YTD) depreciation amount. The difference between the newly calculated YTD depreciation and the previous YTD depreciation is the amount booked to the current period. This is applicable to the declining balance method only.
Yearly	Yearly averaging is similar to monthly averaging except that a yearly average balance is used. Because this amount is not known until the end of the year, it is usually estimated and adjusted periodically as the actual figures become available.

Note: Using the flat rate depreciation method causes any depreciation to be posted to the end of the calendar. If this is not the intention, you must enter a low limit of *.01* when you first select the depreciation method in the Asset Book Definition component for the asset. If you have not already done this, update the **Depreciation Method** field by selecting *Flat Rate* and entering *.01* in the **Low Limit** field that appears.

Field or Control	Description
Calculation Type	Select <i>Remaining Value</i> to deduct any accumulated depreciation from the cost basis and depreciate the remaining value over the remaining life of the asset. Most assets are depreciated using this option. Use <i>Life-to-Date</i> to calculate the difference between the depreciation allowed and the depreciation taken. Typically, you use life-to-date calculations when there is a change in accounting principle, such as depreciation method. Changes of this type require an adjustment for the differences in accumulated depreciation to date. For example, if you took 20,000 USD depreciation over a two year period but the amount allowed was 24,000 USD, the difference of 4,000 USD would be expensed as an adjustment to accumulated depreciation in the current period.
Low Value	Select to identify assets with costs below a certain level for special depreciation processing. This is a requirement for Germany.
Useful Life	Enter the number of periods. This is used to perform the depreciation calculations for the financial books.
End Depr Date (end depreciation date)	Enter a value to have depreciation end at a particular time. At the ending depreciation date, the remaining asset basis is taken in depreciation and the asset is fully reserved.
Future Depr Yrs (future depreciation years)	<p>Asset Management calculates and stores depreciation until the end of the asset's life. However, for optimal processing performance and greater table efficiency, you can specify a fixed number of years for which depreciation is calculated and stored.</p> <hr/> <p>Note: It is strongly recommended that you use the Future Depreciation Years option for group assets and for a large number of assets.</p> <hr/>
Special Depreciation or Special Terms	If you are working in a global environment and want to use special depreciation terms to meet specific country requirements, select the Special Depreciation check box and click Special Terms to open the Depreciation Method Information page, where you can select global attributes for depreciation.
Depr Limit (depreciation limit code)	Depreciation limits generally apply to tax books, but they can also be used for financial books. The tableset delivered with Asset Management contains depreciation limits currently dictated by the U.S. Internal Revenue Service for luxury automobiles.
Cost Basis Limit	Enter the limit on the depreciable basis of this asset. If the actual cost of an asset is greater than its depreciable basis, the difference produces a gain when the asset is retired.

Field or Control	Description
Salvage % (salvage percentage) and Salvage Value	Enter the residual value of the asset subtracted from the cost to determine the depreciable basis used in depreciation calculations. You can enter it either as a flat rate or as a salvage percentage (a percentage of the asset's total cost). If you use a salvage percentage, the system recalculates the salvage value as you add additional costs for the asset.
(DEU) Multi-Shift Code	Enter rates by which depreciation should be increased based on the number of production shifts an asset is used.
Threshold ID	If you want to modify an existing asset to use the capitalization threshold by book method, select the Threshold ID to use as the default value for assets within the selected book. This field is available for editing only when: <ul style="list-style-type: none"> • the Capitalization Threshold feature is enabled from the Installation Options - Asset Management page • the Threshold ID on the Basic Add – General Information page is unpopulated • the business unit where the asset is added uses it
Child Inherits Parent's Life	Select if the child asset inherits the parents remaining life. When you use parent-child component assets, all child assets have their own cost basis and depreciation attributes that are independent of the parent asset. Because the child's asset life may differ from the life of the parent asset, you may need to specify that a new child asset of a parent asset inherit the remaining life of the parent asset.
Impairment Process	Select to make an asset available for impairment processing. See Adjusting for Asset Impairment .
Comments	Click the Comments link to access the Book Depreciation - Comments page and view or add relevant supporting comments to an asset transaction.
Attachments	Click the Attachments link to access the Book Depreciation - Attachments page and view or add relevant supporting documents to an asset transaction.

Book Depreciation - Comments Page

Use the Book Depreciation - Comments page (AM_COMMENTS_SEC) and view or add relevant supporting comments to an asset transaction.

<i>Field or Control</i>	<i>Description</i>
Comment	Enter comments for an asset.
User ID, Name and Date/Time Stamp	Displays the user ID, name, and date/time stamp related to the user who added the comment. You can edit the date/time stamp after saving the comment.
Source	Displays the transaction source for the asset, such as adjustment, transfer, and so forth.

Book Depreciation - Attachments Page

Use the Book Depreciation - Attachments page (AM_ADD_ATTACH_SEC) to view or add relevant supporting documents to an asset transaction.

<i>Field or Control</i>	<i>Description</i>
Add Attachment	Click this button to attach files as supporting documentation for an asset. Supply a description of the file or files that you attach.
File Name	Displays the attached file. Click the file-link to access the file.
Description	Displays a description of the file attachment when one was provided by the user.
User, Name, and Date/Time Stamp	Displays the user ID, name, and date/time stamp related to the user who added the attachment.

Related Links

“Understanding Depreciation Processing” (Asset Lifecycle Management Fundamentals)

Depreciation Method Information Page

Use the Depreciation Method Information page (ASSET_DEPR_DETAILS) to set special depreciation terms and select an accounting method for them.

These are commonly used to meet depreciation requirements for specific countries.

Navigation:

Select the **Special Depreciation** check box and then click the **Special Terms** link on the Book - Depreciation page.

Select one of the following accounting method options:

Field or Control	Description
Allowance	Special depreciation amounts are not booked with the standard depreciation amounts. Journal entries are generated that include only the standard depreciation. PeopleSoft Asset Management does not support automatic generation of journal entries for the special depreciation <i>allowance</i> accounting method. You may need to run two reports—the Reserve for Special Depreciation report and the Reversal for Special Depreciation report—and then generate the journal entries manually into the General Ledger system.
Expense	Total amounts of special depreciation and standard depreciation are booked and journal entries are generated that include the total of the standard and special depreciation amounts.
Reserve	Special depreciation amounts are not booked with the standard depreciation amounts. Journal entries are generated that include only the standard depreciation. PeopleSoft Asset Management does not support automatic generation of journal entries for the special depreciation <i>reserve</i> accounting method. You may need to run two reports—the Reserve for Special Depreciation report and the Reversal for Special Depreciation report—and then generate the journal entries manually into PeopleSoft General Ledger.

Additional fields are provided to comply with the depreciation methods used in countries other than the U.S. If your current depreciation method requires these fields, enter **Special Terms**, **Accel Terms** (accelerated terms), **Initial Terms**, and **Incr Rate** (increased rate).

When you use additional terms, they affect depreciation calculations as follows:

Term	Depreciation
Special	Depreciation × Rate
Accelerated	Depreciation × Rate
Initial	Cost × Rate
Increase	Depreciation × Rate

The **Year of Change** field is available only if the depreciation method is *Japan-Change DB to SL*. Enter the year of the change in calculation methods.

See “Defining Depreciation Terms and Rates” (Asset Lifecycle Management Fundamentals).

Book - Tax Page

Use the Book - Tax page (ASSET_BOOK_02) to specify property type, tax depreciation criteria, and tax credit options.

If the fields on this page are not available, the book was not set up as a tax book on the Business Unit/Book Definition page.

Navigation:

Asset Management > Asset Transactions > Asset Book Information > Define Tax/Depr Criteria > Book - Tax

This example illustrates the fields and controls on the Book - Tax page. You can find definitions for the fields and controls later on this page.

Tax

Field or Control	Description
Property Type and Property Code	These fields determine the amount of gain treated as ordinary income upon the disposition of the asset.

Field or Control	Description
Regulation	<p>Regulation is an indication of the tax system that you elect. Each tax system has an effective date that is validated against the asset's placed-in-service date. Select a regulation to identify the depreciation system elected for this asset. Options are:</p> <ul style="list-style-type: none"> • <i>A</i> (accelerated): Accelerated Cost Recovery System (ACRS). • <i>D</i> (depreciation): Asset Depreciation Range (ADR). • <i>F</i> (facts): Conventional Facts and Circumstances. • <i>G</i> (guidelines): Asset Class Guideline. • <i>M</i> (modified): Modified Accelerated Cost Recovery System (MACRS).
Recovery Life and Recovery SubType	<p>For reporting purposes, you can further classify the asset by specifying the recovery life (expressed in years) and the recovery subtype. For example, the code for a 15-year life might be <i>15</i> and the code for low-income housing might be <i>LI</i>.</p>
Guideline Class	<p>All current U.S. classifications are set up in the Tax Class table in the delivered tableset</p>
Section 179	<p>You can elect to recover all or part of the cost of certain qualifying property, up to a limit, by deducting it in the year you place the property in service. You can elect the section 179 deduction instead of recovering the cost by taking depreciation deductions.</p>

Field or Control	Description
Listed Property	<p>Select the Listed Property check box to define the asset as listed property and select its Listed Property Type. Listed properties are certain kinds of assets that are conducive to mixed business and personal use, such as:</p> <ul style="list-style-type: none"> • Passenger automobiles under a certain weight. • Any other property used for transportation such as trucks, buses, boats, airplanes, motorcycles, and other vehicles for transporting persons or goods. • Any property of a type generally used for entertainment or recreation or amusement such as photographic, phonographic, communication, and video-recording equipment. • Any computer and related peripheral equipment unless it is used only at a regular business establishment and owned or leased by the person operating the establishment. • Any cellular telephone (or similar telecommunications equipment) placed in service or leased in a tax year beginning after 1989.
(FRA) Business Tax	<p>Select to indicate that the business tax is applicable. This option enables you to calculate and report a business tax assessed on the gross value of fixed assets. This is a requirement in some countries.</p>
Corp. Sec. 291 (corporation section 291)	<p>Select if the organization is a corporation. This check box must be selected if the company is a corporation in order for the Tax Retirement Capital Gains report (AMTX3210) to accurately reflect the correct Sec. 1231/Ordinary gains.</p>

Field or Control	Description
(USA) Depreciation Bonus	<p>Select to indicate the specific depreciation bonus definition if the asset qualifies for depreciation bonus treatment.</p> <p>For descriptions of the PeopleSoft delivered field options:</p> <p>See <i>PeopleSoft Asset Lifecycle Management Fundamentals, Establishing Asset Processing, Specifying Tax Attributes in a Profile</i>.</p> <p>You can also define your own depreciation bonus options for selection in this field using the Depreciation Bonus Info page.</p> <p>See <i>PeopleSoft Asset Lifecycle Management Fundamentals, Setting Up Depreciation Processing, Setting Up Depreciation Bonus Information</i></p>
(USA) Bonus Percent	<p>Enter the percent amount of the depreciation bonus to be applied to the books for this profile. The amount depends on the legislation provisions for bonus amount, acquisition date and in-service date of the asset as well as state or local application of the depreciation allowance.</p>

Tax Credits Options

The rate and amount of the tax credit are based on federal tax law and determined by the qualified investment code, tax credit type, tax credit code, and the basis reduction option in Asset Management.

Field or Control	Description
Basis Red (basis reduction)	<p>Displays the total reduction of the cost basis, if any. The total reduction amount is updated each time that you change tax credit information.</p>
Qualified Investment Code	<p>Corresponds to the option you enter in the Tax field.</p>
Tax Credit Type	<p>Although the investment tax credit was essentially repealed on December 31, 1985, certain business incentive credits can still be taken. Currently, you can specify the following credits:</p> <ul style="list-style-type: none"> • <i>R</i> (rehabilitation): Building rehabilitation credit. • <i>E</i> (energy): Energy credit. • <i>I</i> (investment): Regular investment credit.

Field or Control	Description
Tax Credit Code	Enter a value in this field to further define the tax credit—for example, a 20 percent rehabilitation tax credit is available for certified historic buildings.
Basis Reduction Option	Some credits require a corresponding reduction in the asset's cost basis. In this field, specify whether the basis needs to be reduced. Options are: <ul style="list-style-type: none"> • <i>B</i> (basis): Reduction based on tax credit. • <i>P</i> (percentage): Reduction based on specified percentage. • <i>N</i> (no): No reduction required.

Asset Management calculates the percentage and computation amount based on the following calculations:

$$\begin{aligned} (\text{Book Cost}) \times (\text{Qualified Investment Percentage}) &= (\text{Amount Qualifying for Tax Credit}) \\ (\text{Amount Qualifying}) \times (\text{Tax Credit Percentage}) &= (\text{Amount of Tax Credit}) \\ (\text{Amount of Tax Credit}) \times (\text{Basis Reduction Percentage}) &= (\text{Amount That Basis Is Reduced}) \end{aligned}$$

Adding Assets with the Asset ExpressAdd Component

The Asset ExpressAdd component is a series of pages that enable you to add owned assets quickly and efficiently. Assets added with the Asset ExpressAdd component are assigned a capitalization status automatically when you save, and most of the information in the pages can be defaulted from an asset profile. This component also enables you to enter accumulated depreciation for assets.

When entering joint venture assets that are shared among several business units, it is best to assign a unique asset ID. This ensures that the assets created at the participant level have the same ID as the asset created at the joint venture business unit level. You can make these asset IDs easy to identify by including the prefix *JV*, for example, you might create the asset ID JV000022.

If an asset is subject to asset retirement obligation (ARO) treatment, you can designate it as such by selecting an ARO profile or simply selecting to use ARO from the ExpressAdd component.

When entering assets that have a parent/child relationship, you must first enter a parent ID on the Cost/Asset Information page before assigning the profile ID default.

Add assets with the Asset ExpressAdd component as follows:

1. Enter information about how the asset will be capitalized. (If you are adding parent/child assets, you must specify the parent ID in this step.)
2. Assign a profile ID.
3. Identify if the asset is subject to ARO treatment.

4. Identify the asset's books and information needed for calculating depreciation.
5. Specify property type and tax depreciation criteria.

See also [Understanding Leased Assets](#)

Pages Used to Add Assets with the Asset ExpressAdd Component

<i>Page Name</i>	<i>Definition Name</i>	<i>Usage</i>
Cost/Asset Information Page	ASSET_ENTRY_00	Enter information about how the asset will be capitalized.
Depreciation Information Page	ASSET_ENTRY_01	If you set up book information in the asset profile, all book information appears by default. The Depreciation Information page identifies the asset's books and information needed for calculating depreciation.
Tax Information	ASSET_ENTRY_02	Specify property type and tax depreciation criteria and identify the investment credits that are taken for the current asset. If the fields on this page are unavailable, the book was not set up as a tax book.

Related Links

[Understanding Leased Assets](#)

Cost/Asset Information Page

Use the Cost/Asset Information page (ASSET_ENTRY_00) to enter information about how the asset will be capitalized.

Navigation:

Asset Management > Asset Transactions > Owned Assets > Express Add

This example illustrates the fields and controls on the Cost/Asset Information page. You can find definitions for the fields and controls later on this page.

Cost / Asset Information

Asset Information

Unit: US001	Asset ID: NEXT
Profile ID: FURNITURE	Trans Date: 12/18/2020
Description: Cap threshold by asset	Acctg Date: 12/18/2020
Location: US003 USA - California	Trans Code: <input type="text"/>
Tag Number: <input type="text"/>	Currency: USD
<input checked="" type="checkbox"/> Accum Depr in Current Pd	Rate Type: CRRNT

Asset Cost Information

Book Name: FEDERAL	Quantity: 1.0000	Cost: 3,000.00 USD	Salvage: 0.00 USD
Category: FF	Cost Type: <input type="text"/>	Accum Depr: 0.00	YTD Depr: 0.00 USD

Chartfields

Oper Unit	Fund	Dept	Program	Class	Bud Ref	Product	Project
<input type="text"/>	<input type="text"/>	<input type="text"/>	<input type="text"/>	<input type="text"/>	<input type="text"/>	<input type="text"/>	<input type="text"/>

This example illustrates the fields and controls on the Cost/Asset Information page. You can find definitions for the fields and controls later on this page.

Asset Additional Information

Asset Type: Furniture	Set R and D Info...
Asset Subtype: DESK	External Funding Source...
CAP #: <input type="text"/>	Hazardous Code Info...
Serial ID: <input type="text"/>	<input type="checkbox"/> Hazardous Asset
Asset Class: <input type="text"/>	<input type="checkbox"/> Taggable Asset
*Asset Status: In Service	<input type="checkbox"/> Capitalized Asset
FERC Code: <input type="text"/>	<input type="checkbox"/> Composite Asset
Acquisition Date: 12/18/2020	
*Acquisition Code: Purchased	
Collateral Asset: <input type="text"/>	
Parent/Child: None	Parent ID: <input type="text"/>

Asset Information

<i>Field or Control</i>	<i>Description</i>
Accum Depr in Current Pd (accumulated depreciation in current period)	Select to have the system book accumulated depreciation for the asset to the current period. Otherwise, accumulated depreciation is booked to the previous period. If that is the case, you may need to reopen the period.

Field or Control	Description
Trans Date (transaction date) and Acctg Date (accounting date)	Typically, the transaction date represents the date that you actually acquired the asset and the accounting date represents the date that the transaction is posted to the general ledger. The accounting date is validated against the FIN_OPEN_PERIOD table to determine the period to which the transaction is posted. The difference between the transaction date and the accounting date determines if any prior period depreciation needs to be calculated. For example, suppose that a computer was acquired and placed in service on March 15, 2001, but the information was not entered in PeopleSoft Asset Management until August 1, 2001. All general ledger periods prior to August are closed. In this case, PeopleSoft Asset Management automatically calculates depreciation starting in March and posts it to the general ledger in August.
Location	Identify the asset location by selecting from a list of valid values. Identification of the asset location is required for managing hazardous material assets, which must often be monitored and reported on. This location is automatically populated with the ship from location for VAT-enabled business units.
Trans Code (transaction code)	Identify which accounting entry template is used for the asset, such as <i>Abandoned</i> , <i>Inventory</i> , or <i>Scrapped</i> . The system accepts only valid combinations of the category, cost type, transaction code, and transaction type for which accounting entry templates exist.
Currency and Rate Type	Select the currency and exchange rate type.

Note: When working with parent/child assets, you must go to the Asset Additional Information section and enter the parent ID before you select **Default Profile**.

Asset Cost Information

Enter one row of cost information before populating fields with the default information from the asset profile.

Field or Control	Description
Cost Type	Break down portions of the asset cost, and enter as many cost types as needed for each transaction. For example, the costs of constructing a building are often broken down into categories reflecting the type of cost, such as material, labor, permits, and so on. Only valid cost types are accepted. The cost types are user-defined during the system implementation.
Salvage	Displays the salvage value that is calculated based on the option defined at the asset profile level (either flat amount or percentage). Salvage value is prorated based on a ChartField's cost if a flat amount is used, and it appears as a percentage of cost if the percentage option is selected.
Accum Depr (accumulated depreciation)	Enter the amount of depreciation already recognized. If you are adding assets that have depreciation from prior years or prior periods, enter that amount in this field.
YTD Depr (year to date depreciation)	If any portion of the accumulated depreciation amount applies to the current fiscal year, enter the amount of that portion.

Note: The accumulated depreciation, YTD depreciation, and salvage amounts entered while creating a foreign currency asset, will not be converted into the Business Unit's or book's base currency. These values needs to be entered in Primary Book's base currency.

Note: After you save this page, you cannot change the asset information here. To modify the information, you must use the Asset Cost Adjust/Transfer page or the Basic Add page. When working with parent/child assets, remember to designate the parent ID before you continue.

Asset Additional Information

Field or Control	Description
Asset Type	<p>Select a value to indicate a type of asset. The available options are:</p> <p><i>Equipment</i></p> <p><i>Facility</i></p> <p><i>Fleet</i></p> <p><i>Furniture</i></p> <p><i>Hardware</i></p> <p><i>Intangible</i></p> <p><i>Machinery</i></p> <p><i>Other</i></p> <p><i>Property</i></p> <p><i>Software</i></p>
Asset Subtype	<p>Select a value to indicate a subset of asset type. Subtypes are optionally user-defined and directly related to the asset type. Only asset subtypes of the selected asset type are available when defining the asset.</p>
CAP # (capital acquisition plan number) and Seq # (sequence number)	<p>The capital acquisition plan (CAP) number ties the asset to a CAP. Enter a valid number and sequence. You set up CAP numbers in the CAP table.</p>

Field or Control	Description
Threshold ID	<p>This value defaults from the capitalization Threshold ID that is associated with the asset profile for a given asset. You can override the Threshold ID if needed. If no threshold was defined for the profile, you can select an asset based threshold ID. When adding an asset, the system uses the capitalization definition for the applicable Threshold ID to determine the appropriate capitalization action to take. Upon saving, the system compares the total cost of the line (cost x quantity) with the cost established for each bracket, as well as the basis option to decide the action to take.</p> <p>This field is available for editing only when:</p> <ul style="list-style-type: none"> • the Capitalization Threshold feature is enabled from the Installation Options - Asset Management page • the Threshold ID on the Depreciation Information page is unpopulated • the business unit where the asset is added uses it
Serial ID	If applicable, enter the serial number for the asset.
Asset Class	This field is used to classify assets for reporting purposes. It can be used in combination with an asset category to refine asset classification. These fields can also be used for VAT purposes.

Field or Control	Description
Asset Status	<p>Indicate the status by selecting one of the following options:</p> <ul style="list-style-type: none"> • <i>Budgeted</i>: Asset is budgeted but not placed in service. • <i>Commitment</i>: Budget has been approved and you are preparing to acquire the asset. • <i>Disposed</i>: Asset is no longer in service. • <i>In Service</i>: This is the date that the asset is available for use. The transaction date is the default. • <i>Received</i>: Asset was received but is not yet placed in service. • <i>Requisitioned</i> (requisitioned): Necessary paperwork has been completed for acquisition. • <i>Suspended</i>. Depreciation has been suspended for this asset • <i>Transferred</i>. This asset was transferred from another business unit. • <i>WIP</i> (work in progress): Asset is acquired for a project under way.
FERC Code	Select a FERC code if it applies.
Acquisition Date and Acquisition Code	<p>Enter the date the asset was acquired and select an acquisition code:</p> <p><i>Construct, Donated, Leased, Like Exch, Purchased, Trade In, and Transfer</i></p>
Collateral Asset	<p>Japanese accounting principles require that assets offered as collateral be treated according to financial reporting regulations under the commercial law. If the asset is a collateral asset, select one of the available options that comply with Japanese requirements.</p>
Parent/Child and Parent ID	<p>If you are adding a parent or child asset, select the parent-child asset option that applies. The default is <i>None</i>. If this is a child asset, enter the parent asset ID with which to associate it.</p>

<i>Field or Control</i>	<i>Description</i>
Asset Retirement Obligations	Select to identify an asset that is subject to asset retirement obligation (ARO) treatment in accordance with Financial Accounting Standards for proper reporting and processing. This field appears only when you have enabled ARO on the Installation Options – Asset Management page and enabled ARO at the business unit level.
<i>Field or Control</i>	<i>Description</i>
Hazardous Asset	Check if the asset qualifies as hazardous.
Taggable Asset	Check if the asset can be physically assigned a tag number.
Capitalized Asset	This check box is display-only, and the status is determined automatically by the asset profile. Non capitalized assets have no cost or books and are not depreciated in Asset Management. Sometimes you need to track physical information only (such as location, physical specifications, number of units, and so forth), but you don't want information about the assets to appear in the general ledger.
Composite Asset	Check if the asset is a composite asset.
Set R and D Info (set research and development information)	Click this link to enter research and development information on the Asset R&D Information page. In Australia, this option is used for tax reporting purposes. Otherwise, this field is informational only.
External Funding Source	Click to access the External Funding Source Page and associate the asset with an external funding source.
Hazardous Code Info (hazardous code information)	Click on this link to go to the Hazardous Asset Codes page and select a hazardous code to identify with and associate to this asset.

Field or Control	Description
Asset Retirement Obligations	Select to identify an asset that is subject to asset retirement obligation (ARO) treatment in accordance with Financial Accounting Standards for proper reporting and processing. This field appears only when you have enabled ARO on the Installation Options – Asset Management page and enabled ARO at the business unit level.

Depreciation Information Page

Use the Depreciation Information page (ASSET_ENTRY_01) to identify the asset's books and information needed for calculating depreciation.

Navigation:

Asset Management > Asset Transactions > Owned Assets > Express Add > Depreciation Information

This example illustrates the fields and controls on the Depreciation Information page. You can find definitions for the fields and controls later on this page.

The screenshot displays the 'Depreciation Information' page for an asset. The page is divided into several sections:

- Navigation Tabs:** Cost / Asset Information, Depreciation Information (active), Tax Information, Asset Add Work Page 1, Asset Add Work Page 2, Depreciation Request Work.
- Asset Details:** Unit US001, Asset ID CAP_BY_BOOK, Tag, In Service.
- Depreciation Attributes:**
 - *Book Name: CORP (Corporate)
 - Status: Depreciable
 - In Service Date: 10/13/2014 (with 'By' icon)
 - Convention: AD (Actual Day)
 - Retire Conv: AD (Actual Day)
 - Currency: USD
 - Adjust Conv: AM (Actual Month)
 - Retire Option: Calculate Gain/Loss
- Method and Calculation:**
 - *Method: Straight Line
 - Calculation Type: Remaining Value
 - Percent: (empty)
 - Limit Pct: (empty)
 - Useful Life: 84
 - Schedule: (empty)
 - UOP ID: (empty)
 - End Date: (empty)
 - Life in Years: 7.0
 - Low Limit: (empty)
 - DB Pct: (empty)
 - Method ID: (empty)
 - *Avg Option: No Averaging
 - Future Depr Yrs: (empty)
- Special Depreciation:**
 - Special Depreciation: (checkbox checked)
- Additional Fields:**
 - Depr Limit: (empty)
 - Salvage %: (empty)
 - Multi-Shift Code: (empty)
 - Child Inherits Parent's Life: (checkbox unchecked)
 - Cost Basis Limit: (empty)
 - Threshold ID: CT_001

If you set up book information in the asset profile, all book information appears by default. An asset can be linked to any number of books. Typically, separate books are required for financial and tax purposes. If you manage assets in multiple currencies, each currency can have its own book.

The Threshold ID value defaults from the capitalization Threshold ID that is associated with the asset profile for a given asset. You can override the Threshold ID if needed. If no threshold was defined

for the profile, you can select an asset based threshold ID. When adding an asset, the system uses the capitalization definition for the applicable Threshold ID to determine the appropriate capitalization action to take.

The Threshold ID field is available for editing only when:

- the Capitalization Threshold feature is enabled from the Installation Options - Asset Management page
- the Threshold ID on the Cost/Asset Information page is unpopulated
- the business unit where the asset is added uses it

Importing Asset Transaction Data by Spreadsheet

This topic provides an overview of the Import Data by Spreadsheet process and discusses how to import asset transaction data into Asset Management using this process.

Pages Used to Import Asset Transaction Data by Spreadsheet

Page Name	Definition Name	Usage
<u>Define Spreadsheet Template Page</u>	AM_TEMPLATE	Use this page to define spreadsheet template parameters and generate the template (which you will use to populate with your asset transaction data).
<u>Upload Spreadsheet Data Page</u>	AM_LOAD_RQST	Use this page to audit and review asset transaction data stored in the CSV file, and load the data to the Asset Management interface tables.
<u>Financial Transaction Page</u>	INTFC_FIN_SS	Use this page to review asset transaction data in the INTFC_FIN table.
<u>Physical Transaction Page</u>	INTFC_PHY_A_SS	Use this page to review asset transaction data in the INTFC_PHY_A table.

Understanding the Import Data by Spreadsheet Process

The Import Data by Spreadsheet process enables you to enter asset transaction data offline using a spreadsheet application and *Comma Separated Values* (CSV) file, then import the transaction data into Asset Management tables. Using the Import Data by Spreadsheet process you can:

- Add capitalized and non capitalized assets
- Add capitalized assets with accumulated depreciation
- Transfer assets between business units (interunit transfer)

- Transfer assets from one asset category to another (recategorization)
- Transfer ChartFields
- Adjust asset cost (upward and downward adjustment)
- Adjust asset cost by amount
- Adjust accumulated depreciation
- Retire assets
- Create ARO conversions
- Create initial ARO measurements

Delivered Spreadsheet Templates

The Define Spreadsheet Template page provides you with the framework and fields necessary to generate an individualized CSV file you can use to input your asset transaction data. PeopleSoft delivers spreadsheet templates tailored to these transactions:

- Adding capitalized and non capitalized assets
- Adding capitalized assets with accumulated depreciation
- Transferring assets between business units (interunit transfer)
- Transferring assets from one asset category to another (recategorization)
- Transferring ChartFields
- Adjusting asset cost (upward and downward adjustment)
- Adjusting asset cost by amount
- Adjusting accumulated depreciation of assets
- Retiring assets
- Creating ARO conversions
- Creating initial ARO measurements

The following sections provide examples of the fields available for use with each delivered spreadsheet template.

Adding Capitalized Assets Using the Delivered Spreadsheet Template

Add Assets Spreadsheet Template

Define Spreadsheet Template

Template ID: ADD_ASSET
 *Description: ADD ASSET
 *Transaction: Add Assets

Asset Fields

Column Sequence	Field Name	Field Long Name	Required	Active
10	BUSINESS_UNIT	Business Unit	<input checked="" type="checkbox"/>	<input checked="" type="checkbox"/>
20	ASSET_ID	Asset Identification	<input checked="" type="checkbox"/>	<input checked="" type="checkbox"/>
30	DESCR	Description	<input type="checkbox"/>	<input checked="" type="checkbox"/>
40	DESCRSHORT	Short Description	<input type="checkbox"/>	<input checked="" type="checkbox"/>
50	DESCR_LONG	Long Description	<input type="checkbox"/>	<input checked="" type="checkbox"/>
60	ACQUISITION_CD	Acquisition Code	<input type="checkbox"/>	<input checked="" type="checkbox"/>
70	FINANCING_CD	Financing Code	<input type="checkbox"/>	<input checked="" type="checkbox"/>
80	PROFILE_ID	Asset Profile ID	<input checked="" type="checkbox"/>	<input checked="" type="checkbox"/>
90	SERIAL_ID	Serial ID	<input type="checkbox"/>	<input checked="" type="checkbox"/>
100	TAG_NUMBER	Tag Number	<input type="checkbox"/>	<input checked="" type="checkbox"/>
110	CUSTODIAN	Custodian	<input type="checkbox"/>	<input type="checkbox"/>
120	CUSTODIAN_DEPTID	Asset Custodian Deptid	<input type="checkbox"/>	<input type="checkbox"/>
130	EMPLID	Empl ID	<input type="checkbox"/>	<input type="checkbox"/>
140	LOCATION	Location Code	<input type="checkbox"/>	<input checked="" type="checkbox"/>
150	AREA_ID	Area ID	<input type="checkbox"/>	<input type="checkbox"/>

Adding Non Capitalized Assets Using the Delivered Spreadsheet Template

Add Non Capitalized Assets Spreadsheet Template

Define Spreadsheet Template

Template ID NCP
 *Description

Transaction Add Non Capitalized Assets [View Template Audit](#)

Column Sequence	Field Name	Field Long Name	Required	Active
10	BUSINESS_UNIT	Business Unit	<input checked="" type="checkbox"/>	<input checked="" type="checkbox"/>
20	ASSET_ID	Asset Identification	<input checked="" type="checkbox"/>	<input checked="" type="checkbox"/>
30	DESCR	Description	<input checked="" type="checkbox"/>	<input checked="" type="checkbox"/>
40	PROFILE_ID	Asset Profile ID	<input checked="" type="checkbox"/>	<input checked="" type="checkbox"/>
50	ACQUISITION_DT	Acquisition Date	<input checked="" type="checkbox"/>	<input checked="" type="checkbox"/>
60	TRANS_DT	Transaction Date	<input checked="" type="checkbox"/>	<input checked="" type="checkbox"/>
70	ACCOUNTING_DT	Accounting Date	<input checked="" type="checkbox"/>	<input checked="" type="checkbox"/>
80	QUANTITY	Quantity	<input checked="" type="checkbox"/>	<input checked="" type="checkbox"/>
90	TXN_COST	Transaction Cost	<input checked="" type="checkbox"/>	<input checked="" type="checkbox"/>
100	TXN_CURRENCY_CD	Transaction Currency	<input checked="" type="checkbox"/>	<input checked="" type="checkbox"/>
110	TAG_NUMBER	Tag Number	<input type="checkbox"/>	<input checked="" type="checkbox"/>
120	SERIAL_ID	Serial ID	<input type="checkbox"/>	<input checked="" type="checkbox"/>
130	LOCATION	Location Code	<input type="checkbox"/>	<input checked="" type="checkbox"/>
140	AREA_ID	Area ID	<input type="checkbox"/>	<input type="checkbox"/>
150	MANUFACTURER	Manufacturer Name	<input type="checkbox"/>	<input type="checkbox"/>

[Create Template](#)
[View/Download Template](#)

Adding Capitalized Assets with Accumulated Depreciation Using the Delivered Spreadsheet Template

Add Assets with Accumulated Depreciation Spreadsheet Template

Define Spreadsheet Template

Template ID

*Description

*Transaction

Column Sequence	Field Name	Field Long Name	Required	Active
80	CUSTODIAN	Custodian	<input type="checkbox"/>	<input type="checkbox"/>
90	CUSTODIAN_DEPTID	Asset Custodian Deptid	<input type="checkbox"/>	<input type="checkbox"/>
100	EMPLID	Empl ID	<input type="checkbox"/>	<input type="checkbox"/>
110	LOCATION	Location Code	<input type="checkbox"/>	<input checked="" type="checkbox"/>
120	AREA_ID	Area ID	<input type="checkbox"/>	<input type="checkbox"/>
130	MANUFACTURER	Manufacturer Name	<input type="checkbox"/>	<input type="checkbox"/>
140	MFG_ID	Manufacturer ID	<input type="checkbox"/>	<input type="checkbox"/>
150	MODEL	Model	<input type="checkbox"/>	<input type="checkbox"/>
160	ACQUISITION_DT	Acquisition Date	<input checked="" type="checkbox"/>	<input checked="" type="checkbox"/>
170	TRANS_DT	Transaction Date	<input checked="" type="checkbox"/>	<input checked="" type="checkbox"/>
180	ACCOUNTING_DT	Accounting Date	<input checked="" type="checkbox"/>	<input checked="" type="checkbox"/>
190	BOOK	Asset Book Name	<input checked="" type="checkbox"/>	<input checked="" type="checkbox"/>
200	QUANTITY	Quantity	<input type="checkbox"/>	<input checked="" type="checkbox"/>
210	TXN_COST	Transaction Cost	<input checked="" type="checkbox"/>	<input checked="" type="checkbox"/>
220	ACCUM_DEPR	Accumulated Depreciation	<input checked="" type="checkbox"/>	<input checked="" type="checkbox"/>

Personalize | Find | |
First
1-34 of 34
Last

Transferring Assets Between Business Units (Interunit Transfer) Using the Delivered Spreadsheet Template

Inter-Unit Transfer Spreadsheet Template

Define Spreadsheet Template

Template ID IUT
 *Description
 Transaction Inter-Unit Transfer [View Template Audit](#)

Inter-Unit Fields ?

🗖 🔍 1-8 of 8

Column Sequence	Field Name	Field Long Name	Required	Active
10	BUSINESS_UNIT	Business Unit	<input checked="" type="checkbox"/>	<input checked="" type="checkbox"/>
20	ASSET_ID	Asset Identification	<input checked="" type="checkbox"/>	<input checked="" type="checkbox"/>
30	TO_BUSINESS_UNIT	To Business Unit	<input checked="" type="checkbox"/>	<input checked="" type="checkbox"/>
40	TRANS_DT	Transaction Date	<input checked="" type="checkbox"/>	<input checked="" type="checkbox"/>
50	ACCOUNTING_DT	Accounting Date	<input checked="" type="checkbox"/>	<input checked="" type="checkbox"/>
60	TRANS_CODE	Transaction Code	<input type="checkbox"/>	<input checked="" type="checkbox"/>
70	CONVENTION	Convention	<input checked="" type="checkbox"/>	<input checked="" type="checkbox"/>
80	RT_TYPE	Rate Type	<input checked="" type="checkbox"/>	<input checked="" type="checkbox"/>

[View/Download Template](#)

Transferring ChartFields Using the Delivered Spreadsheet Template

Transfer Assets Spreadsheet Template

Define Spreadsheet Template

Template ID TRF
 *Description
 Transaction Transfer Assets [View Template Audit](#)

Transfer Fields ?

🔍
1-17 of 17

Column Sequence	Field Name	Field Long Name	Required	Active
10	BUSINESS_UNIT	Business Unit	<input checked="" type="checkbox"/>	<input checked="" type="checkbox"/>
20	ASSET_ID	Asset Identification	<input checked="" type="checkbox"/>	<input checked="" type="checkbox"/>
30	TRANS_DT	Transaction Date	<input checked="" type="checkbox"/>	<input checked="" type="checkbox"/>
40	ACCOUNTING_DT	Accounting Date	<input checked="" type="checkbox"/>	<input checked="" type="checkbox"/>
50	TRANS_CODE	Transaction Code	<input type="checkbox"/>	<input checked="" type="checkbox"/>
60	RT_TYPE	Rate Type	<input checked="" type="checkbox"/>	<input checked="" type="checkbox"/>
70	CONVENTION	Convention	<input checked="" type="checkbox"/>	<input checked="" type="checkbox"/>
80	OPERATING_UNIT	Operating Unit	<input type="checkbox"/>	<input type="checkbox"/>
90	FUND_CODE	Fund Code	<input type="checkbox"/>	<input type="checkbox"/>
100	DEPTID	Department	<input type="checkbox"/>	<input checked="" type="checkbox"/>
110	PROGRAM_CODE	Program Code	<input type="checkbox"/>	<input type="checkbox"/>
120	CLASS_FLD	Class Field	<input type="checkbox"/>	<input type="checkbox"/>
130	BUDGET_REF	Budget Reference	<input type="checkbox"/>	<input type="checkbox"/>
140	PRODUCT	Product	<input type="checkbox"/>	<input type="checkbox"/>
150	BUSINESS_UNIT_PC	PC Business Unit	<input type="checkbox"/>	<input type="checkbox"/>

[View/Download Template](#)

Recategorizing Assets Using the Delivered Spreadsheet Template

Recategorize Asset Spreadsheet Template

Define AM Spreadsheet Template

Template ID

*Description

*Transaction

Recategorization Fields ?

Column Sequence	Field Name	Field Long Name	Required	Active
10	BUSINESS_UNIT	Business Unit	<input checked="" type="checkbox"/>	<input checked="" type="checkbox"/>
20	ASSET_ID	Asset Identification	<input checked="" type="checkbox"/>	<input checked="" type="checkbox"/>
30	CATEGORY_TO	To Category	<input checked="" type="checkbox"/>	<input checked="" type="checkbox"/>
40	TRANS_DT	Transaction Date	<input checked="" type="checkbox"/>	<input checked="" type="checkbox"/>
50	ACCOUNTING_DT	Accounting Date	<input checked="" type="checkbox"/>	<input checked="" type="checkbox"/>
60	TRANS_CODE	Transaction Code	<input type="checkbox"/>	<input checked="" type="checkbox"/>
70	RT_TYPE	Rate Type	<input checked="" type="checkbox"/>	<input checked="" type="checkbox"/>
80	PROFILE_ID	Asset Profile ID	<input type="checkbox"/>	<input checked="" type="checkbox"/>

[Create Template](#)

Adjusting Asset Cost Using the Delivered Spreadsheet Template

Adjust Asset Spreadsheet Template

Define Spreadsheet Template

Template ID ADJ

*Description

Transaction Adjust Asset [View Template Audit](#)

Adjustment Fields ?

1-7 of 7

Column Sequence	Field Name	Field Long Name	Required	Active
10	BUSINESS_UNIT	Business Unit	<input checked="" type="checkbox"/>	<input checked="" type="checkbox"/>
20	ASSET_ID	Asset Identification	<input checked="" type="checkbox"/>	<input checked="" type="checkbox"/>
30	ADJUST_PCT	Adjustment Percentage	<input checked="" type="checkbox"/>	<input checked="" type="checkbox"/>
40	TRANS_DT	Transaction Date	<input checked="" type="checkbox"/>	<input checked="" type="checkbox"/>
50	ACCOUNTING_DT	Accounting Date	<input checked="" type="checkbox"/>	<input checked="" type="checkbox"/>
60	TRANS_CODE	Transaction Code	<input type="checkbox"/>	<input checked="" type="checkbox"/>
70	RT_TYPE	Rate Type	<input checked="" type="checkbox"/>	<input checked="" type="checkbox"/>

[View/Download Template](#)

Adjusting Asset Cost by Amount Using the Delivered Spreadsheet Template

Asset Cost Adjustment by Amount Spreadsheet Template

Define Spreadsheet Template

Template ID ADA
 *Description
 Transaction Asset Cost Adjustment by Amt [View Template Audit](#)

Adjustment by Amount Fields ?

Column Sequence	Field Name	Field Long Name	Required	Active
10	BUSINESS_UNIT	Business Unit	<input checked="" type="checkbox"/>	<input checked="" type="checkbox"/>
20	ASSET_ID	Asset Identification	<input checked="" type="checkbox"/>	<input checked="" type="checkbox"/>
30	COST_ADJ	Cost Adjustment	<input checked="" type="checkbox"/>	<input checked="" type="checkbox"/>
40	TRANS_DT	Transaction Date	<input checked="" type="checkbox"/>	<input checked="" type="checkbox"/>
50	ACCOUNTING_DT	Accounting Date	<input checked="" type="checkbox"/>	<input checked="" type="checkbox"/>
60	TRANS_CODE	Transaction Code	<input type="checkbox"/>	<input checked="" type="checkbox"/>
70	RT_TYPE	Rate Type	<input checked="" type="checkbox"/>	<input checked="" type="checkbox"/>

Adjusting Accumulated Depreciation of assets Using the Delivered Spreadsheet Template

Adjust Accumulated Depreciation Template

Define AM Spreadsheet Template

Template ID ADJDEPR
 *Description
 *Transaction

Adjustment Fields ?

Column Sequence	Field Name	Field Long Name	Required	Active
10	BUSINESS_UNIT	Business Unit	<input type="checkbox"/>	<input type="checkbox"/>
20	ASSET_ID	Asset Identification	<input type="checkbox"/>	<input type="checkbox"/>
30	BOOK	Asset Book Name	<input type="checkbox"/>	<input type="checkbox"/>
40	CF_SEQNO	Chartfield Sequence Number	<input type="checkbox"/>	<input type="checkbox"/>
50	DEPR	Depr Accum Adjustment	<input type="checkbox"/>	<input type="checkbox"/>
60	DEPR_YTD	Year to Date Depr Adjust	<input type="checkbox"/>	<input type="checkbox"/>
70	TRANS_DT	Transaction Date	<input type="checkbox"/>	<input type="checkbox"/>
80	ACCOUNTING_DT	Accounting Date	<input type="checkbox"/>	<input type="checkbox"/>
90	TRANS_CODE	Transaction Code	<input type="checkbox"/>	<input checked="" type="checkbox"/>

Retiring Assets Using the Delivered Spreadsheet Template

Retire Assets Spreadsheet Template

Define AM Spreadsheet Template

Template ID: RET1

*Description: Retirement

*Transaction: Asset Retirement

Retirement Fields ?

Column Sequence	Field Name	Field Long Name	Required	Active
10	BUSINESS_UNIT	Business Unit	<input checked="" type="checkbox"/>	<input checked="" type="checkbox"/>
20	ASSET_ID	Asset Identification	<input checked="" type="checkbox"/>	<input checked="" type="checkbox"/>
30	RETIREMENT_DT	Retire Date	<input checked="" type="checkbox"/>	<input checked="" type="checkbox"/>
40	ACCOUNTING_DT	Accounting Date	<input checked="" type="checkbox"/>	<input checked="" type="checkbox"/>
50	RETIRE_CONVENTION	Retirement Convention	<input type="checkbox"/>	<input checked="" type="checkbox"/>
60	DISPOSAL_CODE	Retirement Type	<input checked="" type="checkbox"/>	<input checked="" type="checkbox"/>
70	PROCEEDS	Retirement Proceeds	<input type="checkbox"/>	<input checked="" type="checkbox"/>
80	TXN_CURR_PROCEEDS	Proceeds Currency	<input type="checkbox"/>	<input checked="" type="checkbox"/>
90	REMOVAL_COST	Removal Cost	<input type="checkbox"/>	<input checked="" type="checkbox"/>
100	TXN_CURR_REMOVAL	Removal Cost Currency	<input type="checkbox"/>	<input checked="" type="checkbox"/>
110	TRANS_CODE	Transaction Code	<input type="checkbox"/>	<input type="checkbox"/>
120	FULLY_DEPR_SW	Retire As Fully Depreciated SW	<input type="checkbox"/>	<input type="checkbox"/>

[Create Template](#)

The Retirement Convention field is not required. If you do not provide a value for this field in the CSV file, the value automatically defaults from the asset profile. If you provide a value for this field, it overrides the value from the asset profile.

Creating ARO Conversion Using the Delivered Spreadsheet Template

Create ARO Conversion Spreadsheet Template

Define Spreadsheet Template

Template ID ARC

*Description ARC

Transaction Create ARO Conversion [View Template Audit](#)

Column Sequence	Field Name	Field Long Name	Required	Active
10	BUSINESS_UNIT	Business Unit	<input checked="" type="checkbox"/>	<input checked="" type="checkbox"/>
20	ASSET_ID	Asset Identification	<input checked="" type="checkbox"/>	<input checked="" type="checkbox"/>
30	LINE_SEQ_NUM	Sequence	<input checked="" type="checkbox"/>	<input checked="" type="checkbox"/>
40	MEASUREMENT_DT	Measurement Date	<input checked="" type="checkbox"/>	<input checked="" type="checkbox"/>
50	ACCOUNTING_DT	Accounting Date	<input checked="" type="checkbox"/>	<input checked="" type="checkbox"/>
60	ARO_CONVERSION_DT	ARO Conversion Date	<input checked="" type="checkbox"/>	<input checked="" type="checkbox"/>
70	ARO_LIFE_PERIOD	Estimated Life in Periods	<input checked="" type="checkbox"/>	<input checked="" type="checkbox"/>
80	ARO_LIABILITY	ARO Liability	<input checked="" type="checkbox"/>	<input checked="" type="checkbox"/>
90	INFLATION_RATE	Inflation Rate	<input checked="" type="checkbox"/>	<input checked="" type="checkbox"/>
100	MKT_RISK_PREMIUM	Market Risk Premium Rate	<input checked="" type="checkbox"/>	<input checked="" type="checkbox"/>
110	CR_ADJ_RISK_FREE	Credit Adjusted Risk-Free Rate	<input checked="" type="checkbox"/>	<input checked="" type="checkbox"/>
120	BOOK	Asset Book Name	<input checked="" type="checkbox"/>	<input checked="" type="checkbox"/>
130	CONVENTION	Convention	<input checked="" type="checkbox"/>	<input checked="" type="checkbox"/>
140	RT_TYPE	Rate Type	<input checked="" type="checkbox"/>	<input checked="" type="checkbox"/>
150	ARO_CFLOW_ID	ARO Cash Flow	<input checked="" type="checkbox"/>	<input checked="" type="checkbox"/>

[Create Template](#)
[View/Download Template](#)

Creating Initial ARO Measurement Using the Delivered Spreadsheet Template

Create ARO Measurement Spreadsheet Template

Define Spreadsheet Template

Template ID: ARO
 *Description:

Transaction: [Create ARO Measurement](#) [View Template Audit](#)

Column Sequence	Field Name	Field Long Name	Required	Active
10	BUSINESS_UNIT	Business Unit	✓	✓
20	ASSET_ID	Asset Identification	✓	✓
30	LINE_SEQ_NUM	Sequence	✓	✓
40	MEASUREMENT_DT	Measurement Date	✓	✓
50	ACCOUNTING_DT	Accounting Date	✓	✓
60	ARO_LIFE_PERIOD	Estimated Life in Periods	✓	✓
70	ARC_TK_ARO_SW	ARC Inherits ARO Parent's Life	✓	✓
80	INFLATION_RATE	Inflation Rate	✓	✓
90	MKT_RISK_PREMIUM	Market Risk Premium Rate	✓	✓
100	CR_ADJ_RISK_FREE	Credit Adjusted Risk-Free Rate	✓	✓
110	BOOK	Asset Book Name	✓	✓
120	CONVENTION	Convention	✓	✓
130	RT_TYPE	Rate Type	✓	✓
140	ARO_CFLOW_ID	ARO Cash Flow	✓	✓
150	EXP_CASH_FLOW	Txn Unadjusted Cash Flow	✓	✓

Create Template

 [View/Download Template](#)

Steps to Import Asset Transaction Data into Asset Management Using the Import Data by Spreadsheet Process

Follow these steps to import asset transaction data into Asset Management using the Import Data by Spreadsheet process:

1. Define spreadsheet template parameters and generate the CSV file.
 See [Define Spreadsheet Template Page](#)
2. Populate the CSV File with your asset transaction data.
3. Review asset transaction data stored in the CSV file and load the data to the Asset Management interface tables (INTFC_FIN and INTFC_PHY_A).

See [Upload Spreadsheet Data Page](#)

4. Review asset transaction data stored in the Asset Management interface tables.

See:

[Financial Transaction Page](#)

[Physical Transaction Page](#)

5. Run the Transaction Loader Edit Process. (*existing process*)

See [Edit Page](#)

6. Run Transaction Loader process. (*existing process*)

See “Load into AM Page” (Asset Lifecycle Management Fundamentals)

7. Review final assets using pages such as the General Information, Cost History, and ARO Measurement. (*existing pages*)

See:

[General Information Page](#)

[Cost History Page](#)

[ARO Measurement Page](#)

Define Spreadsheet Template Page

Use the Define Spreadsheet Template page (AM_TEMPLATE) to define spreadsheet template parameters and generate the template (which you will use to populate with your asset transaction data).

Navigation:

Set Up Financials/Supply Chain > Product Related > Asset Management > Import Spreadsheet Setup > Define AM Spreadsheet Template > Define Spreadsheet Template

This example illustrates the fields and controls on the Define Spreadsheet Template page.

Define Spreadsheet Template

Template ID

*Description

Transaction [View Template Audit](#)

Asset Fields ?

Column Sequence	Field Name	Field Long Name	Required	Active
10	BUSINESS_UNIT	Business Unit	<input checked="" type="checkbox"/>	<input checked="" type="checkbox"/>
20	ASSET_ID	Asset Identification	<input checked="" type="checkbox"/>	<input checked="" type="checkbox"/>
30	DESCR	Description	<input type="checkbox"/>	<input checked="" type="checkbox"/>
40	DESCRSHORT	Short Description	<input type="checkbox"/>	<input checked="" type="checkbox"/>
50	DESCR_LONG	Long Description	<input type="checkbox"/>	<input checked="" type="checkbox"/>
60	ACQUISITION_CD	Acquisition Code	<input type="checkbox"/>	<input checked="" type="checkbox"/>

This example illustrates the fields and controls on the Define Spreadsheet Template page.

70	FINANCING_CD	Financing Code	<input type="checkbox"/>	<input checked="" type="checkbox"/>
80	PROFILE_ID	Asset Profile ID	<input checked="" type="checkbox"/>	<input checked="" type="checkbox"/>
90	SERIAL_ID	Serial ID	<input type="checkbox"/>	<input checked="" type="checkbox"/>
100	TAG_NUMBER	Tag Number	<input type="checkbox"/>	<input checked="" type="checkbox"/>
110	CUSTODIAN	Custodian	<input type="checkbox"/>	<input type="checkbox"/>
120	CUSTODIAN_DEPTID	Asset Custodian Deptid	<input type="checkbox"/>	<input type="checkbox"/>
130	EMPLID	Empl ID	<input type="checkbox"/>	<input type="checkbox"/>
140	LOCATION	Location Code	<input type="checkbox"/>	<input checked="" type="checkbox"/>
150	AREA_ID	Area ID	<input type="checkbox"/>	<input type="checkbox"/>

[View/Download Template](#)

<i>Field or Control</i>	<i>Description</i>
Template ID	Displays the Template ID.
Description	Enter a description for the template CSV file. This value will appear in the file name of the CSV file.

Field or Control	Description
Transaction	<p>Displays the asset transaction type for the spreadsheet template.</p> <p>PeopleSoft provides three transaction types from which to choose:</p> <ul style="list-style-type: none"> • <i>Asset Addition</i> (add capitalized assets) • <i>Asset Addition With Accum Depr</i> (add capitalized assets with accumulated depreciation) • <i>Non Capitalized Asset Addition</i> • <i>ARO Conversion</i> • <i>ARO Measurement</i> (create initial ARO measurement) • <i>Asset Retirement</i> • <i>Adjust Accumulated Depr</i> • <i>Asset Cost Adjustment with %</i> • <i>Asset Cost Adjustment by Amt</i> • <i>Asset Recategorization</i> • <i>Interunit Transfer</i> • <i>Transfer Assets</i>
View Template Audit	<p>Click this link to view the Template Audit page and review Created by/Created on and Updated by/Updated on information for the template.</p> <hr/> <p>Note: This link does not appear until after you create the template.</p> <hr/>
View/Download Template	<p>Click this link to view or save the CSV template.</p> <p>If you are using Google Chrome as your web browser, you must download the file before you can view it.</p> <hr/> <p>Note: This link does not appear until after you create the template.</p> <hr/>

Asset Fields

Use the Asset Fields group box to select columns to appear in the spreadsheet and define the column order. PeopleSoft required columns are automatically selected and cannot be altered.

Field or Control	Description
Column Sequence	<p>Enter a numerical value for the column sequence. This value will provide the column order in the CSV file.</p> <hr/> <p>Note: PeopleSoft required fields are prepopulated with column sequence values and you cannot alter these values.</p> <hr/>
Field Name/Field Long Name	Displays the column name and long name.
Required	<p>This option indicates which columns are required by PeopleSoft.</p> <p>You cannot alter this option.</p>
Active	Select this option to activate non required columns. Selected columns will appear in the generated CSV file.
Create Template	<p>Click this button to create the spreadsheet template—a Comma Separated Values (CSV) file—based on the parameters you defined on this page.</p> <p>This process runs the ‘AM_ATT’ application engine, creates the CSV file, and stores the file in the PV_ATT_DB_SRV table.</p> <p>The CSV file name is automatically prefixed with ‘AM_TEMPLATE_’ for your convenience.</p> <hr/> <p>Note: Once you run the Create Template process, the View Template Audit and View/Download Template links appear, and the fields in the Asset Fields group box become unavailable for edit.</p> <hr/>
Delete Template	<p>Click this button to delete the spreadsheet template and corresponding template CSV file from the file repository system.</p> <p>You cannot delete the template if it is being used in an Upload Spreadsheet Data run control that has not been processed. To delete the template, you must first complete the Upload Spreadsheet Data process.</p> <hr/> <p>Note: This button does not appear during initial template creation; it appears only after you save the template and refresh the page.</p> <hr/>

Upload Spreadsheet Data Page

Use the Upload Spreadsheet Data page (AM_LOAD_RQST) to audit and review asset transaction data stored in the CSV file, and load the data to the Asset Management interface tables.

Navigation:

Asset Management > Send/Receive Information > Import Data via Spreadsheet > Upload Spreadsheet Data > Upload Spreadsheet Data

This example illustrates the fields and controls on the Upload Spreadsheet Data page.

Upload Spreadsheet Data

Run Control ID: IMPORT Report Manager Process Monitor **Run**

Upload Spreadsheet File

*Template ID: ADD
 Description: New Asset Acquisitions
 Transaction: Add Assets

Select Import File ?

View Import Data
Select File

Import File Name: AM_TEMPLATE_ADD.csv
 Row Count: 5
 Error Count: 3

Run Options ?

Increment to Next Interface ID Interface ID: 10000030
 Auto Approval
 Upload New Spreadsheet

View Spreadsheet Data ?

Asset Information Date Cost AP/PO Chartfields

Asset	Business Unit	Asset ID	Description	Profile ID	Acquisition Code	Financing Code	Short Description
	US001	NEXT	Passenger Wagon 01	AUTO			
	US001	NEXT	Passenger Wagon 02	AUTO			
	US001	NEXT	Passenger Wagon 03	AUTO			
	US001	NEXT	Cargo Van 01				
	US001	NEXT	Cargo Van 02	AUTO			

Save **Return to Search** **Previous in List** **Next in List** **Notify**

Field or Control	Description
Run	<p>Click to run the 'AM_LOAD' application engine and load asset transaction data in the CSV file to the Asset Management interface tables INTFC_FIN and INTFC_PHY_A.</p> <p>You cannot run this process if there are error rows in the CSV file, or when the assets being uploaded are mixed approval—that is, some assets require approval and others do not. A validation error will be displayed to indicate this.</p>
Template ID	<p>Select a template ID for the run control.</p> <p>The template determines what information displays in the View Spreadsheet Data grid.</p>

Select Import File

Field or Control	Description
View Import Data	<p>Select this option to display asset transaction data from the CSV file in the View Spreadsheet Data group box (after you have imported the file).</p> <p>Error data will automatically display in the View Spreadsheet Data group box, even if you do not select this option.</p>
Select File	<p>Click to import the CSV file you created using the Define Spreadsheet Template page. When you click the Select File button, the File Attachment pagelet appears and enables you to navigate to your CSV file.</p> <p>After selecting the file, click Upload. The system performs a data integrity check on the CSV file and flags errors such as decimal precision, blank fields, currency codes, and so forth. If an error is detected, the row displays within the View Spreadsheet Data group box and is flagged with an error icon. You cannot run the upload process until the error is corrected.</p> <hr/> <p>Note: The file chosen for upload must be a Comma Separated Values file and should be populated with your asset transaction data.</p> <hr/>
Import File Name	Displays the name of the CSV file you imported.
Row Count	Displays the number of rows contained in the CSV file you imported.
Error Count	Displays the number of error rows in the CSV file you imported.

Run Options

<i>Field or Control</i>	<i>Description</i>
Interface ID	<p>Displays the interface ID.</p> <p>You can override this value with another if you choose.</p> <hr/> <p>Note: If you reuse an existing run control ID with the same Interface ID, the AM_LOAD process overwrites the interface data from the previous run.</p> <hr/>
Auto Approval	Select this option to automatically approve interface lines for the Transaction Loader process.

View Spreadsheet Data

Use this group box to review asset transaction data from the CSV file you have imported. The group box displays detailed asset information, such as asset ID and location, along with related ChartField and cost information. You can also view whether approvals are required for each asset.

In addition, if a data integrity error is detected in the CSV file, the row is flagged with an error icon and displays here. You cannot run the upload process until the error is corrected. To review detailed error information for a row, click an error icon. Clicking the error icon enables you to access the View Spreadsheet Error page and view error information for the row:

View Spreadsheet Error pagelet

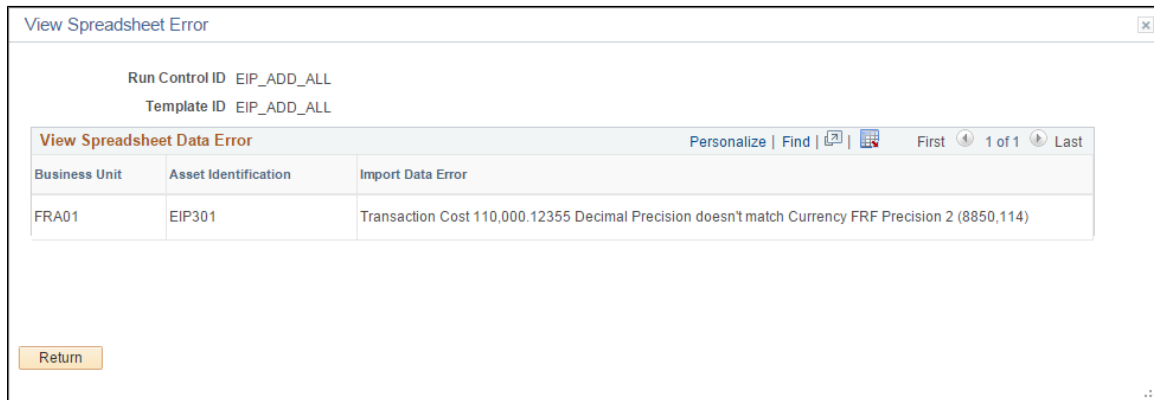

Use the information on the View Spreadsheet Error page as an aid in correcting data in your CSV file.

Note: This group box does not display on the page until you select the **View Import Data** option and import the CSV file. However, if a data integrity error is detected in the CSV file, the row displays here regardless of whether you have selected the **View Import Data** option.

Financial Transaction Page

Use the Financial Transaction page (INTFC_FIN_SS) to review asset transaction data in the INTFC_FIN table (after running the 'AM_LOAD' process and uploading CSV file data to Asset Management interface tables).

Navigation:

Asset Management > Send/Receive Information > Import Data via Spreadsheet > View Financial & Physical Data > Financial Transaction

This example illustrates the fields and controls on the Financial Transaction page.

The screenshot displays the 'Financial Transaction' page with the following data and controls:

- Page Header:** Financial Transaction | Physical Transaction
- Information:**
 - Intfc ID: 10000012 | Line Num: 1 | Unit: US001
 - Load Type: Financial & Physical Add | Intfc Stat: Mass Changes Generated | User: VP1
 - System Source: Load Data From Spreadsheet | Load Status: Loaded | Auto Approval Status
- Book Information:**
 - Asset ID: 00000000152 | Default Books from Profile | Book Name: []
 - Group Asset ID: [] | In Service Dt: 01/01/2015 | Impairment Process
- Depreciation Related Fields:**
 - Method: [] | Calculation Type: [] | Depreciate When in Service
 - Convention: [] | Depreciation Status: [] | Depreciation Bonus
 - Retire Conv: [] | Adjust Convention: [] | Bonus Percent: []
 - Useful Life: [] | Depreciation Percent: [] | UOP ID: []
 - End Date: [] | DB Percent: [] | Future Depr Yrs: []
 - Susp Stat: [] | Schedule Code: [] | Avg Option: []
 - Susp Date: [] | Depr Limit Code: [] | Acct Mthd: []
 - Suspend Pd: [] | Low Limit: []
 - Resume Dt: [] | Cost Limit: []
 - Retire Option: []
- Tax Related Fields:**
 - Property Code: [] | Sec179: []
 - Property Type: [] | 179 Amt: []
 - TaxCred SW: [] | Basis Red: []
 - Basis Rcap: []
- UD Fields:**
 - UD Method: [] | Salvage Val: []
 - UD Char Field1: [] | Salvage %: []
 - UD Char Field2: [] | Tot Obligation: []
 - UD Date Field1: []
 - UD Num Field1: []
 - UD Num Field2: []

This example illustrates the fields and controls on the Financial Transaction page.

Depreciation Information			
Depr Amt		Fiscal Year	
YTD Depr		Start Period	
		End Period	
Cost Information			
Date/Time	06/19/2015 1:46:35PM	Rate Type	CRRNT
Cost	100000.00	Rate Multiplier	1.00000000
Base Currency	USD	Rate Divisor	1.00000000
Transaction Cost	100000.00	Rate Effdt	01/01/2015
Transaction Currency	USD	Cost Type	
Qty	1.0000	Category	
Salvage		Operating Unit	ALBERTA
Trans Code		Fund Code	F100
Acctg Date	01/01/2015	Department	11000
Trans Date	01/01/2015	Program Code	EIP30
		Class Field	EIP30
		Budget Reference	EIP301
		Product	EIP301
		PC Business Unit	
		Project	EIP301
		Activity	
		Source Type	
		Category	
		Subcategory	

Information on this page is display only.

Physical Transaction Page

Use the Physical Transaction page (INTFC_PHY_A_SS) to review asset transaction data in the INTFC_PHY_A table (after running the 'AM_LOAD' process and uploading CSV file data to Asset Management).

Navigation:

Asset Management > Send/Receive Information > Import Data via Spreadsheet > View Financial & Physical Data > Physical Transaction

This example illustrates the fields and controls on the Physical Transaction page.

Financial Transaction		Physical Transaction	
Interface ID	10000012	Interface Line Number	1
		Unit	US001
Information Find View All First 1 of 1 Last			
Load Type	Financial & Physical Add	Intfc Stat	Mass Changes Generated
System Source	Load Data From Spreadsheet	Load Status	Loaded
		Date/Time	06/19/2015 1:46:35PM
Asset Information			
Asset ID	00000000152	Descr	NEXT
Short Desc	NEXT	Contact	
Profile ID	AUTO	Phone #	
Threshold ID		Asset Subtype	
Asset Type		Asset Class	
Status	In Service	Parent ID	
Tag Number		Parent Asset Description	
Serial ID		Parent Long description	
Acq Date	01/01/2015	Replaced Asset ID	
Acq Code	P	Replace	100000.00
Lease ID		Component of Asset	
Region			
<input type="checkbox"/> Linear Asset			
Detailed Description: NEXT			
Custodian	EIP.301	Effective Sequence	
Empl ID	EIP301	Asset Custodian DeptId	30000
Cust Effdt	01/01/2015	Asset Custodian Project	
Loc Effdt	01/01/2015	Loc Au St	
Loc Effseq		Loc Au Nm	
Location	ALBERTA	Loc Au Dt	
Area ID	LOT1		
		Authorization Status	
		Auth. Name	
		Date Authorized	
		<input type="checkbox"/> Offsite	

This example illustrates the fields and controls on the Physical Transaction page.

R&D Plant	CAP #	Version
R and D Start	Sequence	Date Made
Use NBV	Contact	Plant
Stock Keeping Unit		VIN
Manufacturer ID	DELL	Model
Manufacturer	DELL	DELL301
Incentive ID	JV BUS	UD Char Field1
IP Address	Number of CPUs	UD Char Field2
Index Name	FERC Code	UD Date Field1
Subindex		UD Num Field1
		UD Num Field2
<input type="checkbox"/> Asset Resource Switch	<input type="checkbox"/> Repairable Flag	Parts List Template
<input type="checkbox"/> Allow Overbooking	<input type="checkbox"/> Non-Owned Asset	Shop
<input type="checkbox"/> Asset Offline	Work Order Location	Crew
<input type="checkbox"/> Schedulable Switch	Asset Criticality	Business Unit
	Charge Back Switch	Repair Status
	Default	0
Site ID	Parent Property ID	Occupancy Status
Building ID	Total Area	10
Floor ID	Current Occupancy	Property Class
Area ID	Maximum Occupancy	Available For Use
Property Name		
Property Description		

This example illustrates the fields and controls on the Physical Transaction page.

Acquisition Related Fields		
Qty	1.0000	Base Currency USD
Amount	100000.00	Transaction Currency USD
Tran Amt	100000.00	Sales Tax Code
Sales Tax		Use Tax
Base Sales Tax Amount		Rate Divisor 1.00000000
Use Tax		Rate Multiplier 1.00000000
Use Tax Amt Base Curr		Rate Type CRRNT
Freight		Cost Type
Base Freight Amount		
Acq Detail NEXT	Category	
Capitalize 2	Chartfields	
Sequence		

Information on this page is display only.

Adding Assets with the Excel to Component Interface Utility

The PeopleTools Excel to Component Interface utility enables you to add assets from a predefined spreadsheet template. You can use the utility to upload new asset information during a conversion or when adding assets acquired from an acquisition or merger. You can add financial data and physical data. Once the data is uploaded, it is available for the Transaction Loader process to process the asset additions as financial add transactions (FAD).

Note: The amount of data that can be uploaded from a spreadsheet is limited by the spreadsheet utility. Consequently, this method of conversion is inappropriate for large-volume data conversions.

This topic provides an overview of how to import asset information with the Excel to Component Interface utility.

Pages Used to Add Assets with the Excel to Component Interface Utility

Page Name	Definition Name	Usage
Import Data Via Spreadsheet Page	INTFC_FINPHY_SS	Preview data uploaded from ExcelToCI utility to import and add financial transaction data to Asset Management tables INTFC_FIN and INTFC_PHY_A before running the transaction loader. If you want to change any information, you must go back to the ExcelToCI utility to make changes.

See also the product documentation for *PeopleTools: PeopleSoft Component Interfaces*.

Understanding How to Import Asset Information with the Excel to Component Interface Utility

The PeopleSoft system provides a template to import and add transactions financial data from the spreadsheet to Asset Management tables INTFC_FIN and INTFC_PHY_A with the Excel to Component Interface utility.

Here is an overview of the steps to add assets using import data from an Excel spreadsheet:

1. Connect to the database by entering the database connect information on the template Connect Information tab.

You need the PeopleSoft web server name, port, PeopleSoft Pure Internet Architecture or portal name, and default local node.

2. Select the predefined component interface (INTFC_FINPHY_SS_A) to populate the template on the Template tab.
3. Select the fields that are used to enter data.

Select **New Data Input** to format the Data Input tab with the selected data fields for the component interface.

4. Input data for all identified and selected record levels on the Data Input tab.
5. Stage the input data to the Stage & Submit Data tab.
6. Review the data that is ready for staging on the Stage & Submit Data tab.
Submit data for error-checking and transmission to the database, if successful.
7. Errors are returned to the Stage & Submit Data tab; select the **Post Results** option to return processing errors to the Data Input tab for reworking.
8. Submit data to the PeopleSoft Asset Management database as needed to successfully transmit all input data to Asset Management.
9. Preview the financial and physical data, using the menu option for importing data through a spreadsheet.
10. Run the Transaction Loader process to add assets to the database.

Import Data Via Spreadsheet Page

Use the Import Data Via Spreadsheet page (INTFC_FINPHY_SS) to preview data uploaded from ExcelToCI utility to import and add financial transaction data to Asset Management tables INTFC_FIN and INTFC_PHY_A before running the transaction loader.

If you want to change any information, you must go back to the ExcelToCI utility to make changes.

Navigation:

Asset Management > Send/Receive Information > Import Data via Spreadsheet > Financial and Physical > Import Data Via Spreadsheet

Connect and select the component interface to be used for the asset upload: INTFC_FINPHY_SS_A. Select the data fields to be entered and format the Data Input tab by selecting **New Data Input**. Access the Input Data page of the Excel to Component Interface utility. The following table describes the entries for required fields to upload asset FAD transactions. Many other data fields are available to enter data through the template in addition to the ones described here; these are not required or key fields.

Record Level 000 identifies the common key field values to be shared by INTFC_FIN and INTFC_PHY_A. Record level 100 contains data fields for the INTFC_FIN table and record level 200 identifies the data fields for the INTFC_PHY_A table.

Row Property	Input Description	Entry Required
Interface ID (INTFC_ID)	Use a unique previously unused INTFC_ID. Lock the Installation_AM table by updating the INTFC_ID to the next INTFC_ID. Use that INTFC for the CIS.	Required
Interface Line Number (INTFC_LINE_NUM)	The INTFC_LINE_NUM must be unique for each ASSET_ID.	Required
Business Unit (BUSINESS_UNIT)		Required
Asset Identification (ASSET_ID)	This field can be NEXT.	Required
Asset Book Name (BOOK)	BOOK can be entered if the default profile SW (switch) = Y, but all the books need to be entered if the default profile SW = N (multiple lines for each asset, one line per book).	
Date/Time Stamp (DTTM_STAMP)	This field should be populated by the user. If left blank, the current time is entered for the row on which it is blank. If a different date-time stamp exists for the same asset, the asset cannot be created.	Required
Transaction Load Type (INTFC_TYPE)	Either FAD, ADD, CN1 & CN2 should be entered. If left blank, FAD is populated as the INTFC_TYPE	
System Source (SYSTEM_SOURCE)	Always populated as CIS.	
Interface Status (INTFC_STATUS)	Always populated as DON.	
Load Status (LOAD_STATUS)	Always populated as NEW.	

<i>Row Property</i>	<i>Input Description</i>	<i>Entry Required</i>
Default Books from Profile (DEFAULT_PROFILE_SW)		Required

Here is a portion of the input page:

This example illustrates the fields and controls on the Example of Input Data page. You can find definitions for the fields and controls later on this page.

	A	B	C	D	E	F	G	H	I
1	Enter Connect Information > Create Template > Input Data > Stage & Submit Data								
2	Interface ID	Interface Line Number	Business Unit	Asset Identification	Asset Book Name	Date/Time Stamp	Operating Unit	Department	Asset Category
3	73	1	US001	NEXT	CORP	2003-02-11 10:59:36	ILLINOIS	10000	AUTO
4	73	1	US001	NEXT	FEDERAL	2003-02-11 10:59:36	ILLINOIS	10000	AUTO
5	73	1	US001	NEXT	AMT	2003-02-11 10:59:36	ILLINOIS	10000	AUTO
6	73	1	US001	NEXT	ACE	2003-02-11 10:59:36	ILLINOIS	10000	AUTO
7	73	2	US001	NEXT	CORP	2003-02-11 10:59:36	ILLINOIS	10000	AUTO
8	73	2	US001	NEXT	FEDERAL	2003-02-11 10:59:36	ILLINOIS	10000	AUTO
9	73	2	US001	NEXT	AMT	2003-02-11 10:59:36	ILLINOIS	10000	AUTO
10	73	2	US001	NEXT	ACE	2003-02-11 10:59:36	ILLINOIS	10000	AUTO
11									

When the data input is complete, stage the data to the Stage & Submit tab. Data is transmitted to the database from the Stage & Submit page.

Previewing the Data to Be Imported Through a Spreadsheet

Access the Import Data Via Spreadsheet page (**Asset Management > Send/Receive Information > Import Data via Spreadsheet > Financial and Physical > Import Data Via Spreadsheet**).

Select the FIN and PHY data to be uploaded from the Excel to Component Interface utility. Enter search criteria. You can search by interface ID, interface line number, business unit, transaction load type, system source, auto-approval status, load status, asset identification, and asset book name. Preview the data before running the Transaction Loader process. If you need to enter changes, you must return to the Excel to Component Interface utility to make them or update them in preview pages depending upon user permissions

Copying an Asset

This topic discusses how to copy an asset.

Page Used to Copy an Asset

Page Name	Definition Name	Usage
<u>Create Asset Copies Page</u>	ASSET_COPY_01	<p>Copy an existing asset if its financial and physical information is similar to that of a new asset that you want to create. Copy the existing asset and change only the financial and physical information that is different. The system automatically assigns the new asset a different asset ID. Alternatively, you can specify an asset ID.</p> <p>If you copy a nonfinancial asset, the financial information will not be available.</p>

Create Asset Copies Page

Use the Create Asset Copies page (ASSET_COPY_01) to copy an existing asset if its financial and physical information is similar to that of a new asset that you want to create.

Copy the existing asset and change only the financial and physical information that is different. The system automatically assigns the new asset a different asset ID. Alternatively, you can specify an asset ID.

Navigation:

Asset Management > Asset Transactions > Owned Assets > Copy Existing Asset

This example illustrates the fields and controls on the Create Asset Copies page. You can find definitions for the fields and controls later on this page.

This example illustrates the fields and controls on the Create Asset Copies page. You can find definitions for the fields and controls later on this page.

Search assets to be copied by business unit, asset ID, tag number, parent ID, description, asset status, or threshold ID.

Note: Child assets can be copied, but parent assets cannot.

When a user performs a copy of an ARO-applicable asset, a warning message will display to warn user that there may be an obligating event for the new asset that requires recognition of ARO. The copy of the ARO will be considered for a future release based on customer demand.

See [Accounting for Asset Retirement Obligations](#)

Asset Copy Options

Select or deselect the data to be included in the copy.

If you select the PM Schedules check box, the system copies the asset's PM schedules to the new asset at the same time of copying an asset. To view the PM Schedules check box on the Copy existing Asset page, you need to select the Copy PM Schedules check box on the Asset Management Definition - Interface Options page.

Asset

The next available asset ID will be assigned. Enter the additional asset attributes for the copy.

Book

<i>Field or Control</i>	<i>Description</i>
Quantity , Cost, Category, and CT (cost type)	Displays the asset quantity, cost, category, and cost type.
Salvage Value	Displays a value that is calculated based on the selections for this field at the asset profile level (either flat amount or percentage). The salvage value is prorated based on a ChartField's cost if a flat amount is used. It appears as a percentage of cost if the Percentage option has been selected.

Related Links

[Adding and Maintaining Asset Information](#)

Viewing and Managing the Component Asset Hierarchy

This topic provides an overview of component asset hierarchies and discusses how to view and manage component asset hierarchy.

Pages Used to View and Manage the Asset Component Hierarchy

<i>Page Name</i>	<i>Definition Name</i>	<i>Usage</i>
Asset Component Hierarchy Page	AM_HGRID	View associated asset component relationships within the hierarchy (display only).
Asset Component Hierarchy Page	AM_HGRID	Update associated asset component relationships by moving assets within the hierarchy.
Provide Reason for the Modification Page	AM_HGRID_REASN_SEC	Provide a reason and details for the modification. See Asset Component Hierarchy Page
Summary of Changes Page	AM_HGRID_DISP_CHG	Review the summary of changes made within the asset hierarchy. See Asset Component Hierarchy Page
Asset Component Hierarchy Move Page	RUN_AMCH1000	Run the Asset Component Hierarchy Move report to view a list of assets that were moved. Run this report for all assets, financial assets or nonfinancial assets. (SQR) See Asset Component Hierarchy Page

Understanding Component Asset Hierarchies

Assets can be considered as components of other assets of a higher level. For example, when you acquire specialized heavy duty equipment, such as cranes, tractors, or construction vehicles, it may be useful to view specific elements of the asset as individual "subassets" that serve the overall asset it is a part of. A crane may use a specialized extension for larger projects, but the extension device must be attached to a crane before it is useful. In this case, the extension can be considered a component of the crane. It is, however, an expensive piece of equipment with a separate depreciable life from the crane and you would, therefore, want to maintain it as an asset rather than an expendable part of the crane.

In turn, the extension may also be used to support another component of itself, an optional set of hooks or lifters, for example. In such a case, the lifters are a component of the extension and the extension is a component of the crane. In this way, you may have multiple assets that serve one another as components of an asset at a higher level or that create a *component hierarchy*.

PeopleSoft Asset Management enables you to view and manage up to nine levels of asset component relationships from the Asset Component Hierarchy page. You can move assets within the hierarchy as needed, view those changes through the Summary of Changes page, and run a report to view changes within asset components for all assets, financial assets or nonfinancial assets.

Asset Component Hierarchy Page

Use the Asset Component Hierarchy page (AM_HGRID) to View associated asset component relationships within the hierarchy (display only).

Navigation:

Asset Management > Asset Transactions > Owned Assets > View Component Hierarchy

This example illustrates the fields and controls on the Asset Component Hierarchy page (View). You can find definitions for the fields and controls later on this page.

The screenshot shows the 'Asset Component Hierarchy' page. At the top, there are search filters for 'Unit' (US001), 'Asset ID' (0000000000002), and 'Serial ID' (666345234567). Below these is a 'Search' button. Further down, there is an 'Action' dropdown menu set to '2-Focus on Selected Row', a 'Go' button, an 'Expand To' link, and a 'Level' dropdown set to '4'. Below the search area is a section for 'Asset Component Information' with tabs for 'General Information' and 'Operation/Maintenance'. A table is displayed with the following data:

Select	Description	Asset ID	Tag Number	Asset Type	Subtype	Status
<input checked="" type="checkbox"/>	Gas/elec SUV - Fleet vehicle 1	0000000000002	P000000009001	Fleet	AUTO	In Service

This page appears as display only. Review the details within the Asset Component Hierarchy.

Field or Control	Description
Action	<p>After selecting a check box beside an asset, select one of the following actions and click the Go button:</p> <ul style="list-style-type: none"> <i>Focus on Selected Row</i> - Refresh the grid using the selected row as the starting point of the hierarchy. <i>Focus on Top Asset</i> - Refresh the grid using the highest asset as the starting point of the hierarchy.

Note: The View Component Hierarchy provides a subset of actions that are available within the Manage Component Hierarchy.

Asset Component Hierarchy Page

Use the Asset Component Hierarchy page (AM_HGRID) to Update associated asset component relationships by moving assets within the hierarchy.

Navigation:

Asset Management > Asset Transactions > Owned Assets > Manage Component Hierarchy



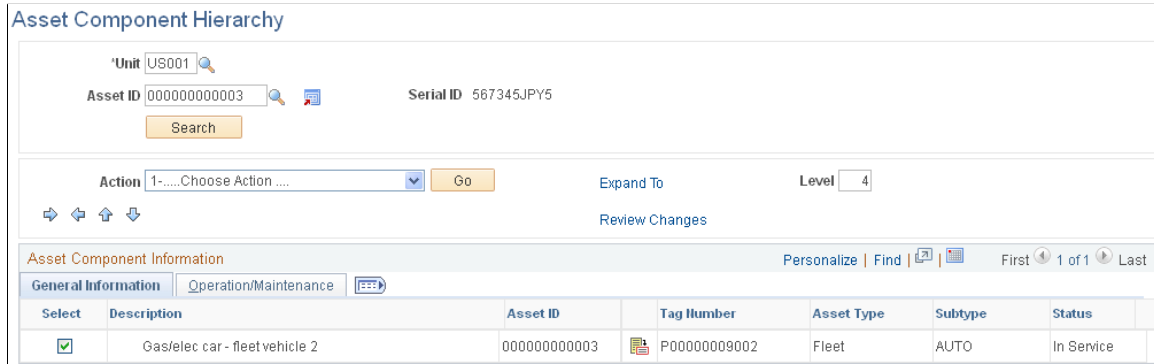





This example illustrates the fields and controls on the Asset Component Hierarchy page (Manage). You can find definitions for the fields and controls later on this page.



Select component assets and move them within the hierarchy. The Asset Component Hierarchy page displays up to nine levels. If the hierarchy of asset components is more than nine levels deep, you can manipulate the whole hierarchy by focusing on specific branches of the component tree.

Note: Property asset types are not editable. When you enter a property type of asset, after clicking the **Search** button, the page will display as if the View Component Hierarchy was used.

<i>Field or Control</i>	<i>Description</i>
Action	<p>Choose one of the following actions:</p> <ul style="list-style-type: none"> <i>Insert Asset on Row Below</i> - Insert a row in the grid just below the selected row. When selecting the first row of the grid, the insert creates a child of the first row. <i>Remove Asset from Hierarchy</i> - Remove the row from the grid and enter a reason for the removal on the secondary page that is provided. <i>Focus on Selected Row</i> - Refresh the grid using the selected row as the starting point of the hierarchy. <i>Focus on Top Asset</i> - Refresh the grid using the highest asset as the starting point of the hierarchy.
 Indent Row	Select that asset and click the Indent Row button. This action moves the selected asset down in the hierarchy so that it is a child of the prior row number (asset) in the grid.

Field or Control	Description
 Outdent Row	Click the Outdent Row button to move the selected asset up one level in the hierarchy.
 Move Item Use Sequence Up	Click the Move Item Use Sequence Up button to move the indented asset up to a different parent. If the parent asset is moved, all of the child assets are moved with it.
 Move Item Use Sequence Down	Click the Move Item Use Sequence Down button to move the selected asset down one row level.
Expand All link	Click to expand the entire hierarchy to view and manage all assets within the grid.
Review Changes link	Click to display a summary of changes made within the asset hierarchy (Summary of Changes page.)
 Comments	Add a comment to explain the reason for the change on the Provide Reason for the Modification page.
 Comment Warning	Upon save, this icon indicates that there have been no comments entered for the hierarchy change.
 Warning	<p>Upon save, this warning icon displays; mouse over text provides a detailed description of the warning for the following reasons:</p> <ul style="list-style-type: none"> No comment provided. Click the comment icon to add or update a comment. Custodian information not updated. Select the Operation/Maintenance tab to add or update the employee ID or department. Location information not updated. Select the Operation/Maintenance tab to add or update the location or area ID.
 Row Deleted	Indicates that the row has been removed from the hierarchy.
 Error	Indicates an invalid use of the Component field.
 Asset Search	Click the Asset Search icon to search for an asset. The system searches PeopleSoft Maintenance Management (MM) assets if that product is installed. If MM is not installed, the search is directed to PeopleSoft Asset Management for retrieval.

Field or Control	Description
 Asset Details	Click to view asset details for the given asset. You will be directed to the Define Asset Operational Information page when PeopleSoft Maintenance Management is installed. When PeopleSoft Maintenance Management is not installed, you are directed to the Basic Add page for asset details.

Operation/Maintenance Tab

This page displays only if PeopleSoft Maintenance Management is installed. It provides the Operation/Maintenance details for the assets such as Custodian, Asset Criticality, Repairable Flag, Repair Status, VIN, Serial ID, EmplID, Department, Location Code, and Area ID.

Comment Page

Use the Provide Reason for the Modification page (AM_HGRID_REASN_SEC) to Provide a reason and details for the modification.

Navigation:

Click the **Comments** icon from the Asset Component Hierarchy page. This icon is visible when a change is made to move an asset within the hierarchy.

This example illustrates the fields and controls on the Comment page. You can find definitions for the fields and controls later on this page.

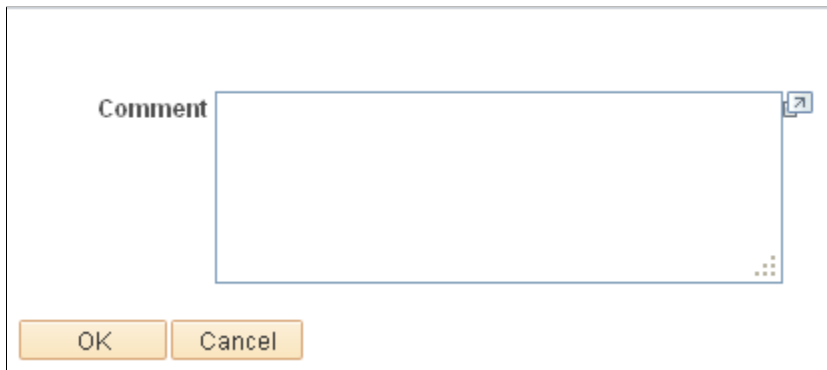

When a component is removed from the hierarchy, you must indicate a reason for this action. This comment page is automatically displayed and contains a reason drop down list in addition to the comment entry field. Both Reason and Comment are mandatory in the case of a removal from the hierarchy.

Summary of Changes Page

Use the Summary of Changes page (AM_HGRID_DISP_CHG) to Review the summary of changes made within the asset hierarchy.

Navigation:

Click the **Review Changes** link from the Asset Component Hierarchy page.

This example illustrates the fields and controls on the Summary of Changes page. You can find definitions for the fields and controls later on this page.



Asset Component Hierarchy Move Page

Use the Asset Component Hierarchy Move page (RUN_AMCH1000) to Run the Asset Component Hierarchy Move report to view a list of assets that were moved.

Run this report for all assets, financial assets or nonfinancial assets. (SQR)

Navigation:

Asset Management > Financial Reports > Asset Details > Asset Component Hierarchy Move.

This example illustrates the fields and controls on the Asset Component Hierarchy Move page. You can find definitions for the fields and controls later on this page.

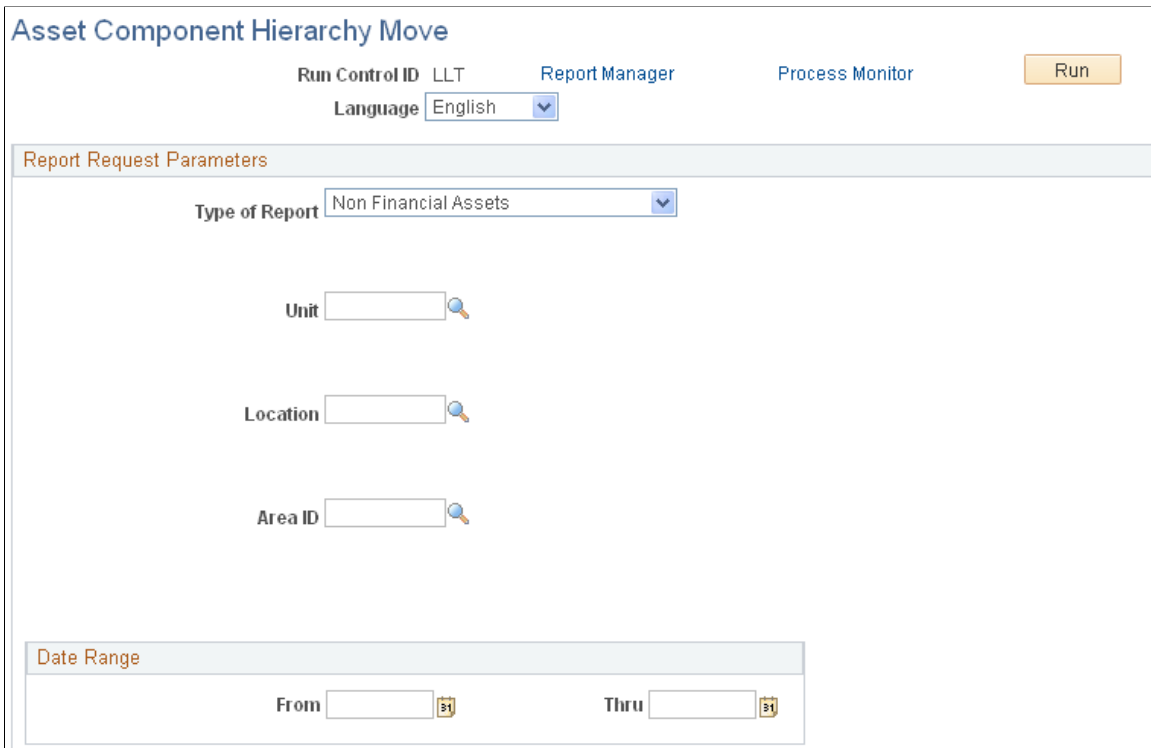

Field or Control	Description
Type of Report	Select to run the report for <i>All</i> assets, <i>Financial Assets</i> , or <i>Non Financial Assets</i> . When you select <i>Financial Assets</i> , the financial asset parameters appear.

Creating Parent-Child Asset Relationships

This topic provides an overview of parent-child asset relationships and discusses how to create Parent-Child Asset relationships.

Pages Used to Create Parent-Child Asset Relationships

Page Name	Definition Name	Usage
Asset Parent Page	ASSET_PARENT	Add an asset that is used only for reporting purposes as an umbrella for child assets. Add or delete comments. Link to a list of all child assets for a parent asset that has already been created.
Create Parent - Child Assets Page	CHILDASSETS_ALL	View child assets related to the parent asset.
Asset Information Page	ASSET_GENERAL_01	Add a parent asset or a child asset; select the appropriate parent asset for a child asset. See General Information Page
Cost/Asset Information Page	ASSET_ENTRY_00	Add a parent asset or a child asset; select the appropriate parent asset for a child asset.
General Parent Info	ASSET_GEN_PAR_CHD	Update basic information about a parent asset.
Location	ASSET_LOCATION	Update location information about a parent asset.
Custodian/License Page	ASSET_CUSTODIAN	Update custodian or license information about a parent asset. See Manufacture/License/Custodian Page

Page Name	Definition Name	Usage
<u>Child Assets Page</u>	CHILD_ASSETS	Select child assets to include in the update to a parent asset.
<u>Review Parent-Child Page</u>	PARENT_CHILDASSETS	View an asset and any child assets associated with it. Use links associated with each child to access other components of Asset Management.

Understanding Parent-Child Asset Relationships

Some assets stand alone, while others are grouped together for ease of processing and reporting. Parent-child assets are assets that are grouped together. For example, a computer can be regarded as several separate assets such as a monitor, a CPU, and a printer.

Three approaches you might use to add the computer as an asset follow:

- Add the computer as a single asset.

You use this approach to capitalize the asset with one cost, depreciate it as a single unit, and physically track it as one item.

- Create a parent asset that is not an actual asset but rather a conceptual asset (for reporting purposes) that ties together the various asset components.

In Asset Management, this is referred to as a *parent only* asset. Use the asset ID to tie together all the components as child assets. Each component has its own cost basis, depreciation, and physical tracking information.

- Identify one of the asset's components as the parent when you enter it.

In PeopleSoft Asset Management, this is referred to as a *parent component* asset. Give it an asset ID, and use that ID to tie together the other components as child assets. Each component has its own cost basis, depreciation, and physical tracking information.

Asset Parent Page

Use the Asset Parent page (ASSET_PARENT) to add an asset that is used only for reporting purposes as an umbrella for child assets.

Add or delete comments. Link to a list of all child assets for a parent asset that has already been created.

Navigation:

Asset Management > Asset Transactions > Parent-Child Relationship > Create Parent > Asset Parent

Parent assets created on this page cannot have associated costs and physical characteristics. Therefore, you cannot view them in the Parent-Child Basic Information component. Also, you cannot view them or perform transactions on them in the Asset Cost Adjust/Transfers component, the Asset Retirements

component, or the Parent-Child NBV component. You can, however, view them on the Inquire - Parent and Child Assets page.

Create Parent - Child Assets Page

Use the Create Parent - Child Assets page (CHILDASSETS_ALL) to view child assets related to the parent asset.

Navigation:

Click the **Child Assets** link on the Asset Parent page.

You can use this page to view a child asset if you have added it with future transaction and accounting dates that have not yet passed. You cannot view such an asset on the Inquire - Parent and Child Assets page.

The Capitalized Asset column indicates whether a child asset is capitalized or non capitalized.

Adding Parent and Child Component Assets

You can add parent and child assets by using the Asset Basic Information component or the Asset ExpressAdd component. Before you can identify a child asset of a parent, you must first identify the parent asset.

Using the Child Inherits Life of Parent Feature

When you use parent-child component assets, all child assets have their own cost basis and depreciation attributes that are independent of the parent asset. Because the child's asset life may differ from the life of the parent asset, you may need to specify that a new child asset of a parent component asset inherit the remaining life of the parent asset. For example, suppose that a car is depreciated using a five-year life. After two years, a CD player is added as a child asset to the car (which is the parent asset). You can depreciate the CD player over the remaining depreciable life of the car—that is, three years. The child asset then takes on the remaining life of the parent component asset. You can also override the child's asset life with a different life, if necessary.

Setting Up the Child Inherits Life of Parent Feature

You must select the Child Inherits Parent's Life option on the following two pages before you can use it:

- On the Asset Management page of the Installation Options component.
- On the Business Unit/Book Feature page of the Asset Management Business Unit Definition component.

Applying the Child Inherits Life of Parent Feature to a Child Asset

To apply the Child Inherits Parent's Life feature to a child asset:

1. Add the child asset using the Cost/Asset Information page of the Asset ExpressAdd component, and enter the cost.
2. Expand the **Asset Additional Information** group box.

From the **Parent-Child** drop-down list box, select *Child* to indicate that this is a child asset. Select an ID for the parent asset in the **Parent ID** field. You must enter a parent ID before you select **Default Profile**.

- From the **Asset Cost Information** group box, enter asset cost information for the child asset as it applies.

Click the **Default Profile** button to capitalize the asset and create all the corresponding asset books.

- When prompted, click **Yes** to have the system recalculate the book's asset life based on the parent's remaining life.
- Access the Depreciation Information page, and click the **Default Parent's Life** button to view or recalculate the child asset's life.

The Default Parent's Depr Attributes page appears. The **Parent Depreciation Attributes** section shows the asset life information for the parent asset. The **Child Depreciation Attributes** section shows the asset life information for the child asset that Asset Management calculates from the remaining life of the parent asset.

- Examine the calculated remaining life information, and either accept the remaining life for the child asset or change it by entering a new life

Note: Remember when working with parent/child assets, you must go to the Asset Additional Information section and enter the parent ID before you click the **Default Profile** button.

Updating Parent-Child Basic Information

Use the pages within the Parent-Child Basic Information component to update basic information about a parent and its child assets.

General Parent Info Page

Unit	Asset ID	Executive Office Set	Tag	In Service
US001	EX_PARENT003			
Description				
Description	Executive Office Set			
Short Desc	Executive			
Tag Number				
Asset Class				
*Asset Status	In Service			
Acquisition Date	01/01/2000			
*Acquisition Code	Purchased			
Profile ID	FURNITURE			
	<input checked="" type="checkbox"/> Capitalized Asset			
	<input checked="" type="checkbox"/> Taggable Asset			

Parent assets created on the Asset Parent page (parent-only assets) do not have cost or basic information. They cannot be viewed in the Parent-Child Basic Information component. Also you cannot view them or perform transactions on them in the Cost Adjust/Transfer Asset component, the Retire/Reinstate Asset component, or the Review Parent-Child NBV component. If you want to use a parent asset as an umbrella

asset for reporting purposes only and access these components to manipulate child assets in mass, you can create a 0-cost parent asset as opposed to a parent-only asset.

Any adjustments made to parent assets are not made to the associated child assets. To make a change to an associated child asset, select the child asset on the Child Assets page.

Details entered on the Location/Comment/Attributes page or the Manufacture/License/Custodian page are not automatically copied from a parent to its child assets.

Related Links

[Adding and Maintaining Asset Information](#)

Child Assets Page

Use the Child Assets page (CHILD_ASSETS) to select child assets to include in the update to a parent asset.

Navigation:

Asset Management > Asset Transactions > Parent-Child Relationship > Parent-Child Basic Information > Child Assets

This example illustrates the fields and controls on the Parent Child Basic Info - Child Assets page.

Selected	Tag Number	Description	Child Asset ID	Asset Status	Capitalized Asset	Cost	Currency	Acq Date	In Service Date	Asset Information
<input type="checkbox"/>	P00000000501	Desk	EX_CHILD0002	In Service	<input checked="" type="checkbox"/>	7500.00	USD	03/01/1999		Asset Information
<input type="checkbox"/>	P00000000506	Bookcase	EX_CHILD0013	In Service	<input checked="" type="checkbox"/>	1500.00	USD	02/03/2000		Asset Information
<input type="checkbox"/>	P00000000507	Chairs	EX_CHILD0014	In Service	<input checked="" type="checkbox"/>	5000.00	USD	02/03/2000		Asset Information
<input type="checkbox"/>	P00000000508	Lamps	EX_CHILD0015	In Service	<input checked="" type="checkbox"/>	2500.00	USD	02/03/2000		Asset Information
<input type="checkbox"/>	P00000000550	Carpet	000000000220	In Service	<input type="checkbox"/>			03/01/1999	03/01/1999	Asset Information

To include a child asset, select the check box in the **Selected** column.

Field or Control	Description
Tag Number	Displays the tag assigned to the child asset. Parent and child assets may share the same tag number. You can sort child assets according to this field.
Description	Displays the child asset description. You can sort child assets according to this field.
Child Asset ID	Displays the asset ID assigned to the child asset. You can sort child assets according to this field.
Asset Status	Displays the status of the child asset, such as <i>In Service</i> .

Field or Control	Description
Capitalized Asset	Indicates whether the child asset is capitalized or non capitalized.
Cost	Displays the cost of the child asset. You can sort child assets according to this field.
Currency	Displays the currency in which child asset costs are stored. You can sort child assets according to this field.
Acq Date (acquisition date)	Displays the date that the child asset was acquired. You can sort child assets according to this field.
In Service Date	Displays the In Service date of the child asset.
Asset Information	Click a link in this column to access another copy of the Asset Information page of the Asset Basic Information component. The component is populated with the child asset information.
Include Parent Asset	Deselecting this default setting enables you to update at once all or selected child assets while excluding the parent asset. However, the update details must be specified on the parent. Note: If you select the Include Parent Asset check box and the transaction is complete, the pages continue to show the parent asset as retired, transferred, or recategorized. The retained parent values are not displayed until you save and exit the pages and then access the component again.

Review Parent-Child Page

Use the Review Parent-Child page (PARENT_CHILDASSETS) to review an asset and any child assets associated with it.

Use links associated with each child to access other components of Asset Management.

Navigation:

Asset Management > Asset Transactions > Parent-Child Relationship > Review Parent-Child

This example illustrates the fields and controls on the Review Parent-Child page.

Review Parent-Child

Unit US001 Asset ID EX_PARENT003 Executive Office Set Status In Service
 Capitalized Asset

Tag Number
 Go To >>

Acquisition Code Purchased Asset Class
 Acquisition Date 01/01/2000 Profile ID FURNITURE Furniture & Fixtures
 Manufacturer

Personalize | Find | | First 1-5 of 5 Last

The following Child Assets are related to this Parent Asset									
Tag Number	Child Asset ID	Description	Asset Status	Capitalized Asset	Acquisition Date	In Service Date	Total Cost	Currency	Go To >>
P00000000501	EX_CHILD0002	Desk	In Service	<input checked="" type="checkbox"/>	03/01/1999		7500.00	USD	<input type="text"/>
P00000000506	EX_CHILD0013	Bookcase	In Service	<input checked="" type="checkbox"/>	02/03/2000		1500.00	USD	<input type="text"/>
P00000000507	EX_CHILD0014	Chairs	In Service	<input checked="" type="checkbox"/>	02/03/2000		5000.00	USD	<input type="text"/>
P00000000508	EX_CHILD0015	Lamps	In Service	<input checked="" type="checkbox"/>	02/03/2000		2500.00	USD	<input type="text"/>
P00000000550	00000000220	Carpet	In Service	<input type="checkbox"/>	03/01/1999	03/01/1999			<input type="text"/>

If the status of a parent asset is Retired or Disposed and the asset has child assets that are still in service, the child assets are orphaned. If you have added a child asset and given it future transaction and accounting dates that have not yet passed, you cannot view that child asset on this page. However, you can view it by clicking the link for the child asset on Asset Parent page.

The Capitalized Asset column indicates whether the child asset is capitalized or non capitalized.

Calculating Asset Replacement Costs

This topic provides an overview of asset replacement cost and lists the page used to calculate replacement cost.

Page Used to Calculate Replacement Cost

<i>Page Name</i>	<i>Definition Name</i>	<i>Usage</i>
Calculate Replacement Cost	RUN_AMRCCAL	Calculate asset replacement cost.

Understanding Asset Replacement Cost

Your tangible working assets are one of the greatest investments made in any enterprise. As certain assets approach the end of their useful lives, you need to be able to anticipate expenditures to replace these assets. You may need to get a replacement cost as you explore insurance coverage for property, equipment, computers, and other assets. Similarly, you may need to replacement calculate the cost in the event of an unforeseen loss, such as when plants or equipment are destroyed in a fire or a natural disaster.

PeopleSoft Asset Management provides the Calculate Replacement Cost application engine (AMRCCAL) that will make a replacement cost calculation of all assets, assets with new activity, or a selected range of assets, based on an index that you apply to the equation, such as the consumer price index (CPI) or other indexes you maintain.

Replacement cost of an asset should not include asset retirement cost. See [Accounting for Asset Retirement Obligations](#)

Defining Asset Operational Information

The Asset Operational Information component provides an efficient way to add and maintain nonfinancial assets. The operational and maintenance fields are available as they are in the Basic Add component but without the financial fields. From this component, however, you can access both financial and nonfinancial assets.

This component also provides a Maintenance Workbench to more easily access other areas of interest within the Service and Maintenance component. The Maintenance Workbench includes links to asset insurance, warranties, inspection, checkout, maintenance history, meter reading, and service and repairs.

Note: Group assets, composite assets, and parent/child assets are not created through this component.

Pages Used to Add and Maintain Asset Operational Information

<i>Page Name</i>	<i>Definition Name</i>	<i>Usage</i>
<u>Define Asset Operational Information - Asset Information Page</u>	AM_OM_ASSET_ADD	Add nonfinancial assets and corresponding details including asset type, manufacture, asset resource, location, custodian, license information, and physical attributes. Include an image of the asset and use the Maintenance Workbench to track service and repairs, warranties, and other maintenance details.
Define Asset Operational Information - Asset Property Page	ASSET_PROPERTY	Enter details to manage nonfinancial property assets and to maintain property-specific attributes such as identifying information, asset hierarchy, area and occupancy, and legal descriptions. This page tab appears when the asset type of <i>Property</i> is selected; however, if Lease Administration is not a selected product within Installation Options and Space Management Installed is not selected within the Asset Management Installation Options, the Property page is disabled. See <u>Asset Property Page</u>
<u>Define Asset Operational Information - Customize Page Layout Page</u>	AM_CUSTOMIZE_PAGE	Customize the layout of the Asset Information page to hide, expand or collapse various sections on the page.
<u>Asset Supplemental Data Page</u>	AM_ASSET_SD	Record additional data regarding hardware information and maintenance information for nonfinancial assets.

Define Asset Operational Information - Asset Information Page

Use the Define Asset Operational Information - Asset Information page (AM_OM_ASSET_ADD) to Add nonfinancial assets and corresponding details including asset type, manufacture, asset resource, location, custodian, license information, and physical attributes.

Include an image of the asset and use the Maintenance Workbench to track service and repairs, warranties, and other maintenance details.

Navigation:

Asset Management > Asset Transactions > Owned Assets > Define Asset Operational Info > Asset Information

This example illustrates the fields and controls on the Define Asset Operational Information page. You can find definitions for the fields and controls later on this page.

Asset Information

Asset Property

Asset Supplemental Data

Define Asset Operational Information

Business Unit	US001	Asset ID	000000000001
Tag Number	<input type="text"/>	*Asset Status	In Service ▼
Short Desc	SOLARIS WO	Profile ID	COMPUTERS
Description	SOLARIS WORKSTATION	Customize Page Layout Attachments (0)	
Detailed Description	SOLARIS WORKSTATION		

Asset Structure

Asset Type	IT Hardware ▼
Asset Subtype	<input style="width: 100%;" type="text"/>
Component of	<input style="width: 100%;" type="text"/>
Tag Number	<input style="width: 100%;" type="text"/>

[Work Order Options for Components](#)

Manufacturer Information

Serial ID	000000000001
Manufacturer ID	<input style="width: 100%;" type="text"/>
Manufacturer Name	<input style="width: 100%;" type="text"/>
Model	<input style="width: 100%;" type="text"/>
Product Version	<input style="width: 100%;" type="text"/>
Plant	<input style="width: 100%;" type="text"/>
VIN	<input style="width: 100%;" type="text"/>
IP Address	<input style="width: 100%;" type="text"/>
Production Date	<input style="width: 100%;" type="text"/>
Contact	<input style="width: 100%;" type="text"/>
SKU	<input style="width: 100%;" type="text"/>
Number of CPUs	1

This example illustrates the fields and controls on the Define Asset Operational Information page. You can find definitions for the fields and controls later on this page.

Physical Life Information

In Service Date 05/01/2000	
Life Expectancy Yrs <input type="text" value="45.00"/>	Life Expectancy Note <input type="text" value="Average life expectancy for this asset type"/>
End of Support <input style="font-size: small; border: none; padding: 0 5px;" type="text" value="01/01/2000"/>	End of Support Note <input type="text" value="Support has ended"/>
End of Life <input style="font-size: small; border: none; padding: 0 5px;" type="text"/>	End of Life Reason <input style="font-size: small; border: none; padding: 0 5px;" type="text" value="Scrap"/>
Replacement 05/01/2045	
Life Expectancy % 44.77	

Asset Resource Information

<input type="checkbox"/> Schedulable	<input type="checkbox"/> Allow Overbooking	<input type="checkbox"/> Use As Tool
WO Unit <input style="font-size: small; border: none; padding: 0 5px;" type="text"/>	Shop <input style="font-size: small; border: none; padding: 0 5px;" type="text"/>	Crew <input style="font-size: small; border: none; padding: 0 5px;" type="text"/>

Maintenance Information

<input type="checkbox"/> Repairable	Repair Status <input style="font-size: small; border: none; padding: 0 5px;" type="text" value="None"/>	Parts List <input style="font-size: small; border: none; padding: 0 5px;" type="text"/>
<input type="checkbox"/> Offline	WO Location <input style="font-size: small; border: none; padding: 0 5px;" type="text"/>	Criticality <input style="font-size: small; border: none; padding: 0 5px;" type="text" value="02"/> Medium

Additional Information

<input type="checkbox"/> Hazardous Asset	Hazardous Code Information	
<input type="checkbox"/> Non-Owned Asset	<input checked="" type="checkbox"/> In Physical Use	
<input type="checkbox"/> Replacement Asset	Asset ID <input style="font-size: small; border: none; padding: 0 5px;" type="text"/>	
<input type="checkbox"/> Asset is Available	Contact <input style="font-size: small; border: none; padding: 0 5px;" type="text"/>	Phone # <input style="font-size: small; border: none; padding: 0 5px;" type="text"/>

This example illustrates the fields and controls on the Define Asset Operational Information page. You can find definitions for the fields and controls later on this page.

Location

Location <input style="font-size: small; border: none; padding: 0 5px;" type="text" value="US001"/>	USA - New York
Area ID <input style="font-size: small; border: none; padding: 0 5px;" type="text" value="PARKING A"/>	Parking A - HQ
Address 144 North Street	
City New York	County
State NY New York	Jurisdiction
Country USA	Sector
Zip Code 10168	Building
Floor #	Room# 845
Latitude 40.5100000	Longitude 73.7000000

Custodian Information

License Information

This example illustrates the fields and controls on the Define Asset Operational Information page. You can find definitions for the fields and controls later on this page.

Physical and Custom Attributes

Effective Date: 06/23/2020

Color:

Height: Height Units:

Width: Width Units:

Length: Length Units:

Weight: Weight Units:

Capacity: Capacity Units:

Power Rating: Power Rating Units:

Custom Attributes

Attribute	Attribute Name	Value	UOM
<input type="text"/>	<input type="text"/>	<input type="text"/>	<input type="text"/>

This example illustrates the fields and controls on the Define Asset Operational Information page. You can find definitions for the fields and controls later on this page.

Comments

Date/Time: 06/23/2020 1:16:08PM

User Name: Source:

Comment:

Image

Maintenance Workbench

- Enter Meter Reading
- Asset Insurance
- Review Maintenance History
- Asset Warranties
- Asset Inspection
- Asset Checkout
- Track Service and Repairs

The Define Asset Operational Information page provides an efficient way of capturing data for physical operators who do not handle financial information. You can review both financial and nonfinancial assets from this page and make changes to the attributes; however, there are no financial implications.

Any changes you make, such as custodian or location, appears as a new entry rather than an update to the existing entry. The effective date is the system date and the profile ID is editable only when adding a new asset.

Note: The Capitalization Threshold feature is not available for assets that are added using this component.

See [General Information Page](#).

Physical Life Information

Use this section to track the physical life of an asset, determine the life expectancy of equipment, and plan for equipment replacement.

The fields in this section are physical asset attributes only and are not used to calculate and record the accounting of asset cost or depreciation.

Field or Control	Description
In Service Date	<p>Displays the in-service date from the asset record.</p> <p>This date is used in the life expectancy and replacement date calculations, and is defined using the General Information Page. It is labeled as Placement Date.</p>
Life Expectancy Yrs (Life Expectancy Years)	<p>Enter the life expectancy of the asset in years. This is the physical life expectancy, not the depreciation (accounting) expectancy.</p>
End of Life	<p>Enter the end of life date for the asset.</p>
End of Life Reason	<p>Select a reason for the end of life.</p> <p>Values for this field are defined on the “End of Life Reason Definition Page” (Asset Lifecycle Management Fundamentals).</p>
Replacement (Date)	<p>Displays the estimated date in which the asset should be replaced.</p> <p>Replacement date is determined in this way:</p> <ul style="list-style-type: none"> • When End of Life date is provided, replacement date is the end of life date. • When End of Life date is not provided, replacement date is <i>In Service Date + Life Expectancy Years</i>.
Life Expectancy % (Life Expectancy Percent)	<p>Displays the current age expressed as a percent of life expectancy.</p> <p>Life Expectancy Percent is determined in this way:</p> $\text{Asset Age (Current Date - In Service Date) / Life Expectancy Years} * 100$ <p>For example, asset age 2.5 years / life expectancy 7 years * 100 = 35.71% of total life expectancy.</p>

Note: The Manufacture/License/Custodian Page has the same physical life fields included on this page. When you make an update to the physical life fields on that page, the changes are reflected here.

Define Asset Operational Information - Customize Page Layout Page

Use the Define Asset Operational Information - Customize Page Layout page (AM_CUSTOMIZE_PAGE) to Customize the layout of the Asset Information page to hide, expand, or collapse various sections on the page.

Navigation:

Click the **Customize Page Layout** link from the Define Asset Operational Information page.

This example illustrates the fields and controls on the Define Asset Operational Information - Customize Page Layout page. You can find definitions for the fields and controls later on this page.

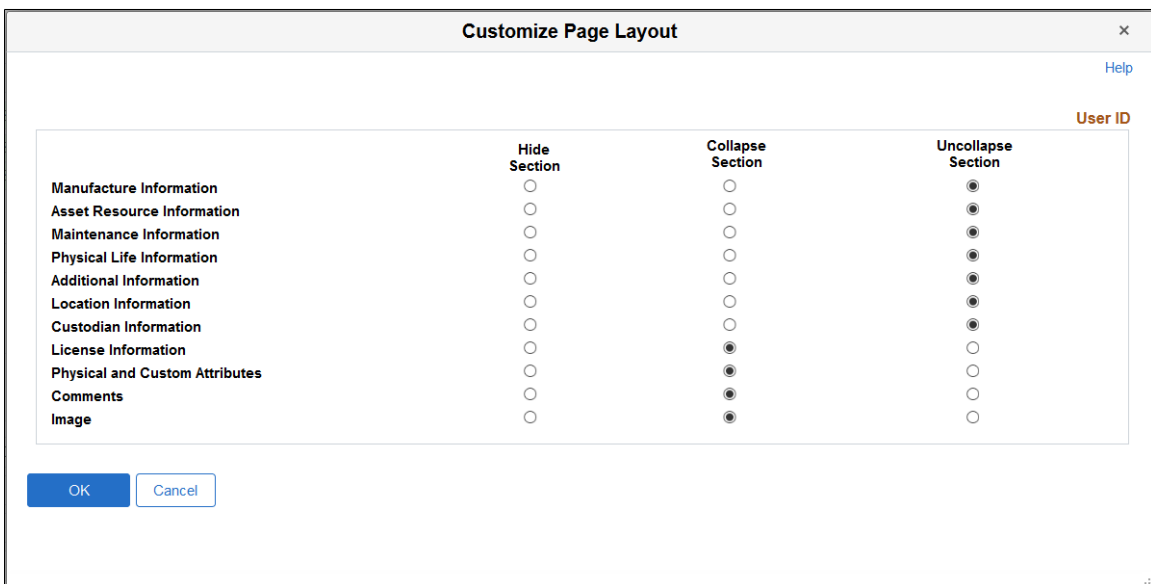

Searching for Asset Information

This topic discusses how to search for an asset.

Page Used to Search for Asset Information

<i>Page Name</i>	<i>Definition Name</i>	<i>Usage</i>
<u>Search for an Asset Page</u>	AM_LOOKUP_PNL	Search for an asset based on specified criteria. After you find assets that meet the criteria, you can view them in greater detail. Use links to quickly access other components in the system and perform transactions on selected assets.

Search for an Asset Page

Use the Search for an Asset page (AM_LOOKUP_PNL) to search for an asset based on specified criteria.

After you find assets that meet the criteria, you can view them in greater detail. Use links to quickly access other components in the system and perform transactions on selected assets.

Navigation:

Asset Management > Search for an Asset

This example illustrates the fields and controls on the Search for an Asset page. You can find definitions for the fields and controls later on this page.

The screenshot shows the 'Search for an Asset' interface. It includes sections for 'Asset Search Criteria' with fields for Unit, Book, Parent ID, Category, Location, Area ID, Asset ID, Asset Status, Impairment Processing, Tag Number, Profile ID, Group ID, Serial ID, Threshold ID, and ARO. There are also checkboxes for 'Approval Pending' and 'Additional Search Criteria'. Below this is the 'Acquisition Details' section with fields for PO Unit, Receipt Unit, AP Unit, PC Bus Unit, PO No, Receipt No, Voucher, and Project ID. A 'Retrieve' section contains checkboxes for Cost Information, Acquisition Information, Location, Non Capital Asset, Custodian, and Lease. Search controls include 'Search', 'Clear', 'Drill-Down To', and 'GO!' buttons. The results section shows a table with columns for Unit, Asset ID, Description, Asset Type, Asset Subtype, Tag Number, and Serial ID. The table contains 9 rows of asset data.

Unit	Asset ID	Description	Asset Type	Asset Subtype	Tag Number	Serial ID
US001	000000000001	SOLARIS WORKSTATION	IT Hardware			000000000001
US001	000000000002	Gas/elec SUV - Fleet vehicle 1	Fleet	AUTO	P00000009001	666345234567
US001	000000000003	Gas/elec car - fleet vehicle 2	Fleet	AUTO	P00000009002	567345JPY5
US001	000000000004	Gas/elec hybrid - fleet vehicl	Fleet	AUTO	P00000009003	123JPY345
US001	000000000005	Fleet vehicle - Gas/Elec Hybrl	Fleet	AUTO	P00000009005	PRIUS1234
US001	000000000006		Other		P000038675	02716277 -3
US001	000000000007		Other		P000041715	02736047
US001	000000000008		Other		P00006375	SG57740753
US001	000000000009		Other		P00007120	3433S22855

Note: The asset search utility includes searching by the **Description** field. If processing is very slow, PeopleSoft recommends that an index of the DESCR field be created for the ASSET table to improve performance.

Enhancing Search Performance

When an organization maintains a high volume of property assets, it is recommended that you create new indexes and alternate search keys to enhance search performance.

Alternate search keys should be created for the following fields:

1. Table ASSET_SITE change Record Definition to include PROPERTY_NM as an Alternate Search Key field.
2. Table ASSET_BLDG change Record Definition to include PROPERTY_NM as an Alternate Search Key field.
3. Table ASSET_FLOOR change Record Definition to include PROPERTY_NM as an Alternate Search Key field.
4. Table ASSET_AREA change Record Definition to include PROPERTY_NM as an Alternate Search Key field.

The following new indexes should be created on the ASSET_PROPERTY table:

1. PS_ASSET_PROPERTY(BUSINESS_UNIT,SITE_PROPERTY_ID).
2. PS_ASSET_PROPERTY(BUSINESS_UNIT,BLDG_PROPERTY_ID).
3. PS_ASSET_PROPERTY(BUSINESS_UNIT,FLOOR_PROPERTY_ID).
4. PS_ASSET_PROPERTY(BUSINESS_UNIT,AREA_PROPERTY_ID).
5. PS_ASSET_PROPERTY(IS_LEASED, BUSINESS_UNIT, SITE_PROPERTY_ID, BLDG_PROPERTY_ID, FLOOR_PROPERTY_ID, AREA_PROPERTY_ID).

Asset Search Criteria

Use the **Asset Search Criteria**, **Acquisition Details**, and **Retrieve** group boxes to establish the search criteria. Each group box enables you to confine the search to specific tables according to the following rules:

- Asset table information is always retrieved.
- Cost information is retrieved if any of the cost fields are used in the search criteria, or the **Cost Information** check box is selected.

For example, if you enter a category and the asset is capitalized, the cost information for the asset is retrieved regardless of whether the cost information check box is selected. However, if you don't populate any of the cost fields in the search criteria, you need to select the **Cost Information** check box. If you don't need to view cost data, leave the check box blank.

- Asset acquisition information is retrieved if any of the fields in the **Acquisition Details** group box are used in the search criteria, or if the **Acquisition Information** check box is selected.
- Location code is retrieved if the location field is used to retrieve asset information or if the **Location** check box is selected.
- The **Non Capital Asset** check box is used *only* when the **Acquisition Information** and **Cost Information** check boxes are selected, or when fields from the **Asset Search Criteria** and **Acquisition Details** group boxes are specified.

Use the **Approval Pending** option to retrieve assets that are pending approval.

Use the **Additional Search Criteria** and **ChartField Search Criteria** links to further constrain your search criteria.

Access the Additional Search Criteria - More Filter Options page by clicking the Additional Search Criteria link.

This example illustrates the fields and controls on the Additional Search Criteria - More Filter Options page.

In addition to search fields such as Employee ID, Capitalized Asset, and Manufacturer ID, you can click the **Supplemental Data** link to access software specific search fields on the Additional Search Criteria - Supplemental Data Filter Options page. You must select one of the following Asset Types to enable the Supplemental Data link:

- *IT Hardware*
- *IT Software*
- *Equipment*
- *Property*
- *Facility*
- *Intangible*
- *Other.*

This example illustrates the fields and controls on the Additional Search Criteria - Supplemental Data Filter Options page.

Access the ChartField Search Criteria - More Filter Options page by clicking the ChartField Search Criteria link.

This example illustrates the fields and controls on the ChartField Search Criteria - More Filter Options page.

Operating Unit	Fund Code	Department	Program	Class Field	Bud Ref	Product	Project
<input type="text"/>	<input type="text"/>	<input type="text"/>	<input type="text"/>	<input type="text"/>	<input type="text"/>	<input type="text"/>	<input type="text"/>

OK Cancel

Search Results - Select One Asset to Continue

Search results display with details available from these tabs:

- **Asset Information:** This tab shows business unit, asset ID, description, asset type, asset subtype, tag number, serial ID, and status.
- **Asset Cost Information:** This tab shows business unit, asset ID, description, ChartFields, cost type, quantity, cost, and currency.
- **Acquisition Detail:** This tab shows business unit, asset ID, description, PO business unit, PO number, receiving business unit, receipt number, AP business unit, voucher ID, PC business unit, project ID, and activity.
- **Owner/Custodian:** This tab shows business unit, asset ID, description, employee ID, custodian, asset custodian department ID, and offsite status.
- **Work Maintenance:** This tab shows business unit, asset ID, description, use-as-tool option, schedulable option, capitalized asset option, overbooking option, work order location, work order business unit, work order shop, and VIN.
- **More:** This tab shows business unit, asset ID, description, profile ID, parent ID, group ID, location, lease end date, manufacturing ID, model, and replacement cost.

Display all columns by clicking the **Show all Columns** icon.

You can sort options to arrange the asset list order. For example, if you click **Asset ID**, assets are ordered according to the asset number assigned in either ascending or descending order.

Note: Some results may contain multiple ChartFields. To display them, click either the **Asset Cost Information** tab or the **Show all Columns** icon.

Drill-Down To

The drill-down functionality enables you to review detailed information about a selected asset within different Asset Management components. You can also use the drill-down functionality to copy or print an asset. Select one of the following options to view detailed asset information in a new window:

- *Asset Accounting Entries.*
- *Asset Basic Information.*
- *Asset Cost Adjust/Transfers.*
- *Asset Cost History.*
- *Asset Depreciation.*
- *Asset Retirements.*
- *Copy Asset.*
- *Define Tax/Depr Criteria* (define tax and depreciation criteria).
- *Print an Asset.*
- *View Component Hierarchy.*

Printing Asset Information

This topic lists the page used to print asset information.

Page Used to Print Asset Information

Page Name	Definition Name	Usage
“Printable view of Asset Page” (PeopleSoft IT Asset Management)	AM_LOOKUP_PRINT	Generate a printed copy of the asset basic information, default book and depreciation attributes, and asset cost information for the default book.

Working with Related Content in Asset Management

This topic provides an overview of related content and discusses how to access Asset Management related information.

Pages Used to Work with Asset Management Related Content

Page Name	Definition Name	Usage
<u>Define Related Content Service Page</u>	PTCSSERVICES	Create and manage service definitions.
<u>Manage Related Content for Content References Page</u>	PTCS_SRVCFG_SRCH	Manage related content and related action configurations for content references.
<u>Configure Related Content – Assign Related Content</u>	PTCS_SERVICECFG	Assign the related content service ID to the application component.
<u>General Information Page (Basic Add)</u>	ASSET_GENERAL_01	Asset Basic Add component.
<u>Cost History List Page</u>	ASSET_TRANS_01	Review Cost component.
<u>Asset Depreciation - Asset Page</u>	DEPR_ALL_MAIN	Asset Depreciation component.
<u>Review Reversal Transaction Page</u>	AM_REVERSAL_REVIEW	Review Transaction Reversal component.

Understanding Related Content

Using PeopleSoft Related Content Services Framework, you can configure services to appear on component pages without customizing PeopleSoft-delivered application pages. This framework provides immediate access to relevant, contextual information for PeopleSoft applications, such as Asset information, without requiring any additional user effort.

Asset Management delivers the following related content:

Related Content Service ID	Related Content Label	Component
AM_ARO_LINKS	ARO Information	Review Cost
AM_BOOK_HISTORY	Review Book	Review Transaction Reversal
AM_BOOK_HISTORY2	Book History	Asset Depreciation
AM_COST_HISTORY	Review Cost	Review Transaction Reversal
AM_COST_HISTORY2	Cost History	Basic Add Asset Depreciation

For more information about using related content, see *PeopleTools: PeopleTools Portal Technology*.

See "Working with Related Content Services," *PeopleTools: PeopleTools Portal Technology*.

Define Related Content Service Page

Access the Define Related Content Service page to create and manage service definitions.

Navigation:

PeopleTools > Portal > Related Content Service > Define Related Content Service

This example illustrates the fields and controls on the Define Related Content Service page. You can find definitions for the fields and controls later on this page.

Define Related Content Service

Service Information ?

Service ID: AM_COST_HISTORY2

*Service Name: Object Owner ID:

Description:

*URL Type: Write help text Copy Service Definition

URL Information

*Node Name:

Component Parameters

*Menu Name: *Market:

*Component Name: Page Name:

Post mapping definition data Escape URL Parameters

Note: parameter names are case-sensitive.

Service URL Parameters				First	1-2 of 2	Last
	*Parameter Name	Required Flag	*Description			
1	<input type="text" value="BUSINESS_UNIT"/>	<input checked="" type="checkbox"/>	<input type="text" value="BUSINESS_UNIT"/>	+	-	
2	<input type="text" value="ASSET_ID"/>	<input checked="" type="checkbox"/>	<input type="text" value="ASSET_ID"/>	+	-	

[Show Formed URL](#) [Test Related Content Service](#)

Refresh New Window

Select Security Options

Public Access Related Content Provider Security Related Content Consumer Security

App Class Required

Manage Related Content for Content References Page

Use the Manage Related Content for Content References page to manage related content and related action configurations for content references.

Navigation:

PeopleTools > Portal > Related Content Services > Manage Related Content Service > Manage Related Content for Content References

This example illustrates the fields and controls on the Manage Related Content for Content References page. You can find definitions for the fields and controls later on this page.



This example illustrates the fields and controls on the Assign Related Content page. You can find definitions for the fields and controls later on this page.

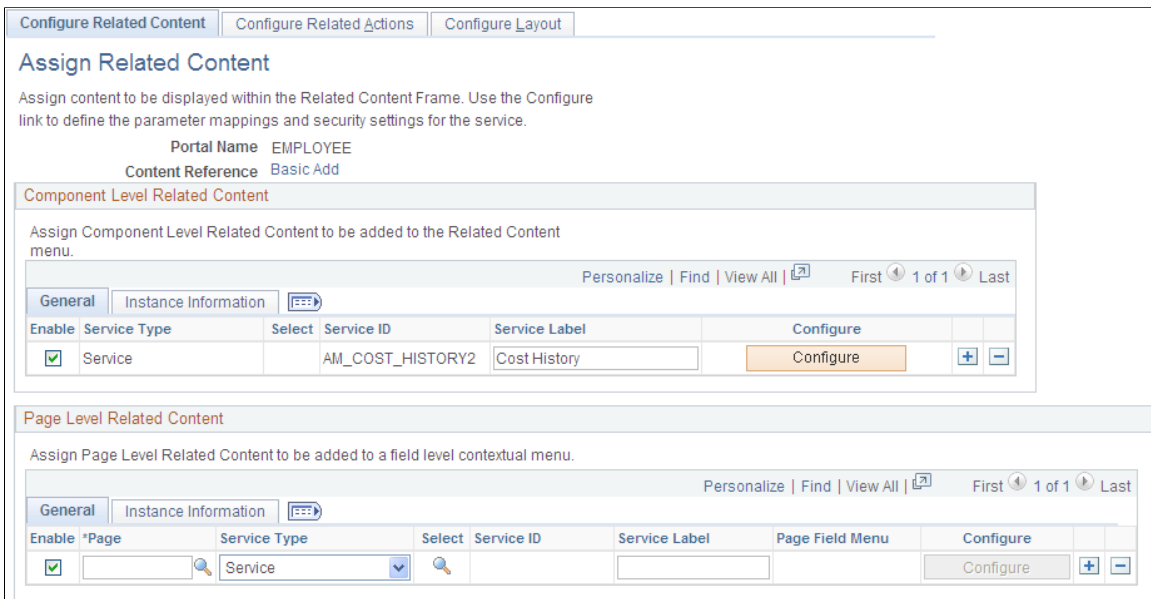

Notice that the Component Level Related Content is assigned to the Service ID, AM_COST_HISTORY2. There is no page level related content. If you want to modify the setup as delivered, see PeopleTools Documentation: *PeopleTools Portal Technologies, Developing and Configuring Related Content Services*.

Configure Layout Page

Click the **Configure** layout button to assign the related content service ID to the application component.

This example illustrates the fields and controls on the Configure Layout page. You can find definitions for the fields and controls later on this page.

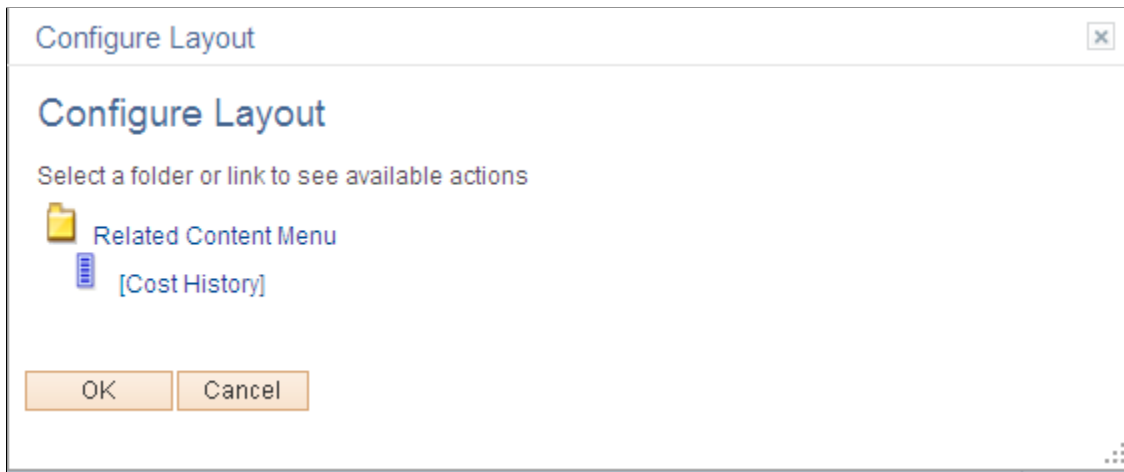

Click **OK** and Save the Configure Layout page.

See [Asset Acquisition Detail Page](#)

Verifying Data in the Loader Tables

You can see what data was loaded into the Asset Management loader tables (INTFC_FIN, INTFC_PHY_A, and INTFC_PHY_B). Viewing these tables provides the opportunity to preview the data that loads into Asset Management tables when you run the Transaction Loader process. If you find errors, you can either fix them online using your SQL query tool, or (preferably) modify the mass transaction definitions and run the mass transaction again.

This topic discusses how to verify data in the Loader tables.

Pages Used to Verify Data in the Loader Tables

<i>Page Name</i>	<i>Definition Name</i>	<i>Usage</i>
Review Page	AM_INTFC_TXN_RVW	View data in the financial and physical interface tables. Verify the financial and physical data (which the Transaction Loader process uses when populating Asset Management tables) and change incorrect data.

Review Page

Use the Review page (AM_INTFC_TXN_RVW) to view data in the interface tables.

Verify the financial and physical data (which the Transaction Loader process uses when populating Asset Management tables) and change incorrect data.

Navigation:

Asset Management > Send/Receive Information > Interface Transactions > Review Interface Transactions

This example illustrates the fields and controls on the Review Page (1 of 2). You can find definitions for the fields and controls later on this page.

Review

Interface ID 90000002 Interface Line Number 1

Physical Inventory ID Transaction

Interface Transaction Information Find | View All First 1 of 1 Last

Trans Load Type CN1 Load Status Pending Auto Approval Status

Load Type Description Conversion of First Book System Source Conversion

Asset Information

Business Unit US001 Description Interface demo data Linear Asset

Asset ID NEX Short Description Demo data

Tag Number Parent ID

Serial ID Component of Asset

Profile ID AUTO Threshold ID [Review Physical Attributes](#)

Detailed Description 254 characters remaining

Cost Information

Acquisition Date 06/07/2000 In Service Date 06/07/2000

Transaction Date 06/07/2000 Accounting Date 06/07/2000

Book Transaction Code

Quantity 1.0000 Salvage Value 0.00 USD

Cost 100,000.000 Base Cost 100,000.00 USD

Depreciation 10,000.00 USD YTD Depr 10000.000 USD

Transaction Proceeds 0.000 Transaction Removal Cost 0.000

This example illustrates the fields and controls on the Review Page (2 of 2). You can find definitions for the fields and controls later on this page.

Distribution Personalize | Find | 1 of 1 Last

Chartfields Cost Acquisition Details Document Details [PDF]

Operating Unit	Fund Code	Department	Program Code	Class Field	Budget Reference	Product	PC Business Unit	Project	Activity	Source Type	Resource Category	Resource Sub Category	Analysis Type
		10500											

Custodian Information

Employee ID Custodian

Asset Location

Location Area ID

Manufacturer Information

Manufacturer ID Manufacturer

Model Product Version

If the Load Type has changed because of an Asset Id change, a Warning icon will appear next to the Load Type to let the user know the actions they performed caused a change in the Load Type.

Note: The fields will be available for editing based on the interface type, load status and User Preferences.

Field or Control	Description
Load Status	<p>Displays the load status associated with the Interface ID. The load status can be the following values:</p> <ul style="list-style-type: none"> • <i>Consolidated</i>: Transactions consolidated. • <i>Errored</i>: Transaction errors. Click the Errors link next to the load status to view all the error messages associated with the transaction. • <i>Excluded</i>: Transactions excluded. • <i>In Process</i>: Transactions in process. • <i>Loaded</i>: Transactions loaded. • <i>On Hold</i>: Transactions on hold. • <i>PO Grp Incomplete</i> • <i>Pending</i>: Transactions pending. • <i>Replaced</i>: Transactions replaced by other interface records. • <i>Unitized</i>: Transactions unitized (will not be loaded).
Auto Approval Status	Select the check box for the Transaction Loader (AMIF1000) to process the transaction.
Review Physical Attributes	Click this link to review the physical attributes. Review Physical Attributes link is available only if the transaction has Physical B information.

Load types include the following (changes marked with an asterisk are uncommon):

Load Type	Name	Financial or Physical Tables
<i>AAD</i>	Additional Cost Add	Financial
<i>ACQ</i>	Insert Acquisition Detail	Physical *
<i>ADD</i>	Asset Add	Financial
<i>ADJ</i>	Asset Cost Adjustment	Financial
<i>ADP</i>	Revaluation Write-off	Financial
<i>ADQ</i>	Adjust Cost & Acquisition Detail	Financial and physical *

Load Type	Name	Financial or Physical Tables
<i>ARA</i>	Add Retired Asset	Financial and physical
<i>ASD</i>	Asset Deletion	Financial and physical
<i>AUP</i>	Asset Information Update	Physical
<i>BKD</i>	Book Deletion	Financial *
<i>BKS</i>	Book Change	Financial
<i>BSD</i>	Selective Book Delete	Financial *
<i>CAP</i>	Asset Capitalization	Financial
<i>CLC</i>	Custodian/Location Change	Physical *
<i>CIC</i>	Capitalize into Composite	Financial
<i>CN1</i>	Conversion of First Book	Financial and physical
<i>CN2</i>	Conversion of Subsequent Books	Financial
<i>CLS</i>	Closed Voucher	Financial
<i>FAD</i>	Financial and Physical Add	Financial
<i>IHI</i>	Physical Inventory History Insert	Physical
<i>IUI</i>	InterUnit Transfer, In Side	Financial and physical
<i>IUO</i>	InterUnit Transfer, Out Side	Financial
<i>LAD</i>	Leased Asset Add	Financial and physical *
<i>NAD</i>	Non-Financial Add	Physical
<i>OPT</i>	Open Transaction Generator	NA *
<i>PHY</i>	Physical Asset Change	Physical

Load Type	Name	Financial or Physical Tables
<i>PRT</i>	Partial Retirement	Financial
<i>RCT</i>	Asset Recategorization	Financial
<i>REI</i>	Asset Reinstatement	Financial
<i>REL</i>	Operating Lease Retire	Physical
<i>REN</i>	Non Capital Retire	Physical
<i>RET</i>	Asset Retirement	Financial
<i>RNA</i>	Retired Non-Financial Asset	Physical
<i>RAQ</i>	Replace Acquisition Detail	Physical
<i>BSD</i>	Selective Book Delete	Financial
<i>TRF</i>	IntraUnit Transfer	Financial
<i>TRO</i>	Operating Lease Transfer	Physical
<i>TRN</i>	Non Capital Transfer	Physical

Approving Changes

You can approve multiple interface transaction rows and also change the Approval and Load status for multiple rows at once.

This topic discusses how to approve financial and physical loader data.

Pages Used to Approve Changes

Page Name	Definition Name	Usage
<u>Approve Page</u>	AM_INTFC_TXN_APPR	View and approve interface transaction data.

Approve Page

Use the Approve page (AM_INTFC_TXN_APPR) to view and approve interface transaction data.

Navigation:

Asset Management > Send/Receive Information > Interface Transactions > Approve Interface Transactions

This example illustrates the fields and controls on the Approve Page. You can find definitions for the fields and controls later on this page.

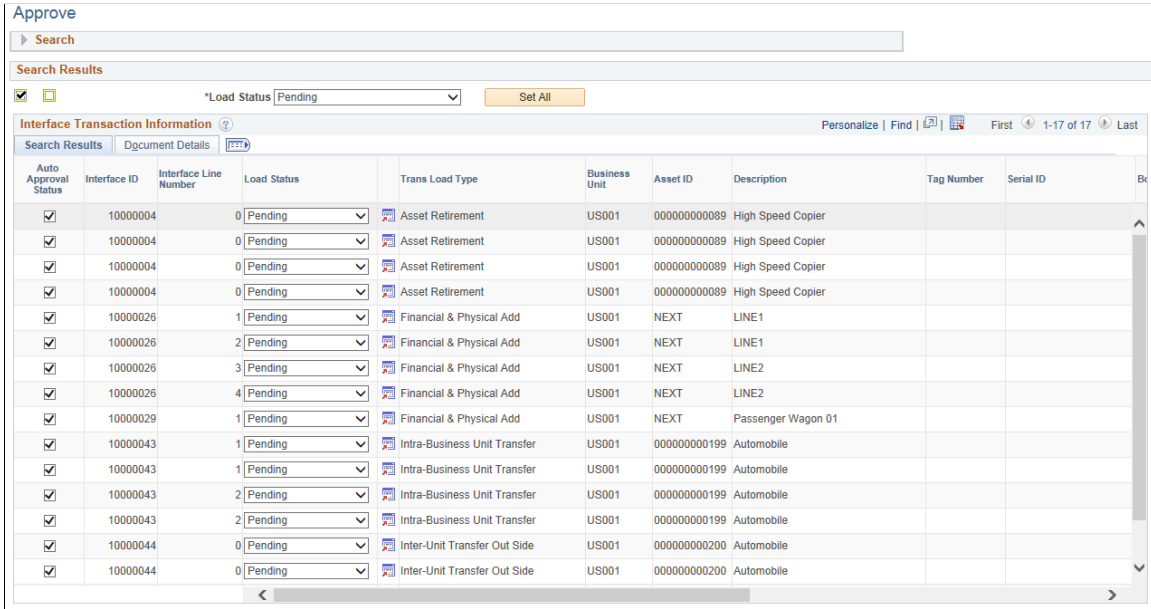

To set up search configuration, see “Setting Up Common Search Configuration” (PeopleSoft IT Asset Management)

When a search is performed to approve transaction, if any rows are returned, the Search group box is collapsed and the Search Results are displayed.

Field or Control	Description
Load Status	Select the desired status in the Search Results group box and click Set All button to change the load status for all the rows.
Auto Approval Status	Approve or reject each transaction by selecting or deselecting the Auto Approval Status check boxes. You can also use the Select All/ Deselect All check boxes to select/ clear all the rows.

You can also click the drill down icon for each row to open a new window displaying that transaction in the Review Transaction component.

Exporting PeopleSoft Assets into Oracle Internet of Things Asset Monitoring Cloud Service

Page Used to Export PeopleSoft Assets into Oracle Internet of Things Asset Monitoring Cloud Service

Page Name	Definition Name	Usage
Upload Assets to IoT (Oracle Internet of Things) Page	IOT_ASSET_BULK	Export PeopleSoft assets into Oracle Internet of Things Asset Monitoring Cloud Service.
Errored Asset Details Page	IOT_ERROR_PAGE	Review a list of PeopleSoft assets that did not properly export to IoT during the Create IOT Asset process.

Upload Assets to IoT (Oracle Internet of Things) Page

Use the Upload Assets to IoT page (IOT_ASSET_BULK) to export assets from the Asset Management Repository to Oracle Internet of Things Asset Monitoring Cloud Service. This page saves you time and effort by enabling you to mass export assets chosen for integration into Oracle IoT (in lieu of manual entry).

Navigation:

Asset Management > Service and Maintenance > Upload Assets to IoT > Upload Assets to IoT

This example illustrates the fields and controls on the Upload Assets to IoT page.

The screenshot displays the 'Upload Assets to IoT' page interface. It is divided into several sections:

- Asset Search Criteria:** Contains search fields for Business Unit (US001), Asset Category, Asset Profile ID, From Asset ID, To Asset ID, Asset Status, Asset Type, Asset Subtype, Description, Location Code, and Area ID. It includes 'Retrieve' and 'New Search' buttons, along with links for 'Process Monitor' and 'Error Page'.
- IoT Defaults:** Features a 'Create IoT Asset' button, fields for Organization, Place Name, and Asset Type, and a 'Set All' button.
- Search Results:** A table listing search results with columns for 'Create IoT Asset', 'IoT Asset Name', 'IoT Organization', 'IoT Place Name', 'IoT Asset Type', and 'Description'. The results show seven entries with names like PSUS001ZONE111 through PSUS001ZONE105. A 'Create IoT Asset' button is located at the bottom of the results section.

Asset Search Criteria

Use the Asset Search Criteria group box to enter search criteria for your PeopleSoft assets. Fields such as **Business Unit**, **Asset Profile ID**, and **Asset Type** help you narrow your asset search results.

<i>Field or Control</i>	<i>Description</i>
Retrieve	Click the Retrieve button to retrieve PeopleSoft assets that are not in IoT and meet your search criteria. When you click the Retrieve button, the IoT Defaults and Search Results group boxes appear.
Process Monitor	Click to access the Process Monitor page and monitor the Create IOT Asset process. Refer to this page <i>after</i> running the Create IoT process (the Create IoT Asset button).
Error Page	Click to access the Errored Asset Details page and review a list of PeopleSoft assets that did not properly export to IoT during the Create IOT Asset process. Refer to this page <i>after</i> running the Create IoT process (the Create IoT Asset button).

IoT Defaults

<i>Field or Control</i>	<i>Description</i>
Create IoT Asset	Click the Create IoT Asset button to run the <i>AM_IOT_BULK</i> process that exports PeopleSoft assets into Oracle Internet of Things Asset Monitoring Cloud Service. Note: Before running this process, you must select at least one asset from the search results (by selecting the Create IoT Asset option) and assign the asset an IoT Organization, Place Name, and Asset Type.

Field or Control	Description
Organization, Place Name, and Asset Type	<p>For each PeopleSoft asset you export into Oracle Internet of Things Asset Monitoring Cloud Service, you must assign IoT organization, place name, asset type, asset name, and description attributes.</p> <p>Use the Organization, Place Name, and Asset Type fields in this group box to apply the selected attribute to all assets in the search results.</p> <p>For example, if you select ‘<i>United States</i>’ for the Organization field and click the Set All button, the system applies the United States value to the organization field for all assets in the search results.</p> <p>Since organization, place name, and asset type attributes can be the same across several or all assets, these fields act as a time-saver by mass populating your asset attributes.</p>
Set All	<p>Click the Set All button to apply Organization, Place Name, or Asset Type attributes to all corresponding fields in the search results.</p> <p>For example, if you select ‘<i>United States</i>’ for the Organization field and click the Set All button, the system applies the United States value to the organization field for all assets in the search results.</p>

Search Results

Field or Control	Description
Create IoT Asset	<p>Use this option to select the individual PeopleSoft assets you want to export into Oracle Internet of Things Asset Monitoring Cloud Service.</p> <p>After selecting the PeopleSoft assets you want to export, you must still click the Create IoT Asset button to run the <i>AM_IOT_BULK</i> process that exports the assets.</p>
IoT Asset Name	Enter an IoT asset name for the PeopleSoft asset.

Field or Control	Description
IoT Organization, IoT Place Name, and IoT Asset Type	Enter an IoT organization, place name, and asset type for the PeopleSoft asset. You can also mass populate these values using the Organization, Place Name, and Asset Type fields in the IoT Default group box.
Description	Enter an IoT description for the PeopleSoft asset.

See also:

“Understanding the Integration with Oracle Internet of Things Asset Monitoring Cloud Service” (Asset Lifecycle Management Fundamentals)

[General Information Page](#)

Errored Asset Details Page

Use the Errored Asset Details page (IOT_ERROR_PAGE) to review a list of PeopleSoft assets that did not properly export to IoT during the Create IOT Asset process.

Navigation:

Asset Management > Service and Maintenance > Upload Assets to IoT > Upload Assets to IoT > Click the Error Page link.

This example illustrates the fields and controls on the Errored Asset Details page.

✕
Help
Errored Asset Details
Asset Details
☰ 🔍 ⏪ ⏩ 1-3 of 3 ▶ ▶▶ | View All

	Business Unit	Asset Identification	Date Time Value			
1	US001	000000000128	09/06/19 23:31			
2	US001	000000000128	09/06/19 23:31			
3	US001	000000000128	09/06/19 23:39			

OK Cancel
⋮

Using Asset Management WorkCenter and Dashboard

Understanding the Asset Management WorkCenter and Dashboard

The Asset Management WorkCenter is a central navigational component that is designed for the end user. The goal of the WorkCenter is to help an end user become more efficient by accessing frequently used pages and pagelets, and keep multiple windows open while performing daily tasks.

Click to watch a short video about the [PeopleSoft Asset Management WorkCenter](#).

The Asset Management WorkCenter is delivered with sample data. It is the responsibility of the system administrator from your organization, to design and create links so that users can view and access specific links, pages, and pagelets.

For information about setting up PeopleTools options for the WorkCenter, see *PeopleTools: Global Technology*

Related Links

- “Understanding WorkCenters and Dashboards” (Enterprise Components)
- “PeopleSoft Classic WorkCenters” (Application Fundamentals)
- “Example: WorkCenter page (Classic)” (Application Fundamentals)
- “Common Terms Used with the PeopleSoft Classic WorkCenter” (Application Fundamentals)
- “Pagelets and Pagelet Setup, Maintenance, and Personalization” (Application Fundamentals)
- “Dashboards and Pivot Grids” (Application Fundamentals)

Asset Management WorkCenter

Use the Asset Management WorkCenter Home page (AM_WORKCENTER) to manage Asset Management activities in one location.

This example illustrates the fields and controls on the Example of an Asset Management WorkCenter home page.

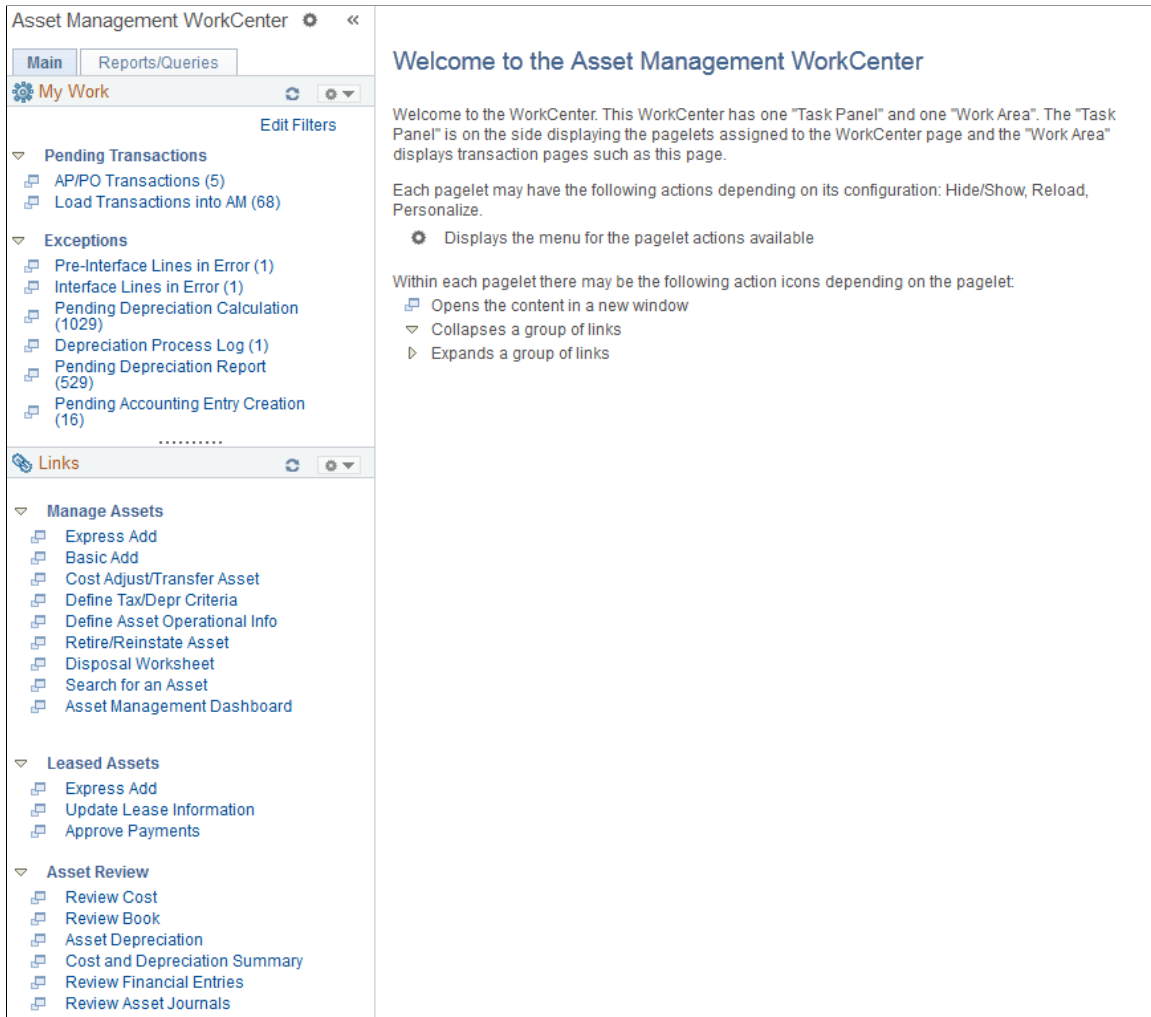

The WorkCenter navigation is located on the left side of the page and can include these primary tabs and sections:

- Main tab:
 - My Work
 - Links
- Reports/Queries tab
 - Queries
 - Reports and Processes

Some WorkCenter pagelets are common to multiple applications, and some pagelets are unique to individual applications.

For more information about the Asset Management WorkCenter, see

PeopleSoft Asset Management WorkCenter

For more information about the links that appear on the My Work pagelet, see [Using the Asset Management WorkCenter - My Work Pagelet](#)

For more information about the links that appear on the My Work pagelet, see [Using the Asset Management WorkCenter - Links Pagelet](#)

For more information about the links that appear on the My Work pagelet, see [Using the Asset Management WorkCenter – Queries Pagelet](#)

For more information about the links that appear on the My Work pagelet, see [Using the Asset Management WorkCenter - Reports and Processes Pagelet](#)

For more information about the links that appear on the My Work pagelet, see [Using the Asset Management WorkCenter - Dashboard](#)

Related Links

“Configuring Pagelets” (Enterprise Components)

“Configuring Filter Definitions and Values” (Enterprise Components)

Using the Asset Management WorkCenter - My Work Pagelet

Use the My Work pagelet within the Asset Management WorkCenter (AM_WORKCENTER) to view and edit your most commonly-used components and be alerted to those items that require your attention.

The My Work pagelet provides links that consolidate a user’s actionable tasks, using the user ID as the Assigned User ID to show only items in their own queue.

The My Work pagelet includes these functional groupings for links:

- Pending Transactions
- Exceptions

This example illustrates the fields and controls on the Example of an Asset Management WorkCenter — My Work pagelet.

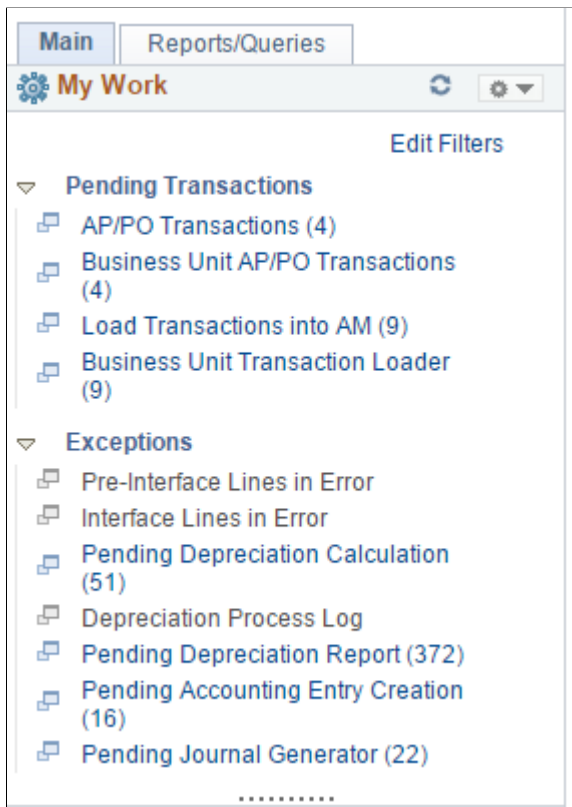

Pending Transactions

The Pending Transactions group level displays asset transactions with a processing status of pending and includes these links to transaction areas:

- AP/PO Transactions
- Business Unit AP/PO Transactions
- Load Transaction to AM
- Business Unit Transaction Loader

Page Name	Definition	Usage
<u>AP/PO Transactions Page</u>	AM_WC_PREAM_PEND	Review and act upon pending AP or PO transactions.
<u>Business Unit AP/PO Transactions Page</u>	AM_WC_PREAM_PENDBU	Review and act on pending AP or PO transaction data.
<u>Load Transactions into AM</u>	AM_WC_INTFC	Review and run load pending transactions into AM.

Page Name	Definition	Usage
Business Unit Transaction Loader Page	AM_WC_INTFC_BU	Review interface transactions and load them into Asset Management tables.

AP/PO Transactions Page

Use the AP/PO Transactions page (AM_WC_PREAM_PEND) to review and act upon AP or PO Transactions assigned to the user.

Navigation:

Asset Management > Asset Management WorkCenter > My Work pagelet

Click the **Pending Transactions: AP/PO Transactions** link.

This example illustrates the fields and controls on the AP/PO Transactions Page – Interface Details Tab

Pre-Interface ID	Pre-Interface Line Number	AM Business Unit	System Source	Asset ID	Asset Profile ID	Transaction Date	Acc
3	2	US001	PO Online Entry Panel	NEXT	LEASED EQT	10/31/2003	10/3
3	3	US002	PO Online Entry Panel	NEXT	AUTO	10/31/2003	10/3
3	4	US002	PO Online Entry Panel	NEXT	COMPUTERS	10/31/2003	10/3
4	1	US001	PO Online Entry Panel	NEXT	COMPUTERS	10/31/2003	10/3
4	2	US001	PO Online Entry Panel	NEXT	FURNITURE	10/31/2003	10/3

This example illustrates the fields and controls on the AP/PO Transactions Page – Document Details Tab

Pre-Interface ID	Pre-Interface Line Number	AM Business Unit	PO Business Unit	PO Number	Receiving Business Unit	Receipt Number	AP Business Unit	Voucher ID
3	2	US001	US001	POAM1	US001	RPOAM1A		
3	3	US002	US001	POAM1	US001	RPOAM1A		
3	4	US002	US001	POAM1	US001	RPOAM1A		
4	1	US001	US001	POAM1	US001	RPOAM1B		
4	2	US001	US001	POAM1	US001	RPOAM1B		

Field or Control	Description
Pre-Interface ID	Click the Pre-Interface ID link to open the Load Preview Pre-AM page.

Field or Control	Description
Pre-Interface Line Number	Click the Pre-Interface ID link to open the Load Preview Pre-AM page.
PO Number	Click the PO Number link to open the Purchase Order Inquiry page.
Receipt Number	Click the Receipt Number link to open the Receiver Line page.
Voucher ID	Click the Voucher ID page to open Voucher Inquiry page.
Actions	<p>Perform an action on one or more items that you select in the AP/ PO Transactions grid, and click the GO button. Choose from these actions:</p> <ul style="list-style-type: none"> • Retrieve Info From AP/PO • Load Into AM
Retrieve Info From AP/PO	Select the Retrieve Info from AP/PO action to run the Pre-Interface Loader process and load data from Payables or Purchasing to Asset Management interface tables.
Load Into AM	Select the Load Into AM action to run Pre-Interface and Transaction Loader processes and populate Asset Management tables with data.

Business Unit AP/PO Transactions Page

Use the Business Unit AP/PO Transactions page (AM_WC_PREAM_PENDBU) to review and act on pending AP or PO transaction data. Transaction data is organized by business unit. This page shares similar functionality with the AP/PO Transactions page and you can use either page to review and act on pending AP or PO transaction data.

Navigation:

Asset Management > Asset Management WorkCenter > My Work pagelet > Click the Pending Transactions: Business Unit AP/PO Transactions link

This example illustrates the fields and controls on the Business Unit AP/PO Transactions page. You can find definitions for the fields and controls later on this page.

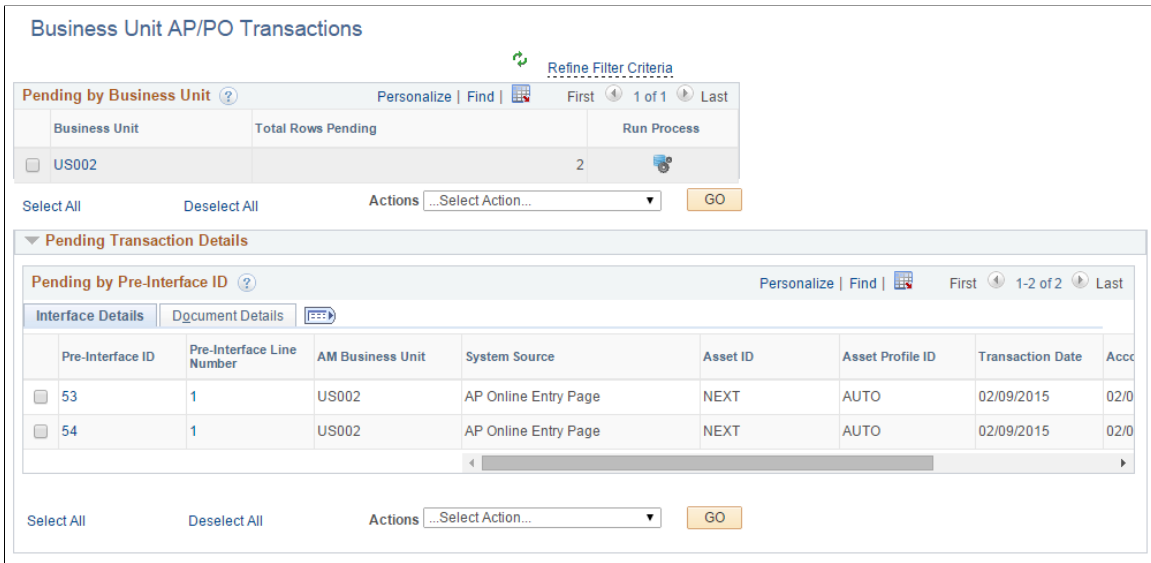

This example illustrates the fields and controls on the Business Unit AP/PO Transactions page. You can find definitions for the fields and controls later on this page.

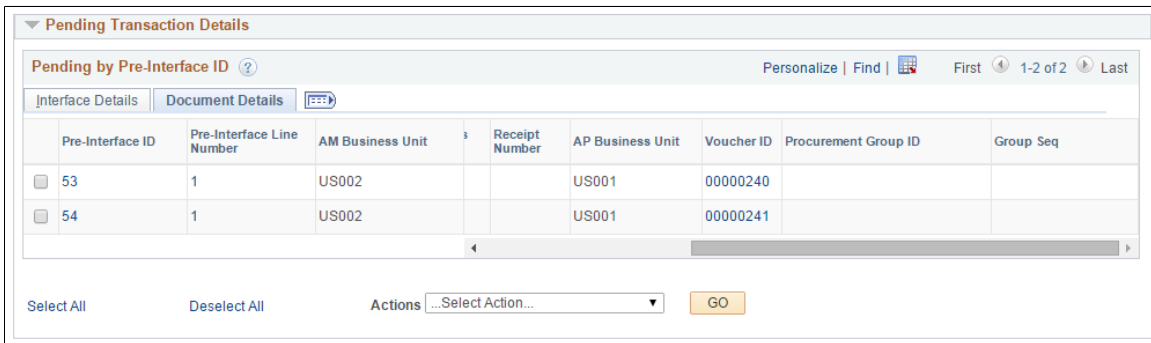

Field or Control	Description
Business Unit	<p>Displays business units that have pending pre-interface transactions.</p> <p>Select a business unit to:</p> <ul style="list-style-type: none"> Perform an action against it (Retrieve Info from AP/PO, Load Into AM). Run the Payables/Purchasing Interface process (AMPS1000) against it. <p>Click a business unit link to display related pre-interface transaction details in the Pending Transaction Details group box.</p>
Total Rows Pending	Displays the total number of pending rows for a business unit.

Field or Control	Description
Run Process	<p>Click the icon to run the Payables/Purchasing Interface process (AMPS1000) for the corresponding business unit in the row.</p> <p>The AMPS1000 process loads data from Payables or Purchasing to Asset Management interface tables (INTFC_FIN, INTFC_PHY_A and INTFC_PHY_B).</p>
Actions	<p>Perform an action on one or more items that you select on the page, and click the GO button. Choose from these actions:</p> <ul style="list-style-type: none"> • <i>Retrieve Info from AP/PO</i>: Select this action to run the Payables/Purchasing Interface process (AMPS1000) for selected business units or pre-interface IDs. The AMPS1000 process loads data from Payables or Purchasing to Asset Management interface tables (INTFC_FIN, INTFC_PHY_A and INTFC_PHY_B). • <i>Load Into AM</i>: Select this action to run the Payables/Purchasing Interface process (AMPS1000) for selected business units or pre-interface IDs and, once complete, automatically initiate the Transaction Loader process (AMIF1000), which transfers the data from the interface tables into your Asset Management tables.
Go	Click to perform an action.

Pending Transaction Details

Field or Control	Description
Pre-Interface ID	<p>Displays the pre-interface IDs associated with a selected business unit.</p> <p>Select a pre-interface ID to perform an action against it (retrieve Info from AP/PO or Load Into AM). When you select a pre-interface ID, all related rows with the same ID are automatically selected as well. Once you process a pre-interface ID, you will not be able to select it again for future processing.</p> <p>Click the Pre-Interface ID link to open the Load Preview Pre-AM page.</p>
Pre-Interface Line Number	<p>Displays the line number associated with a pre-interface ID.</p> <p>Click the Pre-Interface Line Number link to open the Load Preview Pre-AM page.</p>

Field or Control	Description
AM Business Unit	Displays the business unit associated with the pre-interface ID.
System Source	Identifies the source of an accounting entry from which a transaction arises.
Asset ID	Displays the asset ID associated with the pre-interface ID.
Asset Profile ID	Displays the asset profile ID associated with the pre-interface ID.
Transaction Date	Displays the transaction date associated with the pre-interface ID.
Accounting Date	Displays accounting date associated with the pre-interface ID.
Load Status	Displays the load status associated with the pre-interface ID.
PO Business Unit	Displays the PO business unit associated with the pre-interface ID.
PO Number	Displays the PO number associated with the pre-interface ID. Click the PO Number link to open the Purchase Order Inquiry page.
Receiving Business Unit	Displays the receiving business unit associated with the pre-interface ID.
Receipt Number	Displays the receipt number associated with the pre-interface ID. Click the Receipt Number link to open the Receiver Line page.
AP Business Unit	Displays the AP business unit associated with the pre-interface ID.
Voucher ID	Displays the voucher ID associated with the pre-interface ID. Click the Voucher ID page to open the Voucher Inquiry page.

Field or Control	Description
Procurement Group ID	Displays the procurement group ID associated with the pre-interface ID.
Group Seq (Group Sequence)	Displays the group sequence number associated with the pre-interface ID.

Load Transactions into AM

Use the Load Transaction to AM page (AM_WC_INTFC) to review and run load transactions into AM assigned to the user.

Navigation:

Asset Management > Asset Management WorkCenter > My Work pagelet

Click the **Pending Transactions: Load Transaction into AM** link.

This example illustrates the fields and controls on the Load Transactions into AM Page.

Load Transactions into AM [Refine Filter Criteria](#)

Load Transactions into AM Personalize | Find | First 1-12 of 12 Last

Action	Interface ID	Business Unit	System Source	Load Type	Load Description	Load Status	Total Rows Pending
<input type="checkbox"/> Action	10000004	US001	AM Batch	RET	Asset Retirement	Pending	4
<input type="checkbox"/> Action	10000005	US006	AM Batch	REL	Operating Lease Retire	Pending	2
<input type="checkbox"/> Action	10000005	US006	AM Batch	RET	Asset Retirement	Pending	2
<input type="checkbox"/> Action	10000005	US006	AM Batch	AUP	Asset Information Update	Pending	9
<input type="checkbox"/> Action	10000005	US006	AM Batch	IHI	Inventory History Insert	Pending	21
<input type="checkbox"/> Action	10000005	US006	AM Batch	NAD	Non-Financial Add	Pending	7
<input type="checkbox"/> Action	10000005	US006	AM Batch	PHY	Physical Asset Change	Pending	4
<input type="checkbox"/> Action	10000005	US006	AM Batch	TRN	Non Capital Transfer	Pending	8
<input type="checkbox"/> Action	10000005	US006	AM Batch	TRO	Operating Lease Transfer	Pending	1
<input type="checkbox"/> Action	10000005	US006	AM Batch	TRF	Intra-Business Unit Transfer	Pending	8
<input type="checkbox"/> Action	90000001	US001	Conversion	CN1	Conversion of First Book	Pending	1
<input type="checkbox"/> Action	90000002	US001	Conversion	CN1	Conversion of First Book	Pending	1

Select All Deselect All Load Transactions Into AM

Field or Control	Description
Action	Click the action link associated with an item to open the Review Financial or Review Physical A pages. You must perform each action individually in the Action column by drilling into the action from this list
Load Transactions Into AM	Select one or more Interface IDs and click the Load Transactions Into AM button to run the application engine and load transactions into AM.

Business Unit Transaction Loader Page

Use the Business Unit Transaction Loader page (AM AM_WC_INTFC_BU) to review interface transactions and load them into Asset Management tables. Transaction data is organized by business unit. This page shares similar functionality with the Load Transaction to AM page and you can use either page to review interface transactions and load them into Asset Management tables.

Navigation:

Asset Management > Asset Management WorkCenter > My Work pagelet > Click the Pending Transactions: Business Unit Transaction Loader link

This example illustrates the fields and controls on the Business Unit Transaction Loader page. You can find definitions for the fields and controls later on this page.

Business Unit Transaction Loader

Refine Filter Criteria

Personalize | Find | First 1-6 of 6 Last

Business Unit	Total Rows Pending	Run Process
<input type="checkbox"/> ARO01	53	
<input type="checkbox"/> FRA01	59	
<input type="checkbox"/> US001	238	
<input type="checkbox"/> US002	12	
<input type="checkbox"/> US004	3	
<input type="checkbox"/> US006	62	

Select All Deselect All [Load Transactions into AM](#)

This example illustrates the fields and controls on the Business Unit Transaction Loader page. You can find definitions for the fields and controls later on this page.

Pending Transaction Details

Personalize | Find | First 1-37 of 37 Last

Action	Interface ID	Business Unit	System Source	Load Type	Load Description	Load Status	Total Rows Pending
<input type="checkbox"/> Action	202	US001	AM Batch	ADJ	Asset Cost Adjustment	Pending	1
<input type="checkbox"/> Action	701	US001	AM Batch	IUO	Inter-Unit Transfer Out Side	Pending	1
<input type="checkbox"/> Action	801	US001	AM Online Entry Page	FAD	Financial & Physical Add	Pending	9
<input type="checkbox"/> Action	10000004	US001	AM Batch	RET	Asset Retirement	Pending	
<input type="checkbox"/> Action	10000018	US001	AP Online Entry Page	FAD	Financial & Physical Add	Pending	
<input type="checkbox"/> Action	10000032	US001	PO Online Entry Panel	NAD	Non-Financial Add	Pending	
<input type="checkbox"/> Action	10000034	US001	AP Online Entry Page	FAD	Financial & Physical Add	Pending	
<input type="checkbox"/> Action	10000047	US001	AM Batch	RET	Asset Retirement	Pending	
<input type="checkbox"/> Action	10000049	US001	AM Batch	RET	Asset Retirement	Pending	
<input type="checkbox"/> Action	10000053	US001	AM Batch	RET	Asset Retirement	Pending	
<input type="checkbox"/> Action	10000054	US001	AM Batch	RET	Asset Retirement	Pending	
<input type="checkbox"/> Action	10000085	US001	AM Online Entry Page	FAD	Financial & Physical Add	Pending	1
<input type="checkbox"/> Action	10000112	US001	AM Batch	RET	Asset Retirement	Pending	
<input type="checkbox"/> Action	10000135	US001	AM Online Entry Page	FAD	Financial & Physical Add	Pending	
<input type="checkbox"/> Action	10000151	US001	AM Batch	BKS	Book Change	Pending	

Select All Deselect All [Load Transactions into AM](#)

Field or Control	Description
Business Unit	<p>Displays business units that have pending interface transactions.</p> <p>Select a business unit to run the Transaction Loader process (AMIF1000) against it, which will transfer the data from the interface tables into your Asset Management tables.</p> <p>Click a Business Unit link to display related interface transaction details in the Pending Transaction Details group box.</p>
Total Rows Pending	Displays the total number of pending rows for a business unit.
Run Process	<p>Click the icon to run the Transaction Loader process (AMIF1000) for the corresponding business unit in the row.</p> <p>The AMIF1000 process transfers data from the interface tables into your Asset Management tables.</p>
Load Transactions in AM	Click to run the Transaction Loader process (AMIF1000) for one or more business units or interface IDs that you select on the page.

Pending Transaction Details

Field or Control	Description
Selection check box	<p>Select interface IDs that you want to process using the Load Transactions in AM button (which runs the Transaction Loader process, AMIF1000).</p> <p>The system will automatically select corresponding Interface IDs that share the same value.</p> <p>Once you run this process for an interface ID, you will not be able to select it again for future processing.</p>
Action	<p>Click the action link associated with an interface ID to open the Review Financial or Review Physical A pages.</p> <p>You must perform each action individually in the Action column by drilling into the action from this list.</p>
Interface ID	Displays the interface IDs associated with a selected business unit.
Business Unit	Displays the business unit associated with the interface ID.

Field or Control	Description
System Source	Identifies the source of an accounting entry from which a transaction arises.
Load Type	Displays the load type associated with the business unit and interface ID.
Load Description	Displays the load description associated with the business unit and interface ID.
Load Status	Displays the load status associated with the business unit and interface ID.
Total Rows Pending	Displays the total number of rows pending associated with the business unit, interface ID, and load type.

Exceptions

The Exceptions group level includes these links to transaction areas:

- [Pre-Interface Lines in Error](#)
- [Interface Lines in Error](#)
- [Pending Depreciation Calculation](#)
- [Depreciation Process Log](#)
- [Pending Depreciation Report](#)
- [Pending Accounting Entry Creation](#)
- [Pending Journal Generator](#)

Page Name	Definition Name	Usage
Pre-Interface Lines in Error	AM_WC_PREAM_ERR	Displays pre-interface lines in error and reset transactions to pending.
Interface Lines in Error	AM_WC_INTFC_ERR	Displays interface lines in error and reset transactions to pending.
Pending Depreciation Calculation	AM_WC_TRANSACTIONS	Displays and runs depreciation calculations on one or more business units or assets.

Page Name	Definition Name	Usage
<u>Depreciation Process Log</u>	AM_WC_ERR_LOG	Displays depreciation rows in error and select to remove from log.
<u>Pending Depreciation Report</u>	AM_WC_DPRRPT_TRANS	Displays business unit and asset depreciation information pending upload to the asset depreciation reporting table.
<u>Pending Accounting Entry Creation</u>	AM_WC_AE_TRANS	Displays and creates pending accounting entries for one or more business units and asset IDs.
<u>Pending Journal Generator Page</u>	AM_WC_JGEN_TRANS	Review pending Journal Generator transactions and run Journal Generator process for selected assets.

Pre-Interface Lines in Error

Use the Pre-Interface Lines in Error page (AM_WC_PREAM_ERR) to display pre-interface lines in error and reset transactions to pending.

Navigation:

Asset Management > Asset Management WorkCenter > My Work pagelet

Click the **Exceptions: Pre-Interface Lines in Error** link.

Field or Control	Description
Pre-Interface ID	Click the Pre-Interface ID link to open the Load Preview Pre-AM page.
Pre-Interface Line Number	Click the Pre-Interface ID link to open the Load Preview Pre-AM page.
PO Number	Click the PO Number link to open the Purchase Order Inquiry page.
Receipt Number	Click the Receipt Number link to open the Receiver Line page.
Voucher ID	Click the Voucher ID page to open Voucher Inquiry page.
Reset Transaction to Pending	Select one or more Interface IDs and click the Reset Transaction to Pending button to set the selected rows in error to pending.

Interface Lines in Error

Use the Interface Lines in Error page (AM_WC_INTFC_ERR) to display interface lines in error and reset transactions to pending.

Navigation:

Asset Management > Asset Management WorkCenter > My Work pagelet

Click the **Exceptions: Interface Lines in Error** link.

This example illustrates the fields and controls on the Interface Lines in Error page.

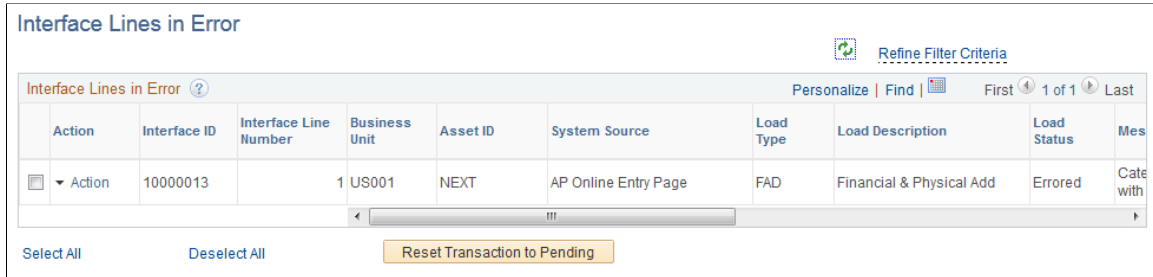

Field or Control	Description
Action	Click the action link associated with an item to open the Review Financial or Review Physical A pages. Each action in the Action column must be performed individually by drilling into the action from this list.
Reset Transaction to Pending	Select one or more Interface IDs and click the Reset Transaction to Pending button to set the selected rows in error to pending.

Pending Depreciation Calculation

Use the Pending Depreciation Calculation page (AM_WC_TRANSACTIONS) to display one or more business units or assets and run depreciation calculations.

Navigation:

Asset Management > Asset Management WorkCenter > My Work pagelet

Click the **Exceptions: Pending Depreciation Calculation** link.

This example illustrates the fields and controls on the Pending Depreciation Calculation Page.

Pending Depreciation Calculation

[Refresh](#) [Refine Filter Criteria](#)

Pending by Business Unit Personalize | Find | First 1-11 of 11 Last

Business Unit	Total Rows Pending	Run Process
<input type="checkbox"/> AUS01	5	
<input type="checkbox"/> BLG01	8	
<input type="checkbox"/> DEU01	4	
<input type="checkbox"/> FRA01	6	
<input type="checkbox"/> JPN01	12	
<input type="checkbox"/> NLDE1	6	
<input type="checkbox"/> US001	840	
<input type="checkbox"/> US003	4	
<input type="checkbox"/> US004	44	
<input type="checkbox"/> US005	44	

[Select All](#) [Deselect All](#) [Run Depreciation Calculation](#)

Pending Transaction Details

Pending by Asset ID Personalize | Find | View All | First 1-5 of 5 Last

Action	Business Unit	Asset ID	Book	Transaction Type	Transaction Date	Accounting Date
<input type="checkbox"/> Action	AUS01	000000000001	ASSETS_AUD	ADD	06/30/2000	06/30/2000
<input type="checkbox"/> Action	AUS01	000000000001	ASSETS_USD	ADD	06/30/2000	06/30/2000
<input type="checkbox"/> Action	AUS01	AM325	TAX_AUD	ADD	07/10/2000	07/10/2000
<input type="checkbox"/> Action	AUS01	AM326	TAX_AUD	ADD	08/08/2000	08/08/2000
<input type="checkbox"/> Action	AUS01	AM327	TAX_AUD	ADD	08/08/2000	08/08/2000

[Select All](#) [Deselect All](#) [Run Depreciation Calculation](#)

Field or Control	Description
Action	Click the action link associated with an item to open the Review Book or Review Cost or Open Transaction or Asset Depreciation pages. Each action in the Action column must be performed individually by drilling into the action from this list.
Business Unit	Click a Business Unit link to display transaction details for the selected business unit.
Run Process icon	Click the Run Process icon to run the depreciation calculation for the business unit associated with the row.
Run Depreciation Calculation (by Business Unit)	Select one or more business units in the Business Unit grid and click the Run Depreciation Calculation button to run depreciation calculations for selected business units.
Run Depreciation Calculation (by Asset ID)	Select one or more Asset IDs in the Transaction Details grid and the click the Run Depreciation Calculation to run depreciation calculation for selected Asset IDs.

Depreciation Process Log

Use the Depreciation Process Log page (AM_WC_ERR_LOG) to display depreciation rows in error and select to remove from log.

Navigation:

Asset Management > Asset Management WorkCenter > My Work pagelet

Click the **Exceptions: Depreciation Process Log** link.

This example illustrates the fields and controls on the Depreciation Process Log Page – Process Details Tab.

Process Name	Process Instance	Sequence Number	Date/Time Stamp	Message Description
AM_DEPR_CALC	17112	1	11/14/13 5:10:44PM	Date '1988-11-14' not found on Convention table 'MQ' for Calendar ID '01'. (8800,4)

This example illustrates the fields and controls on the Depreciation Process Log Page – Asset Details Tab.

Process Name	Process Instance	Sequence Number	Business Unit	Asset ID	Book	Transaction Type	Transaction Date
AM_DEPR_CALC	17112	1	US001	000000000144	CORP	ADD	11/14/1988

<i>Field or Control</i>	<i>Description</i>
Clear Log	Select one or more Process Instances and click the Clear Log button to remove selected logs from the log table.

Pending Depreciation Report

Use the Pending Depreciation Report page (AM_WC_DPRRPT_TRANS) to display and process pending business unit and asset depreciation report information.

Navigation:

Asset Management > Asset Management WorkCenter > My Work pagelet

Click the **Exceptions: Pending Depreciation Report** link.

This example illustrates the fields and controls on the Pending Depreciation Report Page.

Pending Depreciation Report

Refresh [Refine Filter Criteria](#)

Pending by Business Unit ?
Personalize | Find 📄
First ⏪ 1-15 of 15 ⏩ Last

Business Unit	Total Rows Pending	Run Process
<input type="checkbox"/> ARO01	17	
<input type="checkbox"/> AUS01	6	
<input type="checkbox"/> BLG01	78	
<input type="checkbox"/> CAN01	3	
<input type="checkbox"/> DEU01	9	
<input type="checkbox"/> FRA01	178	
<input type="checkbox"/> FRAE1	12	
<input type="checkbox"/> GBR01	47	
<input type="checkbox"/> ITLE1	6	
<input type="checkbox"/> NLD01	66	

Select All
Deselect All
Depr Reporting Table

▼ Pending Transaction Details

Pending by Asset ID ?
Personalize | Find | View All 📄
First ⏪ 1-6 of 6 ⏩ Last

Action	Business Unit	Asset ID	Book	Transaction Type	Transaction Date	Accounting Date
<input type="checkbox"/> Action	AUS01	AM325	ACCNT_AUD	ADD	07/10/2000	07/10/2000
<input type="checkbox"/> Action	AUS01	AM325	CORP_USD	ADD	07/10/2000	07/10/2000
<input type="checkbox"/> Action	AUS01	AM326	ACCNT_AUD	ADD	08/08/2000	08/08/2000
<input type="checkbox"/> Action	AUS01	AM326	CORP_USD	ADD	08/08/2000	08/08/2000
<input type="checkbox"/> Action	AUS01	AM327	ACCNT_AUD	ADD	08/08/2000	08/08/2000
<input type="checkbox"/> Action	AUS01	AM327	CORP_USD	ADD	08/08/2000	08/08/2000

Select All
Deselect All
Depr Reporting Table

Field or Control	Description
Action	Click the action link associated with an item to open the Review Book or Review Cost or Open Transaction or Asset Depreciation pages. Each action in the Action column must be performed individually by drilling into the action from this list.
Business Unit	Click a Business Unit link to display transaction details for the selected business unit.
Run Process icon	Click the Run Process icon to run the depreciation calculation for the business unit associated with the row.
Run Depr Reporting Table (by Business Unit)	Select one or more business units in the Business Unit grid and click the Depr Reporting Table button to run the load depreciation report for selected business units.
Run Depr Reporting Table (by Asset ID)	Select one or more Asset IDs in the Transaction Details grid and the click the Depr Reporting Table to run the load depreciation report for selected Asset IDs.

Pending Accounting Entry Creation

Use the Pending Accounting Entry Creation page (AM_WC_AE_TRANS) to display and create accounting entries for one or more business units and asset IDs.

Navigation:

Asset Management > Asset Management WorkCenter > My Work pagelet

Click the **Exceptions: Pending Accounting Entry Creation** link.

This example illustrates the fields and controls on the Pending Accounting Entry Creation Page.

The screenshot shows the 'Pending Accounting Entry Creation' page. At the top, there is a title bar with 'Pending Accounting Entry Creation' and a 'Refine Filter Criteria' link. Below this is a summary table 'Pending by Business Unit' with columns for Business Unit, Total Rows Pending, and Run Process. It lists GBR01 (6 rows), SPN01 (6 rows), US001 (2 rows), and US002 (2 rows). Below the table are 'Select All', 'Deselect All', and 'Create Accounting Entries' buttons. A section titled 'Pending Transaction Details' contains a table with columns: Action, Business Unit, Asset ID, Book, Transaction Type, Transaction Date, and Accounting Date. It lists six transactions for GBR01 with Asset IDs AM044 and AM046, all of type 'ADD' and dated 07/17/2000. At the bottom of this section are 'Select All', 'Deselect All', and 'Create Accounting Entries' buttons.

Field or Control	Description
Action	Click the action link associated with an item to open the Review Book or Review Cost or Open Transaction or Asset Depreciation pages. Each action in the Action column must be performed individually by drilling into the action from this list.
Business Unit	Click a Business Unit link to display transaction details for the selected business unit.
Run Process icon	Click the Run Process icon to run the depreciation calculation for the business unit associated with the row.
Create Accounting Entries (by Business Unit)	Select one or more business units in the Business Unit grid and click the Create Accounting Entries button to create accounting entries for selected business units.

Field or Control	Description
Create Accounting Entries (by Asset ID)	Select one or more Asset IDs in the Transaction Details grid and the click the Create Accounting Entries button to Create Accounting Entries for selected Asset IDs.

Pending Journal Generator Page

Use the Pending Journal Generator page (AM_WC_JGEN_TRANS) to review pending Journal Generator transactions and run the Journal Generator process for selected assets. Transaction data is organized by business unit.

Navigation:

Asset Management > Asset Management WorkCenter > My Work pagelet > Click the Exceptions: Pending Journal Generator link

This example illustrates the fields and controls on the Pending Journal Generator page. You can find definitions for the fields and controls later on this page.

The screenshot shows the 'Pending Journal Generator' interface. At the top, there is a title 'Pending Journal Generator' and a 'Refine Filter Criteria' link. Below the title is a navigation bar with 'Pending by Business Unit', 'Personalize', 'Find', and pagination controls showing 'First', '1-13 of 13', and 'Last'. The main content is a table with the following columns: Business Unit, Total Rows Pending, Accounting Definition Name, and Run Process. The table lists several business units, with US001 having the highest number of pending rows (854). At the bottom of the table, there are 'Select All', 'Deselect All', and 'Generate Journals' buttons.

Business Unit	Total Rows Pending	Accounting Definition Name	Run Process
<input type="checkbox"/> FRAE1	36		
<input type="checkbox"/> GBR01	59		
<input type="checkbox"/> IMP01	4	AMDEFN	
<input type="checkbox"/> IMP02	18		
<input type="checkbox"/> ITLE1	12		
<input type="checkbox"/> SPN01	18		
<input type="checkbox"/> SPN02	12		
<input type="checkbox"/> US001	854	AMDEFN	
<input type="checkbox"/> US002	23	AMDEFN	
<input type="checkbox"/> US003	18		

Select All Deselect All **Generate Journals**

This example illustrates the fields and controls on the Pending Journal Generator page. You can find definitions for the fields and controls later on this page.

▼ Pending Transaction Details

Pending by Asset ID Personalize | Find | View 100 | First 1-100 of 300 Last

	Action	Business Unit	Asset ID	Book	Transaction Type	Accounting Date
<input type="checkbox"/>	▼ Action	US001	00000000097	CORP	LPY	01/31/2004
<input type="checkbox"/>	▼ Action	US001	00000000097	CORP	LPY	01/31/2004
<input type="checkbox"/>	▼ Action	US001	00000000264	CORP	ADD	03/23/2015
<input type="checkbox"/>	▼ Action	US001	00000000264	CORP	ADD	03/23/2015
<input type="checkbox"/>	▼ Action	US001	00000000265	CORP	ADD	03/23/2015
<input type="checkbox"/>	▼ Action	US001	00000000265	CORP	ADD	03/23/2015
<input type="checkbox"/>	▼ Action	US001	EX_000000096	CORP	ADD	03/15/2000
<input type="checkbox"/>	▼ Action	US001	EX_000000096	CORP	ADD	03/15/2000
<input type="checkbox"/>	▼ Action	US001	EX_000000097	CORP	ADD	03/17/2000
<input type="checkbox"/>	▼ Action	US001	EX_000000097	CORP	ADD	03/17/2000
<input type="checkbox"/>	▼ Action	US001	EX_000000098	CORP	ADD	03/30/2000
<input type="checkbox"/>	▼ Action	US001	EX_000000098	CORP	ADD	03/30/2000
<input type="checkbox"/>	▼ Action	US001	EX_000000099	CORP	ADD	06/01/2000
<input type="checkbox"/>	▼ Action	US001	EX_000000099	CORP	ADD	06/01/2000
<input type="checkbox"/>	▼ Action	US001	EX_000000100	CORP	ADD	06/15/2000

Only the first 300 rows can be retrieved.

Select All Deselect All Accounting Definition Name Generate Journals

Field or Control	Description
Business Unit	<p>Displays business units that have pending journal generator transactions.</p> <p>Select a business unit to run the Journal Generator process (FS_JGEN) against it using the Generate Journals button. The FS_JGEN process creates GL journals from Asset Management accounting entries.</p> <p>Click a Business Unit link to display related transaction details in the Pending Transaction Details group box.</p>
Total Rows Pending	Displays the total number of pending rows for a business unit.
Accounting Definition Name	<p>Displays the accounting definition name associated with the business unit.</p> <p>You provided this value using the Accounting Definition Name field on the Interface Options page.</p> <p>See Asset Management Definition - Interface Options Page</p>

Field or Control	Description
Run Process	<p>Click the icon to run the Journal Generator process (FS_JGEN) for the corresponding business unit in the row.</p> <p>The FS_JGEN process creates GL journals from Asset Management accounting entries.</p>
Generate Journals	Click to run the Journal Generator process (FS_JGEN) for one or more business units or asset IDs that you select on the page.

Pending Transaction Details

Field or Control	Description
Selection (check box)	<p>Select asset IDs that you want to process using the Generate Journals button (runs the Journal Generator process, FS_JGEN).</p> <p>The system will automatically select corresponding Asset IDs that share the same value.</p> <p>Once you run this process for an asset ID, you will not be able to select it again for future processing.</p>
Action	<p>Click the action link associated with an asset ID to open the following pages:</p> <ul style="list-style-type: none"> • Review Financial Entries • Review Operating Leases • Review Cost • Asset Depreciation <p>You must perform each action individually in the Action column by drilling into the action from this list.</p>
Business Unit	Displays the business unit associated with the asset ID
Asset ID	Displays the asset ID associated with a selected business unit.
Book	Displays the book associated with a selected business unit and asset ID.
Transaction Type	Displays the transaction type associated with a selected business unit and asset ID.

Field or Control	Description
Accounting Date	Displays the accounting date associated with a selected business unit and asset ID.
Accounting Definition Name	<p>Enter a value for the accounting definition name.</p> <p>This field identifies which accounting entry definition the system should use when it creates the journal header and lines.</p> <hr/> <p>Note: You cannot run the Journal Generator process (FS_JGEN) without a value for this field.</p> <hr/>

Using the Asset Management WorkCenter - Links Pagelet

Use the Asset Management WorkCenter - Links pagelet to view the Asset Management links. The primary purpose of this pagelet is to minimize the number of clicks to access critical path components and pages. Click any of the links on the pagelet to display the destination page in the transaction area.

The Links pagelet can provide access to internal links and external links.

This example illustrates how the Links pagelet in Asset Management WorkCenter can be set up:

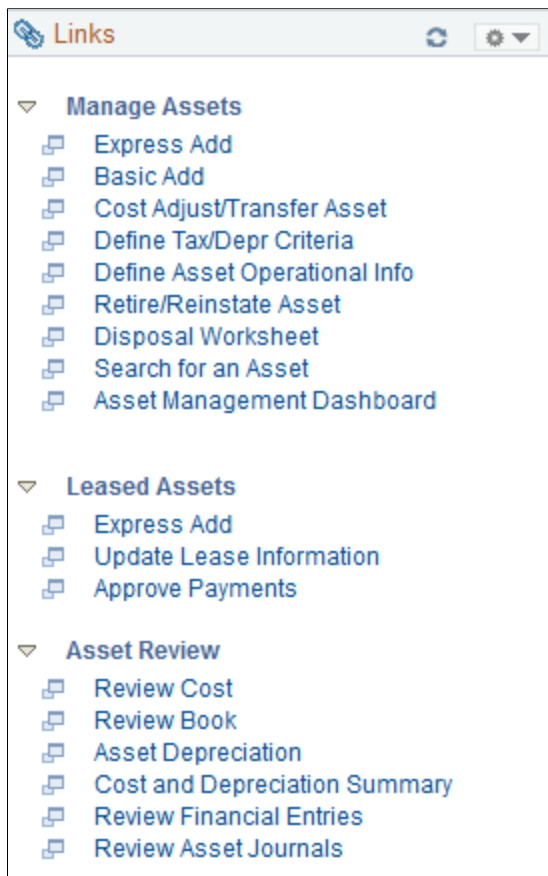

The Links pagelet can provide access to internal links and external links.

Note: If you have migrated your Asset Management lease data into Lease Administration (per PeopleSoft’s compliance with ASC 842 and IFRS 16 lease accounting standards), the **Leased Assets** links are no longer relevant.

To set up the WorkCenter Links pagelet as a system administrator, see “Configure Pagelets - Links Page” (Enterprise Components).

To use and personalize the WorkCenter Links pagelet as an end user, see “Working With and Personalizing the Classic Links Pagelet As an End User” (Application Fundamentals).

For more information about setting up query pagelets as a system administrator, see “Configure Pagelets – Queries Page” (Enterprise Components)

For more information about setting up query pagelets as an end user, see “Working With and Personalizing the Classic Queries Pagelet As an End User” (Application Fundamentals)

Using the Asset Management WorkCenter – Queries Pagelet

The Queries section of the Reports/Queries tab can include links to Query Manager, public queries, private queries, and actionable operational analytics (such as grids and graphs). Click on any link in the Queries pagelet to display the query or analytics in the transaction area of the WorkCenter.

The system administrator can add queries to this pagelet and determine if an end user can add public queries in Query Manager.

This example illustrates how the Queries pagelet in Asset Management WorkCenter can be set up:

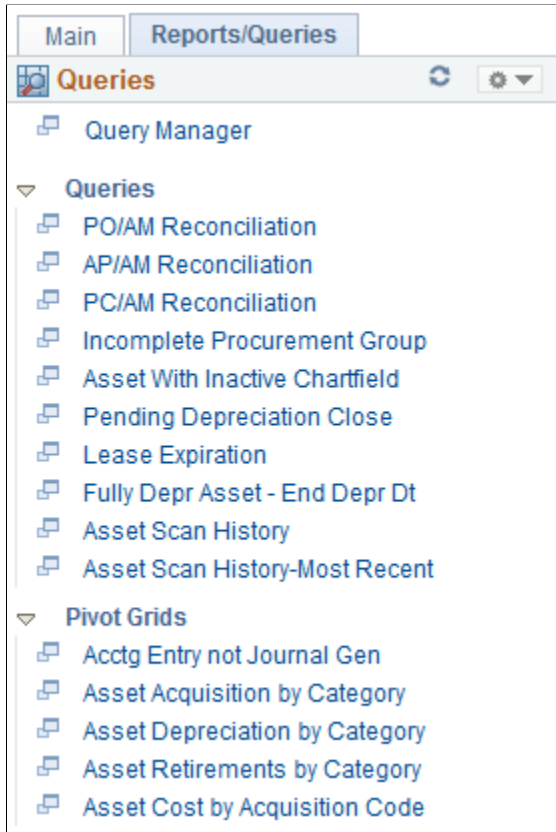

Queries

The Queries group level includes these links to transaction areas:

Field or Control	Description
PO/ AM Reconciliation	Displays a purchase order or receiver related asset, that is not an asset in AM yet.
AP/AM Reconciliation	Displays a voucher related asset, that is not an asset in AM yet.
PC/AM Reconciliation	Displays a project related asset, that is not an asset in AM yet.

Field or Control	Description
Incomplete Procurement Group	Displays pre-interface transactions already existing in the pre-AM table longer than the number of days entered as the procurement group is incomplete.
Asset with Inactive Chartfield	Displays assets with inactive chartfields based on the date entered.
Pending Depreciation Close	Displays assets that need depreciation close run on them for the period based on a given As of Date.
Lease Expiration	Displays leases that will expire within the days entered. Note: This query searches for expired leases in the Asset Management tables only, it does not search the Lease Administration tables.
Fully Depr Asset – End Depr Dt	Displays fully depreciated assets based on the date entered and the asset's end depreciation date.
Asset Scan History	Displays the entire scan history for assets, by business unit.
Asset Scan History – Most Recent	Displays the most recent scan history for assets, by business unit.

Pivot Grids

The Pivot Grids group level includes these links to transaction areas:

Field or Control	Description
Acct Entry not Journal Gen	Displays data in asset accounting entry distribution rows that have not had Journal Generator run on them yet and allows modification of filters and charts.
Asset Acquisition by Category	Displays data in asset acquisition costs as charts based on business unit, book and category and also allows modification of filters and charts.
Asset Depreciation by Category	Displays data in asset depreciation as charts by business unit, book and category and also allows modification of filters and charts .
Asset Retirement by Category	Displays data in asset retirement costs as charts based on business units, books and categories and allows modification of filters and charts.

Field or Control	Description
Asset Cost by Acquisition Code	Displays data in asset costs by acquisition cost as charts based on business units and books and allows modification of filters and charts.

The Queries pagelet can provide access to public queries, private queries, and Pivot Grids.

To set up the WorkCenter Queries pagelet as a system administrator, see “Configure Pagelets – Queries Page” (Enterprise Components).

To use and personalize the WorkCenter Queries pagelet as an end user, see “Working With and Personalizing the Classic Queries Pagelet As an End User” (Application Fundamentals).

Using the Asset Management WorkCenter - Reports and Processes Pagelet

The Reports/Processes pagelet can provide access to system-defined reports and processes for which you have appropriate permissions.

This example illustrates the fields and controls on the Example: Reports/Processes Pagelet in Asset Management WorkCenter.

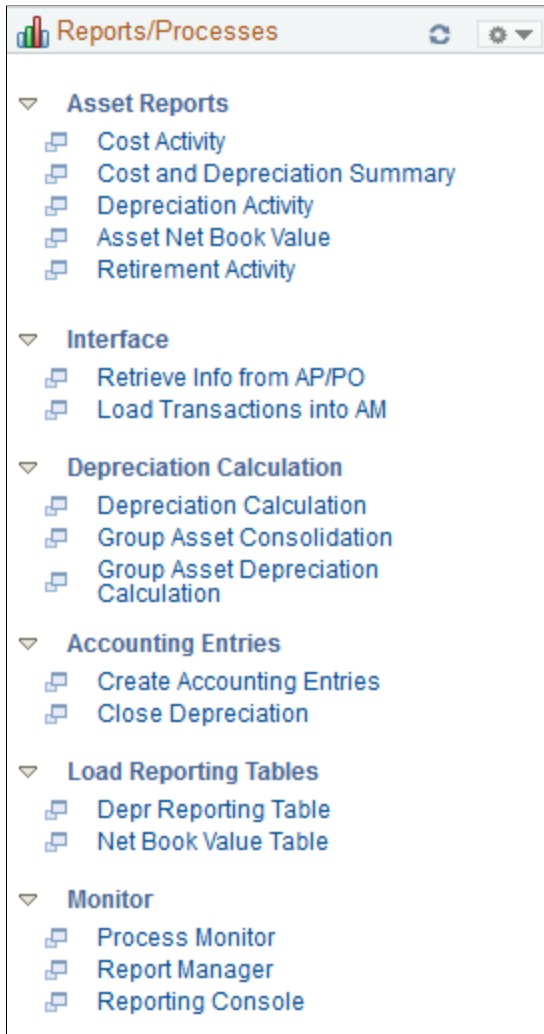

The Reports/Processes pagelet can provide access to system-defined reports and processes for which you have appropriate permissions.

To set up the WorkCenter Reports/Processes pagelet as a system administrator, see “Configure Pagelets – Reports/Processes Page” (Enterprise Components).

To use and personalize the WorkCenter Queries pagelet as an end user, see “Working With and Personalizing the Classic Reports and Processes Pagelet As an End User” (Application Fundamentals).

Using the Asset Management WorkCenter - Dashboard

Use the Asset Management WorkCenter Dashboard to display portal pagelets that provide metrics, pivot grids, and graphics with information in various stages of completion in one aggregated location in the WorkCenter.

This example illustrates the fields and controls on the Asset Management WorkCenter Dashboard.

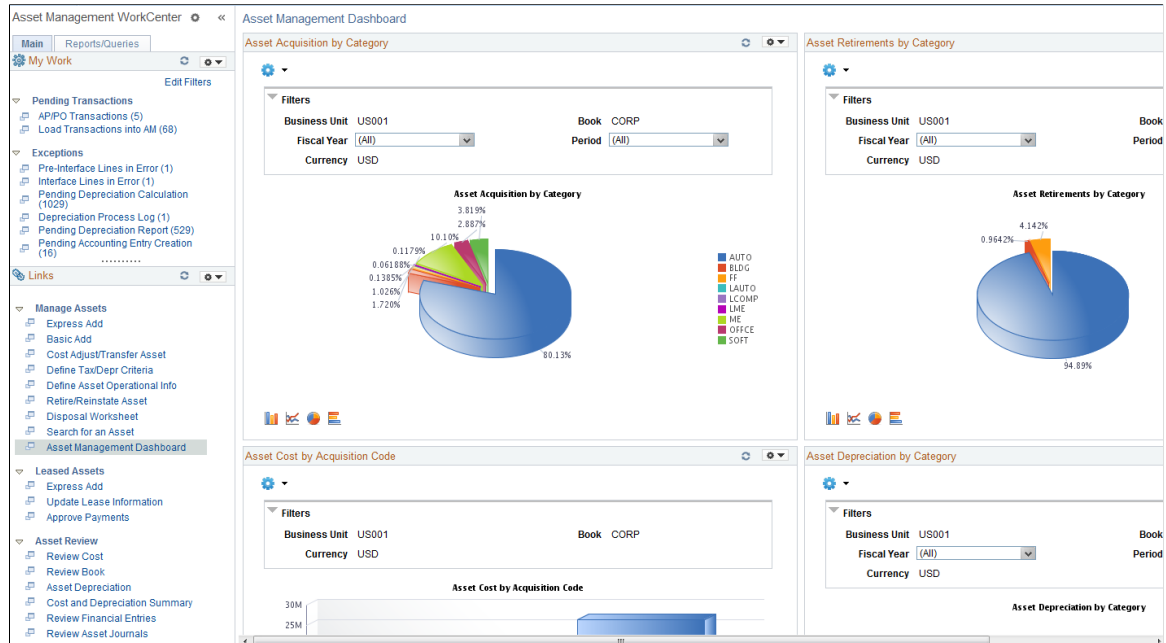

WorkCenter Dashboard and Pivot Grids

PeopleSoft delivers the following pagelets with the Asset Management Dashboard:

- Asset Acquisition by Category
- Asset Retirements by Category
- Asset Cost by Acquisition Code
- Asset Depreciation by Category

These are Asset Management portal pagelets that are configured to appear in your WorkCenter when you click the link within the Links pagelet. When you first click the AM WorkCenter Dashboard link, the delivered pagelets appear by default in collapsed form and in vertical alignment. You can click the refresh button for each pagelet to view the data, if available.

You can configure and personalize the Dashboard pagelet presentation (for example, presenting the pagelets side-by-side) by using Personalize Content/Layout links located in the top right corner of your transaction pane.

Related Links

“Understanding PeopleSoft Classic WorkCenters and Dashboards” (Application Fundamentals)

“PeopleSoft Financials, ESA, ALM, and SCM Portal Packs Overview” (PeopleSoft Financials, ESA, ALM, and SCM Portal Packs)

“Configuring Pagelets” (Enterprise Components)

Chapter 8

Using the PeopleSoft Fluid Asset Management WorkCenter

Understanding the PeopleSoft Fluid Asset Management WorkCenter

The Fluid Asset Management WorkCenter is a central navigational component designed for the end users. The goal of the WorkCenter is to help end users become more efficient by accessing frequently used components and pages and keeping multiple windows open while performing daily tasks.

The Asset Management WorkCenter is delivered with sample data. It is the responsibility of the system administrator from your organization to design and create links so that users can view and access specific links, pages, and pagelets.

For information about setting up PeopleTools options for the WorkCenter, see *PeopleTools: Global Technology*.

Prerequisite

PeopleTools 8.55 is required for the PeopleSoft Fluid WorkCenters.

Related Links

“Understanding PeopleSoft Fluid WorkCenters” (Application Fundamentals)

“Understanding WorkCenters and Dashboards” (Enterprise Components)

Setting Up and Personalizing the PeopleSoft Fluid Asset Management WorkCenter

To personalize the PeopleSoft Fluid Asset Management WorkCenter, see “Setting Up and Personalizing PeopleSoft Fluid WorkCenters” (Application Fundamentals)

Related Links

“Understanding PeopleSoft Fluid User Interface” (Application Fundamentals)

“Understanding How to Set Up PeopleSoft Classic and Fluid WorkCenters As a System Administrator” (Application Fundamentals)

“Understanding Delivered WorkCenters and Dashboards” (Application Fundamentals)

“Configuring Pagelets” (Enterprise Components)

“Configuring Filter Definitions and Values” (Enterprise Components)

Using the PeopleSoft Fluid Asset Management WorkCenter

Pages Used with the PeopleSoft Fluid Asset Management WorkCenter

<i>Page Name</i>	<i>Definition Name</i>	<i>Usage</i>
<u>Asset Management WorkCenter Tile</u>	AM_WORKCENTER_FL	Access the Asset Management WorkCenter page in the PeopleSoft Fluid User Interface.
<u>Asset Management WorkCenter page</u>	AM_WORKCENTER_FL	Access My Work, Links, Queries, and Reports/Processes pagelets using the PeopleSoft Fluid User Interface.

Asset Management WorkCenter Tile

Use the Asset Management WorkCenter Tile (AM_WORKCENTER_FL) to access the Asset Management WorkCenter page in the PeopleSoft Fluid User Interface.

Navigation:

This tile can be placed on any PeopleSoft Fluid Home page. For additional information about how to add a tile to a PeopleSoft Fluid Home page, see *PeopleTools: Application User's Guide*, "Working With PeopleSoft Fluid User Interface", "Working With Fluid Homepages", "Managing Tiles", and "Adding Tiles to a Fluid Homepage".

This example illustrates the Asset Management Workcenter Tile.

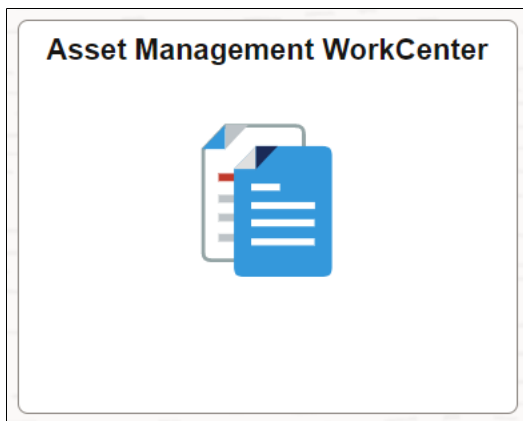

Asset Management WorkCenter page

Use the Asset Management WorkCenter page (AM_WORKCENTER_FL) to access the My Work, Links, Queries, and Reports/Processes pagelets using the PeopleSoft Fluid User Interface.

Navigation:



Select the Asset Management WorkCenter tile.

This example illustrates the fields and controls on the Fluid Asset Management WorkCenter Page as displayed on a desktop. You can find definitions for the fields and controls later on this page.









The screenshot displays the 'Asset Management WorkCenter' interface. On the left is a navigation menu with sections: 'My Work', 'Pending AP/PO Transactions By', and 'Pending Processes'. The 'Purchase Order' item is highlighted in orange. The main area shows a table titled 'AP/PO Transactions By Purchase Order' with 3 rows. The table has columns for Actions, PO Unit, PO ID, Supplier Name, and Transactions Pending.

Actions	PO Unit	PO ID	Supplier Name	Transactions Pending
	US001	0000000352	Westbay Area Electric-	1
	US001	0000000355	Big CompUSA	52
	US001	0000000406	Midton Computer Supplies	25

This example illustrates the fields and controls on the Fluid Asset Management WorkCenter Page as displayed on a smartphone. You can find definitions for the fields and controls later on this page.

Asset Management WorkCenter	
 	
Pending AP/PO Transactions By	▼
Business Unit	78
Pre-Interface ID	78
Purchase Order	78
Receipt	78
System Source	78
Pending Processes	▼
Transaction Loader	83
Depreciation Calculation	925
Accounting Entry Creation	513
Journal Generator	729
Load Depreciation Report	797
Exceptions	▼
Interface Lines in Error	24

On a smartphone (small form factor) only the My Work pagelet is displayed, and only the processes or exceptions with a count are visible.

Field or Control	Description
 (Personalize icon)	Click the Personalize icon to access these options: <ul style="list-style-type: none"> Personalize: Click to access the “Personalize Page (Fluid)” (Application Fundamentals). Edit Filters: Click to access the “Edit Filters Personalize Page (Fluid)” (Application Fundamentals). This option is not available in small form factor.
 (Refresh icon)	Click the Refresh icon to apply updates to personalizations or filters.
 (Update Selected Rows)	Click to activate the checkboxes and Actions button. Select the checkboxes to select one or more rows from the list and perform the related actions in bulk.
 (Actions)	Click to perform the related actions available for the selected items.
 (Filter)	Click to refine filter criteria.
 (Download to Excel)	Click to download data from the current grid into an Excel file.
 (Find)	Click to search for a desired value in the current grid.
 (Sort)	Click to sort current grid data by one of the grid columns.
Process Monitor	This link takes you to the Process List page, where you can view the status of submitted process requests.

Using the Fluid Asset Management WorkCenter – My Work

Use the My Work pagelet within the Fluid Asset Management WorkCenter to quickly view and act on interface transactions, pending processes, and processing exceptions.

The My Work pagelet includes the following groupings:

- Pending AP/PO Transactions By
- Pending Processes
- Exceptions

This example illustrates the fields and controls on the Fluid Asset Management WorkCenter — My Work pagelet.

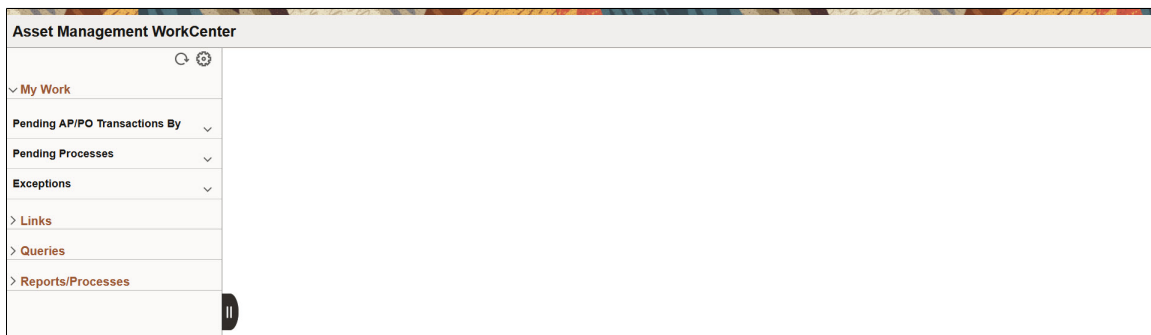

Pending AP/PO Transactions By

Use the options in the Pending AP/PO Transactions By group to review and act upon AP or PO Transactions filtered for the user.

Navigation:

Asset Management > Asset Management WorkCenter > My Work pagelet

Click **Pending AP/PO Transactions By**.

This example illustrates the fields and controls on the AP/PO Transactions By Business Unit page.

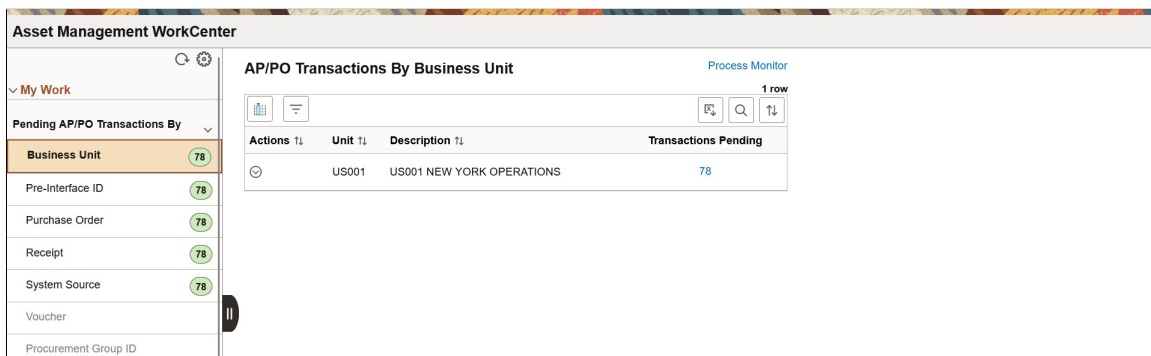

You can also find Pending AP/PO Transactions by the following options:

- Business Unit
- Pre-Interface ID
- Purchase Order
- Receipt
- System Source
- Voucher
- Procurement Group ID

Field or Control	Description
 <p>(Actions)</p>	<p>Click the Actions button to perform the following actions:</p> <ul style="list-style-type: none"> • Load into AM: Select the Load Into AM action to run the PO/AP/AM Interface (AMPS1000) and the Transaction Loader (AMIF1000) processes and populate Asset Management tables with data. • Retrieve Frm AP/PO: Select the Retrieve Frm AP/PO action to run the PO/AP/AM Interface (AMPS1000) process and load asset data from Payables and/or Purchasing to the Asset Management interface tables.
<p>Transactions Pending</p>	<p>Click this hyperlink to view the transaction details for the number of pending transactions displayed.</p> <p>From the Pending Transactions page, you can review the interface, payment, and purchasing details. You can also navigate to other pages, such as View AP/PO Information, View PO Details, View Receiver Details, and View AP Details, by clicking the hyperlinks.</p>

Pending Processes

Use the options in the Pending Processes group to review and complete the pending actions filtered for the user.

Navigation:

Asset Management > Asset Management WorkCenter > My Work pagelet

Click **Pending Processes**.

This example illustrates the fields and controls on the Pending Processes group.

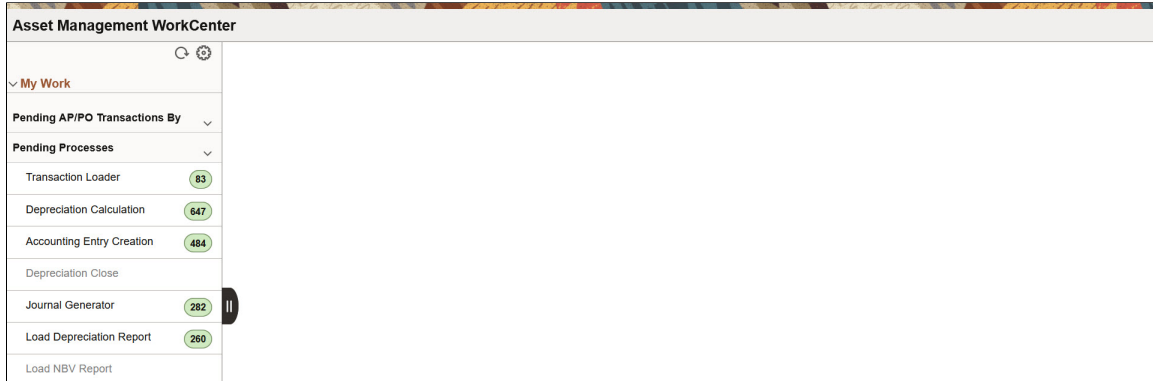

You can perform the pending actions by clicking any of the following options. The number of pending transactions are displayed for each.

- Transaction Loader
- Depreciation Calculation
- Accounting Entry Creation
- Depreciation Close
- Journal Generator
- Load Depreciation Report
- Load NBV Report

Transaction Loader

Use Transaction Loader page (AM_WC_INTFC_FL) to load the pending asset transactions to Asset Management.

This example illustrates the fields and controls on the Load Transactions into AM page. You can find definitions for the fields and controls later on this page.

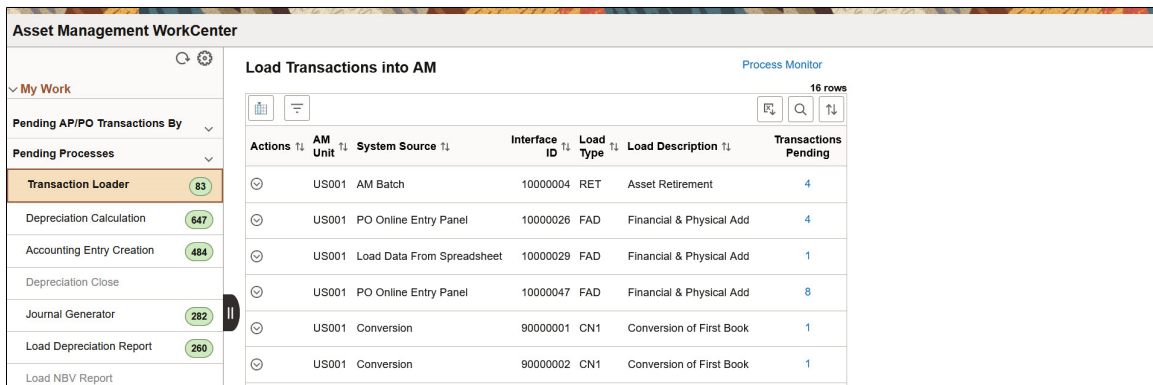



Field or Control	Description
 (Actions)	The available action is Load into AM . Select the Load Into AM action to run the Transaction Loader (AMIF1000) process and populate the Asset Management tables with data.
Transactions Pending	Click this hyperlink to view the transaction details for the number of pending transactions displayed.

Depreciation Calculation

Use Depreciation Calculation page (AM_WC_PEND_PRCS_FL) to view and run the Depreciation Calculation for the pending items.

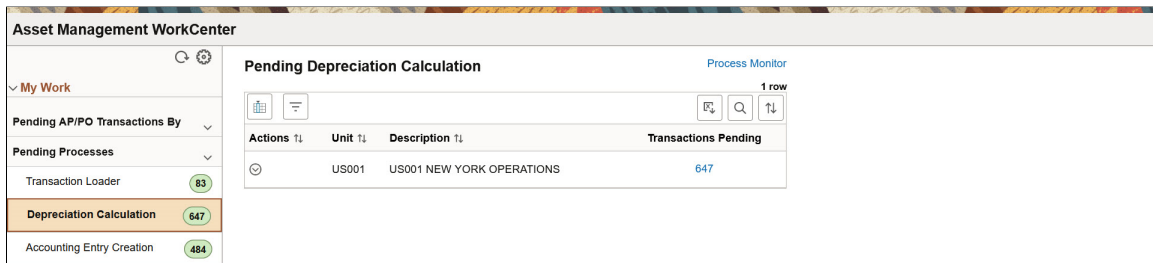
This example illustrates the fields and controls on the Pending Depreciation Calculation page. You can find definitions for the fields and controls later on this page.





Field or Control	Description
 (Actions)	The available action is Run Depreciation Calculation . Select to run the Depreciation Calculation (AM_DEPR_CALC) process for the business unit.
Transactions Pending	Click the Transactions Pending number hyperlink to view the list of pending transactions. On the Transactions Pending page you can perform following actions: <ul style="list-style-type: none"> • Review Book • Review Cost • View Open Transactions • View Asset Depreciation

Accounting Entry Creation

Use Accounting Entry Creation page (AM_WC_PEND_PRCS_FL) to view and create pending accounting entries.

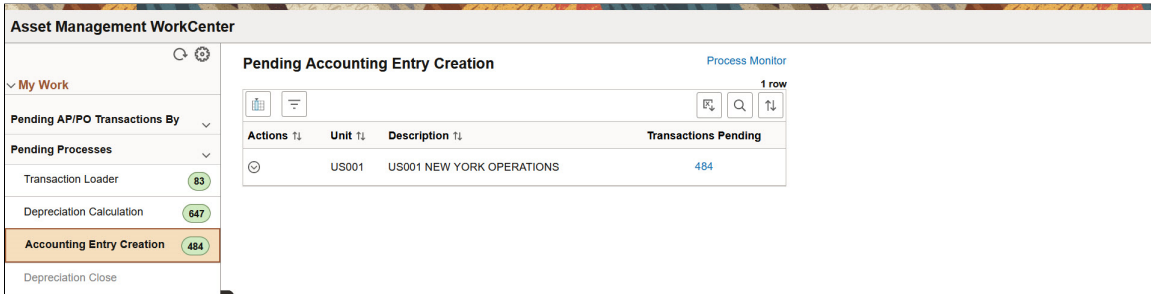
This example illustrates the fields and controls on the Pending Accounting Entry Creation page. You can find definitions for the fields and controls later on this page.



Field or Control	Description
 (Actions)	The available action is Create Actg Entry . Select to create the accounting entries for pending items.
Transactions Pending	Click the Transactions Pending number hyperlink to view the list of pending transactions. On the Transactions Pending page you can perform following actions: <ul style="list-style-type: none"> • Review Book • Review Cost • View Open Transactions • View Asset Depreciation

Depreciation Close

Use Depreciation Close page (AM_WC_PEND_DPCL_FL) to displays assets that need depreciation close run on them for the period based on a given As of Date.

This example illustrates the fields and controls on the Pending Depreciation Close page. You can find definitions for the fields and controls later on this page.

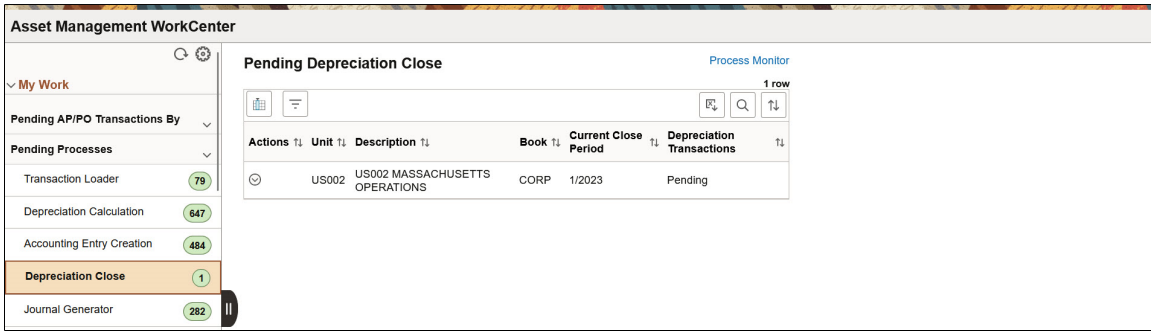

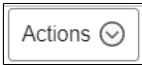

<i>Field or Control</i>	<i>Description</i>
 (Actions)	The available action is Depreciation Close Entry . Click to run the Depreciation Close (AM_DPCLOSE) process for the Business Unit.

Journal Generator

Use Journal Generator page (AM_WC_PEND_PRCES_FL) to view and generate Journal for pending items.

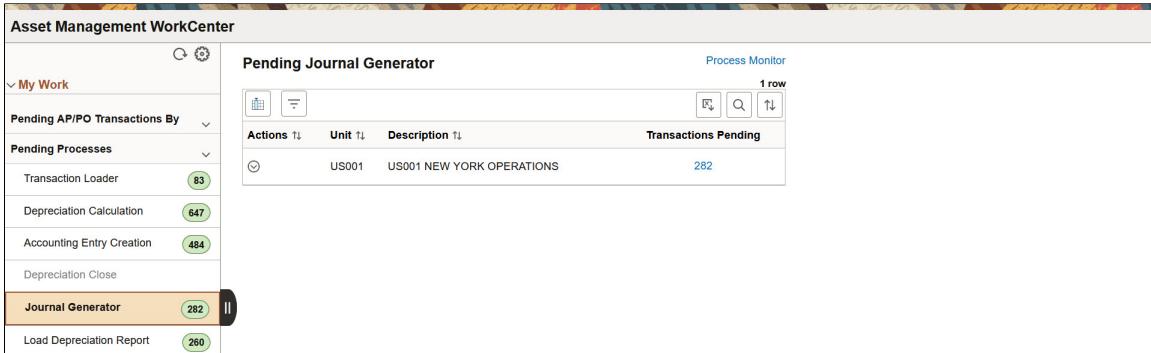
This example illustrates the fields and controls on the Pending Journal Generator page. You can find definitions for the fields and controls later on this page.



<i>Field or Control</i>	<i>Description</i>
 (Actions)	The available action is Generate Journals . Select to run the Generate Journals (FS_JGEN) process for pending items.

Field or Control	Description
Transactions Pending	<p>Click the Transactions Pending number hyperlink to view the list of pending transactions.</p> <p>On the Transactions Pending page you can perform following actions:</p> <ul style="list-style-type: none"> • Review Financial Entries • Review Cost • Asset Depreciation • Review Operating Leases

Load Depreciation Report

Use Load Depreciation Report page (AM_WC_PEND_PRCs_FL) to view and request Depreciation Report table for pending items.

This example illustrates the fields and controls on the Pending Load Depreciation Report page. You can find definitions for the fields and controls later on this page.

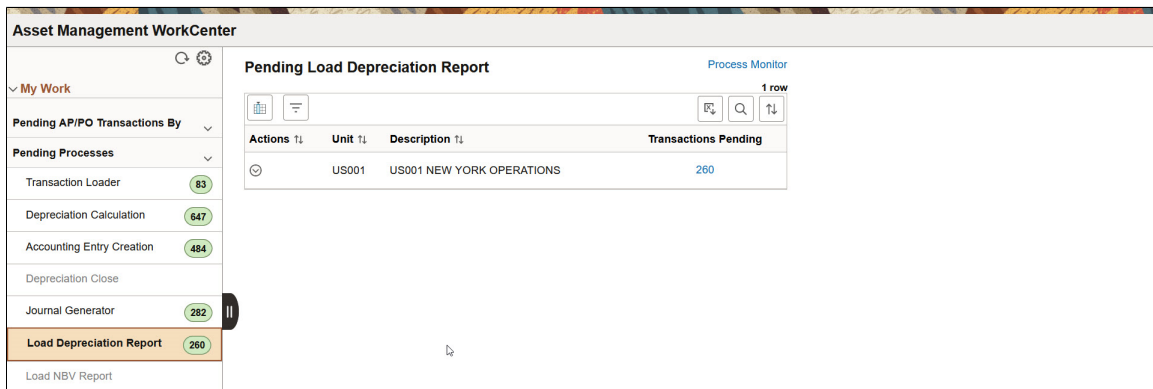

Field or Control	Description
 (Actions)	<p>The available action is Depr Reporting Table.</p> <p>Select to run the Load Depreciation By Period (AMDPREPT) process for pending items.</p>

Field or Control	Description
Transactions Pending	<p>Click the Transactions Pending number hyperlink to view the list of pending transactions.</p> <p>On the Transactions Pending page you can perform following actions:</p> <ul style="list-style-type: none"> • Review Book • Review Cost • View Open Transactions • View Asset Depreciation

Load NBV Report

Use Load NBV Report page (AM_WC_PEND_NBV_FL) to run the process to load the Asset Net Book Value Reporting Table.

This example illustrates the fields and controls on the Pending Load Net Book Value Report page. You can find definitions for the fields and controls later on this page.

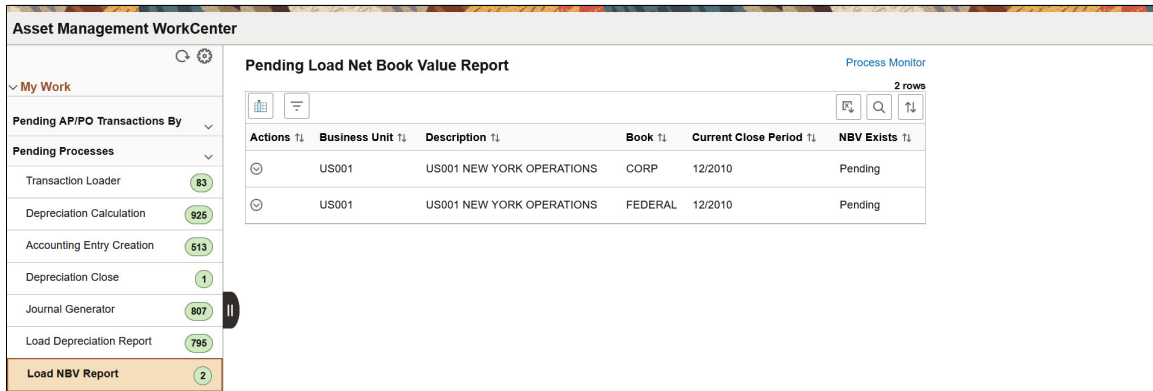

Field or Control	Description
 (Actions)	<p>The available action is Load NBV Report.</p> <p>Select to run the Load Asset Net Book Values (AMLDNBVT) process.</p>

Exceptions

The Exceptions group includes options to view the following processing errors:

- Pre-Interface Lines in Error
- Interface Lines in Error

- Depreciation Log Errors
- Assets with Inactive Location

Pre-Interface Lines in Error

Use the Pre-Interface Lines in Error page (AM_WC_PREAM_ERR_FL) to display pre-interface lines in error and reset or change the transaction status.

This example illustrates the fields and controls on the Pre-Interface Lines in Error page. You can find definitions for the fields and controls later on this page.

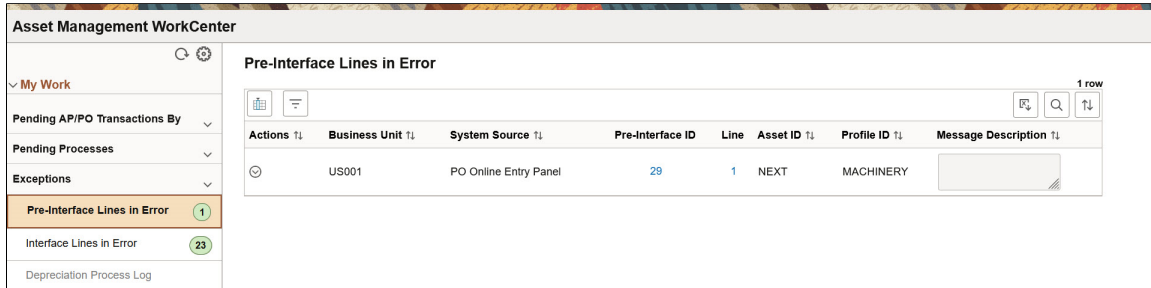

<i>Field or Control</i>	<i>Description</i>
 (Actions)	The available actions are: <ul style="list-style-type: none"> • Reset Transaction To Pending: Select one or more Interface IDs and click the Reset Transaction to Pending action to set the selected rows in error to the Pending status. • Change to On-Hold: Select one or more Interface IDs and click the Change to On-Hold action to set the selected rows in error to the On-Hold status. • Change to Excluded: Select one or more Interface IDs and click the Change to Excluded action to set the selected rows in error to the Excluded status.
Interface ID and Line	Click the Interface ID or Line number hyperlink to navigate to the Review Transactions page.

Interface Lines in Error

Use the Interface Lines in Error page (AM_WC_INTFC_ERR_FL) to display interface lines in error and reset transactions to pending.

This example illustrates the fields and controls on the Interface Lines in Error page. You can find definitions for the fields and controls later on this page.

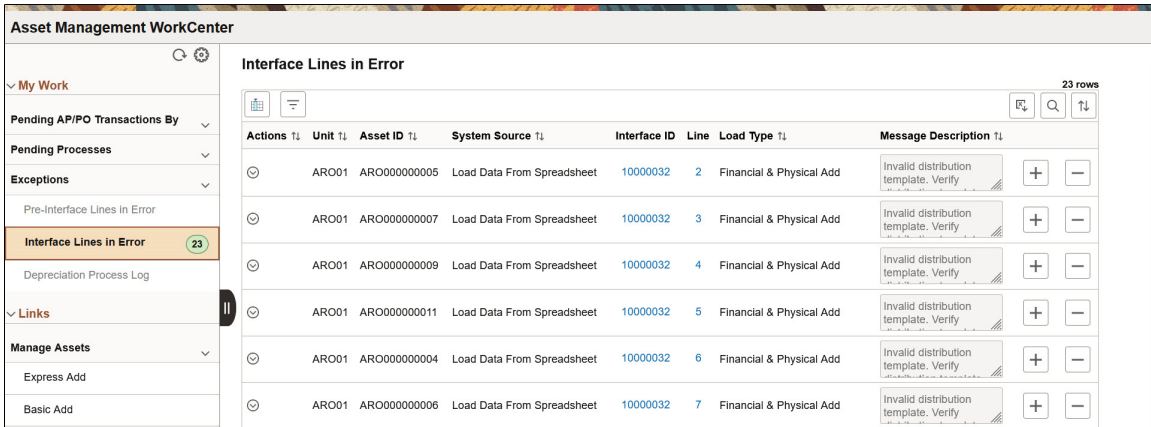

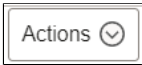
Field or Control	Description
 (Actions)	The available actions are: <ul style="list-style-type: none"> • Reset Transaction To Pending: Select one or more Interface IDs and click the Reset Transaction to Pending action to set the selected rows in error to the Pending status. • Change to On-Hold: Select one or more Interface IDs and click the Change to On-Hold action to set the selected rows in error to the On-Hold status. • Change to Excluded: Select one or more Interface IDs and click the Change to Excluded action to set the selected rows in error to the Excluded status.
Interface ID and Line	Click the Interface ID or Line number hyperlink to navigate to the Review Transactions page.

Depreciation Process Log

Use the Depreciation Process Log page (AM_WC_DEPR_ERR_FL) to display depreciation rows in error and select to remove from log.

This example illustrates the fields and controls on the Depreciation Process Log page - Process Details tab. You can find definitions for the fields and controls later on this page.

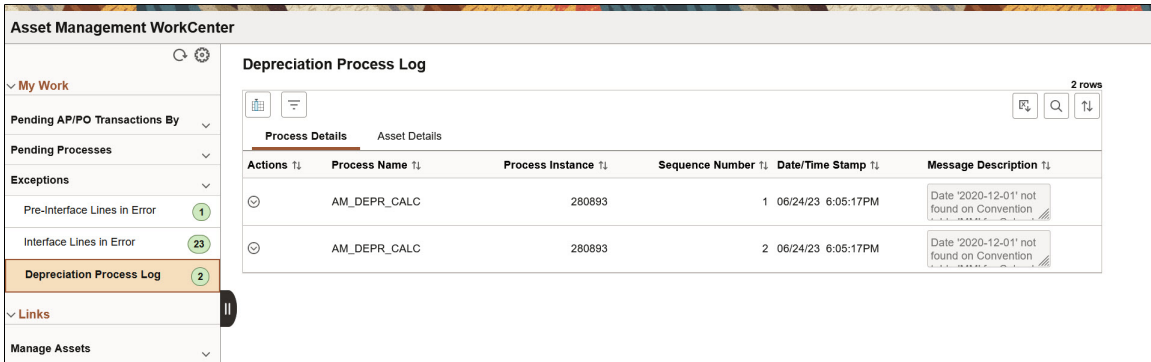

This example illustrates the fields and controls on the Depreciation Process Log page - Asset Details tab. You can find definitions for the fields and controls later on this page.

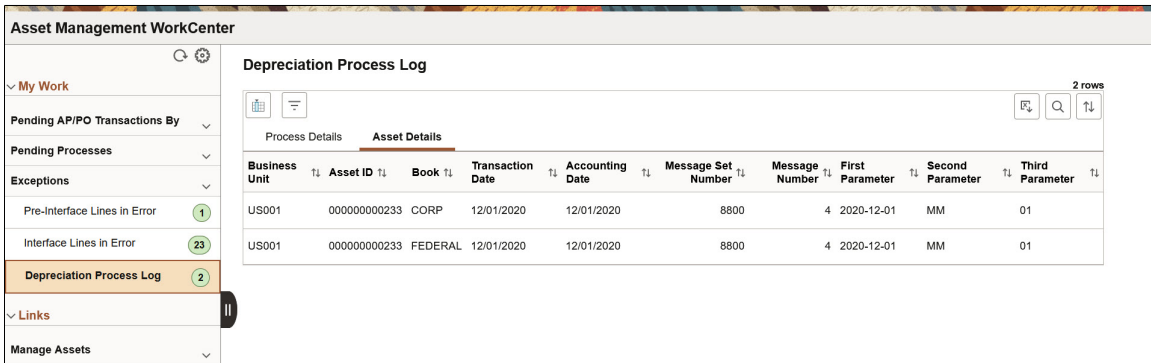

Field or Control	Description
 (Actions)	The available action is Clear Log . Select one or more Process Instances and click the Clear Log action to remove selected logs from the log table.

Assets with Inactive Location

Use the Assets with Inactive Location page (AM_WC_LOC_INACT_FL) to display assets with an inactive location code.

This example illustrates the fields and controls on the Assets with Inactive Location page. You can find definitions for the fields and controls later on this page.

Actions	Business Unit	Asset ID	Description	Asset Status	Asset Type	Tag Number	Location Description	Location Status
⊙	US001	EX_000000007	Chevrolet Tahoe LT 1/2Ton	In Service	Fleet	P00000000007	USA - New York	Inactive
⊙	US001	EX_000000008	Chevrolet Tahoe LT 1/2Ton	In Service	Fleet	P00000000008	USA - New York	Inactive
⊙	US001	EX_000000009	2000 Chevrolet Tahoe LT 1/2Ton	In Service	Fleet	P00000000009	USA - New York	Inactive
⊙	US001	EX_000000010	Chevrolet Tahoe LT 1/2Ton	In Service	Fleet	P00000000010	USA - New York	Inactive
⊙	US001	EX_000000091	Computer Desk	In Service	Furniture	P00000000091	USA - New York	Inactive
⊙	US001	EX_000000258	Machinery Equipment	In Service	Machinery	P00000000258	USA - New York	Inactive
⊙	US001	EX_000000107	Computer Desk	In Service	Furniture	P00000000107	USA - New York	Inactive
⊙	US001	EX_000000108	Computer Desk	In Service	Furniture	P00000000108	USA - New York	Inactive
⊙	US001	EX_000000109	Computer Desk	In Service	Furniture	P00000000109	USA - New York	Inactive

Field or Control	Description
 (Actions)	The available action is Update Asset Location . Select one or more assets and click the Update Asset Location action to access the Update Asset Location page and provide a new location for the asset.

Using the Fluid Asset Management WorkCenter – Links Pagelet

Use the Asset Management WorkCenter - Links pagelet to view the Asset Management links. The primary purpose of this pagelet is to minimize the number of clicks to access critical path components and pages. Click any of the links on the pagelet to display the destination page in the transaction area.

This example illustrates the fields and controls on the Links Pagelet.

The Links pagelet can provide access to internal and external links.

Note: The Leased Asset group of links provides access to all shared Lease Administration functionality licensed within Asset Management.

To personalize the WorkCenter Links pagelet as an end user, see “Setting Up and Personalizing PeopleSoft Fluid WorkCenters” (Application Fundamentals).

Using the Fluid Asset Management WorkCenter – Queries Pagelet

The Queries pagelet can include links to Query Manager, public queries, private queries, and actionable operational analytics (such as grids and graphs). Click on any link in the Queries pagelet to display the query or analytics in the transaction area of the WorkCenter.

The system administrator can add queries to this pagelet and determine if an end user can add public queries in Query Manager.

This example illustrates the fields and controls on the Queries Pagelet.



Queries

The Queries group includes links to the following queries:

Field or Control	Description
PO/AM Reconciliation	Displays a purchase order or receiver related asset, that is not an asset in AM yet.
AP/AM Reconciliation	Displays a voucher related asset, that is not an asset in AM yet.
PC/AM Reconciliation	Displays a project related asset, that is not an asset in AM yet.
Incomplete Procurement Group	Displays pre-interface transactions already existing in the pre-AM table longer than the number of days entered as the procurement group is incomplete.

<i>Field or Control</i>	<i>Description</i>
Asset With Inactive ChartField	Displays assets with inactive chartfields based on the date entered.
Fully Depr Asset - End Depr Dt	Displays fully depreciated assets based on the date entered and the asset's end depreciation date.
Asset Scan History	Displays the entire scan history for assets, by business unit.
Asset Scan History-Most Recent	Displays the most recent scan history for assets, by business unit.
Assets With Inactive Location	Displays assets that are assigned to locations that are no longer active in PeopleSoft. Inactive locations can impact both physical inventory and maintenance.
Asset Journals in Error	Displays the list AM journals that are in error in GL.
Asset Cost Roll Forward	Displays roll forward asset data to assist with financial statements and tax reporting. The cost activity will be summarized by asset category.
Asset NBV Roll Forward	Displays the breakdown of asset net book value by category.

Pivot Grids

The Pivot Grids group includes links to the following pivot grids:

<i>Field or Control</i>	<i>Description</i>
Acctg Entry not Journal Gen	Displays data in asset accounting entry distribution rows that have not had Journal Generator run on them yet and allows modification of filters and charts.
Asset Acquisition by Category	Displays data in asset acquisition costs as charts based on business unit, book and category and also allows modification of filters and charts.
Asset Depreciation by Category	Displays data in asset depreciation as charts by business unit, book and category and also allows modification of filters and charts.
Asset Retirements by Category	Displays data in asset retirement costs as charts based on business units, books and categories and allows modification of filters and charts.

Field or Control	Description
Asset Cost by Acquisition Code	Displays data in asset costs by acquisition cost as charts based on business units and books and allows modification of filters and charts.

The Queries pagelet can provide access to public queries, private queries, and Pivot Grids.

To set up the WorkCenter Queries pagelet as a system administrator, see “Configure Pagelets – Queries Page” (Enterprise Components).

Using the Fluid Asset Management WorkCenter – Reports and Processes Pagelet

The Reports/Processes pagelet provides access to system-defined reports and processes.

This example illustrates the fields and controls on the Reports and Processes Pagelet.

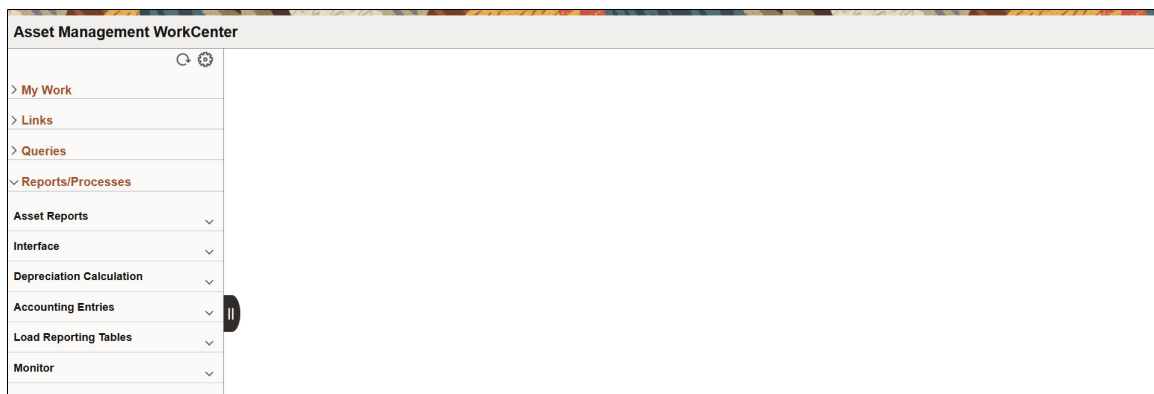

The Reports/Processes pagelet can provide access to system-defined reports and processes depending on user permissions.

To set up the WorkCenter Reports/Processes pagelet as a system administrator, see “Configure Pagelets – Reports/Processes Page” (Enterprise Components).

Working with Asset Budgeting

Understanding Asset Budgeting

Charting foreseeable acquisitions is sometimes straightforward, but can often involve assets with high levels of complexity. The capital acquisition planning functionality in PeopleSoft Asset Management and PeopleSoft Budgeting handles your plans when they involve a single asset, and also accommodates acquisitions that span several phases and involve many different components. For more complex acquisitions, PeopleSoft enables you to define a master plan with an unlimited number of subsidiary plans. As you acquire assets, you can associate them with the capital acquisition plan and maintain an up-to-date view as your business makes each expenditure included in the plan.

Each plan you set up is assigned a type. Types provide a categorization method that you can use when you generate reports.

You can have as many capital acquisition plan types as you need to reflect the range of categories that you want to track. Each time you design a capital acquisition plan, assign a type.

Before you work with capital acquisition planning, you must create business units and establish capital acquisition plan types.

See “Integrating with Budgeting” (Asset Lifecycle Management Fundamentals).

Understanding Capital Acquisition Planning

The PeopleSoft Asset Management and Budgeting products provide a straightforward page set for entering a plan, enabling you to link assets to that plan and to update cost and asset summaries so that you have an overview at a glance.

When you establish a new plan, you provide ChartField information to identify the project and you enter a cost estimate and cost limit. Plans consist of a single asset or multiple asset component in a large project. You can provide a text description and justification for the plan, and you can enter multiple authorizations for each asset within a plan.

Once you assign a plan to *Open* status, you can link assets to the plan as they are acquired. All associated assets appear on one summary page; cost summary information is provided on another. As the status of each asset changes, the summary totals reflect that progress; you can see how much of your acquisition amount is represented by assets in different life phases.

Note: You cannot link assets to a plan until the plan is assigned an *Open* status. Assign open status to a capital acquisition plan on the Capital Acquisition Planning - Details page.

Defining New Capital Acquisition Plans

To appropriate funds for a capital acquisition, you set up a capital acquisition plan by assigning a type; indicating the ChartFields affected; entering cost information; and providing a plan description, justification, and authorization.

Pages Used to Define New Capital Acquisition Plans

Page Name	Definition Name	Usage
Capital Acquisition Planning - Details Page	BD_CAP_DETAILS	Add a new capital acquisition plan.
CAP Detail Long Description Page	BD_CAP_DET_SEC	Enter a long description for a selected item in the capital acquisition plan. See Capital Acquisition Planning - Details Page
CAP Details - Annual Cost Page	BD_CAP_COST_SEC	Enter and keep track of CAP annual cost for a selected item in the capital acquisition plan. The values you enter on this page are for information only. The system does not use this information for any validation purposes. See Capital Acquisition Planning - Details Page
CAP Details - Justification Page	BD_CAP_JUSTIFY_SEC	Enter a detailed justification for a selected item in the capital acquisition plan. (optional) See Capital Acquisition Planning - Details Page
CAP Details - Authorization Page	BD_CAP_AUTH_SEC	Authorize each item in the capitalization acquisition plan. See Capital Acquisition Planning - Details Page

Capital Acquisition Planning - Details Page

Use the Capital Acquisition Planning - Details page (BD_CAP_DETAILS) to add a new capital acquisition plan.

Navigation:

Asset Management > Asset Transactions > Capital Acquisition Planning > Create (CAP) Plan > Details

Note: Column visibility and order for grids may vary by implementation. Use the scroll bar to view all the available columns.

Field or Control	Description
CAP Class	Select a class: <ul style="list-style-type: none"> • <i>Cost Reduction</i> • <i>Expansion</i> • <i>Necessity</i> • <i>New</i>

Details

The Details group box can contain a single entry if the plan is for a standalone asset, or it can contain many assets that make up a larger project. For example, an expansion project for the Customer Service Department could have three CAP **Seq #** (sequence numbers), one each to build out a building wing, interior design plans, and furniture and fixtures.

Note: Since this is a new plan, the **Original/Adjustment Switch** should be set to *Original*. When you revise existing plans, be sure to select *Adjustment* instead.

Field or Control	Description
Description	Enter a description for the asset, which may be similar to the plan name if the plan contains only one sequence number. This description and the CAP Sequence number show on the other detail pages associated with capital acquisition planning for the asset.
CAP Type	Select a type. The available CAP types are those defined when you established asset processing. You can generate reports that segregate the assets by the CAP Type you assign here.

Field or Control	Description
Status	<p>Statuses are used for reporting purposes, organizing information or when making adjustments to existing plans. Select a status from the options on the drop-down list:</p> <ul style="list-style-type: none"> • <i>Open</i>: Select this option to open a CAP. You can only associate assets to a CAP that has an open status. • <i>Closed</i>: Select this option to close the CAP. The CAP Plan sequence will not be treated as closed until its status is set to Closed; It does not matter if the closing date in the Est Comp field has expired. • <i>Entered</i>: Select this status when first entering a CAP. • <i>On Hold</i>: Select this status if the CAP is on hold. • <i>Approval 1, 2 or 3</i>: Select these statuses to denote the approval phase of the CAP.
Est Comp (estimated completion)	<p>Enter an estimated completion date to be used for tracking this plan. When all the items in this plan are acquired, access the page again and enter the Date Closed. Remember, you must also set the Status to <i>Closed</i> to keep assets from being added to this CAP after it is closed.</p>
Requester	<p>To ensure that the audit trail is accurate, enter a requester.</p>
Estimated Cost	<p>The cost you enter displays on the CAP Summary page. You can adjust the cost estimate as time passes by selecting the <i>Adjustment</i> option in the Original/Adjustment Switch field and specifying a different cost. The total of the adjustments and the updated cost estimate also display on the CAP Summary page.</p>
Cost Limit	<p>Enter a maximum cost for the CAP plan; or, enter a % Over Allowed and the system calculates the cost limit automatically based on the percentage that you specify.</p>
% Over Allowed (percentage over allowed)	<p>Specify a percentage to add a margin to your cost estimate. If you specify an amount, the system enables you to add an asset to the plan that pushes your acquisition costs above the limit you set. The system automatically calculates the Cost Limit based upon the estimated amount and the percentage over estimated amount that you specify. The disparity is reflected in the SQRs for capital acquisition planning.</p>

Related Links

[Defining New Capital Acquisition Plans](#)

Adjusting Capital Acquisition Plans

Once a capital acquisition plan is established, there are a variety of revisions and additions you can make. All the information originally entered can be modified, and you have the option to change the original information or leave it intact and tag your changes as adjustments. The *Original* or *Adjustment* option on the Detail page reflects your categorization options.

You may not want to keep track of text changes you make to a plan, but you probably need to maintain the history of fluctuations in estimated costs and cost limits. The CAP Summary page separates the original cost estimate and cost limit from adjustments made to these amounts, so you can see the changing financial picture at a glance. You have these options:

- If you want the cost modifications to display separately, be sure that you select the *Adjustment* option on the Detail page before you enter cost information.
- If you want to change the original cost rather than make an adjustment, leave the *Original* option selected on the Detail page, and access pages by using Update/Display as the action.

Note: Keep in mind that the capital acquisition pages are not effective-dated, so you need to use the Adjustment option if you want to maintain a history of the changes you make to any plans.

Linking Assets to Existing Capital Acquisition Plans

One of the advantages of capital acquisition planning is that it gives you a measure against which you can chart capital expenditures to ensure that you stay within the projected budget. Once you have completed a capital acquisition plan, you want to ensure that the assets you acquire under that plan are associated with it so that you can view the totals as you approach the estimated cost or cost limit.

Each time you add an asset in PeopleSoft Asset Management, you have the option to assign it a capital acquisition plan number that links it to an open capital acquisition plan. This link can also be made in Purchasing when you create requisitions or purchase orders to purchase assets. Assets created using the interface from Purchasing are automatically associated with the CAP assigned on the requisition.

Note: The capital acquisition plan must have a status of *Open* to have assets associated with it. A capital acquisition plan that is still in approval phases cannot have assets linked to it.

Viewing Capital Acquisition Plans

PeopleSoft Asset Management and PeopleSoft Budgeting offer you a view of capital acquisition plans from different perspectives. You can see a list of all the assets that are linked to a particular plan, display any capital or operating lease payments associated with a particular plan, or view a summary of cost information.

Pages Used to View Capital Acquisition Plans

Page Name	Definition Name	Usage
Capital Acquisition Planning - Financial Assets	BD_CAP_ASSETS	<p>View a list of financial assets associated with a plan. The link between an asset and a plan is made on the Asset Basic Information - Asset Entry page or the ExpressAdd Cost/Asset Information page when you add a new asset. The link between an asset and the plan can also be made when you create assets using the Purchasing/Assets interface for requisitions or purchase orders.</p> <p>You must associate the asset with the capital acquisition plan by specifying the appropriate plan number on the Asset Basic Information - Asset Entry page, the ExpressAdd - Cost/Asset Information page, or the Purchasing/Asset interface.</p>
Capital Acquisition Planning - Non-Financial Assets	BD_CAP_NF_ASSETS	View a list of nonfinancial assets associated with a plan. The Non-Financial Assets page is populated by the CAP_ASSET_NF_VW view with nonfinancial assets that are not retired.
Capital Acquisition Planning - Capital Lease Payments	BD_CAP_LSE_PAY	View a list of any capital lease payments associated with a capital acquisition plan.
Capital Acquisition Planning - Operating Lease Payments	BD_CAP_OPR_LSE_PAY	View a list of any operating lease payments associated with a capital acquisition plan. The operating lease payment data is populated by the CAP_LSE_OPR_VW view, which pulls the schedule from the PS_LEASE_SCHED record.
Capital Acquisition Planning - Summary	BD_CAP_SUMMARY	Review cost information related to the plan. The system automatically totals the costs of both nonfinancial and financial assets associated with the capital acquisition plan and shows values by estimated costs, cost limits, and asset status categories.

Running Capital Acquisition Plan Reports

Run the Capital Acquisition Planning report from the Capital Acquisition Planning - Parameters page.

Page Used to Run Capital Acquisition Plan Reports

<i>Page Name</i>	<i>Definition Name</i>	<i>Usage</i>
Capital Acquisition Planning - Parameters	RUN_AMCP2000	Set parameters for the capital acquisition plan reports: Capital Acquisition Planning (AMCP2000), CAP by Department (AMCP2010) and CAP Assets (AMCP2100).

Working With Leased Assets

Understanding Leased Assets

Beginning with PeopleSoft Image 27, PeopleSoft provides you with the ability to transition your leases to the new accounting standards ASC 842 and IFRS 16. Part of this transition includes the migration of Asset Management leases to the Lease Administration data structure. The migration establishes the sharing of leasing functionality between Asset Management and Lease Administration. There is no need to license Lease Administration to run the data migration and transition processes. However, certain components and functionality in Lease Administration will be hidden or unavailable unless you license Lease Administration. Customers licensed only for Asset Management will benefit from the features and functionality within Lease Administration that specifically address the core accounting requirements for payables leases (lessee agreements).

After migrating your Asset Management leases to Lease Administration, you can process information under the current accounting standard and then later transition to the new accounting standard closer to your organization's adoption date. You can also migrate your Asset Management leases to the Lease Administration data structure at your convenience. Because of functionality and page accessibility changes depending on whether you have migrated your leases, this topic is split into pre-migration and post-migration leased asset functionality.

For more information on lease migration, see:

“Understanding the Data Migration and Transition Process” (PeopleSoft Lease Administration)

“Understanding Shared Product Functionality for Asset Management Leases” (PeopleSoft Lease Administration)

Pre-Migration Leased Asset Functionality

PeopleSoft Asset Management incorporates full lease management functionality, including calculating and printing lease payment schedules, calculating leased asset revenues, and verifying leases as operating or capital leases, in accordance with FASB Accounting Standards Codification 840. It also provides the ability to define step leases as well as a robust lease payment integration with PeopleSoft Payables for automatic voucher creation.

In PeopleSoft Asset Management, you can retire and reinstate leased assets and track interim payments.

Note: Your transactions are maintained with multiple currencies if you use them in conjunction with leased assets.

See also [Understanding Conversion to PeopleSoft Asset Management](#)

Capital and Operating Leases

There are two basic types of leases: capital leases and operating leases.

- A capital lease is treated as a financial asset.

It has a lease term and lease payment amount. The lease is carried on the balance sheet and is periodically depreciated.

- An operating lease is treated as a nonfinancial asset to which no cost information is associated. It is normally expensed and can include rent and monthly payments that are expensed periodically.

PeopleSoft Asset Management uses the lease classification rules for capital and operating leases as proscribed by the country requirements that were established during the setup of book location. For example, in the United States, leased assets are defined and governed by Financial Accounting Standards Board (FASB) Statement 13.

Note: The United States FASB 13 lease classification rules apply to all countries unless otherwise noted. For example, in Germany, the threshold for capitalization is 90 percent of the leased asset's economic life, as compared to 75 percent under the United States' generally accepted accounting principles. In Canada, the classification of capital or operating leases is the same as that defined in the United States FASB 13. PeopleSoft Asset Management supports the United States, Germany, Canada, and Australia for lease type verification.

Step Leases

A step lease features variable payment amounts and variable timing over the term of the lease.

Examples of step leases include:

- Step-down leases with decreasing or declining lease payments.
- Step-up leases with increasingly larger lease payments during the lease term.
- Skip-payment leases in which payments are not required during certain periods.

This table provides an example of a step-down lease schedule:

<i>Number of Terms</i>	<i>Frequency</i>	<i>Payment Amount</i>
6	Monthly	\$400
18	Monthly	\$350

This table provides an example of a quarterly step-lease payment schedule. It is suggested that you use three payment schedules with due dates as shown.

<i>Schedule</i>	<i>Due Dates</i>
Schedule 1	January, April, July, October
Schedule 2	February, May, August, November

Schedule	Due Dates
Schedule 3	March, June, September, December

For an annual step-lease payment schedule, it is suggested that you use 12 payment schedules, with one schedule for each of the 12 months as the payment due date.

Lease Payment Integration with PeopleSoft Payables

You can enable the lease payment integration between PeopleSoft Asset Management and PeopleSoft Payables to automatically generate vouchers for lease payments that are calculated in Asset Management. This includes both capital and operating leases. Additionally, the lease payment schedule segregates the principal and interest of each payment and is used by the Depreciation Close process (AMDPCLOS) to generate the payment accounting entries. The lease payments can be allocated on a monthly basis, in accordance with GAAP, and Asset Management generates the associated monthly accrual accounting entries. Lease Interest Contra and Lease Obligation Contra accounts must be established as clearing accounts, which are offset by the Payables voucher entries. This integration is enabled at the Asset Management business unit level.

See *Integrating with PeopleSoft Payables – Sending Lease Payments to Payables* in “Understanding How PeopleSoft Asset Management Integrates with Other Applications” (Asset Lifecycle Management Fundamentals).

See “Interface Options Page” (Asset Lifecycle Management Fundamentals).

Once you have enabled the lease payment integration with PeopleSoft Payables at the business unit level:

- Complete the Payables Integration page within the Leased Assets component with pertinent integration information by asset.
- Review payment date, integration status, and Payables information for lease payments that are selected for Payables integration using the Review Payments page.
- Approve pending lease payments to Payables (if the pre-approval option is not enabled).
- Upload payments to be processed to Payables.
- Run AP/AM Payment Reconciliation report.

See [Integrating Lease Payments with PeopleSoft Payables](#).

Post-Migration Leased Asset Functionality

PeopleSoft Asset Management shares functionality with PeopleSoft Lease Administration to leverage the features and functions within Lease Administration that specifically address the core accounting requirements for payables leases (lessee agreements). Customers licensed only for Asset Management are not required to install Lease Administration, but there will be limited access to functionality in Lease Administration. More specifically, customers licensed only for Asset Management can only access pages under the Asset Management navigation and the required high-level configurations. .

Customers licensed only for Asset Management will be able to enter multiple financial terms, integrate payments with Accounts Payable, perform straight-line accounting, use amendment processing and create

manual fees. Customers licensed only to Asset Management will not have access to clauses, options and critical dates, operating expenses, percent rent, security deposits, site selection and acquisition, my lease portfolio, and lease reports such as the lease abstract. In addition, customers licensed only for Asset Management are limited to only one asset per lease, and the tracking of lease options is limited to only those that are reasonably certain to be exercised.

Customers licensed only for Asset Management will have access to the following common components:

Shared Product Configuration	Navigation
Lease Administration Business Unit	Setup Financials/Supply Chain > Business Unit Related > Lease Administration > LA Business Unit Definition
LA Accounting Rules	Setup Financials/Supply Chain > Product Related > Lease Administration > Accounting > LA Accounting Rules
Amendment Types	Setup Financials/Supply Chain > Product Related > Lease Administration > General Definitions > Amendment Types
Lease Types	Setup Financials/Supply Chain > Product Related > Lease Administration > General Definitions > Lease Types
Prorata Basis	Setup Financials/Supply Chain > Product Related > Lease Administration > General Definitions > Prorata Basis
Related Lease Type Setup	Setup Financials/Supply Chain > Product Related > Lease Administration > General Definitions > Related Lease Type Setup
Borrowing Interest Rate	Setup Financials/Supply Chain > Product Related > Lease Administration > General Definitions > Borrowing Interest Rate
Transaction Routing Codes	Setup Financials/Supply Chain > Product Related > Lease Administration > Financial Terms > Transaction Routing Codes
Miscellaneous Rent Types	Setup Financials/Supply Chain > Product Related > Lease Administration > Financial Terms > Miscellaneous Rent Types
Manual Fee Types	Setup Financials/Supply Chain > Product Related > Lease Administration > Financial Terms > Manual Fee Types
Economic Index	Setup Financials/Supply Chain > Product Related > Lease Administration > Financial Terms > Economic Index
Role Types	Setup Financials/Supply Chain > Product Related > Lease Administration > User Roles > Role Types

Shared Product Configuration	Navigation
Lease Administration Roles	Setup Financials/Supply Chain > Product Related > Lease Administration > Financial Terms > Lease Administration Roles
Options	Setup Financials/Supply Chain > Product Related > Lease Administration > Options

In addition, customers licensed only for Asset Management will have access to the following pages for lease entry and processing residing under the Asset Management navigation:

Shared Product Functionality	Navigation
Migration and Transition	Asset Management > Asset Transactions > Leased Assets > Migration and Transition
Create New Lease	Asset Management > Asset Transactions > Leased Assets > Create New Lease
Maintain Lease	Asset Management > Asset Transactions > Leased Assets > Maintain Lease
Generate Straightline Schedule	Asset Management > Asset Transactions > Leased Assets > Generate Straightline Schedule
Manual Straightline Adjustment	Asset Management > Asset Transactions > Leased Assets > Manual Straightline Adjustment
Processing Payments	Asset Management > Asset Transactions > Leased Assets > Processing Payments
Pending Lease Payables	Asset Management > Asset Transactions > Leased Assets > Pending Lease Payables
Manage Transaction Generator	Asset Management > Asset Transactions > Leased Assets > Manage Transaction Generator
Manage Interface to AP/Billing	Asset Management > Asset Transactions > Leased Assets > Manage Interface to AP/Billing

For more information on lease migration, see:

“Understanding the Data Migration and Transition Process” (PeopleSoft Lease Administration)

Defining Payment Schedules

This topic discusses how to add or modify payment schedules for leases.

Before you can add leased assets to your system, you must define at least one payment schedule to indicate when a lease starts and ends. Leases can share the same payment schedule ID.

Page Used to Define Payment Schedules

<i>Page Name</i>	<i>Definition Name</i>	<i>Usage</i>
<u>Payment Schedules Page</u>	LEASE_SCH_ID	Add or modify payment schedules for leases.

Payment Schedules Page

Use the Payment Schedules page (LEASE_SCH_ID) to add or modify payment schedules for leases.

Navigation:

Set Up Financials/Supply Chain > Product Related > Asset Management > Financials > Payment Schedules > Payment Schedules

This example illustrates the fields and controls on the Payment Schedules page. You can find definitions for the fields and controls later on this page.

Payment Schedules

SetID SHARE Payment Schedule ID AA General Payment Schedule

Payment Schedule

Number of Payments Per Year 12

Prorate Lease Expense

Description This payment schedule will be setup for monthly lease calculations.

Generate Schedule Parameters

Begin Date 31 Lease Term (Periods)

End Date 31 Payment Frequency ▼

End Of Month Due Date Populate

Payment Dates Personalize | Find | 📅 | 🔍 | First ⏪ 1-792 of 792 ⏩ Last

Payment Date			
01/01/1960	31	+	-
02/01/1960	31	+	-
03/01/1960	31	+	-
04/01/1960	31	+	-
05/01/1960	31	+	-
06/01/1960	31	+	-
07/01/1960	31	+	-
08/01/1960	31	+	-
09/01/1960	31	+	-
10/01/1960	31	+	-
11/01/1960	31	+	-
12/01/1960	31	+	-
01/01/1961	31	+	-
02/01/1961	31	+	-
03/01/1961	31	+	-

Complete the information about the begin date, end date, lease term, and payment frequency.

Field or Control	Description
Number of Payments Per Year	Enter a value to determine the number of lease payments for the lease schedule.

Field or Control	Description
Prorate Lease Expense	Select to prorate the accounting entries that are generated for lease payments by the depreciation close process (AMDPCLOS) on a monthly basis. The lease payment schedule segregates the principal and interest of each payment and is used by the AMDPCLOS process to generate the payment accounting entries. The prorated amounts are allocated as well according to their respective ChartField distributions.
End of Month Due Date	Select to always schedule a payment on the last day of the month.
Populate	After completing the fields about the payment schedule, click the Populate button to automatically populate the Payment Date column fields.

Adding Capital and Operating Leases

This topic discusses how to add and update Capital and Operating Leases.

Note: Financial transactions cannot be performed on the Lease Administration Lease Assets through Asset Management.

Pages Used to Add Capital and Operating Leases

Page Name	Definition Name	Usage
<u>Express Add – Definition and Update Lease Information – Definition Pages</u>	ASSET_LEASE_01	Create a capital lease or an operating lease.
<u>Express Add – Definition and Update Lease Information – Definition Pages</u>	ASSET_LEASE_01	Update a capital lease or an operating lease.
<u>Express Add – Cost Page</u>	ASSET_LEASE_02	Enter cost, ChartField, and depreciation data for a leased asset.
<u>Express Add – Cost Page</u>	ASSET_LEASE_02	Update cost, ChartField, and depreciation data for a leased asset.
<u>Express Add – Step Lease Payment and Update Lease Information – Step Lease Payment Pages</u>	ASSET_LEASE_05	Enter a step-lease payment schedule.

Page Name	Definition Name	Usage
<u>Express Add – Step Lease Payment and Update Lease Information – Step Lease Payment Pages</u>	ASSET_LEASE_05	Update a step-lease payment schedule.
<u>Express Add – Payment Schedule and Update Lease Information – Payment Schedule Pages</u>	ASSET_LEASE_03	Create or view lease payment schedules.
<u>Express Add – Payment Schedule and Update Lease Information – Payment Schedule Pages</u>	ASSET_LEASE_03	Update lease payment schedules.
Update Lease Information - Operating ChartFields	ASSET_LEASE_06U	Update operating lease ChartField information. ASSET_LEASE_06 and ASSET_LEASE_06U are used to allocate operating lease payments to a particular set of ChartFields.

Express Add – Definition and Update Lease Information – Definition Pages

Use the Express Add - Definition page (ASSET_LEASE_01) to create a capital lease or an operating lease.

Navigation:

Asset Management > Asset Transactions > Leased Assets > Lease Express Add

Use the Update Lease Information - Definition page (ASSET_LEASE_01) to update a capital lease or an operating lease.

Navigation:

Asset Management > Asset Transactions > Leased Assets > Update Lease Information

This example illustrates the fields and controls on the Leased Assets - Express Add - Definition page (1 of 2). You can find definitions for the fields and controls later on this page.

This example illustrates the fields and controls on the Leased Assets - Express Add - Definition page (2 of 2). You can find definitions for the fields and controls later on this page.

Field or Control	Description
Profile ID	Enter an ID if you want to use the default information from an asset profile to define this asset. You must enter a profile ID for a capital lease because all depreciation information is stored in the profile ID. A profile ID is not required for an operating lease.
Region Code	Select a region code from the available options.

Field or Control	Description
Trans Date (transaction date) and Acctg Date (accounting date)	Enter a transaction date and accounting date for the lease. For leases, the payment date is based on the transaction date. For example, if a lease begins in October and you need to start the payments in the same month, enter a transaction date of October 1. The accounting date has no bearing on the payment date.
CAP # (capital acquisition planning number) and Seq # (sequence number)	Select the associated Capital Acquisition Plan number for this leased asset or look up the associated Asset ID Sequence number if one has been assigned.
Trans Code (transaction code)	Select the accounting entry template that is used for transactions relating to this asset.
Asset Type	Select the asset type from the available established values. You must enter Asset Type for operating leases if you do not enter a profile.
Subtype	Select the asset subtype from the available defined values for the selected Asset Type .
Currency	Select the currency for the transactions that are processed with this asset.
Serial ID	Enter the Serial ID that is associated with this asset. Serial IDs track physical inventory, especially for IT assets.
Tag Number	Enter the tag number that is associated with this asset. Tag numbers track physical inventory. <hr/> Note: To perform a physical inventory with PeopleSoft Asset Management, your assets must use tag numbers. <hr/>
Rate Type	The exchange rate that is defined for the default book for the business unit appears by default in this field. You can select a different rate type.
Location	Select the location code from the available values.
Area ID	Select the area ID from the available values.
Asset Operational Information	Click this link to display the Define Asset Operational Information page. The link is visible only after saving the lease component.

Lease Information

Field or Control	Description
Lease ID and Description	Select from the available lease IDs assign a new ID for this business unit and add a description of the lease. Description is required only if a Lease ID has been assigned.
Supplier ID and Supplier Contact	Select the Supplier ID from the list of available suppliers for this asset and enter contact information. Supplier ID is required if Lease ID is assigned.
Supplier Location and Ship To	Enter the supplier location and ship to location from the available values. These fields are enabled only when a supplier ID is entered.
Responsibility	Enter the name of the person who is responsible for this leased asset. Required if Lease ID is entered.
Acceptance Date	Indicates the date that the lease contract is accepted (signed and returned to the lessor). If you complete the Interim Rent (Monthly) field in the Lease Term group box, you must enter an acceptance date that is earlier than the commencement date of the lease. Interim rent starts on the acceptance date and ends on the commencement date. You enter the amount of the interim rent in the Interim Rent (Monthly) field.
Receipt Date	Enter the date the leased asset is received. This is an information-only date field for reporting purposes.
Lease End Date	Enter the date the leased asset is received. Lease End Date becomes required when a Lease ID is entered. This date is used for the Lease End Date report.
Display Alert Days	Enter the number of days in advance to receive the Lease End Date pagelet based on the Lease End Date. This field appears only if PeopleSoft IT Asset Management (ITAM) is installed.
Commence Date and Expiration Date	These fields represent the first and last lease payment date (regardless of interim rent), and appear only after you save the page.
Inception Date	This field appears when viewing this page in Update/Display mode. The date that is displayed is the date of the original transaction.

Field or Control	Description
Additional Lease Information	<p>Click this link to access the Lease administration component.</p> <hr/> <p>Note: If Lease Administration is installed, users can see Clauses, Options and Critical dates, Contacts along with Notes and Attachments and Supplemental Data pages on the lease component. Else, only the Notes and Attachments, and Supplemental Data pages are displayed on the lease component.</p> <hr/>
Comment	Enter any comments to be noted for this leased asset.

Note: If LEASE is entered and PeopleSoft ITAM is installed then Description, Lease End Date, Vendor Id and Responsibility are required fields.

Lease Term

Field or Control	Description
Lease Term	Enter the number of periods in this lease.
Estimated Life	The number of periods that you entered in Lease Term field appears by default. You can change this value.
Interest Rate (%) (interest rate percentage)	Enter the approximate percentage of profit the lessor gains by leasing the asset to you. This number must be an annual interest rate percentage in whole numbers.
Borrowing Rate (%)	Enter the interest rate that you would have incurred at the inception of the lease if you had borrowed the necessary funds to purchase the leased asset. This number must be an annual interest rate percentage in whole numbers.
Payment Schedule ID	If you want the system to define a lease payment schedule, enter a payment schedule ID. Capital leases must have a payment schedule ID. The values that you can select are set up on the Payment Schedule page when you specify the payment frequency and number of periods.

Field or Control	Description
Fair Value	<p>Enter the fair value. The system uses the fair value to verify the lease type. It also records this value on the AM_FMV table to use in the asset revaluation process. The system calculates the capitalized lease amount using the lesser of the Present Value Lease Payments and Fair Value field values.</p> <p>If the present value of the lease payments is less than the fair value, the capitalized lease amount equals the present value of the minimum lease payment (MLP).</p> <p>If the fair value is less than the present value of lease payments, the capitalized lease amount equals the fair value.</p> <p>You might want to change the interest rate so that the net present value equals the fair value.</p> <p>If you do <i>not</i> enter a fair value, the capitalized lease amount equals the present value of the MLP.</p>
FV Template ID (fair value template ID)	<p>Select a fair value template, which includes the valuation method, level and premise. If left blank, the fair value is created but the additional valuation information is not provided.</p> <p>See “Fair Value Templates Page” (Asset Lifecycle Management Fundamentals).</p>
FV Group ID (fair value group ID)	<p>This field is active only when the selected FV Template ID has a valuation premise of <i>In Use</i>. The default value is supplied from the selected FV Template ID; however, you can override it and select another FV Group ID.</p> <p>See “Fair Value Groups Page” (Asset Lifecycle Management Fundamentals).</p>
Guar. Residual Value (guaranteed residual value)	<p>Calculates depreciation based on the amount of the residual value of the leased asset that is guaranteed by the lessee to the lessor and considered as part of the minimum lease payments.</p>
Guaranteed Residual Percent	<p>Calculates depreciation based on the percent of the residual value of the leased asset that is guaranteed by the lessee to the lessor and considered as part of the minimum lease payments.</p>

Field or Control	Description
BPO (bargain purchase option)	Select if this lease includes a bargain purchase option, which represents a payment by the lessee to the lessor at the end of the lease term, allowing the lessee to obtain title to the leased property.
BRO (bargain renewal option)	Select if this lease includes a bargain renewal option, which requires a payment if the lease agreement grants the lessee the right to renew or extend the lease. If the agreement specifies that the lease must be renewed or extended, a penalty might be required for failure to renew.
Transfer Ownership end lease	Check if there is an ownership transfer of the asset at the end of the lease period.
Step lease	Select if the lease is a step lease. A step lease features variable payment amounts and/or variable timing over the term of the lease.

Field or Control	Description
Minimum Rental Payment (MRP)	<p>Enter the minimum rental payment. This field is not required for step leases.</p> <hr/> <p>Note: You must either enter a minimum rental payment here or complete the cost information on the Cost page. Otherwise, the system cannot calculate the lease payment schedule.</p> <hr/>
Minimum Lease Payments (MLP)	<p>Display a minimum lease payment.</p> <ul style="list-style-type: none"> If there is no bargain purchase option (and you entered a bargain renewal option instead): $MLP = (MRP \times Lease\ Term \div 12\ periods\ per\ year \times number\ of\ payments\ per\ year) + Guaranteed\ Residual + BRO.$ If there is a bargain purchase option: $MLP = (MRP \times Lease\ Term \div 12\ periods\ per\ year \times number\ of\ payments\ per\ year) + BPO.$

Field or Control	Description
Present Value Lease Payments	<p>Displays the present value of the lease payments for a step lease.</p> <p>The system uses two formulas to determine the present value of the total payment for a step lease.</p> <ul style="list-style-type: none"> For the first payment in the schedule, the formula looks at the present value of an ordinary annuity for a series of payments of any amount: $P1 = Pymt \times ([1 - (1 + Intr) ^ -npymt] \div (intr))$ where: P1 = Present value of an ordinary annuity. Pymt = Periodic payment amount. Intr = Periodic interest rate. npymt = Number of payments. For payments that are made after the first payment, the formula looks at the present value of a single future amount: $P2 = Single_Future_Pymt \times (1 \div (1 + intr) ^ nper)$ where: P2 = Present value of a single future amount. Single_Future_Pymt = Future amount. intr = Periodic interest rate. nper = Number of periods.

The example illustrates the calculations using an interest rate of 7.2 percent.

Number of Terms	Frequency	Payment Amount
6	Monthly	400 USD
18	Monthly	350 USD

PV1 equals Present value of the first payment in the schedule:

$$400 \text{ USD} \times ([1 - (1 + 0.01) ^ -6] \div (0.01)) = 2,350.40 \text{ USD}$$

PV2 equals Present value of the second payment in the schedule:

$$[350 \text{ USD} \times ([1 - (1 + 0.01)^{-18}] / (0.01))] \times (1 \div 1.01^6) = 5,744.88 \text{ USD}$$

Present value of the total cash flow equals: $2,350.40 + 5,744.88 = 8,095.28 \text{ USD}$

Note: The lease term during the renewal period is considered part of the overall lease term.

Field or Control	Description
Capitalized Lease Amount	<p>Enter the cost. The system uses the following method to calculate lease payments:</p> <p>Capitalized Lease Amount - Prior Obligation Reduction = Residual Capitalized Lease Amount</p> <p>Residual Lease Amount \times (Annual Implicit Interest Rate / Number of Periods per Year) = Interest Expense per Period</p> <p>Interest Expense per Payment + Obligation Reduction = MRP</p>

For example, this table illustrates a full payment schedule for a simple capital leased asset with a capitalized amount of 10,500 USD, an interest rate of 7 percent, a monthly payment of 908.53 USD, and 12 periods per year:

Period	Residual Capitalized Lease Amount in USD	Obligation Reduction	Interest Expense	Payment in USD
1	10,500.00	847.2800562	61.24994377	908.53
2	9,652.71	852.2225232	56.30747678	908.53
3	8,800.49	857.1938213	51.33617873	908.53
4	7,943.29	862.1941186	46.33588144	908.53
5	7,081.10	867.2235843	41.30641574	908.53
6	6,213.88	872.2823885	36.2476115	908.53
7	5,341.59	877.3707024	31.15929757	908.53
8	4,464.22	882.4886982	26.0413018	908.53

<i>Period</i>	<i>Residual Capitalized Lease Amount in USD</i>	<i>Obligation Reduction</i>	<i>Interest Expense</i>	<i>Payment in USD</i>
9	3,581.73	887.6365489	20.89345107	908.53
10	2,694.10	892.8144288	15.7155712	908.53
11	1,801.28	898.022513	10.50748703	908.53
12	903.26	903.2609776	5.26902237	908.53

<i>Field or Control</i>	<i>Description</i>
Interim Rent (Monthly)	<p>Enter the amount of monthly interim rent for a capital or operating lease. Interim rent is common for quarterly leases. Interim rent starts on the acceptance date and ends on the commencement date of the lease. Once the lease officially begins, the normal rental payment amount is tracked by the lease payment schedule.</p> <p>PeopleSoft Asset Management prorates the first month of interim rent. You can see interim rent payments on the Express Add - Payment Schedule page (ASSET_LEASE_03).</p> <p>Select Capitalize Interim Rent if you want to include these interim payments as part of your asset cost.</p> <hr/> <p>Note: You must post journal entries for interim rent each month by running the Depreciation Close process (AM_DPCLOSE).</p> <hr/>
Capitalize Interim Rent	Select this check box to capitalize. When selected, the interim rent is added to the cost of the leased asset.

Field or Control	Description
Calculate	<p>Click to have the system calculate the lease payment schedule.</p> <p>Before the system can calculate the lease payment schedule, you must have:</p> <ul style="list-style-type: none"> • Defined a payment schedule. • Entered (for leases other than step leases) the minimum rental payment on this page or entered cost information on the Express Add - Cost page. • For step leases, entered payment information on the Express Add - Step Lease Payment page. <p>You can see the results of the calculation on the Express Add - Payment Schedule page.</p>

Lease Payment Type

Select a payment type: **Advance** or **Arrears**. You can use either type for both capital leases and operating leases. More details on these two payment types are provided in this table:

Calculation	Advance Payment Type	Arrears Payment Type
Present Value Factor	Total payment terms for present value factor excludes the term of the advance (or first) payment.	Total payment terms for present value factor equal the total terms of the lease.
Present Value of Minimum Lease Payments	Equals: (Present Value Factor × Periodic Payment Amount) + Advance payment.	Equals: Present Value Factor × Periodic Payment Amount.
Amortization Schedule	<p>Period interest expense equals: Capitalized Amount × the period interest rate.</p> <p>The Capitalized Amount used for the first period of the payment excludes the advance payment amount.</p>	Period interest expense equals: Capitalized Amount × the period interest rate.

Field or Control	Description
Advance	<p>Select if an asset is leased with the first payment that is due before the lease begins. For advance payments, the interest expense is not calculated.</p> <p>If the present value is calculated on a lease with 12 monthly payments of 100.00 USD and an interest rate of seven percent, then the calculated present value factor is 10.6254.</p> <p>Calculated present value = 100 USD + 10.6254 × 100 = 1,162.54 USD</p>
Arrears	<p>An arrears payment type means that an asset is leased with the payment due at the end of the period. This is the lease payment type by default. If the present value is calculated on a lease with 12 monthly payments of 100.00 USD and an interest rate of seven percent, then the calculated present value factor is 11.5571.</p> <p>Calculated present value = 11.5571 × 100 = 1,155.71 USD</p>

Lease Type

When you select the lease type, you can verify that you have selected the correct lease type for a country. If you do not select either the **Capital** or the **Operating** options, the system selects the lease type for you. The system can verify the lease types for the U.S., Canada, Germany, and Australia. Canada uses the same criteria as the U.S. for classifying capital and operating leases. Germany uses a higher threshold for the lease term (90 percent instead of 75 percent).

Note: You cannot change a lease type from capital to operating or from operating to capital. If you must change the lease type, you must first retire the leased asset and then reenter the lease with the appropriate lease type.

Field or Control	Description
Capital	<p>Select if the lease is a capital lease.</p> <p>According to FAS13, a capital lease must meet one of the following criteria:</p> <ul style="list-style-type: none"> • There is an ownership transfer at the end of the lease. • The lease contains a bargain purchase option (BPO). • The lease term is 75 percent or more of the asset life. <p>In Germany, the lease term is 90 percent of the leased asset's economic life.</p> <ul style="list-style-type: none"> • The present value of the minimum lease payment is 90 percent or more of the fair value of the asset.

Field or Control	Description
Operating	Select if the lease is an operating lease.
Verify	<p>Click this button to verify if the lease meets the criteria for a capital lease or an operating lease. If the lease type meets the criteria, the system displays a message confirming that the criteria for FAS13 has been met. If you do not select the Capital or Operating option before clicking the Verify button, the system looks at the information that you have entered on this page about the lease, including the country code, and selects the lease type for that country.</p> <hr/> <p>Note: This verification test is disabled for leased assets that use an Indian business unit; designation of capital or operating leases is manual for assets in India.</p> <hr/> <p>See (IND) Using PeopleSoft Asset Management Options to Meet Indian Requirements.</p>

Express Add – Cost Page

Use the Express Add - Cost page (ASSET_LEASE_02) to enter cost, ChartField, and depreciation data for a leased asset.

Navigation:

Asset Management > Asset Transactions > Leased Assets > Express Add > Cost

Use the Update Lease Information - Cost page (ASSET_LEASE_02) to update cost, ChartField, and depreciation data for a leased asset.

Navigation:

Asset Management > Asset Transactions > Leased Assets > Update Lease Information > Cost

This example illustrates the fields and controls on the Cost page. You can find definitions for the fields and controls later on this page.

Quantity	Cost	Currency	Salvage Value	Currency	Category	Cost Type
1.0000	68,378.39	USD	25,000.00	USD	LAUTO	

If you did not enter a minimum rental payment (MRP) on the Definition (ASSET_LEASE-01) page, you must complete the cost information on this page.

The system uses the cost information on this page to calculate the lease payment schedule. Use the **Cost**, **Chartfields**, and **Depreciation** tabs to enter more details. Because the ChartFields are effective-dated, you can use them to track transfers.

Note: If you are working with a step lease, you do not have to enter any information on this page.

Express Add – Step Lease Payment and Update Lease Information – Step Lease Payment Pages

Use the Express Add - Step Lease Payment page (ASSET_LEASE_05) to enter a step-lease payment schedule.

Navigation:

Asset Management > Asset Transactions > Leased Assets > Express Add > Step Lease Payment

Use the Update Lease Information - Step Lease Payment page (ASSET_LEASE_05) to update a step-lease payment schedule.

Navigation:

Asset Management > Asset Transactions > Leased Assets > Update Lease Information > Step Lease Payment

This example illustrates the fields and controls on the Step Lease Payment page. You can find definitions for the fields and controls later on this page.

Definition	Cost	Step Lease Payment	Payment Schedule	Payables Integration	Asset Lease E Wrk1		
Unit	US001	Asset ID	NEXT	Tag	In Service		
Step Lease ?		Personalize Find View All [?] []		First	1 of 1	Last	
Line Number	Lease Term	Payment Frequency	Payment Amount	Currency			
1				0.00 USD			

If you checked the **Step lease** check box on the Definition (ASSET_LEASE-01) page, you can use this page to change payment information.

Enter a line number, enter the lease term (number of periods), select a payment frequency, and enter a payment amount. For example, you could define a step lease that consists of six monthly payments of 400.00 JPY followed by 18 monthly payments of 350 JPY.

If you are defining a skip payment, enter a payment frequency, the number of lease terms, and a payment amount of zero (0.00).

Note: The line numbers must be in sequential order. For example, if you update a lease schedule and need to insert a row between lines 1 and 2, you can use a line number such as 1.2.

After you are done working with this page, you must return to the Definition (ASSET_LEASE-01) page and click the **Calculate** button to generate the lease payment schedule.

Express Add – Payment Schedule and Update Lease Information – Payment Schedule Pages

Use the Express Add - Payment Schedule page (ASSET_LEASE_03) to create or view lease payment schedules.

Navigation:

Asset Management > Asset Transactions > Leased Assets > Express Add > Payment Schedule

Use the Update Lease Information - Payment Schedule page (ASSET_LEASE_03) to update lease payment schedules.

Navigation:

Asset Management > Asset Transactions > Leased Assets > Update Lease Information > Payment Schedule

This example illustrates the fields and controls on the Payment Schedule. You can find definitions for the fields and controls later on this page.

Unit US001		Asset ID NEXT		Leased Exe SL		Status: In Service	
Lease Book CORP		Corporate		Currency USD			
Payment Schedule Personalize Find First 1-60 of 60 Last							
Payment Date	Payment Total	Currency	Interest Expense	Obligation Reduction	Payment Type		
1 11/01/2010	800.00	USD	0.00	800.00	N		
2 12/01/2010	800.00	USD	112.63	687.37	N		
3 01/01/2011	800.00	USD	111.49	688.51	N		
4 02/01/2011	800.00	USD	110.34	689.66	N		
5 03/01/2011	800.00	USD	109.19	690.81	N		
6 04/01/2011	800.00	USD	108.04	691.96	N		
7 05/01/2011	800.00	USD	106.89	693.11	N		
8 06/01/2011	800.00	USD	105.73	694.27	N		
9 07/01/2011	800.00	USD	104.57	695.43	N		
10 08/01/2011	800.00	USD	103.41	696.59	N		
11 09/01/2011	800.00	USD	102.25	697.75	N		
12 10/01/2011	800.00	USD	101.09	698.91	N		
13 11/01/2011	800.00	USD	99.93	700.07	N		
14 12/01/2011	800.00	USD	98.76	701.24	N		
15 01/01/2012	800.00	USD	97.59	702.41	N		

The system calculates the payment schedule on this page when you click the **Calculate** button on the Express Add - Definition page.

You can update the information on this page as needed.

Note: In case of capitalizing the interim rent, payments are noted with a *C* rather than *I* next to the payment line. You can change this designation by modifying message number 8015,37, using the PeopleTools Message Catalog.

If you elect to process periodic depreciation accounting entries, the system creates the journal entries that are shown in the following table:

Action	Debits	Credits
Add	<ul style="list-style-type: none"> AD Accumulated Depreciation FA Leased property under capital leases (capitalized lease amount) 	<ul style="list-style-type: none"> DE Depreciation Expense LO Obligations under capital leases
Adjust	<ul style="list-style-type: none"> AD Accumulated Depreciation FA Leased property under capital leases (capitalized lease amount) 	<ul style="list-style-type: none"> DE Depreciation Expense LO Obligations under capital leases

Action	Debits	Credits
Transfer In	<ul style="list-style-type: none"> FA Leased property under capital leases (capitalized lease amount) DE Depreciation Expense 	AD Accumulated Depreciation
Transfer Out	AD Accumulated Depreciation	<ul style="list-style-type: none"> FA Leased property under capital leases (capitalized lease amount) DE Depreciation Expense
Retire	<ul style="list-style-type: none"> CA Proceeds [Proceeds] LO Obligations under capital leases [Guaranteed Residual] AD Accumulated Depreciation [Current Reserve] LO Obligations under capital leases [Remaining Lease Payments] 	<ul style="list-style-type: none"> LG Guaranteed Residual Payable [Guaranteed Residual] FA Leased property under capital leases [Current Cost] GL Gain/Loss on leased property [Remaining Payments + ((Proceeds – Removal Cost) + (Cost – Reserve))]

Creating Lease Expense Schedules

This topic discusses how to create lease expense schedules by running the Lease Expense Schedule process.

You must run this process:

- After setting up a step lease.
- After adjusting transactions in a step lease.
- Before running the depreciation close process.

Note: The purpose of running the lease expense schedule process is to prorate payment and interest expenses so that the proper amounts are sent to the general ledger (GL) according to the FASB. You must run this process for all leases that have non-monthly payment schedules.

AMLSESCH reads PS_LEASE_SCHEDULE and creates PS_LEASE_SCHED2, which contains all the step-lease non-monthly payment information. AM_DPCLOSE reads PS_LEASE_SCHED2 (through PS_LEASE_CHART3_vw) to distribute the payment and interest expenses to the GL.

The Lease Expense Schedule process spreads non-monthly lease payments (such as quarterly payments) throughout the year, dividing them into monthly amounts on the lease expense schedule. The results are different for capital leases and operating leases:

- For operating leases, the lease expense schedule allocates non-monthly payments to monthly amounts.
- For capital leases, the lease expense schedule allocates non-monthly interest expense to monthly amounts, and the payment amount is fully allocated on the date that the payment is due.

The following example uses an arrears type lease for a quarterly payment:

<i>Payment Date</i>	<i>Payment Amount</i>	<i>Interest Expense</i>
June 1, 2009	300	33

The lease expense schedule allocates the payments as shown:

<i>Payment Date</i>	<i>Payment Amount</i>	<i>Interest Expense</i>
April 1, 2009	0.00	11
May 1, 2009	0.00	11
June 1, 2009	300	11

If the general ledger period is closed, the allocation is carried forward to the next open period.

Note: Operating leases do not have interest expense on the payment schedule.

Page Used to Run the Lease Expense Schedule Process

<i>Page Name</i>	<i>Definition Name</i>	<i>Usage</i>
<u>Create Expense Schedule Page</u>	LEASE_SCHED2_RQST	Run the lease expense schedule process.

Create Expense Schedule Page

Use the Lease Expense Schedule page (LEASE_SCHED2_RQST) to run the lease expense schedule process.

Navigation:

Asset Management > Asset Transactions > Leased Assets > Create Expense Schedule > Create Expense Schedule

This example illustrates the fields and controls on the Create Expense Schedule page. You can find definitions for the fields and controls later on this page.

Create Expense Schedule

Run Control ID Jobs Report Manager Process Monitor Run

Request Details ?

User ID

Request ID

'Unit

Process Frequency

Once

Always

Don't Run

Options ?

Select Open Trans Range

Select Asset Range

<i>Field or Control</i>	<i>Description</i>
Select Open Trans Range (select open transaction range)	If you select this option, use the From Open Trans and To Open Trans fields to select a range of transaction values.
Select Asset Range	If you select this option, use the From Asset and To Asset fields to select the asset range.

Integrating Lease Payments with PeopleSoft Payables

This topic discusses how to integrate Lease payments with PeopleSoft Payables.

Page Used to Integrate Asset Management Lease Payments with PeopleSoft Payables

<i>Page Name</i>	<i>Definition Name</i>	<i>Usage</i>
Asset Management Definition - Interface Options Page	BUS_UNIT_INTFC_OPT	Enable the Asset Management lease payment integration with PeopleSoft Payables for a business unit.
Payables Integration Page	ASSET_LEASE_07	Select Payables integration information by asset for each scheduled payment.
Review Payments Page	LEASE_INTFC_REVW	Review lease payment information and payment status for scheduled or processed lease payments to Payables.

Page Name	Definition Name	Usage
<u>Approve Payments Page</u>	LEASE_INTFC_APPR	Review and approve lease payments that are scheduled to interface with Payables (if the pre-approval option is not enabled for the business unit).
<u>Lease Payments to Payables Page</u>	AMAPLEAPMT_RQST	Run the Lease Payments to Payables (AMAPLEASE) Application Engine process.
<u>AP/AM Payment Reconciliation Page</u>	AMAPLEAPMT_RQST	Run the AP/AM Payment Reconciliation report

Asset Management Definition - Interface Options Page

Use the Asset Management Definition - Interface Options page (BUS_UNIT_INTFC_OPT) to enable the Asset Management lease payment integration with PeopleSoft Payables for a business unit.

Navigation:

Set Up Financials/Supply Chain > Business Unit Related > Asset Management > Asset Management Definition > Interface Options

This example illustrates the fields and controls on the Interface Options page (1 of 2). You can find definitions for the fields and controls later on this page.

This example illustrates the fields and controls on the Interface Options page (2 of 2). You can find definitions for the fields and controls later on this page.

The screenshot displays the 'Interface Options' page with the following sections and controls:

- Work Order Management Options:** A list of five unchecked checkboxes: 'Retire Assets Components', 'TRF Out Components for Reuse', 'Transfer In Components', 'Copy PM Schedules', and 'Override other Defaults'.
- GIS Integration:** A single unchecked checkbox labeled 'GIS Integration Enabled'.
- Accounting Definition:** A text field for 'Accounting Definition Name' containing the value 'AMDEFN' and a search icon.
- Asset Tracking Options:** A row of controls including a checked checkbox for 'Enable Mobile Inventory', an unchecked checkbox for 'Mask Scanned Tag', and two empty text fields for 'Prefix' and 'Suffix'.
- Interface Approval Default:** A row of three checked checkboxes: 'Payables', 'Purchasing', and 'Projects'.

At the bottom of the page, there are several buttons: 'Save' (green), 'Return to Search', 'Notify', 'Previous tab', 'Next tab', 'Refresh', 'Add', and 'Update/Display'.

The lease payment integration sends to Payables the information that is stored in the book that is defined as the Lease Book on the AM Business Unit Definition page.

Enable the lease payment integration for the business unit by selecting the **Lease Interface Processing** check box. Additionally, select whether to auto approve vouchers and enter the default Payables business unit on the Interface Options page.

Enter a value for the Accounting Definition Name field for the selected business unit. This field provides a default value for the Accounting Definition Name field on the:

- Pending Journal Generator page (AM WorkCenter)
- Create Accounting Entries page
- Close Depreciation page

The Accounting Definition Name field is optional for the Create Accounting Entries and Close Depreciation pages, but *required* for the Pending Journal Generator page in the AM WorkCenter. The Pending by Business Unit grid requires this default value and Journal Generator cannot be run from the page without it.

See “Interface Options Page” (Asset Lifecycle Management Fundamentals).

Setting Up Clearing Accounts

Set up Lease Obligation Contra and Lease Interest Contra accounts as clearing accounts. Both accounts are credited in Asset Management and debited subsequently during the voucher posting process in Payables. The following table presents an example of lease payment entries within the respective applications using the LPY accounting entry template:

<i>Application</i>	<i>Account</i>	<i>Debit</i>	<i>Credit</i>	<i>Distribution Type</i>
Asset Management	Lease Obligation	950		LO
Asset Management	Lease Obligation Contra		(950)	LP
Asset Management	Lease Interest Expense	50		LI
Asset Management	Lease Interest Contra		(50)	LC
Payables	Lease Obligation Contra	950		
Payables	Lease Payable		(950)	
Payables	Lease Interest Contra	50		
Payables	Lease Payable		(50)	

See “Accounting Entry Templates Page” (Asset Lifecycle Management Fundamentals).

Payables Integration Page

Use the Payables Integration page (ASSET_LEASE_07) to select Payables integration information by asset for each scheduled payment.

Navigation:

Asset Management > Asset Transactions > Leased Assets > Express Add > Payables Integration

or

Asset Management > Asset Transactions > Leased Assets > Update Lease Information > Payables Integration

This example illustrates the fields and controls on the Payables Integration page. You can find definitions for the fields and controls later on this page.

Definition		Cost		Step Lease Payment		Operating Chartfields		Payment Schedule		Payables Integration	
Unit		US001		Asset ID		000000000100		L01		Status: In Service	
Lease Book		CORP		Corporate		Currency		USD			
Payment Schedule ?										Personalize Find First 1-3 of 3 Last	
Line	Payment Date	Payment Total	Currency	Payables Integration	AP Business Unit	Voucher ID	Invoice Number	Payment Status			
1	01/01/2009	111.00	USD	<input checked="" type="checkbox"/>	US001	NEXT	V01	Approved-Auto			
2	01/01/2010	111.00	USD	<input checked="" type="checkbox"/>	US001	NEXT	V02	Approved-Auto			
3		0.00	USD	<input checked="" type="checkbox"/>	US001	NEXT		Approved-Auto			

Field or Control	Description
Payment Date	The default payment dates are populated from the Payment Schedule page. You can update the payment dates as needed.
Payment Total	Displays the payment amounts that are established on the Payment Schedule page. This field is not editable.
Payables Integration	Select only those lines that you want to forward to Payables for payment. If a line is not selected, then the other fields are not editable. By default, this check box is selected for every line for which the business unit has been enabled for integration with Payables.
AP Business Unit	Displays the default Payables business unit from the business unit level (Interface Options page). You can enter a different business unit (there are some cases where multiple Payables business units pertain to the same AM business unit).
Voucher ID	Displays the PeopleSoft Payables voucher ID once the transaction has been processed by the integration and Payables has created the voucher.
Invoice Number	(Optional) Enter the invoice number to appear in the Payables voucher.

Field or Control	Description
Payment Status	<p>Displays the integration status. Valid values for this field are:</p> <ul style="list-style-type: none"> • <i>Approved-Auto</i> - Initial status when the Auto Approve check box is selected at the business unit level (Interface Options page). Transaction has not yet been processed. • <i>Pending Approval</i> - Initial status when the Auto Approve check box is not selected at the business unit level (Interface Options page). Transactions with this status must be approved before processing. • <i>Approved</i> - Transaction is approved and ready for integration processing to Payables. • <i>Error</i> - Transaction did not process successfully. • <i>In Process</i> - Transaction is currently being processed by the integration to Payables. • <i>On Hold</i> - Transaction has intentionally been detained from processing to Payables. • <i>Processed</i> - Transaction has been successfully processed through the integration to Payables and the voucher has been created. • <i>Sent to AP</i> - Transaction has been successfully processed through the integration to Payables. • <i>Cancelled</i> - Transaction has been intentionally omitted from processing. This is for tracking purposes since deselecting the Payables Integration check box produces the same outcome. <p>When a transaction is approved or processed through the integration, the transaction line is no longer editable. All fields are unavailable except the Voucher ID field, which becomes link to the corresponding voucher within PeopleSoft Payables. The voucher information is access through a new window.</p>

Review Payments Page

Use the Review Payments page (LEASE_INTFC_REVW) to review lease payment information and payment status for scheduled or processed lease payments to Payables.

Navigation:

Asset Management > Send/Receive Information > Approve Lease Information > Review Lease Payments

This example illustrates the fields and controls on the Review Payments page. You can find definitions for the fields and controls later on this page.

Review Payments

Business Unit

From Asset ID

From Payment Date

Profile ID

To Asset ID

To Payment Date

Payment Status

Payments for Approval									
Asset Identification	Payment Status	Payment Date	Payment Total	Currency	Interest Expense	Obligation Reduction	Payables Integration	AP Unit	
1 000000000100	Approved-Auto	01/01/2009	111.00	USD	4.31	106.69	<input checked="" type="checkbox"/>	US001	
2 000000000100	Approved-Auto	01/01/2010	111.00	USD	2.18	108.82	<input checked="" type="checkbox"/>	US001	
3 000000000101	Processed	01/01/2009	222.00	USD	12.80	209.20	<input checked="" type="checkbox"/>	US001	
4 000000000101	Processed	01/01/2010	222.00	USD	8.62	213.38	<input checked="" type="checkbox"/>	US002	
5 000000000101	Processed	01/01/2011	222.00	USD	4.36	217.64	<input checked="" type="checkbox"/>	US001	
6 000000000101	Approved-Auto	01/01/2011	-222.00	USD	-4.36	-217.64	<input checked="" type="checkbox"/>	US001	
7 000000000102	Processed	01/01/2008	123.00	USD	2.43	120.57	<input checked="" type="checkbox"/>	US001	
8 000000000102	Processed	02/01/2008	123.00	USD	2.23	120.77	<input checked="" type="checkbox"/>	US002	
9 000000000102	Processed	03/01/2008	123.00	USD	2.03	120.97	<input checked="" type="checkbox"/>	US001	
10 000000000102	On Hold	04/01/2008	123.00	USD	1.83	121.17	<input checked="" type="checkbox"/>	FRA01	
11 000000000102	Processed	05/01/2008	123.00	USD	1.63	121.37	<input checked="" type="checkbox"/>	US001	
12 000000000102	Processed	06/01/2008	123.00	USD	1.43	121.57	<input checked="" type="checkbox"/>	US002	
13 000000000102	Pending Approval	07/01/2008	123.00	USD	1.22	121.78	<input checked="" type="checkbox"/>	US001	
14 000000000102	Processed	08/01/2008	123.00	USD	1.02	121.98	<input checked="" type="checkbox"/>	US001	
15 000000000102	Canceled	09/01/2008	123.00	USD	0.82	122.18	<input checked="" type="checkbox"/>	US001	

Use the Review Payments page to review the integration status of the lease payments, select or deselect to send payments through the Payables Integration process and change the Payables business unit, if needed, for payments that are not yet approved or processed.

Select the desired parameters and click the Search button to retrieve payments for review.

Field or Control	Description
Asset Identification	Displays the asset ID for the lease payment based on the criteria that you provide.
Payment Status	Displays the payment status. See Payables Integration Page .
Payables Integration	Select those lines that you want to forward to Payables for payment. If a line is deselected, then the other fields are not editable. By default, this check box is selected for every line for which the business unit has been enabled for integration with Payables.
AP Unit	Select a different Payables business unit for a transaction, if necessary, and save the page.

Approve Payments Page

Use the Approve Payments page (LEASE_INTFC_APPR) to review and approve lease payments that are scheduled to interface with Payables (if the pre-approval option is not enabled for the business unit).

Navigation:

Asset Management > Send/Receive Information > Approve Lease Information > Approve Payments

This example illustrates the fields and controls on the Approve Payments page. You can find definitions for the fields and controls later on this page.

Approve Payments

Business Unit

From Asset ID To Asset ID

From Payment Date To Payment Date

Profile ID Payment Status

Payments for Approval Personalize | Find | First 1-12 of 12 Last

Asset Identification	Payment Status	Payment Date	Payment Total	Currency	Interest Expense	Obligation Reduction	Payables Integration	AP Unit
1 000000000100	Approved-Auto	01/01/2009	111.00	USD	4.31	106.69	<input checked="" type="checkbox"/>	US001
2 000000000100	Approved-Auto	01/01/2010	111.00	USD	2.18	108.82	<input checked="" type="checkbox"/>	US001
3 000000000101	Approved-Auto	01/01/2011	-222.00	USD	-4.36	-217.64	<input checked="" type="checkbox"/>	US001
4 000000000102	On Hold	04/01/2008	123.00	USD	1.83	121.17	<input checked="" type="checkbox"/>	FRA01
5 000000000102	Pending Approval	07/01/2008	123.00	USD	1.22	121.78	<input checked="" type="checkbox"/>	US001
6 000000000102	Canceled	09/01/2008	123.00	USD	0.82	122.18	<input checked="" type="checkbox"/>	US001
7 000000000102	Error	11/01/2008	123.00	USD	0.41	122.59	<input checked="" type="checkbox"/>	US001
8 000000000103	Approved-Auto	01/01/2010	-999.00	USD		-999.00	<input checked="" type="checkbox"/>	US001
9 000000000103	Approved-Auto	01/01/2011	-999.00	USD		-999.00	<input checked="" type="checkbox"/>	US002
10 000000000103	Approved-Auto	01/01/2012	-999.00	USD		-999.00	<input checked="" type="checkbox"/>	US001
11 000000000104	Approved-Auto	03/01/2008	-12000.00	USD	-235.29	-11764.71	<input checked="" type="checkbox"/>	US001
12 000000000104	Approved-Auto	03/01/2008	12000.00	USD	235.29	11764.71	<input checked="" type="checkbox"/>	US001

Use the Approve Payments page (LEASE_INTFC_APPR) to review and approve lease payments that are scheduled to interface with Payables (if the pre-approval option is not enabled for the business unit).

Use the Approve Payments page to review, approve, or change the payment status of the lease payments. This page is similar to the Review Payments page except that you can change the payment status on this page.

Select the desired parameters and click the Search button to retrieve payments that are eligible for approval.

Field or Control	Description
Asset Identification	Displays the asset ID for the lease payment based on the criteria that you provide.
Payment Status	Displays the current payment status. Select to approve or change the current payment status of the lease payment.

Field or Control	Description
Payables Integration	Override the current payables integration selection. Select lines that you want to forward to Payables for payment. Deselect to keep a transaction from being sent through the integration process. Once deselected, the payment will not show up again in a future search.
AP Unit	Override the Payables business unit for a transaction, if necessary, and save the page.

Lease Payments to Payables Page

Use the Lease Payments to Payables page (AMAPLEAPMT_RQST) to run the Lease Payments to Payables (AMAPLEASE) Application Engine process.

Navigation:

Asset Management > Send/Receive Information > Load Interface > Lease Payments to Payables

This example illustrates the fields and controls on the Lease Payments to Payables. You can find definitions for the fields and controls later on this page.

The screenshot shows the 'Lease Payments to Payables' page interface. At the top, there are navigation links for 'Run Control ID', 'tst', 'Report Manager', 'Process Monitor', and a 'Run' button. Below this is a 'Request' section with a search icon and 'Find | View All' options. The main area contains several input fields: 'Request ID' (value: 1), 'Business Unit' (value: US001), 'Profile ID', 'From Payment Date', 'To Payment Date' (value: 12/31/2012), 'From Asset ID', and 'To Asset ID'. A 'Process Frequency' dropdown is set to 'Always'. At the bottom, there is a 'Parameters' section with an 'Invoice Date' field (value: 12/17/2012).

Run the Lease Payments to Payables (AMAPLEASE) Application Engine process. Select the criteria for the lease payments to process for the integration.

This process populates the voucher build integration tables with the necessary information for Payables processing. Payables then continues to process the lease payments from the voucher build staging tables to create the corresponding vouchers. When the vouchers are generated, Payables inserts the voucher ID

and line number into the Asset Management records. The lease payment information is reflected in the asset-related fields at the distribution level.

The lease ID is displayed on the Invoice Information page within Payables.

See [Integrating Lease Payments with PeopleSoft Payables](#) “Entering Invoice Information for Online Vouchers” (PeopleSoft Payables).

Note: To avoid the potential risk of resending these payments to Asset Management as adjustments to existing assets, Payables assigns a unique origin source for vouchers that are created from the lease payment integration with Asset Management.

<i>Field or Control</i>	<i>Description</i>
Business Unit	Select the Asset Management business unit from which to process payments. The default value is the business unit that is specified within user preferences.
Profile ID	(Optional). Select to limit integration processing to a specific profile. Only profiles that are associated with leased assets are available.
Invoice Date	Select the date to be displayed on the Payables voucher. If blank, the system supplies the default system date.

AP/AM Payment Reconciliation Page

Use the AP/AM Payment Reconciliation page (AMAPLEAPMT_RQST) to run the AP/AM Payment Reconciliation report.

Navigation:

Asset Management > Financial Reports > Leased Assets > AP/AM Payment Reconciliation > AP/AM Payment Reconciliation

This example illustrates the fields and controls on the AP/AM Payment Reconciliation run control page. You can find definitions for the fields and controls later on this page.

AP/AM Payment Reconciliation

Run Control ID US001
Report Manager
Process Monitor
Run

Language English ▼

Report Request Parameters

Business Unit 🔍

AP Business Unit 🔍

From Date 📅

Through Date 📅

Run the AP/AM Payment Reconciliation (AMAP1001) report. The reconciliation process compares information about the lease payments from the Asset Management tables with the voucher information that is stored in the Payables tables. The resulting report includes the Asset Management lease payment schedule with payment statuses along with the corresponding Payables voucher information, such as voucher ID, invoice date, payment amount, voucher status and payment status.

Field or Control	Description
Business Unit	Select the Asset Management business unit for which to process the reconciliation report. You can select from the business units for which the integration is enabled.
AP Business Unit	(Optional). Select the Payables business unit for which to process the reconciliation report information.
From Date and Through Date	(Optional). Select the date range for which to run the reconciliation report.

Transferring Operating Leases

This topic describes how to transfer an operating lease.

Page Used to Transfer Operating Leases

Page Name	Definition Name	Usage
<u>Operating Lease Chartfields Page</u>	LEASE_OPER_TFR_01	Transfer an operating lease, for example, from one department to another.

Operating Lease Chartfields Page

Use the Operating Lease Chartfields page (LEASE_OPER_TFR_01) to transfer an operating lease, for example, from one department to another.

Navigation:

Asset Management > Asset Transactions > Leased Assets > Transfer Operating Lease > Operating Lease Chartfields

This example illustrates the fields and controls on the Operating Lease Chartfields page. You can find definitions for the fields and controls later on this page.

The screenshot displays the 'Operating Lease Chartfields' page. At the top, it shows 'Unit US001', 'Asset ID 000000000097', 'Sample data for Oper Lease', 'Tag', and 'In Service'. Below this, there are two main sections: 'Current Chartfields' and 'New Chartfields'. Each section has a 'Chartfields' button and navigation options like 'Personalize', 'Find', 'View All', 'First', '1 of 1', and 'Last'. The 'Current Chartfields' table has columns for Trans Date, Operating Unit, Fund Code, Department, Program Code, Class Field, Budget Reference, Product, Project, and Category. A row is shown with Trans Date 12/14/2003 and Department 12000, with Category LCOMP. The 'New Chartfields' section has a similar table with search icons for each field. At the bottom, there is an 'Edit Trans Dates...' button.

This page displays the current ChartFields for the lease.

Use the **New Chartfields** section to change the **Oper Unit**(operating unit), **Fund Code**, **Department**, **Program**, **Class Field**, **Budget Reference**, **Product**, **Project**,and **Category**. The **Category** field is required for an operating lease.

Click the **Edit Trans Dates** button to change the transaction date.

Note: Financial transactions cannot be performed on the Lease Administration Lease Assets through Asset Management.

Retiring or Reinstating Leases

Leased assets are retired or retired and reinstated using the same processes as all other assets. Review those sections of this product documentation for more information.

Related Links

[Understanding Asset Retirement](#)

Generating Lease Reports

PeopleSoft Asset Management has several reports that you can use to view information about leases that is required to satisfy generally accepted accounting principles (GAAP) and to comply with FAS 13. You can use the lease reports provided to view when a lease expires, create an annual footnote disclosure report, view summary or detail information about a specific lease, or view a lease amortization schedule.

You may also review operating leases.

You must run the Lease Expense Schedule (LEASE_SCHED2) process before you run a lease report.

This topic discusses Lease reports.

Note: PeopleSoft IT Asset Management also provides a report called **Lease End Date**.

Pages Used to Generate Lease Reports

<i>Page Name</i>	<i>Definition Name</i>	<i>Usage</i>
Lease Expiration	RUN_AMLE2400	Define the run parameters for the Lease Expiration report (AMLE2400). Use the report to list leases that expire as of today's date, after a certain number of days from a specified date, or within a date range that you select.
Lease Footnote Disclosure	RUN_AMLE2300 RUN_AMLE2310	Define the run parameters for a Lease Footnote Disclosure Detail and Lease Footnote Disclosure Summary reports (AMLE2300 and AMLE2310, respectively). Use at the end of each fiscal year to view all outstanding capital and operating lease commitments for the next five years. The report also provides the monthly lease payment and yearly totals.
Lease Information	RUN_AMLE2000	Define the run parameters for the following reports: <ul style="list-style-type: none"> Lease Summary Information (AMLE2000) Lease Detail Information (AMLE2100) Detail Amortization Schedule (AMLE2200)
AP/AM Payment Reconciliation	AMAPLEAPMT_RQST	Run the AP/AM Payment Reconciliation report

Adjusting, Transferring, Reversing, and Evaluating Assets

Understanding Adjusting, Transferring, Reversing, and Evaluating Assets

Periodically, it is necessary to make changes to asset records to correct errors or add newly received information. You can modify any information that has been entered about assets, including cost, market value, quantity, depreciation rules, location, physical attributes, and so on.

Sometimes adjustment and transfer changes have a financial or tax impact. Changes to physical information about an asset, such as its weight, do not affect cost or depreciation. However, changing quantity, cost, depreciation attributes, or department affect your financial and tax books.

In compliance with accounting standards, many companies must carry assets at fair value. As a result, frequent revaluation of assets may be necessary, depending on requirements. PeopleSoft Asset Management provides a revaluation worksheet to facilitate potentially frequent revaluation of one or multiple assets using the Cost Based or Depreciation Write-off methods of revaluation. Additionally, you have the option of using the Revaluation en Masse process where the Net Method of revaluation is available, as well as the other two methods. These tools provide the capability to properly deal with the depreciation distribution between original cost and revalued basis

You must also be able to undertake an effective impairment test cycle for assets on at least an annual cycle at the balance sheet date depending on business industry and location. PeopleSoft Asset Management provides an impairment evaluation process that allows you to assess potential impairment of user-defined asset selections. The impairment worksheet enables you to enter recoverable amounts and automatically calculates potential impairment losses. Subsequent to this review, the impairment worksheet generates the associated accounting entries to enable you to recognize these adjustments in your accounting system. This process eliminates manual steps and minimizes accounting errors.

PeopleSoft supports the ability to maintain asset histories. Information on a per-asset basis is available within each record. Cost summary reporting and asset component hierarchy history reporting are both also available.

When necessary, you can also reverse erroneous asset transactions using the Transaction Reversal feature. The Transaction Reversal feature automatically reverses the transaction last performed on the asset and provides a clear audit trail of each reversal.

See:

[Understanding Cost Adjustments and Asset Transfers](#)

[Page Used to Revalue Assets Using the Revaluation Worksheet](#)

[Page Used to Revalue Assets En Masse](#)

[Pages Used to Modify or Delete Pending Asset Transactions](#)

[Pages Used to Make Impairment Adjustments](#)

[Understanding Transaction Reversals](#)

Adjusting Cost and Transferring Assets

This topic provides an overview of cost adjustments and asset transfers.

Pages Used to Adjust Cost and Transfer Assets

Page Name	Definition Name	Usage
Main Transaction Page	ASSET_COST_01	Identify the cost/adjust/transfer transaction that you want to perform.
Cost Information Page	ASSET_COST_01A	Enter or adjust cost information that is required by the transaction that you initiated from the Main Transaction page.
Asset Location Transfer Page	ASSET_COST_02_S2	Change the location for an asset. See Cost Information Page
Asset Cost IU Transfer Page	ASSET_COST_02	Select the asset information that you want transferred with the asset. The link appears on the page only after you select <i>Fixed Price Markup</i> as the action on the Main Transaction page. Cost Information Page
Asset Cost IU Book Transfer page	ASSET_COST_02_S1	Specify how cost information for the transfer will be passed between business books. This link appears when you have selected <i>InterUnit Transfer</i> as the action on the Main Transaction page <i>and</i> when you have entered the business unit to transfer to.
InterUnit Proceeds page	N/A	Apply a markup or markdown to the asset that you are transferring.
Child Assets Page	CHILD_ASSETS	Select child assets to include in the transfer or recategorization that you have initiated against the parent assets.

Page Name	Definition Name	Usage
Child Asset TRF/RCT Overrides Page	AM_PARCHD_TRF_RCT	Specify transaction overrides for a specific child asset. You can specify specific convention, quantity, cost, transaction percentage, transaction date and accounting date for the child asset on this page.
Parent Asset Advanced Transaction Details Page	FULL_PART_SEC	Specify transaction overrides for all child assets at once.
Update Asset Profile Page	ASSET_PROFILE_SEC	Enter a new asset reporting profile ID when you recategorize an asset.

Related Links

[Creating Parent-Child Asset Relationships](#)

Understanding Cost Adjustments and Asset Transfers

To adjust cost and transfer assets:

- Select the type of transaction, enter accounting and transaction dates, and specify the transaction data that is required to update the general ledger.
- Make the actual adjustments or cost entries.
- Select some, none, or all child assets to include in the transaction that you are performing. The Child Assets page appears only when the asset you are transacting against is a parent asset and the transaction type is a transfer. A separate Application Engine process is provided for transferring parent-child assets between business units.

Note: Adjustments to parents do not automatically filter down to the child assets; therefore, the Child Asset page does not appear for adjustments. Instead, add another child asset. A reminder message will appear stating that child assets are associated with the parent asset that you are adjusting.

- Use the Pending Transaction page for workflow processing.
- If you have changed information in a book that posts to your general ledger, PeopleSoft Asset Management generates the appropriate accounting entries when you run Create Accounting Entries (AM_AMAEDIST) or Depreciation Close (AM_DPDCLOSE). The asset account is updated when you generate and post the journal entries.

Note: Financial transactions cannot be performed on the Lease Administration Lease Assets through Asset Management.

Related Links

[“Defining Accounting Entries” \(Asset Lifecycle Management Fundamentals\)](#)

Understanding Federal Funds Transfers

When transferring an asset from one federal fund to another, Treasury rules require that you generate the appropriate federal funds transfer accounting entries as documented in the United States Standard General Ledger (USSGL) transactions E510 and E606.

Public Law 101-5101 requires that upon cancellation of a Treasury Appropriation Fund Symbol (TAFS), any collectible account receivable is re-established in a miscellaneous receipt account. Upon collection, the funds are deposited to Treasury miscellaneous receipt account '3200' – Collections of Receivables from Canceled Accounts. The cancelled fund should no longer be transacted against or posted to the General Ledger per Federal regulations. However, assets can be transferred from the purchasing fund into a non-cancelling fund that is available for the same general purpose but still in the unexpired phase. Thus, when you transfer assets to/from a Federal fund, you must generate accounting entries for USSGL E510 and E606 in Asset Management as follows:

Federal Funds Transfer Out		Federal Funds Transfer In	
DR	5730	DR	Asset Account
CR	Asset Account	CR	5720

The following table indicates when a Federal funds transfer account should be used:

From Fund	To Fund	Federal Funds Transfer Out Account Used	Federal Funds Transfer In Account Used
Federal	Federal	Yes	Yes
Federal	Non-Federal	Yes	No
Non-Federal	Federal	No	Yes
Non-Federal	Non-Federal	No	No

To set up and process Federal funds transfers:

1. Use the Installation Options - Asset Management page to create a Federal fund attribute, which will be used to set up chartfield attributes on the ChartField Attribute page and specify whether a fund is Federal.

See “Setting Up Application-Specific Installation Options” (Application Fundamentals)

2. Use the ChartField Attribute page to set up Federal fund indicators.

See “Defining and Using Account Types and Attributes” (Application Fundamentals)

3. Use the ChartField Values - ChartField Attributes page to attach the Federal fund attribute to a fund.

See “Defining and Using Account Types and Attributes” (Application Fundamentals)

- On the Accounting Entry Template IDs page, select the Federal Fund check box to enable Federal funds transfer distribution types on the Accounting Entry Templates page.

See “Defining Accounting Entries” (Asset Lifecycle Management Fundamentals)

- Use the Accounting Entry Templates page to associate accounts with the Federal Fund Transfer accounting entry.

See “Defining Accounting Entries” (Asset Lifecycle Management Fundamentals)

- Use the Main Transaction page to transfer the asset.

See [Main Transaction Page](#)

- Use the Create Accounting Entries run control page to generate accounting entries from the Federal Fund Transfer accounting entries.

See [Create Accounting Entries Page](#)

The following is an example of generated Federal fund transfer accounting entries as viewed from the Review Financial Entries page:

Example of generated Federal fund transfer accounting entries

Acctg Date	Trans Type	Account	Alternate Account	Base DR Amount	Base CR Amount	Detail
1 01/10/2014	ADD	100001		36,000.00		Detail
2 01/10/2014	ADD	100003			36,000.00	Detail
3 01/10/2014	ADD	8801			36,000.00	Detail
4 01/10/2014	ADD	8803		36,000.00		Detail
5 07/10/2014	TRF	100001			36,000.00	Detail
6 07/31/2014	TRF	100002		6,000.00		Detail
7 07/31/2014	TRF	200000		30,000.00		Detail
8 07/10/2014	TRF	8801		36,000.00		Detail
9 07/10/2014	TRF	8803			36,000.00	Detail
10 07/10/2014	TRF	100001		36,000.00		Detail
11 07/31/2014	TRF	100002			6,000.00	Detail
12 07/31/2014	TRF	200000			30,000.00	Detail
13 07/10/2014	TRF	8801			36,000.00	Detail
14 07/10/2014	TRF	8803		36,000.00		Detail

Main Transaction Page

Use the Main Transaction page (ASSET_COST_01) to identify the cost/adjust/transfer transaction that you want to perform.

Navigation:

Asset Management > Asset Transactions > Financial Transactions > Cost Adjust/Transfer Asset > Main Transaction

This example illustrates the fields and controls on the Main Transaction page. You can find definitions for the fields and controls later on this page.

Field or Control	Description
Transaction Date and Accounting Date	Displays the current date or the dates that are specified as operator defaults. As a rule, transactions are entered in PeopleSoft Asset Management some time after they have occurred. Any difference between accounting and transaction dates will affect depreciation as well as posting. See Adding and Maintaining Asset Information .
Transaction Code	(Optional) Select a code to help identify which accounting entry template to use for this transaction.
Rate Type	Enter the currency exchange rate type to use for this transaction.
Copy Changes to Other Books	Select to copy the changes that you make to other books.
Transfer Other Books by	Select to transfer the changes that you make to other books by <i>Amount</i> or <i>Percent</i> .

Field or Control	Description
Adjust Other Books by	<p>Select to adjust the other books by <i>Amount</i> or <i>Percent</i>.</p> <p>Select <i>Percent</i> to transfer a percentage of the amount from subsequent books. For example, suppose you have an asset with two books, Corporate and Federal. The cost amount for Corporate is 5000.00 USD and is 4000.00 USD for Federal.</p> <p>If you transfer 2500.00 USD from the Corporate book, select Copy Changes to Other Books, and then specify the <i>Percent</i> option. 2500.00 USD will be transferred from the Corporate book and 2000.00 USD will be transferred from the Federal book.</p> <p>If you select <i>Amount</i>, a transfer of 2500.00 USD from both books will occur.</p> <p>If you have a multicurrency business unit, the <i>Amount</i> option will be overridden by <i>Percent</i> when you transfer or recategorize an asset.</p> <hr/> <p>Note: If you do not select the Copy Changes to Other Books option, when the book that you are changing is associated with a ledger group that contains multiple ledgers, and the Keep Ledgers In Sync check box is selected for the ledger group, changes will be copied to other books that associated with the same ledger.</p> <hr/>
Include Convention	<p>The options are to <i>Exclude</i> or <i>Include</i> a depreciation convention. The depreciation convention automatically displays <i>AM</i> (actual month) for all transactions (except for Adjustments, which invokes the convention specifically defined for adjustments.) If you choose to have the convention included, the convention will be copied to all books. If you choose to have the convention excluded, the convention will not be copied to all books. You can override each book separately at the transaction level also.</p>

Field or Control	Description
Action	<p>Select the financial transaction to be performed. Select an action and click the GO! button:</p> <ul style="list-style-type: none"> • <i>Addition:</i> Adds an adjustment cost line with transaction type of <i>ADD</i> as a result of alternate or multiple funding sources, and so on. This option works the same as <i>Adjustment</i>, except that the transaction type in the cost table will be <i>ADD</i> instead of <i>ADJ</i>. If you use multiple currencies to track asset transactions, access to Transaction Currency fields for Adjust All Rows and Adjust Current Row By are available. When you click Apply, these fields are unavailable for entry. The transaction cost is converted to the base cost and added to the total cost of the asset. Exchange rates cannot be viewed from this component. • <i>Adjustment:</i> Adjusts the cost or quantity of an existing row and adds a line with a transaction type of <i>ADJ</i>. If you use multiple currencies to track asset transactions, access to Transaction Currency fields for Adjust All Rows and Adjust Current Row By are available in this activity. When you click Apply, these fields are unavailable for entry. The transaction cost is converted to the base cost and added to the total cost of the asset. Exchange rates cannot be viewed from this component. • <i>Fixed Price Markup:</i> Applies a markup to the asset that you are transferring. Transaction Currency fields are unavailable for enter for this activity. • <i>InterUnit Transfer:</i> Transfers an asset from one business unit to another with different legal entities. Transaction Currency fields are unavailable for entry for this activity. You can also perform InterUnit transfers from regular assets to a group asset ID. • <i>Recategorize:</i> Changes an asset category or cost type. Asset Categories classify assets by type for accounting entry purposes. Transaction Currency fields are unavailable for entry for this activity. • <i>Revaluation:</i> Revalues an asset by percentage. Revaluation occurs as a result of a monetary revaluation or to account for inflation and is prescribed by a governmental entity. This value is used mostly in countries with high rates of inflation. Transaction Currency fields are unavailable for entry for this activity. <hr/> <p>Note: Revaluation from this page is based upon the Cost of the assets disregarding the current Net Book Value, current Fair Value and any prior Impairment made to the asset. For example, a revaluation adjustment of 15,000 USD means an increment in the asset's cost of that amount using the Cost type indicated for revaluation with no further calculations. If you want to calculate the revaluation considering the mentioned parameters, you must use the Revaluation Worksheet or the Revaluation en Masse process.</p>

Field or Control	Description
	<p>See:</p> <ul style="list-style-type: none"> Revaluating Assets Using the Revaluation Worksheet Revaluating Assets En Masse <i>Transfer</i>: Transfers an asset within the same business unit. For example, you can make a transfer between two departments or two operating units as an <i>intraunit</i> transaction as opposed to a transaction between two distinct and separate business units, or an <i>interunit</i> transaction. Transaction Currency fields are unavailable for this transaction.

Cost Information Page

Use the Cost Information page (ASSET_COST_01A) to enter or adjust cost information that is required by the transaction that you initiated from the Main Transaction page.

Navigation:

Click the **GO!** button on the Main Transaction page.

This example illustrates the fields and controls on the Cost Information page. You can find definitions for the fields and controls later on this page.

The screenshot displays the 'Cost Information' page for an asset. At the top, it shows 'Unit US001', 'Asset ID 00000000091', and 'Automobile'. Below this, there are tabs for 'Main Transaction' and 'Cost Information'. The 'Book' section shows 'Book Name CORP', 'Corporate', 'Base Currency USD', and 'Convention Actual Month'. The 'Edit Cost Information' section has fields for 'Adjust All Rows By', 'Percent', 'Quantity', 'Cost 100.00', and 'Curr USD'. The 'Chartfields' section includes a table with columns: Oper Unit, Fund, Dept, Program, Class, Bud Ref, Product, and Project. At the bottom, there is an 'Adjust Current Row By' field and an 'Apply' button.

The Cost Information page displays different fields and value options depending upon the action that you select before clicking the GO! button: addition, adjustment, recategorization, revaluation, or transfer activities.

Note: If you want to perform multiple transactions, complete one transaction, and then save and reenter the page to begin the next transaction. Doing so preserves the audit trail for each transaction.

Note: Transaction currency appears by default from the asset book base currency. Each line can reflect a different transaction currency, depending on the transaction. Balances are displayed in the base currency after the transaction currency is converted to the base currency.

Field or Control	Description
Update Asset Profile	<p>Click to access the Update Asset Profile Page and synchronize the reporting asset profile with the new asset category when you recategorize an asset.</p> <p>An update to the reporting asset profile ID alone does not change the asset book information or category. Profile updates after asset addition are for reporting purposes only.</p> <p>This field is only visible when you select <i>Recategorize</i> from the Action field on the Main Transaction page.</p> <p>See “Updating Asset Reporting Profile After Asset Recategorization” (Asset Lifecycle Management Fundamentals)</p>
Change Location	Click to change the asset's location.
Convention	<p>Convention appears by default as <i>Actual Month</i> for all transactions, with the exception of Adjustments, which has its own convention. If you selected the Copy Changes to Other Books check box on the Main Transaction page and selected <i>Exclude</i> in the Include Convention check box, the convention will not be copied to all books. You need to override each book separately.</p>
Cost History	Shows cost balance for the selected asset. You cannot update information here, but you can review cost rows and their associated ChartFields for an asset.

This documentation discusses the remaining fields on the Cost Information Page in the context of the transaction being performed. Some fields are available only for certain transactions.

Note: If the asset transactions that you want to adjust are still pending (depreciation has not yet been run), you may, depending on the transaction type, be able to delete or change them.

Cost History

Expand this group box to view cost history information.

The information displayed includes ChartField information, Salvage Value, Category and Cost Type.

Edit Cost Information

Add new cost rows in the **Edit Cost Information** group box.

<i>Field or Control</i>	<i>Description</i>
Cost, Percent, and Quantity	Enter as necessary, and enter additions and adjustments for any appropriate ChartFields.

Adjusting Total Cost or Quantity

You can adjust the total cost of an asset by either a percentage of its original cost or by a specific cost amount.

<i>Field or Control</i>	<i>Description</i>
Adjust All Rows By	<p>Enter the appropriate percentage or amount in the appropriate fields: Percent, Quantity, and Cost. The default is a positive adjustment. To make a negative adjustment, enter a negative percentage or amount. In a transaction, you can adjust the cost either by percent or cost, but not both.</p> <p>You can adjust the total quantity of an asset by entering the Quantity adjustment. The default is a positive adjustment. If you want to make a negative adjustment, you must enter a negative quantity.</p>
Apply	<p>Click to prorate the adjustment and add it to each cost row in cases of multi-ChartField asset. If the asset has one ChartField combination, the cost is added to the total cost. The system automatically calculates and displays the adjusted total cost. If the cost that is entered is in a different currency than the base currency of your book, the cost is converted to the base currency before the cost rows are adjusted.</p> <hr/> <p>Note: Changes are applied only to the current book unless you select the Copy Changes to All Books check box on the Main Transaction page. If you select this option, your changes will be visible after you save the page and then restart it.</p> <hr/> <p>Note: Currency for Adjust by Percent is the same as the base currency of the book. However, Currency for Adjust by Cost can be any valid value.</p> <hr/>

Adjusting Cost or Quantity by Cost Row

<i>Field or Control</i>	<i>Description</i>
Cost and Quantity	<p>To adjust the cost or quantity for a particular cost row, enter the new field values directly into the cost row. You can adjust an asset's cost for individual cost rows by entering the new cost into the Cost field for each cost row that you'd like to change. To adjust the quantity for individual cost rows, enter the new quantity into the cost rows, not the number of units by which quantity will increase or decrease.</p> <p>For example, if the quantity should be adjusted from 1 to 2, enter 2. This changes only the quantity, not the cost.</p> <hr/> <p>Note: To establish an audit trail, you should change cost information one field at a time. For example, if you need to change the department and adjust the cost, enter the new department and save your change, and then go back and adjust the cost.</p>
Apply	<p>Click to apply the adjustment to each cost row. The system automatically calculates and displays the adjusted total quantity.</p>

Adding and Viewing Comments

Click the Comments link to access the Cost Information - Comments page (AM_COMMENTS_SEC) and view or add relevant supporting comments to an asset transaction.

This example illustrates the fields and controls on the Cost Information - Comments page.

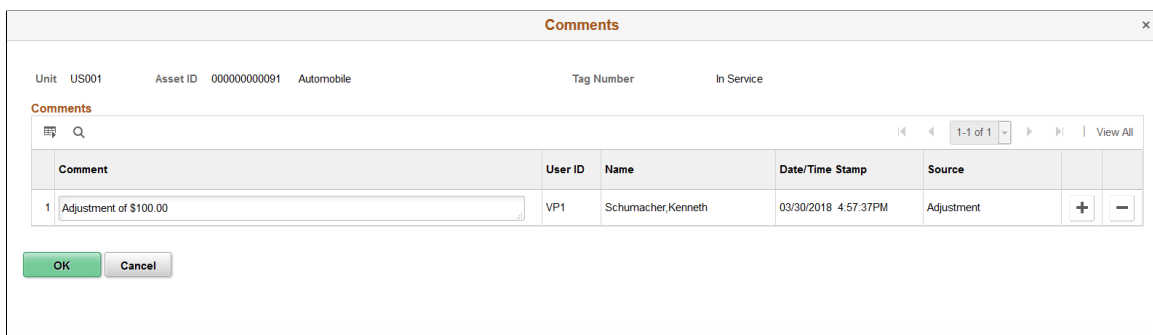

<i>Field or Control</i>	<i>Description</i>
Comment	Enter comments for an asset.

Field or Control	Description
User ID, Name and Date/Time Stamp	Displays the user ID, name, and date/time stamp related to the user who added the comment.
Source	Displays the transaction source for the asset, such as adjustment, transfer, and so forth.

Adding and Viewing Attachments

Click the Attachments link to access the Cost Information - Attachments page (AM_ADD_ATTACH_SEC) and view or add relevant supporting documents to an asset transaction.

This example illustrates the fields and controls on the Cost Information - Attachments page.



Field or Control	Description
Add Attachment	Click this button to attach files as supporting documentation for an asset. Supply a description of the file or files that you attach.
File Name	Displays the attached file. Click the file-link to access the file.
Description	Displays a description of the file attachment when one was provided by the user.
User, Name, and Date/Time Stamp	Displays the user ID, name, and date/time stamp related to the user who added the attachment.

Transferring Assets Within a Business Unit

Periodically, you need to transfer assets from one department, product, or project to another. In addition to physically relocating the assets, you may need to change some of the ChartField elements to correctly allocate asset cost and depreciation expense. You can perform full, partial, or retroactive transfers.

Note: This transaction describes transferring assets within a business unit.

See [Transferring Parent-Child Assets to Other Business Units \(Interunit Transfers\) In Mass.](#)

Full Transfers – Edit Cost Information

A full transfer requires you to transfer all units or the total cost of the asset.

<i>Field or Control</i>	<i>Description</i>
Oper Unit (operating unit), Dept (department), Program, Product , and Project (and any other delivered or customized Chartfield)	Enter the new values into the appropriate fields.

Partial Transfers – Edit Cost Information

Partial transfers are useful when you want to assign an asset's cost and depreciation to two or more sets of ChartFields. To partially transfer an asset, you need to perform a separate transfer for each set of ChartFields.

<i>Field or Control</i>	<i>Description</i>
Oper Unit (operating unit), Dept (department), Project , or Product (and any other delivered or customized Chartfield)	<p>For each transfer, select the appropriate ChartFields, and enter quantity and amount in the Edit Cost Information group box.</p> <p>For example, suppose department 43000 has two automobiles, worth a total of 60,000 JPY. You plan to transfer one car from department 43000 to 12000, and the other from department 43000 to 14000. Because the cost of the assets will eventually be allocated to two separate sets of ChartFields, you'll need to perform two separate transfers. Each transfer will move 30,000 JPY out of department 43000 and into departments 12000 and 14000.</p>

Retroactive Transfers

You may want to transfer assets retroactively if they were transferred during a prior accounting period, but are not yet entered in PeopleSoft Asset Management. To do this, enter the transaction and accounting dates on the Main Transaction page and enter the appropriate cost information in the Edit Cost Information group box. The system will create correcting entries that back out depreciation from the original department for the period between the transaction date and the accounting date. Prior period depreciation for that same period will be posted for the new department.

Recategorizing Assets – Edit Cost Information

You may want to recategorize assets either because you entered the incorrect category or cost type, or because you have created a new category or cost type and want to transfer existing assets to the new reclassification.

<i>Field or Control</i>	<i>Description</i>
Category and Cost Type	Change the values as needed. Recategorizing an asset affects depreciation.

Revaluing Assets

Revaluation as defined here is based upon the original cost of the asset without consideration of any prior impairment nor taking into account the fair value or net book value of the asset at the time of revaluation. For revaluation that includes these considerations, use the Revaluation Worksheet or the Revaluation en Masse process.

See:

[Revaluing Assets Using the Revaluation Worksheet](#), [Revaluing Assets En Masse](#).

<i>Field or Control</i>	<i>Description</i>
Cost Type	<p>To revalue assets, select an action of revaluation, which will change the cost type to <i>R</i>, and enter the appropriate percentage in the Adjust All Rows By Percent field. Click Apply. The system will create an adjustment cost line with cost type of <i>R</i>.</p> <hr/> <p>Note: This action is only available if the revaluation process is enabled at the Installation Options and Business Unit/Book levels. The cost type that is used here depends upon the cost type for revaluation that is established at the Business Unit/Book level. The cost type, <i>R</i>, is the default value.</p>

Note: Entering changes to cost information and transacting transfers, recategorizations and revaluations affect prior calculated depreciation and accounting entries. You must run both depreciation and accounting entry processing when you make these changes.

Transferring Assets to Other Business Units (Interunit Transfers)

PeopleSoft Asset Management gives you full flexibility in performing Interunit transfers. You can fully or partially transfer assets from one business unit to another, or from one business unit to many others. You can do full or partial transfers by cost, quantity, or percentage.

Note: You can perform interunit transfers from group assets to other group assets, group assets to regular assets and from regular assets to group assets.

Note: You cannot perform interunit transfers on joint venture business units. When you perform an interunit transfer of an ARO-enabled asset, you receive a warning that an ARO may have been recognized for this asset.

Interunit processing is performed through the PeopleSoft Centralized Inter/IntraUnit Processor. It provides consistent setup and centralized processing to manage Inter/Intraunit transactions.

The procedures for performing interunit transfers that are discussed in this section do not apply to parent-child assets. You do Interunit transfers for parent-child assets using the Parent-Child IU Transfer page (AM_PARCHD_IU application engine program).

Note: To transfer parent and child assets among business units in this application engine, you must set up the appropriate InterUnit Transfer Definitions.

In the **New Unit** field, select the business unit to which you are transferring the asset. The **New Asset ID** field is populated by default as *NEXT*. You can change this value if necessary. Do not enter an existing asset ID unless you want to transfer costs between the two assets.

Select a profile ID that is valid for the new business unit to set up book reporting. **Trans Code** (transaction code) identifies which accounting entry template to use for this transaction. Only valid combinations for accounting entry templates that exist are accepted.

Click the **InterUnit Transfer Options** link to access the InterUnit Transfer Options page, where you can select the asset information that you want transferred with the asset.

Click **Transfer From/To Books** link to access the Transfer From/To Books page where you specify the way in which cost information is passed between business unit books. This link displays after supplying the value in the **New Unit** field.

Select the **Remaining Life** check box to depreciate the transferred (ADD) asset through its remaining life. This check box is deselected by default, which allows the transferred (ADD) asset to calculate depreciation over its full useful life. The full useful life depends upon the selection of the Use Profile check box. If deselected, the useful life is derived from the source asset. If the Use Profile check box is selected, the useful life is derived from the target unit profile.

Use the fields in the **Edit Cost Information** group box to specify the cost and quantity to be transferred.

Select the **Use Profile** option to get profile attributes when **New Profile ID** has been enabled. If it is not enabled, the profile attributes are derived from the "from" or original asset profile. When using the capitalization threshold feature, the Use Profile option establishes which threshold is used for the new asset. If this check box is deselected, the system uses the anchor profile threshold. If the check box is selected, the system uses the threshold defined in the target profile.

Note: You can run the capitalization threshold validation in the new business unit if you want to validate the status again.

See [Capitalization Thresholds Page](#).

Click **Proceeds** to open the InterUnit Proceeds page, where you can specify a markup value to be applied to the transferred assets in the receiving business unit. This feature is often used in European countries.

You can perform full interunit transfers from one business unit to another, or from one business unit to many others. You can also perform a partial interunit transfer in which the original business unit retains a portion of the asset but transfers part of it to another business unit.

Note: When performing a partial interunit transfer when multiple ChartField combinations within the same book are involved, you must delete the entry or entries in the page for the ChartField combination that you do not want to transfer. Additionally, it is recommended that if you want to do a partial transfer to more than one business unit, you should do them separately.

Full Interunit Transfers from One Business Unit to Another

Full interunit transfers from one business unit to another are the simplest transfers to perform. After you have completed the information in the **Enter New Unit** group box and its pages and saved the Cost Information page, all cost rows are transferred to the new business unit.

Full Interunit Transfers from One to Many Business Units

You can transfer to as many business units as existing cost rows. To do this, enter one of the receiving business units in the **New Unit** field in the **Enter New Unit** group box. Complete the rest of the Interunit transfer information. Review each cost row in the **Edit Cost Information** group box. All cost rows will show the new business unit that you entered in the **New Unit** field. Change the business unit for each cost row as appropriate. In this way, you can transfer all cost rows for an asset to multiple business units.

Note: Transaction currency is supplied by default from the base currency of the book. Each line can reflect a different transaction currency depending on the transaction. Balances are displayed in the base currency after the transaction currency is converted to the base currency. The system allows interunit transfers across business units with different base currencies when using the TRANSFER action.

Partial Interunit Transfers

You can transfer part of an asset to a different business unit and enable the original business unit to retain a portion of it. To do this, enter the receiving business unit in the **New Unit** field in the **Enter New Unit** group box. Complete the rest of the Interunit transfer information. Review each cost row in the **Edit Cost Information** group box. All cost rows will show the new business unit that you entered in the **New Unit** field. To retain partial ownership of the asset with the original business unit, delete the entry or entries with the ChartField combination for which you do not want to transfer.

Accumulated Depreciation Adjustment for Group Assets

PeopleSoft estimates the NBV for Group Members when they are being transferred to a new business unit or being recategorized. This estimation of the accumulated depreciation amount is calculated in the Group Asset Depreciation Calculation process. You can, however, override the estimated calculation by clicking the **Accum Depr** button and supply your own accumulated depreciation value. When you select a member asset for *Fixed Price Markup*, *InterUnit Transfer*, *Recategorize*, or *Transfer*, the **Accum Depr** button appears on the Cost/Information page. When you click the button, you are prompted to enter the accumulated depreciation value.

Related Links

[Transferring Parent-Child Assets to Other Business Units \(Interunit Transfers\) In Mass](#)

Asset Cost IU Book Transfer page

Use the Asset Cost IU Book Transfer page (ASSET_COST_02_S1) to specify how cost information for the transfer will be passed between business books.

This link appears when you have selected InterUnit Transfer as the action on the Main Transaction page and when you have entered the business unit to transfer to.

Navigation:

Click the **Transfer To/From Books** link on the Cost Information page.

The transactions that are generated to pass book information for Interunit transfers differ depending on how many *To* books a *From* book is passing information to, and whether it is passing the information using a Transfer Book action or an Add Book action.

Note: Assets that you transfer to new business units using the Add Book action will have a cost row of zero on the new business unit until you run the Depreciation Calculation application engine program (AM_DEPR_CALC). Running this program updates the asset's cost row with its net book value from the From book.

Using a From Book Once

When you use a From book once only, an Add Book action generates a retirement for the From book and an add to the To book. A Transfer Book action generates a Transfer Out for the From book and a Transfer In for the To book.

The asset that is retired receives an asset status of *Disposed* on the From book.

These tables show that assets that you transfer between books using the action Transfer Book receive a status of Transferred.

<i>From Book</i>	<i>From Trans</i>	<i>To Book</i>	<i>To Trans</i>	<i>Action</i>
CORPORATE	Transfer Out	CORPORATE	Transfer In	Transfer Book
FEDERAL	Transfer Out	FEDERAL	Transfer In	Transfer Book

<i>From Book</i>	<i>From Trans</i>	<i>To Book</i>	<i>To Trans</i>	<i>Action</i>
CORPORATE	Transfer Out	CORPORATE	Transfer In	Transfer Book
FEDERAL	Retire	FEDERAL	Add	Add Book

<i>From Book</i>	<i>From Trans</i>	<i>To Book</i>	<i>To Trans</i>	<i>Action</i>
CORPORATE	Retire	CORPORATE	Add	Add Book
FEDERAL	Retire	FEDERAL	Add	Add Book

Using a From Book for Two or More Transfers

When you use a From book for two or more Transfer Book actions, only one Transfer Out transaction is generated. Because this takes care of the cost on the From book, no additional Transfer Out transactions are generated for that book.

This table shows that assets that you transfer between books using the Transfer Book action receive a status of *Transferred*.

<i>From Book</i>	<i>From Trans</i>	<i>To Book</i>	<i>To Trans</i>	<i>Action</i>
CORPORATE	Transfer Out	CORPORATE	Transfer In	Transfer Book
CORPORATE		LOCAL	Transfer In	Transfer Book

Using a From Book for Both Transfer and Add

When you use a From book for both a Transfer Book and an Add Book, a Transfer Out transaction is generated for the Transfer Book. Because this takes care of the cost on the From book, the Add Book does not generate a retirement for that book.

This tables shows that assets that you transfer between books using the Transfer Book action receive a status of Transferred.

<i>From Book</i>	<i>From Trans</i>	<i>To Book</i>	<i>To Trans</i>	<i>Action</i>
CORPORATE	Transfer Out	CORPORATE	Transfer In	Transfer Book
CORPORATE		LOCAL	Add	Add Book

Using a From Book for Two or More Adds

When a From book is used for two or more Add Book actions, a retirement is generated for the first Add Book action. Because this takes care of the cost on the From book, no further retirements are generated for it.

This table shows that the asset that was retired receives a status of Disposed on the From book.

<i>From Book</i>	<i>From Trans</i>	<i>To Book</i>	<i>To Trans</i>	<i>Action</i>
CORPORATE	Retire	CORPORATE	Add	Add Book
CORPORATE		LOCAL	Add	Add Book

Retiring a Book

When an asset is transferred from a business unit with two books to a business unit with more than two books, the asset pulls the additional book's mapping from the Interunit Business Unit/Book Definition page and profile.

For example, if you do a transfer from CAN01 (two books - ASSET-CAD/ASSET-USD) to US001, the mapping might be like this:

ASSETS-CAD -----> CORP

ASSETS-USD -----> FEDERAL

ASSETS-USD -----> ACE

ASSETS-USD -----> AMT

Some of the information such as life for the new business unit and book comes from the profile. The transfer amounts and so on are calculated from the FROM business unit or book, as previously outlined.

Note: When you transfer from a business unit with three books to a business unit with two books, the cost information on the extra From Book is automatically retired. You do not need to enter an action.

This table shows that assets that are retired receive a status of Disposed.

<i>From Book</i>	<i>From Trans</i>	<i>To Book</i>	<i>To Trans</i>	<i>Action</i>
CORPORATE	Transfer Out	CORPORATE	Transfer In	Transfer Book
LOCAL	Transfer Out	LOCAL	Transfer In	Transfer Book
FEDERAL	Retire			

InterUnit Proceeds page

Use the InterUnit Proceeds page (N/A) to apply a markup or markdown to the asset that you are transferring.

Navigation:

Click the **Proceeds** button on the Cost Information Page. This button appears on the page only when you select *Fixed Price Mark Up* as the action on the Main Transaction page.

You can transfer an asset from one business unit to another and have the receiving business unit receive the assets at a marked up cost by specifying either a fixed markup cost or a fixed markup percentage. To do so, enter the net markup price in **Interunit Proceeds** or the net markup percentage in **Mark Up/Down Percent**. The default is a positive adjustment. If you want to decrease the price or percentage, you must enter a negative amount. Enter the number of assets in **Transfer Quantity**.

Note: If you were to enter both an Interunit proceeds (Price) and a Mark Up/Down percent, the percent overrides the price.

You can complete a partial transfer and a fixed price markup or markdown by using a two-step method. For example, you may want to do a partial transfer of four computers out of a total quantity of ten computers and mark up the price as well. The first step is to perform an Interunit transfer for six computers. Complete this transaction, and then do a fixed price markup on the remaining four computers, and transfer them to the new business unit.

PeopleSoft Asset Management processes markups in the following ways:

- The markup percentage of the asset is specified on the cost of the asset.
- The cost of the asset is marked up or down for all the ChartFields in proportion to the original cost distribution of the asset.
- You can have the markup affect one or all of the asset's books during the transfer.

The **Keep All Books in Sync** option for the acquiring business unit controls whether the markup is done on one book or all the asset's books.

- The book information for the asset in the acquiring business unit comes from the asset profile that is specified at the time of the sale (on the Cost Information page).

This includes the depreciation method and convention, asset life, and so on.

- The selling business unit manages the markup price as proceeds.

Accumulated depreciation is not passed on to the new business unit.

Child Assets Page

Use the Child Assets page (CHILD_ASSETS) to select child assets to include in the transfer or recategorization that you have initiated against the parent assets.

Navigation:

Asset Management > Asset Transactions > Financial Transactions > Cost Adjust/Transfer Asset > Child Assets

The Child Assets page appears for child assets when you select the Transfer or the Recategorize actions on the Main Transaction page.

This example illustrates the fields and controls on the Child Assets page. You can find definitions for the fields and controls later on this page.

Main Transaction Cost Information Doc Sequencing Asset Cost Wrk Child Assets Asset Cost 01 Wrk Asset Cost Wrk2 D										
Unit US001		Asset ID MMFACTY0009			Air Conditioner Unit			Status In Service		
Tag Number										
<input type="button" value="Select All"/>										
Child Assets										Personalize Find View All [?] []
	Selected	Tag Number	Description	Child Asset ID	Asset Status	Cost	Currency	Acq Date	Child Details	Go To >>
1	<input type="checkbox"/>		AC Fan Motor	MMFACTY0010	In Service	400.00	USD	07/01/2004	Child Details	<input type="text" value=""/>

Note: Parent assets that are created on the Parent Asset page (parent-only assets) do not have cost or basic information. They cannot be viewed in the Parent-Child Basic Information component, nor can they be viewed or transacted against in the Asset Cost/Adjust Transfers component; the Asset Retirements component; or the Parent-Child NBV component. If you want to use a parent asset as a reporting umbrella only and access these pages to manipulate child assets in mass, you should create a zero cost parent asset instead of a parent only asset. Also, to transact against parent and child assets at once, parent and child must share the same asset profile.

Field or Control	Description
Select All	Click Select All to include all child assets with the parent in the transaction that you have initiated. To include some child assets, select the Selected check box on the specific rows.
Include Parent Asset	Select to include the parent asset in this transaction.
Advanced Txn Details (advanced transaction details)	Click this link to access the Parent Asset Adv Txn options page. Specify transaction overrides for all child assets at once. For example, you would use this page to specify that only 50 percent of the cost of all child assets be transferred between departments, while the parent asset is fully transferred. Select to apply as full transaction, actual percentage, or transaction amount. See Parent Asset Advanced Transaction Details Page .

Note: Only child assets available for transfer based on the specified accounting date can be selected. The system compares the last accounting dates for the child assets as specified on the Book table with the accounting date of the current transaction to make this determination.

Child Asset TRF/RCT Overrides Page

Use the Child Asset TRF/RCT Overrides page (AM_PARCHD_TRF_RCT) to specify transaction overrides for a specific child asset.

You can specify specific convention, quantity, cost, transaction percentage, transaction date and accounting date for the child asset on this page.

Navigation:

Click **Child Details** on the Asset Cost/Adjust Transfer Child Assets page.

This example illustrates the fields and controls on the Child Asset TRF/RCT Overrides page. You can find definitions for the fields and controls later on this page.

Child Asset TRF/RCT Overrides

Child Transfer/Recat Options

Convention

Quantity

Cost

Transaction Percentage

Transaction Date

Accounting Date

Field or Control	Description
Convention	Select a depreciation convention.
Quantity or Cost	Enter the quantity or cost to use in this transaction for the child asset. For example, if you were transferring all costs for the parent from one department to another, but wanted to transfer only 500 USD for the child asset, you would enter 500 in Cost .
Transaction Percentage	You can specify a percentage of the child asset's cost to include by entering it in the Transaction Percentage field.
Transaction Date and Accounting Date	Enter a transaction date or an accounting date if you want it to differ from the dates that you entered for the parent's transaction.

Parent Asset Advanced Transaction Details Page

Use the Parent Asset Adv Txn options page (FULL_PART_SEC) to specify transaction overrides for all child assets at once.

Navigation:

Click the **Advanced Txn Details** link on the Asset Cost/Adjust Transfer Child Assets page.

Select one of these options:

Field or Control	Description
Full Transaction	Applies the full transaction to all child assets. Select this check box when you are partially transferring the parent asset, for example, but want to fully transfer all associated child assets.
Actual Percentage	Enter the percentage of the costs of the child assets to apply to this transaction. For example, if you enter 50 percent, then 50 percent of the costs of all child assets will be included in the transaction even though a different percentage has been specified for the parent asset.
Transaction Amount	Enter a specific amount of the costs of the child assets to apply to this transaction. For example, if you enter 250, USD 250 of the costs of each child asset will be included in the transaction.

Update Asset Profile Page

Use the Update Asset Profile page (ASSET_PROFILE_SEC) to enter a new asset reporting profile ID when you recategorize an asset.

Update Asset Profile page

Transferring Parent-Child Assets to Other Business Units (Interunit Transfers) In Mass

Use the Parent-Child IU Transfer (AMPC_IUT_RQST) component to transfer parent-child assets from one business unit to another. The transfer process uses the application engine AM_PARCHD_IU.

This topic discusses how to transfer parent-child assets from one business unit to another.

Page Used to Transfer Parent-Child Assets to Other Business Units In Mass

Page Name	Definition Name	Usage
Parent-Child IU Transfer Page	AMPARCHDIU_RQST	Run the AM_PARCHD_IU Application Engine process to transfer Parent-Child assets from one business unit to another.

Parent-Child IU Transfer Page

Use the Parent-Child IU Transfer page (AMPARCHDIU_RQST) to run the AM_PARCHD_IU Application Engine process to transfer Parent-Child assets from one business unit to another.

Navigation:

Asset Management > Asset Transactions > Parent-Child Relationship > Parent-Child IUT

This example illustrates the fields and controls on the Parent-Child IU Transfer page. You can find definitions for the fields and controls later on this page.

Parent-Child IU Transfer

Run Control ID ACU Report Manager Process Monitor Run

*Request ID Status Pending

Process Frequency

*Unit *Transaction Date

*New Unit *Accounting Date

New Group ID Transaction Code

*Convention

*Parent Asset Test parent 1 Include Parent Asset

*Profile ID Capitalized Asset

Select All

Select from the following Child Assets Personalize | Find | | | First 1-3 of 3 Last

Selected	Tag Number	Description	Child Asset ID	Asset Status	Capitalized Asset	Cost	Curr	Acq Date	In Service Date
<input type="checkbox"/>		Furniture & Fixtures	ABCT03	In Service	<input checked="" type="checkbox"/>	12000.00	USD	09/14/2016	09/14/2016
<input type="checkbox"/>		test child 1	ABP01_C01	In Service	<input checked="" type="checkbox"/>	1000.00	USD	09/15/2016	09/15/2016
<input type="checkbox"/>		test child 2	ABP01_C02	In Service	<input type="checkbox"/>			09/15/2016	09/15/2016

Field or Control	Description
Unit	Select the business unit from which you are transferring assets.
New Unit	Select the acquiring business unit.
New Group ID	This field displays when the New Unit field points to a Group Asset business unit. This is used when you want to extend parent/child functionality to group assets. See Understanding Group Asset Processing .

Field or Control	Description
Convention	Select the depreciation convention.
Transaction Date	Enter the transaction date.
Accounting Date	Enter the accounting date for the transaction.
Transaction Code	Identifies which accounting entry template to use for this transaction. Only valid combinations for which accounting entry templates exist are accepted.
Parent Asset	Select the parent asset from which you are transferring assets.
Profile ID	Select an ID that is valid for the new business unit to set up book reporting.
Include Parent Asset	Deselect this check box to transfer all or selected child assets at once while leaving the parent asset out of the transaction.
Capitalized Asset	Indicates whether the parent asset is capitalized or non capitalized.

The **Select from the following Child Assets** results grid displays child asset description, ID, status, capitalization status, and so forth.

Revaluing Assets Using the Revaluation Worksheet

This topic lists the page used to revalue assets using the Revaluation Worksheet.

The Revaluation Worksheet allows you to revalue financial assets in accordance with International Accounting Standards (IAS 16) to reflect current fair value, provided that the net book value (NBV) of an asset is less than its fair value (FV) at a given point.

Note: Since the NBV is required for determining the revaluation amount, the depreciation reporting table must be loaded prior to performing revaluation.

Revaluing an Asset Below Net Book Value to Meet Australian Accounting Standard AASB 116

PeopleSoft provides you with the ability to revalue an asset below net book value, so that fair market value is less than net book value. This enables Australian users to meet Australian Accounting Standard AASB 116.

When you revalue an asset below net book value, two cost rows are created for this scenario: one row representing the revaluation up to where the net book value is greater than the fair market value, and a second row representing the difference to match the total revaluation of calculating the cost adjustment.

Page Used to Revalue Assets Using the Revaluation Worksheet

<i>Page Name</i>	<i>Definition Name</i>	<i>Usage</i>
<u>Revaluation Worksheet Page</u>	AM_REVALUATION	Search for financial assets using the desired criteria, mark them for revaluation, supplying the current fair value amount and click the Save button. Changes take effect upon save as the Transaction Loader (AMIF1000) is automatically invoked, provided the Auto-Run Transaction Loader options within Asset Management - User Preferences are selected.

Revaluation Worksheet Page

Use the Revaluation Worksheet page (AM_REVALUATION) to search for financial assets using the desired criteria, mark them for revaluation, supplying the current fair value amount and click the Save button.

Changes take effect upon save as the Transaction Loader (AMIF1000) is automatically invoked, provided the Auto-Run Transaction Loader options within Asset Management - User Preferences are selected.

Navigation:

Asset Management > Asset Transactions > Financial Transactions > Revaluation Worksheet

This example illustrates the fields and controls on the Revaluation Worksheet page (1 of 2). You can find definitions for the fields and controls later on this page.

Revaluation Worksheet

▼ Asset Search Criteria

*Business Unit <input type="text" value="US001"/>	*Book Name <input type="text" value="CORP"/>
Asset Category <input type="text"/>	Location <input type="text"/>
Profile ID <input type="text"/>	Cost Type <input type="text"/>
Asset Class <input type="text"/>	Chartfield Search Criteria
From Asset ID <input type="text"/>	To Asset ID <input type="text"/>

▼ Revaluation Information

FV Percentage(%) <input type="text"/>	FV Template ID <input type="text"/>
NBV Percentage(%) <input type="text"/>	FV Group ID <input type="text"/>
*Accounting Date <input type="text" value="09/25/2018"/>	Convention <input type="text" value="AM"/>
*Revalue Method <input type="text" value="Investment Property"/>	<input checked="" type="checkbox"/> Copy Revaluation To Other Book
*Revaluation Date <input type="text" value="09/25/2018"/>	Exclude Assets Revalue After <input type="text"/>
<input type="checkbox"/> Include current Period Depr.	Frequency <input type="text" value="Annually"/>

<i>Field or Control</i>	<i>Description</i>
Business Unit	Select a business unit for your search criteria. This is a required field and displays only business units whose revaluation option is enabled.
Book Name	Select a book for your search criteria. This is a required field and displays the default book for the business unit that you select in the Business Unit field.
Cost Type	(Optional) Select a Cost Type to narrow your search criteria.
Asset Category	(Optional) Select a Category to narrow your search criteria.
Location	(Optional) Select a Location to narrow your search criteria.
Profile ID	(Optional) Select a Profile ID to narrow your search criteria.
Asset Class	(Optional) Select an Asset Class to narrow your search criteria.
From Asset ID/To Asset ID:	(Optional) Select an asset or a range of assets to further narrow your search criteria.

Field or Control	Description
ChartField Search Criteria	(Optional) Use this link to search assets by ChartField.
FV Percentage (%): (fair value percentage)	<p>(Optional) Use a percentage that applies to all assets that appears in the search result section when the Retrieve button is pushed. Enter a value that is less than zero if there is a decrease from the original value. If both FV percent and NBV percent exist, the system uses the FV percent.</p> <p>For example, assume that Asset A has a Fair Value of 10,000 USD and the FV has been effective for two years. If you enter a value of 25, it will change the FV of the asset to 12,500 USD with the revaluation date when page is saved, which is 125 percent x Original FV (125% x 10000 = 12500). The calculated FV will appear in the result section.</p> <p>See “Defining Fair Value Processing” (Asset Lifecycle Management Fundamentals).</p>
FV Template ID (fair value template ID)	<p>Select an existing fair value template, if applicable. This provides an efficient way to populate the other fair value fields. Upon clicking the Retrieve button, the FV Template ID and FV Group ID in the Asset Search Results retrieves default values from the Revaluation Information section.</p> <p>When marking rows and saving the page, the fair value fields are updated on the Fair Value record (AM_FMV).</p> <p>See “Fair Value Templates Page” (Asset Lifecycle Management Fundamentals).</p>
FV Group ID (fair value group ID)	<p>Default value populates from the selected FV Template ID. You can override the default value that is derived from the FV Template. If the valuation premise from the FV Template is <i>In-Exchange</i> or the FV Template ID is blank, the FV Group ID is disabled.</p> <p>See “Fair Value Groups Page” (Asset Lifecycle Management Fundamentals).</p>
NBV Percentage (%):	<p>(Optional) Use a percentage that applies to all assets that appears in the search result section when the Retrieve button is pushed. You must enter a value that is greater than zero in this field; otherwise, it will cause the FV to be less than the NBV and no revaluation will occur.</p> <p>For example, assume that Asset B has a Fair Value of 9,000 USD and a Net Book Value of 10,000 USD. The FV has been effective for two years. If you enter a value of 30, it will change the FV to 13,000 USD (130% x 10,000) with the revaluation date when the page is saved. The calculated FV will appear in the result section.</p>
Accounting Date	Enter the date that the revaluation is to be booked. This date must fall within the open period range and cannot be earlier than the revaluation date.

Field or Control	Description
Copy Revaluation to Other Book	<p>Select this check box if you want the revaluation amount in a given book to populate other books whose revaluation process is enabled.</p> <p>PeopleSoft Asset Management copies the revaluation amount to other books in the ledger group as long as the Keep Ledgers in Sync (KLS) option is selected. If the option Copy Revaluation to Other Books is checked, PeopleSoft Asset Management copies the same amount to the books with the revaluation process selected for books that do not point to the ledger group. Depending on the selection of these options, when Copy Zero Impair/Revalue Rows is checked, the system copies zero revaluation data in all the remaining books.</p> <p>For example: Suppose you have a business unit with six books (A, B, C, D, E, F), with the first three books, A, B and C pointing to a ledger group, the ledger group is synchronized with the general ledger business unit and book B is pointing to the primary ledger. However, the other three books, D, E and F, do not point to general ledger and books A, B, C, and E have the revaluation option enabled. PeopleSoft Asset Management processes the revaluation against the primary book, B. The system then copies the revaluation adjustment to book A and book C because they are in the same ledger group, regardless of the status of the options Copy Revaluation to other books and Copy Zero Impair/Revalue Rows. If Copy Revaluation to other books is selected, the system copies the same revaluation adjustment to book E because the revaluation option is selected for that book. If the Copy Zero Impair/Revalue Rows option is selected, the system copies zero revaluation rows into book D and F. If the Copy Revaluation to other books option is not selected <i>and</i> the Copy Zero Impair/Revalue Rows option is selected, the system copies zero impairment rows to books D and F. When both options are not selected, the system does not copy any impairment or revaluation row to books D, E and F.</p>

Field or Control	Description												
Revalue Method	<p>Select the method used to calculate the asset revaluation. This is a required field and includes the following options:</p> <ul style="list-style-type: none"> <p><i>Dpr Wt-Off</i> (depreciation write-off)</p> <p>This option appears only if the Revaluation Write-off flag is turned on at the Business Unit/Book level. The depreciation write-off method writes off the accumulated depreciation as of the revaluation date. The asset value is increased to reflect the current fair value and a revaluation surplus is recorded.</p> <p>This table shows, at a high level, what happens with the depreciation write-off method when the original asset cost is 20,000 USD, the NBV is 19,000 USD and the FV is 22,000 USD:</p> <table border="1" data-bbox="911 730 1471 1205"> <thead> <tr> <th>Account</th> <th>Debit / (Credit)</th> <th>Description</th> </tr> </thead> <tbody> <tr> <td>Fixed Asset</td> <td>2,000</td> <td>FV less Original Cost (22,000 - 20000)</td> </tr> <tr> <td>Accumulated Depreciation (write-off)</td> <td>1,000</td> <td>Original Cost less NBV (20,000 - 19,000)</td> </tr> <tr> <td>Revaluation Surplus</td> <td>(3,000)</td> <td>FV less NBV (22,000 - 19,000)</td> </tr> </tbody> </table> <p>Note: With the previous accumulated depreciation written off, the adjusted basis of the asset is 22,000 USD and subsequent depreciation is calculated keeping, untouched the original depreciation amount, plus adjustments to fully depreciate the asset by the end of its useful life.</p> <p>Note: If there is a remaining impairment processed previously for the asset, under the depreciation write-off method, the system first eliminates it and only the remaining value generates a revaluation surplus.</p> <p><i>Cost Based</i></p> <p>This method leaves the accumulated depreciation to-date in tact and adjusts the asset cost by the difference between the asset NBV and the FV.</p> <p>This table shows, at a high level, what happens with the Cost Based method when the original asset cost is 20,000 USD, the NBV is 19,000 USD and the FV is 22,000 USD:</p> 	Account	Debit / (Credit)	Description	Fixed Asset	2,000	FV less Original Cost (22,000 - 20000)	Accumulated Depreciation (write-off)	1,000	Original Cost less NBV (20,000 - 19,000)	Revaluation Surplus	(3,000)	FV less NBV (22,000 - 19,000)
Account	Debit / (Credit)	Description											
Fixed Asset	2,000	FV less Original Cost (22,000 - 20000)											
Accumulated Depreciation (write-off)	1,000	Original Cost less NBV (20,000 - 19,000)											
Revaluation Surplus	(3,000)	FV less NBV (22,000 - 19,000)											

Field or Control	Description											
	<table border="1"> <thead> <tr> <th>Account</th> <th>Debit / (Credit)</th> <th>Description</th> </tr> </thead> <tbody> <tr> <td>Fixed Asset</td> <td>3,000</td> <td>FV less NBV (22,000 - 19,000)</td> </tr> <tr> <td>Revaluation Surplus</td> <td>(3,000)</td> <td>FV less NBV (22,000 - 19,000)</td> </tr> </tbody> </table>	Account	Debit / (Credit)	Description	Fixed Asset	3,000	FV less NBV (22,000 - 19,000)	Revaluation Surplus	(3,000)	FV less NBV (22,000 - 19,000)		
Account	Debit / (Credit)	Description										
Fixed Asset	3,000	FV less NBV (22,000 - 19,000)										
Revaluation Surplus	(3,000)	FV less NBV (22,000 - 19,000)										
	<p>Note: The total cost of the asset is now 23,000 USD with a remaining accumulated depreciation of 1,000. Subsequent depreciation is calculated based on the new total cost to fully depreciate the asset by the end of its useful life.</p> <p>The actual accounting entries that are recorded as a result of these two revaluation methods are comprised of separate accounts so as to leave the original entries in tact. These accounts and corresponding distribution types are:</p> <ul style="list-style-type: none"> • Provision for Revaluation, (PR distribution type), is the Revaluation Surplus account and records the gain on the revaluation. This account is credited when creating the revaluation surplus and debited with the asset disposal. • Reversal of Depreciation, (RD distribution type), is the realized gain during the usage of the asset and is credited periodically along with the asset depreciation. • Provision for Revaluation Contra, (RC distribution type), is the depreciated amount of the Provision for Revaluation and is used for facilitating calculations at the moment of transferring or doing a recategorization. It acts for Provision for Revaluation as Accumulated Depreciation acts for the fixed asset account. It is debited periodically along with the asset depreciation and credited with the asset disposal. • <i>Inv Prop</i> (investment property) - Investment property measured at fair value is considered non depreciable according to International Accounting Standards (IAS). When you select this field value and click the Retrieve button, those assets that were designated as investment property are retrieved. <p>See “Defining Investment Property” (Asset Lifecycle Management Fundamentals).</p>											

Field or Control	Description
Convention	Enter the depreciation convention. The default value is <i>AM</i> (actual month). See “Setting Up Depreciation Conventions” (Asset Lifecycle Management Fundamentals).
Revaluation Date:	Enter the date that the revaluation takes place. This is the transaction date and is used to determine the NBV and the FV.
Include current Period Depr.	Select this option if the current period depreciation is to be accumulated. For example: if you perform the revaluation at the end of period 12 (the final period in the year) but you do not want to include period 12 depreciation to compare with FV, you would not select this check box.
Exclude Assets Revalue After:	(Optional) Select a date that may assist you in retrieving assets that have not been revalued recently.
Frequency	Select the frequency of the revaluation. This is used for audit purposes.
Retrieve	Click the Retrieve button to retrieve the assets based on your search criteria.

Asset Search Results

Once you click the **Retrieve** button, the Asset Search Results page appears. The Asset Search Criteria section collapses and the revaluation information is visible but disabled.

This example illustrates the fields and controls on the Revaluation Worksheet page (2 of 2). You can find definitions for the fields and controls later on this page.

Revaluation Worksheet

▶ **Asset Search Criteria**

▼ **Revaluation Information**

FV Percentage(%) FV Template ID
 NBV Percentage(%) FV Group ID
 *Accounting Date 09/25/2018 Convention AM
 *Revalue Method Copy Revaluation To Other Book
 *Revaluation Date 09/25/2018 Exclude Assets Revalue After
 Include current Period Depr. Frequency

Retrieve Next Rows 1 - 54

use the buttons to mark assets for revaluating, updating FMV, or removing from the list. The changes will take effect after you click "Save" button.

Asset Search Results

1-54 of 54

Revaluation Information | Asset Information | Comments and Attachments

Mark	Revaluation Status	Asset ID	Cost	Accumulated Depreciation	Net Book Value	Fair Value	Revaluation	Cost Adjustment	Accum. Depr. Adjustment	Impairrr Reversr
<input type="checkbox"/>		000000000001	84000.00	-10,933.36	73,066.64	<input type="text"/>	-73,066.64	-84,000.00	10,933.36	^
<input type="checkbox"/>		000000000002	84000.00	-10,933.36	73,066.64	<input type="text"/>	-73,066.64	-84,000.00	10,933.36	

Field or Control	Description
Mark to Revalue	Click to revalue the selected assets. The revaluation status of the selected assets is changed to <i>Revalue</i> and when the page is saved, the asset is revalued.
Mark to not Revalue	Click to change the revaluation status of the selected assets to <i>Don't Revalue</i> . When the page is saved, the selected assets will not be revalued. A blank revaluation status is treated the same as the "Don't Revalue" asset; however, this designation marks the asset specifically as an asset that should not be revalued and the asset appears in the audit table.
Mark to Update FV	Click to update the FV in mass without performing a revaluation. The revaluation status will be <i>FV</i> and implies only an update in the FV table using the date of revaluation as the appraisal and effective date. The FV is necessary for comparison purposes in the revaluation process and this provides a convenient way to update those values for in mass.
Remove From List	Click to remove the selected assets from the grid. This action does not generate a new Revaluation Status.

Field or Control	Description
Refresh	Click to update changes in the revaluation calculation if you modify the FV before saving the page.
Mark	Select those assets to which the action applies.
Revaluation Status	<p>Displays the revaluation status of the asset. The values are:</p> <ul style="list-style-type: none"> • <i>[blank]</i>: Default value. • <i>Revalue</i>: Displays when the Mark to Revalue button is selected. This inserts the new FV into the FV table, if applicable, and creates transaction rows in the financial interface table. • <i>Don't Revalue</i>: Displays when the Mark to not Revalue button is selected. No action is performed for the asset. • <i>FV</i>: Displays the FV when the Mark to Update FV button is selected. <hr/> <p>Note: You can change the revaluation status until saving the page. Once you save the page, all data becomes unavailable for change.</p> <hr/>
Asset ID	Displays the asset identifier.
Cost	Displays the total cost of the asset in the base currency.
Accumulated Depreciation	<p>Displays the total depreciation in the base currency of the asset up to the revaluation period or prior period based on the "Include Current Period Depr." option.</p> <hr/> <p>Note: If the convention is <i>AD</i>, prior period means prior day.</p> <hr/>
Net Book Value	Displays the asset NBV. This value is copied from the Depreciation Reporting table, which must be loaded before using the Revaluation Worksheet for revaluation.

Field or Control	Description
Fair Value	<p>Displays the FV converted from its original currency to the book's base currency at the revaluation date rate. You can update the FV in the book's base currency and at such time, a new entry is created in the FV table at the time of save as long as the revaluation status is <i>Revalue</i> or <i>FV</i>. If you modify the given FV, click refresh button to update the revaluation amount.</p> <p>See “Defining Fair Value Processing” (Asset Lifecycle Management Fundamentals).</p>
Revaluation	<p>Displays the revaluation adjustment amount. The system calculates the amount as follows:</p> <ul style="list-style-type: none"> • Depreciation Write-Off Method: FV less NBV less Carry Cost (Impairment) amount, if Revaluation is greater than zero. • Cost Based Method: FV less NBV.
Cost Adjustment	<p>Displays the cost adjustment amount. The system calculates this amount as follows: FV less Cost.</p> <ul style="list-style-type: none"> • Depreciation Write-Off Method: FV less Cost. • Cost Based Method: FV less NBV.
Accum. Depr. Adjustment (accumulated depreciation adjustment)	(Applies only when the Depreciation Write-off method is used.) Displays the amount of the accumulated depreciation adjustment due to revaluation.
Impairment Reversal	<p>(Applies only when the Depreciation Write-off method is used.) Displays the impairment reversal amount. The system calculates this amount as follows:</p> <ul style="list-style-type: none"> • If the Revaluation amount is greater than zero, the impairment reversal is the Carry Cost (Impairment) value. • If the Revaluation amount is less than zero, the impairment reversal is the FV less the NBV.
Carry Cost (Impairment)	Displays the sum of the Impairment Loss and prior Impairment Reversal (in the base currency.)
Carry Cost (Revaluation)	Displays the sum of the prior Revaluation, Revaluation Reversal and Revaluation Write-off (in the base currency.)

Field or Control	Description
Comments	Click the Comments link to access the Asset Comments page. Use this page to view or add relevant supporting comments to an asset transaction.
Attachments	Click the Attachments link to access the Asset Attachments page. You can view or add relevant supporting attachments to an asset transaction.

Note: Upon saving, an audit trail is stored in two tables: AM_REV_AUD_HDR and AM_REV_AUD_DTL.

Revaluing Assets En Masse

This topic lists the page that you use to revalue assets in mass.

You can run the AMREVAL process (Cost Based method) to revalue assets in mass that meet the criteria that you specify. You can also run the AMAUSCAL process (Australian Revaluation or Net Method) or the AMDEPRWROFF process (Depreciation Write-Off) in mass. To revalue assets in mass, access the Mass Revaluation page.

Note: All three revaluation methods are available using the Mass Revaluation process: Cost Based (primarily French revaluation), Depreciation Write-Off and the Net Method (Australian revaluation). In contrast, the Revaluation Worksheet only allows the Cost Based and Depreciation Write-Off methods for revaluation.

When the NBV is required for determining the revaluation amount (as is always the case with the AMDEPRWROFF), the depreciation reporting table must be loaded prior to performing the revaluation. If you are using the Net Method, you do not need to load the depreciation reporting table prior to revaluation (AMAUSCAL.)

When calculating the revaluation amount, you may select from the following parameters: FV, FV Percentage, NBV Percentage, Cost Percentage or Amount. You may only select one parameter at a time and precedence takes place hierarchically from top to bottom in the order that the parameters appear on the Mass Revaluation run control page. Some parameters may not be available, depending upon the revaluation method that is selected.

Note: The revaluation method selected on the run control page must match the process name that is selected on the process scheduler request page.

Using the AMAUSCAL Process (Australian Revaluation or Net Method)

The AMAUSCAL process for Australian revaluation loads the interface tables and automatically sets the correct load status for each transaction:

- RET load status = **Pending**

- REI load status = **On Hold**
- ADJ load status = **On Hold**
- BKS load status = **On Hold**

This behavior enables the Load Transaction into AM (AMIF1000) process to run just once for all transactions when you input the RET transaction interface ID on the Load Transaction into AM page.

Warning! Do not modify the load status of the *On Hold* transactions; this is part of the processing behavior that automatically sets the load status and associates the REI, ADJ, and BKS (On Hold) transactions with the RET (Pending) transaction. This behavior enables the Load Transaction into AM (AMIF1000) process to run just once for all transactions when you input the RET transaction interface ID on the Load Transaction into AM page.

Using the AMREVAL Process (Cost Based method)

When using the Cost Based Method (AMREVAL), you should load the depreciation reporting table for all parameters except when using Cost Percentage. The Cost Percentage parameter does not require the depreciation reporting table.

Note: The Cost Based (AMREVAL) and the Depreciation Write-Off (AMDEPRWRTOFF) processes update the FV of the revalued assets.

Page Used to Revalue Assets En Masse

<i>Page Name</i>	<i>Definition Name</i>	<i>Usage</i>
Revaluation en Masse Page	AMREVAL_RQST	Run a process to revalue, at once, all assets that meet the criteria that you specify. This process loads the interface tables and updates the FV table if applicable; you must then use the Transaction Loader to populate all the asset tables.

Related Links

[Understanding PeopleSoft Asset Management in Global Settings](#)

Revaluation en Masse Page

Use the Revaluation en Masse page (AMREVAL_RQST) to run a process to revalue, at once, all assets that meet the criteria that you specify.

This process loads the interface tables and updates the FV table if applicable; you must then use the Transaction Loader to populate all the asset tables.

Navigation:

Asset Management > Asset Transactions > Financial Transactions > Revaluation en Masse > Revaluation en Masse

This example illustrates the fields and controls on the Revaluation en Masse page. You can find definitions for the fields and controls later on this page.

Capturing and Maintaining Asset Fair Value

Fair Value is a key factor in establishing revaluation of assets. PeopleSoft Asset Management stores this information based on each asset and allows you to add a new fair value (FV) on a regular basis, leave it blank, or let it stay as original cost, depending upon your business requirements. FV is not rolled up to the composite asset from its members, and the FV history cannot be deleted for audit purposes.

FV history cannot be deleted or updated for audit purposes unless you are authorized to edit within Correction Mode. Any changes made in this value after performing revaluation do not affect existing revaluations.

You can load market values in mass using the Excel to CI component interface.

See [Adding Assets with the Excel to Component Interface Utility](#).

This topic lists the page that you use to capture and maintain asset FV.

Page Used to Capture and Maintain Asset FV

Page Name	Definition Name	Usage
Fair Value Page	AM_FV_DEFN	Capture and maintain the asset fair value that is to be used in the revaluation process.

Fair Value Page

Use the Fair Value page (AM_FV_DEFN) to capture and maintain the asset fair value that is to be used in the revaluation process.

Navigation:

Asset Management > Asset Transactions > Financial Transactions > Fair Value

This example illustrates the fields and controls on the Fair Value Page. You can find definitions for the fields and controls later on this page.

Fair Value

Unit US001 Asset ID 000000000007 Tag P000041715 In Service

Fair Value Detail Find | View All First 1 of 1 Last

*Effective Date Effective Sequence 0

Appraisal Date *Rate Type

Fair Value Currency

Valuation Method

Valuation Method Group By

Valuation Premise FV Group ID

Input Level

Comment

Field or Control	Description
Effective Date	Enter the date that the revaluation process will use to find FV at a specified point in time.
Effective Sequence	The system populates this field and is incremented when a new row is inserted with the same effective date.

Field or Control	Description
Fair Value:	<p>Enter the amount to be copied to the Basic Add page where the current fair value is displayed.</p> <hr/> <p>Note: If the asset is a capital lease, synchronize the fair value entered from the Lease Express Add page or the Update Lease Information page. The FV entered on the lease page is inserted in the FV table with the transaction date as the effective and appraisal dates. The valuation method is <i>Acquisition Amount</i>. The FV becomes unavailable for edit on the FV table, but you can modify it on the Lease Update page (ASSET_LEASE_01.) The system allows you to add/update other rows. On this page, you can change only the original FV, and it is copied into the FV table. A new row inserted on the FV page will not impact on the FV field on the Lease Update page.</p> <hr/> <p>See Understanding Leased Assets.</p>
Currency	Enter the currency to be used to measure the FV. This field value automatically populates from the default book currency.
Rate Type	Enter the rate type that will be used to convert FV to base currency when it is used for revaluation. This field value automatically populates from the default book rate type.
Valuation Method	Select the valuation method that is to be used for this asset.
Valuation Premise	Designate the valuation premise as either <i>In-Use</i> or <i>In Exchange</i> . If <i>In Use</i> is selected, the Group By and FV Group ID fields appear.
Input Level	Select the report input level for the asset: Level 1, Level 2 or Level 3. The default value is blank.
Group By	This field is active when the Valuation Premise is <i>In-Use</i> . Select the appropriate grouping for the asset.
FV Group ID (fair value group ID)	<p>This field is active when the Valuation Premise is <i>In-Use</i>. Select the appropriate FV Group ID.</p> <p>See “Defining Fair Value Processing” (Asset Lifecycle Management Fundamentals).</p>

Updating Non capitalized Costs

This topic lists the page that you use to update non capitalized costs for assets.

Please note that Financial transactions cannot be performed on the Lease Administration Lease Assets through Asset Management.

Page Used to Update Non capitalized Costs

<i>Page Name</i>	<i>Definition Name</i>	<i>Usage</i>
Update Non-Capitalized Cost	ASSET_NON_CAP_UPD	Update non capitalized costs for an asset.

Viewing Cost History and Summarizing Cost Rows

Use the Review Cost (COST_HISTORY) component to review cost history for capitalized and non capitalized assets.

Use the Cost Summarization (AM_COST_SUM_RUN) component to summarize cost rows.

This topic provides overviews of cost history and cost summarization and discusses how to generate cost summarizations:

Pages Used to View Cost History and Summarize Cost Rows

<i>Page Name</i>	<i>Definition Name</i>	<i>Usage</i>
<u>Cost History List Page</u>	ASSET_TRANS_01	View a history of an asset's transactions. Physical Book Cost displays when book cost is categorized as physical as a result of Capitalization Threshold. This information does not display for a Financial book.
Cost History Detail	ASSET_TRANS_02	View more detail about a specific transaction.
Non Cap History List	ASSET_TRANS_03	View a history of a non capitalized asset's transactions.
Non Cap History Detail	ASSET_TRANS_04	View more detail about a specific transaction.
<u>Cost Summarization Page</u>	AM_COST_SUM_RUN	Generate cost summarizations.

Understanding Cost History

PeopleSoft enables you to view cost history of assets online. You can view cost history for both capitalized and non capitalized assets. Using the Cost History component, you can:

- View a history of an asset's transactions on the Cost History List page.
- View detail about a specific transaction on the Cost History Detail page.

- View a history of a non capitalized asset's transactions on the Non Cap Cost History List page.
- View more detail about a specific transaction on the Non Cap Cost History Detail page.
- View physical book cost when book cost is categorized as physical as a result of Capitalization Threshold. This information does not display for a Financial book.

Understanding Cost Summarization

Multiple transactions coming from PeopleSoft feeder systems rapidly create a large volume of cost history lines. PeopleSoft Asset Management provides the Cost Summarization process to summarize multiple cost lines that meet certain criteria into a single line. The process uses the Cost Summarization Run component (AM_COST_SUM_RUN). You should run the process only after calculating depreciation (AM_DEPR_CALC) and creating accounting entries (AM_AMAEDIST).

Cost summarization affects cost rows in the Cost table only. No changes are made to the Acquisition Detail table. The fields that are summarized are **Cost**, **Transaction Cost**, and **Quantity**. Cost summarization creates an audit table (AM_COST_SUM_AUD) that contains the original cost rows before summarization.

You can summarize cost rows that have matching values for:

- Business unit.
- Asset ID.
- Book.
- Category.
- Transaction type.
- Chart of accounts, or ChartField.
- Cost type.
- Transaction code.
- Accounting year and period.
- Transaction year and period.
- Depreciation convention.

Summarization updates the transaction date with the first day in the transaction period for all lines. It updates the accounting date with the last day in the accounting period for all lines. The summarization is then based on the new dates.

The only exception is the actual day (AD) convention.

When the transaction currency code or type differs, cost summarization uses the asset base currency as the transaction currency, and currency type is blank.

Note: You can run cost summarization in streamline mode during the create accounting entry process using the accounting entry component (AM_AMAEDIST).

Cost History List Page

Use the Cost History List page (ASSET_TRANS_01) to view the cost history of an asset.

Navigation:

Asset Management > Asset Transactions > History > Review Cost > Cost History List

This example illustrates the fields and controls on the Cost History List page. You can find definitions for the fields and controls later on this page.

The screenshot shows the 'Cost History List' page for an asset. At the top, there are tabs for 'Cost History List', 'Cost History Detail', 'Non Cap History List', and 'Non Cap History Detail'. Below the tabs, asset information is displayed: Unit US001, Asset ID 000000000091, Automobile, Tag, and In Service. A checkbox for 'Approval Pending' is checked. Below this is a 'Book' section with a search bar and navigation controls, showing 'Book Name CORP Corporate' and 'Currency USD'. The 'Total Cost' is 10,000.00. An 'Asset Cost Information' section follows, also with a search bar and navigation controls, showing '1-1 of 1'. Below this is a table with columns: Acctg Date, Trans Type, In/Out, Quantity, Total Cost, and Detail. The table contains one row: 1 09/19/2003, ADD, 1.0000, 10,000.00, and a 'Detail' link. At the bottom, there are links for 'Comments (1)' and 'Attachments (1)'.

Click the **Detail** link to access the Cost History Detail page and review cost details for an individual transaction.

Click the **Comments** link to access the Cost History List - Comments page and view or add relevant supporting comments to an asset transaction.

Click the **Attachments** link to access the Cost History List - Attachments page and view or add relevant supporting documents to an asset transaction.

Cost History List - Comments Page

Use the Cost History List - Comments page (AM_COMMENTS_SEC) and view or add relevant supporting comments to an asset transaction.

Field or Control	Description
Comment	Enter comments for an asset.
User ID, Name and Date/Time Stamp	Displays the user ID, name, and date/time stamp related to the user who added the comment. You can edit the date/time stamp after saving the comment.

Field or Control	Description
Source	Displays the transaction source for the asset, such as adjustment, transfer, and so forth.

Cost History List - Attachments Page

Use the Cost History List - Attachments page (AM_ADD_ATTACH_SEC) to view or add relevant supporting documents to an asset transaction.

Field or Control	Description
Add Attachment	Click this button to attach files as supporting documentation for an asset. Supply a description of the file or files that you attach.
File Name	Displays the attached file. Click the file-link to access the file.
Description	Displays a description of the file attachment when one was provided by the user.
User, Name, and Date/Time Stamp	Displays the user ID, name, and date/time stamp related to the user who added the attachment.

Cost Summarization Page

Use the Cost Summarization page (AM_COST_SUM_RUN) to generate cost summarizations.

Navigation:

Asset Management > Asset Transactions > Financial Transactions > Cost Summarization > Cost Summarization

Field or Control	Description
Business Unit	The business unit is required.
Book Name	If this field is blank, the cost summarization applies to all books.
Category	Select a category to apply summarization only to that category. Leave blank to include all categories.

Field or Control	Description
From Asset ID and To Asset ID	Optionally enter a range of asset IDs to apply the summarization to specific assets. The assets that are available belong to the category when category is defined and that have accounting entries already generated. If the To Asset ID field is left blank, the summarization applies only to the asset ID that is specified in the From Asset ID field.
Accounting Date Range	The accounting date range is required for summarization. You can apply cost summarization to multiple books with different calendars. Define the date range according to the books that are selected.

Note: When a line does not meet the criteria to summarize with other lines, no summarization occurs. Cost summarization creates an audit table so that you can review the summarization details after you have processed the summary.

Updating the General Ledger with Adjustments and Transfers

When you make adjustments or changes that affect your general ledger, PeopleSoft Asset Management automatically creates corresponding journal entries that update the applicable accounts in your general ledger. Specifically, journal entries are created when your changes require recalculation or when an asset is transferred. The information that is used to create these journal entries comes from an Accounting Entry template that is set up for adjustments and transfers.

Related Links

“Defining Accounting Entries” (Asset Lifecycle Management Fundamentals)

“Understanding General Ledger Journal Entries” (PeopleSoft General Ledger)

Modifying or Deleting Pending Asset Transactions

You can modify or delete financial asset transactions that are pending depreciation. (These are transactions on which depreciation has not yet been run.) You can modify or delete the following pending asset transactions:

- Adds
- Adjustments
- Transfers
- Recategorizations

Warning! You cannot modify or delete retirement transactions, leased asset transactions, group asset transactions, joint venture transactions, or parent/child asset transactions.

Note: Regarding the **Copy Changes to Other Books** option: when you delete an Add transaction, the deletion applies to all books to which the asset reports. However, when you delete Adjustments, Recategorizations, and Transfers transactions, you should review the delete at each book in the scroll area and click the **Delete** button on each book. Also, if you are using this page only to change the accounting date, transaction date, or transaction code, these changes will apply to all books to which the asset reports. To apply other types of updates to pending transactions, you need to scroll through each book that you want to affect with the modification. No other way is available to affect all books with an update.

Note: Financial transactions cannot be performed on the Lease Administration Lease Assets through Asset Management.

Pages Used to Modify or Delete Pending Asset Transactions

<i>Page Name</i>	<i>Definition Name</i>	<i>Usage</i>
<u>Pending Trans Update/Delete Page</u>	PEND_TRANS_UPD_DEL	Update or delete transactions in Pending Transaction table prior to running depreciation processing (AM_DEPR_CALC).
<u>Asset Addition Page</u>	PEND_TRANS_A1_SP	Review detail transaction information and then modify or delete the transaction.
<u>Transaction Information Page</u>	ASSET_TRNINFO4_SEC	Modify the transaction or accounting date.

Pending Trans Update/Delete Page

Use the Pending Trans Update/Delete (pending transaction update and delete) page (PEND_TRANS_UPD_DEL) to update or delete transactions in Pending Transaction table prior to running depreciation processing (AM_DEPR_CALC).

Navigation:

Asset Management > Asset Transactions > Financial Transactions > Change/Delete Pending Trans > Pending Trans Update/Delete

Review the information to make sure that this is the intended transaction that you want to modify or delete.

Click **Update** or **Delete** to review transaction information, and then either modify or delete it.

Click **Edit Trans Info** to edit the transaction date, accounting date, and the Transaction code.

Asset Addition Page

Use the Asset Addition page (PEND_TRANS_A1_SP) to review detail transaction information and then modify or delete the transaction.

Navigation:

Click the **Update** button or the **Delete** button on the Pending Trans Update/Delete page.

Field or Control	Description
Depreciation Status	You can change the status from <i>Depreciable</i> to <i>Non Depreciable</i> .
In Service Date	Captures when the asset was placed in service. You can modify this date.
Accum Depr in Current Pd (accumulate depreciation in current period)	Select if you want any accumulated depreciation for this asset to be booked to the current period. Do not select the check box if you want accumulated depreciation to be booked to the previous period, which you will probably have to reopen. The default setting for this option is disabled, or deselected. If you use this check box, remember to select it for each book for the asset transaction that you are modifying.

Asset Transaction Detail

Modify the transaction directly in the cost row or rows.

Only certain fields are available for editing, based on the type of transaction that you are modifying:

Field or Control	Description
Accum Depr (accumulated depreciation)	Add the amount of any depreciation that is already recognized for the asset. If you are adding assets that have depreciation from prior years or prior periods, you can enter the depreciation here if you forgot to enter it when you added the assets, or change it if you added depreciation before but want to change it now.

Transaction Type	Fields You Can Update
ADD	Cost, Quantity, ChartFields, Category, Cost Type, In Service Date, Depreciation Status, Accumulated Depreciation
ADJ	Cost, Quantity
RCT	Category, Cost Type
TRF	ChartFields

Transaction Information Page

Use the Transaction Information page (ASSET_TRNINFO4_SEC) to modify the transaction or accounting date.

Navigation:

Click the **Edit Trans Info** button on the Pending Trans Update/Delete page.

Trans Code (transaction code) is optional. It helps to identify which accounting entry template will be used for this transaction. You can select only those valid combinations for which accounting entry templates exist.

Adjusting for Asset Impairment

Use the Impairment (AM_IMPAIR) component or the CGU Impairment (AM_CGU_IMPAIR_RUN) component to perform impairment testing and create impairment adjustments to assets.

This topic provides an overview of impairment testing, lists the pages used for impairment testing.

Pages Used to Make Impairment Adjustments

<i>Page Name</i>	<i>Definition Name</i>	<i>Usage</i>
Impairment Worksheet Page	AM_IMPAIR	Select criteria to search for assets that can potentially be impaired, to process potential impairment, and to create loss adjustments automatically.
Cash Generating Unit Definition Page	AM_CGU_DEFN_01	Review the CGU definition. See Impairment Worksheet Page
More Filter Options Page	AM_IMPAIR_CF_SEC	Filter search criteria by selecting ChartFields: Operating Unit, Fund Code, Department, Program, Class Field, Budget Reference, Product, and Project. See Impairment Worksheet Page
Impairment Comments Page	AM_IMPAIR_COMMENTS	Enter comments about this impairment. See Impairment Worksheet Page
CGU Impairment Page	AM_CGU_IMP_RUN_CTL	Allocate impairment losses to individual assets on a CGU basis.

Page Name	Definition Name	Usage
<u>Cost and Depreciation Page</u>	AM_REPORT1	View impairment losses and reversals online using the Cost and Depreciation online view.
<u>View and Report Impairment Losses and Reversals</u>	AM_IMP_RPT_RUN_CTL	Generate reports by category or CGU ID of impaired asset values.

Understanding Impairment Testing

PeopleSoft supports the requirements of International Accounting Standard (IAS) 36 by providing an impairment test worksheet.

A generally accepted principle is that long-lived assets should be subject to some form of recoverable amount constraint, that is, that the carrying amount of an asset does not exceed the amount that is recoverable from the future economic benefits that the asset is expected to generate. When the carrying amount of an asset exceeds its recoverable amount, the asset is described as *impaired* and the carrying value should be reduced to the recoverable amount. Therefore, assets should be subject to some type of impairment evaluation or test. The purpose of an impairment or recoverable amount test is to identify such assets and ensure that losses of future economic benefits are properly recognized in a timely manner (asset values are reduced in the statement of financial position, and expenses are recognized in the statement of financial performance).

In pursuance of this principle, the International Accounting Standards Board has defined IAS 36. This requires that you ensure that your assets are carried at no more than their recoverable value. IAS 36 provides a list of external and internal indicators of impairment as well as requirements for an impairment assessment strategy and frequency-of-asset impairment review. Only assets that are identified as 'potentially impaired' require an impairment assessment. If you have an indication that an asset may be impaired, then the enterprise is required to calculate the asset's recoverable amount.

Note: To assess whether any assets you have are subject to impairment review, consult the most current published IAS standards.

PeopleSoft also enables the definition of a Cash Generating Unit (CGU) and the association of CGUs with business units to further support impairment testing. Impairment losses can be allocated to individual assets on a CGU basis using the CGU Impairment utility. This batch process allocates CGU impairment data for each asset and stores the details in the INTFC_FIN table. You can also initiate the transaction loader (AMIF1000) to process and update asset tables automatically.

If an organization cannot determine recoverable value for an individual asset, it must identify the lowest aggregation of assets that generate largely independent cash flows. These aggregations of assets are called CGUs. CGUs are defined as the smallest identifiable group of assets that generates cash inflows from continuing use, and are largely independent of the cash inflows from other assets or groups of assets. CGU should be defined consistently from period to period. However, an asset that was previously part of a CGU but which is no longer used, should be excluded from the CGU and assessed for impairment separately.

If you are required to perform impairment evaluation, at a minimum, you should evaluate assets at each balance sheet date. You can test assets or CGUs for impairment at any time.

Impairment processing is enabled at the installation level. Impairments are then processed on assets that are contained within the business unit where impairment processing is selected. You can select asset categories, profiles, books, accounting entry template, CGUs, and individual asset IDs for impairment processing.

To process calculation of impairment, the system compares the following information:

- Carrying amount: The net book value (NBV) of the asset as it is currently recorded in the accounts.
- Recoverable amount: The higher of an asset's Net Selling Price (NSP) or its Value In Use (VIU):
 - The NSP is obtained from the sale of an asset in a bargained transaction between knowledgeable, willing parties with reference to the price of an active market and less the costs of disposal.
 - The VIU is the present value of estimated future cash flows that are expected to arise from the continuing use of an asset, and from its disposal at the end of its useful life, (for example, the sum of discounted cash flows).

The impairment worksheet can also apply an index to the carrying cost and calculates the potential NSP/VIU cost. The system compares the carrying amount value to the recoverable amount value to calculate the potential impairment. Any difference is the *impairment loss*.

An impairment reversal is required when a change has occurred in the estimates that are used to determine the impairment loss. In this case, the carrying amount of the asset is increased to the recoverable amount, where the recoverable amount does not exceed the original carrying amount.

You can also select impairment processing when running the Cost and Depreciation process.

To view impairment loss and reversal, use the Cost and Depreciation Summary page (AM_REPORT1). To generate reports of impairments, use the Asset Impairment report (AM_IMPAIR_RPT_RUN) component.

Note: Impairment testing prescribed by IAS 36 is not required in all countries.

See “Understanding Asset Management Business and Cash Generating Units” (Asset Lifecycle Management Fundamentals).

Impairment Worksheet Page

Use the Impairment Worksheet page (AM_IMPAIR) to select criteria to search for assets that can potentially be impaired, to process potential impairment, and to create loss adjustments automatically.

Navigation:

Asset Management > Asset Transactions > Financial Transactions > Impairment Worksheet > Impairment Worksheet

This example illustrates the fields and controls on the Impairment Worksheet page (1 of 2). You can find definitions for the fields and controls later on this page.

Impairment Worksheet

Asset Search Criteria

*Business Unit	IMP01	Q	*Book Name	CORP	Q
Asset Category	ME	Q	Location		Q
Cash Generating Unit		Q	CGU Details		
Profile ID		Q			
From Asset ID		Q	To Asset ID		Q
			Chartfield Search Criteria		

Impairment Information

NSP Percentage(%)			<p>Fair Value</p> <p><input type="checkbox"/> Use FV</p> <p>FV Action: No Action</p> <p>FV Template ID: </p> <p>FV Group ID: </p> <p><input checked="" type="checkbox"/> Copy Impairment to other books</p> <p><input type="checkbox"/> Impairment Reversal</p>
VIU Percentage(%)			
Accounting Date	09/25/2018		
*Impairment Strategy	Assets		
Convention	FM	Q	
Transaction Code		Q	
Frequency	Annually		
*Impairment Date	09/25/2018		
Exclude Assets Impaired After			

Retrieve 100 New Search

Enter the asset search criteria and impairment information.

Field or Control	Description
Business Unit	Select the business unit (required). The business unit is supplied from the search dialog box.
Book Name	Select the book name (required). The Book Name field is initially supplied by the default book (when the book is enabled for impairment processing). The valid values include only books for which impairment processing is enabled.
Asset Category	Select the asset category to search for assets by category. The valid values include only categories for which impairment processing is enabled.
Location	Select the asset location to search for assets by location. The valid values include only locations for which impairment processing is enabled.
Cash Generating Unit	Select from the valid CGUs for this business unit, book, profile, or category if you want to impair at the CGU level.
Profile ID	Select the asset profile ID to search for assets by profile. The valid values include only locations for which impairment processing is enabled.

Field or Control	Description
From Asset ID and To Asset ID	Select an asset ID or a range of asset IDs to be included.
ChartField Search Criteria	Click the link to supply more filter options by ChartField to further narrow the search.
NSP Percentage (%) (net selling price percentage)	<p>Apply and enter a net selling price percentage to determine the actual NSP.</p> <p>Net selling price is the amount that is obtainable from the sale of an asset in a bargained transaction (between knowledgeable, willing parties), less the costs of disposal.</p> <p>For example, suppose the net book value of an asset is 10,000.00 USD. But the NSP is equal to 8,000.00 USD. The NSP percent is equal to 80 percent.</p>
Copy Impairment to other books	Select if you want the impairment carried over to other books.
VIU Percentage (%) (value in use percentage)	<p>Enter the value in use percentage that you expect to determine the actual VIU amount.</p> <p>Value in use is the present value of estimated future cash flows that are expected to arise from the continuing use of an asset, and from its disposal at the end of its useful life.</p> <p>For example, suppose the net book value of an asset is 23,500.00 USD. But the VIU is unknown. You can apply a percentage that you expect, such as 70 percent, and the system will calculate the actual amount to be 16,450.00 USD.</p>
Impairment Reversal	<p>Select if the potential impairment is a reversal of a prior impairment adjustment.</p> <hr/> <p>Note: This option appears only if impairment reversal is enabled for the business unit.</p> <hr/>
Accounting Date	Enter the accounting date of the impairment.
Convention	Select the depreciation convention. The valid values are derived from those that are defined for the business unit.

Field or Control	Description
Impairment Strategy	<p>Select the impairment strategy. Valid values are: <i>Asset</i> and <i>CGU</i>.</p> <ul style="list-style-type: none"> • <i>Asset</i>: If asset is selected, the system makes the impairment adjustment asset by asset. • <i>CGU</i>: If CGU is selected, the system calculates the adjustment to the whole CGU as a body. Impairment is based on all assets that are part of CGU definitions. If CGU is selected, then a cash generating unit must be provided. The CGU field in the search criteria section is only used to find out specific groups but it does not say what kind of impairment will apply to them.
Frequency	<p>Select the frequency for performing the impairment test. the options include <i>Yearly</i>, <i>Semiannually</i>, <i>Quarterly</i>, <i>Monthly</i>, and <i>Other</i></p>
Impairment Date	<p>This is the transaction date on which the system calculates carrying cost (NBV). The depreciation for the impairment month is included in the NBV calculation. For example, if the impairment date is between December 12, 2003 and December 12, 2003, period 12 is included in the accumulated depreciation for the calculation:</p> <p><i>NBV=Cost-ACCUM</i></p>
Exclude Assets Impaired After	<p>Enter the dates to exclude more recently impaired assets.</p>
Use FV(use fair value)	<p>Select to retrieve the fair values in the NSP amount or VIU amount fields instead of using the NSP Percentage(%) or VIU Percentage(%) fields for impairments. These fields become unavailable when selecting the Use FV field. If this check box is not selected, the fair values are retrieved from the NSP Percentage(%) or the VIU Percentage(%) fields for impairments.</p>

Field or Control	Description
FV Action (fair value action)	<p>Select the action by which to update the fair value records from the NSP or VIU amount fields. Select from the following fair value actions:</p> <ul style="list-style-type: none"> • <i>No Action</i> - (default) If Use FV is selected in conjunction with this action, the fair values are retrieved in the NSP or VIU amount fields but the fair values will not be updated. • <i>Update From NSP</i> - If Use FV is selected in conjunction with this action, the fair values are retrieved in the NSP Amount field to update impairments and fair values. • <i>Update From VIU</i> - If Use FV is selected in conjunction with this action, the fair values are retrieved in the VIU Amount field to update impairments and fair values. • <i>Update Higher</i> - If Use FV is selected in conjunction with this action, the fair values are updated from the higher value that is entered on the NSP or VIU Amount in the results grid.
FV Template ID (fair value template ID)	<p>Select an existing fair value template to populate the fair value fields. When the Retrieve button is pushed, the FV Template ID and Group ID in the Asset Search Results will be defaulted from the values in the Impairment Information section.</p>
FV Group ID (fair value group ID)	<p>Select when the valuation premise from the FV Template is <i>In-Use</i>. You can override the default value from the template. This field is unavailable if the valuation premise from the FV Template is <i>In-Exchange</i>.</p> <p>See “Defining Fair Value Processing” (Asset Lifecycle Management Fundamentals).</p>

Asset Search Results

When you are finished entering search criteria and impairment information, initiate the retrieval process. On completion, the **Search Criteria** group box collapses. The **Impairment Information** group box is visible, but unavailable for entry. You can initiate a new search or refine search of your returned results.

This example illustrates the fields and controls on the Impairment Worksheet page (2 of 2). You can find definitions for the fields and controls later on this page.

The screenshot shows the 'Impairment Worksheet' interface. At the top, there are sections for 'Asset Search Criteria' and 'Impairment Information'. Below these are buttons for 'Retrieve Next', 'Count Total', 'New Search', and 'Refine Search'. A row count indicator shows 'Rows 1 - 51'. A note states: 'Use the buttons below to mark assets for impairing or removing from the list. The changes will take effect after you click "Save" button.' Below this are buttons for 'Mark to Impair', 'Mark to not Impair', 'Remove From List', and 'Refresh'. The 'Asset Search Results' section features a search bar and a table with columns: Mark, Impair Status, Asset ID, Carry Cost (NBV), NSP(%), NSP Amount, VIU(%), VIU Amount, Impairment Loss, Revaluation Reversal, Carry Cost (Impairment), and Carry Cost (Revaluation). The table contains five rows of data, each with a checkbox in the 'Mark' column and a value of 71,699.97 in the 'Carry Cost (NBV)' column. The 'Impairment Loss' column shows -71,699.97 for each row.

The results of the assets matching the criteria that are entered are displayed in the **Asset Search Results** grid on the worksheet. The grid contains three tabs:

- Impairment Information
- Asset Information
- Comments and Attachments

Use the buttons to mark assets to be impaired and assets not to be impaired, to remove assets from the list, and to refresh the page.

Note: Selected assets must already have been processed for depreciation and included in the load depreciation report table process before they are available to be reported in the impairment worksheet.

Impairment Information

This section enables you to select or exclude selected assets for impairment.

Field or Control	Description
Mark 	When you click the Check button, you will select all assets in the list. Use Mark to select the line.
Mark to Impair	Click Mark to Impair and the system will set Impair Status to <i>Impair</i> for all selected rows.
Mark to not Impair	Click Mark to Not Impair and the system will set Impair Status to <i>Don't Impair</i> for all selected rows.

Field or Control	Description
Mark to Update FV	Click Mark to Update FV and the system will set Impair Status to <i>FV</i> for all selected rows.
Remove From List	Click Remove From List to remove selected rows from Asset Search Results.
Refresh	Click Refresh to recalculate all impairment information.
Impair Status	Displays the status of selected assets to be impaired or not to be impaired. Impaired assets will be inserted into INTFC_FIN table and Impairment audit tables. Not impaired assets will be inserted into the impairment audit tables.
Asset ID	Displays the asset ID for all assets meeting the search criteria.
Carry Cost (NBV)	Displays the current carry cost (net book value) of the asset.
NSP%	Enter the net selling price percentage that is applied to the carry cost.
NSP Amount	Enter the NSP as an amount in the base currency.
VIU%	Enter the value in use percentage that is applied to the carry cost.
VIU Amount	Enter the VIU as an amount in the base currency.
Impairment Loss	Displays the calculated impairment loss, usually the disposal cost. Impairment loss = NBV - (greater than NSP or VIU). You can override this amount.
Revaluation Reversal	If this asset had a revaluation before, you need to reverse the revaluation before you allocate the loss.
Carry Cost (Impairment)	The remaining amount that is attributable to prior impairment loss.
Carry Cost (Revaluation)	The remaining amount that is attributable to prior impairment reversal.

Field or Control	Description
Comments	Click the Comments link to access the Asset Comments page. Use this page to view or add relevant supporting comments to an asset transaction.
Attachments	Click the Attachments link to access the Asset Attachments page. You can view or add relevant supporting attachments to an asset transaction.

When you have reviewed and selected assets to be impaired, save the worksheet. The saving process performs the following tasks:

- The system creates a cost adjustment (with user define impairment loss cost type) for the impairment loss.
- The system creates a cost adjustment (user defined impairment reversal cost type) for the impairment revaluation reversal.
- The transaction date and the impairment date are inserted and is the same for this transaction.
- If you do not provide an accounting date, the system looks for the last day of the open period and books the transaction against that date. This date is validated against the open period.
- The system commits all validations at the time of the save.
- Upon saving the worksheet, the system places the actual adjustment in the staging table INTFC_FIN. The system loads the adjustment in the main asset tables when the transaction loader (AMIF1000) is run.
- The system automatically triggers the transaction loader (AMIF1000) to load the transactions if this option has been selected.
- The system validates that the impairment date is less than or equal to the accounting date.
- When the impairment reversal box is checked, the system processes impairment reversal instead of impairment loss.

CGU Impairment Page

Use the CGU Impairment page (AM_CGU_IMP_RUN_CTL) to allocate impairment losses to individual assets on a CGU basis.

Navigation:

Asset Management > Asset Transactions > Financial Transactions > Cash Generating Unit Impairment > CGU Impairment

This example illustrates the fields and controls on the CGU Impairment page. You can find definitions for the fields and controls later on this page.

The screenshot shows the 'CGU Impairment' page with the following fields and controls:

- Run Control ID:** 1
- Report Manager:** Process Monitor
- Run Button:** Run
- Request Section:**
 - *Request ID: 1
 - *Business Unit: IMP01
 - *CGU ID: USCGU_01
 - *Process Frequency: Always
 - *Book Name: CORP
 - Currency Code: USD
- CGU Details Section:**
 - Exclude Assets Impaired After: [Date]
 - *Impairment Date: 09/22/2009
 - *Accounting Date: 09/22/2009
 - Convention: FM
 - Impairment Strategy: CGU
 - *Impairment Frequency: Annually
 - Copy Impairment to other books
 - Impairment Reversal
 - Use FV
- Impairment Information Section:**
 - Carrying Values:** Calculate button, NBV field
 - Fair Value:** Calculate button, Fair Value field
 - Net Selling Price:** NSP(%) field, Or, NSP Amount field
 - Value In Use:** VIU(%) field, Or, VIU Amount field
- Calculate Impairment Loss:** Button
- Total Impairment Loss:** Field

Complete the applicable fields. When satisfied with the criteria, click **Run**. The batch process allocates CGU impairment data to each asset.

Request

<i>Field or Control</i>	<i>Description</i>
Business Unit	Select the business unit (required). The business unit is supplied from the search dialog box.
Book Name	Select the book name (required). The book is initially supplied by the default book (when the book is enabled for impairment processing). The valid values include only books for which impairment processing is enabled.
Currency Code	The currency code as defined for the Book.

Field or Control	Description
CGU ID	Select from the valid CGUs for this business unit, book, profile, or category if you want to impair at the CGU level.
Exclude Assets Impaired After	Enter dates to exclude more recently impaired assets.

Impairment Information

Field or Control	Description
Impairment Date	Enter the date of the asset impairment. This is the transaction date on which the system calculates carrying cost (NBV). The depreciation for the impairment month is included in the NBV calculation. The system uses the current date by default.
Impairment Strategy	<p><i>CGU:</i> Impairment based on all assets that are part of CGU definitions.</p> <p>The impairment strategy CGU appears by default when you are processing impairment in batch mode.</p>

Field or Control	Description
Copy Impairment to other books	<p>Select if you want the impairment carried over to other books.</p> <p>PeopleSoft Asset Management copies the impairment amount to other books in the ledger group as long as the Keep Ledgers in Sync (KLS) option is selected. If the option Copy to Other Books is checked, PeopleSoft Asset Management copies the same amount to the books with impairment amount selected, for books that do not point to the ledger group.</p> <p>Depending on the selection of these options, when Copy Zero Impair/Revalue Rows is checked, then the system copies zero impairment data in all the remaining books.</p> <p>For example: Suppose you have a business unit with six books (A, B, C, D, E, F), with the first three books, A, B and C pointing to a ledger group, the ledger group is synchronized with the general ledger business unit and book B is pointing to the primary ledger. However, the other three books, D, E and F do not point to general ledger and books A, B, C, and E have the impairment option enabled. PeopleSoft Asset Management processes impairment loss against the primary book B. The system then copies the impairment loss to book A and book C because they are in the same ledger group regardless of the status of the options Copy Impairment to other books and Copy Zero Impair/Revalue Rows. If Copy Impairment to other books is selected, the system copies the same impairment loss to book E because the impairment option is selected for that book. If the Copy Zero Impair/Revalue Rows option is selected, the system copies zero impairment loss into book D and F. If the Copy Impairment to other books option is not selected <i>and</i> the Copy Zero Impair/Revalue Rows option is selected, the system copies zero impairment rows to books D and F. When both options are not selected, the system does not copy any impairment or revaluation row to books D, E and F.</p> <p>See “Setting Up Cross-Application Installation Options” (Application Fundamentals), :Asset Management Page”.</p> <p>See “Creating PeopleSoft Asset Management Cash Generating Units” (Asset Lifecycle Management Fundamentals).</p>
Accounting Date	Enter the accounting date of the impairment.
Impairment Frequency	Select the frequency for performing the impairment test. The options include <i>Yearly</i> , <i>Semiannually</i> , <i>Quarterly</i> , <i>Monthly</i> , and <i>Other</i>

Field or Control	Description
Impairment Reversal	<p>Select for the system to process impairment reversal instead of impairment loss.</p> <p>Click the Calculate button to compute the net book value, prior impairment loss, and prior revaluation reversal.</p> <p>Click the Calculate Impairment Loss button to calculate the total impairment loss.</p> <hr/> <p>Note: This option is available only if impairment reversal is enabled for the business unit.</p> <hr/>
Convention	<p>Select the depreciation convention. The valid values are derived from those that are defined for the business unit.</p>
Use FV (use fair value)	<p>Select to retrieve fair values that were previously captured. This selection enables the Fair Value group box and disables the Carrying Values group box.</p> <hr/> <p>Note: You are not allowed to update fair values using the CGU impairment process.</p> <hr/>

Carrying Values

The NBV is the equivalent to the carrying value.

Click the **Calculate** button to retrieve the current NBV for the selected assets.

Fair Value

Field or Control	Description
Fair Value	<p>Click the Calculate button to retrieve the current fair value for the selected assets.</p>

Net Selling Price

<i>Field or Control</i>	<i>Description</i>
NSP Percentage (%) (net selling price percentage)	<p>Enter the net selling price percentage.</p> <p>For example, suppose the net book value of an asset is 10,000.00 USD. But the net selling price (NSP) is equal to 8,000.00. The NSP percent is equal to 80 percent.</p> <p>Net selling price is the amount obtainable from the sale of an asset in a bargained transaction (between knowledgeable, willing parties), less the costs of disposal.</p>
NSP Amount) (net selling price)	Enter the net selling price amount.

Value In Use

<i>Field or Control</i>	<i>Description</i>
VIU % (value in use percentage)	<p>Enter the value in use percentage.</p> <p>Value in use is the present value of estimated future cash flows that is expected to arise from the continuing use of an asset, and from its disposal at the end of its useful life.</p> <p>For example, suppose the net book value of an asset is 10,000.00 USD. But the VIU is equal to 7,200.00 USD. The VIU percent is equal to 72 percent.</p>
VIU Amount	Enter the value in use amount. Value in use is the present value of estimated future cash flows that are expected to arise from the continuing use of an asset, and from its disposal at the end of its useful life.

Click the **Calculate Impairment Loss** button to compute total impairment loss.

View and Report Impairment Losses and Reversals

This section discusses how to view and report impairment losses and reversals.

Viewing Impairment Loss Online

Use the Cost and Depreciation page (AM_REPORT1) to view impairment losses and reversals online using the Cost and Depreciation online view.

Navigation:

Asset Management > Financial Reports > Cost and Depreciation Summary > Cost and Depreciation

This example illustrates the fields and controls on the Cost and Depreciation page. You can find definitions for the fields and controls later on this page.

Cost and Depreciation							
Selection Criteria							
*Business Unit		US001	US001 NEW YORK OPERATIONS				
*Book Name		CORP	Corporate		Currency	USD	
*Fiscal Year		2009	Period		Group Type	None	
Secondary Selection Criteria							
Search		Clear					
Cost and Depreciation by Period							
Personalize [?] []							
Net Book Value Depreciation Activity Cost Activity []							
Period	Drill-down To	Current Depr	YTD Depr	LTD Depr	Cost	Salvage Value	NBV
1	--- Select Field ---			221,520.00	20,434,220.97	10,000.00	20,212,700.97
2	--- Select Field ---			221,520.00	20,449,459.94	12,000.00	20,227,939.94
3	--- Select Field ---			221,520.00	20,906,459.94	14,000.00	20,684,939.94
4	--- Select Field ---			221,520.00	20,906,459.94	14,000.00	20,684,939.94
5	--- Select Field ---			221,520.00	20,908,209.94	14,000.00	20,686,689.94
6	--- Select Field ---			221,520.00	20,908,209.94	14,000.00	20,686,689.94
7	--- Select Field ---			221,520.00	20,908,209.94	14,000.00	20,686,689.94
8	--- Select Field ---			221,520.00	20,908,209.94	14,000.00	20,686,689.94
9	--- Select Field ---			221,520.00	20,888,308.97	12,000.00	20,666,788.97
10	--- Select Field ---			221,520.00	20,888,308.97	13,080.00	20,666,788.97
11	--- Select Field ---			221,520.00	20,888,308.97	13,080.00	20,666,788.97
12	--- Select Field ---			221,520.00	20,888,308.97	13,080.00	20,666,788.97

Use the Cost and Depreciation online view to review impairment transactions. Search by business, book name, and fiscal year (all required) or search by selected secondary ChartField criteria.

Select to drill down to details for each period by asset ID, accumulated depreciation account, fixed asset account, asset category, asset profile, department, operating unit, product or project.

Reporting Asset Impairment Activity

Use the Impaired Asset Value Report page (AM_IMP_RPT_RUN_CTL) to generate reports by category or CGU ID of impaired asset values.

Navigation:

Asset Management > Financial Reports > Cost and Depreciation > Asset Impairment Report > Impaired Asset Value Report

This example illustrates the fields and controls on the Impaired Asset Value Report page. You can find definitions for the fields and controls later on this page.

The screenshot shows the 'Impaired Asset Value Report' interface. At the top, there are labels for 'Run Control ID 1', 'Report Manager', and 'Process Monitor', along with a 'Run' button. Below this is a 'Language' dropdown menu currently set to 'English'. A section titled 'Report Request Parameters' contains several input fields: '*Business Unit' with the value 'IMP01', '*Impairment Strategy' with a dropdown set to 'Assets', '*Impairment Date From' (empty), 'As of Date' with the value '12/14/2012', 'Book Name' (empty), 'Category' (empty), and '*Impairment Date To' (empty). Each date field has a calendar icon, and the business unit and book name fields have search icons.

Enter the report criteria for the report. You can have the report output sorted by asset category or by asset CGU ID. You can see the report formats in the Reports topic.

The business unit, impairment strategy and impairment date are required for the report.

Note: You *must* run the load depreciation report process for the dates on which you plan to evaluate the assets or CGU in order to perform the impairment.

See [Transaction Reports](#).

Reversing Asset Transactions

This topic provides an overview of the Transaction Reversal feature and discusses the steps to reverse transactions.

Pages Used to Reverse Asset Transactions

Page Name	Definition Name	Usage
Reversal Reason Codes Page	AM_REVERSAL_REASON	Use this page to create transaction reversal reasons and corresponding reason codes.
Transaction Reversal Page	AM_TXN_REVERSAL	Use this page to enter the parameters for the reversal and generate the reversal transaction.
Review Reversal Transaction Page	AM_REVERSAL_REVIEW	Use this page to review details about a reversed transaction.

Understanding Transaction Reversals

Occasionally asset transactions may be entered improperly into the system or applied to the wrong asset ID, thus creating errors in the depreciation calculation and corresponding accounting entries. To help you

reverse the erroneous transaction and correct the issue, PeopleSoft provides the Transaction Reversal feature. The Transaction Reversal feature automatically reverses the transaction last performed on the asset and provides a clear audit trail of each reversal.

Please note the following for transaction reversals:

- Transaction reversal can only be performed on assets that have completed the depreciation process.
- Transaction reversal is permitted for initial asset addition, subsequent asset additions, adjustments, Chartfield transfers, recategorizations, and interunit transfers.
 - Reversal of initial asset addition is permitted only when entries are not yet posted to General Ledger.
 - Reversal of initial asset addition results in deletion of depreciation and accounting entries for that particular transaction.
- Transaction reversal cannot be performed on leased assets, joint venture assets, group assets, or non-financial assets.
- Transaction reversal is performed based on the previous transaction, whether for one book or multiple books—that is, the reversal process automatically reverses the previous transaction performed on the asset.
- Reversal of a transaction other than the initial asset addition results in reversing the cost of the transaction.
- If a transaction is found to be erroneous prior to running the depreciation process, the user must modify the transaction using the Pending Trans Update/Delete page.

See [Pending Trans Update/Delete Page](#)

- Reinstatement of assets that have been retired in error, either partially or in full, is performed using the existing Retire/Reinstate Asset component.

See [Pages Used to Retire Financial Assets](#)

Steps to Reverse Transactions

Complete these steps to reverse transactions and restore assets to their state prior to the last depreciation calculation:

1. Select the **Reversal Reason Required** option on the AM Business Unit Definition page. (*Optional*)

This step is only necessary if you want to require users to select a transaction reversal reason when reversing transactions.

See “AM Business Unit Definition Page” (Asset Lifecycle Management Fundamentals)

2. Create a reversal reason using the Reversal Reason Codes page. You will associate the reason code with the transaction reversal. (*Optional*)

This step is only necessary if you want to require users to select a transaction reversal reason when reversing transactions.

See [Reversal Reason Codes Page](#)

- Reverse the transaction using the Transaction Reversal page.

See [Transaction Reversal Page](#)

- Review the transaction reversal using these pages:

- Review Reversal Transaction
- Cost History Detail
- Review Financial Entries - Detail

See:

[Review Reversal Transaction Page](#)

[Pages Used to View Cost History and Summarize Cost Rows](#)

[Pages Used to Create Accounting Entries](#)

Reversal Reason Codes Page

Use the Reversal Reason Codes page (AM_REVERSAL_REASON) to create transaction reversal reasons and corresponding reason codes.

Navigation:

Set Up Financials/Supply Chain > Product Related > Asset Management > Financials > AM Reversal Reason Code > Reversal Reason Codes

This example illustrates the fields and controls on the Reversal Reason Codes page. You can find definitions for the fields and controls later on this page.

The screenshot displays the 'Reversal Reason Codes' page. At the top, it shows 'SetID SHARE' and 'Reversal Reason Code INCORRECT ASSET'. Below this is a 'Reversal Reason Details' section with a search bar and navigation controls. The form contains the following fields:

- *Effective Date:** 05/07/2010 (with a calendar icon)
- *Status:** Active (dropdown menu)
- *Description:** INCORRECT ASSET
- Comment:** Transaction performed on wrong asset (text area)

Transaction Reversal Page

Use the Transaction Reversal page (AM_TXN_REVERSAL) to enter the parameters for the reversal and generate the reversal transaction.

Navigation:

Asset Management > Asset Transactions > Financial Transactions > Transaction Reversal > Transaction Reversal

This example illustrates the fields and controls on the Transaction Reversal page. You can find definitions for the fields and controls later on this page.

To reverse a transaction, use this page to enter the parameters for the reversal, then click Save. You must click Save in order for the transaction to be reversed.

Field or Control	Description
Transaction Type	Displays the transaction type for the transaction you are reversing.
Reversal Accounting Date	Enter a reversal accounting date. The system displays the current system date initially, but you can modify the value.
Reversal Reason Code	Enter a reversal reason code for this reversal. Reversal reasons are defined on the Reversal Reason page (AM_REVERSAL_REASON). If you selected the <i>Reversal Reason Required</i> option on the AM Business Unit Definition page, this field will be required.
Book	Displays the book associated with the transaction being reversed.
Depreciation Calc Status (Depreciation Calculation Status)	Displays the status of the depreciation calculation. Note that transaction reversal can only be performed on assets for which depreciation is already processed.

Field or Control	Description
Acctg Entry Creation Status (Accounting Entry Creation Status)	Displays the accounting entry creation status.
Accounting Entry Post Status	Displays the accounting entry post status.

Transaction Being Reversed

This section displays details of the transaction being reversed, such as cost, currency, department, and so forth. Click the Save button to reverse the selected transaction.

Transaction Reversal Created

This section provides a preview of the transaction reversal that will be created and displays reversal details, such as costs and quantities reversed. You must still click Save in order for the transaction to be reversed.

You can view additional details about the reversed transaction using the Review Reversal Transaction page.

Note: This section does not display when reversing initial *Asset Addition* transactions.

Adding and Reviewing Comments

Click the Comments link to access the Transaction Reversal - Comments (AM_COMMENTS_SEC) page and view or add relevant supporting comments to an asset transaction.

This example illustrates the fields and controls on the Transaction Reversal - Comments page.

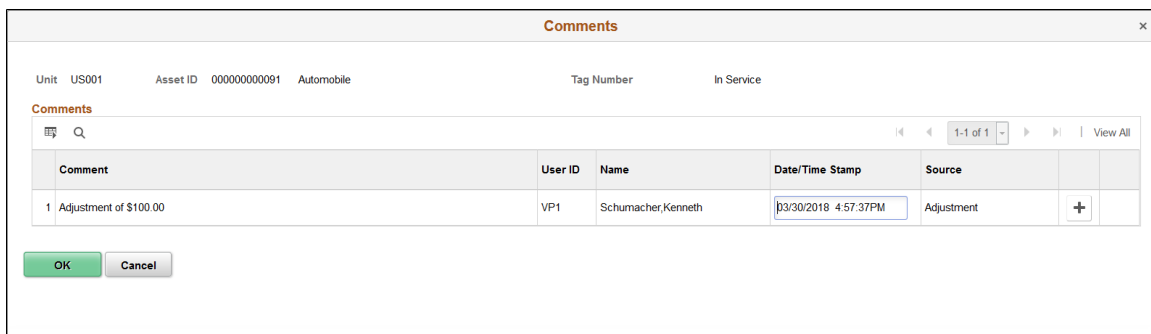

Field or Control	Description
Comment	Enter comments for an asset.
User ID, Name and Date/Time Stamp	Displays the user ID, name, and date/time stamp related to the user who added the comment. You can edit the date/time stamp after saving the comment.

Field or Control	Description
Source	Displays the transaction source for the asset, such as adjustment, transfer, and so forth.

Adding and Reviewing Attachments

Click the Attachments link to access the Transaction Reversal - Attachments (AM_ADD_ATTACH_SEC) page and view or add relevant supporting documents to an asset transaction.

This example illustrates the fields and controls on the Transaction Reversal - Attachments page.

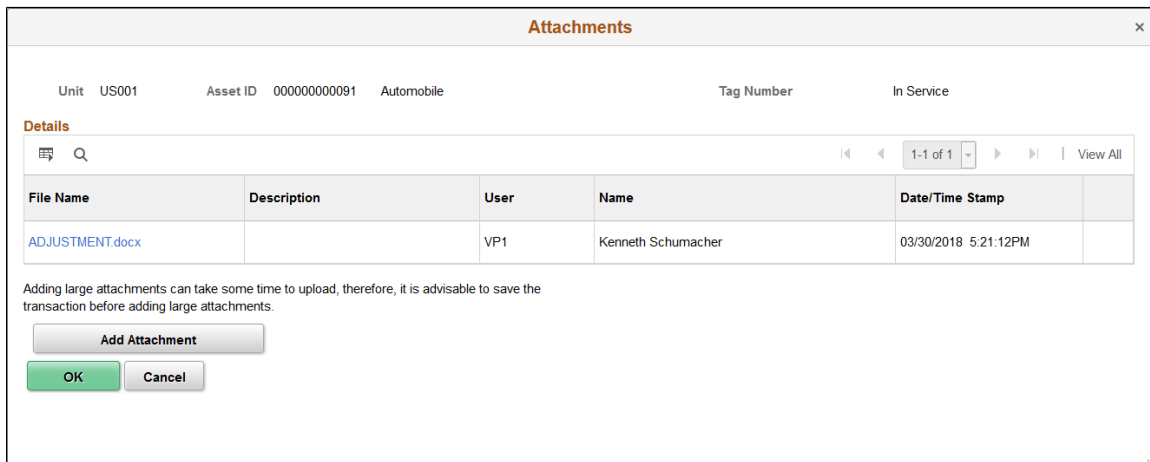

Field or Control	Description
Add Attachment	Click this button to attach files as supporting documentation for an asset. Supply a description of the file or files that you attach.
File Name	Displays the attached file. Click the file-link to access the file.
Description	Displays a description of the file attachment when one was provided by the user.
User, Name, and Date/Time Stamp	Displays the user ID, name, and date/time stamp related to the user who added the attachment.

Review Reversal Transaction Page

Use the Review Reversal Transaction page (AM_REVERSAL_REVIEW) to review details about a reversed transaction.

Navigation:

Asset Management > Asset Transactions > Financial Transactions > Review Transaction Reversal > Review Reversal Transactions

This example illustrates the fields and controls on the Review Reversal Transaction page. You can find definitions for the fields and controls later on this page.

Review Reversal Transactions

Unit US001 Asset ID 00000000152 Machinery & Equipment Tag In Service

[Audit Logs](#)

Reversal Reason Code

Comment

Transaction Details						Personalize Find View All First 1-2 of 2 Last
Asset Book Name	Transaction Type	Transaction Date	Accounting Date	Date/Time Stamp	User ID	
1 CORP	Asset Cost Adjustment	01/01/2015	08/03/2015	08/03/15 9:50:09PM	DVP1	
2 FEDERAL	Asset Cost Adjustment	01/01/2015	08/03/2015	08/03/15 9:50:09PM	DVP1	

This page displays details for a reversed transaction, such as the corresponding asset book, transaction type, and user ID of the individual who performed the reversal.

Click the **Audit Logs** link to access the Search Audit Logs pagelet and view detailed audit information for the reversed transaction.

This example illustrates the fields and controls on the Search Audit Logs pagelet.

Search Audit Logs

Application Name Asset Management Document Name AM ASSETS

Search Criteria

- * Business Unit is equal to
- * Asset Identification is equal to
- Event Code is equal to
- Event Date is equal to
- User ID is equal to
- Process Instance is equal to

Include Archive
 Include Batch Changes
 Include Purge Logs

Search Results								Personalize Find First 1 of 1 Last
Business Unit	Asset Identification	Event Code	Event Name	Event Date Time	User ID	Process Instance	Message Text	
US001	00000000148	ASSET_REV	Asset Reversal	06/27/2015 3:12:32.000000PM	VP1		Reversal Transaction was performed on transaction date 2015-01-01 and accounting date 2015-03-01. The transaction reversed was Addition	

Chapter 12

Approving Assets Using the PeopleSoft Fluid User Interface

Approving Assets Using the PeopleSoft Fluid User Interface

This topic discusses approving asset transactions using the PeopleSoft Fluid User Interface.

Pages Used to Approve Asset Transactions in the PeopleSoft Fluid User Interface

<i>Page Name</i>	<i>Definition Name</i>	<i>Usage</i>
<u>Pending Approvals - Asset Adjustment Page</u>	EOAWMA_MAIN_FL	View a list of all asset adjustment transactions that are pending your approval.
<u>Asset Adjustment - Approval Header Detail Page</u>	EOAWMA_TXNHDTL_FL	View asset adjustment summary and line detail information, and approve, push back, or deny the adjustment.
<u>Pending Approvals - Asset Inter Unit Transfer Page</u>	EOAWMA_MAIN_FL	View a list of all asset inter unit transfers that are pending your approval.
<u>Asset Inter Unit Transfer - Approval Header Detail Page</u>	EOAWMA_TXNHDTL_FL	View asset inter unit transfer summary and line detail information, and approve, push back, or deny the transfer.
<u>Pending Approvals - Asset Transfer Page</u>	EOAWMA_MAIN_FL	View a list of all asset transfers that are pending your approval.
<u>Asset Transfer - Approval Header Detail Page</u>	EOAWMA_TXNHDTL_FL	View asset transfer summary and line detail information, and approve, push back, or deny the transfer.
<u>Pending Approvals - Asset Physical Transfer page</u>	EOAWMA_MAIN_FL	View a list of all asset physical transfers that are pending your approval.
<u>Asset Physical Transfer - Header Detail page</u>	EOAWMA_TXNHDTL_FL	View asset physical transfer summary and asset and transaction details, and approve, push back, or deny the transfer.

Page Name	Definition Name	Usage
<u>Pending Approvals - Asset Retire Page</u>	EOAWMA_MAIN_FL	View a list of asset retirement requests routed to you and approve or deny an asset retire request.
<u>Asset Retire - Header Detail page</u>	EOAWMA_TXNHDTL_FL	View the asset and transaction details, and approve, push back, or deny the asset retirement request.
<u>Pending Approvals - Asset Disposal Page</u>	EOAWMA_MAIN_FL	Approve or deny an asset disposal request.
<u>Asset Disposal - Approval Header Detail Page</u>	EOAWMA_TXNHDTL_FL	View the details of the originator, who requested the asset disposal and approve, deny, push back, or hold an asset disposal request.
<u>Pending Approvals - Asset Self Service Page</u>	EOAWMA_MAIN_FL	View a list of all asset self service that are pending approval.
<u>Asset Self Service - Approval Header Details Page</u>	EOAWMA_TXNHDTL_FL	View the list of asset self service requests routed for approval, asset details, activity details, and approve, deny, or hold self service approval requests.
<u>Pending Approvals - Asset Addition Reversal Page</u>	EOAWMA_MAIN_FL	View a list of all asset addition reversals that are pending your approval.
<u>Asset Addition Reversal - Approval Header Detail Page</u>	EOAWMA_TXNHDTL_FL	View asset addition reversal summary and line detail information, and approve, push back, or deny the addition reversal.
<u>Pending Approvals - Asset Adjustment Reversal Page</u>	EOAWMA_MAIN_FL	View a list of all asset adjustment reversals that are pending your approval.
<u>Asset Adjustment Reversal - Approval Header Detail Page</u>	EOAWMA_TXNHDTL_FL	View asset adjustment reversal summary and line detail information, and approve, push back, or deny the adjustment reversal.
<u>Pending Approvals - Asset InterUnit Reversal Page</u>	EOAWMA_MAIN_FL	View a list of all asset interunit reversals that are pending your approval.
<u>Asset InterUnit Reversal - Approval Header Detail Page</u>	EOAWMA_TXNHDTL_FL	View asset interunit reversal summary and line detail information, and approve, push back, or deny the interunit reversal.

Page Name	Definition Name	Usage
<u>Pending Approvals - Asset Transfer Reversal Page</u>	EOAWMA_MAIN_FL	View a list of all asset transfer reversals that are pending your approval.
<u>Asset Transfer Reversal - Approval Header Detail Page</u>	EOAWMA_TXNHDTL_FL	View asset transfer reversal summary and line detail information, and approve, push back, or deny the transfer reversal.
<u>Pending Approvals - Asset Mass Transaction Page</u>	EOAWMA_MAIN_FL	View a list of all asset mass transactions that are pending your approval.
<u>Asset Mass Transaction - Approval Header Detail Page</u>	EOAWMA_TXNHDTL_FL	View asset mass transaction summary and interface line detail information, and approve, push back, or deny the mass transaction.
<u>Pending Approvals - Asset Upload Spreadsheet Data</u>	EOAWMA_MAIN_FL	View a list of all spreadsheet asset upload transactions that are pending your approval.
<u>Asset Upload Spreadsheet Data - Approval Header Detail Page</u>	EOAWMA_TXNHDTL_FL	View asset upload spreadsheet data, summary, and interface line detail information, and approve, push back, or deny the asset upload transaction.

Understanding Asset Approvals Using the Fluid User Interface

PeopleSoft provides mobile approvals using the Enterprise Component Fluid Approvals framework. Approvers can take Application Workflow Engine (AWE) actions on select PeopleSoft transactions pending their approval using the Fluid User Interface.

Using the PeopleSoft Fluid User Interface approvers can review a list of pending approvals for asset:

- Cost adjustments
- Cost line additions
- Cost transfers (including interunit and chartfield transfers)
- Cost recategorizations
- Cost revaluations
- Fixed price markups
- Addition reversal
- Adjustment reversal
- Interunit transfer reversal

- Transfer reversal
- Disposals
- Self service
- Mass Transactions
- Asset Upload Spreadsheet

Approvers can access the pending approvals using the Approvals tile:

Approvals tile in the Fluid User Interface

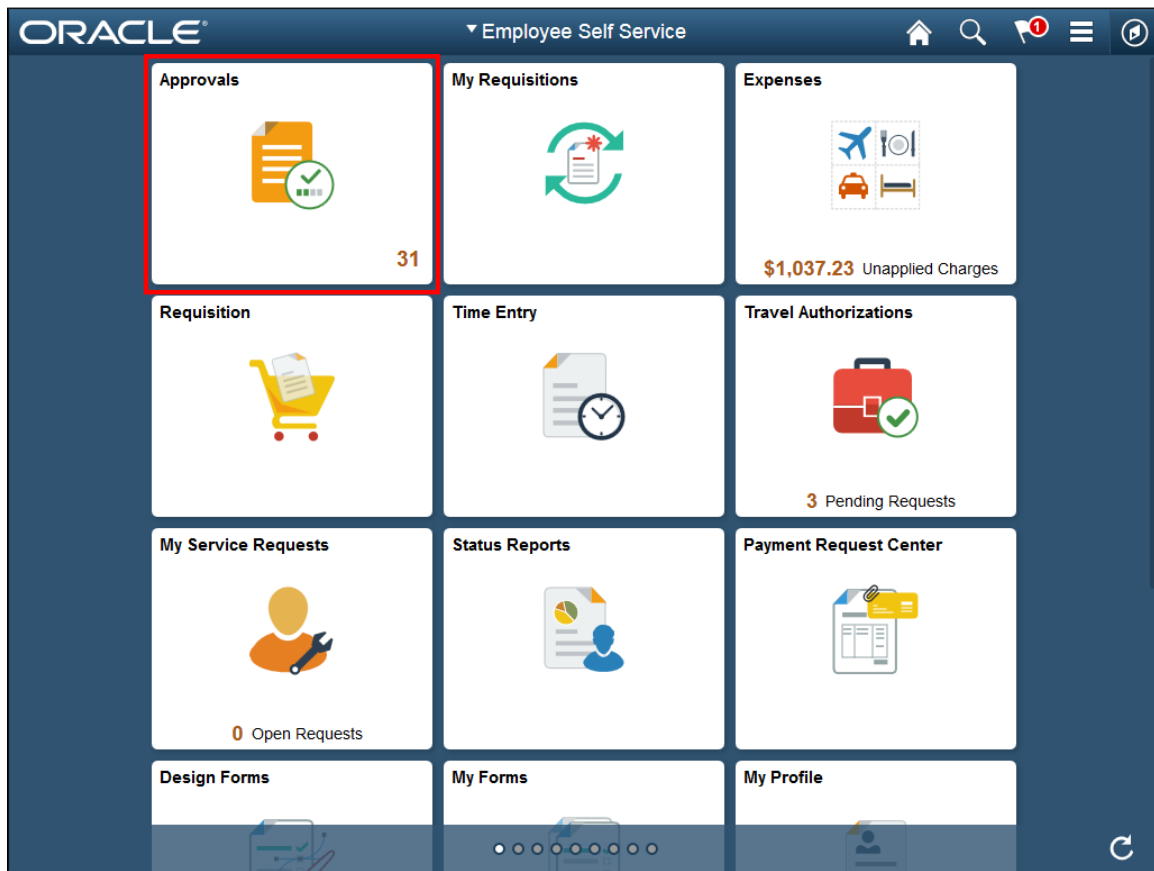

Approvers can perform the following actions using the approval pages:

- Review asset transaction summary and description.
- View line summary.
- Approve or deny the asset transaction.
- Add comments for approval actions and view comments from previous reviewers.
- View attachments related to the approval.
- View the approval chain.

Oracle PeopleSoft delivers Notification Composer Framework to manage the setup and administration of notifications in one central location. Once you have adopted the Notification Composer feature, you must use it to create new notifications and manage your existing notifications.

For more information about Notification Composer Framework, see “Understanding Notification Composer” (Enterprise Components).

Asset Transaction Approval Sequence

Asset transaction approvals follow this sequence:

1. A requester performs a cost adjustment, transfer, recategorization, revaluation, line addition, or other modification to an asset and saves the transaction.
2. The transaction data is flagged as approval pending.

While the asset is flagged as approval pending, users cannot perform further transactions on the asset.

3. The approver approves or denies the transaction.

Upon final approval or denial, users can resume transactions on the asset.

Assets Pending Approval

While an asset is flagged as approval pending, users cannot perform transactions on the asset. In addition, users cannot process depreciation calculations. When users load an asset with approval pending on any transaction component, the following message appears: *Transactions cannot be performed on the asset as approval is still pending.* Upon final approval or denial, users can resume transactions on the asset.

Approval Pending Flag

The Cost History and Print Asset components display an **Approval Pending** option used to indicate an asset is pending approval.

The Search for an Asset page also includes the **Approval Pending** option, but is used to search for assets that are pending approval.

See:

[Pages Used to View Cost History and Summarize Cost Rows](#)

[Page Used to Print Asset Information](#)

[Search for an Asset Page](#)

Understanding Fluid Approval Set Up

This section discusses how to set up Fluid approvals for Asset Management.

Enable Approval Workflow

Enable the approval workflow using the *Enable Adjustment Approval*, *Enable Transfer Approval*, *Enable InterUnit Approval*, or *Enable Reversal Approval* options on the AM Business Unit Definition page.

See “AM Business Unit Definition Page” (Asset Lifecycle Management Fundamentals)

Set Up Approval Framework

PeopleSoft delivers the approval process IDs on the following Enterprise Components setup pages:

- Register Transactions page (Enterprise Components > Approvals > Approvals > Transaction Registry > Register Transactions).

You should not modify the values on this page (with the exception of the Notification Options values, which you can alter).

- Configure Transactions page (Enterprise Components > Approvals > Approvals > Transaction Configuration > Configure Transactions).

You can modify the values on this page to meet your approval requirements.

PeopleSoft delivers the following approval process IDs for asset approvals:

- *AMCostAdjustTransfer*: used for cost adjustment and revaluation approvals.
- *AssetCostTransfer*: used for cost recategorization and chartfield transfer approvals.
- *AssetCostIUT*: used for cost fixed price markup and interunit transfer approvals.
- *AMDisposal*: used for disposal worksheet approvals.
- *AMSelfService*: used for self service approvals.
- *AssetReversalADD*: used for asset addition reversal approvals.
- *AssetReversalADJ*: used for asset adjustment reversal approvals.
- *AssetReversalIUT*: used for asset interunit transfer reversal approvals.
- *AssetReversalTRF*: used for asset transfer reversal approvals.
- *AMMTM*: used for mass transaction manager approvals.
- *AMUSD*: used for asset upload spreadsheet data approvals.

See:

“Register Transactions Page” (Approval Framework)

“Configure Transactions Page” (Approval Framework)

Set Up User Roles and Permissions

Define approval path steps by user role on the Setup Process Definitions page (Enterprise Components > Approvals > Approvals > Approval Process > Setup Process Definitions) for these process IDs:

- *AMCostAdjustTransfer*
- *AssetCostTransfer*
- *AssetCostIUT*

- *AMDisposal*
- *AMSelfService*
- *AssetReversalADD*
- *AssetReversalADJ*
- *AssetReversalIUT*
- *AssetReversalTRF*
- *AMMTM*
- *AMUSD*

PeopleSoft delivers Supervisor and Manager approval levels, but you can modify these to meet the need of your organization.

Next use the User List Definition page (Enterprise Components > Approvals > Approvals > User List Setup) to define approval user lists to use with the approval process.

See:

“Setup Process Definitions Page” (Approval Framework)

“User List Definition Page” (Approval Framework)

Review Registered Components and Configure Page Composer

Use the Developer Registration page of Page Composer (Enterprise Components > Page Composer Administrator > Developer Registration > Registration) to review a list of registered components. You can edit existing components per your business needs. Registered components and the changes made to them are then available in the Toolbox panel in Page Composer.

Next use the Page Composer page (Enterprise Components > Page Composer > Page Composer) to edit the design of the Fluid Approval pages based on the registered components. Users can design the existing placement of the fields in the fluid approval pages as well as add buttons and links in line with specific business requirements.

See:

“Registration Page” (Enterprise Components)

“Page Composer Page” (Enterprise Components)

Related Links

“Understanding Approval Framework in Asset Management” (Asset Lifecycle Management Fundamentals)

“Completing the Approval Transaction Registry and Configuration” (Asset Lifecycle Management Fundamentals)

Common Elements Used in This Topic

Common elements used in this topic.

<i>Field or Control</i>	<i>Description</i>
Approve	Select this button to approve the transaction. The system prompts you to provide comments and submit the approval. This action routes the approval to the next approver in the chain.
Deny	Select this button to deny the transaction. The system prompts you to provide comments and submit the denial. When you deny a transaction, the status changes to Denied and the transaction is removed from the approval queue.
Pushback	Select this button to push back the approval request to the previous step.

Pending Approvals - Asset Adjustment Page

Use the Pending Approvals - Asset Adjustment page (EOAWMA_MAIN_FL) to view a list of all asset adjustment transactions that are pending your approval.

Navigation:

Approvals (tile) > Select Asset Adjustment in the approval list panel on the left side of the page.

This example illustrates the fields and controls on the Pending Approvals - Asset Adjustment page.

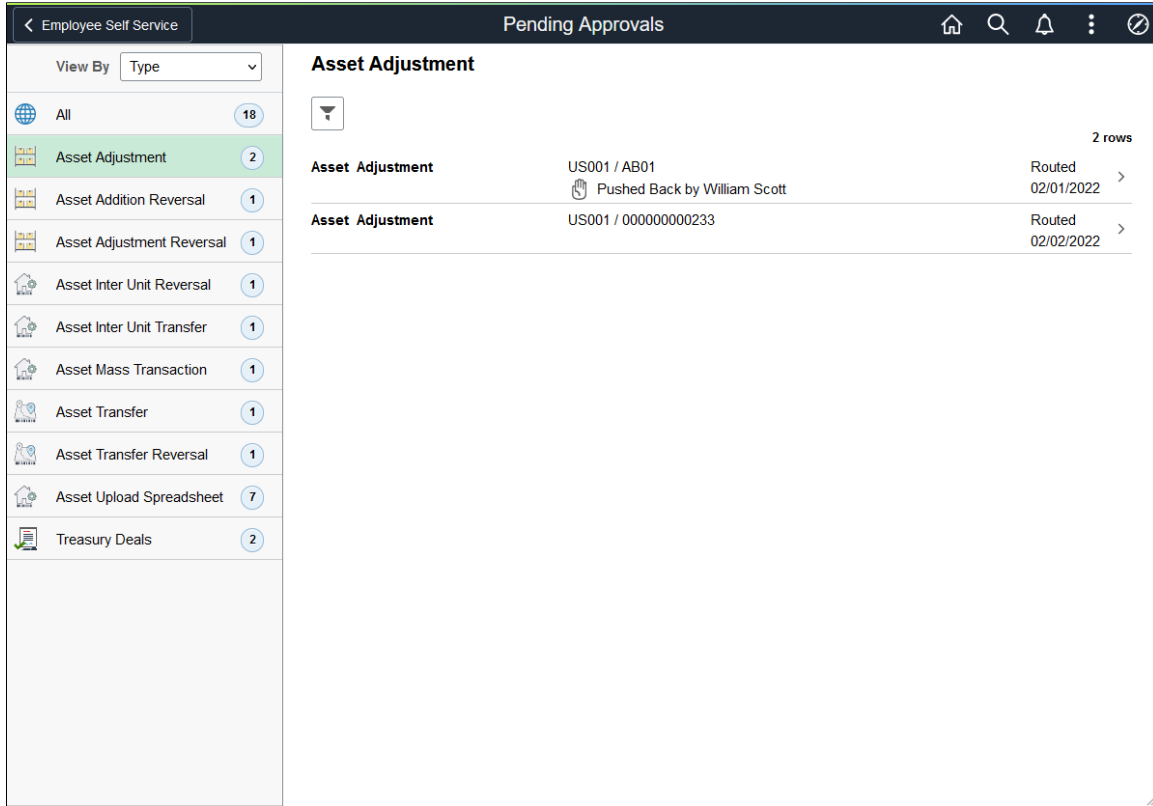

Select the Filter button to access the Filters page. Use the filter to refine the results displayed in the pending approvals list.

Select an Asset Adjustment row to access the Asset Adjustment - Approval Header Detail page and review adjustment details. You can also approve or deny the adjustment from this page.

Asset Adjustment - Approval Header Detail Page

Use the Asset Adjustment - Approval Header Detail page (EOAWMA_TXNHDTL_FL) to view asset adjustment, line summary, and line detail information, and approve, push back, or deny the adjustment.

Navigation:

Select an Asset Adjustment row from the Pending Approvals - Asset Adjustment page.

This example illustrates the fields and controls on the Asset Adjustment - Approval Header Detail page.

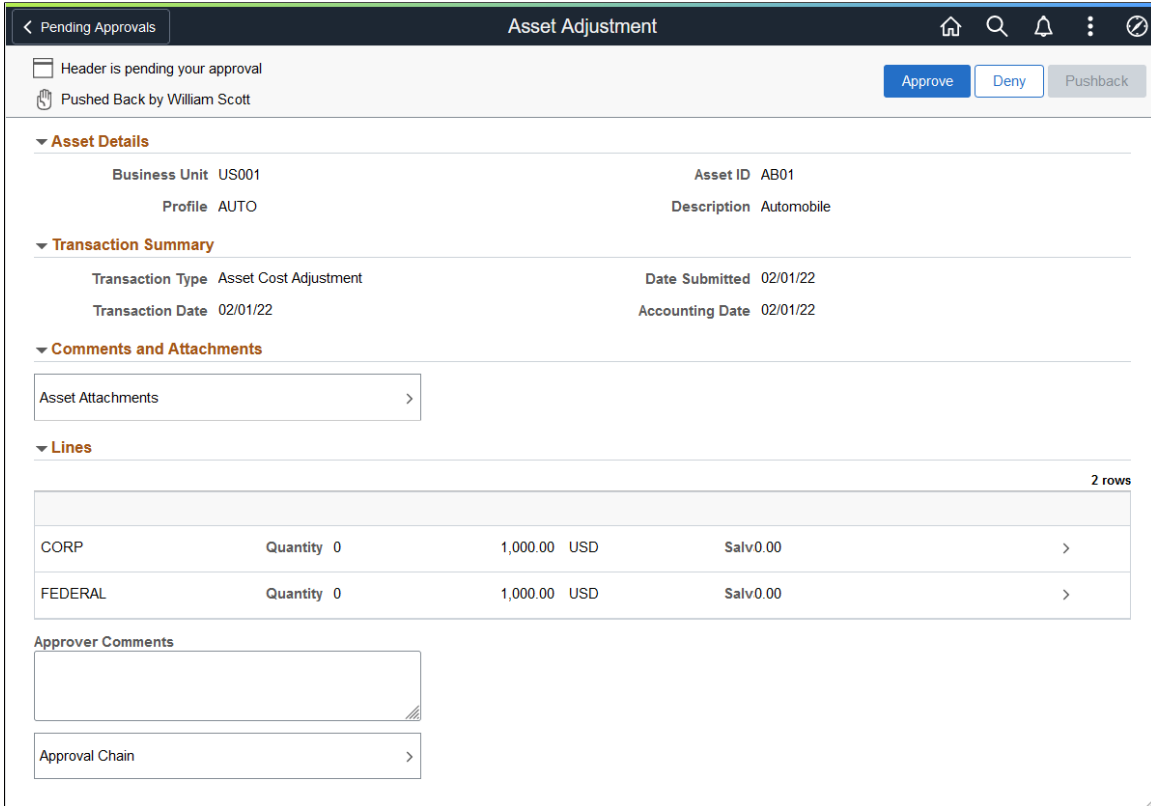

Review asset adjustment, transaction summary, and line summary information, then select a row in the **Lines** grid to access the Approval Line Detail page and view line details.

Select **Asset Attachments** to access the Comments and Attachments pagelet and view comments and attachments related to the asset for approval.

Select **Approval Chain** to access the Approval Chain pagelet and view the approval hierarchy.

Asset Adjustment - Comments and Attachments Page

Use the Asset Adjustment - Comments and Attachments page to view comments and attachments related to the asset for approval.

This example illustrates the fields and controls on the Asset Adjustment - Comments and Attachments page.

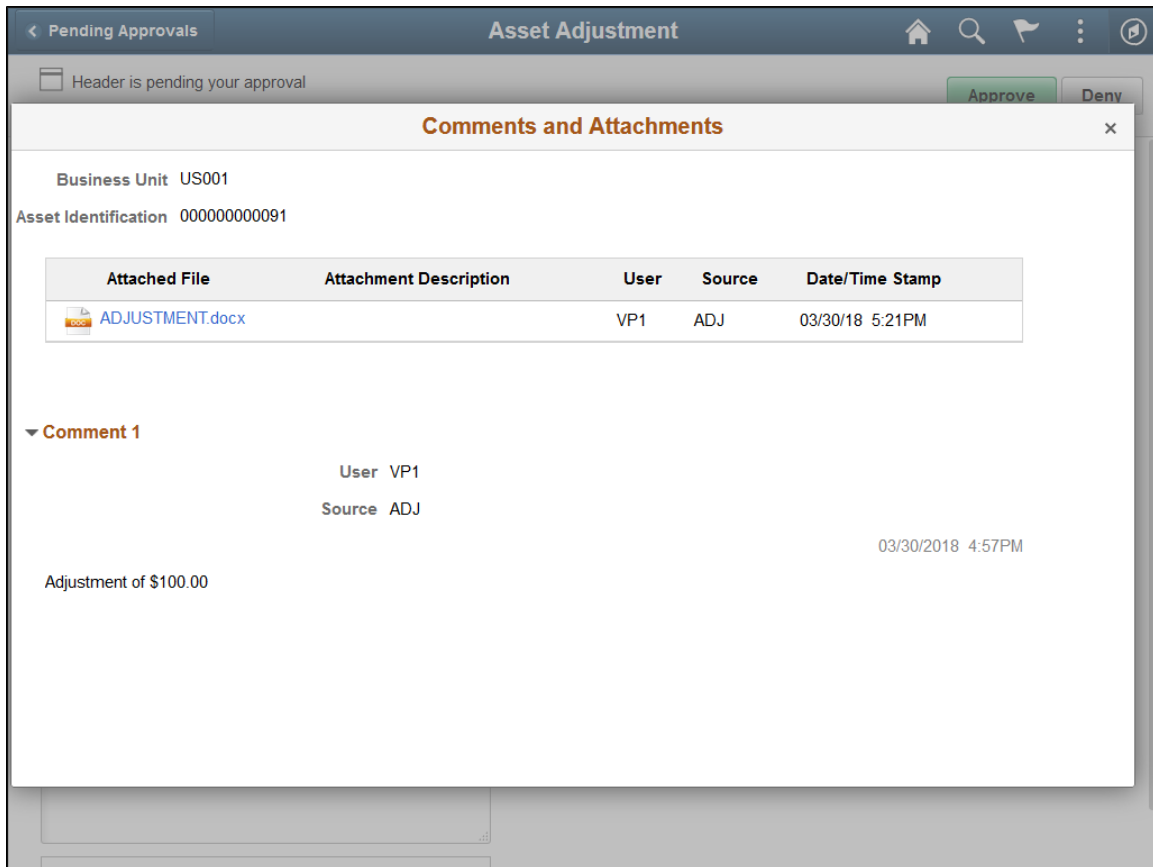

Pending Approvals - Asset Inter Unit Transfer Page

Use the Pending Approvals - Asset Inter Unit Transfer page (EOAWMA_MAIN_FL) to view a list of all asset inter unit transfers that are pending your approval.

Navigation:

Approvals (tile) > Select Asset Inter Unit Transfer in the approval list panel on the left side of the page.

This example illustrates the fields and controls on the Pending Approvals - Asset Inter Unit Transfer page.

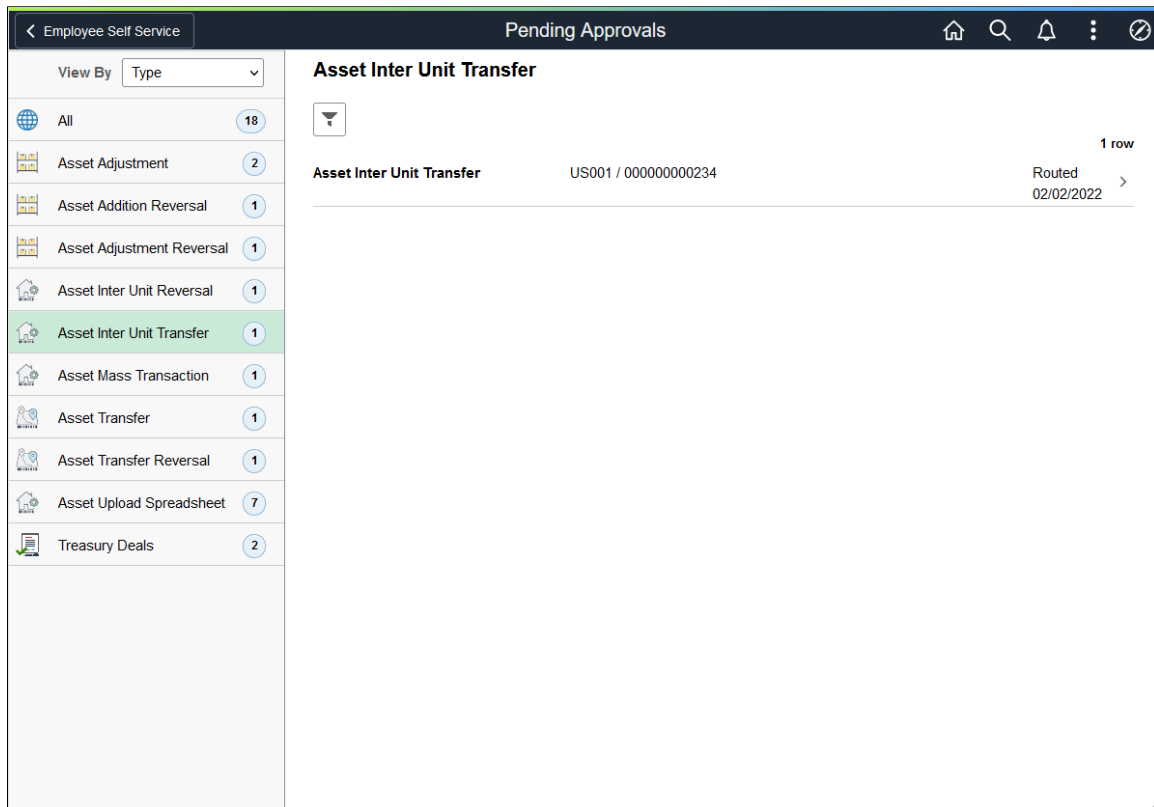

Select the Filter button to access the Filters page. Use the filter to refine the results displayed in the pending approvals list.

Select an Asset Inter Unit Transfer row to access the Asset Inter Unit Transfer - Approval Header Detail page and review transfer details. You can also approve or deny the transfer from this page.

Asset Inter Unit Transfer - Approval Header Detail Page

Use the Asset Inter Unit Transfer - Approval Header Detail page (EOAWMA_TXNHDTL_FL) to view asset transfer, line summary, and line detail information, and approve, push back, or deny the transfer.

Navigation:

Select an Asset Inter Unit Transfer row from the Pending Approvals - Asset Inter Unit Transfer page.

This example illustrates the fields and controls on the Asset Inter Unit Transfer - Approval Header Detail page.

Asset Inter Unit Transfer

Header is pending your approval

Approve Deny Pushback

Asset Details

Business Unit US001 Asset 000000000234
 Profile ID AUTO Description Automobile

Transaction Summary

Transfer To Business Unit US002 Transfer To Asset ID 000000000008
 Transaction Date 02/02/22 Accounting Date 02/02/22

Comments and Attachments

Asset Attachments >

Lines 2 rows

CORP	-20,000.00	USD	Out	>
FEDERAL	-20,000.00	USD	Out	>

Approver Comments

Approval Chain >

Review asset transfer, transaction summary, and line summary information, then select a row in the **Lines** grid to access the Approval Line Detail page and view line details.

Select **Asset Attachments** to access the Comments and Attachments pagelet and view comments and attachments related to the asset for approval.

Select **Approval Chain** to access the Approval Chain pagelet and view the approval hierarchy.

Pending Approvals - Asset Transfer Page

Use the Pending Approvals - Asset Transfer page (EOAWMA_MAIN_FL) to view a list of all asset transfers that are pending your approval.

Navigation:

Approvals (tile) > Select Asset Transfer in the approval list panel on the left side of the page.

This example illustrates the fields and controls on the Pending Approvals - Asset Transfer page.

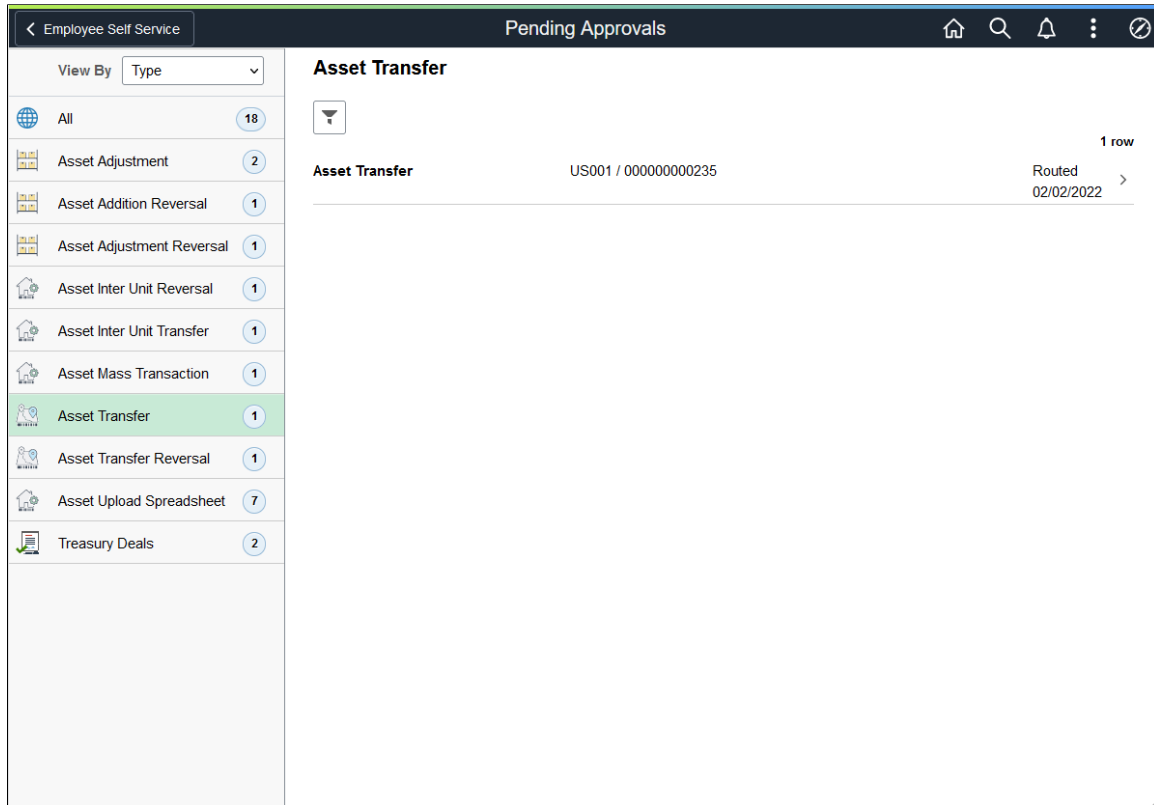

Select the Filter button to access the Filters page. Use the filter to refine the results displayed in the pending approvals list.

Select an Asset Transfer row to access the Asset Transfer - Approval Header Detail page and review transfer details. You can also approve or deny the transfer from this page.

Asset Transfer - Approval Header Detail Page

Use the Asset Transfer - Approval Header Detail page (EOAWMA_TXNHDTL_FL) to view asset transfer, line summary, and line detail information, and approve, push back, or deny the transfer.

Navigation:

Select an Asset Transfer row from the Pending Approvals - Asset Transfer page.

This example illustrates the fields and controls on the Asset Transfer - Approval Header Detail page.

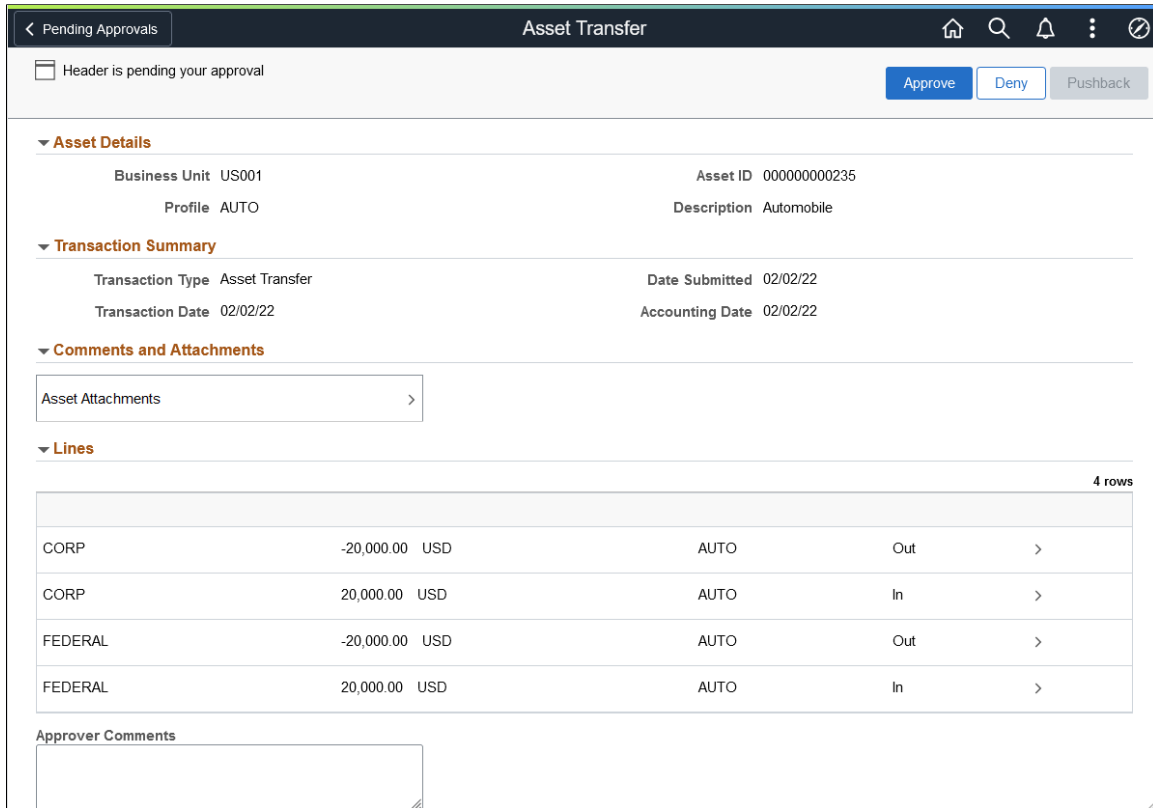

Review asset transfer, transaction summary, and line summary information, then select a row in the **Lines** grid to access the Approval Line Detail page and view line details.

Select **Asset Attachments** to access the Comments and Attachments pagelet and view comments and attachments related to the asset for approval.

Select **Approval Chain** to access the Approval Chain pagelet and view the approval hierarchy.

Pending Approvals - Asset Physical Transfer page

Use the Asset Physical Transfer page (EOAWMA_MAIN_FL) to view a list of physical asset transfers that are pending your approval.

Navigation:

Approvals (tile) > Select Asset Physical Transfer in the approval list panel on the left side of the page.

This example illustrates the fields and controls on the Pending Approvals - Asset Physical Transfer page. You can find definitions for the fields and controls later on this page.

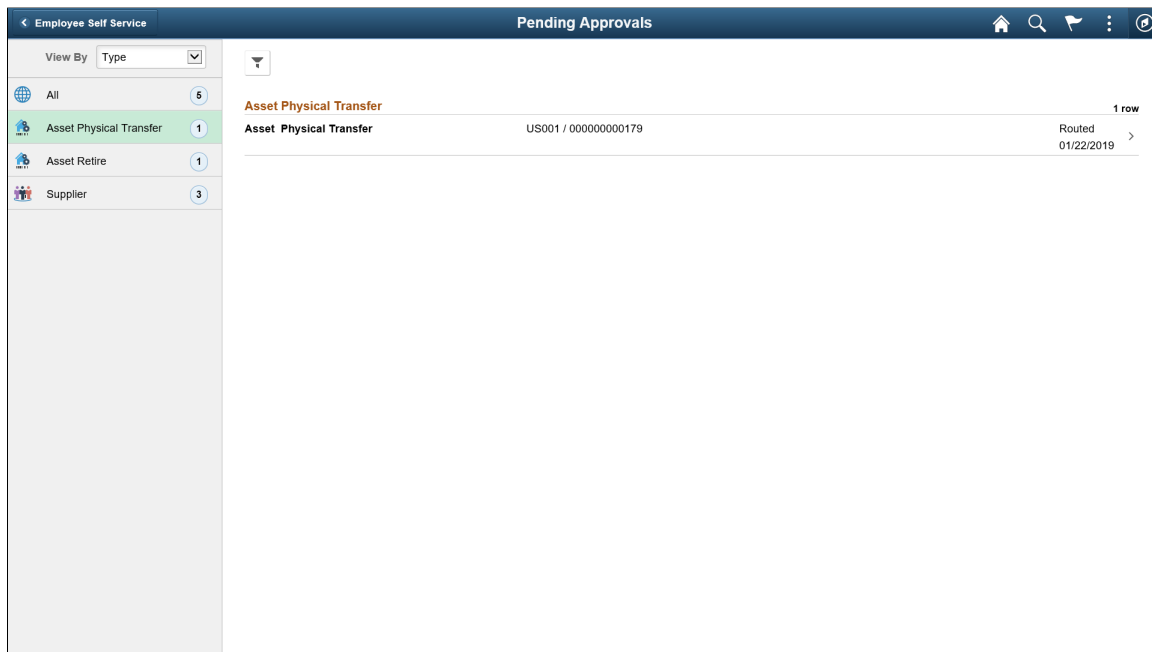

Select an asset physical transfer row to access the Asset Physical Transfer - Approval Header Detail page and review transfer details. You can also approve or deny the transfer from this page.

Asset Physical Transfer - Header Detail page

Use the Asset Physical Transfer - Approval Header Detail page (EOAWMA_TXNHDTL_FL) to view asset and transaction details, and approve, push back, or deny the transfer.

Navigation:

Select an asset physical transfer row from the Pending Approvals - Asset Physical Transfer page.

This example illustrates the fields and controls on the Asset Physical Transfer - Header Detail page. You can find definitions for the fields and controls later on this page.

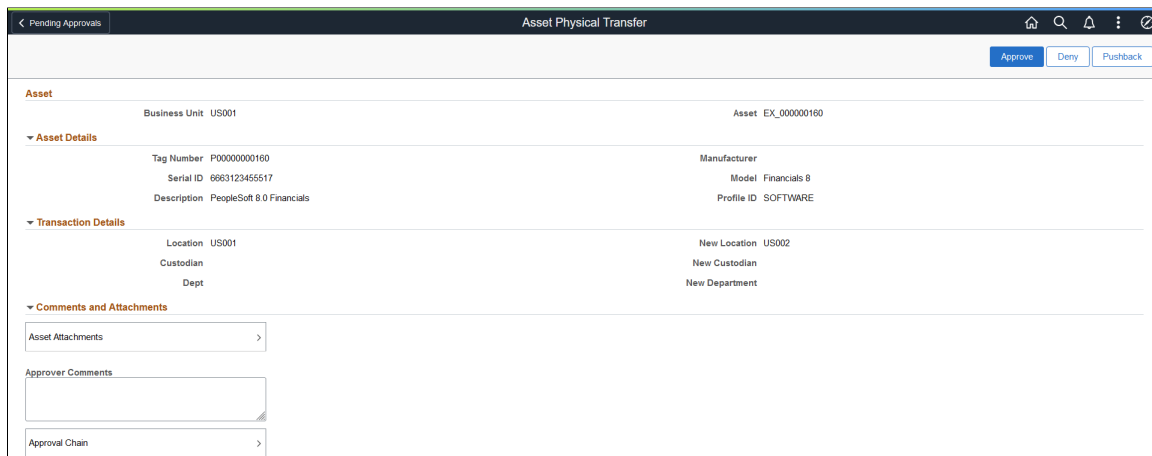

The Transaction Details section displays the current and new location details. On final approval, the new location details replace the current values.

Pending Approvals - Asset Retire Page

Use the Asset Retire page (EOAWMA_MAIN_FL) to view a list of asset retirement requests routed to you. It deals with transactions submitted from Asset Transactions fluid component.

Navigation:

Approvals (tile) > Select Asset Retire in the approval list panel on the left side of the page.

This example illustrates the fields and controls on the Pending Approvals - Asset Retire page. You can find definitions for the fields and controls later on this page.

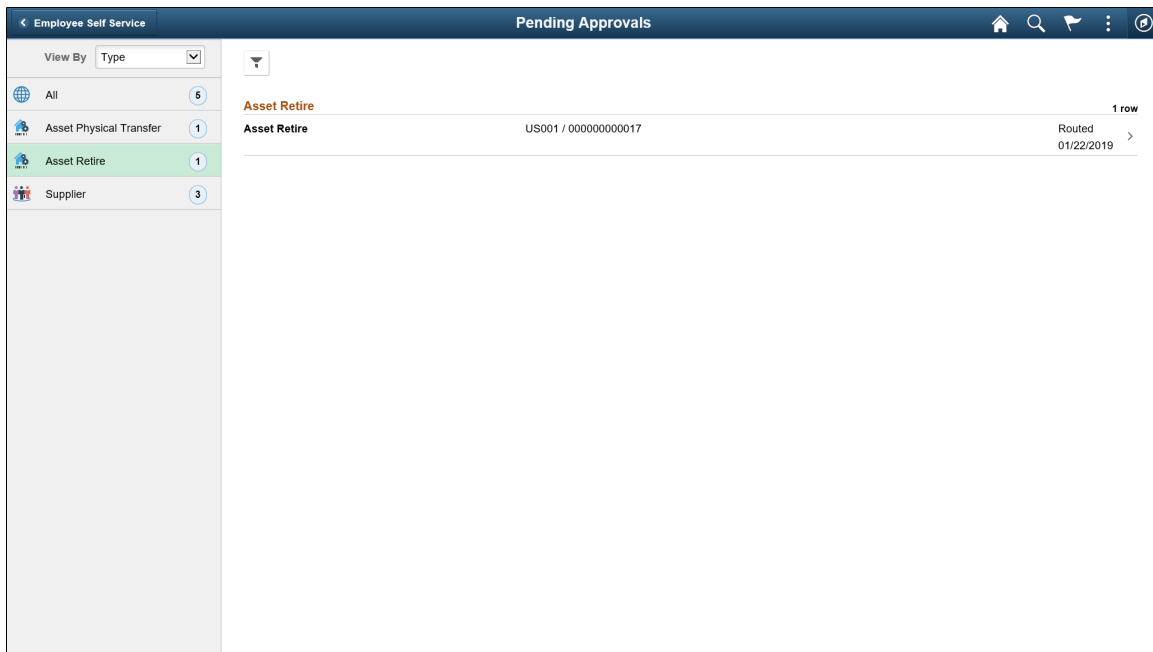

Select an asset retire row to review the details and approve or deny the request.

Asset Retire - Header Detail page

Use the Asset Retire - Header Detail page (EOAWMA_TXNHDTL_FL) to view the asset and transaction details, and approve, push back, or deny the asset retirement request.

Navigation:

Select an asset retire request row from the Pending Approvals - Asset Retire page.

This example illustrates the fields and controls on the Asset Retire - Header Detail page. You can find definitions for the fields and controls later on this page.

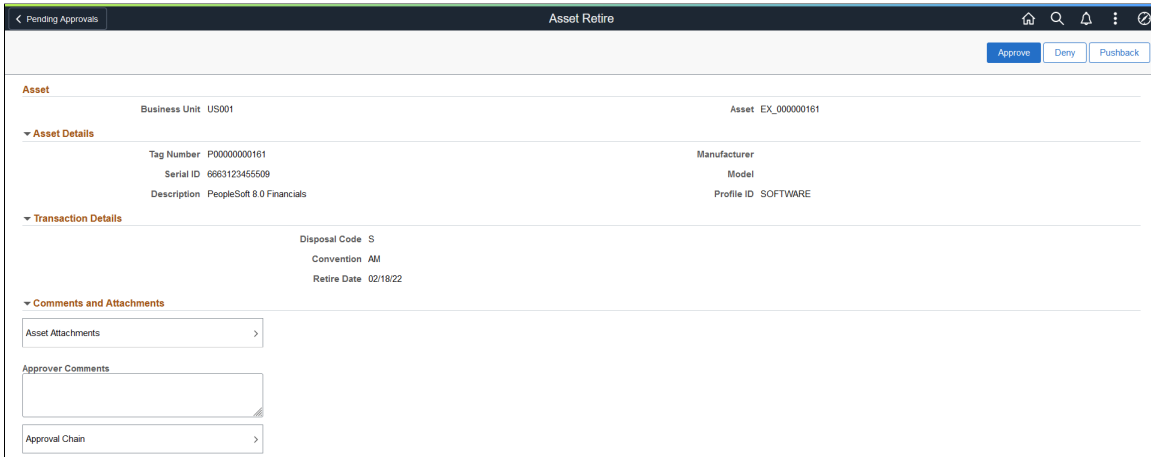

Before you approve or deny the request, check the details, enter any comments in the Approver Comments text field, and select Approval Chain to view the approval hierarchy.

Pending Approvals - Asset Disposal Page

Use the Asset Disposal page (EOAWMA_MAIN_FL) to approve or deny an asset disposal request. It deals with transactions submitted from Disposal Worksheet.

Navigation:

Approvals (tile) > Select Asset Disposal in the left pane.

This example illustrates the fields and controls on the Pending Approvals – Asset Disposal page. You can find definitions for the fields and controls later on this page.

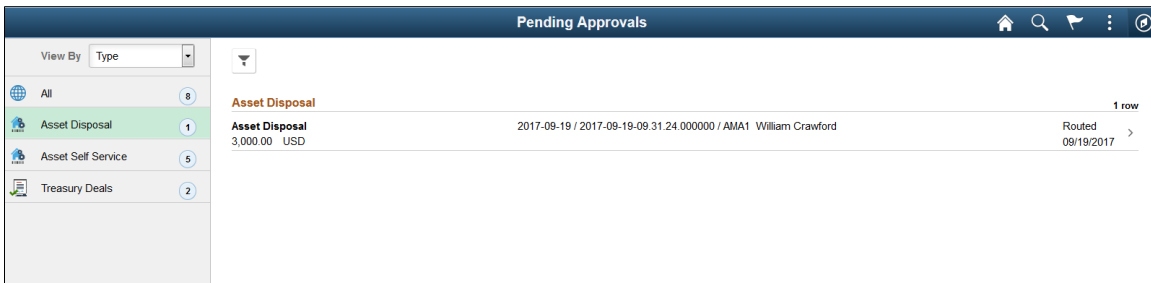

Select the Filter button to access the Filters page. Use the filter to refine the results displayed in the pending approvals list.

Select a row in the Asset Disposal grid to access the Asset Disposal – Approval Header Detail page and review the transaction details. The page provides you the options to approve, deny, push back, or hold an asset disposal request.

Asset Disposal - Approval Header Detail Page

Use the Asset Disposal – Approval Header Detail page (EOAWMA_TXNHDTL_FL) to view the details of the originator, who requested the asset disposal and approve, deny, push back, or hold an asset disposal request.

Navigation:

Select an Asset Disposal row from the Pending Approvals - Asset Disposal page.

This example illustrates the fields and controls on the Asset Disposals- Approval Header Detail page. You can find definitions for the fields and controls later on this page.

6 line(s) are pending your approval

Approve Deny More

Originator
 Originator AMA1 Name William Crawford Date Submitted 09/19/17

▼ Disposals Pending Approval

Pending All

ID	Description	Capitalize	Category	Tag	Amount	Unit
US001 ACDW21	ACDW21DES	Capitalize	FF	ACDW21TAG	1,000.00	USD
US001 ACDW21N	ACDW21NDES	Non Cap	Category	ACDW21NTAG	0	
US001 ACDW22	ACDW22DES	Capitalize	FF	ACDW22TAG	1,000.00	USD
US001 ACDW22N	ACDW22NDES	Non Cap	Category	ACDW22NTAG	0	
US001 ACDW23	ACDW23DES	Capitalize	FF	ACDW23TAG	1,000.00	USD
US001 ACDW23N	ACDW23NDES	Non Cap	Category	ACDW23NTAG	0	

Approver Comments

Approval Chain

This example illustrates the fields and controls on the Asset Disposals- Approval Header Detail page as displayed on a smartphone. You can find definitions for the fields and controls later on this page.

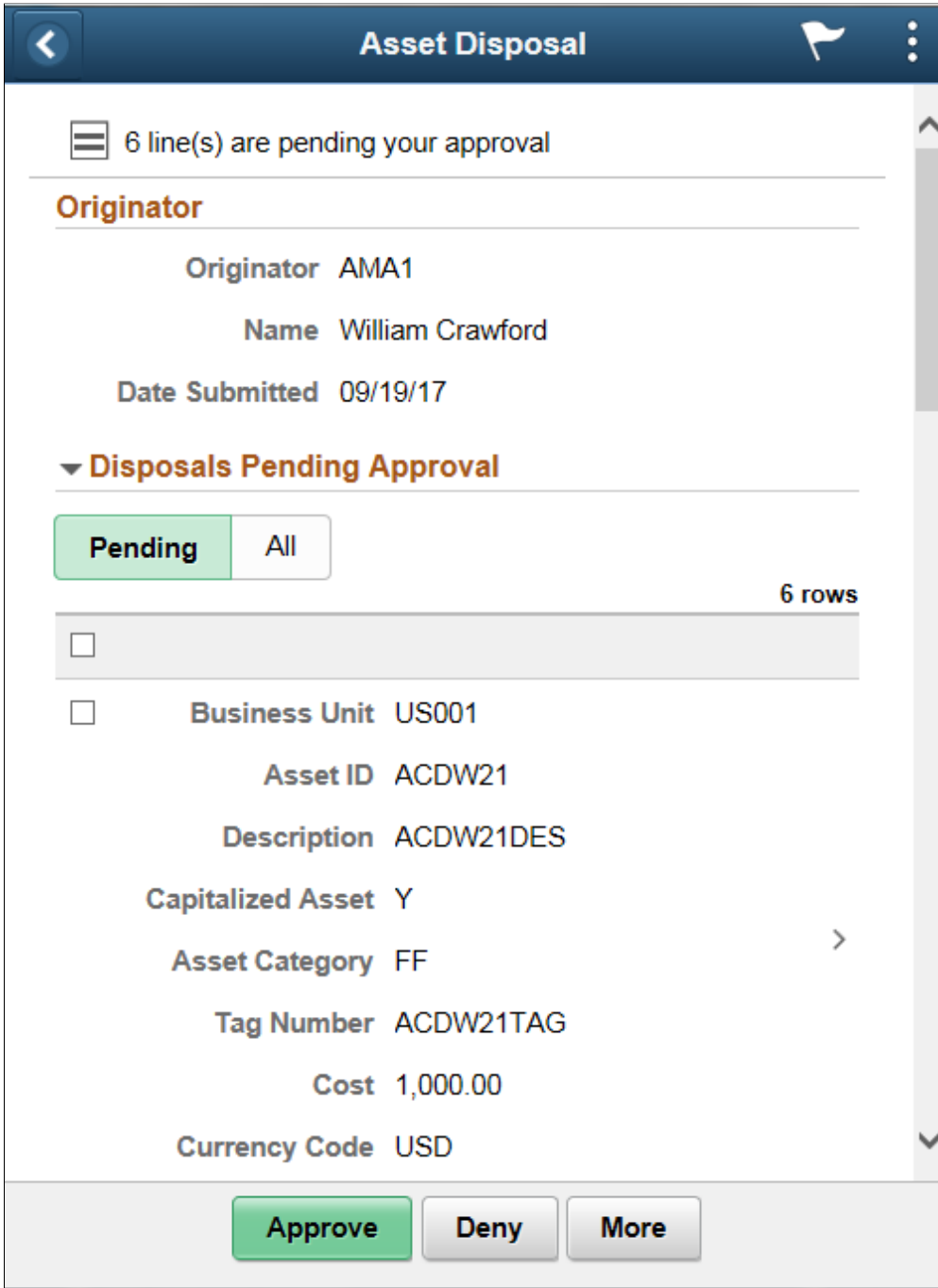

Select a row in the Disposals Pending Approvals grid to view the Approval Line Detail page and view the asset and retirement information. Review the details and select the desired approval action. You can also select all the rows pending approval and proceed to the desired approval action. The approval actions include:

Field or Control	Description
Hold	Places the approval request on hold. The approval status remains as On Hold until the approver acts on the request.

Enter any comments in the Approver Comments text field.

Select Approval Chain to view the approval hierarchy.

See [Approving Disposals](#).

Pending Approvals - Asset Self Service Page

Use the Pending Approvals - Asset Self Service page (EOAWMA_MAIN_FL) to view a list of all asset self service that are pending approval.

Navigation:

Approvals (tile) > Select Asset Self Service in the left pane.

This example illustrates the fields and controls on the Pending Approvals – Asset Self Service page. You can find definitions for the fields and controls later on this page.

Pending Approvals			
View By	Type		
All	8	Asset Self Service	5 rows
Asset Disposal	1	Asset Self Service Transfer Asset	US001 / ITZ053 William Crawford Routed 07/25/2017
Asset Self Service	5	Asset Self Service Asset Lost or Stolen	US001 / ITZ063 William Crawford Routed 07/25/2017
Treasury Deals	2	Asset Self Service Asset Not Assigned to Me	US001 / ITZ166 William Crawford Routed 07/25/2017
		Asset Self Service Transfer Asset	US001 / AITZ0533 William Crawford Routed 08/18/2017
		Asset Self Service Transfer Asset	US001 / ABITZ053C William Crawford Routed 08/28/2017

Select the Filter button to access the Filters page. Use the filter to refine the results displayed in the pending approvals list.

Select a row in the Asset Self Service grid to access the Asset Self Service – Approval Header Details page and review the transaction details before you select the approval action.

Asset Self Service - Approval Header Details Page

Use the Asset Self Service – Approval Header Details page (EOAWMA_TXNHDTL_FL) to view the list of asset self service requests routed for approval, asset details, activity details, and approve, deny, or hold self service approval requests.

Navigation:

Select an Asset Self Service row from the Pending Approvals - Asset Self Service page.

This example illustrates the fields and controls on the Asset Self Service – Approval Header Details page. You can find definitions for the fields and controls later on this page.

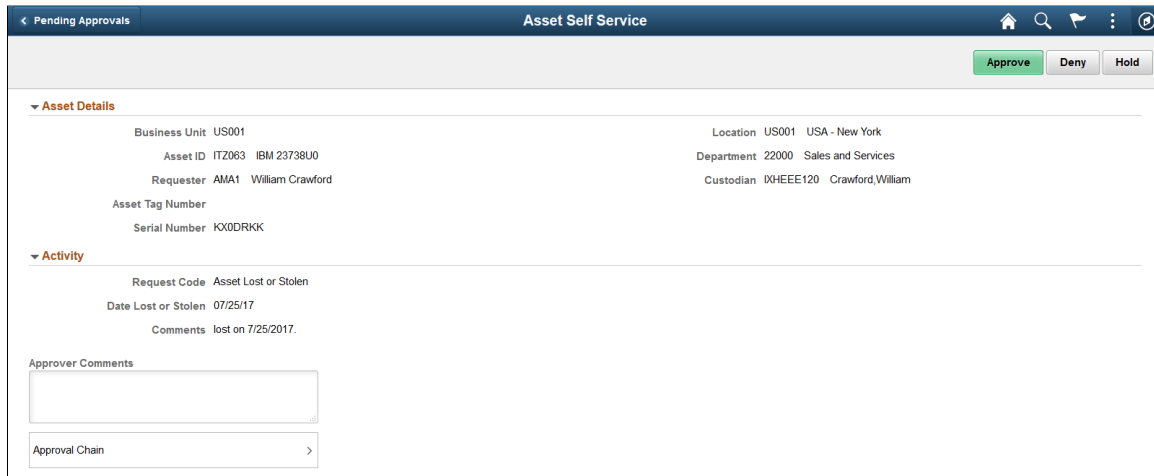

Review asset details and activity before you act on the request. The approval actions include:

Field or Control	Description
Hold	Places the request on hold. The approval status remains as On Hold until the approver acts on the request.

Enter comments in the Approver Comments text box.

Select Approval Chain to view the approval hierarchy.

For more information about Self Service Application pages, see [Using Self Service Application Pages](#).

Pending Approvals - Asset Addition Reversal Page

Use the Pending Approvals - Asset Addition Reversal page (EOAWMA_MAIN_FL) to view a list of all asset addition reversals that are pending your approval.

Navigation:

Approvals (tile) > Select Asset Addition Reversal in the approval list panel on the left side of the page.

This example illustrates the fields and controls on the Pending Approvals - Asset Addition Reversal page.

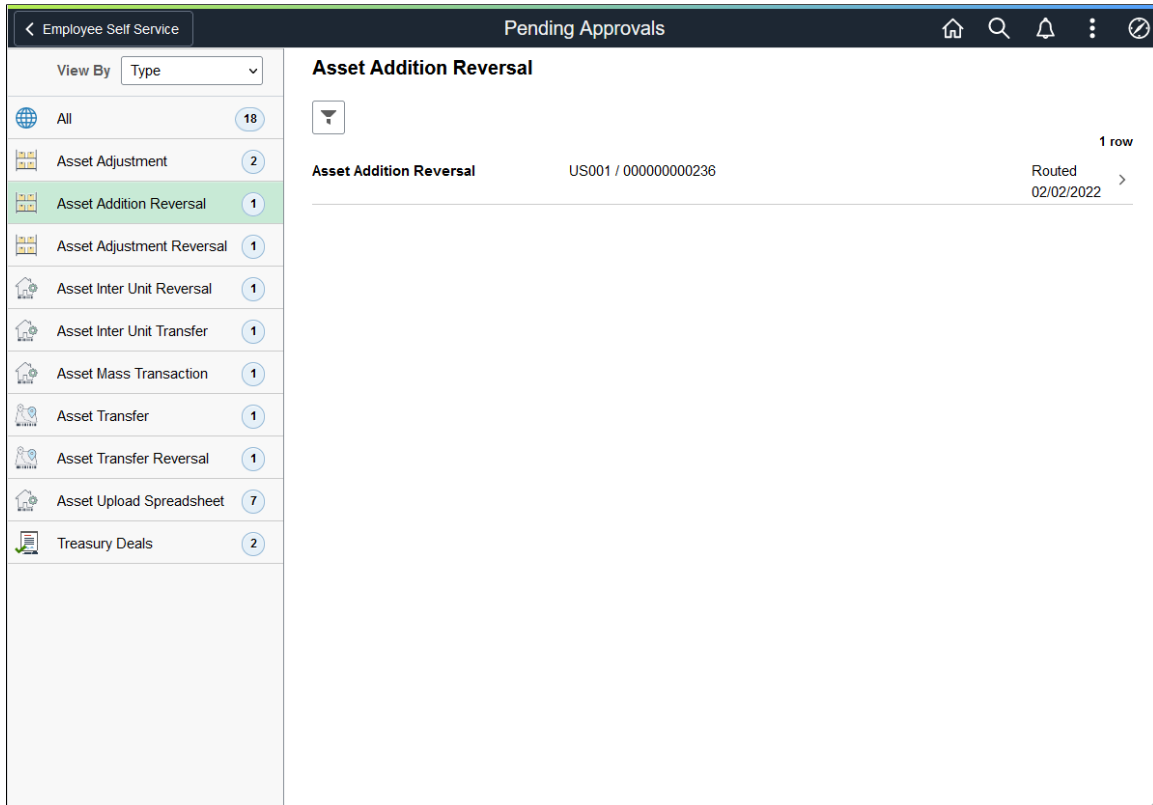

Select the Filter button to access the Filters page. Use the filter to refine the results displayed in the pending approvals list.

Select an Asset Addition Reversal row to access the Asset Addition Reversal - Approval Header Detail page and review addition reversal details. You can also approve or deny the transfer from this page.

Asset Addition Reversal - Approval Header Detail Page

Use the Asset Addition Reversal - Approval Header Detail page (EOAWMA_TXNHDTL_FL) to view asset addition reversal, line summary, and line detail information, and approve, push back, or deny the addition reversal.

Navigation:

Select an Asset Addition Reversal row from the Pending Approvals - Asset Addition Reversal page.

This example illustrates the fields and controls on the Asset Addition Reversal - Approval Header Detail page.

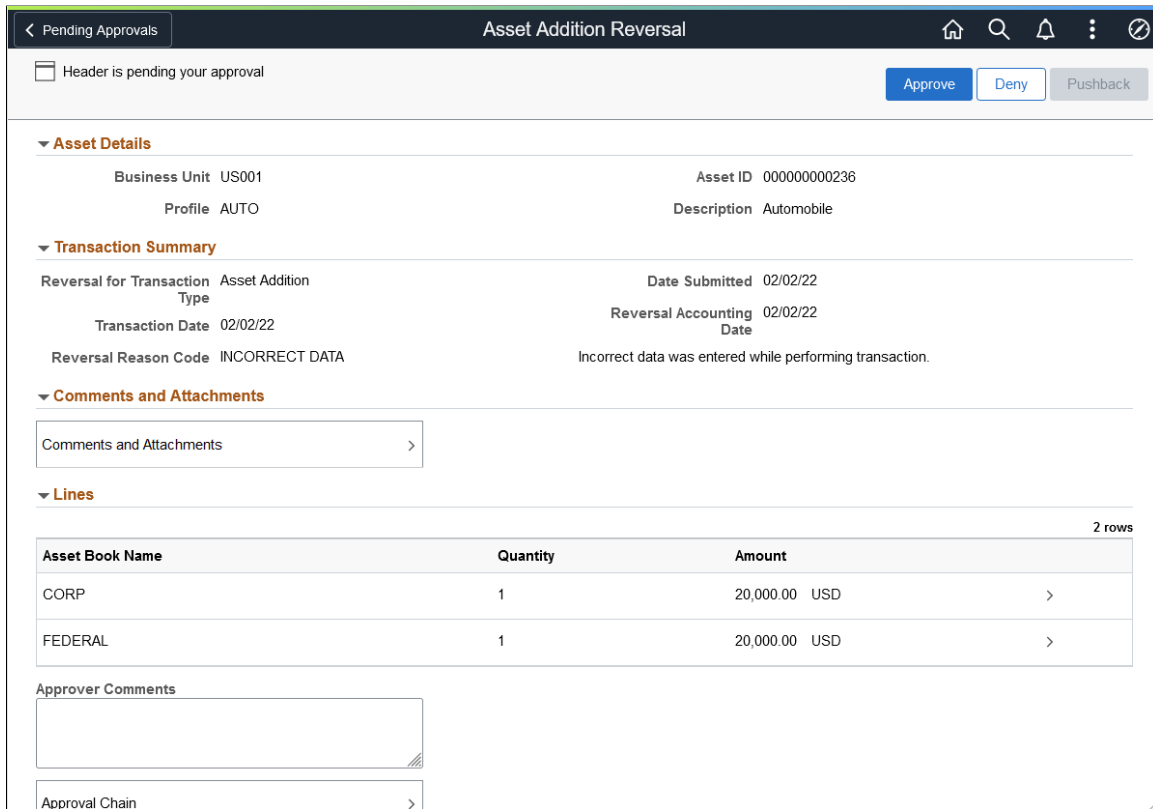

Review asset addition reversal, transaction summary, and line summary information, then select a row in the **Lines** grid to access the Approval Line Detail page and view line details.

Select **Asset Attachments** to access the Comments and Attachments pagelet and view comments and attachments related to the asset for approval.

Select **Approval Chain** to access the Approval Chain pagelet and view the approval hierarchy.

Pending Approvals - Asset Adjustment Reversal Page

Use the Pending Approvals - Asset Adjustment Reversal page (EOAWMA_MAIN_FL) to view a list of all asset adjustment reversals that are pending your approval.

Navigation:

Approvals (tile) > Select Asset Adjustment Reversal in the approval list panel on the left side of the page.

This example illustrates the fields and controls on the Pending Approvals - Asset Adjustment Reversal page.

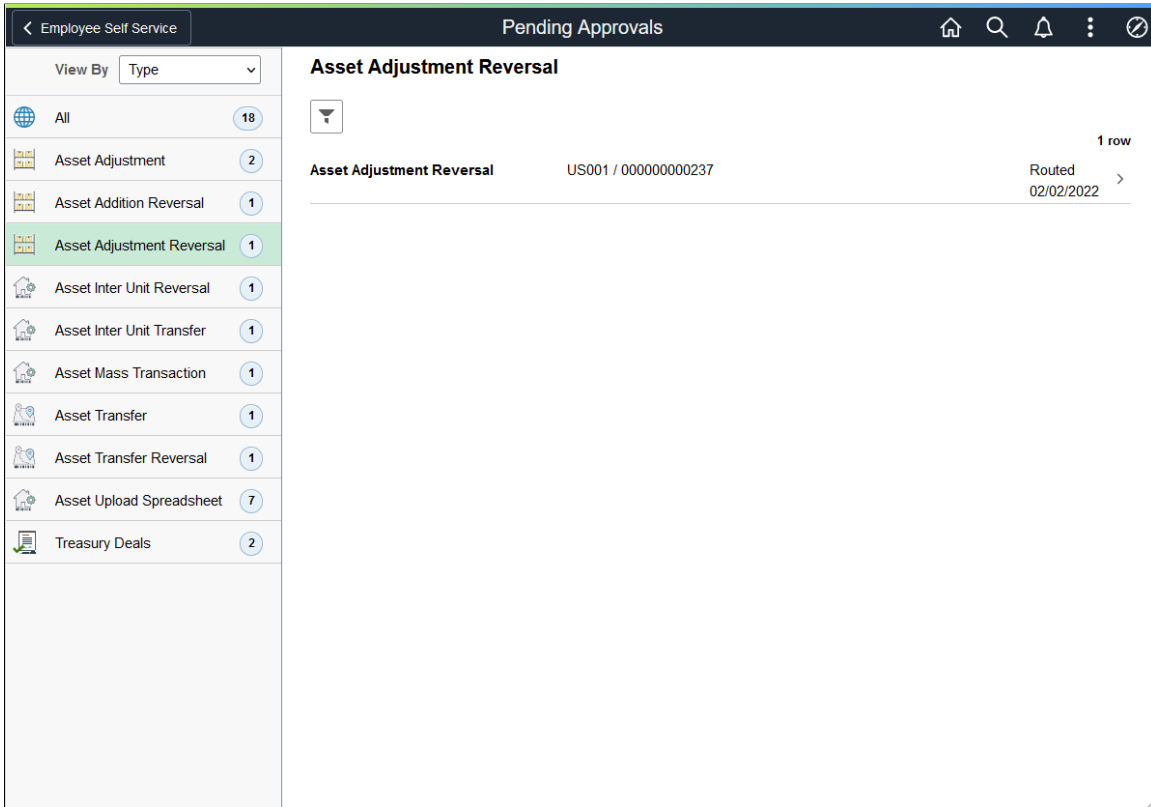

Select the Filter button to access the Filters page. Use the filter to refine the results displayed in the pending approvals list.

Select an Asset Adjustment Reversal row to access the Asset Adjustment Reversal - Approval Header Detail page and review adjustment reversal details. You can also approve or deny the adjustment reversal from this page.

Asset Adjustment Reversal - Approval Header Detail Page

Use the Asset Adjustment Reversal - Approval Header Detail page (EOAWMA_TXNHDTL_FL) to view asset adjustment reversal, line summary, and line detail information, and approve, push back, or deny the adjustment reversal.

Navigation:

Select an Asset Adjustment Reversal row from the Pending Approvals - Asset Adjustment Reversal page.

This example illustrates the fields and controls on the Asset Adjustment Reversal - Approval Header Detail page.

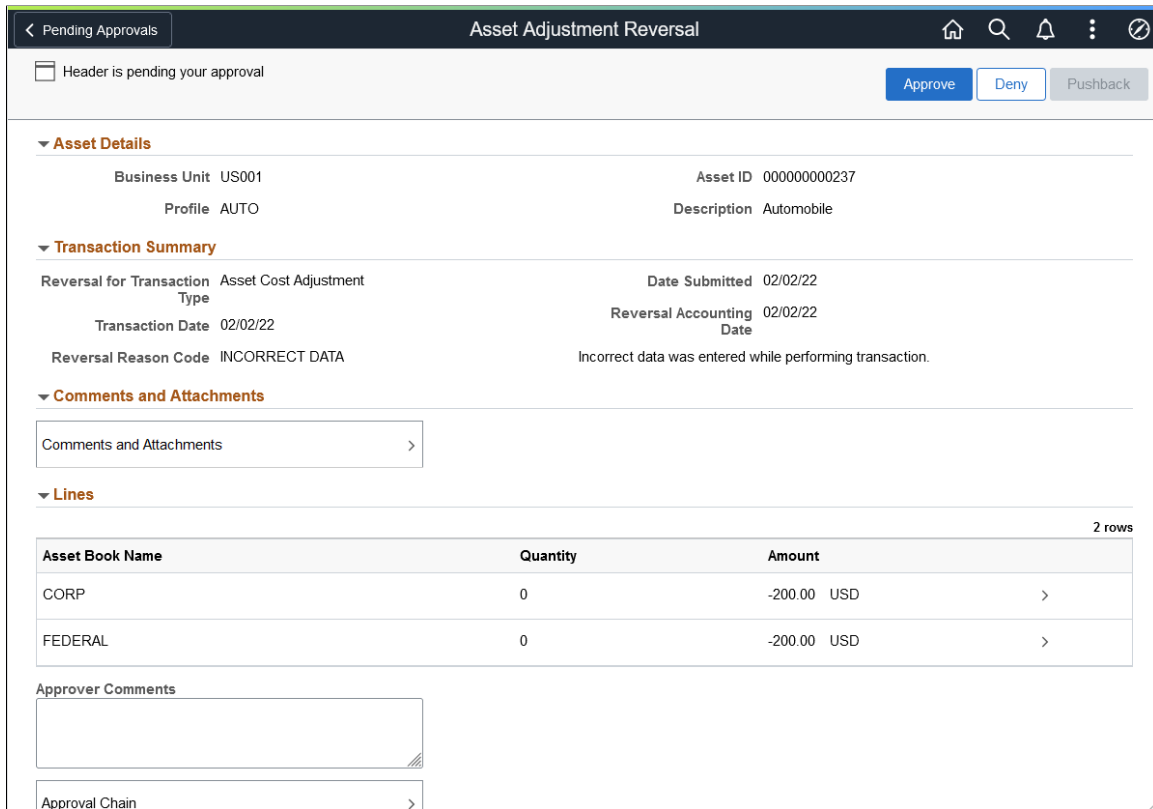

Review asset adjustment reversal, transaction summary, and line summary information, then select a row in the **Lines** grid to access the Approval Line Detail page and view line details.

Select **Asset Attachments** to access the Comments and Attachments pagelet and view comments and attachments related to the asset for approval.

Select **Approval Chain** to access the Approval Chain pagelet and view the approval hierarchy.

Pending Approvals - Asset InterUnit Reversal Page

Use the Pending Approvals - Asset InterUnit Reversal page (EOAWMA_MAIN_FL) to view a list of all asset interunit reversals that are pending your approval.

Navigation:

Approvals (tile) > Select Asset InterUnit Reversal in the approval list panel on the left side of the page.

This example illustrates the fields and controls on the Pending Approvals - Asset InterUnit Reversal page.

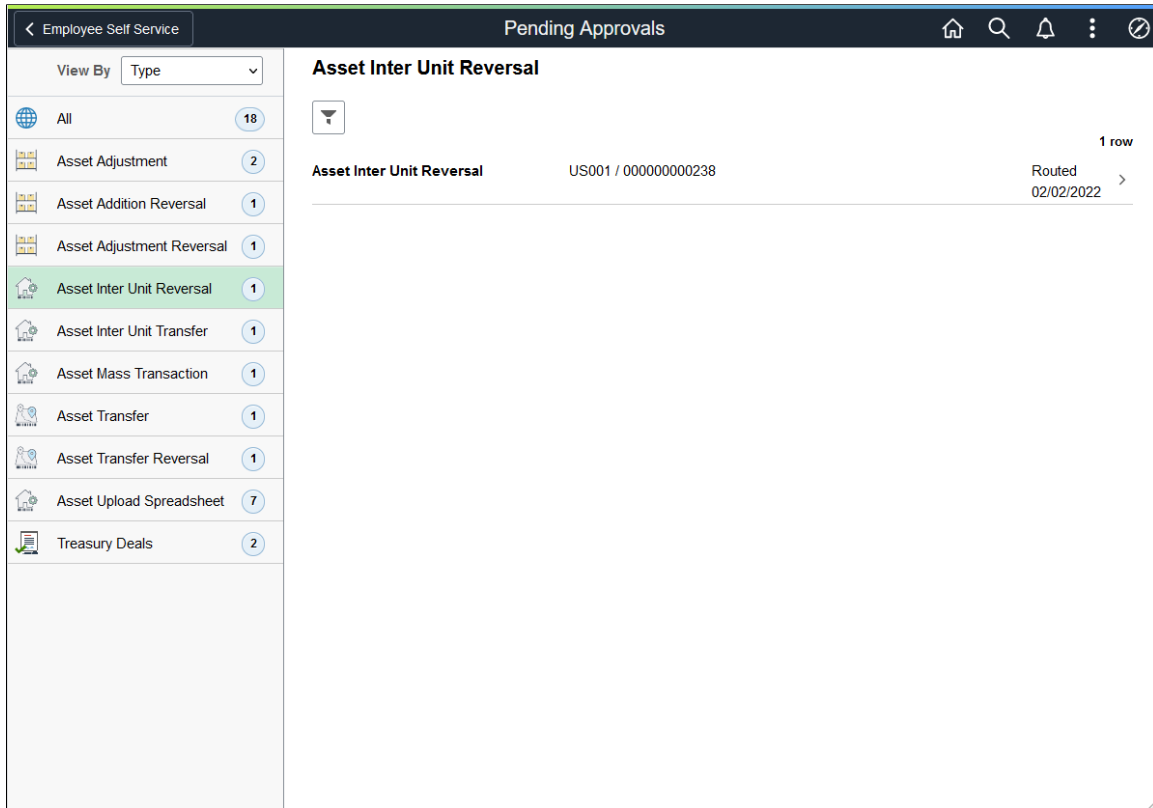

Select the Filter button to access the Filters page. Use the filter to refine the results displayed in the pending approvals list.

Select an Asset InterUnit Reversal row to access the Asset InterUnit Reversal - Approval Header Detail page and review interunit reversal details. You can also approve or deny the interunit reversal from this page.

Asset InterUnit Reversal - Approval Header Detail Page

Use the Asset InterUnit Reversal - Approval Header Detail page (EOAWMA_TXNHDTL_FL) to view asset interunit reversal, line summary, and line detail information, and approve, push back, or deny the interunit reversal.

Navigation:

Select an Asset InterUnit Reversal row from the Pending Approvals - Asset InterUnit Reversal page.

This example illustrates the fields and controls on the Asset InterUnit Reversal - Approval Header Detail page.

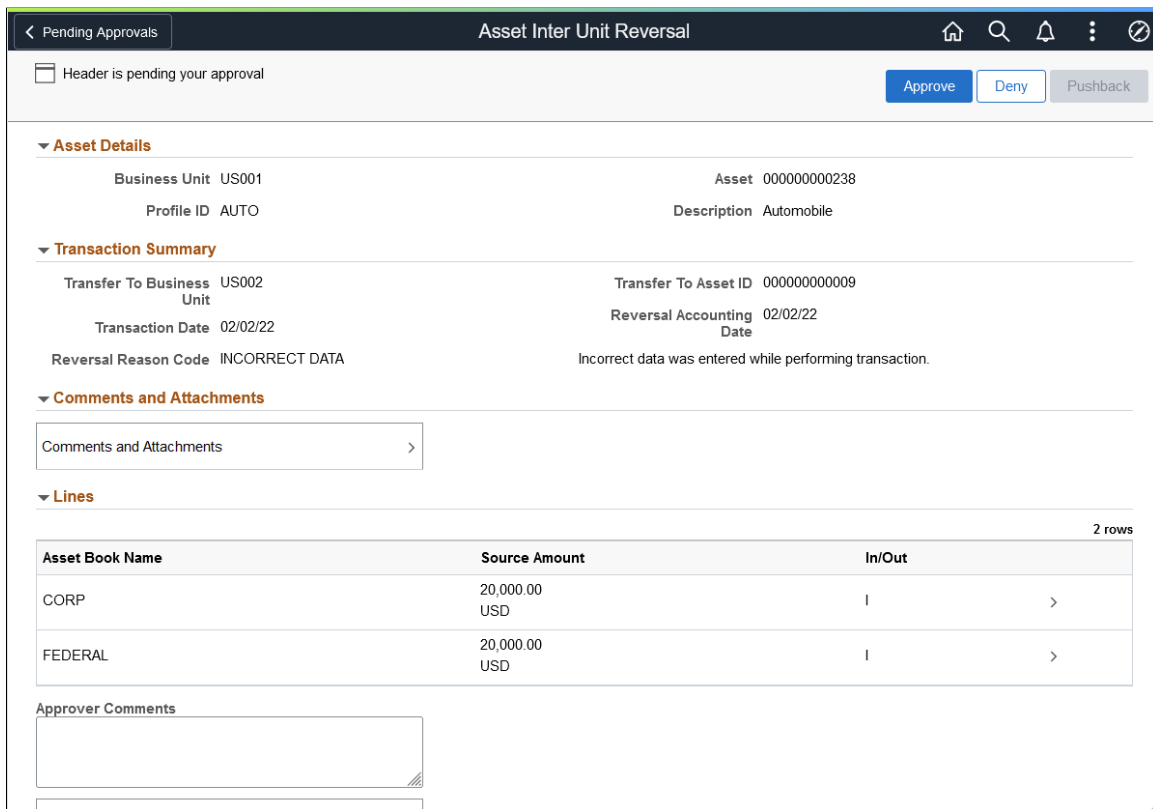

Review asset interunit reversal, transaction summary, and line summary information, then select a row in the **Lines** grid to access the Approval Line Detail page and view line details.

Select **Asset Attachments** to access the Comments and Attachments pagelet and view comments and attachments related to the asset for approval.

Select **Approval Chain** to access the Approval Chain pagelet and view the approval hierarchy.

Pending Approvals - Asset Transfer Reversal Page

Use the Pending Approvals - Asset Transfer Reversal page (EOAWMA_MAIN_FL) to view a list of all asset transfer reversals that are pending your approval.

Navigation:

Approvals (tile) > Select Asset Transfer Reversal in the approval list panel on the left side of the page.

This example illustrates the fields and controls on the Pending Approvals - Asset Transfer Reversal page.

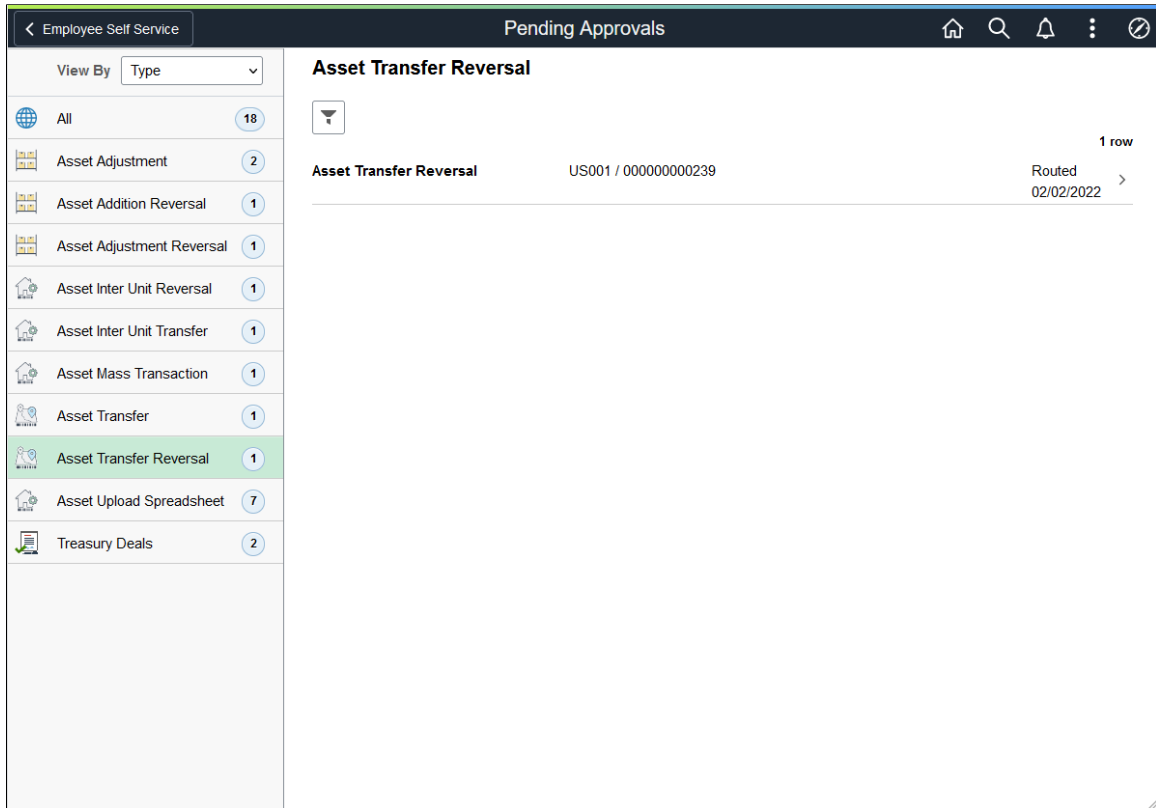

Select the Filter button to access the Filters page. Use the filter to refine the results displayed in the pending approvals list.

Select an Asset Transfer Reversal row to access the Asset Transfer Reversal - Approval Header Detail page and review transfer reversal details. You can also approve or deny the transfer reversal from this page.

Asset Transfer Reversal - Approval Header Detail Page

Use the Asset Transfer Reversal - Approval Header Detail page (EOAWMA_TXNHDTL_FL) to view asset transfer reversal, line summary, and line detail information, and approve, push back, or deny the transfer reversal.

Navigation:

Select an Asset Transfer Reversal row from the Pending Approvals - Asset Transfer Reversal page.

This example illustrates the fields and controls on the Asset Transfer Reversal - Approval Header Detail page.

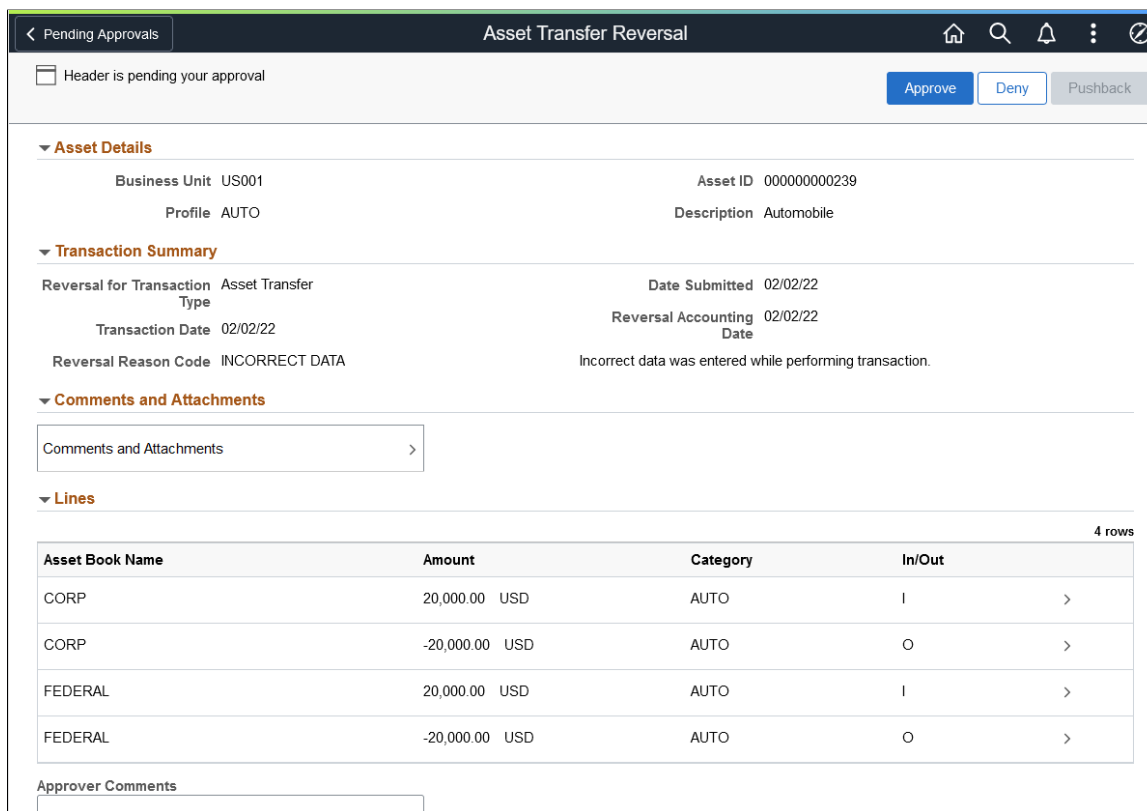

Review asset transfer reversal, transaction summary, and line summary information, then select a row in the **Lines** grid to access the Approval Line Detail page and view line details.

Select **Asset Attachments** to access the Comments and Attachments pagelet and view comments and attachments related to the asset for approval.

Select **Approval Chain** to access the Approval Chain pagelet and view the approval hierarchy.

Pending Approvals - Asset Mass Transaction Page

Use the Pending Approvals - Asset Mass Transaction page (EOAWMA_MAIN_FL) to view a list of all asset mass transactions that are pending your approval.

Navigation:

Approvals (tile) > Select Asset Mass Transaction in the approval list panel on the left side of the page.

This example illustrates the fields and controls on the Pending Approvals - Asset Mass Transaction page.

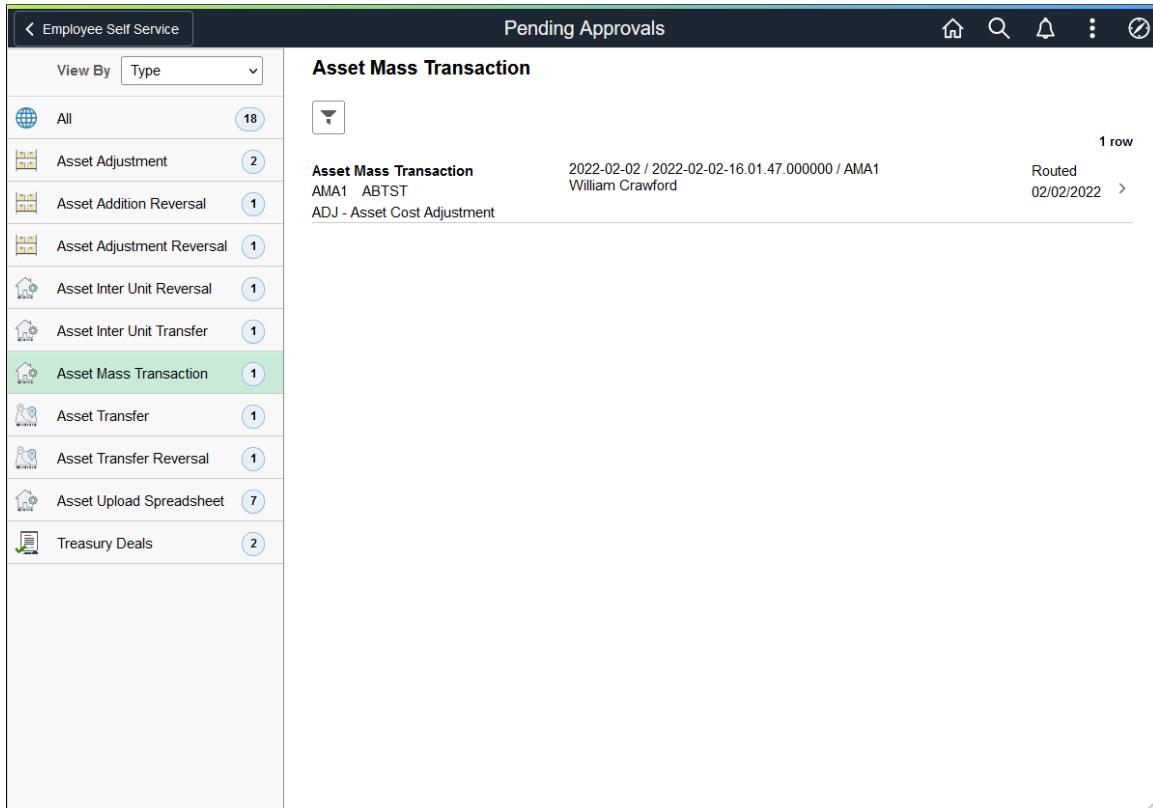

Select the Filter button to access the Filters page. Use the filter to refine the results displayed in the pending approvals list.

Select an Asset Mass Transaction row to access the Asset Mass Transaction - Approval Header Detail page and review mass transaction details.

Asset Mass Transaction - Approval Header Detail Page

Use the Asset Mass Transaction - Approval Header Detail page (EOAWMA_TXNHDTL_FL) to view asset mass transaction, interface line summary, and line detail information, and approve, push back, or deny the mass transaction.

Navigation:

Select an Asset Mass Transaction row from the Pending Approvals - Asset Mass Transaction page.

This example illustrates the fields and controls on the Asset Mass Transaction - Approval Header Detail page.

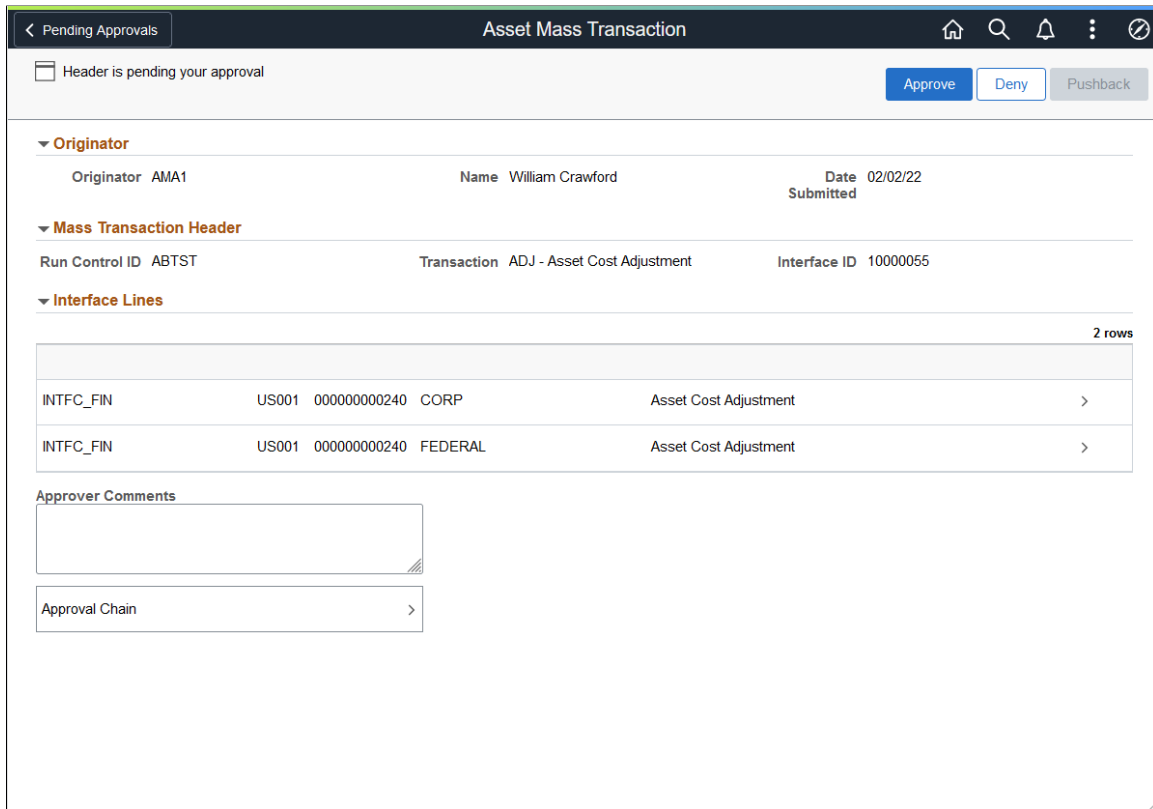

Review asset mass transaction and interface line summary information, then select a row in the **Interface Lines** grid to access the Approval Line Detail page and view interface line details.

Select **Asset Attachments** to access the Comments and Attachments pagelet and view comments and attachments related to the asset for approval.

Select **Approval Chain** to access the Approval Chain pagelet and view the approval hierarchy.

Pending Approvals - Asset Upload Spreadsheet Data

Use the Pending Approvals - Asset Upload Spreadsheet Data page (EOAWMA_MAIN_FL) to view a list of all spreadsheet asset upload transactions that are pending your approval.

Navigation:

Approvals (tile) > Select Asset Upload Spreadsheet Data in the approval list panel on the left side of the page.

Pending Approvals - Asset Upload Spreadsheet Data page

View By		Type	Pending Approvals				
All	18		Asset Upload Spreadsheet Data				
Asset Adjustment	2						7 rows
Asset Addition Reversal	1		Asset Upload Spreadsheet Data	2022-02-02 / 2022-02-02-16.15.55.000000 / AMA1	William Crawford	Routed	02/02/2022 >
Asset Adjustment Reversal	1		Asset Upload Spreadsheet Data	2022-02-04 / 2022-02-04-10.27.15.000000 / AMA1	William Crawford	Routed	02/04/2022 >
Asset Inter Unit Reversal	1		Asset Upload Spreadsheet Data	2022-02-04 / 2022-02-04-10.29.56.000000 / AMA1	William Crawford	Routed	02/04/2022 >
Asset Inter Unit Transfer	1		Asset Upload Spreadsheet Data	2022-02-04 / 2022-02-04-10.42.27.000000 / AMA1	William Crawford	Routed	02/04/2022 >
Asset Mass Transaction	1		Asset Upload Spreadsheet Data	2022-02-04 / 2022-02-04-11.10.35.000000 / AMA1	William Crawford	Routed	02/04/2022 >
Asset Transfer	1		Asset Upload Spreadsheet Data	2022-02-04 / 2022-02-04-12.01.36.000000 / AMA1	William Crawford	Routed	02/04/2022 >
Asset Transfer Reversal	1		Asset Upload Spreadsheet Data	2022-02-04 / 2022-02-04-12.16.44.000000 / AMA1	William Crawford	Routed	02/04/2022 >
Asset Upload Spreadsheet	7		Asset Upload Spreadsheet Data	2022-02-04 / 2022-02-04-12.16.44.000000 / AMA1	William Crawford	Routed	02/04/2022 >
Treasury Deals	2						

Select the Filter button to access the Filters page. Use the filter to refine the results displayed in the pending approvals list.

Select an Asset Upload Spreadsheet Data row to access the Asset Upload Spreadsheet Data - Approval Header Detail page and review asset upload details.

Asset Upload Spreadsheet Data - Approval Header Detail Page

Use the Asset Upload Spreadsheet Data - Approval Header Detail page (EOAWMA_TXNHDTL_FL) to view asset upload spreadsheet data, summary, and interface line detail information, and approve, push back, or deny the asset upload transaction.

Navigation:

Select Asset Upload Spreadsheet row from the Pending Approvals - Asset Upload Spreadsheet page.

Asset Upload Spreadsheet Data - Approval Header Detail page

Asset Upload Spreadsheet Data

Header is pending your approval

Approve Deny Pushback

Originator

Originator AMA1 Name William Crawford Date Submitted 02/02/22

Transaction Header

Run Control ID ABTST Template ID RET Interface ID 10000056

Interface Lines

2 rows

INTFC_FIN	US001	000000000241	CORP	Asset Retirement	>
INTFC_FIN	US001	000000000241	FEDERAL	Asset Retirement	>

Approver Comments

Approval Chain >

Review asset upload information, then select a row in the **Interface Lines** grid to access the Approval Line Detail page and view line details.

Select **Asset Attachments** to access the Comments and Attachments pagelet and view comments and attachments related to the asset for approval.

Select **Approval Chain** to access the Approval Chain pagelet and view the approval hierarchy.

Managing Asset Maintenance, Repair, Warranties, and Insurance

Understanding Asset Maintenance, Repair, Warranties, and Insurance

All assets usually require some level of maintenance service or repair. Many are also acquired with accompanying insurance or warranties. PeopleSoft Asset Management provides features enabling you to manage and track these asset attributes.

Asset Checkout

PeopleSoft Asset Management provides the asset check out functionality in order to prepare, configure and maintain assets for use. This enables you to manage assets as they are moved around the enterprise for use in multiple settings. As well, the usage can be monitored and intervening maintenance or service events can be tracked while the asset is out of use.

Asset Maintenance, Service, and Inspection Management

At various intervals, all assets require some degree of maintenance, such as routine mechanics for company vehicles or repainting an office or building. Scheduling and tracking this type of maintenance provides a more complete picture of the true costs and revenues associated with these assets.

PeopleSoft Asset Management provides features to track the details of individual maintenance events by date and time, the person responsible for the maintenance, the vendor who issued the maintenance contract or warranty, and the cost.

Whenever an asset requires maintenance, you can track exactly when the maintenance takes place, how long it will take, and how it will affect cost and performance. Annual tune-ups may require that some automobiles are unavailable at certain times. Damages to machinery can result in large expenses due to unavailable equipment, as well as replacement and repair costs.

PeopleSoft Asset Management additionally provides the tools to view the maintenance history by type of maintenance performed or by the date that the maintenance was performed. Using inquiry pages, you can determine if any asset, or group of assets, requires a particular type of maintenance too often. For example, a vehicle that requires several quarts of oil more often than every 1,000 miles may have more severe underlying problems. Similarly, a piece of equipment that requires repeated repair or replacement of a particular part may be defective and should be replaced.

When you own assets that require expensive maintenance, you may acquire maintenance contracts with providers covering service and repair. While maintenance contracts do not necessarily have a one-to-one relationship with assets that require maintenance, you may still want to keep track of those contracts, the assets that they cover, the extent of coverage provided, and so forth. PeopleSoft Asset Management provides the tools to track such contracts and to determine repair and servicing costs, the time period covered in the contract, and the exact coverage specified by the contract.

Keeping detailed records of maintenance events helps manage the physical aspects of your assets. You can compare detailed repair estimates to actual costs and evaluate whether a warranty or maintenance contract on the asset can lower the costs that you may incur. Or a review of an asset maintenance history can help you make decisions about addressing underlying costs that are driving up the cost of production. Some assets additionally require routine inspections related to licensing or other validations or certifications. PeopleSoft Asset Management provides inspection and license tracking.

Asset Repair Data Management

In addition to tracking physical information about asset maintenance, it is useful to track detailed financial information. PeopleSoft Asset Management enables you to track:

- How long an asset will be unavailable for use.
- Hours required to service or repair the asset.
- Costs for labor and materials.
- Any other expenses that you may incur, such as rental of necessary replacement equipment.

This type of detail enables you to assess asset maintenance and repair costs. For instance, as equipment grows older, it may cost more to repair and service, especially if the parts are obsolete or out of stock. Tracking asset service and repair statistics helps you to see the financial picture more clearly and may be instrumental in helping you to decide when to retire or replace an asset.

Asset Warranty Management

Warranties can often lower the cost of repair and maintenance of your assets. Keep track of any warranties that you might have, which assets they cover, the period of coverage, the cost of the warranty, and so forth. Manufacturers often warrant an asset, or part of an asset, using specific terms and indicating specific conditions. Such information is easily accessible to all employees in your organization who might be responsible for the physical aspects of asset management.

Asset Insurance Management

PeopleSoft Asset Management enables you to enter asset-specific insurance coverage information, including key insured information, such as insured amount and insurer details. This provides immediate online access to asset insurance information associated with a specific asset ID, rather than maintaining this information in a separate database.

Checking Out Assets

This topic discusses how to enter maintenance events and details.

Page Used to Check Out Assets

Page Name	Definition Name	Usage
<u>Asset Checkout Page</u>	ASSET_CHECKOUT	Check out an asset that can be scheduled from available assets.

Asset Checkout Page

Use the Asset Checkout page (ASSET_CHECKOUT) to check out an asset that can be scheduled from available assets.

Navigation:

Asset Management > Service and Maintenance > Asset Checkout

This example illustrates the fields and controls on the Asset Checkout page. You can find definitions for the fields and controls later on this page.

Asset Checkout

Asset Checkout

Business Unit <input type="text" value="US001"/>	Asset ID <input type="text" value="EX_000000122"/>	Checkout ID <input type="text" value="000000000002"/>
WO Business Unit <input type="text"/>	Work Order <input type="text"/>	Task No. <input type="text"/>
Checkout By <input type="text" value="Todman,Joe"/>		
Contact Info <input type="text" value="(925) 555-9090"/>		
Location <input type="text" value="US001"/>	Shop <input type="text"/>	
Deployed BU <input type="text" value="US001"/>	Deployed Asset ID <input type="text"/>	
*Start Date <input type="text" value="12/24/2004"/>	Start Time <input type="text" value="6:18PM"/>	
End Date <input type="text" value="12/16/2004"/>	End Time <input type="text" value="3:15PM"/>	<input type="checkbox"/> Checked In
Usage Amount <input type="text"/>	Unit of Measure <input type="text"/>	

Field or Control	Description
WO Business Unit	Select the business unit from which to select the work order for this asset.
Work Order	Select the work order to associate with this asset checkout.
Task No.	Select the task number associated with this checkout event.
Checkout By	Select the person who checked out the asset.
Contact Info	Enter any contact information regarding the checkout of this asset.
Location	Select the location by business unit for the asset.

Field or Control	Description
Shop	Select the shop if applicable where the asset will be maintained.
Deployed BU	Select the business unit to which the asset is deployed.
Deployed Asset ID	Select the asset ID used when the asset is deployed.
Start Date	Enter the start date for the asset deployment.
Start Time	Enter the start time of the asset deployment
End Date	Enter the ending date of the asset deployment.
End Time	Enter the ending time of the asset deployment.
Checked In	Check this box when the deployed asset has been checked in.
Usage Amount	Enter the usage amount of the asset. For example, if the asset usage is tracked by a meter, a reading value can be entered.
Unit of Measure	Select the usage amount unit of measure type, such as miles, gallons, etc.

Entering Asset Inspection Information

Use the Asset Inspection (ASSET_INSPECTION) component to enter information about required or other inspection for a given asset.

This topic discusses how to enter asset inspections.

Page Used to Enter Asset Inspection Information

Page Name	Definition Name	Usage
Asset Inspection	ASSET_INSPECTION	Enter details pertaining to inspections performed for the asset. The inspection agency should be defined first.

Entering Asset Maintenance Service and Repairs

Use the Track Service and Repairs (ASSET_MAINT_01) component to enter asset service and repair statistics. This topic lists the pages used and discusses how to enter Asset Maintenance Service and Repairs.

Pages Used to Enter Asset Service and Repair

Page Name	Definition Name	Usage
Asset Service/Repair - Event Page	ASSET_MAINT_01	Provide the date and time of maintenance events and identify the type of maintenance, party responsible for the maintenance, and status of the maintenance.
Maintenance Details Page	ASSET_MAINT_01_S	Identify the type of maintenance, party responsible for the maintenance, and status of the maintenance. See Asset Service/Repair - Event Page
Track Service and Repairs - Statistics Page	ASSET_MAINT_02	Enter detailed financial information pertaining to asset maintenance.
Related Meter Readings Page	ASSET_MAINT_05	Enter meter reading information relative to a maintenance event for this asset. This page enables you to enter and view related meter readings which may have influenced the maintenance event being tracked. See Track Service and Repairs - Statistics Page
Meter Reading Details Page	AM_MTR_RD_HID3	Use the details link to view asset meter reading details. See Track Service and Repairs - Statistics Page
Track Service and Repairs - Payment Page	ASSET_MAINT_03	Enter information about a parts or services vendor. You can add any number of payment records.
Asset Service/Repair Details - Comments	ASSET_MAINT_04	Enter problems encountered or recommendations for repair and service. You can maintain separate comments for each service/repair event or you can keep a running commentary covering all events.

Asset Service/Repair - Event Page

Use the Asset Service/Repair - Event page (ASSET_MAINT_01) to provide the date and time of maintenance events and identify the type of maintenance, party responsible for the maintenance, and status of the maintenance.

Navigation:

Asset Management > Service and Maintenance > Track Service and Repairs > Event

This example illustrates the fields and controls on the Track Service and Repairs - Event page. You can find definitions for the fields and controls later on this page.

The screenshot shows a web form for tracking maintenance events. At the top, there are tabs for 'Event', 'Statistics', 'Payment', and 'Comments'. Below the tabs, the asset information is displayed: Unit US001, Asset ID 000000000002, Gas/elec SUV - Fleetvehicle 1, and Tag P00000009001. The asset is currently 'In Service'. There are two main sections: 'Maintenance Date and Time' and 'Maintenance Event'. The 'Maintenance Date and Time' section has a 'Date/Time' field with the value '06/12/2005 10:58PM'. The 'Maintenance Event' section contains several fields: 'Type' (MINOR), 'Status' (Complete), 'Problem ID', 'WO Unit' (US001), 'Work Order ID' (0000000002), 'Repair Code', 'Responsibility', 'Pickup Date', 'Pickup Contact', and 'Ready Date Time'. There is also a 'Task Number' field with the value '1' and a checkbox for 'This Asset is Offsite'.

Field or Control	Description
Date/Time	Displays the date and time that each maintenance event was entered into PeopleSoft Asset Management.
Type	Enter a valid maintenance type. This field is required to save the event. Note: You can complete the rest of the fields on this page at any time.

Field or Control	Description
Status	<p>Select the status of the maintenance event:</p> <p><i>Complete:</i> Maintenance and repairs are done and ready for inspection.</p> <p><i>Complete-Pickup:</i> Asset is ready for return to service.</p> <p><i>In Process:</i> Asset is undergoing maintenance or repairs.</p> <p><i>Inspected:</i> Maintenance and repairs have been approved.</p> <p><i>Scheduled:</i> Maintenance event has been planned and scheduled.</p> <p><i>Scheduled-Pickup:</i> Asset has been scheduled for pickup.</p>
Problem ID	If applicable, enter an ID for this maintenance event.
WO Unit	Select the work order business unit from which to select the work order for this asset maintenance event.
Work Order ID	Select the work order ID to associate with this asset.
Task Number	Select the task number associated with this maintenance event.
Repair Code	<p>Enter a repair code, if used. This field may be populated automatically when you have installed PeopleSoft Maintenance Management.</p> <p>See “Understanding Preventive Maintenance Work Orders” (PeopleSoft Maintenance Management).</p>
Responsibility	<p>Enter the name of the person responsible for this asset, if used. This field may be populated automatically when you have installed Maintenance Management.</p> <p>See “Understanding Preventive Maintenance Work Orders” (PeopleSoft Maintenance Management).</p>
This Asset is Offsite	Check this box to indicate the asset is located off site.
Pickup Date and Pickup Contact	Enter the date the asset is scheduled for pickup and the contact name.
Ready Date Time	Enter the date and time the repaired asset is scheduled to be ready.

Related Links

“Understanding Asset Processing” (Asset Lifecycle Management Fundamentals)

Track Service and Repairs - Statistics Page

Use the Track Service and Repairs - Statistics page (ASSET_MAINT_02) to enter detailed financial information pertaining to asset maintenance.

Navigation:

Asset Management > Service and Maintenance > Track Service and Repairs > Statistics

This example illustrates the fields and controls on the Track Service and Repairs - Statistics page. You can find definitions for the fields and controls later on this page.

The screenshot shows the 'Statistics' tab of the Track Service and Repairs page. At the top, it displays asset information: Unit US001, Asset ID 000000000002, Gas/elec SUV - Fleet vehicle 1, and Tag P00000009001. Below this, there are navigation options for 'Maintenance Date and Time' (06/12/2005 10:58PM) and 'Maintenance Event' (Type: MINOR, Minor Maintenance). The event details include a list of costs and estimated values:

Field	Value	Estimated	Value
Down Hours	<input type="text"/>	Estimated	<input type="text"/>
Labor Hours	<input type="text"/>	Estimated	<input type="text"/>
Labor Cost	\$100.00	Estimated	\$100.00
Material Cost	\$26.00	Estimated	\$26.00
Tools Cost	\$0.00	Estimated	\$0.00
Purchase Cost	\$0.00	Estimated	\$0.00
Other Cost	\$0.00	Estimated	\$0.00
Total Cost	\$126.00	Estimated	\$126.00

Typically, you enter estimates of the hours and monetary costs first. Then, as information becomes available or when the service is completed, you can go back and enter actual data in the following fields:

Field or Control	Description
Down Hours and Estimated	Enter the length of time that the asset is unavailable for service.
Labor Hours and Estimated	Enter the length of time for repair and maintenance labor.
Labor Cost and Estimated	Enter the monetary expense for repair or maintenance labor.
Material Cost and Estimated	Enter the monetary expense for items used in repair or maintenance materials.
Tools Cost and Estimated	Enter the monetary expense for items used in repair or maintenance tools.
Purchase Cost and Estimated	Enter the purchase cost for items used in repair or maintenance.

Field or Control	Description
Other Cost and Estimated	Enter miscellaneous costs, such as subcontracting, replacement equipment, or rental equipment.

PeopleSoft Asset Management keeps a running total of both the actual **Total Cost** and **Estimated** total cost. Use this worksheet to compare your estimates with actual figures for determining if:

- The time and cost of maintaining the asset is within the expected margins.
- You must revise your estimates.
- You must find a more economical way to maintain your assets.

To view meter reading details for this asset, click on the **Related Meter Readings** link.

To view downtime details for this asset, click on the **Downtime Detail** link. Downtime detail is supported by PeopleSoft Maintenance Management.

Track Service and Repairs - Payment Page

Use the Track Service and Repairs - Payment page (ASSET_MAINT_03) to enter information about a parts or services vendor.

You can add any number of payment records.

Navigation:

Asset Management > Service and Maintenance > Track Service and Repairs > Payment

This example illustrates the fields and controls on the Track Service and Maintenance - Payment page. You can find definitions for the fields and controls later on this page.

Enter information about asset parts or services, including vendor, purchase orders, and voucher IDs. You can also associate the payment with a contract ID. You can add any number of payment records.

Tracking Asset Maintenance Contracts

This topic discusses how to track Asset Maintenance Contracts.

Pages Used to Track Asset Maintenance Contracts

<i>Page Name</i>	<i>Definition Name</i>	<i>Usage</i>
<u>Maintenance Contracts - Detail Page</u>	MAINT_CONTRACT_01	Add or modify maintenance contracts.
<u>Maintenance Contracts - Coverage Page</u>	MAINT_CONTRACT_02	Enter the terms of each maintenance contract and the coverage that it provides.

Understanding Asset Maintenance Contracts

Use the Maintenance Contract Terms (MAINT_CONTRACT_01) component to track such contracts and to determine repair and servicing costs, the time period covered in the contract, and the exact coverage specified by the contract.

To track maintenance contracts:

- Add or modify maintenance contracts on the Maintenance Contracts - Detail page.
- Enter the terms of each maintenance contract and the coverage that it provides.

Note: You cannot set up maintenance contracts without first setting up a Vendor table. You need not set up all vendor tables, but you must at least set up a list of vendors.

Maintenance Contracts - Detail Page

Use the Maintenance Contracts - Detail page (MAINT_CONTRACT_01) to add or modify maintenance contracts.

Navigation:

Asset Management > **Service and Maintenance** > **Maintenance Contract Terms**

You can add multiple records for any contract. By creating separate records with different dates in the **Effective Date** field, you can maintain a history of when the contract was first issued and any subsequent renewals. To identify the contract currently in use, make its **Status** *Active*.

The information in this page helps you to track maintenance contracts. You can enter when the contract was issued, when it expires, what you had to pay for it, and the vendor honoring the contract. You can also identify the person who is responsible for ensuring that the assets covered by this contract are maintained and repaired as required.

Maintenance Contracts - Coverage Page

Use the Maintenance Contracts - Coverage page (MAINT_CONTRACT_02) to enter the terms of each maintenance contract and the coverage that it provides.

Navigation:

Asset Management > Service and Maintenance > Maintenance Contract Terms > Coverage

In the **Coverage** field, enter any information about the coverage provided under each maintenance contract, the cost of such coverage, or any other contract-related information.

Entering Warranty Information

Enter warranty information on the Asset Warranty (ASSET_WARRANTY) page.

This topic lists prerequisites and discusses how to enter Warranty information.

Pages Used to Enter Warranty Information

<i>Page Name</i>	<i>Definition Name</i>	<i>Usage</i>
Asset Warranty Page	ASSET_WARRANTY	Enter warranty information.
Search for Asset Warranty Templates Page	AM_WTMPL_SRH	Search to find a defined Standard Warranty Template to apply to the asset.

Prerequisites

Before entering asset warranty information, you can:

- Define standard warranty templates.
- Define asset warranty templates.

When these tables have been defined, the templates and defaults are available for assignment to asset warranties.

Related Links

[Entering Warranty Information](#)

Asset Warranty Page

Use the Asset Warranty page (ASSET_WARRANTY) to enter warranty information.

Navigation:

Asset Management > Service and Maintenance > Asset Warranties

This example illustrates the fields and controls on the Asset Warranties page. You can find definitions for the fields and controls later on this page.

The screenshot shows the 'Asset Warranties' page for a specific asset. At the top, it displays asset information: Unit US001, Asset ID 000000000005, Fleet vehicle - Gas/Elec Hybr, Asset Status In Service, Tag P00000009005, Serial ID PRIUS1234, and VIN. Below this is a 'Warranty' section with a 'Sequence 1' header. The main form area is titled '&Detail' and contains several fields: 'Effective Date' (12/17/2012), '*Status' (Active), 'Supplier ID' (USA0000050) with 'ABC Auto Supplies' as the name, 'Contact ID', 'Warranty Number', 'Warranty Name' (50,000 MILES WARRANTY), and 'Warranty End Date'. A 'Coverage' section below shows '100% Parts and Materials'.

Most of the information on this page helps you manage the repair of assets covered by manufacturer warranties.

Field or Control	Description
Sequence	The sequence value is determined by the order or <i>sequence</i> of warranty terms entered for this warranty. This system is enabled to support multiple warranties per asset.
Effective Date and Status	Enter the effective date and status of the warranty. Use these fields to establish a history of when each warranty is first issued and any subsequent information that is relevant. You can add multiple warranty records for an asset. If the warranty is currently valid, select <i>Active</i> in its Status field.
Supplier ID	Select a supplier by ID from the list of those available for this business unit. Identifies the manufacturer. Only valid IDs set up in the Supplier Table are accepted.
Contact ID	Select a warranty contact by ID from the list of those available for this supplier.
Warranty Number	Enter the warranty number or ID.
Warranty Name	Select a warranty name from the list of those available for this SetID.

Field or Control	Description
Warranty End Date	Enter the date the warranty expires.
Coverage	Specify the terms and conditions of each warranty in this memo field.

Search for Asset Warranty Templates Page

Use the Search for Asset Warranty Templates page (AM_WTMPL_SRH) to search for a defined Standard Warranty Template to apply to the asset.

Navigation:

Click the Apply Warranties from Template link on the Asset Warranties page.

Enter search criteria to restrict template selections based on:

- **Asset Type**
- **Asset Subtype**
- **Supplier ID**
- **Model**
- **Item ID**

The valid warranty templates matching the search criteria appear, and you may select one to associated with this asset. Standard warranties are defined on the Standard Warranty Template.

See “Setting Up Asset Warranties” (Asset Lifecycle Management Fundamentals).

Entering Asset Insurance Information

This topic lists prerequisites and discusses how to enter Asset Insurance information.

Use the Asset Insurance (ASSET_INSURANCE) component to set up asset insurance.

The Asset Insurance page captures all of the information necessary to track the insurance coverage for an asset. The *Asset Insurance by Company* query is provided to enable viewing of the insurance by business unit and vendor ID.

Note: (JPN) This feature satisfies the Japanese requirement to link an insurance policy ID to an asset ID.

Page Used to Set Up Asset Insurance Information

<i>Page Name</i>	<i>Definition Name</i>	<i>Usage</i>
Asset Insurance Page	ASSET_INSURANCE	Track insurance information by asset ID.

Prerequisites

The asset insurance pages use data stored in the Vendor table and the Insurance Type table. Before you set up asset insurance, you must first define these tables and establish an asset ID.

To use the Asset Insurance page, you must first:

- Establish insurance types.
- Set up asset insurance vendors.

Related Links

[Entering Asset Insurance Information](#)

Asset Insurance Page

Use the Asset Insurance page (ASSET_INSURANCE) to track insurance information by asset ID.

Navigation:

Asset Management > Service and Maintenance > Asset Insurance

This example illustrates the fields and controls on the Asset Insurance page. You can find definitions for the fields and controls later on this page.

Asset Insurance

Unit US001 Asset ID EX_000000001 2000 Chevrolet Tahoe LT 1/2Ton Tag P00000000001 In Service

Policy ID ABC1234

Insurance Co USAKUJETNA AETNA INSU-001 Insurance Type AUTO

Insurance Information Find | View All First 1 of 1 Last

<p>Effective Date <input type="text" value="01/01/2004"/> </p> <p>Descr <input type="text" value="AUTO Ins"/></p> <p>Location Code <input type="text" value="US001"/> USA - New York</p> <p>Issue Date <input type="text" value="01/01/2004"/> </p> <p>Valuation Type <input type="text" value="User Entered"/></p> <p>Insured Value <input type="text" value="40,000.00"/></p> <p>Current Value <input type="text" value="35,000.00"/></p> <p>Min Insured Val <input type="text"/></p> <p>Premium Amount <input type="text"/></p> <p>Total Cost 39,107.00 USD</p> <p>Replacement Cost</p> <p>Comments <input style="width: 100%; height: 40px;" type="text"/></p>	<p>Status <input type="text" value="Active"/> </p> <p>Long Desc <input type="text" value="Automobile Insurance"/></p> <p>Expiration Dt <input type="text" value="12/31/2006"/> </p> <p>Insurance Indicator <input type="text"/></p> <p>Policy Currency <input type="text" value="USD"/> </p> <p>Appraised Value <input type="text"/></p> <p>Last Indexation Dt <input type="text"/> </p> <p>Premium Frequency <input type="text"/></p> <p>User Defined Amount <input type="text"/></p> <p>Date of last update</p>
---	---

Field or Control	Description
Unit	Displays the business unit selected from the search criteria.
Asset ID	Displays the asset ID selected from the search criteria and with which this insurance information is associated.
Tag	Displays the asset tag number selected from the search criteria.
Policy ID	Displays the insurance policy ID if insurance information has previously been established or displays the ID entered when adding a new value.
Insurance Co (insurance company)	Displays the name of the insurance company for this coverage. The company must already be defined in the vendor file.
Insurance Type	Display or change the insurance type to correspond with this policy coverage. The available insurance types are defined during the setup process.

Insurance Information

Field or Control	Description
Effective Date	Indicates when the insurance coverage takes effect. If you want a history of changes, add new rows to the table and use effective dating to update insurance coverage, rather than making changes to the initial row.
Status	Refers to the status of the Effective Date row.
Descr (description)	Enter a description of the asset.
Long Descr (long description)	Enter a description of the asset.
Issue Date	Enter the insurance coverage issue date.
Expiration Dt (expiration date)	Enter the insurance coverage expiration date.
Valuation Type	Designate the insurance valuation calculation type used for this coverage. No processing takes effect as a result of this entry, but this entry identifies the appropriate calculating method in effect. The available insurance valuation types are: <ul style="list-style-type: none"> • <i>Curr Market Value at Mkt Rate</i> (current market value at market rate): Value at market rate. • <i>User Entered</i>: Enter a definition. • <i>Value as New and Insure</i>: Value as new and insure if repurchased.
Insurance Indicator	Designate the type of asset and risk associated with the asset: <i>On Loan</i> or <i>High Value</i> . Use this indicator to identify assets with any special insurance characteristics for reporting purposes.
Insured Value	Enter the amount of the insured asset value.
Policy Currency	Select the policy currency type. The value of this field is defaulted from the base currency of the business unit default book.
Current Value	Enter the current value of the asset.

Field or Control	Description
Appraised Value	Enter the appraised value of the asset.
Min Insured Val (minimum insured value)	Enter the minimum amount of insurance for the asset.
Last Indexation Dt (last indexation date)	Enter the last date on which an indexation for the asset took place.
Premium Amount	Enter the amount of the premium in full or periodically.
Premium Frequency	Enter the type of premium schedule such as annual, quarter, month and so on.
Total Cost	Displays the total cost, which is derived from the COST table and reported in the base currency of the default book.
User Defined Amount	Corresponds to User Entered value.
Replacement Cost	Displays the replacement cost, which is derived from the replacement cost calculated for the asset and stored on the Basic Asset page.
Date of last update	Displays the date of the last update to the replacement cost.
Comments	Enter any comments. This is a free-text field.

Generating the Asset Warranties Report

You can generate an asset warranty report to review asset warranty information. This topic lists the page used to generate this report.

Page Used to Generate the Asset Warranty Report

Page Name	Definition Name	Usage
Warranties	RUN_AMAS1600	Specify run control parameters to generate an asset warranty report. The warranties reports lists Asset ID, Description, Warranty, Vendor ID, End Date, Coverage.

Reviewing Asset Maintenance History

This topic lists the pages used to review asset maintenance history.

Page Used to View Asset Maintenance History Summaries

<i>Page Name</i>	<i>Definition Name</i>	<i>Usage</i>
Asset Service/Repair History - Maint History by Type (asset service/repair history - maintenance history by type)	ASSET_MAINT_SUM_01	View a summary of asset maintenance by maintenance type. From the Work Order tab, you can link directly to the work order and review maintenance, cost and work order details.

Using Group Asset Processing

Understanding Group Asset Processing

PeopleSoft Asset Management is fully equipped to handle group asset processing for organizations such as utility companies or other entities that support a communal infrastructure—such as federal, state, or municipal public utilities, highways, and roads—or other infrastructure that owns, leases, or uses depreciable assets.

Group assets are treated as a single entity for the purpose of depreciation but as multiple entities for all other purposes. These entities may reside in different locations, or they may be in different stages of their service lives. Nevertheless, you consolidate and depreciate their collective cost as if it were that of a single asset.

Some items commonly tracked as group assets include telephone poles, pipelines, and wire. Some of these group assets can be identified by the Federal Energy Regulatory Commission (FERC) code (delivered with the PeopleSoft system) and depreciated according to FERC guidelines. Group assets are added without cost information. The group member assets are added with associated cost information. Asset transactions, except depreciation and accounting entries, are performed on group member assets. After performing transactions against group members and before running depreciation against the group, the Group Asset Consolidation process is run, consolidating group member cost information at the group asset level. Depreciation is then run against the group asset, and the resulting accounting entries are made.

This topic discusses:

- Asset transactions.
- Depreciated group assets.
- Retired group members.
- Strategy for asset grouping.

Asset Transactions

All transactions, except depreciation and accounting entries, are performed on the group asset's member assets. The member assets can be adjusted, transferred, recategorized, retired, reinstated, and so forth—just like any other asset. You can even transfer group member assets from one group asset to another.

The system applies asset transactions at the group member level. The resulting cost is then consolidated, and the total depreciable basis is depreciated at the group asset level.

Depreciated Group Assets

Each group asset is associated with an average service life that is usually set by the local regulatory agency. The system uses the asset's remaining service life to calculate a group depreciation rate. The

group depreciation rate is usually calculated annually and remains fixed for the entire year. The system then applies this rate to the asset's depreciable basis (the sum of the depreciable bases of its group members) to calculate depreciation expense.

Depreciation expense is booked to general ledger by applying the depreciation rate either to an average account balance for the period (using an averaging option) or to actual activity for the period.

Average service life studies provide the basis for calculating average remaining life for a group of assets. Average service life studies are performed every three or four years, depending on the length of the local regulatory agency's rate cases.

Because depreciation rates are calculated by using remaining service life at the group asset level, and depreciation also takes place at the group asset level, it is not possible to over-depreciate group members.

Flat rate depreciation methods calculate depreciation until the calendar ends. Alternatively, if you don't want to calculate depreciation until the end of the associated calendar, you can specify the number of future years for which depreciation should be calculated when you add the asset.

Note: PeopleSoft Asset Management supports only the flat rate depreciation method for group asset processing.

Note: For optimal processing performance and greater table efficiency, you should specify the number of future years for which depreciation will be calculated rather than calculating it to the end of the calendar. Use the Future Depreciation Years option to do this.

Related Links

[Understanding Adding and Maintaining Assets](#)

Retired Group Members

Retirements can be processed only against group members.

Because all group members of a group asset are generally depreciated as a single unit, and because the depreciation rate is based on a group average remaining life, all assets that are retired from within a group should be fully depreciated with no gain or loss.

However, not all assets that are managed by an organization are fully depreciated when they are retired. PeopleSoft Asset Management enables you to retire a group member as either fully depreciated or not fully depreciated. If not fully depreciated, gain or loss is calculated for the group member. Any accumulated depreciation is moved to the group asset.

Strategy for Asset Grouping

Before you set up group asset processing, consider how you want to group the assets. Asset grouping is not standardized; however, there are key components that apply almost universally. Assets can be grouped by FERC account or subaccount at the highest level. Vintage year and location are also commonly included in a grouping strategy.

Depreciation of group assets identified by the FERC code is usually calculated and booked to the general ledger at the FERC account level by using a group asset depreciation rate. Assets are summed by vintage year within the FERC account to provide statistics to support life studies and, subsequently, to derive the

group rate for the FERC account and vintage year. Grouping by vintage year is also required to support reporting of deferred taxes. Regulatory agencies require reporting of assets by location or jurisdiction. Consequently, they require grouping by location.

Other factors that you should consider in determining how to group assets include depreciation policies, tax reporting requirements, jurisdictional reporting requirements, and corporate accounting procedures. Assets grouped together should have these attributes in common.

This diagram shows an asset grouping scheme:

Asset grouping scheme

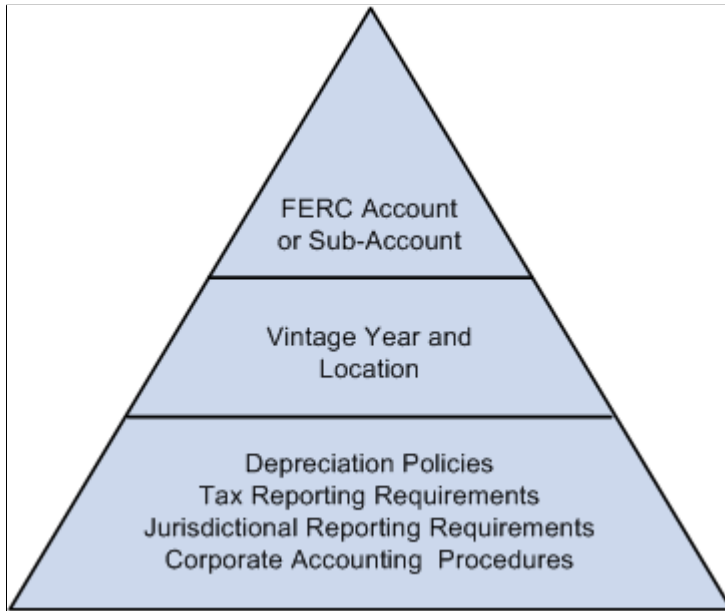

Note: All group asset processes are available for processing with multiple currency transactions enabled.

Prerequisites

To enable group asset processing, you must first set it up at the system and business unit book levels. To set up group asset processing:

1. Select **Set Up Financials/Supply Chain > Install > Installation Options > Asset Management** and then select the **Group Asset Processing** check box.
2. Add or select a business unit and books for group asset processing.
You can use any book or business unit for group asset processing.
3. Associate the books with the business unit, and enable group asset processing at the business unit book level.

You must also select the ChartFields that the system will use to store depreciation records and subsequently charge with depreciation accounting entries.

Because group asset processing is enabled at the book level, a business unit might track assets in both a group asset processing book and another book that does not have group asset processing enabled. An asset would appear exactly the same in both books, but transactions would be processed differently. PeopleSoft Asset Management enables you to track assets in each of the books. Also, you can add a regular asset to the business unit that has group asset processing. The system prompts you to confirm that you want to add the asset as a regular asset.

Adding Group Member Assets

PeopleSoft Asset Management links each group asset to an asset profile. After the profile is linked to the asset, any group members that are added using that profile are automatically linked to that group asset. Much of the book information appears by default from the profile, as well.

To add group member assets:

1. Add a profile for the group member assets.

Be sure to associate this profile with the group asset processing books. Remember, each asset profile that you use for adding group member assets *must* be used by a single business unit. If you have multiple business units that perform group asset accounting, each one must have a unique set of asset profiles for adding group member assets. In this case, you may want to add a business unit identifier to the asset profile ID to facilitate recognition.

2. Using the ExpressAdd component, add a group asset ID.

Use the group asset profile to display the default book information for the asset. Do not add any cost information. Be sure to enter transaction and accounting dates that cover all group member assets. In the **Group Flag** field, select *Group ID*.

3. Link the group asset ID to the group member profile.

Return to the profile that you created. On the Depreciation page, select the **Group Asset ID** field. A list appears with all group assets for the business unit. Select the group asset (and all related group members) to link to this profile. You can override the default and enter a different group asset when you add the group members.

Next, add group member assets. Do this online or in a background process. It is recommended that you add group member assets using a background process. This reduces the likelihood of errors, frees up human resources, and saves time.

Related Links

[Adding and Maintaining Asset Information](#)

“Setting Up Asset Profiles” (Asset Lifecycle Management Fundamentals)

Adding Group Member Assets with Background Processing

Add group member assets by using background processing if the assets originated in another system. In that case, all asset data exists in either relational tables or a flat file format. To load the asset data into PeopleSoft Asset Management, you perform the steps discussed here.

To add group member assets with background processing:

1. Add a value for the **PROFILE_ID** field to each asset record.
2. Set the value of the **PROFILE_ID** field to equal the asset profile on which you want to base the group member assets.

Information in the profile populates the **GROUP_ASSET_ID** field and **GROUP_ASSET_FLAG** field in the Asset Management loader tables.

Note: The **GROUP_ASSET_FLAG** field must be set to *M*, and the **GROUP_ASSET_ID** field must be populated with the ID of a group asset. If these aren't set properly, group asset accounting does not work.

The next step depends on whether the data resides in relational tables or in flat files.

Relational Table Data

If the data resides in relational tables, write a Structured Query Report (SQR) to transfer the data to the PeopleSoft Asset Management loader tables. Then run the Transaction Loader process to transfer the load lines into PeopleSoft Asset Management as open transactions.

Note: Follow the same procedure outlined within the Custom SQR Conversion section in the Converting to PeopleSoft Asset Management topic.

Related Links

[Understanding Conversion to PeopleSoft Asset Management](#)

Adding Group Member Assets Online

Add group member assets online using the Asset ExpressAdd component.

When you add a group member asset online, remember that you must enter a group member profile ID for the asset. The group member profile automatically associates the group member with a particular group asset, flags it as a group member asset, and links it to a group asset processing book (or books). Remember, you must select a profile ID that is unique to the business unit.

Make sure that the **Group Asset Flag** field is set to *Grp Member* in the ExpressAdd component.

Related Links

[Adding and Maintaining Asset Information](#)

Adding Group Asset IDs with Background Processing

Group asset IDs, like group member assets, can be loaded using a background process. In the Transaction Loader, you use the `Default_Profile_SW = "N"` option. Consequently, you must load one record for each book of each asset into `INTFC_FIN`.

Load these required fields into the `PS_INTFC_FIN` table when adding group asset IDs:

- INTFC_ID
- INTFC_LINE_NUM
- BUSINESS_UNIT
- ASSET_ID

This is the group asset ID.

- BOOK
- DTTM_STAMP
- APPROVAL_SW
- LOAD_STATUS
- DEFAULT_PROFILE_SW = 'N'
- CATEGORY
- METHOD

Set the method to *FL* (flat rate).

- DEPR_PERCENT
- CONVENTION
- DEPR_AVG_OPTION
- IN_SERVICE_DT
- TRANS_DT
- CURRENCY_CD

Load these fields into the PS_INTFC_PHY_A record when loading group asset IDs:

- INTFC_ID
- INTFC_LINE_NUMBER
- BUSINESS_UNIT
- ASSET_ID

This is the group asset ID.

- DTTM_STAMP
- INTFC_TYPE
- SYSTEM_SOURCE
- APPROVAL_SW

- LOAD_STATUS
- DEFAULT_PROFILE_SW
- ASSET_STATUS
- FINANCIAL_ASSET_SW
- PROFILE_ID
- GROUP_ASSET_FLAG
- CURRENCY_CD
- CUSTODIAN_EFFDT
- LOCATION_EFFDT

Note: You can include physical attribute data (asset location and asset custodian) for the group asset; however, the custodian and location effective-dated fields are required. The physical attribute data must be loaded into the PS_INTFC_PHY_A table.

Note: If a profile is already created for a group asset ID and you load the group asset ID in a background process, the system detects the profile ID in the PROFILE_DET_TBL table and returns an error.

Related Links

[Understanding Conversion to PeopleSoft Asset Management](#)

Performing Transactions on Group Member Assets

This topic discusses how to transfer group members among group assets.

Although you depreciate grouped assets and make accounting entries at the group asset level, you perform all other transactions for grouped assets at the group member level. You can perform these transactions on group member assets:

- Adds
- Adjustments
- Transfers
- Recategorizations
- Retirements
- Reinstatements

Perform these transactions on group member assets the same way in which you perform these transactions on other assets.

You can override the estimated accumulated depreciation at the group member level on the following transactions:

- Asset transfers
- Interunit transfers
- Fixed price markup
- Recategorizations
- Retirements

See [Running the Group Member Estimated Net Book Value Report](#).

Transferring Group Members Among Group Assets

Transfer a group member asset from one group asset to another by using the Asset Book Definition component.

To transfer group member assets:

1. Access the Asset Book Definition page.
2. Change the group asset ID to the new group that you want to associate with the member asset.
3. Enter the transaction date and accounting date.

Note: Enter a group asset ID for a group asset processing book only.

Consolidating Group Member Assets

This topic provides an overview of consolidation of group member assets and discusses how to run the Group Asset Consolidation process (AMGRPCON).

Pages Used to Consolidate Group Member Assets

<i>Page Name</i>	<i>Definition Name</i>	<i>Usage</i>
Consolidate Page	AMGRPCON_RQST	Run the process that consolidates cost information for group member assets. The process summarizes cost information of group members at the group level, based on the ChartFields that you specify on the Business Unit/Book Definition page. Run this process before calculating depreciation for group assets.

Page Name	Definition Name	Usage
Group Member Open Transaction Detail Page	AMGRPCON_DET_SEC	Review open transactions for group members. See Consolidate Page

Understanding Consolidation of Group Member Assets

PeopleSoft Asset Management provides the Group Asset Consolidation process, which consolidates (or summarizes) group member asset cost information at the group level, based on ChartFields that you specify. Once the process has been run, cost and depreciation information for all group members is stored at the group level. The process summarizes asset addition (ADD) and asset adjustment (ADJ) transactions. Other transactions such as transfers, retirements, and reinstatements are copied to the group asset level without consolidation because the system calculates reserve at the group member level. However, after you run depreciation for these transactions, they are consolidated at the group level the next time that you run the Group Asset Consolidation process.

The Group Asset Consolidation process uses the transaction period in which the ADD or ADJ transaction occurs, except when you use the actual-day depreciation convention. In that case, the process uses the actual transaction date. The period of the in-service date is also a factor when consolidating ADD transactions.

You must run the Group Asset Consolidation process before you depreciate group assets. When you next run the process to summarize new group member additions and adjustments, the process consolidates the new transactions with the previously summarized transactions for greater table efficiency.

Consolidate Page

Use the Consolidate page (AMGRPCON_RQST) to Run the process that consolidates cost information for group member assets.

The process summarizes cost information of group members at the group level, based on the ChartFields that you specify on the Business Unit/Book Definition page. Run this process before calculating depreciation for group assets.

Navigation:

Asset Management > Depreciation > Group Asset Depreciation > Consolidate Group Assets > Consolidate

This example illustrates the fields and controls on the Consolidate page. You can find definitions for the fields and controls later on this page.

Note: Accumulated depreciation for group member assets is loaded at the member asset level, and the Group Asset Consolidation (AMGRPCON) process consolidates at a group level.

Consolidation Example for Asset Additions

This example shows how group member cost information is consolidated for asset additions. In this example, Project and Category represent the ChartFields selected for summarization. The example is based on a monthly depreciation calendar.

This table shows the cost records for nine member assets that belong to one group asset before you run the Group Asset Consolidation process:

Asset	Trans Date	Acct Date	In Svc Date	Depr Conv	Oper Unit	Dept	Project	Cate-gory	Cost Type	Cost	Group Asset
1	Jan 1, 2XX3	Jan 1, 2XX3	Jan 1, 2XX3	AM	PL01	32000	1	AUTO	C	1,000	GR1
2	Jan 5, 2XX3	Jan 31, 2XX3	Jan 15, 2XX3	AM	PL05	53000	1	AUTO	NA	2,000	GR1
3	Jan 31, 2XX3	Jan 31, 2XX3	Jan 1, 2XX3	AM	NA	53000	1	AUTO	M	1,300	GR1
4	Jan 20, 2XX3	Jan 20, 2XX3	Jan 15, 2XX3	AM	PL06	10200	2	AUTO	C	2,300	GR1

Asset	Trans Date	Acct Date	In Svc Date	Depr Conv	Oper Unit	Dept	Project	Cate- gory	Cost Type	Cost	Group Asset
5	Jan 25, 2XX3	Jan 31, 2XX3	Jan 20, 2XX3	AM	NA	NA	2	AUTO	NA	4,300	GR1
6	Jan 31, 2XX3	Jan 31, 2XX3	Jan 20, 2XX3	FM	PL07	29321	2	AUTO	NA	6,290	GR1
7	Dec 31, 2XX2	Jan 6, 2XX3	Jan 1, 2XX3	AM	PL01	32000	1	AUTO	C	3,400	GR1
8	Jan 15, 2XX3	Jan 15, 2XX3	Dec 15, 2XX2	FM	PL01	32000	1	AUTO	C	3,400	GR1
9	Jan 31, 2XX3	Jan 31, 2XX3	Dec 31, 2XX2	FM	PL01	53000	1	AUTO	C	1,230	GR1

This table shows how the Group Asset Consolidation process consolidates the nine group member cost rows into five group asset cost rows:

Group ID	Trans Date	Acct Date	In Svc Date	Depr Conv	Project	Category	Cost
GR1	Jan 1, 2XX3	Jan 31, 2XX3	Jan 1, 2XX3	AM	1	AUTO	4,300
GR1	Jan 1, 2XX3	Jan 31, 2XX3	Jan 1, 2XX3	AM	2	AUTO	6,600
GR1	Jan 1, 2XX3	Jan 31, 2XX3	Jan 1, 2XX3	FM	2	AUTO	6,290
GR1	Dec 1, 2XX2	Jan 31, 2XX3	Jan 1, 2XX3	AM	1	AUTO	3,400

Group ID	Trans Date	Acct Date	In Svc Date	Depr Conv	Project	Category	Cost
GR1	Jan 1, 2XX3	Jan 31, 2XX3	Dec 1, 2XX2	FM	1	AUTO	4,630

The cost rows are consolidated in this way:

- Group row 1 summarizes group member rows 1, 2, and 3.
- Group row 2 summarizes group member rows 4 and 5.
- Group row 3 summarizes group member row 6.
- Group row 4 summarizes group member row 7.
- Group row 5 summarizes group member rows 8 and 9.

Each of the group cost rows is then depreciated separately. In addition, the begin depreciation date for each asset is updated in this way:

Asset ID (Group Members)	Updated Begin Depreciation Date
1	January 1, 2XX3
2	January 1, 2XX3
3	January 1, 2XX3
4	January 1, 2XX3
5	January 1, 2XX3
6	February 1, 2XX3
7	January 1, 2XX3
8	January 1, 2XX3
9	January 1, 2XX3

Consolidation Summary Levels

The consolidation summary levels are:

- Business unit.
- Book.
- Group asset ID.
- Depreciation convention.
- Transaction period (except when the actual-day convention is used; in that case, the actual transaction date is used instead of the period).
- Period of accounting date.
- Period of in-service date (ADD transactions only).
- Category ChartField (required).
- General ledger ChartFields and cost type (optional, depending on the settings on the Business Unit/Book Definition page).

Consolidation Example for Asset Adjustments

This example shows how group member cost information is consolidated for asset adjustments. In this example, Project ID and Category represent the ChartFields selected for summarization.

This table shows the cost records for nine member assets that belong to one group asset before you run the Group Asset Consolidation process:

<i>Asset ID</i>	<i>Trans Date</i>	<i>Acct Date</i>	<i>Depr Conv</i>	<i>Oper Unit</i>	<i>Dept</i>	<i>Project</i>	<i>Cate-gory</i>	<i>Cost Type</i>	<i>Cost</i>	<i>Group Asset</i>
1	Mar 1, 2XX3	May 1, 2XX3	AM	PL01	32000	1	AUTO	C	200	GR1
2	Mar 12, 2XX3	May 12, 2XX3	AM	PL05	53000	1	AUTO	NA	120	GR1
3	Mar 15, 2XX3	May 31, 2XX3	AM	NA	53000	1	AUTO	M	250	GR1
4	Mar 31, 2XX3	May 12, 2XX3	AM	PL06	10200	2	AUTO	C	90	GR1
5	Mar 20, 2XX3	May 30, 2XX3	AM	NA	11000	2	AUTO	NA	120	GR1

Asset ID	Trans Date	Acct Date	Depr Conv	Oper Unit	Dept	Project	Category	Cost Type	Cost	Group Asset
6	Apr 30, 2XX3	May 15, 2XX3	AM	PL07	29321	2	AUTO	NA	75	GR1
7	Apr 30, 2XX3	Jun 1, 2XX3	AM	PL01	32000	1	AUTO	C	200	GR1
8	May 15, 2XX3	Jun 14, 2XX3	AM	PL01	32000	1	AUTO	C	430	GR1
9	May 31, 2XX3	Jun 30, 2XX3	AM	PL01	53000	1	AUTO	C	892	GR1

This table shows how the Group Asset Consolidation process consolidates nine group member cost rows into five group asset cost rows:

Group ID	Trans Date	Acct Date	DeprConv	Project ID	Category	Cost
GRP1	Mar 1, 2XX3	May 31, 2XX3	AM	1	AUTO	570
GRP1	Mar 1, 2XX3	May 31, 2XX3	AM	2	AUTO	210
GRP1	Apr 1, 2XX3	May 31, 2XX3	AM	2	AUTO	75
GRP1	Apr 1, 2XX3	Jun 30, 2XX3	AM	1	AUTO	200
GRP1	May 1, 2XX3	Jun 30, 2XX3	AM	1	AUTO	1,322

The cost rows are consolidated in this way:

- Group row 1 summarizes group member rows 1, 2, and 3.
- Group row 2 summarizes group member rows 4 and 5.
- Group row 3 summarizes group member row 6.
- Group row 4 summarizes group member row 7.
- Group row 5 summarizes group member rows 8 and 9.

Calculating Depreciation for Group Assets

This topic discusses how to run the Group Asset Depreciation process.

Page Used to Calculate Depreciation for Group Assets

<i>Page Name</i>	<i>Definition Name</i>	<i>Usage</i>
<u>Group Asset Depreciation Page</u>	RUN_AMDPCGRP	Run the depreciation calculation process for group assets. View the Asset Batch Process error log for information about problems that occurred during the process.

Group Asset Depreciation Page

Use the Group Asset Depreciation page (RUN_AMDPCGRP) to run the depreciation calculation process for group assets.

View the Asset Batch Process error log for information about problems that occurred during the process.

Navigation:

Asset Management > Depreciation > Group Asset Depreciation > Calculate Group Asset Depr > Group Asset Depreciation

Select the parameters that this process will use to include assets in the calculation.

View the Asset Batch Process error log for information about problems that occurred during the process but did not terminate the process.

Indexing to Increase Processing Performance

To increase processing performance, PeopleSoft recommends that you create an index, as follows:

```
CREATE INDEX ON PS_OPEN_TRANS (BUSINESS_UNIT, GROUP_ASSET_ID, BOOK, TRANS_TYPE, DTTM_ST⇒
AMP)
```

Running the Group Member Estimated Net Book Value Report

This topic provides an overview of the estimated net book value calculation and discusses how to run the Group Member Estimated Net Book Value (NBV) report.

Page Used to Run the Group Member Estimated Net Book Value Report

<i>Page Name</i>	<i>Definition Name</i>	<i>Usage</i>
<u>Group Member Estimated NBV Page</u>	RUN_AMDP2150_RPT	Estimate the net book value (NBV) of an asset member before selling the asset.

Understanding the Estimated Net Book Value Calculation

The Group Member Estimated Net Book Value (NBV) report enables you to estimate the net book value of asset members. The report provides the estimated accumulated depreciation of the member by using the following formula:

$$\text{Cost of member (cost)} - \text{Estimated life-to-date depreciation of member, using historical rate of the group (expense)} = \text{Estimated net book value}$$

Note: The report provides only an estimate of the NBV.

Related Links

[Asset Cost IU Book Transfer page](#)

Group Member Estimated NBV Page

Use the Group Member Estimated NBV page (RUN_AMDP2150_RPT) to estimate the net book value (NBV) of an asset member before selling the asset.

Navigation:

Asset Management > Financial Reports > Cost and Depreciation > Group Member Estimated NBV Rpt > Group Member Estimated NBV

This example illustrates the fields and controls on the Group Member Estimated NBV page. You can find definitions for the fields and controls later on this page.

Group Member Estimated NBV

Run Control ID Group1 Report Manager Process Monitor
Run

Request
Find | View All First 1 of 1 Last

'Request ID'
 Load Member Reporting Table + -

'Unit'

'Book Name'

Assets

From Asset
To Asset

OR

Group ID

Accounting Period

Fiscal Year
Period

OR

Trans Date

Note: The business unit and book name must be associated with a group asset.

<i>Field or Control</i>	<i>Description</i>
Load Member Reporting Table	Select to record the member accumulated depreciation. If this check box is not selected, the report is printed and the member accumulated depreciation is not recorded in the table (DEPR_RPT_MEM).

Changing Rates Retroactively

Utility companies often must use an interim depreciation rate pending FERC settlement of a rate case. The process of changing rates retroactively enables utility companies to retroactively recalculate group depreciation using a new rate.

This topic discusses how to process retroactive rate changes.

Pages Used to Change Rates Retroactively

<i>Page Name</i>	<i>Definition Name</i>	<i>Usage</i>
Create New Group Rate	AMGRPRRC_RQST	Enter a new rate and initiate the Group Asset Rate Change process.
Group Asset Depreciation	RUN_AMDPCGRP	Run the depreciation calculation process for group assets. This process picks up the retroactive rate change (RRC) open transaction records and recalculates depreciation as of the transaction date.
Run Depreciation Close Process	DEPR_CLOSE_RQST	Run the depreciation close process (AM_DPCLOSE) to pick up the prior period depreciation (PDP) entries and generate accounting entries.

Processing Retroactive Rate Changes

To process retroactive rate changes:

1. On the Create New Group Rate page, enter the new rate, a range of assets to which the rate applies, and the transaction date on which the rate change retroactively became effective.
2. Run the Group Asset Rate Change process (AMGRPRRC).

The process updates the asset book and creates a book history entry with the new rate for the range of group assets that you specify. It also creates RRC open transaction records.

3. When you next run the Group Asset Depreciation process (AMDPCGRP), it picks up the RRC open transaction records and recalculates depreciation as of the transaction date.

The Group Asset Depreciation process also generates PDP entries in the depreciation table for the difference in the depreciation amounts.

4. When you next run the Depreciation Close process (AM_DPCLOSE), it picks up the PDP entries and generates accounting entries.

Reviewing Asset Book History

The Asset Book History component enables you to review a list of all book changes for an asset. You can use the Book History List page or view the details of a listed item on the Book History Detail page.

This topic lists the pages used to review asset book history.

Pages Used to Review Asset Book History

<i>Page Name</i>	<i>Definition Name</i>	<i>Usage</i>
Asset Book History - List	ASSET_BOOK_HIST1	Review a list of book changes for an asset.
Asset Book History - Detail	ASSET_BOOK_HIST2	Review the details of a book change for an asset.

Using Composite Asset Processing

Understanding Composite Asset Processing

Composite Asset Processing, frequently used by utility companies, is a way of grouping many assets so that their total cost is carried by, and depreciated as, one asset. This single asset is termed a *composite* asset, and associated assets are known as composite members.

In composite processing, no transaction detail is carried by individual composite members. All transaction detail, including any gain or loss accrued upon retirement, is rolled up to the composite asset level. Once this rollup occurs, no transaction detail is retained by composite members. Because depreciation occurs at the composite asset level, only the composite asset carries any information—such as book, depreciation method, prorate convention, or life—that relates to depreciation.

This graphic illustrates a composite asset.

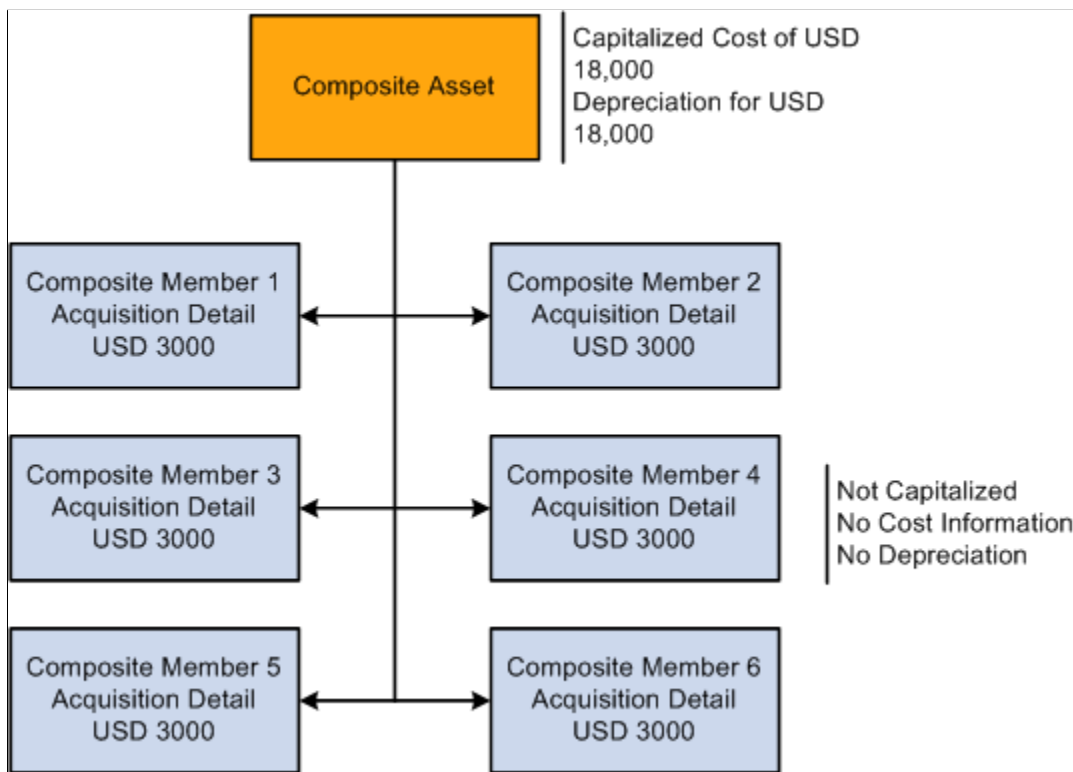

Because the composite asset carries all the cost for its associated composite members, it is a financial, or capitalized, asset. The composite asset can also carry its own cost information or not, as required, although no individual detail is retained once the total cost has been rolled up. Composite member assets, on the other hand, are nonfinancial assets, or not capitalized, and carry no cost information. Instead, they carry acquisition detail, which is summed up and capitalized at the composite asset level.

All transactions are performed at the composite asset level except for adjustments to acquisition detail. Adjustments are made at the composite member level and then rolled up to the composite level.

Note: The fair value (FV) of the asset does not roll up from the composite member to the composite level.

Summing up and adjusting cost information for composite assets is accomplished through a mass change that:

- Sums the acquisition detail for each ChartField combination contained in the affected Composite Member assets.
- Inserts one cost row into the Composite Asset for the total of each ChartField combination.

Note: Composite members are not considered in the Capitalization Threshold evaluation.

Adding a Composite Asset

Using Asset Basic Information, you must perform three steps to add a composite asset:

1. Select the **Composite Asset** check box on the General Information page.
After you save the asset, make note of its Asset ID.
2. Enter an asset **Profile ID** on the General Information page.
3. Capitalize the asset on the Asset Acquisition Detail page by selecting the **Capitalize** button.

You can enter cost information or not, as required.

See [Adding and Maintaining Asset Information](#).

Adding Composite Member Assets

Using Asset Basic Information, you must perform these steps to enter composite member assets:

1. Associate the member with a composite asset.
Select the **Composite Asset** check box on the General Information page and associate the composite member by selecting a composite asset in the **Composite Asset ID** field.
2. On the Asset Acquisition Detail page, assign a **Capitalize** status of *To be Capitalized*.
The composite member is uncapitalized with no cost rows. You can use a Profile ID for composite member assets if you want. However, you must use a nonfinancial asset profile. A composite member asset may display an **Amount left to Capitalize** if it has any acquisition detail. This amount is displayed until the composite member is capitalized into its associated composite asset.
3. Add appropriate acquisition details to the composite member on the Asset Acquisition Detail page.

Note: A nonfinancial Asset Profile does not contain any book information. On the pages of the Asset Basic Information component, Capitalized Asset should not be selected.

4. Select an asset type (if no profile has been established).

See [Adding and Maintaining Asset Information](#).

See “Setting Up Asset Profiles” (Asset Lifecycle Management Fundamentals).

Capitalizing Composite Members into Composite Assets

To capitalize composite members into their associated composite asset, you need to run the mass transaction *CC - Capitalize into Composite*.

Related Links

[Understanding Mass Transaction Manager](#)

Retiring Composite Members from Composite Assets

To retire composite members from their associated composite asset, you need to run the mass transaction *CR - Composite Retirement*.

Related Links

[Understanding Mass Transaction Manager](#)

Loading Composite Asset Transactions

After you have run a Composite Asset mass transaction, use the Transaction Loader to load results of the mass transaction into the PeopleSoft Asset Management tables.

The Load Type for *capitalize into composite* transactions is *CIC*. The Load Type for retire from composite transactions is either *PRT* or *RET*, depending on whether you are doing a partial or a full retirement.

See “Running the Transaction Loader” (Asset Lifecycle Management Fundamentals).

Understanding the Effect of Capitalization into Composite

After your composite member assets are capitalized, they are designated *Already Capitalized* on the Asset Acquisition Detail page. The **Capitalization Information** group box is inactive. The Asset Acquisition Detail page no longer displays an amount or quantity that is left to capitalize.

The Composite Asset into which you capitalized will now contain one cost row for each ChartField combination represented in the acquisition detail of the composite members you just rolled up. To view

this, select **Asset Management > Asset Transactions > Financial Transactions > Cost Adjust/Transfer Asset > Cost Information.**

Note: The Cost Information page appears after clicking the Search button.

Understanding the Effect of Retirement from Composite

After you retire a Composite Member from a Composite Asset, the cost row for the ChartField combination you retired will be decreased by the amount you retired. To view this, select **Asset Management > Asset Transactions > Asset Disposal > Retire/Reinstate Asset > Retire Assets.** You can also view this information on the Cost Information page.

Because Composite Member Assets carry no cost information, you will not see any change in them after retirement.

Performing Transactions on Composite Assets

All transactions on composite assets are performed at the composite asset level except adjustments to cost. Adjustments to cost/quantity are made at the composite member level as adjustments to acquisition detail, and then rolled up to the composite level and capitalized, where they are recognized as adjustments to total cost/quantity.

Transaction on Composite Elements

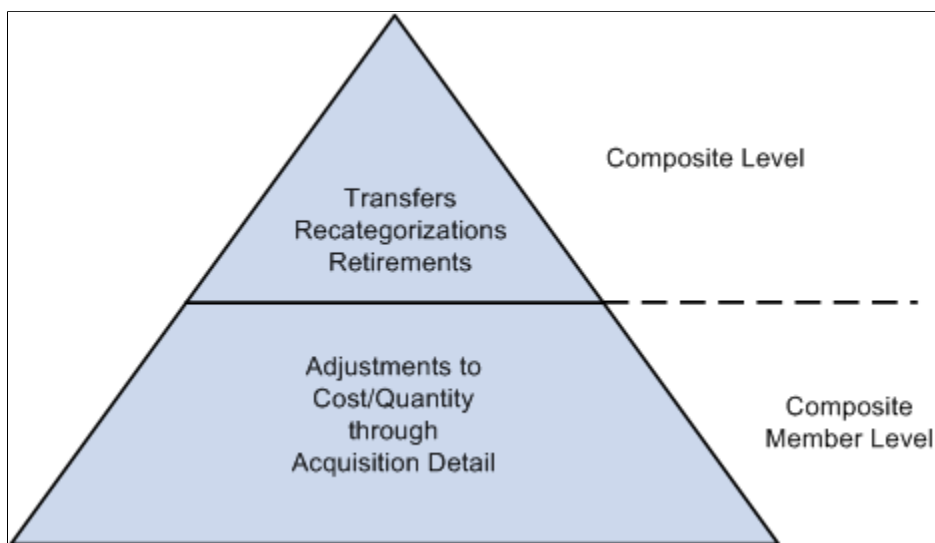

Adjustments to Cost/Quantity

Using Asset Basic Information, you must perform three steps to adjust the cost/quantity of a composite asset:

1. Add a row of acquisition detail to one of the associated Composite Members.

This row should equal the amount of the desired cost/quantity adjustment and contain the appropriate ChartField combination. The additional row is reflected in the Amount Left to Capitalize on the Asset

Acquisition Detail page. If you want to add cost/quantity for more than one ChartField combination, enter additional rows.

2. Use mass transaction to capitalize the adjusted Composite Member into the Composite Asset.
3. Run the Transaction Loader.

Recategorizations and Transfers

Recategorizations and transfers on composite assets are performed at the composite level. Perform these transactions on composite assets as you would for any other asset by using the Asset Cost Adjust/Transfers component.

To transfer a composite asset:

1. Select **Asset Management > Asset Transactions > Financial Transactions > Cost Adjust/Transfer Asset** to access the Main Transaction page.
2. Select the **Transaction Date, Accounting Date, Transaction Code, and Rate Type**. Select *Transfer* in the **Action** drop-down list box. The **Transaction Type** for transfers is *TRF*.
3. Enter new ChartField information into the appropriate fields on the Cost Information page.

PeopleSoft recommends that you change information one field at a time to establish an audit trail. For example, if you need to change the department and project, first enter the new department and save the change. Then go back and change the project.

The Composite Asset may have several cost rows, each for a separate ChartField combination. These rows are the totals, by ChartField combination, of all the acquisition detail for the associated Composite Member Assets that have been capitalized into the Composite Asset.

4. Save your changes.

See [Understanding Adjusting, Transferring, Reversing, and Evaluating Assets](#).

Chapter 16

Performing Asset Physical Inventory

Understanding Physical Inventories

Physical Inventory Terminology

The following terms are integral to physical inventory processing and reconciliation.

Term	Definition
Asset Repository	The database of assets stored within the PeopleSoft Asset Management system. The repository provides a single, centralized database that stores and tracks organizational assets physically and financially.
Physical Inventory ID	A physical inventory control ID you assign within PeopleSoft Asset Management for each physical inventory that you perform.
Extract scope	Set of all assets that you might scan during a physical inventory. This set of assets is broader than the scan scope. It should include all possible locations, departments, profiles, cost limits, categories, class types and subtypes for the assets to be inventoried.
Extract data	Data extracted from PeopleSoft Asset Management before you perform the physical inventory scan. This data should include all assets that you might scan during the physical inventory scan.
Extract file	PeopleSoft Asset Management creates a sequential file of the physical inventory data collected for each asset. The files are created as random access files when you enter a tag or serial number. One is sorted by tag number and one is sorted by serial number.
Physical inventory scan	Process of scanning assets with a bar code scanning device, such as a mobile handheld device.
Physical inventory scan scope (classic physical inventory)	Set of all assets that are defined in PeopleSoft Asset Management as belonging to a particular location or department to be scanned.

Term	Definition
Physical inventory scan scope (mobile physical inventory)	Set of all assets that you might scan during physical inventory. Scan scope can be viewed using the Physical Inventory tile in the PeopleSoft Fluid User Interface.
Physical inventory scan data	Data collected by the bar code scanning device during the physical inventory.
Mass Transaction Manager	PeopleSoft Asset Management Mass Transaction Manager is used to define the scan scope. The mass transaction definition is a user-defined scan scope and includes the area of the <i>actual</i> scan.
Overs	Any assets that appear in the scanned data but not in the scan scope.
Unders	Any assets that appear in the scan scope but not in the scanned data.

Mobile Physical Inventory and Classic Physical Inventory

PeopleSoft Asset Management provides two methods to perform physical inventory:

- *Classic physical inventory* (the physical inventory method delivered *prior* to PeopleSoft Image 9.2.016).
- *Mobile physical inventory* (the physical inventory method delivered with PeopleSoft Image 9.2.016).

You can use either method to perform physical inventory. However, there are key differences you should understand.

The mobile physical inventory method enables you to scan assets, retrieve and display real-time asset information from the Asset Repository, and automatically populate the Physical Inventory (PI_SCAN) interface and Scan History (PI_SCAN_HIST) tables with scan records—all from your mobile scanning device and without the use of a third party scanning solution. The classic physical inventory method requires a third party scanning solution and necessitates that you use flat files to populate the Physical Inventory interface table with scan records.

The mobile physical inventory method automatically maintains asset scan history in the Scan History (PI_SCAN_HIST) table. When an asset or tag is scanned, this table records the date and time it was scanned. If an asset is scanned again, another record is inserted into the table. The previous record remains to provide a history. The Scan History table is not used with the classic physical inventory method.

The classic physical inventory method requires you to extract assets and generate an extract file, then load the scan file back into Asset Management to create a set of all assets that you might scan during a physical inventory. However, with the mobile physical inventory method you can simply run the Generate Scan Scope process to create a list of assets that you expect to scan. With the Generate Scan Scope process, if an asset is scanned and not found in the Scan Scope, the asset is automatically retrieved directly from the Asset Repository.

Because the mobile physical inventory method does not require flat file downloads and uploads, or an extract scope, there are fewer processing steps than the classic method.

The following diagrams provide a high-level process flow of the two physical inventory methods:

The following diagram illustrates the Classic physical inventory method.

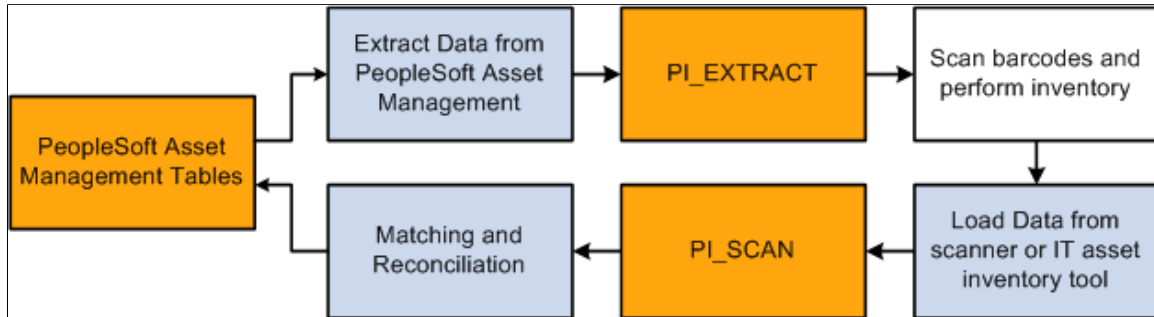

The following diagram illustrates the Mobile physical inventory method

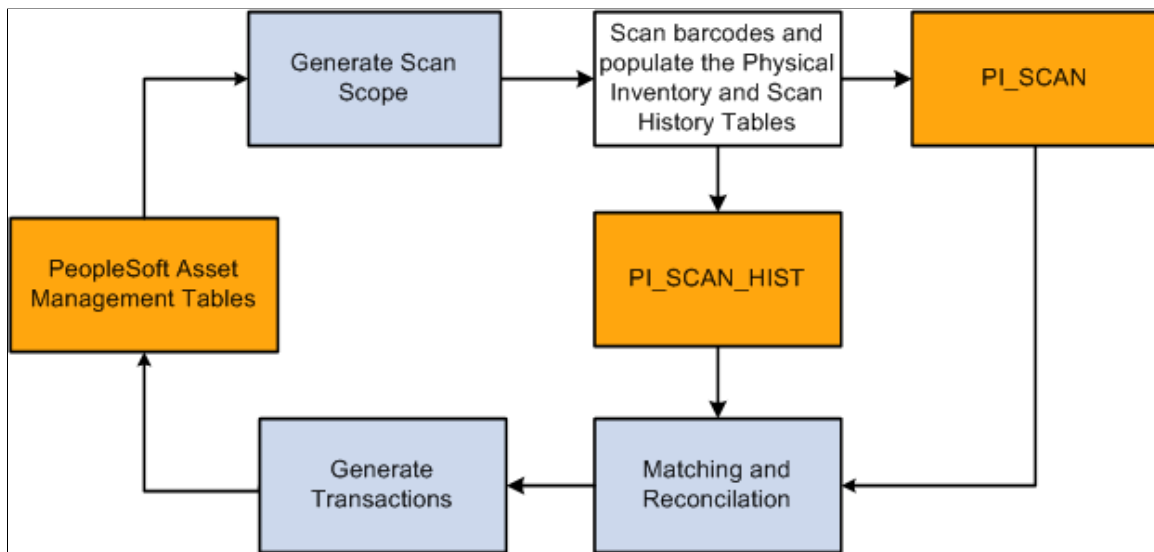

Mobile Physical Inventory

Mobile physical inventory enables you to perform mobile physical inventory—scanning assets, retrieving and displaying asset information from the Asset Repository, and automatically populating the Physical Inventory and Scan History tables with scan records—all from your mobile scanning device.

To facilitate mobile physical inventory, PeopleSoft Asset Management provides the new **Physical Inventory** tile within the **Asset Tracking** homepage.

Physical Inventory tile and the Asset Tracking homepage

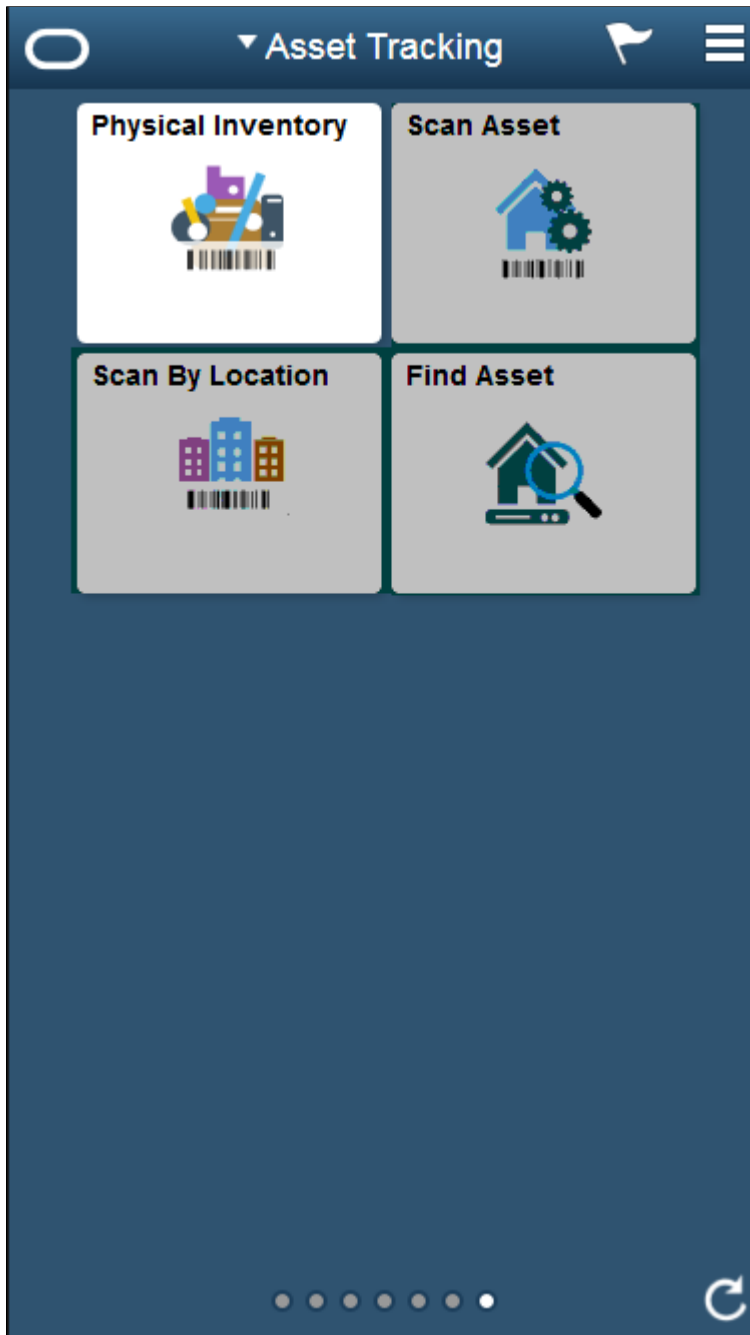

The Physical Inventory tile is part of the PeopleSoft Fluid User Interface and can be accessed from your mobile scanning device (with web browsing capability).

The Physical Inventory tile enables you to:

- Perform mobile physical inventory.
- Access real time data in the Asset Repository using your mobile scanning device.
- Add a new asset or edit an existing asset using your mobile scanning device.

- Automatically populate the PI_SCAN and PI_SCAN_HIST tables with scan records, simply by scanning a barcode.
- Send email notifications regarding an asset from your mobile scanning device.

You will use the Physical Inventory tile *after* you run the Generate Scan Scope process and *before* you run the Generate Results process and the Generate Transactions process.

For more information on using the Physical Inventory tile, see:

[Understanding Mobile Physical Inventory Processing](#)

[Physical Inventory Page](#)

Mobile Physical Inventory Processing

Follow these steps to perform mobile physical inventory:

1. Set up and configure physical inventory per your requirements.

See [Configuring Physical Inventory](#)

2. Set up scan scope parameters and run the Generate Scan Scope (AMPI1000) process. The Generate Scan Scope process automatically defines a set of assets that should be scanned and enables that information to be discoverable by your scanning device.

Note: You do not need to manually populate the PI_EXTRACT table, create an extract file, and load the file into a scanning device.

See:

[Defining the Extract Scope, the Scan Scope, and the Physical Inventory Parameters](#)

[Load/Match/Reconcile PI Info Page \(Mobile Physical Inventory\)](#)

3. Perform barcode scanning in combination with the Physical Inventory tile in the PeopleSoft Fluid User Interface; this populates the Physical Inventory (PI_SCAN) and Scan History (PI_SCAN_HIST) tables with scan records.

See [Physical Inventory Page](#)

4. Run the Generate Results (AMPI1000) process to perform scan scope/scanned data matching and generate physical inventory results for review.

See [Physical Inventory Page](#)

5. Run the Generate Transactions (AMPI1000) process to move transactions from the PI_SCAN interface table to Asset Management tables.

See [Physical Inventory Page](#)

6. Run the Delete Data (AMPI1000) process to delete physical inventory transactions, physical inventory results, and physical inventory scanned asset data when you no longer need them.

See [Physical Inventory Page](#)

Prerequisites

The following prerequisites are required prior to setting up and performing physical inventory in PeopleSoft Asset Management:

- All assets must have tag numbers.
- All assets must belong to a particular department or location, or you must have some other way to track their whereabouts, such as asset custodian.

Hardware and Software Requirements for Mobile Physical Inventory

There are hardware and software requirements necessary for performing mobile physical inventory. These requirements are listed here.

Hardware

The following hardware requirement is necessary for physical inventory processing:

Mobile device paired with barcode scanner or dedicated barcode scanner: A handheld unit that you can use to collect asset data. The device must have web browsing capability to access the PeopleSoft Fluid User Interfaces available in the Asset Tracking homepage.

Note: You can integrate the Physical Inventory feature of PeopleSoft Asset Management with virtually any bar coding hardware.

Software

The following are software requirements and information necessary for performing physical inventory:

Barcode scanning devices using an Apple Operating System (iOS): Barcode scanning devices using an Apple Operating System must use the Safari browser in full screen mode. Furthermore, the virtual keyboard will not display when using the Physical Inventory tile in the PeopleSoft Fluid User Interface.

Barcode scanning devices using an Android Operating System: Barcode scanning devices that use an Android Operating System will display the virtual keyboard when using the Physical Inventory tile in the PeopleSoft Fluid User Interface.

Classic Physical Inventory

For classic physical inventory processing, suppose that you are inventorying computer equipment. An IT discovery tool obtains the physical attributes of a workstation, along with the amount of installed memory, the type of monitor, the amount of free hard disk space, and the installed software on the computer. You then load physical inventory data and the physical information gathered by the discovery tool software into Asset Management. The physical inventory processing determines the assets that have been added, transferred, or retired. Using these results, you perform matching and generate transactions to reconcile the data in Asset Management with the results of the physical inventory.

Classic Physical Inventory Processing

These are the steps to process classic physical inventory:

1. (Optional) Extract physical inventory asset data from PeopleSoft Asset Management.

PeopleSoft Asset Management provides a physical inventory system that enables you to extract asset data from the PeopleSoft Asset Management database into a sequential file and then load it into a bar code scanning device. You can also extract data from third-party information technology (IT) asset discovery tools. Such discovery tools belong to a class of software that you can use instead of bar coding for laptops, computers, and other IT equipment. These discovery tools poll the assets over a network and update a central database.

2. (Optional) Use the extracted physical inventory data to generate a sequential file or Excel Comma Separated Value (CSV) file that a bar code scanner or inventory device can use, and enter the file into the scanner.

Steps 1 and 2 are necessary only if you want to display data from your PeopleSoft Asset Management database as you scan each asset. The displayed information can include asset IDs, tag numbers, serial numbers, manufacturers, models, descriptions, departments, locations, and so forth. This asset data can provide instant information about an asset's history.

3. After you scan assets, load the scanned data into PeopleSoft Asset Management and resolve any duplicate tag numbers and serial numbers.
4. After you match the physical inventory scan scope to the scanned data, generate physical inventory results for review.
5. Generate transactions based on the results.

You then load the transactions to reconcile the data in PeopleSoft Asset Management with the physical inventory results.

6. Delete the physical inventory transactions, physical inventory results, and physical inventory scanned asset data when you no longer need them.
7. (Optional) If you created an extract file, delete that file when you no longer need it.

Prerequisites

Before you can perform a physical inventory in PeopleSoft Asset Management, all assets must have tag numbers. They must also belong to a particular department or location, or you must have some other way to track their whereabouts.

Hardware and Software Requirements for Classic Physical Inventory

To use the full range of the classic physical inventory functionality, you need additional hardware and software beyond the standard PeopleSoft system setup. These requirements are listed here.

Hardware

Here are the additional hardware requirements for physical inventory processing:

<i>Term</i>	<i>Definition</i>
Portable bar code reader	A handheld unit that you can use to collect asset data.

Term	Definition
Bar code scanning wand	A device that you use to physically scan bar codes. The wand is usually purchased along with the bar code reader.
Thermal transfer label printer	A printer for printing labels. If you have a relatively large number of assets (more than 10,000), you should purchase a label printer.

Note: You can integrate the Physical Inventory feature of PeopleSoft Asset Management with virtually any bar coding hardware.

Software

If you plan to print your own labels, you can use a Windows-based label-printing software package.

To view PeopleSoft Asset Management data on a scanning device while you scan assets, you need to develop your own application for the scanner or use the program that PeopleSoft Asset Management provides. This application reads data from the extract file, displays the data to the operator, and records any data that the operator enters. PeopleSoft has developed a sample application to run on a DOS-based bar code scanner. The program is written in Microsoft QuickBasic, and you can configure it easily. This application (which comprises the files PI.BAS and PI.EXE) is packaged with PeopleSoft Asset Management and resides in the \PI directory.

You need to transfer files between the computer and the bar code scanner. To do this, you can use any communications application transfers information from a computer to a scanning device.

In addition to (or in lieu of) bar coding, you can use an auto-discovery tool from any that are available on the market.

Asset Management comes with a number of programs (in the \PI directory) for physical inventory processing on DOS-based scanners. This table lists these programs:

Program	Description
PI.BAS	This is the BASIC source code for the scanner application that you use to perform the physical inventory.
PI.EXE	This is the compiled version of PI.BAS that runs on the scanner. You need a BASIC compiler to generate an executable file if you change this code.

Program	Description
PISORT.BAS	This is a BASIC source code program that sorts the sequential extract file that Asset Management creates. This application creates two random access files—one that is sorted by tag number (EXT.TAG) and one that is sorted by serial number (EXT.SER). These files are read by PI.EXE when the user enters a tag or serial number.
PISORT.EXE	This is the compiled version of PISORT.BAS. It is called from the batch file EXTCOPY.BAT.
EXTCOPY.BAT	<p>This batch file is used to download extract files to the scanner. Edit this file so that it:</p> <ul style="list-style-type: none"> • Calls the communications software to connect to the scanner. • Calls PISORT to sort the extract file. • Deletes EXT.TAG and EXT.SER from the scanner. • Downloads new versions of EXT.TAG and EXT.SER. <p>You may need to edit EXTCOPY.BAT if you want to copy files to the appropriate drive on the scanner. This requirement may vary among different scanning devices.</p>
SCANCOPY.BAT	This batch file is used to upload the SCAN.DAT file from the scanner to \TEMP\SCAN.DAT. You can modify the program to copy the SCAN.DAT file from the appropriate drive on the scanner.

Configuring Physical Inventory

To configure Physical Inventory in PeopleSoft Asset Management, use the Physical Inventory Control component (PI_SYSTEM_SETUP) the Mass Transaction Definition component (PSDMT_UNITS), the Mass Transaction Configuration component (PSDMT_UNIT_DTL), and the Mass Transaction Criteria component (PSDMT_UDC). This section discusses how to configure a physical inventory.

Pages Used to Configure Physical Inventory

Page Name	Definition Name	Usage
“Interface Options Page” (Asset Lifecycle Management Fundamentals) (mobile physical inventory only)	BUS_UNIT_INTFC_OPT	Enable the mobile physical inventory feature and establish product and application interface default processing options for Payables, Purchasing, Billing, Lease Administration, and Maintenance Management.
<u>Physical Inventory Control Page</u>	PI_SYSTEM_SETUP	Review relationships between physical inventory fields and Transaction Type. Note: Unless you have altered the physical inventory system (for example, by adding fields), do not change information on this page.
<u>Scan Options Page</u>	PI_SCAN_OPTIONS	Define email notification defaults and configure field level authorization for the pages within the Asset Tracking homepage.
<u>Mass Transaction Definition - Mass Transactions List Page</u>	PSDMT_UNITS_01	View the delivered Mass Transaction templates used in extracting and scanning asset physical inventory data.
<u>Mass Transaction Definition – Transaction Definition Page</u>	PSDMT_UNITS_02	View, add to, or manage the delivered Mass Transaction Definitions used in performing asset physical inventory.
<u>Mass Transaction Configuration Page</u>	PSDMT_UNIT_DTL	Define criteria fields and edit type to be used in performing asset physical inventory.
<u>Mass Transaction Criteria Page</u>	PSDMT_UDC	Enable the fields that are to be used for specifying selection criteria for the physical inventory process.

Physical Inventory Control Page

Use the Physical Inventory Control page (PI_SYSTEM_SETUP) to review relationships between physical inventory fields and Transaction Type.

Navigation:

Set Up Financials/Supply Chain > Product Related > Asset Management > Physical Inventory > AM Physical Inventory Control > Physical Inventory Control

This example illustrates the fields and controls on the Physical Inventory Control page. You can find definitions for the fields and controls later on this page.

Physical Inventory Control				
Physical Inventory System Setup ?				
Personalize Find [?] [] First 1-18 of 18 Last				
	Scan Fieldname	Basis Record	Target Record	*Transaction Type
1	<input type="text"/>	<input type="text"/>	<input type="text"/>	Asset Non-Financial Add
2	<input type="text"/>	<input type="text"/>	<input type="text"/>	Inventory History Insert
3	<input type="text"/>	<input type="text"/>	<input type="text"/>	Operating Lease Retire
4	<input type="text"/>	<input type="text"/>	<input type="text"/>	Non Capital Retirement
5	<input type="text"/>	<input type="text"/>	<input type="text"/>	Asset Retirement
6	AREA_ID	ASSET_LOC_VW	PI_RES_AREA_ID	Physical Change
7	COMMENTS	ASSET_COMMENTS	PI_RES_COMMENT	Physical Change
8	CUSTODIAN	ASSET_CUST_VW	PI_RES_CUSTOD	Physical Change
9	DEPTID	COST_BAL_VW	PI_RES_DEPTID	Asset Transfer
10	DEPTID	LEASE_OPER	PI_RES_DEPTID	Operating Lease Transfer
11	DEPTID	NON_CAP_VW	PI_RES_DEPTID	Non Capital Transfer
12	DESCR	ASSET	PI_RES_DESCR	Asset Update
13	EMPLID	ASSET_CUST_VW	PI_RES_EMPLID	Physical Change
14	LOCATION	ASSET_LOC_VW	PI_RES_LOCATION	Physical Change
15	MANUFACTURER	ASSET	PI_RES_MANUF	Asset Update

NOTE: Leave Scan Fieldname, Basis Record & Target Record blank for ADD and RET trans types; required otherwise!

When you generate the physical inventory results, the Structured Query Report (SQR) AMPI1000 uses data from this page to compare asset field values and determines the types of transactions that need to be generated. After the physical inventory is reconciled, the Transaction Loader process (AMIF1000), will then load transactions into PeopleSoft Asset Management.

Note: The information on this page is prepopulated to work with the delivered physical inventory programs. Modify this page only if you have made alterations to the physical inventory system—for example, by creating new fields.

Mass Transaction Definition - Mass Transactions List Page

For classic physical inventory, use the Mass Transaction Definition – Mass Transactions List page (PSDMT_UNITS_01) to view the delivered Mass Transaction templates used in extracting and scanning asset physical inventory data.

For mobile physical inventory, use the Mass Transaction Definition – Mass Transactions List page (PSDMT_UNITS_01) to view the delivered Mass Transaction templates used in scanning asset physical inventory data.

Navigation:

Set Up Financials/Supply Chain > Product Related > Asset Management > Mass Transaction Manager > AM Mass Transaction Definition Mass Transactions List

This example illustrates the fields and controls on the Mass Transactions List page. You can find definitions for the fields and controls later on this page.

Transaction	Description	Active Status	Public	View Description
1 PI Extract	PI Extract	Active	<input type="checkbox"/>	
2 PI NCP Extract	PI NCP Extract	Active	<input type="checkbox"/>	
3 PI NCP Scan Scope	PI NCP Scan Scope	Active	<input type="checkbox"/>	
4 PI OPL Extract	PI OPL Extract	Active	<input type="checkbox"/>	
5 PI OPL Scan Scope	PI OPL Scan Scope	Active	<input type="checkbox"/>	
6 PI Scan Scope	PI Scan Scope	Active	<input type="checkbox"/>	

PeopleSoft delivers the following Mass Transactions that can be used in performing asset physical inventory:

- PI Extract – Physical Inventory extract scope for capital assets (*classic physical inventory only*)
- PI NCP Extract – Physical Inventory extract scope for non capital assets (*classic physical inventory only*)
- PI OPL Extract – Physical Inventory extract scope for operating leases (*classic physical inventory only*)
- PI Scan Scope – Physical Inventory scan scope for capital assets
- PI NCP Scan Scope – Physical Inventory scan scope for non capital assets
- PI OPL Scan Scope – Physical Inventory scan scope for operating leases

For the extract templates, the Mass Transaction Definition is used to extract asset data from multiple Asset Management tables into one physical inventory extract table. This extract data may be reviewed before downloading to a bar code scanner file.

Note: It is not advisable to change these delivered transaction definitions.

Mass Transaction Definition – Transaction Definition Page

Use the Mass Transaction Definition – Transaction Definition page (PSDMT_UNITS_02) to view, add to, or manage the delivered Mass Transaction Definitions used in performing asset physical inventory.

Navigation:

Set Up Financials/Supply Chain > Product Related > Asset Management > Mass Transaction Definition > Transaction Definition

This example illustrates the fields and controls on the Mass Transaction Definition - Transaction Definition page. You can find definitions for the fields and controls later on this page.

The screenshot displays the 'Mass Transaction Definition - Transaction Definition' page. It features a 'Mass Transaction' header with 'Transaction PI Scan Scope' and a 'Statement' section with 'Sequence' (100) and 'Description' (PI Capital Assets Scan Scope). Below are 'Source Records' and 'User Entered Values' sections.

Source Record	Record Alias
1 PI_CNTL	PI_CNTL
2 PI_EXTRACT_VW	PI_EXTRACT_VW
3 RUN_CNTL_AM	RUN_CNTL_AM

Field Name	Label ID	Edit Type	Prompt Table
1			

This page defines the source (selection) records, associated record alias, and any user entered values to be accessed in physical inventory processing. You should not change these values for the delivered definitions unless you have added records and views that are to be used in physical inventory processing.

Field or Control	Description
Sequence	The sequence number Indicates the order in which the SQL statements will run.
Description	Describes the mass transaction definition.

User Entered Values

You can add record fields to the template for selection criteria to limit the extract or scan data.

Mass Transaction Configuration Page

Use the Mass Transaction Configuration page (PSDMT_UNIT_DTL) to define criteria fields and edit type to be used in performing asset physical inventory.

Navigation:

Set Up Financials/Supply Chain > Product Related > Asset Management > Mass Transaction Manager > AM Mass Transaction Config

This example illustrates the fields and controls on the Mass Transaction Configuration page. You can find definitions for the fields and controls later on this page.

The screenshot displays the 'Mass Transaction Configuration' page for 'Transaction PI Extract'. It is divided into two main sections: 'Filter Fields' and 'Filter Fields by Statement'.

Filter Fields Section:

Field Number	Record (Table) Name	Field Name	Label ID	Edit Type	Prompt Table
1	PI_EXTRACT_VW	BUSINESS_UNIT	Business Unit	Prompt Table	BUS_UNIT_TBL_AI
2	PI_EXTRACT_VW	ASSET_CLASS	Asset Class	Prompt Table	ASSET_CLASS_TBL
3	PI_EXTRACT_VW	ASSET_TYPE	Asset Type	Translate Table	
4	PI_EXTRACT_VW	ASSET_SUBTYPE	Asset Subtype	Prompt Table	MTM_AMSUBTYPEPV
5	PI_EXTRACT_VW	CATEGORY	Asset Category	Prompt Table	CATEGORY_TBL
6	PI_EXTRACT_VW	COST	Total Cost	No Table Edit	
7	PI_EXTRACT_VW	DEPTID	Department	Prompt Table	DEPT_TBL

Filter Fields by Statement Section:

Sequence 100
Description PI Capital Assets Extract

Sequence Definition	Record (Table) Name	Record Alias	Field Name
1	PI_EXTRACT_VW	PI_EXTRACT_VW	ASSET_CLASS
2	PI_EXTRACT_VW	PI_EXTRACT_VW	ASSET_SUBTYPE
3	PI_EXTRACT_VW	PI_EXTRACT_VW	ASSET_TYPE
4	PI_EXTRACT_VW	PI_EXTRACT_VW	BUSINESS_UNIT
5	PI_EXTRACT_VW	PI_EXTRACT_VW	CATEGORY
6	PI_EXTRACT_VW	PI_EXTRACT_VW	COST
7	PI_EXTRACT_VW	PI_EXTRACT_VW	DEPTID

Field List

Define/List fields that can be used as the selection criteria. It also defines the Edit Type and Prompt Table, if any, for each field being selected.

Field Control

Define the Business Unit/SetID and the Prompt Table relationship, if any, for each field.

Filter Fields by Statement

Define the Record and Field relationship and the record alias being used in the SQR AMPI1000.



Mass Transaction Criteria Page

Use the Mass Transaction Criteria page (PSDMT_UDC) to enable the fields that are to be used for specifying selection criteria for the physical inventory process.

Navigation:

Set Up Financials/Supply Chain > Product Related > Asset Management > Mass Transaction Manager > AM Mass Transaction Criteria

This example illustrates the fields and controls on the Mass Transaction Criteria page. You can find definitions for the fields and controls later on this page.

Mass Transaction Criteria	
Transaction PI Extract	
Selection Criteria	Personalize Find  First  1-9 of 9  Last
Field Label ID	Select Switch
1 Business Unit	<input checked="" type="checkbox"/>
2 Asset Class	<input checked="" type="checkbox"/>
3 Asset Type	<input checked="" type="checkbox"/>
4 Asset Subtype	<input checked="" type="checkbox"/>
5 Asset Category	<input checked="" type="checkbox"/>
6 Total Cost	<input checked="" type="checkbox"/>
7 Department	<input checked="" type="checkbox"/>
8 Location Code	<input checked="" type="checkbox"/>
9 Asset Profile ID	<input checked="" type="checkbox"/>

Select the fields to appear on the Inventory Occurrence - Enter Criteria page. They are to be used for defining the selection criteria for the physical inventory extract and scan scopes.

See [Define Inventory Occurrence – Enter Criteria Page](#)

Defining the Extract Scope, the Scan Scope, and the Physical Inventory Parameters

To define the extract and scanning scope, and set up the inventory controls for a physical inventory, use the Physical Inventory component. This topic provides an overview of defining the extract scope, the scan scope, and the physical inventory controls.

Pages Used to Define Extract Scopes, Scan Scopes, and Physical Inventory Parameters

<i>Page Name</i>	<i>Definition Name</i>	<i>Usage</i>
<u>Define Inventory Occurrence - Definition Page</u>	PI_CNTL_01	For classic physical inventory, establish a physical inventory ID and define the extract scope and scan scope within Asset Management for each physical inventory that you perform. For mobile physical inventory, establish a physical inventory ID and define the scan scope within Asset Management for each physical inventory that you perform.
<u>Define Inventory Occurrence – Enter Criteria Page</u>	PI_CNTL_CRITERIA	For classic physical inventory, define the selection criteria for each selected set of extract and scan scopes by capital, non capital, and operating lease. For mobile physical inventory, define the selection criteria for each selected set of scan scopes by capital, non capital, and operating lease.
<u>Define Inventory Occurrence - Transaction Defaults Page</u>	PI_CNTL_02	Specify the defaults for any transactions and asset retirements that are generated from the physical inventory.
<u>Create Schedules Page</u>	PI_SCHEDULE_01	Set up physical inventory schedule information. If several people perform physical inventories simultaneously at different locations, you may need to track the status of each inventory.

Understanding Extract Scopes and Scan Scopes for Classic Physical Inventory

Physical inventory matching and reconciliations are based on two separate sets of asset data that you define—the extract scope and the scan scope. Each of these sets is based on location, department, or both. The first set is the data that you originally extract from PeopleSoft Asset Management and load into a scanning device. The extract scope includes all possible locations and departments for the assets to be inventoried. This enables the bar code scanner to find PeopleSoft Asset Management data for most of the assets that it scans. Define separate scopes for capital assets, non capital assets and operating leases.

If you have not performed physical inventory in several years, define a broad extract scope. Because many assets may have been redistributed in the interim, the extract scope might even include the entire business unit.

Note: If you are using an IT asset discovery tool only, you do not need to define an extract scope.

The scan scope defines the scope of the actual physical inventory—that is, where the inventory actually occurs. For example, suppose that you plan to take inventory on the second floor of a five-floor building. Because the assets may have been redistributed since the last inventory, the extract scope might include assets on all five floors. However, the scan scope would include only assets on the second floor.

The system compares the scan scope with the actual scanned data when PeopleSoft Asset Management generates physical inventory results. Any assets that appear in the scan scope but not in the scanned data are called *unders*, and they create *retirements* when you generate transactions. Any assets that appear in the scanned data but not in the scan scope are *overs*, and they create *physical adds* when you generate transactions. Other differences between the scan scope and the scanned data create transfers and changes in the assets' nonfinancial information. These assets are assigned the status *Inventoried*.

Identifying Scanned Assets to Retire

The PeopleSoft physical inventory process automatically retires assets missing from the physical inventory-scanned data matching step and defined in scan scope. However, you can also identify assets to retire in the physical inventory scanned data, allowing *negative inventory*.

You can identify assets to retire by:

- Using the CSV export file to set the MATCH_STATUS to 'R' when you upload the Scan File.

Physical Inventory CSV Export File with MATCH_STATUS set for retirement.

	A	B	C	D	E	F	G	H	I	J	K	L
1	TAG_NUM	SERIAL_ID	ASSET_ID	DEPTID	MODEL	LOCATION	AREA_ID	DESCR	CUSTODIA	EMPLID	MANUFAC	MATCH_STATUS
2			EIP101	12000		US001	LOT A	Automobi		EIP,101		I
3			EIP201	12000		US001	LOT A	Automobi		EIP,201		R

- Using your own scanning program to input assets for retirement directly into the PS_SCAN table.

The PI_SCAN process uses the MATCH_STATUS value to identify retired assets and will reflect the status in the Verify Scanned Data (PI_SCAN_01), Verify Duplicate Tags (PI_SCAN_01), Verify Duplicate Serial ID (PI_SCAN_01), and Results (PI_RESULTS) pages.

Understanding Scan Scopes for Mobile Physical Inventory

The scan scope defines the scope of the actual physical inventory—that is, where the inventory actually occurs. For example, suppose that you plan to take inventory on the second floor of a five-floor building.

The system compares the scan scope with the actual scanned data when PeopleSoft Asset Management generates physical inventory results. Any assets that appear in the scan scope but not in the scanned data are called *unders*, and they create *retirements* when you generate transactions. Any assets that appear in the scanned data but not in the scan scope are *overs*, and they create *physical adds* when you generate transactions. Other differences between the scan scope and the scanned data create transfers and changes in the assets' information. These assets are assigned the status *Inventoried*.

Define Inventory Occurrence - Definition Page

For classic physical inventory, use the Define Inventory Occurrence - Definition page (PI_CNTL_01) to establish a physical inventory ID and define the extract scope and scan scope within Asset Management for each physical inventory that you perform.

For mobile physical inventory, use the Define Inventory Occurrence - Definition page (PI_CNTL_01) to establish a physical inventory ID and define the scan scope within Asset Management for each physical inventory that you perform.

Navigation:

Asset Management > Physical Inventory > Define Inventory Occurrence > Definition

This example illustrates the fields and controls on the Define Inventory Occurrence - Definition page. You can find definitions for the fields and controls later on this page.

For classic physical inventory, the extract scope should include all assets that *might* be scanned during the inventory for the given Physical Inventory ID. The scan scope should include the area of the actual scan.

Note: You must define a scan scope. An extract scope is necessary only if you want the scanning device to display asset data from the PeopleSoft Asset Management database as you scan each asset.

Before you scan assets, you must establish a physical inventory control ID for each physical inventory that you perform. Specify the Physical Inventory ID and PI Name.

Each physical inventory occurrence must have a unique Physical Inventory ID. If you are running both the classic physical inventory process and mobile physical inventory process, you must create separate Physical Inventory IDs for each process. Physical inventory IDs cannot contain spaces. Use an underscore instead of a space in a physical inventory ID.

Field or Control	Description
Business Unit	Enter the business unit for which you want to conduct an inventory. If you are using an IT asset discovery tool, you can process all business units by leaving the Unit field blank, or you can process a single business unit by making a business unit selection.

Field or Control	Description
Book Name	Enter a Book Name to process assets for physical inventory that were added to a book other than the one that is designated as the current default book value on the AM Business Unit Definition page. If you leave the Book Name blank, the system uses the current default book value from the AM Business Unit Definition page. In this way, if you change your designated default book value on the AM Business Unit Definition page, you can create a separate Physical Inventory ID to process those assets in physical inventory that were added with the old default book value.
Start Date and End Date	Enter date range for the physical inventory. The asset acquisition date is validated against these inventory control dates.
Last Step	This page indicates the last step that you performed in the current physical inventory. Refer to this page to ensure that you perform all steps in the proper sequence.
Enable Mobile Inventory	Indicates whether the mobile physical inventory feature is enabled. If the option is selected, the feature was enabled for the business unit on the Asset Management Definition - Interface Options page. Additionally, you are able to deselect the option if you wish to do so. However, if the feature was not enabled for the business unit on the Asset Management Definition - Interface Options page, you cannot select the option here.

Extract Assets (Classic Physical Inventory Only)

Select to extract capitalized, non capitalized, and operating lease assets data. You can select one or all types of assets for extract. A corresponding Enter Criteria link appears for the asset types that you select.

Note: This group box does not display if you have enabled the mobile physical inventory feature.

Field or Control	Description
Enter Criteria	Click this link to access the Enter Criteria page for the selected type of assets and specify selection criteria for the system to use in defining the extract for the selected group. See Define Inventory Occurrence – Enter Criteria Page .

Scan Scope

Select to scan capitalized, non capitalized, and operating lease assets. You can select one or all types of assets for scanning. A corresponding Enter Criteria link appears for the asset types that you select.

Field or Control	Description
Enter Criteria	Click this link to access the Enter Criteria page for the selected type of assets and specify selection criteria for the system to use in defining the scope of the physical inventory – that is, the set of assets to be scanned. See Define Inventory Occurrence – Enter Criteria Page .

Define Inventory Occurrence – Enter Criteria Page

For classic physical inventory, use the Define Inventory Occurrence – Enter Criteria page (PI_CNTL_CRITERIA) to define the selection criteria for each selected set of extract and scan scopes by capital, non capital, and operating lease.

For mobile physical inventory, use the Define Inventory Occurrence – Enter Criteria page (PI_CNTL_CRITERIA) to define the selection criteria for each selected set of scan scopes by capital, non capital, and operating lease.

Navigation:

Asset Management > Physical Inventory > Define Inventory Occurrence > Enter Criteria

This example illustrates the fields and controls on the Define Inventory Occurrence - Enter Criteria page. You can find definitions for the fields and controls later on this page.

Physical Inventory

This section identifies the physical inventory subset for which you are defining selection criteria for a given Physical Inventory ID. You can scroll through the subsets using the arrows at the far top right corner of the grid, or you can access the specific subset by clicking the Enter Criteria link from the Definition page. The possible criteria subsets are:

- Capital Assets – (Extract scope for capital assets, classic physical inventory only)
- Non Capital Assets – (Extract scope for non capital assets, classic physical inventory only)
- Operating Lease – (Extract scope for operating leases, classic physical inventory only)

- Scan Scope capital assets
- Scan Scope Non Capital Assets
- Scan Scope operating lease

If you have not selected the check box for a given subset from the Definition page, it will not appear on the Enter Criteria page.

Selection Criteria

Use this section to define the selection criteria for each subset of assets that you have selected for the physical inventory scope (from the Definition page). Limit your extract scope and scan scope data by specifying explicit values for a field or fields, or use the arithmetic operators to limit by value ranges.

You can configure the fields that appear in this section from the Mass Transaction Criteria page.

See [Mass Transaction Criteria Page](#).

Define Inventory Occurrence - Transaction Defaults Page

Use the Physical Inventory Occurrence - Transaction Defaults page (PI_CNTL_02) to specify the defaults for any transactions and asset retirements that are generated from the physical inventory.

Navigation:

Asset Management > Physical Inventory > Define Inventory Occurrence > Transaction Defaults

This example illustrates the fields and controls on the Define Inventory Occurrence - Transaction Defaults page. You can find definitions for the fields and controls later on this page.

Auto Approval

<i>Field or Control</i>	<i>Description</i>
Approve	Select this check box to have the system automatically approve the transactions that are generated from the inventory. PeopleSoft strongly recommends that you review and approve all transactions that are generated during the physical inventory process before you load them into PeopleSoft Asset Management.

Transactions Enabled

Use the check boxes in this group box to select the types of transactions that you want to generate. For instance, you may not want the results of the physical inventory to generate any financial transactions. In such cases, you would deselect all of the **Transfers** and **Retirements** check boxes. Select from the following types of transactions:

<i>Field or Control</i>	<i>Description</i>
Non-Financial Adds	Select that the results of the physical inventory generate nonfinancial additions.
Operating Lease Retirement	Select that the results of the physical inventory generate nonfinancial retirements. This triggers the mass transaction associated with this transaction type as a result of nonfinancial unders.
Retirements	Select that the results of the physical inventory generate unders.
Non Capital Retirements	Select that the results of the physical inventory generate non capital retirements. This triggers the mass transaction associated with this transaction type as a result of non capital unders.
Transfers	Select that the results of the physical inventory generate transfers.
Operating Lease Transfer	Select that the results of the physical inventory generate operating lease transfers. This triggers the mass change associated with this transaction type when a discrepancy occurs between the stored and the scanned department records.

Field or Control	Description
Physical Asset Changes	Select that the results of the physical inventory generate physical asset changes. This includes changes in the custodian department.
Asset Updates	Select that the results of the physical inventory generate any asset updates.
Non-Capital Transfer	Select that the results of the physical inventory generate non capital transfers. This triggers the mass change associated with this transaction type when a discrepancy occurs between the stored and the scanned department records.

Transaction Defaults

Field or Control	Description
Transaction Date, Accounting Date, and Transaction Code	The current date will display by default in the Transaction Date and Accounting Date fields. You may override these and enter a transaction code as needed.
User ID	Enter the user ID of the person who performs the physical inventory.
Interface ID and Open Transaction ID	By default, the system populates the Interface ID and Open Transaction ID fields with the next available values. When you process the generated transactions using the Transaction Loader, (AMIF1000) refer to the interface ID on this page. You can use the open transaction ID to locate depreciation open transactions that are created as a result of the physical inventory.
Transfer Convention	Select a value to indicate how to prorate the depreciation for Physical Inventory transfer transactions; for example, prorate according to 'Life to Date,' 'Following Month,' and so forth. This field provides more control over how you calculate depreciation for the transfer transaction.

Retirement Defaults

<i>Field or Control</i>	<i>Description</i>
Disposal Code	Select the method for retiring assets.
Retirement Convention	Select to indicate how you want to prorate retired assets.
Retire Option	Select one of the following retirement options: <ul style="list-style-type: none"> • <i>Calculate Gain/Loss</i> • <i>Fully Depr no Future Expense</i> • <i>Fully Depr with Future Expense</i>
Voluntary Conversion	Select to identify whether the retirement takes place for intended or unintended reasons. Options are Voluntary and Involuntary for the retirement default.
Type	Select Ordinary or Extraordinary to define the types of retirements that you generate.

Create Schedules Page

Use the Create Schedules page (PI_SCHEDULE_01) to set up physical inventory schedule information.

If several people perform physical inventories simultaneously at different locations, you may need to track the status of each inventory.

Navigation:

Asset Management > Physical Inventory > Create Inventory Schedules > Create Schedules

This example illustrates the fields and controls on the Create Schedules page. You can find definitions for the fields and controls later on this page.

Create Schedules

*Schedule ID Description

Schedule Details Find | View All First 1 of 1 Last

*Start Date	End Date	*PI ID	PI Name	PI Leader
<input type="text" value="08/08/2000"/>	<input type="text" value="10/31/2000"/>	<input type="text" value="PI2000"/>	2000 Inventory	<input type="text" value="Engles, Anita"/>

Field or Control	Description
Schedule ID	Set up one Schedule ID or as many unique IDs as you like. For instance, if you have several branches, you might want a separate schedule for each branch. Enter an informative description for each Schedule ID.
Start Date and End Date	You can leave the end date field blank until the inventory has actually been completed.
PI ID (physical inventory ID) and PI Leader (physical inventory leader)	Select the physical inventory ID for the schedule dates. You may also assign a physical inventory leader.

Note: Scheduling information is not used in any physical inventory processing. It is informational only.

Processing a Physical Inventory

This topic discusses how to process Physical inventory.

Pages Used to Process Physical Inventory

Page Name	Definition Name	Usage
<u>Load/Match/Reconcile PI Info Page</u> (Mobile Physical Inventory) <u>Load/Match/Reconcile PI Info Page</u> (Classic Physical Inventory)	RUN_AMPI1000	Execute each step of the classic and mobile physical inventory process.
<u>Physical Inventory Page</u> (Mobile Physical Inventory only)	PI_SCAN_PHY_FL	Perform mobile physical inventory, scan assets, retrieve and display asset information from the Asset Repository, and automatically populate the Physical Inventory and Scan History tables with scan records—all from your mobile scanning device.
<u>Edit Scan Record Page</u> (Mobile Physical Inventory only)	PI_SCAN_EDIT_SCF	Modify scanned asset information.
<u>New Asset Scan Record Page</u> (Mobile Physical Inventory only)	PI_SCAN_NEW_SCF	Manually add a new scanned asset to the Physical Inventory interface table.
<u>Find Asset Page</u> (Mobile Physical Inventory only)	PI_SCAN_FIND_FL	Manually create a scan record for an asset without scanning a barcode.

Page Name	Definition Name	Usage
Notify (Email Notification) Page (Mobile Physical Inventory only)	PI_SCAN_EMAIL_SCF	Send email notification regarding an asset.
<u>Review Extracted Data Page (Classic Physical Inventory Only)</u>	PI_EXTRACT_01	(Optional) View the results of the extract data one asset at a time. You can also search by PI line number, asset ID, department, tag number, serial ID, and location. The PI line number reflects the number of this asset in the extract sequence. For instance, the third asset that was extracted falls on PI Line Number 3. The system presents you with all the assets that match your criteria. Select the one you want to view. You can run the report AMPI2000 to list all the information that has been extracted. Run this from the Physical Inventory Reports page.
<u>Verify Scanned Data Page</u>	PI_SCAN_01 PI_SCAN (component)	Verify scanned data for the Physical Inventory ID.
<u>Verify Duplicate Tags Page</u>	PI_SCAN_01 PI_SCAN_DUP_TAG is the component	Conduct searches for finding and correcting physical inventory data.
<u>Verify Duplicate Serial ID Page</u>	PI_SCAN_01 PI_SCAN_DUP is the component	Conduct searches for finding and correcting physical inventory data.
<u>Results Page</u>	PI_RESULTS_01	View the results of the matching process.
Review Matching Results - Details	PI_RESULTS_02	View the original and scanned data. You can run reports that list inventoried assets (AMPI2200), unders (AMPI2210), and overs (AMPI2220).

Understanding Mobile Physical Inventory Processing

You will use the **Physical Inventory** tile to perform mobile physical inventory, scan assets, retrieve and display asset information from the Asset Repository, and automatically populate the Physical Inventory (PI_SCAN) interface and Scan History (PI_SCAN_HIST) tables with scan records—all from your mobile scanning device. The Physical Inventory tile is part of the PeopleSoft Fluid User Interface and can be accessed from your mobile scanning device (with web browsing capability).

Physical Inventory tile and the Asset Tracking homepage

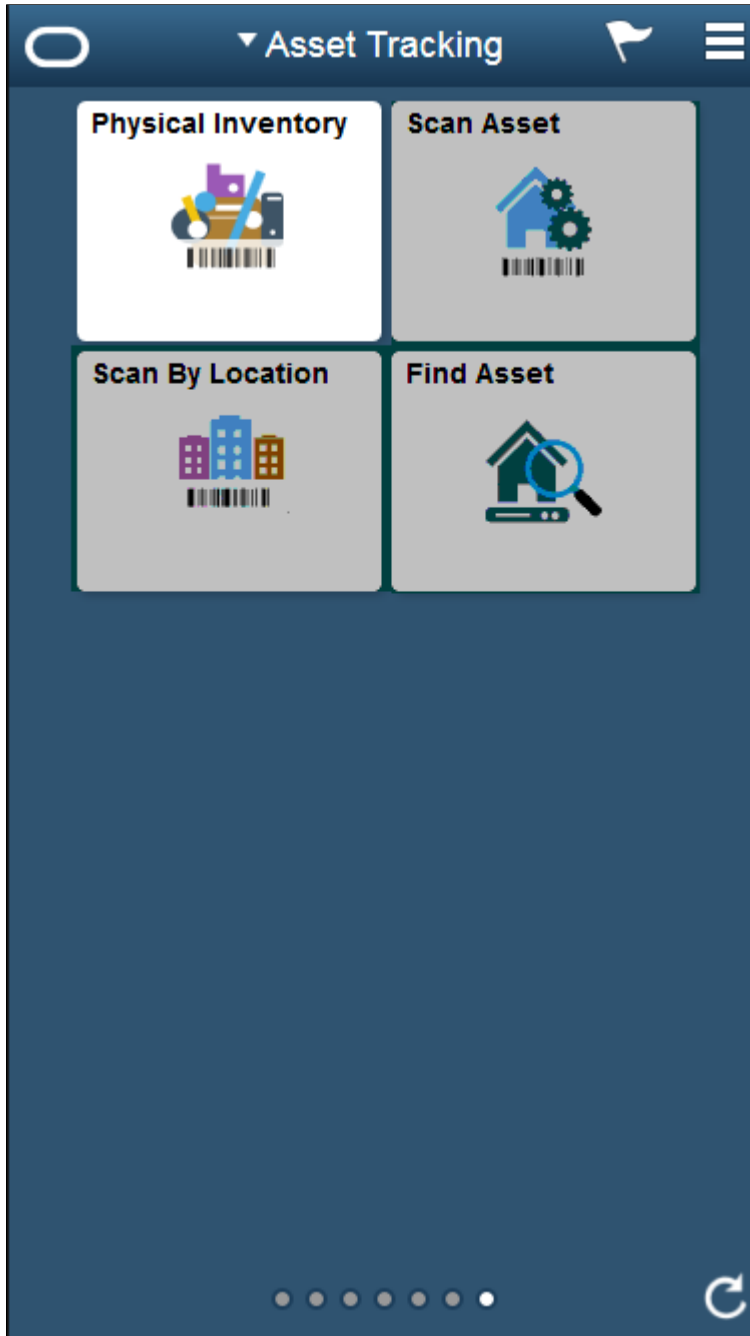

You will use the Physical Inventory tile *after* running the Generate Scan Scope process and *before* you generate results and transactions. During the scanning process an individual uses the Physical Inventory tile along with a scanning device to scan a barcode; asset information is automatically retrieved from the Asset Repository and presented to the scanning device. Scanned assets appear in list form on the left side of the page. This process also populates the Physical Inventory and Scan History tables with scan records.

Understanding Classic Physical Inventory Processing

After you configure your physical inventory process and define the extract scopes and scan scopes for your physical inventory IDs, as well as the physical inventory schedule, you can extract data from

PeopleSoft Asset Management tables. When the extract is complete, you can use the extract data in subsequent steps of the physical inventory process.

In order to process physical inventory, you must execute each step in its proper order. The Load/Match/Reconcile PI Info page includes each step in the proper order and prominently displays the step that was last processed for a given physical inventory ID

Note: Because steps 2 and 3 of Load/Match/Reconcile PI require writing and reading files, you should run the AM_PIJOB, which consists of the AMPI1000 SQR program and AM_PIWS_RUN Application Engine program that are executed in parallel for these steps from the file location. For example, if you are writing and reading files from `c:\temp\file.txt` or `c:\temp\scan.dat`, you would run the process on the client. If you are writing and reading files from a directory on the PeopleSoft Internet Architecture server, run the process on that server.

Load/Match/Reconcile PI Info Page (Mobile Physical Inventory)

Use the Load/Match/Reconcile PI Info page (RUN_AMPI1000) to execute each step of the Physical Inventory process. It is recommended that you add a new run control ID for each physical inventory ID (PI ID). Also use this run control ID for subsequent steps within the same PI ID.

Navigation:

Asset Management > Physical Inventory > Load/Match/Reconcile PI Info > Load/Match/Reconcile PI Info

Load/Match/Reconcile PI Info page

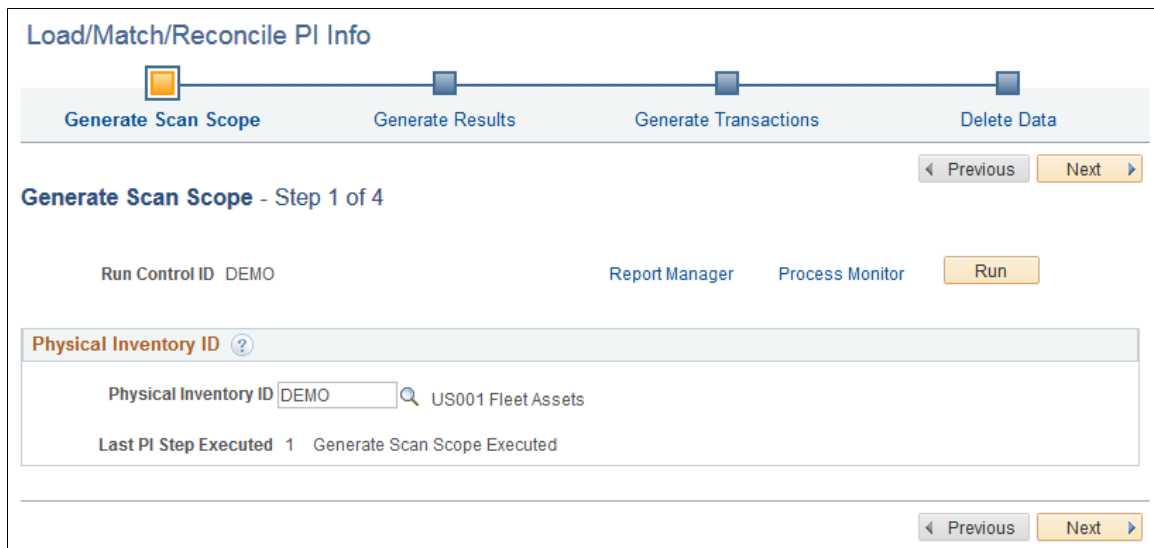

You can navigate either by clicking on the corresponding Step buttons or by clicking the Next and Previous buttons.

Run the various steps in sequential order from this run control page for a specific PI ID (**Physical Inventory ID**) and click the **Run** button.

Last PI Step Executed displays the step number and step description of the last step that was processed in the physical inventory process.

Generate Scan Scope (Step 1)

After defining scan scope parameters you can run step 1 of the Load/Match/Reconcile PI process.

Load/Match/Reconcile PI Info - Generate Scan Scope page

Load/Match/Reconcile PI Info

Generate Scan Scope Generate Results Generate Transactions Delete Data

Generate Scan Scope - Step 1 of 4

Run Control ID DEMO Report Manager Process Monitor Run

Physical Inventory ID ?

Physical Inventory ID DEMO US001 Fleet Assets

Last PI Step Executed 1 Generate Scan Scope Executed

Click the **Run** button to run the Generate Scan Scope process. This process automatically defines a set of assets that should be scanned and provides that list to the Physical Inventory page, which is accessible from your mobile scanning device.

Generate Results (Step 2)

After scanning barcodes in combination with the Physical Inventory tile (which inserts scanned records into the PI_SCAN table), review the scanned data before running step 2 (generate results).

Step 2 performs matching between a physical inventory scan scope and scanned data, and creates physical inventory results for review.

Load/Match/Reconcile PI Info - Generate Results page

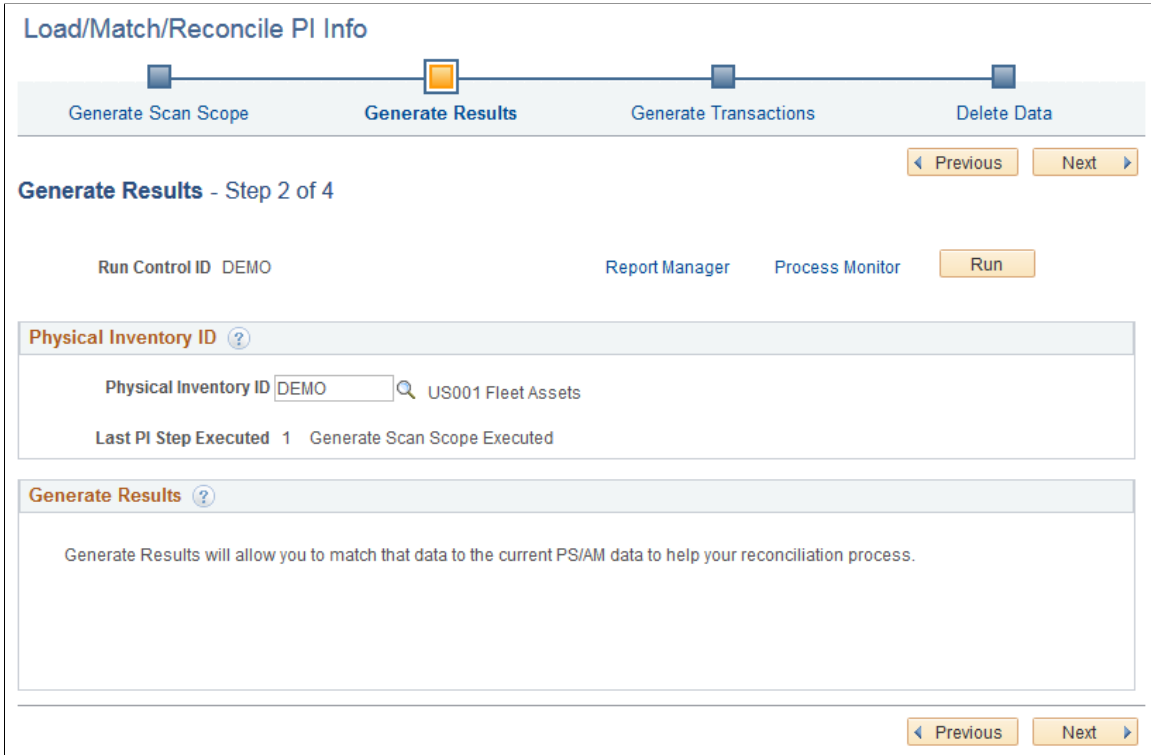

Remember before you generate results, you should use the Verify Duplicate Tags page and Verify Duplicate Serial ID page to clean up any possible errors in the scanned data.

Generate Results Select the Generate Results option and click the Run button to initiate processing. Note that this step may take some time to complete due to the amount of information that must be processed.

Because this step involves some complex processing, you may want to have your database administrator optimize the database before you execute the step.

Generate Transactions (Step 3)

After matching is performed, you create physical inventory transactions that reconcile the data in Asset Management with the results of the physical inventory.

Load/Match/Reconcile PI Info - Generate Transactions page

Select the Generate Transactions step and click the **Run** button to begin generating the transactions.

Because this step involves some complex processing, you may want to have the database administrator optimize the database before you run it.

This step takes the longest time to process, so be sure that you are satisfied with the generated results before you load the transactions. You can see the results of the matching process by reviewing the Results page and the Results Detail page.

See [Results Page](#)

After you have created, reviewed, and approved the reconciliation transactions, you load them by using the Interface Asset Information component and the Transaction Loader.

Delete Data (Step 4)

When you no longer need your physical inventory data, select one of the following options and click the Run button.

Load/Match/Reconcile PI Info - Delete Data page

Field or Control	Description
Delete All	Select to delete all physical inventory data generated for the specified Physical Inventory ID: (Scan Data, Result Data, and Transaction Data).
Delete Scan Data	Select to delete the physical inventory scan data.
Delete Result Data	Select to delete the physical inventory results data.
Delete Transaction Data	Select to delete the physical inventory transaction data.

Upon successfully completing all the steps, the system will advance the navigator to the next step. The user can click the **Run** button to submit the process.

Note: You may want to archive records from the Scan History (PI_SCAN_HIST) table when the scan history data is no longer needed (at the conclusion of a physical inventory cycle, for example). Use PeopleTools Data Archive Manager to remove records from the Scan History table. If you choose to use Data Archive Manager, you will have to create the archive and history table for the Scan History table.

See ‘Understanding PeopleSoft Data Archive Manager’ and ‘Understanding Archiving Strategy’ in the *PeopleTools Data Management documentation*.

Physical Inventory Page

Use the Physical Inventory (PI_SCAN_PHY_FL) page to perform mobile physical inventory, scan assets, retrieve and display asset information from the Asset Repository, and automatically populate the Physical Inventory (PI_SCAN) and Scan History (PI_SCAN_HIST) tables with scan records.

Navigation:

Fluid Home > Asset Tracking > Select the Physical Inventory tile

This example illustrates the fields and controls on the Physical Inventory page - Scan Scope. You can find definitions for the fields and controls later on this page.

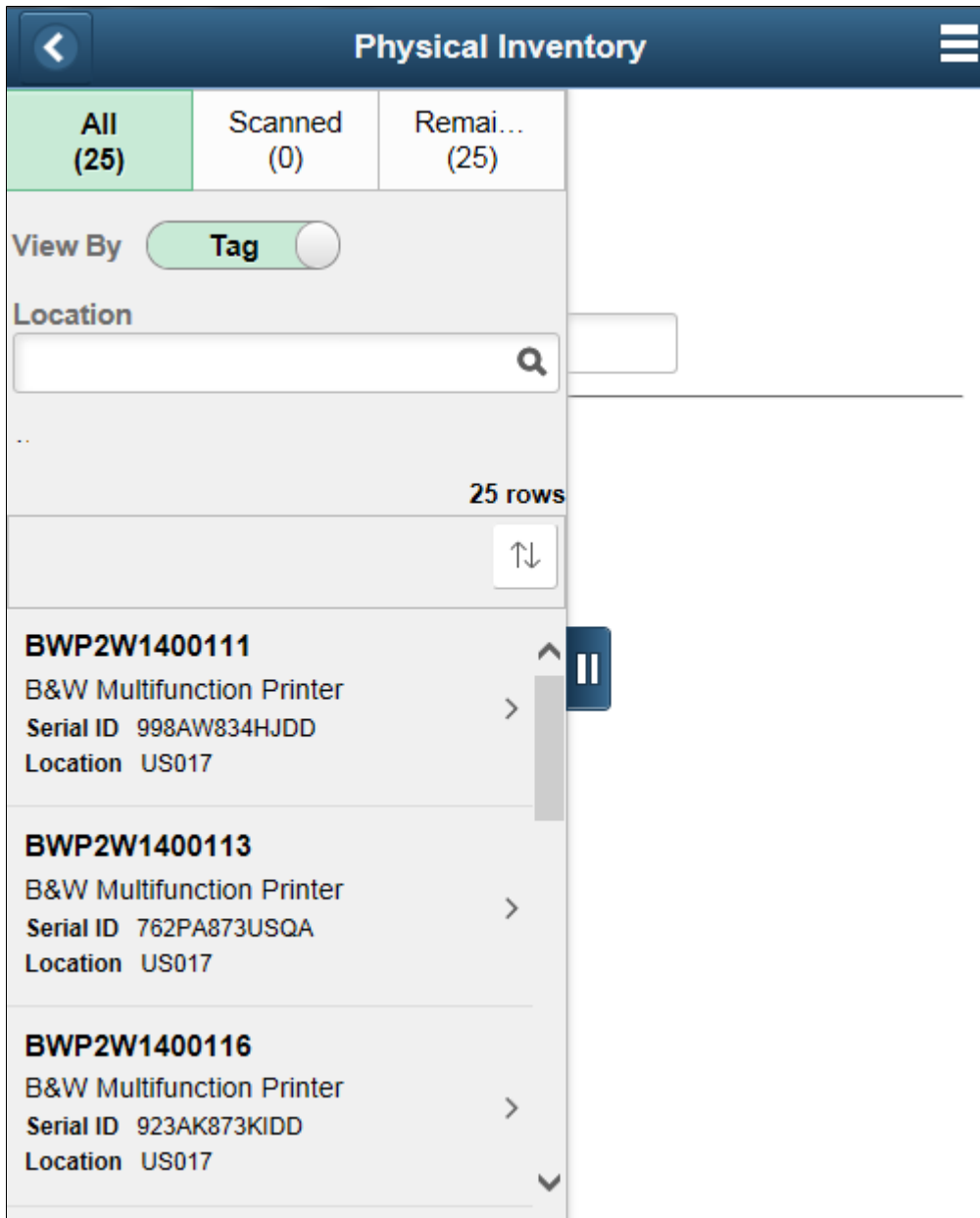

This example illustrates the fields and controls on the Physical Inventory page - detail.

The screenshot shows a mobile application interface for 'Physical Inventory'. At the top, there is a dark blue header with a back arrow on the left, the title 'Physical Inventory' in the center, and a menu icon on the right. Below the header, the page displays the following information:

- PI Name:** Boston-Glenlake
- Scan Location:** (empty field)
- Scan By:** A toggle switch set to 'Tag' (indicated by a green circle).
- Scan Next:** (empty text input field)

Below a horizontal separator line, the following asset details are listed:

- Unit:** US001
- Asset ID:** 000000000162
- Tag:** BWP2W1400111
- Serial ID:** 998AW834HJDD
- Description:** B&W Multifunction Printer
- Asset Status:** In Service
- Location Code:** US017
- Location:** USA - Boston
- Area ID:** GL2-WEST
- Area:** Glenlake 2 West
- Mfg Name:** Ricoh
- Model:** 5210
- Department ID:** 43000

On the left side of the form, there is a blue square button with a white double vertical bar icon (||).

When you begin physical inventory, the asset inventory list displays on the left side of the page. You can filter the list by all assets (*all assets in scan scope, plus scanned assets not in the scan scope*), scanned assets, and remaining assets (assets not yet scanned). You can also use the **Grid Sort** icon to sort list results by Tag Number, Description, Serial ID, Location, or Scan Date.

The View By toggle switch determines whether to display the Tag or the Serial Id as the primary/secondary data in the grid. The View By toggle switch is available only when the Scan By field option is *Tag Number or Serial ID*. For details see “Setting Up Application-Specific Installation Options” (Application Fundamentals)

Note: The asset inventory list displays when you select the **Show Inventory List** option on the Scan Options page. If you do not enable this option, the asset inventory list is hidden from the page.

Scan an asset barcode to perform physical inventory and populate the Physical Inventory (PI_SCAN) and Scan History (PI_SCAN_HIST) tables with scan records.

From here you can access related physical inventory pages that enable you to edit asset information, manually add a scan record for a new asset, and manually add a scan record.

The Scan By toggle switch is displayed based on the value entered in the Installation Options - Asset Management page. For details see “Setting Up Application-Specific Installation Options” (Application Fundamentals)

Select the **Edit** button to access the **Edit Scan Record** page and edit scanned asset information.

Select **New Asset** from the Actions List menu to access the **New Asset Scan Record** page and add a new scanned asset to the PI_SCAN table.

Select **Find Asset** from the Actions List menu to access the **Find Asset** page and manually create a scan record for an asset without scanning a barcode.

Edit Scan Record Page

Use the Edit Scan Record (PI_SCAN_EDIT_SCF) page to modify scanned asset information.

Navigation:

Fluid Home > Asset Tracking > Select the Physical Inventory tile > Select the Edit button on the Physical Inventory tile.

Edit Scan Record page

Cancel
Edit Scan Record
Done

Unit US001

Asset ID 000000000102

Retire Asset No

Tag T00000000102

Serial ID 🔍

Description

Location Code 🔍

Area ID 🔍

Mfg Name 🔍

Model 🔍

Dept ID 🔍

Custodian Deptid 🔍

Custodian

Empl ID 🔍

IP Alias

You can use the Edit Scan Record page to modify scanned asset information. If this is a new asset you can edit all fields on this page. If this is an existing asset you cannot edit **Business Unit**, **Asset ID**, and **Tag**.

Use the **Retire Asset** toggle to retire the scanned asset. This field is functional when you select the **Allow Retirements** option on the Scan Options page. If you do not enable this option, you cannot use the Retire Asset toggle.

Select **Done** to save your changes.

New Asset Scan Record Page

Use the New Asset Scan Record (PI_SCAN_NEW_SCF) page to manually add a new scanned asset to the Physical Inventory (PI_SCAN) interface table.

Navigation:

Fluid Home > Asset Tracking > Select the Physical Inventory tile > Select New Asset Scan Record from the Actions List menu.

New Asset Scan Record page

New Asset Scan Record	
PI Name	US001 Fleet Assets
Unit	US001
Asset ID	NEXT
Tag	
Serial ID	
Description	
Location	
Area ID	
Mfg Name	
Model	
Department	
Custodian Deptid	
Custodian	
Empl ID	

Find Asset Page

Use the Find Asset (PI_SCAN_FIND_FL) page to manually create a scan record for an asset without scanning a barcode.

Navigation:

Fluid Home > Asset Tracking > Select the Physical Inventory tile > Select Find Asset from the Actions List menu.

Find Asset page

The screenshot shows the 'Find Asset' page with the following details:

Confirm To PI ID	DEMO
PI Name	US001 Fleet Assets
Unit	US001
Asset ID	000000000003
Tag	P00000009002
Serial ID	567345JPY5
Description	Gas/elec car - fleet vehicle 2
Asset Status	In Service
Location Code	US001
Location	USA - New York
Area ID	PARKING B
Area	Parking B - HQ
Mfg Name	Toyota Motor Sales, Inc.
Model	Prius
Dept ID	10000
Department	Human Resources
Custodian	10000

At the bottom of the page, there is a green button labeled 'Confirm Manual Scan'.

When you are unable to scan a barcode while performing physical inventory, you can use the Find Asset page to manually create a scan record for an asset without scanning a barcode.

Simply enter search parameters, such as **Business Unit** and **Asset ID**, and select **Search** to retrieve asset information from the Asset Repository. Asset information is displayed in a list on the left side of the page.

Use the list to select an asset you want to manually create a scan record for, and select **Confirm Manual Scan** to complete the process. Similar to scanning an asset, selecting **Confirm Manual Scan** populates the Physical Inventory (PI_SCAN) and Scan History (PI_SCAN_HIST) tables with the scan record.

Load/Match/Reconcile PI Info Page (Classic Physical Inventory)

Use the Load/Match/Reconcile PI Info page (RUN_AMPI1000) to execute each step of the Physical Inventory process. It is recommended that you add a new run control ID for each physical inventory ID (PI ID). Also use this run control ID for subsequent steps within the same PI ID.

Navigation:

Asset Management > **Physical Inventory** > **Load/Match/Reconcile PI Info** > **Load/Match/Reconcile PI Info**

This example illustrates the fields and controls on the Load/Match/Reconcile PI Info page. You can find definitions for the fields and controls later on this page.

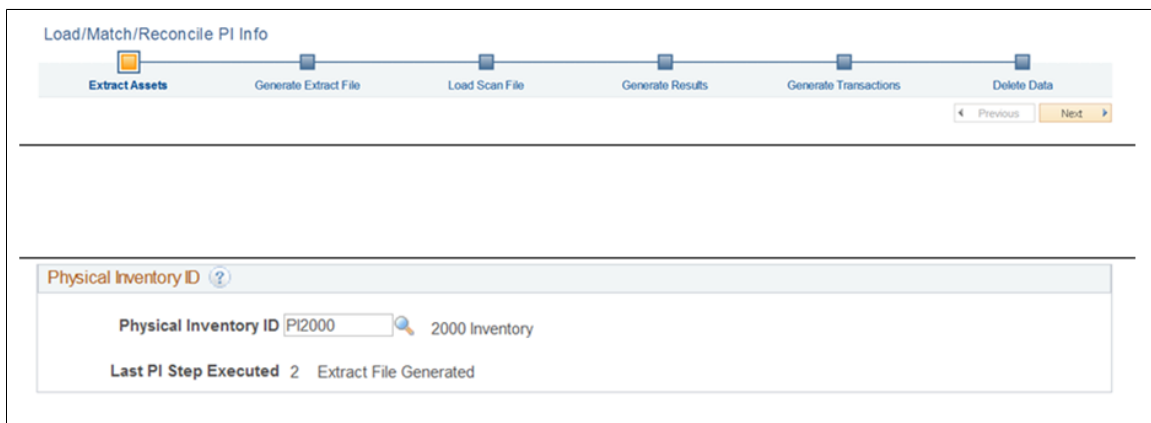

You can navigate either by clicking on the corresponding Step buttons or by clicking the Next and Previous buttons.

Extract data allows you to extract all your current PS/AM data

Run the various steps in sequential order from this run control page for a specific PI ID (physical inventory ID) and click the Run button.

Last PI Step Executed – Displays the step number and step description of the last step that was processed in the physical inventory process.

This step executes the actual data extract from PeopleSoft Asset Management. When you extract data, you do not need to enter a file name or file type. The data is saved in a relational table called PI_EXTRACT. Click the **Extract** button and click the **Run** button. If you want to view the extract data before using it in subsequent steps, access the Extract Data page.

You can navigate either by clicking on the corresponding Step buttons or by clicking the Next and Previous buttons.

Run the various steps in sequential order from this run control page for a specific PI ID (**Physical Inventory ID**) and click the **Run** button.

Last PI Step Executed displays the step number and step description of the last step that was processed in the physical inventory process.

Extract Assets (Step 1)

Select this physical inventory option to extract asset data and click the Run button to process the step.

This example illustrates the fields and controls on the Extract Assets Page. You can find definitions for the fields and controls later on this page.

This step executes the actual data extract from PeopleSoft Asset Management. When you extract data, you do not need to enter a file name or file type. The data is saved in a relational table called PI_EXTRACT. If you want to view the extract data before using it in subsequent steps, see [Review Extracted Data Page \(Classic Physical Inventory Only\)](#).

Generate Extract Export File (Step 2)

Select this step to create an output file from the extract data. When you select this option, you must select an export file format and supply a file name:

This example illustrates the fields and controls on the Generate Extract File Page. You can find definitions for the fields and controls later on this page.

Extract Assets **Generate Extract File** Load Scan File Generate Results Generate Transactions Delete Data

Generate Extract File - Step 2 of 6 Previous Next

Run Control ID EIP Report Manager Process Monitor Run

Physical Inventory ID ?

Physical Inventory ID 2000 Inventory

Last PI Step Executed 2 Extract File Generated

Generate Extract File ?

Generate Extract File will allow you to extract all your current PS/AM data into a format you may load into a Bar-code reader.

Export File ?

*Format ▼

*Export File Name

Field or Control	Description
Export File	<p>CSV File - Select CSV File for a comma-separated values (CSV) file.</p> <p>Scanner File - Select Scanner File as the export file type, and enter a file name (as well as any additional path information) for the file that you want to generate. The output file is formatted for loading into a bar code scanning device in preparation for performing physical inventory.</p> <p>Generate Labels - To create a file for printing labels rather than performing inventory, select Generate Labels as the export file type. A label file is created for the printer in a different format from the one used for a scanning device.</p> <p>To generate files for both a scanning device and a printer, perform step 2 twice with a different output file type each time.</p> <p>Web Service - Select Web Service to use the Integration Broker web service option to load the physical inventory data. This happens without any input or initiation. As soon as an inbound XML message is received from the third party vendor, the associated handler loads the scanned data.</p> <hr/> <p>Note: When using the web service option, remember to supply the file size for chunking on the Asset Management Installation Options page. This specifies the chunk size for the message GET_PIDATA.</p> <hr/> <p>See “Setting Up Application-Specific Installation Options” (Application Fundamentals)</p>

Note: The EXTCOPY.BAT file is configured to copy the extract file to the A:\ drive for demonstration or quick overview purposes. You need to modify EXTCOPY.BAT if you want to copy the extract file to the appropriate drive on a scanner.

Copy the scanner program (PI.EXE) and scanner file to the MS-DOS based scanning device. You can easily do this using a communications software package. You may wish to use a certified integration solution provided by recommended software vendors. Consult the bar code scanning device manual and software vendor for more information.

Once you have loaded the extract file and scanner program into the inventory-scanning device, you can perform the physical inventory. Each time that you scan an asset that is included in the extract file, the scanner displays the asset's information, such as tag number, description, serial ID, asset ID, and custodian. For the asset that you scan, you can retain or modify the values displayed on the scanner.

While you are performing the physical inventory scan, the scanning device creates a sequential file that contains information on all the scanned assets. The next step is to load the scanned file into PeopleSoft Asset Management for review.

Note: The files EXTCOPY.BAT and PI.EXE reside in the \PI directory. EXTCOPY.BAT is no longer supported, but it may be useful for a quick overview of the process.

Review the section on hardware requirements for further information about bar code scanners and methods of moving data to and from scanning devices.

If you are using an IT asset discovery tool from a third party vendor, you need to run a gateway extract so that you have a file to load into PeopleSoft Asset Management.

Load Scan Import File (Step 3)

After completing the physical inventory with the scanning system, download the scanner data into a workstation or network server so that it can be converted back into a PeopleSoft Asset Management table called PI_SCAN. You do this using a communications software package or by using the certified integration solution provided by various software vendors. Consult the bar code scanning device manual or software supplier for more information.

This example illustrates the fields and controls on the Load Scan Import File. You can find definitions for the fields and controls later on this page.

Note: PeopleSoft Asset Management provides an unsupported file called SCANCOPY.BAT (found in the \PI directory) that can be edited to copy the SCAN.DAT file from the scanner to the computer. You may need to modify the copy statement in SCANCOPY.BAT so that it copies from the drive letter corresponding to the scanner's drive. This is similar to the modification that you may need to make to EXTCOPY.BAT.

Once the scanner files are available to load into Asset Management, you can run step 3 of the physical inventory process.

Enter the directory and file name of the inventory file. This is most likely \TEMP\SCAN.DAT. If located on the PeopleSoft Internet Architecture server, you can run the next process on the server.

Select the Load Scan Import File option and click the Run button to load the scan data into PeopleSoft Asset Management. You can load as many files as you need by renaming SCAN.DAT (during the bar code scanning process) with unique file names and loading each file separately.

Note: If you have written your own scanning program or modified PI.BAS to configure fields or field lengths, you need to update the file formats in AMPI1000.SQC to match.
 Once you have completed this step, review scanned data, find any duplicate tags, and verify that there are no duplicate serial IDs.
 See [Verify Scanned Data Page](#).
 See [Verify Duplicate Tags Page](#).
 See [Verify Duplicate Serial ID Page](#).

Generate Results (Step 4)

After the inventory data is loaded into Asset Management and you have reviewed it, correcting any duplicates or errors, you can run step 4. This step performs matching between a physical inventory scan scope and scanned data and creates physical inventory results for review.

This example illustrates the fields and controls on the Generate Results . You can find definitions for the fields and controls later on this page.

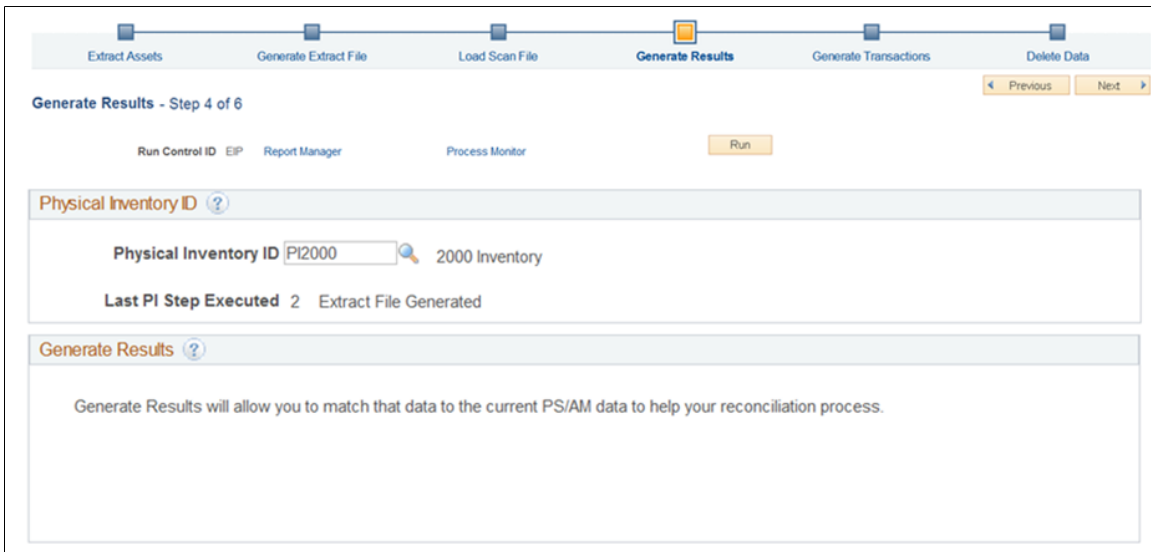

Note: Remember before you generate results, you should use the Verify Duplicate Tags page and Verify Duplicate Serial ID page to clean up any possible errors in the scanned data.

Field or Control	Description
Generate Results	<p>Select the Generate Results option and click the Run button to initiate processing. Note that this step may take some time to complete due to the amount of information that must be processed.</p> <p>Because this step involves some complex processing, you may want to have your database administrator optimize the database before you execute the step.</p>

Generate Physical Inventory Transactions (Step 5)

After matching is performed, you create physical inventory transactions that reconcile the data in Asset Management with the results of the physical inventory.

Select the Generate Transactions and click the Run button to begin generating the transactions.

Because this step involves some complex processing, you may want to have the database administrator optimize the database before you run it.

This example illustrates the fields and controls on the Generate Physical Inventory Transactions. You can find definitions for the fields and controls later on this page.

The screenshot displays the 'Generate Transactions' step (Step 5 of 6) in a software interface. At the top, a progress bar shows the following steps: Extract Assets, Generate Extract File, Load Scan File, Generate Results, **Generate Transactions** (highlighted), and Delete Data. Below the progress bar, the title is 'Generate Transactions - Step 5 of 6'. There are navigation buttons for 'Previous' and 'Next'. A 'Run' button is visible. Below the 'Run' button, there are links for 'Run Control ID', 'EIP', 'Report Manager', and 'Process Monitor'. The main content area has two sections: 'Physical Inventory ID' with a search box containing 'PI2000' and a dropdown showing '2000 Inventory', and 'Generate Transactions' with a text box containing 'Generate Transactions will create corresponding PI Interface entries being processed by AMIF1000.'

Note: This step takes the longest time to process, so be sure that you are satisfied with the generated results before you load the transactions. You can see the results of the matching process by reviewing the Results page and the Results Detail page. See [Results Page](#).

After you have created, reviewed, and approved the reconciliation transactions, you load them by using the Interface Asset Information component and the Transaction Loader.

Delete Physical Inventory Data (Step 6)

When you no longer need your physical inventory data, select one of the following options and click the **Run** button.

This example illustrates the fields and controls on the Delete Physical Inventory Data. You can find definitions for the fields and controls later on this page.

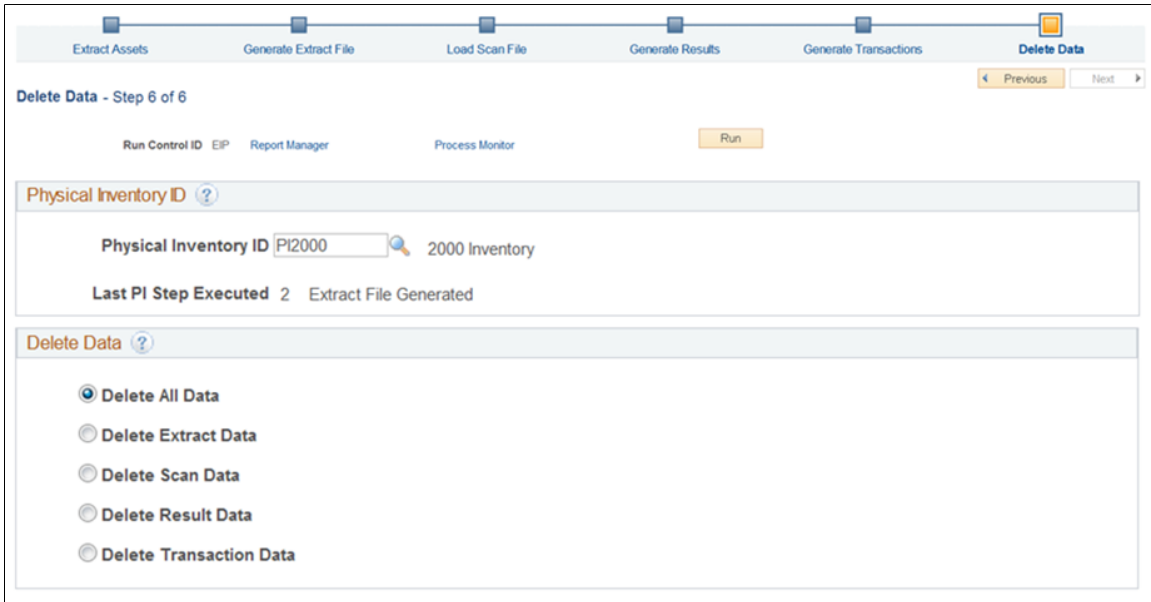

Field or Control	Description
Delete All	Select to delete all physical inventory data generated for the specified Physical Inventory ID: (Extract Data, Scan Data, Result Data, and Transaction Data).
Delete Extract Data	Select to delete the Physical Inventory extract file.
Delete Scan Data	Select to delete the physical inventory scan data.
Delete Result Data	Select to delete the physical inventory results data.
Delete Transaction Data	Select to delete the physical inventory transaction data.

Upon successfully completing all the steps, the system will advance the navigator to the next step. The user can click the Run Button to submit the process.

This example illustrates the fields and controls on the Process Scheduler Request Page. You can find definitions for the fields and controls later on this page.

Process Scheduler Request

User ID: VP1 Run Control ID: EIP

Server Name: Run Date:

Recurrence: Run Time:

Time Zone: Pacific Time (US)

Process List

Select	Description	Process Name	Process Type	*Type	*Format	Distribution
<input checked="" type="checkbox"/>	AM PI Job - SQR & AE Web Serv	AM_PIJOB	PSJob	(None) ▼	(None) ▼	Distribution

Review Extracted Data Page (Classic Physical Inventory Only)

Use the Review Extracted Data page (PI_EXTRACT_01) to view the results of the extract data one asset at a time. This step is optional.

You can also search by PI line number, asset ID, department, tag number, serial ID, and location. The PI line number reflects the number of this asset in the extract sequence. For instance, the third asset that was extracted falls on PI Line Number 3. The system presents you with all the assets that match your criteria. Select the one you want to view.

Navigation:

Asset Management > Physical Inventory > Review Extracted Data > Review Extracted Data

This example illustrates the fields and controls on the Review Extracted Data page. You can find definitions for the fields and controls later on this page.

Review Extracted Data

Physical Inventory ID	AM-PI	PI ID FOR AM	
Extracted Data			
Asset ID	FINBASC06		Description Location Chnage
Location	US001		Serial ID ASSET 6
Cost	USD	3,000.00	Tag Number ASSET 6
Manufacturer			
Model			
Empl ID			
Category	FF		Cost Type
Asset Type	Furniture		Asset Subtype
Asset Class			Asset Profile FURNITURE
Custodian			
Area ID			
Chartfields			
ChartField Value			
Operating Unit			
Fund Code			
Department			
Program Code			
Class Field			
Budget Reference			
PC Business Unit			
Project			
Activity			
Source Type			
Category			
Subcategory			
Product			

View the extract data one asset at a time. You can search by Physical Inventory ID, PI line number, asset ID, , tag number, and location code. The PI line number reflects the number of this asset in the extract sequence. For instance, the third asset that was extracted falls on PI Line Number 3. The system presents you with all the assets that match your criteria. Select the one you want to view.

Verify Duplicate Tags Page

Use the Verify Duplicate Tags page (PI_SCAN_DUP_TAG) to conduct searches for finding and correcting physical inventory data.

Navigation:

Asset Management > Physical Inventory > Verify Duplicate Tags

It is very common for an asset to be scanned multiple times during physical inventory, thus creating more than one entry with the same tag or serial number. In order for PeopleSoft Asset Management to perform inventory reconciliation, each tag or serial number must be unique. Therefore, it is extremely important that you identify and resolve any duplicate entries. If any duplicate entries exist when results are generated, these entries are marked as errors and are not processed any further.

This example illustrates the fields and controls on the Verify Duplicate Tags page. You can find definitions for the fields and controls later on this page.

Verify Duplicate Tags

Physical Inventory ID PI2000 2000 Inventory

Unit Match Status Manual Review Required

Asset ID

Scanned By

Physical Inventory ID

Tag Number	<input type="text" value="P00005460"/>	Custodian	<input type="text" value="Natter,Andreas"/>
Serial ID	<input type="text" value="03712928"/>	Empl ID	<input type="text" value="3279"/>
Manufacturer	<input type="text" value="Toshiba"/>	Location	<input type="text" value="GERMANY"/>
Model	<input type="text" value="730"/>	Area ID	<input type="text"/>
Description	<input type="text"/>	Department	<input type="text" value="3100"/>
IP Alias	<input type="text" value="ANATTER052099.peoplesoft.com"/>	IP Address	<input type="text"/>
Comment	<input type="text"/>		

You can search on a tag and a physical inventory line number. The physical inventory line number reflects the number of this asset in the scanning sequence. For instance, the third asset that was scanned falls on physical inventory line number 3.

If duplicates exist, the system displays a page on which you can correct or delete assets that have duplicate numbers.

The **IP Alias** and **IP Address** fields describe the internet protocol attributes of IT assets that are extracted from the IT discovery tools database.

Verify Duplicate Serial ID Page

Use the Verify Duplicate Serial ID (identification) page (PI_SCAN_DUP) to conduct searches for finding and correcting physical inventory data.

Navigation:

Asset Management > Physical Inventory > Verify Duplicate Serial ID

This example illustrates the fields and controls on the Verify Duplicate Serial ID page. You can find definitions for the fields and controls later on this page.

The Duplicate Serial Number page is similar to the Duplicate Tags page except that you are reviewing created records that have a duplicate Serial ID number.

Identification of duplicate serial IDs within the same physical inventory ID.

Verify Scanned Data Page

Use the Verify Scanned Data page to review the scanned data.

Navigation:

Asset Management > Physical Inventory > Verify Scanned Data > Verify Scanned Data

This example illustrates the fields and controls on the Verify Scanned Data page. You can find definitions for the fields and controls later on this page.

The Verify Scanned Data page is similar to the Verify Duplicate Tags page except that you are reviewing the scanned data.

Results Page

Use the Results page (PI_RESULTS_01) to view the results of the matching process.

Navigation:

Asset Management > Physical Inventory > Review Matching Results

This example illustrates the fields and controls on the Results page. You can find definitions for the fields and controls later on this page.

The screenshot shows a web interface for reviewing matching results. At the top, there are tabs for 'Results' and 'Details'. Below the tabs, there are labels for 'Physical Inventory ID AM-PI' and 'PI ID FOR AM'. The main section is titled 'Asset Match Results' and contains several input fields: 'Asset ID' with the value 'FINADD01', 'PI Match Status' with a dropdown menu set to 'Inventory', and 'Scanned By' with an empty text box. To the right, there is an 'Alerts' section with three checkboxes: 'Manual Review Required', 'Result In Error', and 'Multiple Department Error'. Below this is a 'Results Notification' section with checkboxes for 'Send Email' and 'Send Worklist', a 'Description' text area, and a 'User ID' field with a search icon. At the bottom, there are two sections for error messages: 'PI Results Error Msg' and 'Department Error Msg', each with a 'Description' text area.

The **PI Match Status** (physical inventory match status) field displays an asset's physical inventory status when results are generated and matching is performed. An asset can have one of the following statuses:

Status	Reason	Transactions Generated
<i>Accel</i>	NA	NA
<i>All I, O, U</i>		
<i>Discard</i>		
<i>Initial</i>		
<i>Inventory</i>	Asset was scanned during inventory as expected.	Transfers and physical changes (description, location, department, custodian, and so on).
<i>None</i>		

Status	Reason	Transactions Generated
<i>Over</i>	Asset was scanned but not expected.	Physical adds.
<i>Retire</i>	Asset was scanned during inventory and was determined to be sold/retired.	Retirements.
<i>Special Depr</i>		
<i>Under</i>	Asset was expected but not scanned.	Retirements.

Field or Control	Description
Manual Review Required	This check box is selected if the scanner operator requested a special review for this asset.

Field or Control	Description
Results in Error	<p>This check box is selected if the physical inventory processing cannot process a result further. The following error conditions may apply:</p> <ul style="list-style-type: none"> • Duplicate tags. If any duplicate tags still exist in the scanned data, the results generated for those duplicates contain errors. • Duplicate Serial IDs. If any duplicate Serial IDs exist when being scanned by Serial ID, they will be reported as errors. <hr/> <p>Note: Additionally, the duplicates that are not errors (Duplicate Tag or Duplicate Serial ID) will appear in Verify Duplicate Tags and Verify Duplicate Serial IDs respectively for review and correction.</p> <hr/> <ul style="list-style-type: none"> • Multiple Departments If an asset has multiple departments (that is, the cost is divided between two or more departments), an error results. Physical inventory processing cannot handle such assets. However if the cost is split between multiple funding (Split Funding) within 1 department the system will allow the transfer of the Split Funding to the new department specified. Furthermore, if multiple departments error occurs, the system will stop the departmental transfer but will still allow other transactions, such as location/custodian transfer to be processed for that asset. • Asset retired. An asset recorded as <i>Retired</i> in Asset Management was scanned. Physical inventory processing doesn't process reinstatements automatically. Complete these in the Retiring Financial Assets component. • InterUnit candidate. A scanned tag was found for an asset in a business unit other than the one for which you're processing physical inventory. You should transfer it from that business unit to the physical inventory business unit. Physical inventory processing doesn't perform interunit transfers automatically. Complete these in the Asset Cost Adjust/Transfers component. <p>These errors are exceptions to the rule and should not occur frequently or in high volumes. Results that are in error do not generate transactions and should be resolved manually.</p>

Results Notification

If you use Workflow, this section contains fields that are used in workflow processing to generate automatic physical inventory results notifications. These can be sent to a worklist, an email address, or both.

This example illustrates the fields and controls on the Details Page. You can find definitions for the fields and controls later on this page.

Results		Details
Physical Inventory ID		AM-PI
Asset ID		FINADD01
PI ID FOR AM		
PI Scan Scope Mass Change ID		
	Scanned Values	Original Values
Tag Number	<input type="text" value="FIN ASSET 1"/>	FINADD001
Serial ID	<input type="text" value="FIN ASSET 1"/>	FINADD001
Manufacturer	<input type="text" value="APS"/>	
Model	<input type="text"/>	
Location	<input type="text" value="US001"/>	US001
Area ID	<input type="text"/>	
Department	<input type="text"/>	12000
Custodian	<input type="text" value="NEW,NEW"/>	
Empl ID	<input type="text"/>	
Description	<input type="text" value="No Description"/>	FINADD001

Viewing Physical Inventory History and Reports

This topic lists the pages used to view physical inventory history.

Pages Used to View Physical Inventory History

<i>Page Name</i>	<i>Definition Name</i>	<i>Usage</i>
Review Inventory History Page	PI_ASSET_HIST1	View a history of all the instances that an asset has been inventoried by PI ID, Inventory date and user.

Page Name	Definition Name	Usage
<u>Run Physical Inventory Reports Page</u>	RUN_AMPI2000	Generate physical inventory reports, specifying Physical Inventory ID, location and department.

Review Inventory History Page

Use the Review Inventory History page (PI_ASSET_HIST1) to view history of all the instances that an asset has been inventoried by Physical Inventory ID, Inventory date and user.

Navigation:

Asset Management > Physical Inventory > Review Inventory History > Review Inventory History

This example illustrates the fields and controls on the Review Inventory History Page. You can find definitions for the fields and controls later on this page.

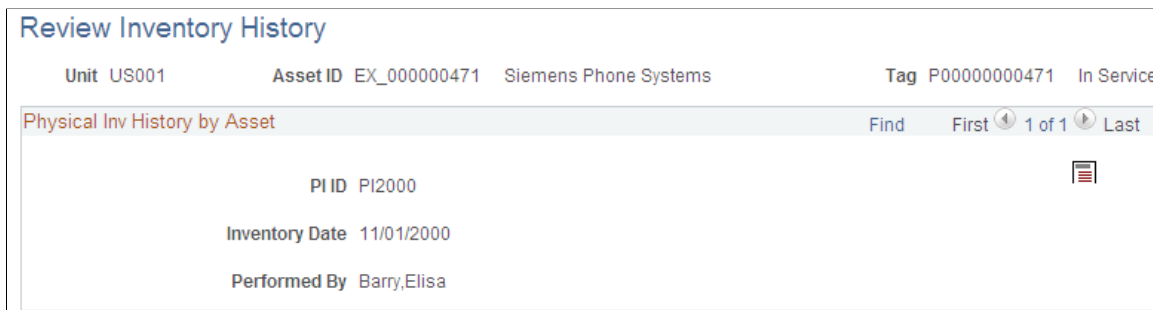

Review all the physical inventory process instances for a given asset within a business unit. You can click the Popup Comment PB button to add your comments for the instance in the modal window, PI History Comments.

Run Physical Inventory Reports Page

Use the Run Physical Inventory Reports page (RUN_AMPI2000) to generate physical inventory reports, specifying Physical Inventory ID, location and department.

Navigation:

Asset Management > Physical Inventory > Run Physical Inventory Reports

This example illustrates the fields and controls on the Run Physical Inventory Reports Page. You can find definitions for the fields and controls later on this page.

The screenshot shows the 'Run Physical Inventory Reports' interface. At the top, there is a title bar with the text 'Run Physical Inventory Reports'. Below the title bar, there are several controls: 'Run Control ID LL', 'Report Manager', and 'Process Monitor' are displayed as links. To the right of these links is a yellow 'Run' button. Below these controls is a 'Language' dropdown menu currently set to 'English'. A section titled 'Report Request Parameters' is highlighted with a light blue background. This section contains three input fields: 'Physical Inventory ID', 'Location', and 'Department'. Each input field has a magnifying glass icon to its right, indicating a search function.

Select report request parameters to limit report output by Physical Inventory ID, Location, and Department. Click the Run button, and select any of the following SQR reports from the Process Scheduler Request page:

- AMPI2000 - PI Extract
- AMPI2100 - PI Scan Data
- AMPI2200 - PI Results Inventoried
- AMPI2210 - PI Results – Unders
- AMPI2220 - PI Results - Overs

Tracking Assets with the Asset Tracking Homepage

Asset Tracking enables you to search for assets and display asset information without scanning a barcode, view preventative maintenance schedules and work orders associated with an asset, and scan assets within a specific location to build an audit history for assets in that location—all from your mobile device or mobile scanning device.

To facilitate mobile asset tracking, PeopleSoft Asset Management provides the new **Scan Asset**, **Scan By Location**, and **Find Asset** tiles within the **Asset Tracking** homepage.

Asset Tracking tiles in the Asset Tracking homepage

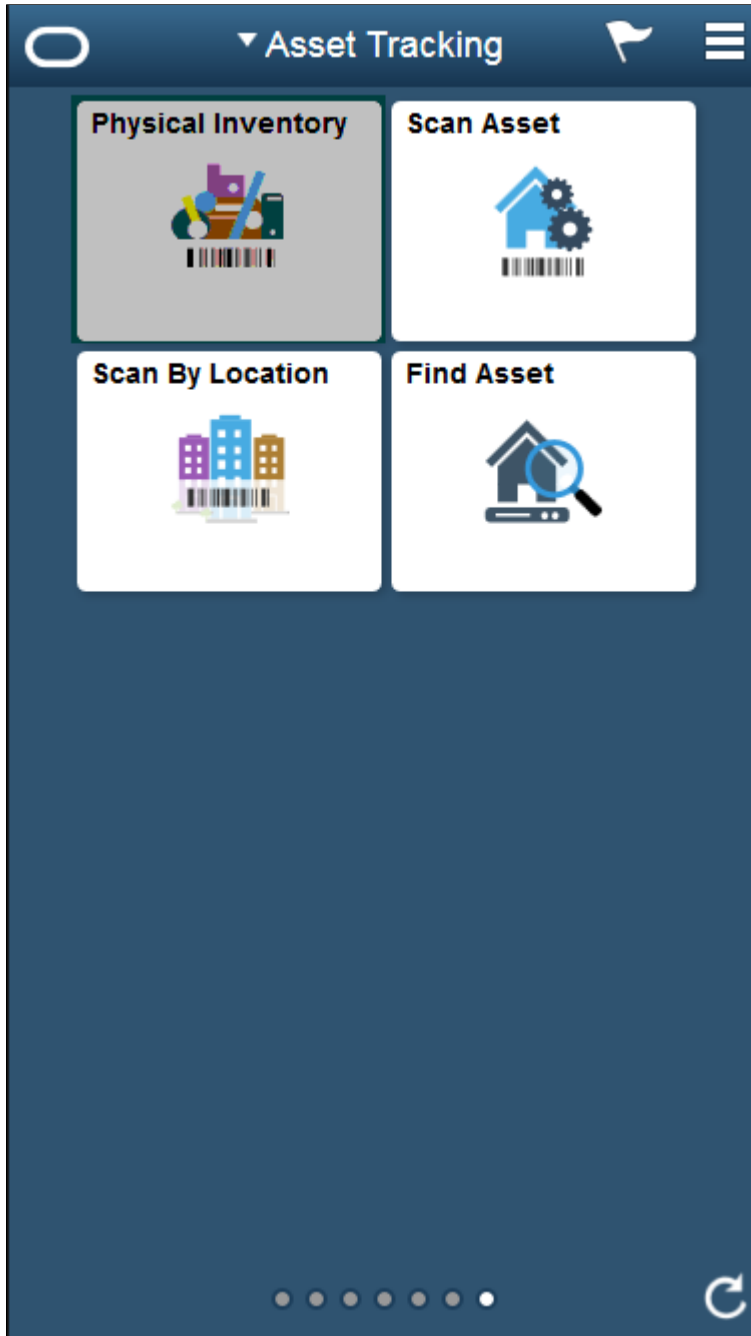

This example illustrates the fields and controls on the Asset Tracking home page. You can find definitions for the fields and controls later on this page.



The asset tracking tiles are part of the PeopleSoft Fluid User Interface and can be accessed from your mobile device or mobile scanning device.

Use the **Scan Asset** tile to retrieve general information, preventative maintenance schedules, and work orders associated with a scanned asset. The asset information is retrieved from the Asset Repository.

Use the **Scan By Location** tile to scan assets within a specific location and build an audit history for assets in that location. Audit history is stored in the Scan History (PI_SCAN_HIST) table.

Use the **Find Asset** tile to retrieve information for assets without scanning a barcode.

Use the Asset Tracking pivot tiles to view the pivot display of asset scans, duplicate tags, scan results, and scan history.

Note: Use the Scan Options page to configure field-level authorization and define email notification defaults for the pages within the Asset Tracking homepage.

Note: You can assign a default business unit to use with the Scan Asset, Scan By Location, and Find Asset pages using the Asset Management - User Preferences page.

See “Asset Management - User Preferences Page” (Application Fundamentals)

Pages Used to Track Assets

<i>Page Name</i>	<i>Definition Name</i>	<i>Usage</i>
<u>Scan Options Page</u>	PI_SCAN_OPTIONS	Define email notification defaults and configure field level authorization for the pages within the Asset Tracking homepage.
<u>Field Display Setup Page</u>	PI_SCAN_OPT_FLD	Configure individual field display and edit properties for the Fluid pages in the Asset Tracking homepage.
<u>Scan Asset Page</u>	PI_SCAN_ASSET_FL	Retrieve general information, preventative maintenance schedules, and work orders associated with a scanned asset. The asset information is retrieved from Asset Repository. You cannot edit asset information on the Scan Asset page.
<u>Scan By Location Page</u>	PI_SCAN_LOC_FL	Scan assets within a specific location and build an audit history for assets in that location.
<u>Find Asset Page</u>	AM_FIND_ASSET_FL	Retrieve information for assets without scanning a barcode. You cannot edit asset information on the Find Asset page.
Notify (Email Notification)	PI_SCAN_EMAIL_SCF	Send email notification regarding an asset.

Scan Options Page

Use the Scan Options page (PI_SCAN_OPTIONS) to define email notification defaults and configure field level authorization for the pages within the Asset Tracking homepage.

Navigation:

Setup Financials/Supply Chain > Product Related > Asset Management > Physical Inventory > Asset Tracking Scan Options > Scan Options

This example illustrates the fields and controls on the Scan Options page (1 of 5). You can find definitions for the fields and controls later on this page.

Scan Options

Notifications Personalize | Find | View All | [Print] [Grid] First 1 of 1 Last

Email Options Email Text [More]

*Business Unit	Send To Asset Custodian	Auto Send Email	*Default Email Address
US001	<input type="checkbox"/>	<input type="checkbox"/>	change_me@oracle.com

User/Rolename Tile Options Personalize | Find | View All | [Print] [Grid] First 1 of 1 Last

Physical Inventory Scan By Location | Scan Asset | Find Asset [More]

*ID Type	*User/Role	Show Inventory List	Allow Retirements	Show Asset Not in List Message	Show New Scan Record Message	Show Edit Scan Record Message	Show Find Asset Message	Field Display Setup
Role	CLERK	<input checked="" type="checkbox"/>	<input type="checkbox"/>	<input checked="" type="checkbox"/>	<input checked="" type="checkbox"/>	<input checked="" type="checkbox"/>	<input checked="" type="checkbox"/>	[More]

This example illustrates the fields and controls on the Scan Options page (2 of 5). You can find definitions for the fields and controls later on this page.

Notifications Personalize | Find | View All | [Print] [Grid] First 1 of 1 Last

Email Options Email Text [More]

*Subject Message Set	*Subject Message Number	*Body Message Set	*Body Message Number	Preview Email
8040	102	8040	103	[More]

This example illustrates the fields and controls on the Scan Options page (3 of 5). You can find definitions for the fields and controls later on this page.

User/Rolename Tile Options Personalize | Find | View All | [Print] [Grid] 1-1 of 1 | View All

Physical Inventory Scan By Location | Scan Asset | Find Asset [More]

*ID Type	*User/Role	Force Asset Location Update	Scan Any Location	Update Other BU	Field Display Setup
Role	CLERK	<input type="checkbox"/>	<input type="checkbox"/>	<input type="checkbox"/>	[More]

This example illustrates the fields and controls on the Scan Options page (4 of 5). You can find definitions for the fields and controls later on this page.

User/Rolename Tile Options Personalize | Find | View All | [Print] [Grid] First 1 of 1 Last

Physical Inventory Scan By Location | Scan Asset | Find Asset [More]

*ID Type	*User/Role	Field Display Setup
Role	CLERK	[More]

This example illustrates the fields and controls on the Scan Options page (5 of 5). You can find definitions for the fields and controls later on this page.

The screenshot shows a software interface for 'Scan Options'. At the top, there is a navigation bar with 'Personalize | Find | View All | [Print] | [Grid] | First 1 of 1 Last'. Below this are four tabs: 'Physical Inventory', 'Scan By Location', 'Scan Asset', and 'Find Asset'. A table below the tabs has three columns: '*ID Type', '*User/Role', and 'Field Display Setup'. The first row of the table contains the values 'Role', 'CLERK', and a small icon with a plus and minus button.

Notifications

Use this group box to define email notification defaults for all four tiles within the Asset Tracking homepage. The parameters you define here correspond to the **Notify** (email notification) option associated with the Actions List.

Field or Control	Description
Business Unit	Select the business unit for which you will apply email notification defaults.
Send to Asset Custodian	<p>Select this option to send notifications to the asset custodian (instead of the default email address) when you use the Notify feature in the Actions List.</p> <p>When you select this option, the To field of the Email Notification pagelet is automatically populated with the email address of the asset custodian.</p> <p>Asset custodian email address is defined on the PeopleTools User Profiles page. If custodian email address does not exist, the To field of the Email Notification pagelet is automatically populated with the default email address defined on this page.</p>
Auto Send Email	Select this option to bypass the Email Notification pagelet and automatically send an email when you select the Notify feature from the Actions List.
Default Email Address	Enter a default email address that will automatically populate the To field of the Email Notifications pagelet when you use the Notify feature from the Actions List.

Use the **Email Text** tab to define subject line and message body default text for the Email Notifications pagelet when you use the Notify feature from the Actions List. PeopleSoft Asset Management delivers Message Catalog Set Number *8040* and Message Numbers *102* and *103*.

Note: You can modify the delivered messages, but you must ensure you accurately maintain the bind variables when doing so.

User/Rolename Tile Options

Use this group box to configure field authorization for the Asset Tracking homepage. You can configure field behavior at an individual (user) level or by role. There are four tabs in this group box, each corresponding to one of the four Asset Tracking homepage tiles.

Note: If a user belongs to multiple roles, the superset of enabled options is used.

Field or Control	Description
ID Type	Select the ID type for which you will configure field behavior. You can select <i>User</i> or <i>Role</i> .
User/Role	Select an individual user or role.
	Click the Field Display Setup icon to access the Field Display Setup page and configure individual field display and edit properties.
Show Inventory List (Physical Inventory)	<p>Select this option to display the asset inventory list on the Physical Inventory page.</p> <p>If you do not enable this option, the asset inventory list is hidden from the Physical Inventory page.</p>
Allow Retirements (Physical Inventory)	Select this option to enable asset retirement using the Edit Scan Record page from the Physical Inventory tile.
Show Assets Not in List Message (Physical Inventory)	Select this option to display an alert on the Physical Inventory page when a scanned asset is not in the Scan Scope.
Show New Scan Record Message (Physical Inventory)	Select this option to display a confirmation message on the Physical Inventory page when you create a new asset and click the Done button in the New Asset Scan Record page.
Show Edit Scan Record Message (Physical Inventory)	Select this option to display a confirmation message on the Physical Inventory page when you edit an asset scan record and click the Done button in the Edit Scan Record page.
Show Find Asset Message (Physical Inventory)	Select this option to display a confirmation message on the Physical Inventory page when an asset is confirmed in the Find Asset page.

Field or Control	Description
Force Asset Location Update (Scan By Location)	Select this option to automatically update the Asset Location (ASSET_LOCATION) table with the scan location in place of the current location. When set to 'Yes,' the system inserts an effective dated location record into the Asset Location table. Location attributes are also stored in the Scan History (PI_SCAN_HIST) table.
Scan Any Location (Scan By Location)	Select the check box to allow the user to select any scan location. The Business Unit default for the Scan By Location tile is the Business Unit value specified in the Define User Preferences page. This value determines which Scan Location values are available (via Tableset Sharing). When the Scan Any Location check box is selected, the Select Scan Location page will display a Business Unit field to allow the user to initially select a Business Unit value before selecting a Scan Location. The prompt values for the Scan Location field will be locations available for the selected Business Unit value.
Update Other BU (Update Other Business Unit)	Select this option to update the location for all assets sharing the same tag number, regardless of which business unit the asset originates. In other words, if a user updates a single asset location, the system will update all related assets sharing the same tag number across all business units. If you do not select this option, the system only updates location for related assets within the same business unit.

Field Display Setup Page

Use the Field Display Setup (PI_SCAN_OPT_FLD) page to configure individual field display and edit properties for the Fluid pages in the Asset Tracking homepage.

Navigation:

Setup Financials/Supply Chain > Product Related > Asset Management > Physical Inventory > Scan Options > Click the Field Display Setup icon on the Scan Options page.

Field Display Setup page

User/Role VP1

Display Fields Physical Inventory

Field Name	Show Field	Allow Field Edit
BUSINESS_UNIT	<input checked="" type="checkbox"/>	<input type="checkbox"/>
ASSET_ID	<input checked="" type="checkbox"/>	<input type="checkbox"/>
TAG_NUMBER	<input checked="" type="checkbox"/>	<input type="checkbox"/>
SERIAL_ID	<input checked="" type="checkbox"/>	<input checked="" type="checkbox"/>
DESCR	<input checked="" type="checkbox"/>	<input checked="" type="checkbox"/>
ASSET_STATUS	<input checked="" type="checkbox"/>	<input type="checkbox"/>
LOCATION	<input checked="" type="checkbox"/>	<input checked="" type="checkbox"/>
LOCATION_DESCR	<input checked="" type="checkbox"/>	<input type="checkbox"/>
OLD_LOCATION	<input checked="" type="checkbox"/>	<input type="checkbox"/>
OLD_LOCATION_DESCR	<input checked="" type="checkbox"/>	<input type="checkbox"/>
AREA_ID	<input checked="" type="checkbox"/>	<input checked="" type="checkbox"/>
AREA_ID_DESCR	<input checked="" type="checkbox"/>	<input type="checkbox"/>
MANUFACTURER	<input checked="" type="checkbox"/>	<input checked="" type="checkbox"/>
MODEL	<input checked="" type="checkbox"/>	<input checked="" type="checkbox"/>
DEPTID	<input checked="" type="checkbox"/>	<input checked="" type="checkbox"/>

<i>Physical Inventory Field Display Setup</i>	<i>Scan By Location Field Display Setup</i>	<i>Scan Asset Field Display Setup</i>	<i>Find Asset Field Display Setup</i>
<p>The field display setup options for Physical Inventory include the Show Field and Allow Field Edit options.</p> <p>The Allow Field Edit option is disabled for Business Unit, Asset ID, and Tag Number, and cannot be selected.</p>	<p>The field display setup options for Scan By Location include the Show Field and Allow Field Edit options.</p> <p>The Allow Field Edit option is disabled for all fields except for Comment. Disabled fields cannot be selected.</p>	<p>The field display setup options for Scan Asset include the Show Field only.</p>	<p>The field display setup options for Find Asset include the Show Field only.</p>

Scan Asset Page

Use the Scan Asset (PI_SCAN_ASSET_FL) page to retrieve general information, preventative maintenance schedules, and work orders associated with a scanned asset.

Navigation:

Fluid Home > Asset Tracking > Select the Scan Asset tile.

This example illustrates the fields and controls on the Scan Asset page - Assets.

The screenshot shows a mobile application interface for the 'Scan Asset' page. At the top, there is a dark blue header with a back arrow on the left, the title 'Scan Asset' in the center, and a three-dot menu icon on the right. Below the header is a text input field labeled 'Scan Next Tag'. Underneath is a horizontal tab bar with three tabs: 'Assets' (highlighted in green), 'PMs', and 'Work Orders'. The main content area displays the following asset information:

- Unit US001
- Asset ID 000000000003
- Tag P0000009002
- Serial ID 567345JPY5
- Description Gas/elec car - fleet vehicle 2
- Asset Status In Service
- Location Code US001
- Location USA - New York
- Area ID PARKING B
- Area Parking B - HQ
- Mfg Name Toyota Motor Sales, Inc.
- Model Prius
- Product Version
- Production Date
- Dept ID
- Department
- Custodian
- Deptid

On the left side of the main content area, there is a blue square button with a white double vertical bar icon (a pause or stop button).

This example illustrates the fields and controls on the Scan Asset page - Preventative Maintenance.

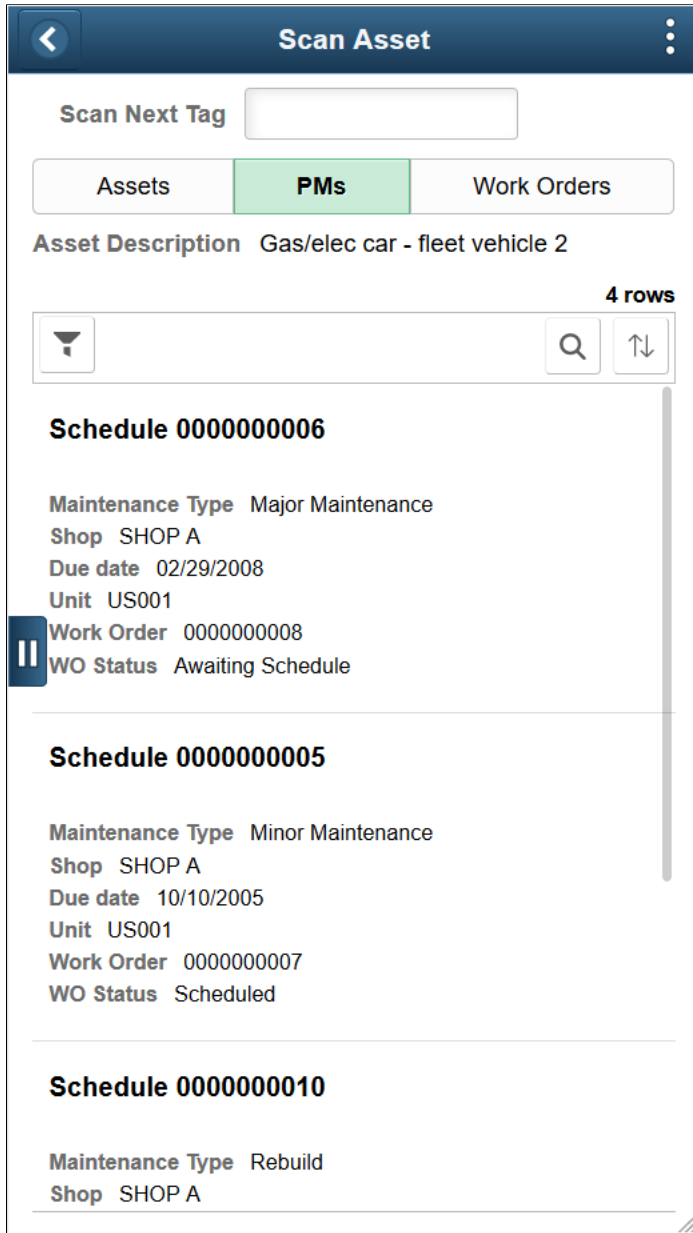

This example illustrates the fields and controls on the Scan Asset page - Work Orders.

The screenshot shows the 'Scan Asset' interface with the 'Work Orders' tab selected. The asset description is 'Gas/elec car - fleet vehicle 2'. Two work orders are listed below, each with a list of fields including ID, description, start/completed dates, type, status, approval, and responsibility.

Work Order ID	Description	Required Start	Completed Date	WO Type	WO Status	Approval Status	PM Schedule ID	Responsibility
000000002	Replace coolant in vehicle	06/10/2005	06/12/2005	Corrective Maintenance	Closed	Approved		Wong, Kim
000000013	Replace alternator belt, battery cable, and install new battery	06/10/2005	06/12/2005	Corrective Maintenance	Closed	Approved		

Scan an asset barcode to retrieve general information, preventative maintenance schedules, and work orders associated with the asset. Asset information displayed on this page is retrieved from Asset Repository.

The Scan By toggle switch is displayed based on the value entered in the Installation Options - Asset Management page. For details see “Setting Up Application-Specific Installation Options” (Application Fundamentals)

Select the **Assets** tab to view general information about the asset. Hazardous assets, warranties, and asset hierarchies are indicated with icons when an asset has that attribute.

Select the **PMs** tab to view preventative maintenance schedules for the asset. Upcoming maintenance is indicated with an icon when an asset has that attribute.

Select the **Work Orders** tab to view work orders associated with the asset.

Note: You cannot edit asset information on this page. If an asset does not have preventative maintenance or work orders associated with it, the related tabs are disabled.

Scan By Location Page

Use the Scan By Location (PI_SCAN_LOC_FL) page to scan assets within a specific location and area ID to build an audit history for assets in that location.

Navigation:

Fluid Home > Asset Tracking > Select the Scan By Location tile.

This example illustrates the fields and controls on the Select Scan Location page.

The screenshot shows a mobile application interface titled "Select Scan Location". At the top right, there is a three-dot menu icon. The main content area contains the following elements:

- Scan Location:** A text input field containing "US001" with a magnifying glass icon to its right. To the right of this field, the text "USA - New York" is displayed.
- Scan Area ID:** A text input field containing "PARKING A" with a magnifying glass icon to its right.
- Force Asset Location Update:** A toggle switch currently set to "Yes".

At the bottom center of the screen, there is a green button labeled "Done".

This example illustrates the fields and controls on the Select Scan Location page. You can find definitions for the fields and controls later on this page.

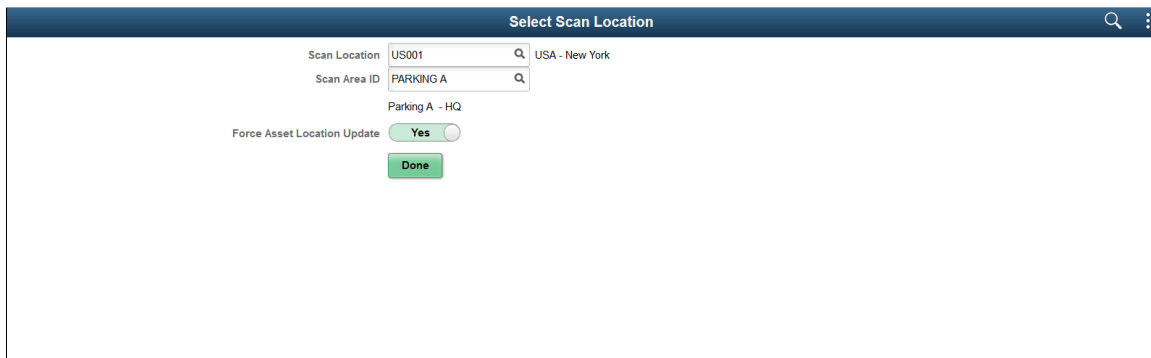

Select a location for the **Scan Location** field.

When an asset's location differs from the scan location, you can use the **Force Asset Location Update** toggle button to update the asset location and area ID. When set to 'Yes,' the system inserts an effective dated location and area ID record into the ASSET_LOCATION table. Location attributes are also stored in the PI_SCAN_HIST table. In addition, the system creates comments in the ASSET_COMMENTS table. The user can view the comments in the Basic Add Asset Comment page.

Select **Done** to retrieve a list of assets associated with the specific location and area ID.

This example illustrates the fields and controls on the Scan By Location page.

Scan By Location

Scan Location US001 USA - New York
Scan Area ID PARKING A
Parking A - HQ

Force Asset Location Update Yes

Update Other BU No

Scan Tag



This example illustrates the fields and controls on the Scan By Location Page. You can find definitions for the fields and controls later on this page.

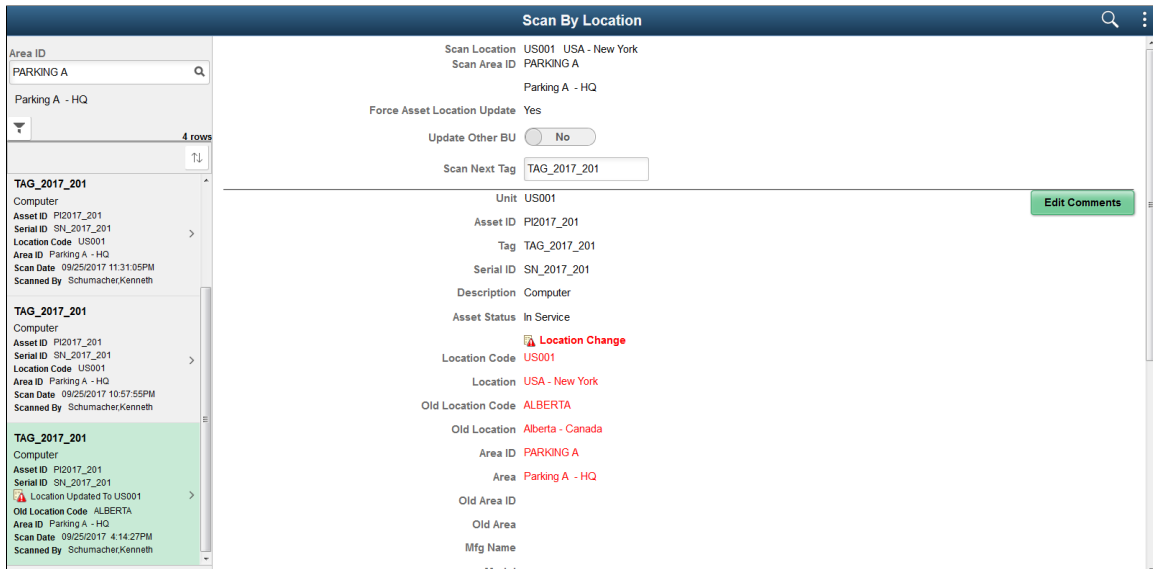

Enter a valid tag number. The system displays the old and new location as well as the old and new area ID.

Select **Edit Comments** to edit comments for the asset.

This example illustrates the fields and controls on the Edit Comments. You can find definitions for the fields and controls later on this page.



Make the required modifications to the comment displayed and save your changes.

You can view the new location, area ID, and asset comments on the Basic Add - Location/Comments/Attributes page.

For information about Basic Add - Location/Comments/Attributes page, see [Location/Comments/Attributes Page](#).

Find Asset Page

Use the Find Asset (AM_FIND_ASSET_FL) page to retrieve information for assets without scanning a barcode.

Navigation:

Fluid Home > Asset Tracking > Select the Find Asset tile.

Find Asset page

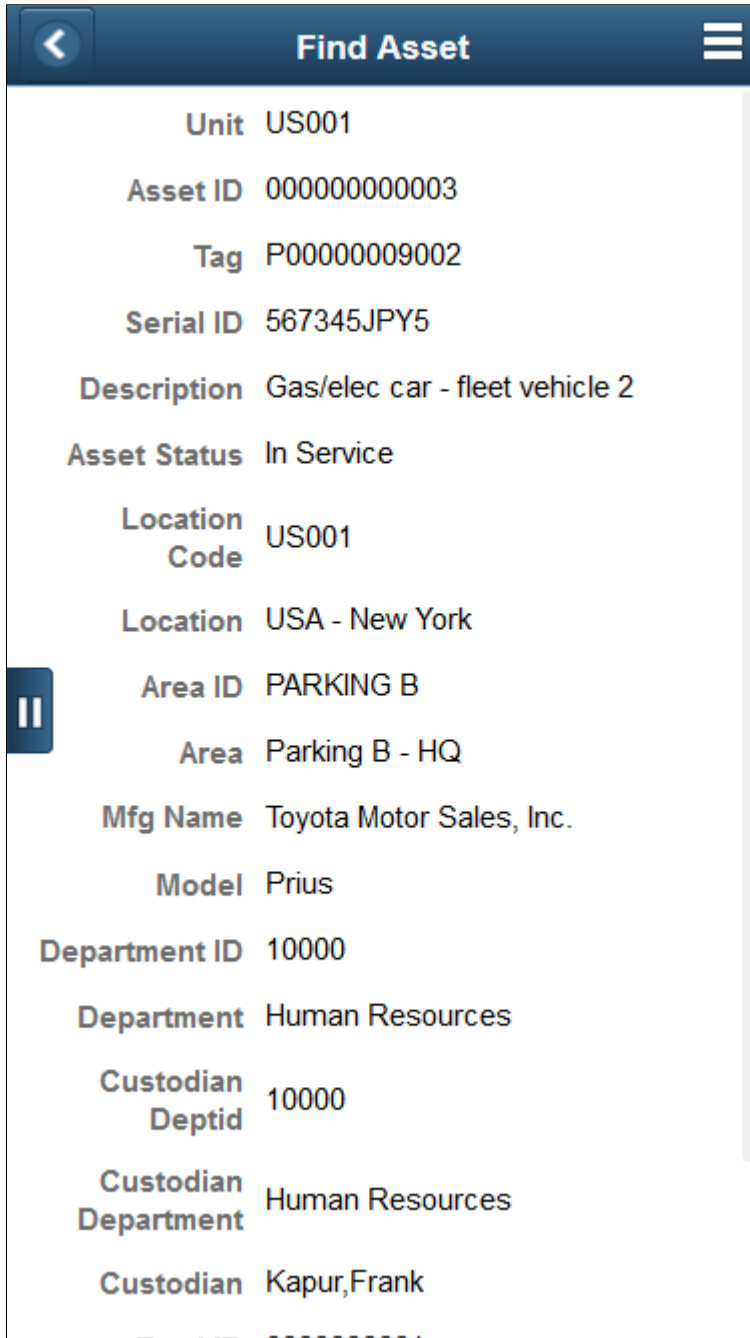

Enter search parameters, such as **Business Unit**, **Asset ID**, or **Location**, and select **Search** to retrieve information for scanned assets. Asset information displayed on this page is retrieved from the Asset Repository.

Scan Scope List Pivot Grid

Use the Scan Scope List pivot display to view the status of Physical Inventory IDs in progress and the list of assets scanned.

Navigation:

Select the **Scan Scope List** tile on the Asset Tracking Home page.

This example illustrates the fields and controls on the Scan Scope List Pivot Grid.

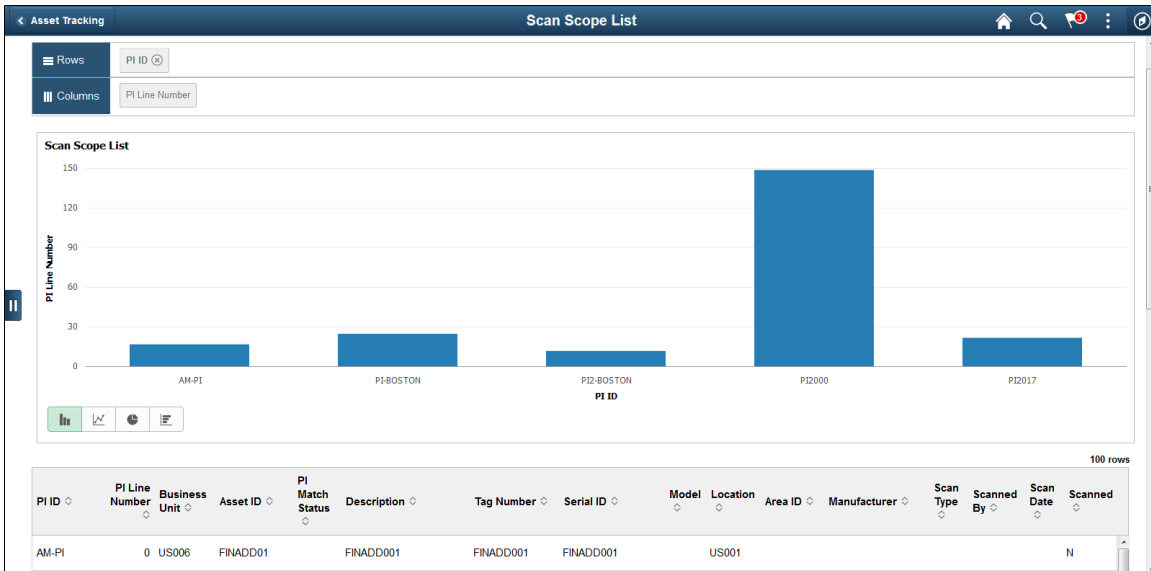

Scan Duplicate Tag Pivot Grid

Use the Scan Duplicate Tag pivot display to identify the assets with duplicate tags.

Navigation:

Select the **Scan Duplicate Tag** tile on the Asset Tracking Home page.

This example illustrates the fields and controls on the Scan Duplicate Tag pivot grid.

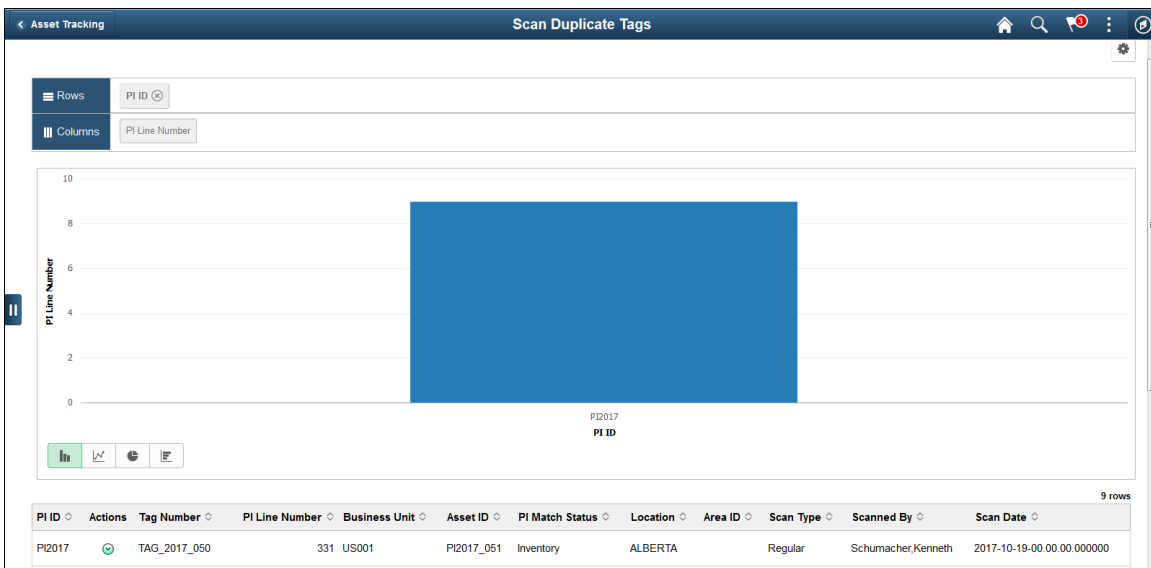

<i>Field or Control</i>	<i>Description</i>
 Related Actions Icon	Select this icon to navigate to the Verify Duplicate Tags page to verify duplicate tags. You can make changes to the tag number and save the changes.

Scan Results Pivot Grid

Use the Scan Results pivot display to review the matching results and take the necessary actions.

Navigation:

Select the **Scan Results** tile on the Asset Tracking Home page.

This example illustrates the fields and controls on the Scan Results pivot grid.

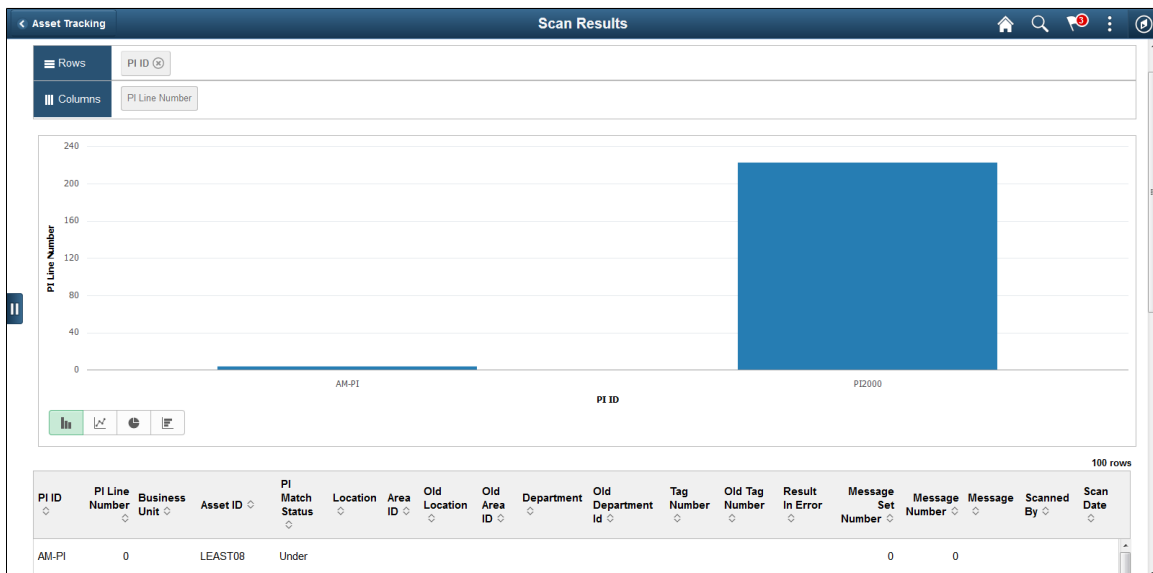

<i>Field or Control</i>	<i>Description</i>
 Related Actions Icon	Select this icon to navigate to the Review Matching Results page and to review and make changes to the scan result.

Scan History Pivot Grid

Use the Scan History pivot display to browse Scan History Audit trails.

Navigation:

Select the **Scan History** tile on the Asset Tracking Home page.

This example illustrates the fields and controls on the Scan History pivot grid.

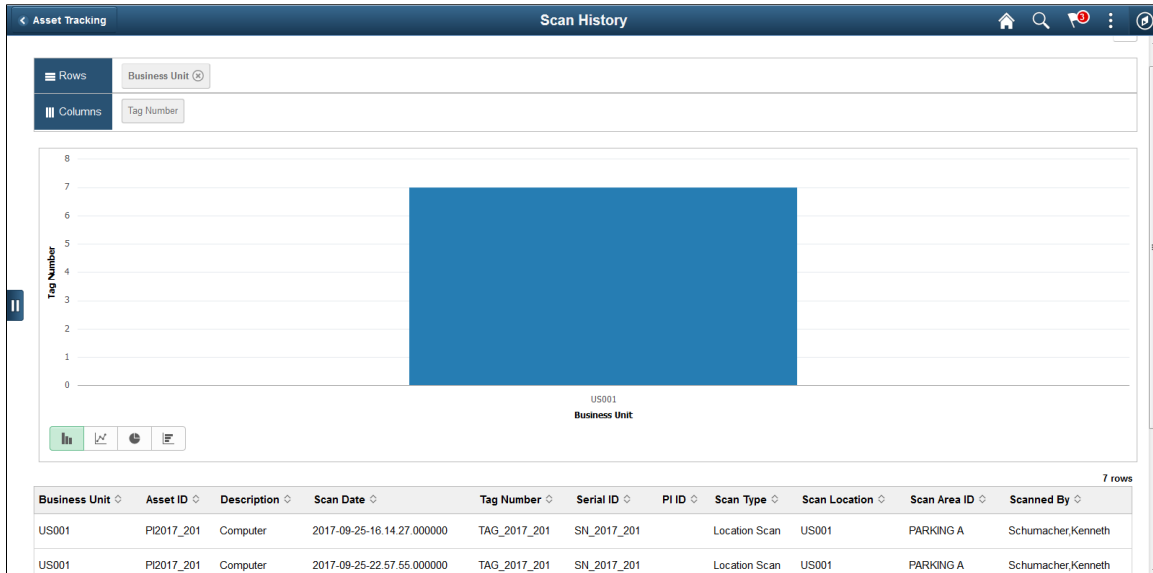

Asset Transactions Page

Use the Asset Transactions page (AM_SS_ASSETS_FL) to perform asset physical transfer and asset retire transactions.

Navigation:

Fluid Home > Asset Tracking > Asset Transactions tile

This example illustrates the fields and controls on the Asset Transactions page. You can find definitions for the fields and controls later on this page.

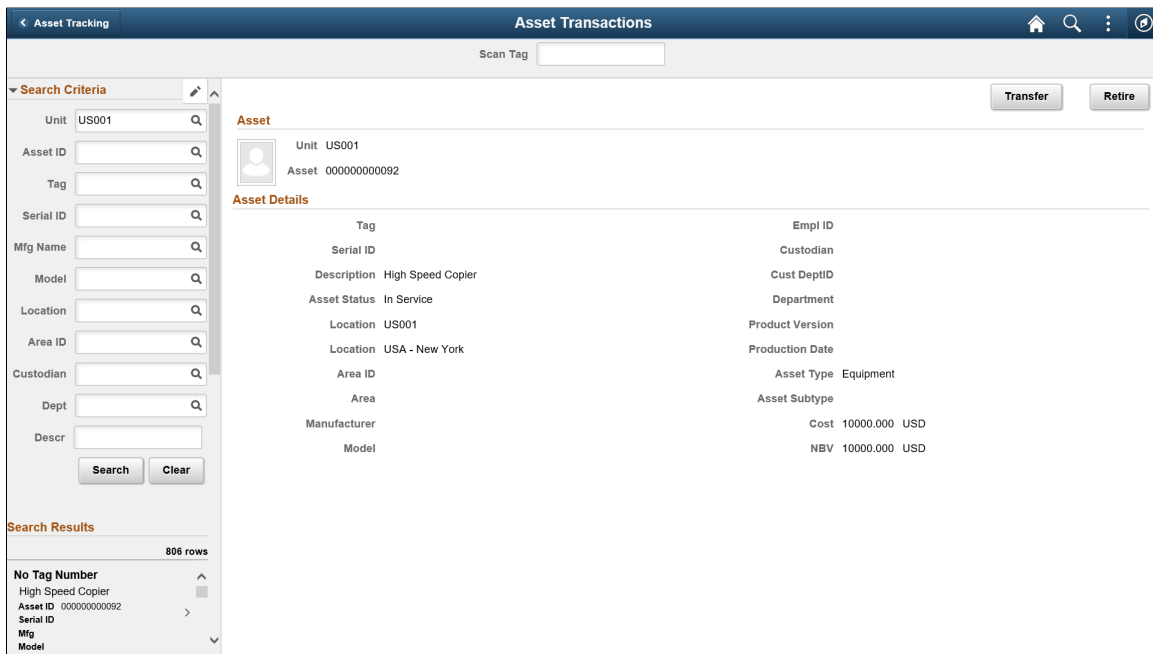

Field or Control	Description
Search Criteria	Enter the search criteria to perform manual search for assets, if an asset tag cannot be scanned. View the details and perform the transfer or retire transaction as required.
Edit icon	Select to configure the search criteria. The Edit option is available only in large form factor.
Scan Tag	Scan the tag number of the asset to view the details and perform the transaction.
Transfer	Select the Transfer button to navigate to the Asset Physical Transfer page. The page allows you to review the asset and transaction details, and modify the asset transfer location and custodian details if required.
Retire	Select the Retire button to navigate to the Asset Retire page to perform the asset retire transaction.

This example illustrates the fields and controls on the Asset Physical Transfer page. You can find definitions for the fields and controls later on this page.

The screenshot shows the 'Asset Physical Transfer' page. At the top, there is a navigation bar with 'Asset Transactions' and 'Asset Physical Transfer'. Below this, there is a 'Submit' button. The main content area is divided into sections: 'Asset' (Unit: US001, Asset ID: 000000000092, Tag Number, Serial ID, Description: High Speed Copier), 'Transaction Details' (Transaction Date: 01/23/2019), 'New Value' (Location: USA - New York, Area ID, Cust Dept, Custodian, EmpID), and 'Current Value' (Location: USA - New York). There are also 'Comments and Attachments' sections at the bottom.

Field or Control	Description
New Value	Modify the existing field value or select new values.
Current Value	Displays the existing values for comparison purposes.

Field or Control	Description
Comments and Attachments	Enter comments and add attachments about the transaction, if any.
Submit	Select the Submit button to proceed with the transaction.

During the Asset physical transfer approval process, the approvers can review the new values. After the final approval, the asset details display the new values.

See [Pending Approvals - Asset Physical Transfer page](#).

This example illustrates the fields and controls on the Asset Retire page. You can find definitions for the fields and controls later on this page.

The screenshot shows the 'Asset Retire' page with the following fields and controls:

- Asset Section:** Unit US001, Asset ID 000000000092, Tag Number, Serial ID, Description High Speed Copier.
- Transaction Details Section:** Trans Date 01/23/2019, Acctg Date 01/23/2019, Retirement Type Retirement by Sale.
- Comments and Attachments Section:** A text input field for comments and an 'Attachments (0)' button.
- Submit Button:** A green button labeled 'Submit' in the top right corner.
- Navigation Bar:** Includes icons for home, search, and refresh.

Review the details and modify them if required, and submit for approval. After final approval for Asset Retire transaction, you need to run the transaction loader to update the asset transaction tables.

See [Load into AM Page](#).

Working with Joint Venture Asset Processing

Understanding Joint Venture Processing

The Joint Venture Processing feature of PeopleSoft Asset Management enables you to accurately track finances when two or more business units share in the ownership of an asset or a group of assets. To use this feature, you must set up a Joint Venture Business Unit, identify business units that participate in the joint venture, and associate all of the business units with their respective equities.

The following graphic illustrates the relationship between a joint venture business unit and its participants. A joint venture business unit owns 100 percent of all joint venture assets. Participating business units are each assigned an equity percentage of the jointly owned assets. When you add, adjust, or retire an asset at the joint venture business unit level, similar transactions take place at the participant level, with cost and depreciation prorated according to each participant's equity percentage.

The following graphic illustrates the relationship between a joint venture business unit and its participants.

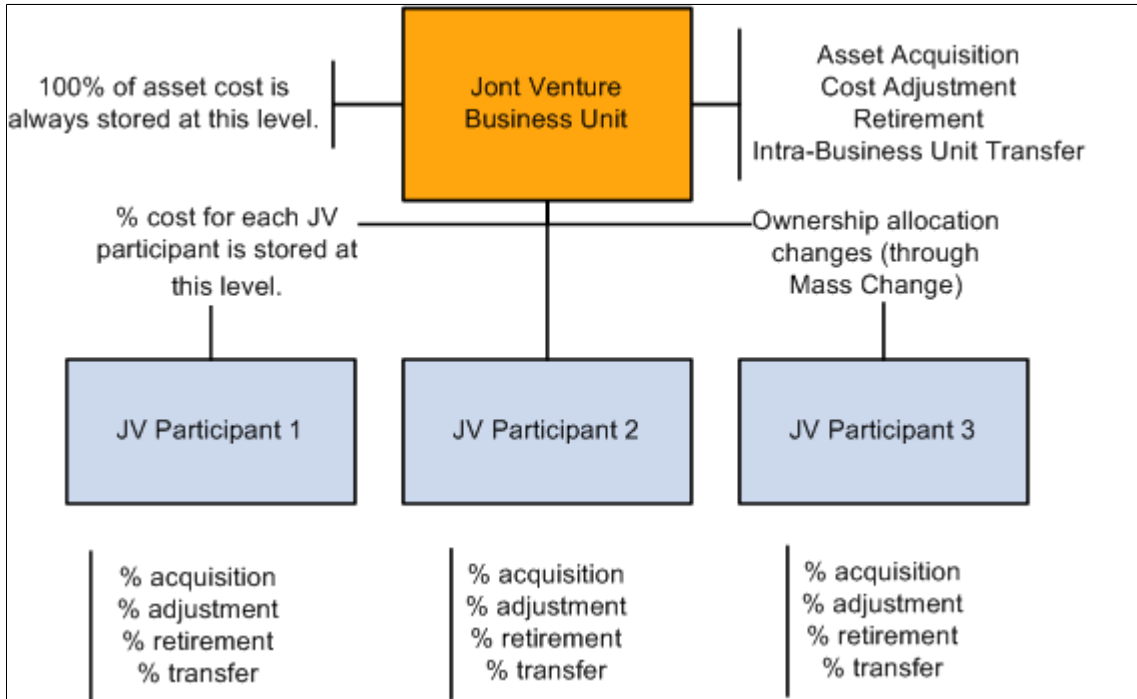

Equity percentages are defined in the Joint Venture Allocation table when you set up the PeopleSoft Asset Management tables. The sum of the participants' percentages must equal 100 percent. Equity percentages are allotted to participating business units according to the values you enter in the joint venture allocation table.

This allocation table sets up joint venture processing for Participants 1, 2, and 3, which own 60 percent, 20 percent, and 20 percent of the joint venture assets, respectively:

Business Unit	Percentage
Joint Venture Business Unit	100
Participant 1	60
Participant 2	20
Participant 3	20

Most transactions on joint venture assets are performed at the Joint Venture Business Unit level. These transactions are automatically performed at the participant level as well, with cost, fair market and depreciation information prorated based on each participant's equity percentage.

For example, asset ID JV00022 was entered for the Joint Venture Business Unit. With USD 10,000 of remaining value and USD 2,000 in accumulated depreciation, these assets are created based on the previous allocation table:

Unit	Asset ID	Book	Remaining Value	Accumulated Depreciation
Joint Venture Business Unit	JV000022	CORP	10,000	2,000
NA	NA	FEDERAL	10,000	2,000
Participant 1	JV000022	CORP	6,000	1,200
		FEDERAL	6,000	1,200
Participant 2	JV000022	CORP	2,000	400
		FEDERAL	2,000	400
Participant 3	JV000022	CORP	2,000	400
		FEDERAL	2,000	400

Adds, Adjusts, and Retirements must take place at the Joint Venture Business Unit level. Changes in ownership allocation—such as additions and deletions of participants and reallocations of equity percentages—must be made at the Joint Venture Participant level.

Prerequisites for Joint Venture Processing

Joint Venture Processing requires setup steps that you need to follow to use this feature. These steps must be completed in the correct order so that subsequent options are available for selection.

To set up joint venture processing:

1. Select **Set Up Financials/Supply Chain > Install > Installation Options > Asset Management** and select the **Joint Venture Processing** check box on the Installation Options - Asset Management page.
2. Select **Set Up Financials/Supply Chain > Business Unit Related > Assets > Asset Management Definition** and define at least one Joint Venture Business Unit on the PeopleSoft AM Business Unit Definition page.

The option to define a Joint Venture Business Unit is active only if you enabled Joint Venture Processing in step 1.

3. Create one business unit for each participant in the joint venture relationship to establish Joint Venture Processing.

These are standard business units and there are no additional steps to perform. Profiles for joint venture participant business units must have the same Profile ID as the joint venture business unit.

4. Associate the Joint Venture Participants with a particular Joint Venture Business Unit and define the percentage of asset ownership allocated to each participant to complete the last step in establishing Joint Venture Processing.

Do this by setting up a Joint Venture Allocation table for each Joint Venture Business Unit.

Related Links

“Understanding Asset Management Business and Cash Generating Units” (Asset Lifecycle Management Fundamentals)

Adding and Maintaining Joint Venture Assets

Most transactions on joint venture assets are performed at the Joint Venture Business Unit level. These include asset acquisitions, cost adjustments, retirements, and intrabusiness unit transfers (for example, transfers from one department, product, project, or category to another within the same business unit).

Note: InterUnit transfer of joint venture assets is not available or supported.

Joint venture asset transactions are executed just as they are for any non-joint venture asset with no special steps to take. However, it is recommended that you establish a naming convention to distinguish assets that are shared by a joint venture. For example, you might assign a joint venture asset an asset ID that begins with the letters *JV*.

Joint venture asset transactions are automatically executed at the participant level as well, with cost and depreciation information prorated based on each participant's equity percentage. Acquisition detail

table entries are not prorated. Any change in the ownership allocation of joint venture assets (ownership transfers) must be performed at the joint venture participant level.

Changing Ownership Allocations for Existing Joint Ventures

You must define and run a mass transaction to change the ownership allocation of assets in an existing joint venture. The Joint Venture Allocation table affects only newly added assets, which means that changes made to the allocation table do not affect existing joint venture assets.

Additions and deletions of participants and reallocations of equity percentages are recorded as sales transactions. This results in either a gain or a loss on the part of the selling participant. The value of the sale proceeds for the selling participants is recorded as the capital cost incurred by the buying participants.

PeopleSoft Asset Management processes these changes by retiring some portion of the equity percentage from the selling participant (to calculate gain/loss) and then transferring percentages between business units until the desired ownership ratio is achieved. The mass transaction transfers an established amount of the asset cost and quantity from one business unit to another (a one-to-one transfer). Because of this, you may need to run the mass transaction multiple times (up to the number of participating business units minus 1) to effect the desired change. For instance, if you have three original participants and want to add another, you might run the mass transaction three times: between business units 1 and 4, 2 and 4, and 3 and 4.

Defining a Mass Transaction for Joint Venture Processing

To change the ownership allocation of assets in an existing joint venture, PeopleSoft Asset Management is delivered with these joint venture mass transactions:

Mass Transaction	Description
<i>JVA-Joint Venture BU Addition</i>	Adds a joint venture participant.
<i>JVP-Joint Vent BU Add (w/Prof)</i>	Adds a joint venture participant using book values from the new business unit's profile ID.
<i>JVR-Joint Venture BU Removal</i>	Removes a joint venture participant.
<i>JVT-JV Allocation Change</i>	Transfers the allocation percentages for a joint venture from one business unit to another.

Note: After you run these changes, it is a good idea to update the allocation table to reflect the new equity percentages. Joint venture mass transactions do not affect Joint Venture Allocation tables, and you must change these tables to reflect the updated joint ventures.

In addition to selecting the appropriate mass transaction, make other selections that are specific to joint venture processing. PeopleSoft Asset Management requires a **Transaction Date** and an **Accounting Date**.

Depending on the joint venture mass transaction you select, you may also need to select a set of default values for some or all of these fields:

Field or Control	Description
Joint Venture Business Unit to Add to	Value is inserted into INTFC_FIN table.
Percentage of Cost	Enter a decimal value—for example, enter 0.50 for 50 percent.
Disposal Code	Choose a disposal code from the available options. Disposal codes are fully described in Retiring Assets.
Total Proceeds	Enter 0 if there are none.
Percentage of Quantity	Enter a decimal value—for example, enter 0.50 for 50 percent.
Total Removal Cost	Enter 0 if there is none.
Retirement Type	Enter either Extraordinary or Ordinary to indicate how the gain or loss that results from a retirement should be reported. This is for information only.
Retirement Convention	Select a retirement convention. This indicates how depreciation will be calculated through retirement.
Voluntary/Involuntary	Enter either Voluntary or Involuntary to indicate the reason for a retirement. This is for information only.

See [Understanding Mass Transaction Manager](#).

Adding a Joint Venture Participant

The Mass Transaction application engine program adds a joint venture participant business unit to an existing joint venture and performs these additional functions:

- Retires an established percentage of cost and quantity from one business unit and its books by using the defaults you specify for the retirement.
- Adds the same percentage of cost and quantity to the new business unit and its books by using the proceeds you specify for the retirement.

Use the mass transaction *JVA-Joint Venture BU Addition* to add a joint venture participant. If you want to use book values from the profile ID of the new participant business unit, use the *JVP-Joint Vent BU Add (w/Prof)* mass transaction.

Note: Before adding a business unit to an existing joint venture, that business unit must be fully established.

Removing a Joint Venture Participant

When Mass Transaction removes a joint venture participant business unit from an existing joint venture, it also performs these functions:

- Retires the total cost and quantity from one business unit and its books, using the defaults you specify for the retirement.
- Adds that cost and quantity to another business unit and its books, using the proceeds you specify for the retirement.

Use the mass transaction *JVA-Joint Venture BU Removal* to remove a joint venture participant.

Changing Joint Venture Ownership Allocations

When the Mass Transaction process changes ownership allocations for an existing joint venture, it also performs these functions:

- Retires a percentage of the cost and quantity from one business unit and its books, using the defaults specified for the retirement.
- Adds that same percentage of cost and quantity to another business unit and its books, using the proceeds specified for the retirement.

Use the mass transaction *JVT-JV Allocation Change* to change joint venture ownership allocations.

Loading Joint Venture Transactions

After you run a joint venture mass transaction, use the Transaction Loader to load results of the mass transaction into the PeopleSoft Asset Management tables.

See “Running the Transaction Loader” (Asset Lifecycle Management Fundamentals).

Chapter 18

Processing Asset Depreciation

Prerequisites

Before you begin to depreciate assets, you must set them up with required depreciation attributes.

You must set up the following attributes:

- Depreciation method.
- Prorate convention.
- Depreciable basis.
- Estimated useful life.
- Placed-in-service date.

See “Understanding Asset Management Business and Cash Generating Units” (Asset Lifecycle Management Fundamentals).

See “Setting Up Asset Profiles” (Asset Lifecycle Management Fundamentals).

See “Understanding Depreciation Processing” (Asset Lifecycle Management Fundamentals).

See [Adding and Maintaining Asset Information](#).

Understanding Depreciation Processing

PeopleSoft Asset Management can calculate depreciation for more than 18,000 different scenarios, depending on the depreciation attributes that you select. Most standard depreciation methods and prorate conventions are delivered, along with functionality for you to define your own depreciation methods and prorate conventions. In the United States, PeopleSoft Asset Management calculates tax credits and tax credit recapture. Standard depreciation reports are provided, as well as reports that enable you to comply with the U.S. Tax 40% Rule, the U.S. Alternative Minimum Tax (AMT), and the U.S. Adjusted Current Earnings (ACE). Outside the U.S., PeopleSoft Asset Management provides depreciation methods that are commonly used in Europe, Australia, India, and Japan, as well as other methods that are used globally.

PeopleSoft Asset Management calculates the annual depreciation based on the asset's life, depreciable cost basis, placed-in-service date, and any depreciation limits that you specify. You can set up required depreciation attributes on three levels: You can enter them in your business unit books, define them when you set up asset profiles, or specify them when you add assets to the system.

When you set up your business unit books, specify whether each book is a financial book, a tax book, or a financial book with tax information. This specification acts as a filter, enabling you to select options that correspond to the book type that you specified. For example, if you define a book as a tax book in

the U.S., PeopleSoft Asset Management does not allow you to select depreciation attributes that are not supported by U.S. federal tax code.

Asset profiles function as templates. They provide a quick way to enter asset information, especially depreciation criteria. Rather than enter the book, method, convention, life, and tax credit information each time that you add an asset, you can use the asset profile to supply that information by default. When you enter assets, specify the profile ID. If any depreciation information in the profile does not apply, you can override it.

You can also specify depreciation attributes as you add assets to PeopleSoft Asset Management. Do this if the asset profile does not contain the depreciation criteria that you want for the asset. If you use more than one book, specify the depreciation criteria for each book.

To ensure correct depreciation processing, the PeopleSoft detail calendar that you use must include at least five years prior to the life of the oldest asset. For example, if the life of the oldest asset began on January 1, 2000, your calendar must begin no later than January 1, 1995. These prior periods are required for correct depreciation processing.

Build detail calendars beyond the end depreciation date of the asset as well. When you do this, the system calculates depreciation over the longer period correctly for any added assets that have a longer than usual service life. If any short tax years are contained within this five-year period, create a calendar of more than five years to ensure correct depreciation.

If you use a depreciation method that relies on tables specifying the percentage of depreciation that is expensed for each period, review the delivered depreciation schedules. If you use depreciation schedules that are different from those delivered, you must add a schedule with the appropriate percentages for each in-service period for each year of life.

PeopleSoft Asset Management provides all standard prorate conventions. In addition, it enables you to build new conventions based on calendars and to copy conventions from one SetID to another as appropriate.

Note: PeopleSoft Asset Management enables you to change both depreciation conventions and schedules as you deem necessary. If you change either the schedule or convention, you get a warning that the convention and the schedule do not agree. When you save your change, PeopleCode changes the convention or the schedule for you. The depreciation will calculate correctly whether you enter a change to schedule or convention and in either order.

Steps for Processing Depreciation

Follow these steps to process depreciation:

1. Run the Depreciation Calculation Application Engine process (AM_DEPR_CALC).
2. Review open transactions.
3. Change depreciation attributes and expand periods as needed.
4. Review the depreciation processing results for errors.
5. Create pending depreciation transactions.
6. Create period depreciation accounting entries.

When you have completed processing depreciation, you must go on to create accounting entries for the period depreciation. Before you create any accounting entries, check the processing options to determine whether the system runs processes automatically or whether you must schedule processing.

To create period depreciation accounting entries:

- Determine which periods are open to ensure that depreciation is expensed to the correct period.

To verify periods, use the Establish Business Units component, and access the Asset Management Definition page. Click the **Update Open Periods** link to review open and closed periods on the Open Period Update page.

If the open periods show that the current accounting period is open, you can create period depreciation accounting entries. If not, you must close the prior period manually and open the current period before creating period depreciation accounting entries.

- Account for any depreciation that is allowed for time during which an asset was not established in PeopleSoft Asset Management.

When you acquire assets (or place assets in service) during one accounting period but add them to PeopleSoft Asset Management during a different accounting period, you need to account for any depreciation that is allowed for the time during which the asset was not established in PeopleSoft Asset Management. You can do this by adjusting the transaction and accounting dates.

Typically, the transaction date represents the date that you actually acquired the asset and the accounting date represents the date that you begin expensing depreciation. The accounting date is validated against the open periods for PeopleSoft Asset Management that are stored in the FIN_OPEN_PERIOD table to determine the period to which it is expensed. The difference between the transaction date and the accounting date determine whether any prior period depreciation needs to be calculated. For example, suppose that a computer was acquired and placed in service on March 15, 2005, but the information was not entered into PeopleSoft Asset Management until August 1, 2005. All periods prior to August are closed. PeopleSoft Asset Management automatically calculates depreciation starting in March, and it reflects this depreciation in the August period. When period depreciation accounting entries are created for August, they will reflect all depreciation activity since March.

Note: This is the only time life-to-date calculations take place without being selected.

- Create accounting entries for the amount that you enter during the *Add* process for assets with accumulated depreciation.

When you add an asset with accumulated depreciation, you can create accounting entries for the amount that you enter during the Add process. When the asset has been added, accumulated depreciation is updated each time that you create new period depreciation accounting entries.

- Set up the depreciation allocation calendar.

The amount of depreciation that you can expense for each period depends on how you set up your calendar. You can define the periods as months. When you set up your calendar, specify the year, the number of periods in each year, the beginning and ending date of each period, and the name of each period. For example, if you use a monthly calendar, the first period might be called January or April.

You also specify the portion of depreciation to be allocated for each period. For example, if you use a monthly calendar, you can specify that 1/12 of the annual depreciation amount is allocated to each period.

- Close accounting periods.

When you have created accounting entries for depreciation for an accounting period, you must close it.

Related Links

[Understanding Asset Information Flow](#)

[Run Depreciation Close Process Page](#)

“Understanding Asset Management Business and Cash Generating Units” (Asset Lifecycle Management Fundamentals)

Understanding Depreciation of Group Assets

Group assets are treated differently from regular assets for depreciation purposes. Before you run depreciation on group assets, you must run a process that consolidates group member asset cost information at the group level. Then, you can depreciate group assets using the Group Asset Depreciation Calculation page. PeopleSoft Asset Management supports only the flat-rate depreciation method for group assets.

Related Links

[Understanding Group Asset Processing](#)

Processing Depreciation

This topic provides an overview of processing depreciation.

Pages Used to Process Depreciation

<i>Page Name</i>	<i>Definition Name</i>	<i>Usage</i>
Depreciation Calculation Page	RUN_AMDPCALC	Run the Depreciation Calculation process.

Page Name	Definition Name	Usage
<u>Open Transaction Detail Page</u>	OPEN_TRANS_DETAIL	Review detailed information about an open transaction. You can view open tax transactions by using the same process when you select Asset Management > Taxes > Reports > Review Open Tax Transactions > Open Transactions-Tax.
<u>Depreciation Process Log Page</u>	AM_ERROR_LOG	Review depreciation processing results for errors.

Understanding Depreciation Processing

You must run depreciation to account for every transaction that you perform on an asset. For example, when you transfer an asset, you may need to run depreciation to correctly reflect the new department that is using the asset. For some transactions (including adjustments, transfers, and recategorizations), the depreciation calculation process moves the stored depreciation amounts from department to department or category to category, depending on the transaction that you are performing and the ChartFields that you specify.

Depreciation Calculation Page

Use the Depreciation Calculation page (RUN_AMDPCALC) to run the Depreciation Calculation process.

Navigation:

Asset Management > Depreciation > Processing > Calculate Depreciation > Depreciation Calculation

Field or Control	Description
Unit	Select a business unit from which to select a book or range of assets.
Book Name	Select a book to further narrow the assets to be included in processing.
From Asset ID and To Asset ID	Enter a range of assets to include in processing.
Process Frequency	Select the frequency for the process from these values: <i>Always</i> <i>Don't</i> <i>Once</i>

Field or Control	Description
Delete Stage Row	Select the staged rows to delete: <i>All</i> <i>Current</i> <i>No</i>

Note: Accumulated depreciation for group member assets is loaded at the member asset level.

See “Configuring Temporary Tables for Background Processing” (Asset Lifecycle Management Fundamentals).

Open Transaction Detail Page

Use the Open Transaction Detail page (OPEN_TRANS_DETAIL) to review detailed information about an open transaction.

Navigation:

Asset Management > Depreciation > Open Transactions > Review Open Transactions > Open Transaction Detail

You can review open transactions broadly—for example, by searching for them by business unit. Review open transactions more specifically by including more criteria in your search.

Open Transaction Searches

Use broad or narrow search criteria to identify a list of open transactions. In addition to business unit, you can specify asset identification, asset book name, transaction date, or accounting date. Alternatively, you can specify the action type of a pending transaction. Also, each open transaction can have a status, which you can use to further narrow the search criteria.

Actions of Open Transactions

Each pending transaction can have an action type associated with it. The following list shows the action types that are available:

- Asset Addition
- Asset Cost Adjustment
- Asset Recategorization
- Asset Reinstatement
- Asset Retirement
- Asset Transfer
- Book Adjustment

- Budgeted Depreciation
- Budgeted Lease Payments
- Depreciation
- Inflation Adjustment
- Lease Payment
- Manual Reserve Adjustment
- Prior Period Depreciation
- Resume Depreciation
- Retro Rate Change for Group Assets
- Suspend Depreciation

Depreciation Calc Status

<i>Field or Control</i>	<i>Description</i>
Completed Depreciation	Depreciation has been calculated for the transaction.
Held For Transfer In	When you process interunit transfers, PeopleSoft Asset Management processes the out and in transactions at the same time. This status indicates that the transaction is being held until its corresponding transfer-out can be processed.
Never Calculate Depreciation	The Depreciation Calculation process never includes the transaction.
Pending Depreciation	Depreciation has not yet been calculated for the transaction.
In Processing	Depreciation calculation is processing.

Acctg Entry Creation Status

<i>Field or Control</i>	<i>Description</i>
Completed Distribution	The transaction has been sent to the general ledger.
Never Calculate Distribution	The distribution process never includes the transaction.
Pending Distribution	The transaction has not yet been sent to the general ledger.

Reporting Process Status

The reporting process status reflects the status in connection with the depreciation reporting table.

Field or Control	Description
Completed	The transaction has been uploaded to the depreciation reporting table.
Never	The transaction will not be processed.
Pending	The transaction has not yet been uploaded to the depreciation reporting table.

Group Consolidation Status

Field or Control	Description
Completed Sum Composite	The summarization process has been completed on the transactions for group member assets.
Grouped Composite	The asset is a group asset.
Member Depreciation	A book change has been made on a group member (such as changing its convention or in-service date).
Never Sum Composite	The transactions are never used by the summarization process.
Pending Sum Composite	The summarization process has not yet been completed on the transactions for group member assets.

When you have searched for all open transactions based on specified criteria, you can view particular open transactions in detail.

Changing Depreciation Attributes

PeopleSoft Asset Management enables you to change depreciation attributes as necessary. You may find it necessary to:

- *Change the effective date.*

Changing the effective date of depreciation attributes may become necessary to accommodate changes in tax law or company policy. You can set up anticipated changes for future use by effective-dating them. You can also affect prior periods by changing the effective date.

- *Change the depreciation limit.*

Changing the depreciation limits on assets may change the amount of depreciation that you can expense on an asset in a given year. This, in turn, changes the depreciation amount that is allocated to each period. If necessary, the life of the asset is extended to depreciate the asset fully.

- *Change the status.*

Asset depreciation status is book-specific. Therefore, an asset can be depreciable for one book and non depreciable for another. There is no limit to the number of times that an asset can have its depreciation suspended. Also, there is no limit on the length of time for which it can be suspended.

When you change the status of an asset from Depreciable to Nondepreciable, the system deletes future depreciation calculations. All transactions that are performed while the asset is suspended take into account only the depreciation that has occurred as of that time.

While an asset is in a suspended state (that is, has a status of Nondepreciable), you can still perform financial transactions on it. Those transactions generate appropriate accounting entries with a transaction date indicating when the transaction actually took place. Adjustments generate one accounting entry for the cost adjustment. Transfers generate two accounting entries—one for the cost transfer and one to transfer accumulated depreciation. Retirements generate accounting entries for cost, accumulated depreciation, and any gain or loss.

Note: You cannot perform interunit transfers on assets that have been suspended.

When you change a non depreciable asset to a depreciable asset, PeopleSoft Asset Management performs a remaining value calculation and calculates depreciation based on all depreciation parameters. The time during which depreciation was suspended is not taken into account against the asset's life.

See [Calculating Depreciation When Salvage Value Exceeds Net Book Value \(NBV\)](#).

Depreciation Process Log Page

Use the Depreciation Process Log page (AM_ERROR_LOG) to review depreciation processing results for errors.

Navigation:

Asset Management > Depreciation > Depreciation Process Log > Depreciation Process Log

You can review each processing instance for errors that may have occurred during processing. You can view the business unit, asset ID, and other information that is related to the error along with a message describing the problem. You can then correct the problem or continue.

Expanding Depreciation by Period

To maintain optimal table size and increase depreciation processing efficiency, store depreciation entries by fiscal year. However, if you need to store depreciation entries by period rather than by fiscal year, use the Expand Depreciation by Period page to expand fiscal year storage to period storage.

This topic discusses how to expand the depreciation period.

Page Used to Expand Depreciation by Period

<i>Page Name</i>	<i>Definition Name</i>	<i>Usage</i>
<u>Expand Depreciation by Period Page</u>	AMDPEXPD_RQST	Store depreciation entries by period. You can expand storage one fiscal year at a time.

Expand Depreciation by Period Page

Use the Expand Depreciation by Period page (AMDPEXPD_RQST) to store depreciation entries by period.

You can expand storage one fiscal year at a time.

Navigation:

Asset Management > Depreciation > Processing > Expand by Period > Expand by Period

Enter a fiscal year and process frequency. You can run the process for only one fiscal year at a time.

Run Options

<i>Field or Control</i>	<i>Description</i>
Unit Option	Select a business unit option, either <i>All</i> or <i>One</i> . If you select <i>One</i> , select a business unit in the field that appears.
Book Option	Select either <i>All</i> or <i>One</i> . If you select <i>One</i> , select a book name in the field that appears.
GRP Asset Opt (group asset option)	Select a book group asset option, either <i>All</i> or <i>Range</i> . If you specify a range, select values in the From Asset field and the To Asset ID field.

Creating Pending Depreciation Transactions

This topic discusses how to create open depreciation transactions.

Page Used to Create Pending Depreciation Transactions

<i>Page Name</i>	<i>Definition Name</i>	<i>Usage</i>
<u>Open Transactions - Create Page</u>	AMOPNTRNS_RQST	Run a process that creates open transactions.

Open Transactions - Create Page

Use the Open Transactions - Create page (AMOPNTRNS_RQST) to run a process that creates open transactions.

Navigation:

Asset Management > Depreciation > Open Transactions > Create Open Transactions > Create

Use this page to run a process that opens transactions. This is necessary when you have used the **Future Depr Years** (future depreciation years) option to limit depreciation calculations to a specific number of years rather than the asset's useful life. For example, if you had limited future depreciation years to two, and you were now entering the third year, you would run this process before running depreciation so that the depreciation calculations would account for all open transactions.

Run Options

Select an asset type. Options are:

<i>Field or Control</i>	<i>Description</i>
<i>All Assets</i>	Recalculates depreciation for all assets.
<i>Group Asset</i>	Recalculates depreciation for all group assets.
<i>Non Group Asset</i>	Recalculates depreciation for all assets except group assets.

Process Scheduler runs the Create Pending Depreciation Transactions (AMOPNTRNS) process at user-defined intervals.

Viewing Depreciation-Related Information

You can view depreciation-related information for both regular assets and parent-child assets online.

This topic discusses how to view asset and depreciation-related information.

Pages Used to View Depreciation-Related Information

Page Name	Definition Name	Usage
Asset Depreciation - Asset Page	DEPR_ALL_MAIN	View a summary of basic asset and depreciation information.
Asset Depreciation - Depreciation Page	DEPR_ALL_YEAR	For regular assets, calculate an asset's net book value and view its depreciation information for the year. For parent-child assets, calculate net book value. Depreciation information by year does not appear.
Asset Depreciation - Period Depreciation Page	DEPR_ALL_PERIOD	View depreciation for the periods that you specified when you entered the asset.
Child Assets Page	CHILD_ASSETS	Specify child assets to include in a parent asset's net book value calculation.

Asset Depreciation - Asset Page

Use the Asset Depreciation - Asset page (DEPR_ALL_MAIN) to view a summary of basic asset and depreciation information.

Navigation:

Asset Management > Depreciation > Review Depreciation Info > Asset Depreciation > Asset

This example illustrates the fields and controls on the Asset Depreciation - Asset page. You can find definitions for the fields and controls later on this page.

Asset Depreciation

[Related Content](#) | [New Window](#) | [Help](#) | [Personalize Page](#)

Asset
[Depreciation](#)
[Period Depreciation](#)

Unit	US001	Asset ID	00000000091	Automobile	Status	In Service
------	-------	----------	-------------	------------	--------	------------

Asset Information

Profile ID	AUTO	Automobile
Asset Class		
Tag Number		
Acquisition Code	P	
Acquisition Date	09/19/2003	

Book

<input type="checkbox"/> <input type="checkbox"/> <input type="checkbox"/> <input type="checkbox"/>	Q		<	<	1-2 of 2	>	>
Book	Description	Currency	Method	Convention			
1	CORP	Corporate	USD	Straight Line	FM		
2	FEDERAL	Federal	USD	Declining Balance w/SL	HY		

This example illustrates the fields and controls on the Asset Depreciation - Asset page with Book History related content.

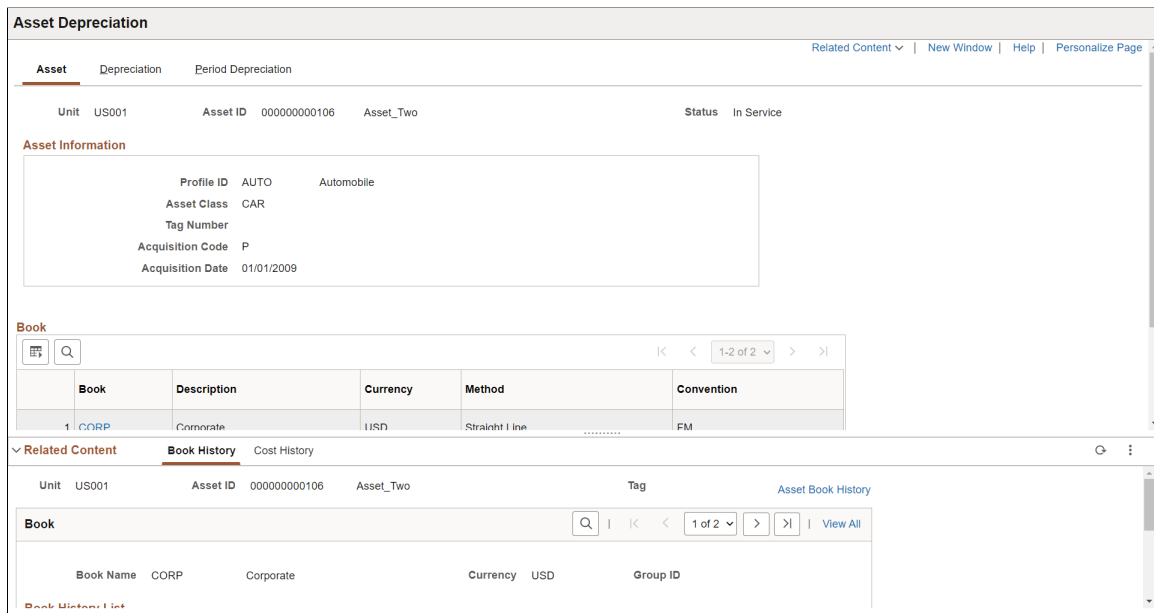

Field or Control	Description
Related Content	<p>Select the Related Content drop-down to view book or cost history information related to the asset. Related content displays below the transaction page in split-screen format.</p> <p>For information about cost and book history, see:</p> <ul style="list-style-type: none"> • Reviewing Asset Book History • Cost History Page <p>You can access related content from all the pages within the Review Depreciation component.</p> <p>To manage related content, see Working with Related Content in Asset Management.</p>

Parent assets that are created on the Parent Asset page (parent-only assets) do not have cost or basic information. They cannot be viewed in the Parent Child Basic Information component. Also, you cannot view them or perform transactions on them in the Asset Cost/Adjust Transfers component, the Asset Retirements component, or the Parent-Child NBV component.

If you want to use a parent asset as an umbrella asset for reporting purposes only and access these components to manipulate child assets in mass, create a zero-cost parent asset as opposed to a parent only asset. Also, to transact against parent and child assets at once, parent and child must use the same asset profile.

Asset Depreciation - Depreciation Page

Use the Asset Depreciation - Depreciation page (DEPR_ALL_YEAR) to for regular assets, calculate an asset's net book value and view its depreciation information for the year.

For parent-child assets, calculate net book value. Depreciation information by year does not appear.

Navigation:

Asset Management > Depreciation > Review Depreciation Info > Asset Depreciation > Depreciation

This example illustrates the fields and controls on the Asset Depreciation - Depreciation page. You can find definitions for the fields and controls later on this page.

This example illustrates the fields and controls on the Asset Depreciation - Depreciation page. You can find definitions for the fields and controls later on this page.

This asset has pending depreciation of some transaction

Yearly Depreciation

Year	Depreciation Amt	Oper Unit	Fund	Dept	Program	Class	Bud Ref	Product	Project	Category	Cos Typ
2003	400.00									AUTO	
2004	1,600.00									AUTO	
2005	1,600.00									AUTO	
2006	1,600.00									AUTO	
2007	1,600.00									AUTO	
2008	1,200.00									AUTO	

Field or Control	Description
Depr Status	<p>Displays the depreciation status of the asset.</p> <p>For a finance lease, during reclassification the underlying asset depreciation will be adjusted to reflect the change in the depreciation status. Also for lease reclassification from operating to finance and asset recategorization from non-depreciable to depreciable, depreciation is applicable for the leased asset.</p>

Field or Control	Description
Net Book Value	To calculate the net book value of the asset, enter values in the As Of Fiscal Year field and the Period field, and click the Calculate NBV (calculate net book value) button. The system displays the cost, salvage value, accumulated depreciation, and net book value for the selected asset, fiscal year, and accounting period.
Accum Amort	Displays the accumulated amortization amount. This value is displayed only for asset that has been reclassified. The amortization amount is considered for the calculation of net book value.
Operating Lease Asset Amortization	Click to open the Operating Lease Asset Amortization page. This page displays the operating asset's accumulated amortization details. The amortization schedule can be downloaded to the local system for further review and analysis.
Yearly Depreciation	Displays depreciation amounts by year through the last year of the asset's life.

Note: Yearly depreciation amounts are not shown for parent-child assets.

Asset Depreciation - Period Depreciation Page

Use the Asset Depreciation - Period Depreciation page (DEPR_ALL_PERIOD) to view depreciation for the periods that you specified when you entered the asset.

Navigation:

Asset Management > Depreciation > Review Depreciation Info > Asset Depreciation > Depreciation > Period Depreciation

This example illustrates the fields and controls on the Asset Depreciation - Period Depreciation page. You can find definitions for the fields and controls later on this page.

Get Period Depreciation

<i>Field or Control</i>	<i>Description</i>
Expense	Select to view depreciation expense for the year that is specified.
Accum (accumulated)	Select to view accumulated depreciation for the year that is specified.

Note: If you do not select **Expense**, but you do select **Accum**, only the amounts that affected accumulated depreciation appear. The system does not show the expense for that year. For example, when an asset is added with accumulated depreciation, no corresponding expense amount exists. If you do not select **Accum**, but you do select **Expense**, the system displays the amounts that affected the expense account, but not the accumulated depreciation for that year.

<i>Field or Control</i>	<i>Description</i>
Year	Select a year to display its period depreciation entries.
Get Period Depr (get period depreciation)	Click to have the system calculate depreciation that was allocated to each period for the year specified and display the information. You can change the period depreciation amounts. Note that when you modify the period depreciation, you change the depreciation method to manual depreciation.

Period Depreciation

Click the **Depr. Accum Adjustment** (depreciation accumulated adjustment) link to make adjustments to accumulated depreciation.

Note that if you perform two transfers on the same asset in the same accounting period (on the same set of ChartFields), the Asset Depreciation - Period Depreciation page displays only a *net* result of both transfers. For example, suppose that an asset with an actual month convention is added to department 12000 on August 31, 2006, with a cost of 10,000.00 JPY and a life of five years. On September 30, 2006, the asset is transferred to department 14000 using the same convention. The asset is then transferred again on the same day to department 21100. The Asset Depreciation - Period Depreciation page displays the following entries for the transfers:

```
12000 2006 8 DPR 166.66
12000 2006 9 TFR -166.66
21100 2006 9 TFR +166.66
```

No entry exists for the transfer in and out of department 14000 on the same day, as this is a net 0. Note, however, that the depreciation table has two additional rows for both transfer out and transfer in.

Child Assets Page

Use the Child Assets page (CHILD_ASSETS) to specify child assets to include in a parent asset's net book value calculation.

Navigation:

Asset Management > Asset Transactions > Parent-Child Relationship > Review Parent-Child NBV > Child Assets

Click the **Select All** button to include all child assets with the parent in the net book value calculation.

To include particular child assets, select the **Selected** check box for a row.

Field or Control	Description
Tag Number	Displays the tag that is assigned to the child asset. Parent and child assets can share the same tag number.
Description	Displays the child asset description.
Child Asset ID	Displays the asset ID that is assigned to the child asset.
Asset Status	Displays the asset status of the child asset.
Capitalized Asset	Indicates whether the child asset is capitalized or non capitalized.
Cost	Displays the cost of the child asset.

<i>Field or Control</i>	<i>Description</i>
Currency	Displays the currency in which child asset costs are stored.
Acq Date (acquisition date)	Displays the date that the asset was acquired.
In Service Date	Displays the In Service date of the child asset.
Asset Information	Click to open a new Asset page in the Asset Depreciation component. The page is populated with the child asset.

The **Include Parent Asset** check box is selected by default. Deselecting it enables you to calculate net book value at once for all or selected child assets while excluding the parent asset from the calculation.

Adjusting Accumulated Depreciation

This topic provides an overview of updating accumulated depreciation of assets.

Page Used to Adjust Accumulated Depreciation

<i>Page Name</i>	<i>Definition Name</i>	<i>Usage</i>
Adjust Accumulated Depreciation page	DEPR_ACCUM_ADJ	Make adjustments to accumulated depreciation.

Adjust Accumulated Depreciation page

Use the Adjust Accumulated Depr (DEPR_ACCUM_ADJ) page to make adjustments to accumulated depreciation for individual assets.

Navigation:

Asset Management > Depreciation > Processing > Adjust Accumulated Depr > Asset Depr Accum Adjustment

This example illustrates the fields and controls on the Adjust Accumulated Depr page.

Field or Control	Description
Unit	Displays the Business Unit of the selected asset.
Asset ID	Displays the Asset ID.
Status	Displays the status of the asset.
Trans Date	Enter the Transaction date for which the accumulated depreciation needs to be updated.
Acctg Date	Enter the Accounting date for which the accumulated depreciation needs to be updated.
Trans Code	Enter a transaction code that identifies special asset transactions that are used in combination with actions to create accounting entries. You can modify these codes by changing the description and short description. The transaction code associated with revaluation displays revaluation related distribution types for additions.
Depr Accum Adjustment	Enter the accumulated depreciation for the required chartfield.
Year to Date Depr Adjust	Enter the year to date depreciation adjustment amount for the required chartfield.

After saving the page, click the **Asset Depreciation** link to view the adjustment.

Note: Each book must be adjusted separately. If multiple books are associated with the same ledger group with KLS (Keep Ledgers in Sync) activated, the adjustment amount is converted and copied from the primary book to the secondary books if no adjustment amounts are entered in the secondary book.

Use the spreadsheet asset data import feature for adjusting accumulated depreciation for multiple assets at once. For more information, see the [Adjusting Accumulated Depreciation of assets Using the Delivered Spreadsheet Template](#) section of the [Importing Asset Transaction Data by Spreadsheet](#) topic.

After adjusting accumulated depreciation, run the depreciation calculation process. For more information, see the [Processing Depreciation](#) topic.

Running Depreciation Reports

This topic provides an overview of depreciation reports and discusses how to load the depreciation reporting table.

Pages Used to Run Depreciation Reports

<i>Page Name</i>	<i>Definition Name</i>	<i>Usage</i>
Depreciation Reporting Table Page (Depr Reporting Table Page)	AMDPREPT_RQST	Load the Depreciation Reporting table (PS_DEPR_RPT). Use this table for all depreciation reports.
Depreciation by Period	RUN_AMDP2200	Run the Depreciation by Period report.
Depreciation by Fiscal Year	RUN_AMDP2300	Run the Depreciation by Fiscal Year report.
Depreciation Activity	RUN_AMDP2000	Run the Depreciation by Activity report.

Understanding Depreciation Reports

PeopleSoft Asset Management provides a full complement of depreciation-related reports. Before you can run depreciation reports, you must load the Depreciation Reporting table (PS_DEPR_RPT). The table stores life-to-date and year-to-date depreciation amounts. You should run the process once at the beginning of the year for all assets in your system, and on a monthly or other regular basis thereafter for new open transactions.

To run depreciation reports:

1. Load the Depreciation Reporting table.
2. Run the Depreciation by Period report.
3. Run the Depreciation by Fiscal Year report.
4. Run the Depreciation Activity report.

Depreciation Reporting Table Page (Depr Reporting Table Page)

Use the Depreciation Reporting Table (Depr Reporting Table) page (AMDPREPT_RQST) to load the Depreciation Reporting table (PS_DEPR_RPT).

Use this table for all depreciation reports.

Navigation:

Asset Management > Financial Reports > Load Reporting Tables > Load Depr Reporting Table > Depr Reporting Table

This example illustrates the fields and controls on the Depr Reporting Table page. You can find definitions for the fields and controls later on this page.

Depr Reporting Table

Run Control ID DeprRpt Report Manager
Process Monitor
Run

Request
Find | View All
First 1 of 1 Last

'Request ID'
Process Frequency
+ -

Run Options

Use Open Trans
 From Year
 Unit
 Book Name
 From Asset ID

Keep Other Fiscal Years
 To Year
 To Asset ID

Process Current Activity
 Update Statistic

Check 'Update Statistics' if you want the process to Update Statistics at run time.
 You need to update statistics if there is a huge difference between number of assets during this run and last run.

Run Options

<i>Field or Control</i>	<i>Description</i>
Use Open Trans (use open transactions)	Select to pick up only new open transactions since you last ran the process.
Keep Other Fiscal Years	Select to process a new year but retain other years in the table.

Note: The Depreciation Reporting table should be loaded only for the current fiscal year, or at most two fiscal years (depending on your reporting requirements). You should run the AMDPREPT_RQST process throughout the year to account for new transactions that were created during the year by selecting the **Use Open Trans** check box.

Using User-Defined Asset Depreciation

Understanding User-Defined Depreciation

PeopleSoft Asset Management enables you to create and use your own depreciation method. This topic provides the information that you need to do so.

To create and use depreciation methods:

1. Review the variables available for use in your depreciation formula.

This topic includes a table that lists the commonly used user-defined depreciation variables. Also included is an inquiry page, where you can review these variables within the system. Review the available variables, and then proceed to create depreciation formulae.

2. Define the formula that you want to use for depreciation.

Do this in a series of steps, and then review the steps on a summary page that PeopleSoft provides for this purpose.

3. Assign the user-defined method to assets.

You can do this on several different pages within the system.

4. Save the user-defined depreciation method.
5. Generate a user-defined method SQC program.

This SQC is called by the main depreciation calculation program, AM_DEPR_CALC, during depreciation calculations. It processes all user-defined depreciation methods by SetID.

Creating or Selecting Variables

PeopleSoft provides a listing of the user-defined depreciation variables that are commonly used to construct the depreciation formula. The following table shows the variable name, the corresponding program variable, and whether a variable can be assigned a calculation result. Review this information to see if you can use it to construct your formula.

<i>Variable</i>	<i>Program Variable</i>	<i>Assign To Flag</i>
ALLOC_LIFE	# ALLOC_LIFE	N
ALLOC_TOTAL	#ALLOC_TOTAL	N

Variable	Program Variable	Assign To Flag
ASSET_BASIS	#ASSET BASIS	N
ASSET_COST	#ASSET_COST	N
ASSET_COST_PER_CHARTFIELD	#LINE_COST	N
ASSET_LIFE	#ASSET_LIFE	N
BEGIN_DEPR_PERIOD	#BEGIN_DEPR_PD	N
BEGIN_DEPR_YEAR	#BEGIN_DEPR_FY	N
CURRENT_YEAR	#SELECTED_FY	N
DB_PERCENT	#DB_PERCENT	N
DEPR	#DEPR	Y
DEPR_LOW_LIMIT	# DEPR_LOW_LIMIT	N
DEPR_PERCENT	#FLAT_PERCENT	N
LIFE_IN_YEARS	# LIFE_IN_YEARS	N
LIFE_REMAINING	#LIFE_REMAINING	N
LINE_COST_FRACTION	#LINE_COST_FRACTION	N
LTD_DEPR	#LTD_DEPR	N
NO_OF_PERIODS_IN_YEAR	#NUMBER_OF_PERIODS	N
NO_OF_PERIODS_TO_DEPR	# ALLOC	N
RESULT_A	#RESULT_A	Y
RESULT_B	#RESULT_B	Y
RESULT_C	#RESULT_C	Y

Variable	Program Variable	Assign To Flag
RESULT_D	#RESULT_D	Y
RESULT_E	#RESULT_E	Y
RESULT_F	#RESULT_F	Y
RESULT_G	#RESULT_G	Y
RESULT_H	#RESULT_H	Y
RESULT_I	#RESULT_I	Y
RESULT_J	#RESULT_J	Y
RESULT_K	#RESULT_K	Y
RESULT_L	#RESULT_L	Y
RESULT_M	#RESULT_M	Y
RESULT_N	#RESULT_N	Y
SALVAGE_VALUE	#SALVAGE_VALUE	N
TOTAL_PERIODS_DEPR	#PERIOD_COUNT_ACCUM	N
UDX1	#UDX1	Y
UDX2	#UDX2	Y
UDX3	#UDX3	Y
UDX4	#UDX4	Y
UDX5	#UDX5	Y
UDX6	#UDX6	Y

Page Used to Create or Select Variables

<i>Page Name</i>	<i>Definition Name</i>	<i>Usage</i>
User Defined Variables Page	UD_VARIABLE_DEFN	Create a new variable or select an existing variable.
Review User Defined Methods - User Defined Variables	UD_VARIABLE_INQ	View or select an existing variable.

User Defined Variables Page

Use the User Defined Variables page (UD_VARIABLE_DEFN) to create a new variable or select an existing variable.

Navigation:

Set Up Financials/Supply Chain > Product Related > Asset Management > Depreciation > AM User Defined Variables

This example illustrates the fields and controls on the User Defined Variables page. You can find definitions for the fields and controls later on this page.

User Defined Variables

Variable `ALLOC_LIFE`

Attributes

'Description

Assign to Variable

Program Variable

Comment

Original Asset Life (#Life) adjusted by accumulated depreciation periods for new asset with accumulated depreciation.
 #Alloc_Life is expressed in the units of period for a non-445 calendar and in weeks in a 445-calendar system.

<i>Field or Control</i>	<i>Description</i>
Assign To Variable	Indicates whether you can assign the resultant value to this variable.

<i>Field or Control</i>	<i>Description</i>
Program Variable	Identifies and references the user-defined variable name with the corresponding internal AM_DEPR_CALC or AMDPCUDM program variable name.
Initialize	<p>Note: This check box appears only for variables that have the Assign To Variable selected.</p> <p>Determines whether you can initialize the content of a variable during consecutive year calculation in order to use the variable content in the calculation for the subsequent years.</p>

Creating a User-Defined Depreciation Method

Once you have designed the depreciation formula, you must enter it into PeopleSoft Asset Management. The User Defined Method component consists of three pages on which you define the custom depreciation formula, see a summary page of the formula that you entered, and add comments about the formula for reference as appropriate.

The User Defined Methods component (UD_METHOD) contains the pages to create and review custom depreciation formulas.

This topic provides an overview of and discusses how to create and view user-defined depreciation methods.

Pages Used to Create a User-Defined Depreciation Method

<i>Page Name</i>	<i>Definition Name</i>	<i>Usage</i>
<u>User-Defined Methods – Definition Page</u>	UD_METHOD_DEFN	Create a user-defined depreciation method. Method ID is the five-character identifier for the user-defined depreciation method that you create.
User Defined Methods - Definition (inquiry)	UD_METHOD_INQ	View the custom depreciation formula.
User Defined Methods - Summary	UD_METHOD_SUMMARY	View a visual representation of the complete depreciation formula that you entered.
User Defined Methods - Comment	UD_METHOD_COMMENT	Enter or view additional comments or explanations of this depreciation method.

User-Defined Methods – Definition Page

Use the User-Defined Methods - Definition page (UD_METHOD_DEFN) to create a user-defined depreciation method.

Navigation:

Set Up Financials/Supply Chain > Product Related > Asset Management > Depreciation > AM User Defined Methods

This example illustrates the fields and controls on the User Defined Methods - Definition page. You can find definitions for the fields and controls later on this page.

The screenshot displays the 'User-Defined Methods - Definition' page. At the top, there are tabs for 'Definition', 'Summary', and 'Comment'. The 'Definition' tab is active, showing the following fields:

- SetID:** SHARE
- Method ID:** JSI
- Description:** Intangible/Straight Line

Below these fields is the 'Formula Sequence' section, which includes a 'Find | View All' link and navigation controls for 'First', '1 of 11', and 'Last'. The sequence is defined as follows:

- Sequence:** 10
- Description:** Calculate Line Asset Basis
- Condition:** None (selected), Then, And, If, Else, Or
- Operand 1:** Variable (selected), ASSET_BASIS
- Operation:** *
- Operand 2:** Variable (selected), LINE_COST_FRACTION
- Result:** RESULT_A

At the bottom right of the form, there are 'Sort' and 'Validate' buttons.

Formula Sequence

The system displays a sequence number. The sequence numbers are incremented by 10s (10, 20, and so on). You can change the sequence number if you like. Add a description of the sequence in the field provided.

For example, you can break the following depreciation formula into steps that you can enter as separate sequences on this page:

$$\text{Depreciation} = (\text{Asset Cost} / \text{Asset Life}) \times \text{Number of Periods to be Depreciated}$$

You can write the depreciation formula as two steps, or sequences:

1. Step 1

$$\text{Result A} = \text{Asset Cost} / \text{Asset Life}$$

2. Step 2

$$\text{Depreciation} = \text{Result A} \times \text{No. of periods to be depreciated}$$

Condition

<i>Field or Control</i>	<i>Description</i>
None	The default.
If	Indicates the beginning of an <i>If</i> statement within an If-Then-Else construct.
Then	Indicates the beginning of the <i>Then</i> statement within an If-Then-Else construct.
Else	Indicates the beginning of the <i>Else</i> statement within an If-Then-Else construct.
And	Indicates that you want to include both variables in the search.
Or	Indicates that you want to include either variable in the search.

You can create and/or statements, if-then-else statements, and multiple if-then-else statements. You cannot use nested if statements.

Operand 1

<i>Field or Control</i>	<i>Description</i>
Constant	Select to indicate a value, and then enter the value.
Variable	Select to indicate a user-defined variable.

Operation

Select the arithmetic operator.

Operand 2

<i>Field or Control</i>	<i>Description</i>
Constant	Select to indicate a value, and then enter the value.
Variable	Select to indicate a user-defined variable.

Result

<i>Field or Control</i>	<i>Description</i>
Result	Specify a name for the result of this operation. The result can be any user-defined variable for which the Assign To Variable check box on the User Defined Variables page is selected.
Validate	Click to ensure that the syntax that you entered is correct. The program performs a validation check and prompts you with an error message to correct any syntax mistakes.
Sort	Click to redisplay the sequence of steps that you entered in ascending sequence order, if you have edited some steps into the formula.

End If

Select **End If** to indicate that this is the end of an If-Then-Else construct.

Generating a User-Defined Depreciation SQC Program

Once you have created a new user-defined depreciation method, you must regenerate the AMUDDEPR.SQC program that is called by the main depreciation calculation program AM_DEPR_CALC during the depreciation calculation process.

Page Used to Generate a User-Defined Depreciation SQC Program

<i>Page Name</i>	<i>Definition Name</i>	<i>Usage</i>
<u>Generate User Defined Methods Page</u>	RUN_AMUD_METHOD	Regenerate the AMUDDEPR.SQC program that is called by the main depreciation calculation program AM_DEPR_CALC during the depreciation calculation process.

Generate User Defined Methods Page

Use the Generate User Defined Methods page (RUN_AMUD_METHOD) to regenerate the AMUDDEPR.

SQC program that is called by the main depreciation calculation program AM_DEPR_CALC during the depreciation calculation process.

Navigation:

Set Up Financials/Supply Chain > Product Related > Asset Management > Depreciation > AM Generate User Defined Mthds > Generate User Defined Methods

This example illustrates the fields and controls on the Generate User Defined Methods page. You can find definitions for the fields and controls later on this page.

The program automatically processes all user-defined depreciation method IDs that you created for that SetID.

Note: Make sure that you copy the output file as AMUDDEPR.SQC in the same directory where the AMDPCALC.SQR program is located.

If you receive any error messages when you run AM_DEPR_CALC, verify that you have copied the SQC properly to the directory where AMDPCALC is stored.

Process Scheduler runs the AMUDMTHD process at user-defined intervals.

Copying a User-Defined Depreciation Method

You can copy an existing user-defined depreciation formula when you define a new method that is similar to an existing one. You can copy the existing formula and modify it for the requirements of the new method, rather than defining it from scratch.

Page Used to Copy a User-Defined Depreciation Method

<i>Page Name</i>	<i>Definition Name</i>	<i>Usage</i>
<u>User Defined Method Copy Page</u>	UD_METHOD_COPY	Copy a user-defined depreciation method. Enter the method ID of the user-defined depreciation method that you want to copy.

User Defined Method Copy Page

Use the User Defined Method Copy page (UD_METHOD_COPY) to copy a user-defined depreciation method.

Navigation:

Set Up Financials/Supply Chain > Product Related > Asset Management > Depreciation > AM User Defined Methods Copy > User Defined Method Copy

This example illustrates the fields and controls on the User Defined Method Copy page. You can find definitions for the fields and controls later on this page.

The screenshot shows the 'User Defined Method Copy' page. At the top, it displays the current method details: SetID: SHARE, Method ID: JDB, and Tangible/Declining Balance. Below this is a 'Copy New Method' section with three input fields: 'New SetID' (containing 'SHARE'), 'New Method ID' (containing 'DDB'), and 'Description' (containing 'Double Declining Balance'). A yellow 'Copy' button is positioned to the right of the 'New Method ID' field. Below the 'Copy New Method' section is a 'Comment' section with a large, empty text area for entering a comment.

Field or Control	Description
New SetID	Select the ID for the new depreciation method; it may be the same or different from the depreciation method from which you are copying.
New Method ID	Enter an ID and a description for the new depreciation method. The description and Comment field appear by default from the old method; you can modify them.

After you have saved the new method, click the **Go to Maintain User Defined Method Page** link to modify the new copied method, if appropriate.

Note: You must save the new depreciation method before you can modify it.

Selecting a User-Defined Depreciation Method for an Asset

Once you have created a user-defined depreciation method and generated the SQC, the method is available for selection as the depreciation method to be used for an asset. You do this when you:

- Specify a user-defined depreciation method for the asset profile.
- Complete an Asset Book Definition.
- Add an asset with ExpressAdd.

Related Links

[“Setting Up Asset Profiles” \(Asset Lifecycle Management Fundamentals\)](#)

[Adding and Maintaining Asset Information](#)

Reviewing Asset Depreciation Calculation Results

Understanding What If Depreciation

PeopleSoft Asset Management provides you with the ability to perform what if depreciation simulation modeling and to load the net book value results into a spreadsheet program for analysis.

Using what if depreciation simulation modeling, you can determine, evaluate, and compare the depreciation amounts for assets if you were to change all or some of the depreciation parameters. For example, you may want determine the effect on depreciation if you change the prorate convention from mid-month to mid-quarter, or if you change the depreciation method from straight line to sum of the years digits. You can experiment with depreciation to determine what the effect on depreciation would be without changing the actual depreciation parameters for an asset.

Another useful benefit of the What If Depreciation feature is to project the depreciation if you add an asset and run the actual depreciation program. For example, you can create an asset and run the What If Depreciation program rather than running the *actual* depreciation program. You can then see what the depreciation amount for the asset would be, go back and modify the depreciation parameters accordingly, and then perform the actual depreciation.

To perform what if depreciation simulation, the assets must already exist in the system. Add at least one asset to perform the simulation. The What If Depreciation feature uses only Add and Transfer In transactions for modeling.

Performing What If Depreciation

To generate what if depreciation simulation:

- Perform what if depreciation.
- View what if depreciation results.

Pages Used to Perform What If Depreciation

<i>Page Name</i>	<i>Definition Name</i>	<i>Usage</i>
<u>What If Depreciation Page</u>	RUN_AMDPCOMP	Perform what if depreciation.

Page Name	Definition Name	Usage
<u>What If Depreciation Results Page</u>	DEPR_ALL_PRD_COMP DEPR_ALL_YEAR_COMP DEPR_ALL_MAIN_COMP	View results of what if depreciation.

What If Depreciation Page

Use the What If Depreciation page (RUN_AMDPCOMP) to perform what if depreciation.

Navigation:

Asset Management > Depreciation > What If Scenarios > What-If Depreciation Request > What If Depreciation

This example illustrates the fields and controls on the What If Depreciation page. You can find definitions for the fields and controls later on this page.

Save the what if depreciation changes that you make and run the program. If you want to run multiple modeling comparisons using the same range of assets, use different run control IDs.

The What If Depreciation page uses the AM_DEPR_COMP application engine program to run simulated depreciation instead of the actual depreciation program (AM_DEPR_CALC).

Process Scheduler runs the AM_DEPR_COMP application engine process at user-defined intervals.

What If Depreciation Results Page

Use the What If Depreciation Results page (DEPR_ALL_PRD_COMP) to view results of what if depreciation.

Navigation:

Asset Management > Depreciation > What If Scenarios > Review What-If Results > What If Depreciation Results

This example illustrates the fields and controls on the What If Depreciation page. You can find definitions for the fields and controls later on this page.

The screenshot displays the 'What If Depreciation' page for asset EX_000000001 (2000 Chevrolet Tahoe LT 1/2Ton). The interface includes sections for 'Depreciation Attributes' and 'Net Book Value'. The 'What If Yearly Depreciation' table shows a consistent annual depreciation amount of 1,775.00 for the operating unit NEWYORK from 1999 to 2013.

Year	Depreciation Amt	Operating Unit	Fund Code	Department	Program	Class Field	Bud Ref	Product	Project	Affiliate	Fund Affiliate	Operatir
1999	3,060.00	NEWYORK		14000								
2000	5,000.00	NEWYORK		14000								
2001	2,950.00	NEWYORK		14000								
2002	1,775.00	NEWYORK		14000								
2003	1,775.00	NEWYORK		14000								
2004	1,775.00	NEWYORK		14000								
2005	1,775.00	NEWYORK		14000								
2006	1,775.00	NEWYORK		14000								
2007	1,775.00	NEWYORK		14000								
2008	1,775.00	NEWYORK		14000								
2009	1,775.00	NEWYORK		14000								
2010	1,775.00	NEWYORK		14000								
2011	1,775.00	NEWYORK		14000								
2012	1,775.00	NEWYORK		14000								
2013	1,775.00	NEWYORK		14000								

You can view the results of what if depreciation using this What If Depreciation Inquiry component or you can run a query to review results.

Using either method, examine the depreciation results to see the consequences of the depreciation parameter modifications that you made, or to see the projected depreciation if you ran depreciation for an asset. You can run the results of the query to Excel. Go back and modify the depreciation results accordingly, and then run the actual depreciation program (AM_DEPR_CALC), if applicable.

Loading the Net Book Value Table for Reporting

You can load the net book value depreciation results into a spreadsheet program.

Page Used to Load the Asset Net Book Value Reporting Table

<i>Page Name</i>	<i>Definition Name</i>	<i>Usage</i>
<u>Net Book Value Table Page</u>	RUN_AMLDNBVT	<p>Run the process to load the Asset Net Book Value Reporting Table. This generates an online report of depreciation processing results.</p> <p>You can run different modeling simulations for the same range of assets by giving each simulation a different Run Control ID. Net book value information is loaded to the Asset Net Book Value table (ASSET_NBV_TBL) and is available for reporting using various reporting tools.</p>

Net Book Value Table Page

Use the Net Book Value Table page (RUN_AMLDNBVT) to run the process to load the Asset Net Book Value Reporting Table.

This generates an online report of depreciation processing results.

Navigation:

Asset Management > Financial Reports > Load Reporting Tables > Load Net Book Value Table > Net Book Value Table

This example illustrates the fields and controls on the Net Book Value Table page. You can find definitions for the fields and controls later on this page.

Load Net Book Value Table

Run Control ID 42424 Report Manager Process Monitor

Process Request Parameters

Run ID

Unit

Book Name

As Of FY

Period

Selection Criteria

Include Transfers

Include Retirements

Specify the as of fiscal year (in the **As Of FY** field) and accounting period (in the **Period** field).

Once you have loaded the Net Book Value Table, you can run any of the following reports:

- Asset NBV by ChartField (AMNB1000)
- Asset NBV by Category (AMNB1010)
- Asset NBV by Location (AMNB1030).

Note: The ASSET_NBV_TBL reflects the updates to the Load Asset Net Book Value SQR (AMLDNBVT). The updates include accumulated amortization, YTD amortization, and period amortization calculated for operating leased assets, and the periods where finance leases may have been classified as operating.

The net book value that is displayed on the Review Depreciation Info reflects the NBV calculation performed here.

The ASSET_NBV_TBL shows the remaining useful life of an asset.

The remaining useful life of an asset is calculated by subtracting the number of periods between the beginning depreciation fiscal year and the period stored on the BOOK record and the **As Of FY** and **Period** on the Load Net Book Value run control page from the asset's useful life.

The remaining useful life will not be calculated for the following depreciation methods that do not populate the LIFE field in the BOOK record:

- Declining Balance
- Flat Rate %
- France Derogatory Balance
- Manual Depreciation
- Units of Production
- User Defined Method.

Allocating Asset Depreciation Expenses

Understanding the Depreciation Allocation Business Process

PeopleSoft Asset Management enables you to allocate depreciation expenses or asset costs across multiple departments or ChartField combinations. The allocation might be divided equally among all departments or selected ChartField combinations, or it might be calculated on a factor that is appropriate to your business, such as a prorata basis.

In some business environments, allocation of depreciation expenses to departments or ChartField combinations other than those assigned to an asset's cost might be required. For example, depreciation expenses for shared services assets such as HVAC (Heating, Ventilation, Air Conditioning) for a store in a mall might be needed to allocate the expenses across all departments using the service. The allocation might be spread evenly among all departments, or it might be calculated on a prorata basis based on the square footage of each department or some other factor.

PeopleSoft Asset Management enables you to create and process allocations before posting depreciation to the general ledger. Allocation amounts are derived in PeopleSoft Asset Management from the DIST_LN table, which is populated by accounting entry generation programs such as the Accounting Entry Creation process (AM_AMAEDIST) and the Depreciation Close process (AM_DPCLOSE). The allocation process must be run after running these programs and before journal generation. The allocation program takes unposted journal lines from the DIST_LN table, processes them according to the defined allocation, and creates new allocation entries. Also, lines that have already been sent to the general ledger by previous journal generation are available to allocate.

Processing Allocations With Fund Accounting

When an educational or governmental entity acquires a capital asset, the transaction is usually accounted for as a budgeted or funded acquisition. Other programs within PeopleSoft provide the tools to perform budget checking, such as in the Purchase Order and Accounts Payable transaction processing. After the transaction to acquire the asset is completed, PeopleSoft Asset Management creates ongoing depreciation transactions. It is important that the asset depreciation entries do not inherit the original budget reference during creation of period depreciation entries because the original budget reference is not appropriate for future year's depreciation.

For example, assume that the current financial year is 2008 with budget year of 2007. An asset was added on 01/01/2005 with a budget year of 2005. All of the depreciation rows for 2008 are created with the budget year of 2005. When the depreciation entries for 2008 are posted to the general ledger, they have an incorrect budget year of 2005.

To accommodate the use of budget or fund accounting in PeopleSoft Asset Management, it is recommended that you use the allocation process to reallocate the depreciation and other transactions to the active budget reference and year. This program is run after the accounting entry creation process and depreciation close process have been run.

Prerequisites

You must have already defined transaction groups to set up the allocation basis for asset costs and depreciation. If you use budget or fund accounting, it is recommended that you establish an asset or budget reallocation transaction group, such as *All* to include all transaction types that apply, such as ADD, DPR, PDP, RCT, RET, and TRF.

Related Links

- “Understanding Asset Processing” (Asset Lifecycle Management Fundamentals)
- “Understanding Accounting Entry and Financial Processing” (Asset Lifecycle Management Fundamentals)
- “Understanding Depreciation Processing” (Asset Lifecycle Management Fundamentals)

Setting Up the Depreciation Allocation Business Process

Use the Allocation Basis Group component (ALLOC_BASIS_GRP) to set up the Depreciation Allocation business process:

- Define the allocation basis, which determines how and in what proportion the journal line amounts are distributed to various targets.
- Define the sources and destinations for the cost/depreciation to be allocated.
- Link assets to a defined allocation basis.

Pages Used to Set Up the Depreciation Allocation Business Process

<i>Page Name</i>	<i>Definition Name</i>	<i>Usage</i>
<u>Allocation Basis Definition - Definition Page</u>	ALLOC_BASIS_PNL	Define basic information for your allocation basis.
<u>Allocation Basis Definition - Allocations Page</u>	ALLOC_BASIS1_PNL	Specify the sources and destinations for the allocation.
<u>Asset Allocations Page</u>	ALLOC_DEFN_PNL	Associate assets with Allocation Basis IDs.

Allocation Basis Definition - Definition Page

Use the Allocation Basis Definition - Definition page (ALLOC_BASIS_PNL) to define basic information for your allocation basis.

Navigation:

Set Up Financials/Supply Chain > Product Related > Asset Management > Accounting > Asset Allocation Basis Defn

This example illustrates the fields and controls on the Allocation Basis - Definition page. You can find definitions for the fields and controls later on this page.

The screenshot shows the 'Definition' tab of the 'Allocation Basis' page. At the top, 'SetID' is 'SHARE' and 'Basis Id' is 'DEPT_ALLOC'. Below this, there are several input fields:

- 'Description': Department Depr Alloc Basis
- 'Effective Date': 01/01/1900
- 'Transaction Group': DEPR
- 'Allocation Type': Spread Evenly
- 'Unit of Measure': (empty)
- 'Total Allocation Units': (empty)

 On the right side, there is a 'Status' section with radio buttons for 'Active' (selected) and 'Inactive'. Navigation controls like 'Find', 'View All', 'First', '1 of 1', and 'Last' are also visible.

Field or Control	Description
Transaction Group	Select a transaction group which combines depreciation types for allocating expenses. In the case of using budget or fund accounting, select the transaction group that is used for budget or fund reallocations.
Allocation Type	Select one: <ul style="list-style-type: none"> • <i>Copy</i>: Select to override a value so that ownership can be assigned (for example, to one department while expense is charged to another department). • <i>Evenly</i>: Select to distribute the Total Allocation Units equally among the allocation destinations. • <i>Prorata</i>: Select to distribute the Total Allocation Units in the way you specify in the Destination group box on the Allocation Basis Definition - Allocations page. <hr/> Note: If you select <i>Prorata</i> as the allocation type, enter a Unit of Measure and the number of Total Allocation Units .
Unit of Measure	If you select <i>Prorata</i> as the allocation type, enter a unit of measure. This is the criteria you are going to use to do the allocation.
Total Allocation Units	The total quantity of your units of measure that are used to perform the allocation. You enter the allocation units for each destination to establish the allocation ratio for each destination.

Allocation Basis Definition - Allocations Page

Use the Allocation Basis Definition - Allocations page (ALLOC_BASIS1_PNL) to specify the sources and destinations for the allocation.

Navigation:

Set Up Financials/Supply Chain > Product Related > Asset Management > Accounting > Allocation Basis Definition > Allocations

This example illustrates the fields and controls on the Allocation Basis Allocations page. You can find definitions for the fields and controls later on this page.

The screenshot shows the 'Allocation Basis Allocations' page. It includes sections for 'Allocation', 'Source', 'Chartfields', and 'Destination'. The 'Source' section has fields for SetID (SHARE), Basis Id (DEPT_ALLOC), and Effective Date (01/01/1900). The 'Chartfields' section has a table with columns: Account, Alt Acct, Oper Unit, Fund, Dept, Program, Class, Bud Ref, Product, Project. The 'Destination' section has a table with columns: Account, Alt Acct, Oper Unit, Fund Code, Department, Program, Class Field, Bud Ref, Product, Project. The 'Destination' table contains the following data:

Account	Alt Acct	Oper Unit	Fund Code	Department	Program	Class Field	Bud Ref	Product	Project
				10000					
				10500					
				11000					
				12000					
				13000					
				14000					
				15000					
				25000					
				27000					

Complete the applicable ChartField sources and destinations.

If you are using a prorata allocation, enter the **Allocation Units** for each destination in the **Destination** group box.

Asset Allocations Page

Use the Asset Allocations page (ALLOC_DEFN_PNL) to associate assets with Allocation Basis IDs.

Navigation:

Asset Management > Accounting Entries > Allocate Depreciation Expense > Asset Allocations

This example illustrates the fields and controls on the Asset Allocations page. You can find definitions for the fields and controls later on this page.

The screenshot shows the 'Asset Allocations' page with the following details:

- Unit:** US001
- Allocation Id:** BLDG_ALLOC
- Allocation Section:** Includes 'Effective Date' (01/01/1900), 'Book Name' (dropdown), 'Category' (BLDG), 'Cost Type' (dropdown), 'Asset Status' (dropdown), and 'Allocation Basis Id' (DEPT_ALLOC). A 'Search' button is located below these fields.
- Status Section:** A dropdown menu is open, showing 'Active' (selected) and 'Inactive' options.
- Chartfields Section:** A table with columns: Oper Unit, Fund, Dept, Program, Class, Bud Ref, Product, Project. Each column has a search icon.
- Search Results Section:** A table with columns: 'Asset ID', 'Allocation Basis Id', Description, Tag Number. It displays three results:

'Asset ID	'Allocation Basis Id	Description	Tag Number
EX_000000498	DEPT_ALLOC		
EX_000000499	DEPT_ALLOC		
EX_000000500	DEPT_ALLOC		

Specify the criteria for your allocation and click the Search button to retrieve the resulting assets:

Note: The system might not display all ChartFields. The available ChartFields are dependent upon the definitions that you have created during implementation.

You can modify an asset allocation in one of two ways:

- Modify an existing asset allocation (same effective date) using Correction mode. You can also add assets to your list that do not meet the search criteria.
- Add a new effective-dated row for the asset allocation.

Field or Control	Description
Search	<p>For a new effective-dated asset allocation, click the Search button to retrieve all of the assets that match your criteria. If you are adding assets to your results that do not match your criteria, make sure that you save your allocation so that you don't lose those assets that you manually added.</p> <p>For an existing effective-dated asset allocation, click the Search button to retrieve any additional assets that match your criteria. Your existing assets will not be removed; only any new assets matching the criteria will be added to your existing list.</p>

Field or Control	Description
Cost Type	Select the Cost Type to further narrow your search results.
Allocation Basis Id	<p>Enter the Allocation Basis ID for this allocation; this is the default basis for this allocation.</p> <hr/> <p>Note: Use the upper Allocation Basis Id field to quickly establish the allocation basis value by default to each one of the selected asset IDs. Entering a value in the Allocation Basis Id field in this portion of the page <i>does not</i> narrow your search.</p> <hr/>

Within the group box on the page, you can also associate each **Asset ID** with an **Allocation Basis Id** .

When using budget or fund accounting, define the assets against which allocations should be run. For example, include all assets that pertain to the budget reference year 2001. After running the accounting entry generation process (AM_AMAEDIST) and the depreciation close (AM_DPDCLOSE) process, the Depreciation Allocation (AMALLOC) process with the appropriate budget Allocation ID can be run for the applicable fiscal year and period.

Performing the Depreciation Allocation Business Process

You can create allocation entries in the DIST_LN table by running the Depreciation Allocation (AMALLOC) process.

Note: The allocations process calls the centralized processor to generate balanced Inter/IntraUnit entries.

Page Used to Run the Depreciation Allocation Business Process

Page Name	Definition Name	Usage
<u>Process Allocation Page</u>	AMALLOC_RQST	Create allocation entries in the DIST_LN table. If necessary, the allocations process calls the IU Processor to create balanced entries.

Related Links

“Understanding PeopleSoft Interunit and Intraunit Functionality” (Application Fundamentals)

Process Allocation Page

Use the Process Allocation page (AMALLOC_RQST) to create allocation entries in the DIST_LN table.

If necessary, the allocations process calls the IU Processor to create balanced entries.

Navigation:

Asset Management > Accounting Entries > Allocate Depreciation Expense > Process Allocation > Process Allocation

This example illustrates the fields and controls on the Process Allocation page. You can find definitions for the fields and controls later on this page.

The screenshot shows the 'Process Allocation' page with the following elements:

- Page title: **Process Allocation**
- Navigation links: **Run Control ID** (ALLOC), **Report Manager**, **Process Monitor**, and a **Run** button.
- Section header: **Request**
- Fields:
 - 'Request ID' with value 1
 - 'Business Unit' with value US001 and a search icon
 - 'Allocation Id' with value BLDG_ALLOC and a search icon
 - 'Fiscal Year' with value 2012
 - 'Accounting Period' with value 12
- Process Frequency section with radio buttons:
 - Once
 - Always (selected)
 - Don't Run

Enter a **Business Unit**, **Allocation Id**, and **Accounting Period** to process allocations. Select a **Process Frequency**.

When processing for budget and fund accounting allocations, first run the accounting entry generation process (AM_AMAEDIST) and the depreciation close (AM_DPCLOSE) process. Then run the Depreciation Allocation (AMALLOC) process with the appropriate budget Allocation ID for the applicable fiscal year and period. These steps will change the entries to reflect the correct budget reference in the accounting entries for assets that were created in prior fiscal year and period.

Creating PeopleSoft Asset Management Accounting Entries

Prerequisites

Before you initiate any processing, you should review your application options. Ensure that you have:

- Defined business unit and book accounting entry options.
- Established the accounting entry template IDs to be used for PeopleSoft Asset Management processing.
- Established the accounting entry templates to be used for PeopleSoft Asset Management processing.
- Determined the depreciation open and close status for periods.

Understanding Asset Information Flow

Each financial transaction that is entered into PeopleSoft Asset Management can be used to generate balanced accounting entries. These entries in turn can be summarized and written to a journal, which can then be rolled up and posted to the general ledger system.

Balanced accounting entries are generated from financial transactions and are the basis for creating journals that are posted to the general ledger. The primary sources of accounting entries within PeopleSoft Asset Management include:

- Accounting entries that are created from financial transactions such as asset additions, adjustments, allocations or retirements.
- Accounting entries that are created from depreciation close for a particular accounting period.
- Accounting entries that are created from lease payments.

Others include processing transactions to adjust for inflation and accounting entries that are created from an active integration with other PeopleSoft products such as Billing, Purchasing, and Payables.

Each time financial asset information is entered or adjusted, PeopleSoft Asset Management creates an open transaction. This transaction remains open until accounting entries are created or depreciation is calculated for the transaction. The process for accounting entry creation generates accounting entries for all financial transactions that are not related to depreciation. The Depreciation Close process (AM_DPCLOSE) generates accounting entries for depreciation in a particular accounting period.

To create accounting entries:

1. Enter asset transactions.

Based on the context of the transaction that you enter, the system creates an open transaction with a transaction type such as Add, Transfer, Adjust, Retire, and so forth. These open transactions form a list of accounting entry or depreciation tasks to be processed.

2. Calculate depreciation for open transactions.
3. Create asset transaction accounting entries by running the Accounting Entry Creation process (AM_AMAEDIST), which applies the appropriate accounting entry templates to the open transactions that were created in step 1.

Selection of an accounting entry template is determined by the accounting entry template ID, category, cost type, transaction type, and transaction code of the asset transaction. You can run this process at any interval. You should run the process more than once a month to prevent the process from being slowed at period close time. Use Process Scheduler to schedule and automatically initiate these processes.

4. At the end of each accounting period, create depreciation accounting entries by running the Depreciation Close process; the process applies the depreciation (DPR) and prior depreciation period (PDP) accounting entry templates to the asset depreciation table.

Run this process only once for each accounting period, and only after all of the transaction activity for the period has been completed.

5. Reverse accounting entries by running the Depreciation Close process with the option **Reverse Posted Entries** selected.

This option reverses only those journal entries that have been created and posted to the general ledger, and creates reversal entries.

This diagram shows the processes for creating accounting entries:

This diagram shows the processes for creating accounting entries.

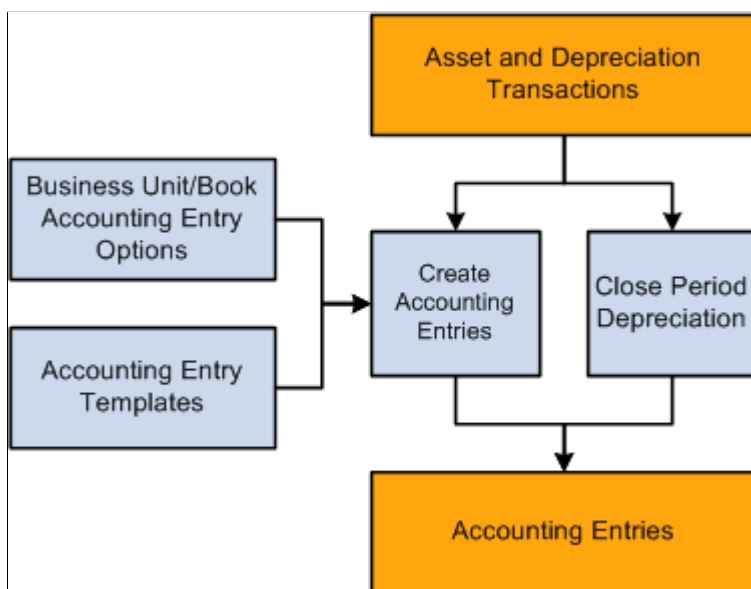

See “Understanding Accounting Entry and Financial Processing” (Asset Lifecycle Management Fundamentals).

See “Understanding Asset Processing” (Asset Lifecycle Management Fundamentals).

Understanding Accounting Entry Setup

This topic discusses:

- Business unit and book accounting entry options.
- Accounting entry templates.
- Depreciation close status.

Business Unit and Book Accounting Entry Options

Business unit and book accounting entry options are defined in the Establish Business Units component, and they control which business unit book is used to create accounting entries. Select one book for each business unit to create accounting entries.

Note: When processing accounting entries, you should understand the relationship between PeopleSoft Asset Management business units and PeopleSoft General Ledger business units. If you are using different business units for the applications because you use multiple ledgers, you must be sure to specify the ledger. The ledger is required when you are searching on the Asset Journals page. Failing to enter the value generates an error, and the journal lines for business units that are different do not appear, even though the PeopleSoft Asset Management entries are generated and posted to the journal tables.

See “Understanding Asset Management Business and Cash Generating Units” (Asset Lifecycle Management Fundamentals).

Accounting Entry Templates

The accounting entry template is the central table that the system uses to create accounting entries, which are the basis for general ledger journals. The accounting entry template defines accounting entry types based on asset category, cost type, transaction type, transaction code, and accounting entry template ID. For each accounting entry type, you specify:

- The accounts to use during accounting entry.
- The journal template to use for recording actual transactions.
- The budget journal template to use to record budget transactions.

When you add an accounting entry template in PeopleSoft Asset Management, the system populates it with standard accounting entry types (distribution types), based on the asset category, cost type, and action that is specified for all supported features that require accounting types.

If impairment and revaluation options are enabled at the installation level, you can specify within the cost type definition if you want to enable a given cost type for impairment or revaluation processing. If enabled, the system displays the appropriate impairment and revaluation related accounts at the Accounting Entry Template level.

Use the features within the Accounting Entry Template ID component to define accounting entry template IDs that include or exclude the appropriate accounting entry (distribution) types for each type of transaction. The accounting entry template IDs can be associated with business unit-level features such as the Book Code feature, the Derogatory Depreciation feature, the Like Kind Exchange feature, and the Revaluation feature.

Accounting entry types are delivered with the PeopleSoft system, and each asset event has an associated set of accounting entry types. For each combination of category, cost type, transaction code, and accounting entry template ID, you must set up an accounting entry template for the following transaction types:

<i>Transaction Type</i>	<i>Description</i>
AA	Accumulated amortization
ADD	Additions.
ADJ	Adjustments.
LN	Lease incentive.
LR	Lease remeasurement
TRF	Transfers.
RCT	Recategorizations.
DPR	Depreciation expense.
PDP	Prior period depreciation.
RE	Rent expense.
RET	Retirements (also used for processing reinstatements).
RT	Rent expense contra.
LPY	Lease payments.
INF	Inflation adjustment.
LEX	Lease expense.

Note: If you enter a transaction into the system with a combination of category, cost type, transaction code, and accounting entry template ID for which no accounting entry template exists, the accounting entry process will fail the next time it is run.

DPR and PDP transaction types are used only on an accounting entry template with a blank transaction code.

Accounting Entry Types (Distribution Types)

Asset Management creates accounting entries by using standard accounting entry types (distribution types), based on the asset category, cost type, and action that is specified for all supported features that require accounting entry types. The following tables list the accounting distribution types that are associated with each accounting entry feature.

Following are the distribution types for the ADD (addition) transaction type (if there is no 'X' for a distribution type (blank), that type is not applicable for the listed feature):

<i>Type</i>	<i>Description</i>	<i>Basic</i>	<i>Expensed Asset</i>	<i>Lease</i>	<i>Derogatory</i>	<i>Like Kind Exchange</i>	<i>Revaluation</i>
AD	Accumulated Depreciation	X					X
AP	Contra Asset	X	X				X
DD	Accumulated Derogatory Depreciation				X		
DE	Depreciation Expense	X					X
DR	Derogatory Depreciation Reversal				X		
DX	Derogatory Depreciation Expense				X		
EX	Expense		X				
FA	Fixed Asset	X					X

<i>Type</i>	<i>Description</i>	<i>Basic</i>	<i>Expensed Asset</i>	<i>Lease</i>	<i>Derogatory</i>	<i>Like Kind Exchange</i>	<i>Revaluation</i>
IV	Investment Property	X					X
IX	Investment Property Accumulated Depreciation Adjustment	X					X
LO	Lease Obligation			X			
TI	Trade In	X					X
UR	Unrecognized Gain/Loss					X	X
RL	Recognized Loss					X	X
PR	Provision for Revaluation						X

Following are the distribution types for the ADJ (adjustment) transaction type:

<i>Type</i>	<i>Description</i>	<i>Basic</i>	<i>Expensed Asset</i>	<i>Lease</i>	<i>Derogatory</i>	<i>Like Kind Exchange</i>	<i>Revaluation</i>
AD	Accumulated Depreciation	X					X
AP	Contra Asset	X	X				X
DD	Accumulated Derogatory Depreciation				X		
DE	Depreciation Expense	X					X

<i>Type</i>	<i>Description</i>	<i>Basic</i>	<i>Expensed Asset</i>	<i>Lease</i>	<i>Derogatory</i>	<i>Like Kind Exchange</i>	<i>Revaluation</i>
DR	Derogatory Depreciation Reversal				X		
DX	Derogatory Depreciation Expense				X		
EX	Expense		X				
FA	Fixed Asset	X					X
IV	Investment Property	X					X
LO	Lease Obligation			X			
PG	Investment Property Gain	X					X
PL	Investment Property Loss	X					X
PR	Provision for Revaluation						X
RD	Reversal of Depreciation						X
IM	Impairment Loss	X					X
IN	Impairment Contra						X

Here are the distribution types for the TRF (transfer) transaction type:

Type	Description	Basic	Lease	Derogatory	Like Kind Exchange	Revaluation
AD	Accumulated Depreciation	X			X	
DD	Accumulated Derogatory Depreciation			X		
DR	Derogatory Depreciation Reversal			X		
DX	Derogatory Depreciation Expense			X		
FA	Fixed Asset	X			X	
IV	Investment Property	X			X	
PR	Provision for Revaluation					X
RC	Provision for Revaluation Contra					X

Here are the distribution types for the RCT (recategorize) transaction type:

Type	Description	Basic	Lease	Derogatory	Like Kind Exchange	Revaluation
AD	Accumulated Depreciation	X			X	
DD	Accumulated Derogatory Depreciation			X		

Type	Description	Basic	Lease	Derogatory	Like Kind Exchange	Revaluation
DR	Derogatory Depreciation Reversal			X		
DX	Derogatory Depreciation Expense			X		
FA	Fixed Asset	X			X	
IV	Investment Property	X			X	
PR	Provision for Revaluation					X
RC	Provision for Revaluation Contra					X

Here are the distribution types for the RET (retire) transaction type:

Type	Description	Basic	Lease	Derogatory	Like Kind Exchange	Revaluation
AD	Accumulated Depreciation	X				
AP	Contra Asset				X	
BI	Proceeds to Billing Account	X (If Billing is installed)				
CA	Proceeds	X				
DD	Accumulated Derogatory Depreciation			X		

Type	Description	Basic	Lease	Derogatory	Like Kind Exchange	Revaluation
DR	Derogatory Depreciation Reversal			X		
DX	Derogatory Depreciation Expense			X		
FA	Fixed Asset	X				
GA	Gain	X				
GL	Loss	X				
IV	Investment Property	X				
LG	Lease Guarantee Contra		X			
LO	Lease Obligation		X			
LU	Lease Guarantee Obligation		X			
MA	Mortgage - Others				X	
ML	Mortgage - Comp				X	
NV	Net Book Value			X		
PR	Provision for Revaluation					X

Type	Description	Basic	Lease	Derogatory	Like Kind Exchange	Revaluation
RC	Provision for Revaluation Contra					X
RD	Reversal of Depreciation					X
RG	Recognized Gain				X	
RM	Removal Contra	X				
SL	Sales of Fixed Asset			X		
TI	Trade In	X				
UG	Unrealized Gain				X	
UL	Unrealized Loss				X	

Here are the distribution types for the DPR (depreciation) transaction type:

Type	Description	Basic	Lease	Derogatory	Like Kind Exchange	Revaluation
AD	Accumulated Depreciation	X				X
DD	Accumulated Derogatory Depreciation			X		
DE	Depreciation Expense	X				X
DR	Derogatory Depreciation Reversal			X		

Type	Description	Basic	Lease	Derogatory	Like Kind Exchange	Revaluation
DX	Derogatory Depreciation Expense			X		
RC	Provision for Revaluation Contra					X
RD	Reversal of Depreciation					X

Here are the distribution types for the PDP (prior period depreciation) transaction type:

Type	Description	Basic	Lease	Derogatory	Like Kind Exchange	Revaluation
AD	Accumulated Depreciation	X				
DD	Accumulated Derogatory Depreciation			X		
DE	Depreciation Expense	X				
DR	Derogatory Depreciation Reversal			X		
DX	Derogatory Depreciation Expense			X		
RC	Provision for Revaluation Contra					X
RD	Reversal of Depreciation					X

Here are the distribution types for the LPY (lease payment) transaction type:

Type	Description	Basic	Lease	Derogatory	Like Kind Exchange	Revaluation
LC	Lease Interest Contra		X			
LI	Lease Interest		X			
LO	Lease Obligation		X			
LP	Lease Obligation contra		X			
VE	Variable Lease Expense Debit		X			
VC	Variable Lease Expense Contra		X			

Here are the distribution types for the INF (inflation) transaction type:

Type	Description	Basic	Lease	Derogatory	Like Kind Exchange	Revaluation
IA	Inflation Accum Depr	X				
IB	Inflation Accum Depr	X				
IC	Inflation Cost Adjustment	X				
ID	Inflation Cost Adjustment	X				
IG	Inflation Gain	X				
IL	Inflation Loss	X				

<i>Type</i>	<i>Description</i>	<i>Basic</i>	<i>Lease</i>	<i>Derogatory</i>	<i>Like Kind Exchange</i>	<i>Revaluation</i>
IP	Inflation Period Depr	X				
IQ	Inflation Period Depr	X				
IY	Inflation YTD Depr	X				
IZ	Inflation YTD Depr	X				

See “Defining Accounting Entries” (Asset Lifecycle Management Fundamentals).

See “Creating PeopleSoft Asset Management Business Units” (Asset Lifecycle Management Fundamentals).

Depreciation Close Status

You can run the Depreciation Close process only in an open period. You use the Business Unit/Book Definition page to determine which accounting periods have been closed. Select **Depreciation Closed List** to display all closed periods.

Note: Open and close accounting periods are maintained in General Ledger and migrated with the financial subsystems. Each subsystem application can either use the periods that are created in General Ledger or update the open and close periods at the application business unit level.

See “Defining and Updating Open Periods and Adjustment Periods” (Application Fundamentals).

See “Open Period Update Page” (Asset Lifecycle Management Fundamentals).

Creating Accounting Entries

This topic provides an overview of the Depreciation Close process, lists common elements, and discusses how to create Accounting entries.

Pages Used to Create Accounting Entries

Page Name	Definition Name	Usage
<u>Create Accounting Entries Page</u>	AM_AMAEDIST_RQST	Set up and initiate a request or set of requests for accounting entry creation.
<u>Run Depreciation Close Process Page</u>	DEPR_CLOSE_RQST	Enter and initiate a depreciation close request or requests.
<u>Closing Accounting Period Page</u>	DEPR_CLOS_PD	Close accounting periods to ensure that you do not make any new transactions in the period.
Review Financial Entries - List	ASSET_DIST_LIST	Review accounting financial entries in summary list. In the case where there are multiple "Future-dated" EFFDT, only the MAXIMUM effective-dated row will be displayed in the prompt for ACCOUNT in the Review Financial Entries component.
Review Financial Entries - Detail	ASSET_DIST_DETAIL	Review accounting financial entries in detail. In the case where there are multiple "Future-dated" EFFDT, only the MAXIMUM effective-dated row will be displayed in the prompt for ACCOUNT in the Review Financial Entries component.
Review Operating Leases - List	ASSET_NF_DIST_LN	Review operating lease entries in summary list.
Review Operating Leases - Detail	LEASE_DIST_DETAIL	Review operating lease entries in summary list.
Review Asset Journals	AM_GL_DRILL	Review asset journal information.
Calculate Inflation - Request	DEPR_INF_RQST	Run a process to calculate inflation for assets.
Review Expense Entries - List	ASSET_NF_LIST	Review the expense entries (nonfinancial assets) that were created by running the Clearing Reconciliation process.

Page Name	Definition Name	Usage
Review Expense Entries - Details	ASSET_NF_DET	Review the expense entry details (nonfinancial assets) that were created by running the Clearing Reconciliation process.
<u>Clearing Reconciliation Page</u>	AM_CLEREC_RQST	Run the process to reconcile the clearing account that is created by trackable assets from feeder systems against the expense account.

Understanding the Depreciation Close Process

The Depreciation Close process generates period depreciation accounting entries for all depreciable assets in a particular accounting period, including lease payments and offset accounts for the period. Run this process only for an accounting period that has not yet been closed. You can reverse or rerun this process if errors are detected in the results. The flexible run parameters allow processing to close the period, reversing the output of the last posting run, or reversal with reprocessing of the close entries.

Open and close accounting periods are maintained in General Ledger and migrated to the financial subsystems. Each subsystem application can either use the periods that are created in General Ledger or update the open and close periods at the application business unit level.

When you run the Depreciation Close process, you have two options: **Rerun Depreciation Close** and **Reverse Posted Entries**. The following examples demonstrate how these options affect processing.

Example of the Rerun Depreciation Close Option

With **Rerun Depreciation Close** enabled and the journal entries not yet created, the Depreciation Close process creates a new accounting entry, as shown in this table, and deletes the existing one (if any). If the journal entries have already been created, depreciation close will neither delete nor generate entries. No actions occur.

DISTRIBUTION _TYPE	DTTM_STAMP	AMOUNT	GL_DISTRIB_ STATUS	REVERSE_ STATUS	REVERSE_ DTTM_STAMP	Journal ID	Journal Dttm Stamp
AD	2009-09-05 14:25:20	-110.00	N		NULL		NULL
DE	2009-09-05 14:25:20	110.00	N		NULL		NULL

When the journal entries have been posted, the system updates the general ledger distribution status to *D* (done).

This table shows the results after the PeopleSoft General Ledger run:

<i>DISTRIBUTION _TYPE</i>	<i>DTTM_STAMP</i>	<i>AMOUNT</i>	<i>GL_DISTRIB_ STATUS</i>	<i>REVERSE_ STATUS</i>	<i>REVERSE_ DTTM_STAMP</i>	<i>Journal ID</i>	<i>Journal Dttm Stamp</i>
AD	2009-09-05 14:25:20	-110.00	D		NULL	XX	Journal Dttmstamp
DE	2009-09-05 14:25:20	110.00	D		NULL	XX	Journal Dttmstamp

Example of the Reverse Posted Entries Option

When the **Reverse Posted Entries** option is selected and the journal entries have been created, the original entry is reversed with new rows inserted showing the reversed amounts. The new entries display the statuses *R* for reversal and *X* for reversed entries.

This table shows the original entry:

<i>DISTRIBUTION _TYPE</i>	<i>DTTM_STAMP</i>	<i>AMOUNT</i>	<i>GL_DISTRIB_ STATUS</i>	<i>REVERSE_ STATUS</i>	<i>REVERSE_ DTTM_STAMP</i>	<i>Journal ID</i>	<i>Journal Dttm Stamp</i>
AD	2009-09-05 14:25:20	-110.00	D	X	NULL	XX	Journal Dttmstamp
DE	2009-09-05 14:25:20	110.00	D	X	NULL	XX	Journal Dttmstamp

This table shows the reversed entry:

<i>DISTRIBUTION _TYPE</i>	<i>DTTM_STAMP</i>	<i>AMOUNT</i>	<i>GL_DISTRIB_ STATUS</i>	<i>REVERSE_ STATUS</i>	<i>REVERSE_ DTTM_STAMP</i>	<i>Journal ID</i>	<i>Journal Dttm Stamp</i>
AD	2009-09-12 17:37:25	110.00	N	R	2003-09-05 14:25:20		
DE	2009-09-12 17:37:25	-110.00	N	R	2003-09-05 14:25:20		

Example of Both the Rerun Depreciation Close and Reverse Posted Entries Options

When the **Reverse Posted Entries** and the **Rerun Depreciation Close** options are both selected, and the journal entries have been created, then the original entry is reversed as shown in the previous example, and a new accounting entry is created.

This table shows the original entry:

<i>DISTRIBUTION _TYPE</i>	<i>DTTM_STAMP</i>	<i>AMOUNT</i>	<i>GL_DISTRIB_ STATUS</i>	<i>REVERSE_ STATUS</i>	<i>REVERSE_ DTTM_STAMP</i>	<i>Journal ID</i>	<i>Journal Dttm Stamp</i>
AD	2009-09-05 14:25:20	-110.00	D	X	NULL	XX	Journal Dttmstamp
DE	2009-09-05 14:25:20	110.00	D	X	NULL	XX	Journal Dttmstamp

This table shows the reversed entry:

<i>DISTRIBUTION _TYPE</i>	<i>DTTM_STAMP</i>	<i>AMOUNT</i>	<i>GL_DISTRIB_ STATUS</i>	<i>REVERSE_ STATUS</i>	<i>REVERSE_ DTTM_STAMP</i>	<i>Journal ID</i>	<i>Journal Dttm Stamp</i>
AD	2009-09-12 17:37:25	110.00	N	R	2003-09-05 14:25:20		
DE	2009-09-12 17:37:25	-110.00	N	R	2003-09-05 14:25:20		

This table shows the results of the rerun with the new entry:

<i>DISTRIBUTION _TYPE</i>	<i>DTTM_STAMP</i>	<i>AMOUNT</i>	<i>GL_DISTRIB_ STATUS</i>	<i>REVERSE_ STATUS</i>	<i>REVERSE_ DTTM_STAMP</i>	<i>Journal ID</i>	<i>Journal Dttm Stamp</i>
AD	2009-09-12 17:37:25	-140.00	N		NULL		NULL
DE	2009-09-12 17:37:25	140.00	N		NULL		NULL

Common Elements Used in This Section

<i>Field or Control</i>	<i>Description</i>
Request ID	Displays the number of process requests that you have submitted.
Unit	Enter the business unit for which transactions are processed.
Book Name	Enter the book for which transactions are processed.

Field or Control	Description
Currency	Displays the currency in which the transactions are processed, based on the base currency for the selected book or business unit.

Create Accounting Entries Page

Use the Create Accounting Entries page (AM_AMAEDIST_RQST) to set up and initiate a request or set of requests for accounting entry creation.

Navigation:

Asset Management > Accounting Entries > Create Accounting Entries > Create Accounting Entries

This example illustrates the fields and controls on the Create Accounting Entries page. You can find definitions for the fields and controls later on this page.

Field or Control	Description
Cost Summarize	Select to create cost summary while creating accounting entries.
From Asset ID and To Asset ID	Enter the transaction range to process.
Process GL Journal Generator	Select this option to enable the Journal Generator process (FS_JGEN) to run automatically once the Create Accounting Entries process (AM_AMAEDIST) completes. See “Understanding Journal Generator” (Application Fundamentals)

Field or Control	Description
SetID	Enter a setID for the Journal Generator process.
Accounting Definition Name	Enter an accounting definition name for the Journal Generator process.

Note: The system calls the Inter/IntraUnit central processor to create balanced accounting entries.

See “Understanding PeopleSoft Interunit and Intraunit Functionality” (Application Fundamentals).

Run Depreciation Close Process Page

Use the Close Depreciation page (DEPR_CLOSE_RQST) to enter and initiate a depreciation close request or requests.

Navigation:

Asset Management > Accounting Entries > Close Depreciation > Close Depreciation

This example illustrates the fields and controls on the Close Depreciation page. You can find definitions for the fields and controls later on this page.

Run Control ID 001
Report Manager Process Monitor
Run

Request
Find | View All
First 1 of 1 Last

*Request ID

*Unit

*Book Name

*Fiscal Year

Process Frequency

Currency USD

*Period

Options

- Rerun depreciation close
- Reverse Posted Entries
- Create budgeted depreciation
- Process a range of assets

Accounting Definition

Process GL Journal Generator

SetID

Accounting Definition Name Asset Management Definition

Field or Control	Description
Fiscal Year and Period	Enter the appropriate fiscal year and open periods to be closed.
Rerun Depreciation Close	<p>Select to delete all existing accounting entries that haven't been generated as journal entries for depreciation expense and lease obligations for the specified business unit, book, fiscal year, and period. The system generates new entries.</p> <p>To generate new journal entries and to reverse a journal entry, run a request with both Rerun Depreciation Close and Reverse Posted Entries options selected.</p> <p>To rerun depreciation close for budgeted depreciation, run a request with both Rerun Depreciation Close and Create Budgeted Depreciation options selected.</p>
Reverse Posted Entries	<p>Select to reverse only those accounting entries that have been created and posted to the general ledger, including all existing accounting entries for depreciation expense and lease payments for the specified business unit, book, fiscal year, and period. The process creates reversal entries and marks the old entries with a status of <i>Reversed</i>. If journal entries have not been created, the entries marked <i>Reversed</i> are not used by the Journal Generator process.</p> <p>To reverse entries that are created and post them again, use Reverse Posted Entries in tandem with Rerun Depreciation Close. When you do this, the original journal entry is reversed and a new entry is created.</p> <p>When an entry has not been posted to the general ledger, use the rerun option. Reverse Posted Entries does not reverse unposted entries.</p>
Create budgeted Depreciation	Displays the resulting accounting entries as budgeted depreciation and lease payments. These entries are posted to the budget ledger that is specified in the Business Unit Book options page when you run the Journal Generator process.

Field or Control	Description
Process a range of assets	<p>Select to process a specific range of assets for a business unit, book, fiscal year, and period. Use this option to split up a large volume of assets for a particular business unit and book. Because the program AM_DPCLOSE commits its work after each request, selecting this option accelerates the process. You can also use this selection with the parallel option to take advantage of servers that have parallel processors. This speeds up processing for large volumes of data.</p> <p>For example, to increase throughput when creating depreciation accounting entries for 1,000,000 assets, you can enter 10 requests to process 100,000 assets each. Select Process in Parallel, and assign a processing sequence number to each process request. Processing sequence numbers must be unique.</p> <p>Use care when specifying From asset ID and To asset ID processing parameters, as these parameters are inclusive. Overlapping can occur, and no edit is available to verify that you have set up inclusive asset ranges. For example, suppose that request 1 is processed from asset ID 0001 and to asset ID 0005. If request 2 is processed from asset ID 0005 and to asset ID 9999, asset 0005 is processed twice. You can use Query to verify ranges by counting the number of assets in total and number of assets per range.</p>
Process GL Journal Generator	<p>Select this option to enable the Journal Generator process (FS_JGEN) to run automatically once the Close Depreciation process (AM_DPCLOSE) completes.</p> <p>See “Understanding Journal Generator” (Application Fundamentals)</p>
SetID	<p>Enter a setID for the Journal Generator process.</p>
Accounting Definition Name	<p>Enter an accounting definition name for the Journal Generator process.</p>

Note: If you use the interface between PeopleSoft Asset Management and PeopleSoft Billing, accounting entries are created by these integrated transactions. How the entries are created is described in more detail in the PeopleSoft Billing documentation.

See “Understanding How PeopleSoft Asset Management Integrates with Other Applications” (Asset Lifecycle Management Fundamentals).

See “Understanding Asset Management Business and Cash Generating Units” (Asset Lifecycle Management Fundamentals).

See “Understanding General Ledger Journal Entries” (PeopleSoft General Ledger).

See “Understanding PeopleSoft Billing and Asset Management Integration” (PeopleSoft Billing).

Closing Accounting Period Page

Use the Close Accounting Period page (DEPR_CLOS_PD) to close accounting periods to ensure that you do not make any new transactions in the period.

Navigation:

Asset Management > Accounting Entries > Close Accounting Period > Close Accounting Period

Enter the year and period to be closed, and save the page. When a period has been closed, you cannot create additional depreciation-related accounting entries for that period.

See “Understanding Interim and Year End Closing” (PeopleSoft General Ledger).

Clearing Reconciliation Page

Use the Clearing Reconciliation page (AM_CLEREC_RQST) to run the process to reconcile the clearing account that is created by trackable assets from feeder systems against the expense account.

Navigation:

Asset Management > Accounting Entries > Clearing Reconciliation > Clearing Reconciliation

This example illustrates the fields and controls on the Clearing Reconciliation page. You can find definitions for the fields and controls later on this page.

The screenshot shows the 'Clearing Reconciliation' page with the following fields and controls:

- Run Control ID:** Clearing
- Report Manager:** Report Manager
- Process Monitor:** Process Monitor
- Run:** Run button
- Selection Criteria:** Find | View All | First 1 of 1 | Last
- 'Request ID:** 1
- System Source:** AP Batch
- 'Business Unit:** US001
- 'Book Name:** CORP
- From Asset ID:** [Empty]
- To Asset ID:** [Empty]
- Document Type:** [Empty]
- Process Frequency:** Always
- Currency:** USD

PeopleSoft Asset Management provides an optional Capitalization Threshold feature that, once enabled, can automatically determine capitalization status of an asset, by profile, based on its cost or quantity according to limits that you define. The system classifies assets as capital, non capital, or expense. The Clearing Reconciliation process (AM_CLEREC) provides a way to reconcile accounting entries for expensed assets.

See [Capitalization Thresholds Page](#).

When assets came from other sources, a debit is usually recorded to a fixed asset account and a clearing account is credited that was previously debited in the source system. When an asset is deemed trackable because of the specified threshold, the asset ID is generated but no accounting activities take place. This reconciliation process provides a way to balance out the clearing account that was debited in the source

system and debit the expense account instead. This is not applicable to expensed (trackable) assets that are entered directly in Asset Management with no clearing account.

Enter the parameters and run the process. The system searches non capital assets for the specified parameters in the acquisition detail. For each non capital row that matches the system source, the following entry is generated in the DIST_LN table:

<i>Debit</i>	<i>Credit</i>	<i>Distribution Type</i>
Expense Account		EX
	Clearing Account	AP

Creating Memorandum Accounting Entries for Federal Reporting

This topic provides an overview of memorandum accounting and discusses how to set up and create memorandum accounting entries.

Pages Used to Create Memorandum Accounting Entries

<i>Page Name</i>	<i>Definition Name</i>	<i>Usage</i>
<u>Federal Posting Rules Page</u>	AM_FDRL_RULES	Define memorandum account posting rules for a selected asset
<u>Manage Current Year Assets Page</u>	AM_FDRL_ASSETS_UPD	Identify and review new current year assets that require memorandum account posting.
<u>ChartField Search Criteria Page</u>	AM_SEL_CF2_SEC	Specify additional ChartField search criteria when searching for assets on the Manage Current Year Assets page.
<u>Review Current Year Assets Page</u>	AM_FDRL_ASSET_VIEW	Review previously selected current year assets for a federal group.
<u>Create Federal Entries Page</u>	AM_FDRLPOST_RQST	Create memorandum account postings.

Understanding Memorandum Account Posting

Federal changes to the Governmentwide Treasury Account Symbol Adjusted Trial Balance System (GTAS) require that organizations track current year asset acquisitions using memorandum accounts, which are used for GTAS Bulk File attribute reporting, validations, and edits. Current year acquisitions include operating materials and supplies, inventory, real property, exhibits, capital leases, leasehold improvements, internal-use software, and other assets and personal property expenditures that are

capitalized. 'Current year' is defined as any asset transaction posted in a given fiscal year (October 1 – September 30) and is not tied to the expiration of an agency's Treasury Account Symbol (TAS)/ appropriation.

Memorandum accounts are administrative accounts only and do not affect recorded or reported budgetary and proprietary values on the adjusted trial balance.

Per Treasury guidance, the memorandum postings should be booked on a transaction by transaction basis. This requires each asset purchase transaction that posts to a United States Standard General Ledger (USSGL) asset account (15XX, 17XX, 18XX, or 19XX) to also post the USSGL memo accounts (8801, 8802, 8803, and 8804). Create memorandum accounting entries any time your agency takes possession of an asset. Concurrent postings include asset accounts (15XX, 17XX, 18XX, and 19XX), 4901 (Delivered Orders - Obligations, Unpaid), 3107 (Unexpended Appropriations – Used), and 5700 (Expended Appropriations).

This table describes the USSGL memorandum accounts and their associated USSGL asset accounts:

USSGL Memorandum Account	Description	Associated USSGL Asset Accounts
8801	Offset for purchases of assets	15xx, 17xx, 18xx, 19xx
8802	Purchases of property, plant, and equipment	17xx (Property, plant, and equipment) 18xx (Leases, leasehold improvements, and internal-use software)
8803	Purchases of inventory and related property	15xx (Operating materials, supplies, and inventory)
8804	Purchases of assets - other	19xx (Other assets)

This table describes the new USSGL transactions that are a part of Federal GTAS changes:

USSGL Transaction	Description
G120	Used to record activity for current-year purchases of property, plant, and equipment.
G122	Used to record activity for current-year purchases of inventory and related property.
G124	Used to record activity for current-year purchases of other assets not recorded as Property, Plant and Equipment (USSGL TC-G120), or Inventory and Related Property (USSGL TC-G122).

The following screenshot provides an example of generated memorandum accounting entries viewed on the Review Financial Entries page:

Generated memorandum accounting entries

Acctg Date	Trans Type	Account	Alternate Account	Base DR Amount	Base CR Amount	Detail
1 01/10/2014	ADD	100001		36,000.00		Detail
2 01/10/2014	ADD	100003			36,000.00	Detail
3 01/10/2014	ADD	8801			36,000.00	Detail
4 01/10/2014	ADD	8803		36,000.00		Detail
5 07/10/2014	TRF	100001			36,000.00	Detail
6 07/31/2014	TRF	100002		6,000.00		Detail
7 07/31/2014	TRF	200000		30,000.00		Detail
8 07/10/2014	TRF	8801		36,000.00		Detail
9 07/10/2014	TRF	8803			36,000.00	Detail
10 07/10/2014	TRF	100001		36,000.00		Detail
11 07/31/2014	TRF	100002			6,000.00	Detail
12 07/31/2014	TRF	200000			30,000.00	Detail
13 07/10/2014	TRF	8801			36,000.00	Detail
14 07/10/2014	TRF	8803		36,000.00		Detail

Steps to Set up and Create Memorandum Accounting Entries

To set up and process memorandum accounts for GTAS Bulk File reporting:

1. Use the Federal Posting Rules page to define memorandum account posting rules for selected assets.
See [Federal Posting Rules Page](#)
2. Use the Manage Current Year Assets page to identify and review new current year assets that require memorandum account posting.
See [Manage Current Year Assets Page](#)
3. Use the Review Current Year Assets page to review previously selected current year assets.
See [Review Current Year Assets Page](#)
4. Use the Create Federal Entries run control page to run the AM_FDRLPOST process and create memorandum account postings for the selected current year asset accounts.

Note: Federal entries can also be created using the Create Accounting Entries page. However, assets must already be in the federal group to be run from the page.

See

[Create Federal Entries Page](#)

Create Accounting Entries Page

Federal Posting Rules Page

Use the Federal Posting Rules page (AM_FDRL_RULES) to define memorandum account posting rules for a selected asset.

Navigation:

Set Up Financials/Supply Chain > Product Related > Asset Management > Accounting > AM Federal Posting Rules

This example illustrates the fields and controls on the Federal Posting Rules page. You can find definitions for the fields and controls later on this page.

Federal Posting Rules

SetID: SHARE Federal Rule: 88XXPOST

Posting Rules Find | View All First 1 of 1 Last

*Effective Date: 01/01/2001 *Status: Active

*Description: 88XX POSTINGS

Category Find | View All First 1 of 1 Last

*Asset Category: 15XX

Accounting Entries Personalize | Find First 1-14 of 14 Last

Transaction Type	Transaction In/Out	Accounting Entry Type	Account	DR/CR
Asset Addition		Asset Purchased	8803	Debit
Asset Addition		Asset Offset	8801	Credit
Asset Cost Adjustment		Asset Purchased	8803	Debit
Asset Cost Adjustment		Asset Offset	8801	Credit
Asset Transfer	Out	Asset Purchased	8803	Credit
Asset Transfer	Out	Asset Offset	8801	Debit
Asset Transfer	In	Asset Purchased	8803	Debit
Asset Transfer	In	Asset Offset	8801	Credit
Asset Recategorization	Out	Asset Purchased	8803	Credit
Asset Recategorization	Out	Asset Offset	8801	Debit
Asset Recategorization	In	Asset Purchased	8803	Debit
Asset Recategorization	In	Asset Offset	8801	Credit
Asset Retirement		Asset Purchased	8803	Credit
Asset Retirement		Asset Offset	8801	Debit

Field or Control	Description
SetID	Displays the SetID associated with the federal posting rule.

Field or Control	Description
Federal Rule	<p>Displays the unique name of the federal rule.</p> <p>PeopleSoft recommends that you define one main posting rule for each asset category (for example, 15XX, 17XX, 19XX). This configuration simplifies the rule assignment for assets by reducing the number of rules.</p>
Asset Category	<p>Enter the asset category to which the federal posting rule applies.</p>
Transaction Type	<p>Displays the AM transaction type to which the debit/credit pairs apply.</p>
Transaction In/Out	<p>Displays transaction in/out status.</p> <p>Recat and Transfer type transactions displaying 'In' will be applied to the new selection. Recat and Transfer type transactions displaying 'Out' will be applied to the old selection.</p>
Accounting Entry Type	<p>Displays a description of the debit or credit.</p>
Account	<p>Enter the account to be debited or credited by the posting rule transaction type.</p> <p>The system requires a balanced entry; if you enter a debit, a credit is required as well (and vice versa).</p> <p>You can leave the account field blank if the transaction type should not have an additional accounting entry.</p>
DR/CR	<p>Displays 'DR' for a debit and 'CR' for a credit.</p>

Manage Current Year Assets Page

Use the Manage Current Year Assets page (AM_FDRL_ASSETS_UPD) to identify and review new current year assets that require memorandum account posting.

Navigation:

Asset Management > Accounting Entries > Federal Posting > Manage Current Year Assets

This example illustrates the fields and controls on the Manage Current Year Assets page. You can find definitions for the fields and controls later on this page.

Field or Control	Description
Business Unit	Displays the Asset Management business unit associated with the current year asset group.
Federal Group	Displays the unique federal group name associated with the current year asset group. Note: A new federal group must be created each fiscal year to represent the group of current year assets.

Federal Fund Information

Field or Control	Description
Book	Enter the book name associated with the assets for which you are searching.

Field or Control	Description
Fiscal Year	Enter the fiscal year associated with the assets for which you are searching. The fiscal year is compared with the acquisition date to determine which assets to display.
Status	Select a status to Indicate whether the list is active or inactive.
From/To Date	Displays the calendar range for the selected business unit, book, and fiscal year.
Assets in Group	Displays the number of assets already in the group.

Asset Search Criteria

The fields in this grid all help to narrow your search results.

Field or Control	Description
Asset Category	Select an asset category associated with the assets for which you are searching.
Asset Location	Select an asset location associated with the assets for which you are searching.
Profile ID	Select a profile ID associated with the assets for which you are searching.
Area ID	Select an area ID associated with the assets for which you are searching.
Asset Class	Select an asset class associated with the assets for which you are searching.
Cost Type	Select a cost type associated with the assets for which you are searching.
From/To Acquisition Date	Specify the acquisition date range to limit your search results to that timeframe.

Field or Control	Description
From/To Asset ID	Specify the asset ID range to limit your search results to that group of asset IDs.
Federal Rule	Select a federal rule associated with the assets for which you are searching.
Status	Select a status associated with the assets for which you are searching.
System Source	Select a system source associated with the assets for which you are searching.
ChartField Search Criteria	Click the link to access the ChartField Search Criteria page and specify additional ChartField search criteria.
Search New	Click to find new assets based on the given search criteria, fiscal year entered, and asset acquisition date.
Search Existing	Click to search assets that are already listed. This search utilizes the current search criteria provided.
Max Rows	Enter the maximum number of rows to display in the search results.
Clear Search	Push to clear both the asset search criteria and search results.

Search Results

The following fields apply to all rows of the search results.

Field or Control	Description
Select All	Click to select all the assets in the search results.
Deselect All	Click to deselect all the assets in the search results.
Remove from List (trash can icon)	Click to remove an asset from the search results.

Field or Control	Description
Federal Rule	Select one or more assets from the search results, select a federal rule using this field, and click Default to apply the federal rule to multiple assets. <hr/> Note: A federal rule is required for all assets. <hr/>
Status	Select one or more assets from the search results, select a status using this field, and click Default to apply the status to multiple assets.
Default	Click to apply a default federal rule or status to multiple assets.

The following fields apply to individual rows of the search results.

Field or Control	Description
Asset ID	Displays the asset ID associated with the asset.
Federal Rule	Specify a federal rule for an individual asset. <hr/> Note: A federal rule is required for all assets. <hr/>
Description	Displays the description of the asset.
Tag Number	Displays the tag number of the asset (when available).
Serial ID	Displays the serial ID of the asset (when available).
Acquisition Date	Displays the acquisition date of the asset.
Status	Specify a status for the asset. The status relates to whether an asset is active in the Federal group.

ChartField Search Criteria Page

Use ChartField Search Criteria Page (AM_SEL_CF2_SEC) to select an operating unit, fund code, department (and so forth) associated with the assets for which you are searching. To access this page, click the ChartField Search Criteria link on the Manage Current Year Assets page.

This example illustrates the fields and controls on the ChartField Search Criteria page.

Review Current Year Assets Page

Use the Review Current Year Assets page (AM_FDRL_ASSET_VIEW) to review previously selected current year assets for a federal group.

Navigation:

Asset Management > Accounting Entries > Federal Posting > Review Current Year Assets

This example illustrates the fields and controls on the Review Current Year Assets page. You can find definitions for the fields and controls later on this page.

The fields on this page function identically to the fields on the Manage Current Year Assets page, except that you are searching for previously selected current year assets. The Audit History tab displays information about when an asset was added, by user, as well as last update date, by user.

For more information on the fields on this page, please refer to the field definitions for the Manage Current Year Assets page.

Create Federal Entries Page

Use the Create Federal Entries page (AM_FDRLPOST_RQST) to create memorandum account postings for the selected current year asset account.

Navigation:

Asset Management > Accounting Entries > Federal Posting > Create Federal Entries

This example illustrates the fields and controls on the Create Federal Entries page. You can find definitions for the fields and controls later on this page.

Field or Control	Description
Run Control ID	Displays the unique name for the run control.
Run	Click to run the AM_FDRLPOST process and create memorandum account entries for the selected current year asset accounts.
Business Unit	Select the Asset Management business unit against which the process should run.
Book	Select the book against which the process should run.
Fiscal Year	Enter a fiscal year from which to select transactions and post accounting transactions.
Accounting Period	Enter an accounting period from which to select transactions and post accounting transactions.
Federal Group	Select the federal group against which the process should run.

Retiring Assets

Understanding Asset Retirement

PeopleSoft Asset Management enables you to fully or partially retire assets in the past, present, or future. Occasionally, a retirement transaction may require a reversal. In that case, you can reinstate a retired asset using the pages in the Asset Retirements component.

You retire assets when they are either disposed of or no longer in use. When you retire an asset, PeopleSoft Asset Management creates all the necessary journal entries. For example, when you sell an asset, the system calculates depreciation through the date of the sale, as well as any gain or loss. In addition, you can have the system create journal entries corresponding to each of these events. Gains and losses are booked to separate accounts, providing flexibility in updating general ledger journals and balances.

An asset is retired by its book designation; therefore, you can retire an asset in one book, but it is still available for depreciation in others. You can reinstate retired assets at any time. When assets are reinstated, depreciation starts again for them if they are not fully depreciated.

Retirement Types

Assets are fully or partially retired by quantity or by cost. You can also enter retroactive retirement information for assets that were actually retired in a prior accounting period.

Full Retirement

When the full quantity and total cost of an asset are retired, the asset is considered fully retired. The asset is taken off the books after the retirement has been fully processed and accounting entries have been created. No further depreciation accrues.

Partial Retirement

You can partially retire an asset, and the system continues to process depreciation for the amount that remains. Two types of partial retirement are available:

- By quantity

You can partially retire assets by quantity. For example, if you have 250 computers, and you sell 50 of them to employees, you enter the 50 units as the quantity retired. PeopleSoft Asset Management calculates the corresponding cost.

- By cost

You can partially retire assets by cost. For example, suppose that you partially retire a computer for the price of the computer monitor, 400 USD, and you sell the monitor for 100 USD. The total cost of the computer is 1500 USD. The cost (400 USD) is the amount retired, and the 100 USD is the

proceeds from the sale. PeopleSoft Asset Management automatically calculates the gain or loss based on these amounts.

Prior Period

To enter a retirement transaction for an asset that was actually retired in a prior accounting period, you must enter transaction and accounting dates that reflect the actual retirement and the accounting period in which you want the retirement posted. For example, suppose that an asset sold on April 30 was processed as a retirement in PeopleSoft Asset Management on June 30. By the time the asset is entered as a retirement, depreciation expense for May and June post to the general ledger. That posting results in overstated accumulated depreciation and an incorrect gain or loss. To correctly process this retirement, you would specify April 30 as the transaction date and—assuming all prior periods are closed—June 30 as the accounting date. PeopleSoft Asset Management then reverses the accumulated depreciation attributable for May and June and calculates the correct gain or loss on the asset.

Retiring Financial Assets

This topic discusses how to retire financial assets.

Financial transactions cannot be performed on the Lease Administration Lease Assets through Asset Management.

Understanding Traded-In Asset Processing

To retire an asset by trading it for another asset:

1. Retire the asset using the disposal code in the **Traded-In for Another Asset** field.
2. Enter the amount that is gained through the trade-in into the **Proceeds** field.
3. Run depreciation to calculate the gain or loss amount.
4. Add the new asset by using the Asset ExpressAdd component and select Trade-in as the acquisition code.
5. Enter the asset ID of the asset that you traded into the **Trade-in** field.

Note: Be sure to run depreciation whenever you retire an asset. This process calculates the gain or loss amount. The proceeds are offset against the cost of the asset that is acquired as part of the exchange.

Understanding Asset Retirement Using the Disposal Worksheet

PeopleSoft Asset Management provides the Disposal Worksheet page as a quick method to select assets to retire based on the following elements: ChartField combination, location, department, manufacturer, or other fields that are related to the assets.

Use of the worksheet depends on the establishment of asset-to-owner relationships as well as owner-to-operator relationships to enable the selection, review, and approval of asset disposal. When the **Asset**

Owner and **Asset Owner User** links are defined, the asset owner can generate and submit a disposal worksheet for processing or approval.

After the approval process has been established and configured, an asset owner can review asset disposal requests from the Approve Disposals page via link from Worklist entry notifications, or asset approvers with proper permissions can review disposal requests directly from the Approve Disposals page. Requests can be approved, denied, pushed back, or placed on hold by designated approvers or adhoc approvers. Upon approval of the request, you can submit the disposal for processing through the AMIF1000 transaction processor.

See also “Establishing Asset Ownership” (Asset Lifecycle Management Fundamentals).

Pages Used to Retire Financial Assets

Page Name	Definition Name	Usage
Retire Assets Page	ASSET_RETIRE_01	Retire or reinstate an asset. Click the appropriate button to access other fields based on your selection.
Like Kind Exchange	LIKE_KIND_EXCH	Enter fair values and descriptions for each asset to add multiple assets as part of a like-kind exchange.
General Info	CUST_GENERAL1	Search for and select customer information to add for retirements by sale or trade.
Retire/Reinstate Assets - Other Options Page	ASSET_RETIRE_02	Select assets to be retired based on gain or loss and on other options.
Retire/Reinstate Assets - By ChartField Page	ASSET_RETIRE_03	Override PeopleSoft Asset Management calculations when shared assets are partially retired.
Retire/Reinstate Asset - Child Assets Page	CHILD_ASSETS	Select child assets to include in a retirement transaction that you have initiated against the parent on the Retire Assets page.
Child Asset Retirement Options	AM_PARCHD_RET01	Specify retirement overrides for a specific child asset. For example, you might specify a different retirement disposal code for the child asset.
Advanced Transaction Details	FULL_PART_SEC	Specify transaction overrides for all child assets at once.

Page Name	Definition Name	Usage
Proceeds and Removal Cost Allocation	AM_PARCHD_ALLOC	Specify allocation options to calculate removal cost and proceeds for the parent (if selected) and selected children.
<u>VAT Page</u>	AM_VAT_TRANS_RET	Specify options to use to calculate VAT on an asset retirement.
<u>Auto-Retire Fully Depr Assets Page</u>	RUN_AMRETFDA	Identify run-control parameters to initiate the Auto-Retire Fully Depreciated Assets process (RUN_AMRETFDA).
Auto-Retired Assets	RUN_AMRET001	Identify run-control parameters to generate the Auto-Retire Assets report.
Proceeds and Removal Cost	ASSET_RETIRE_SEC1	View the transaction in the base currency, alternate currency, and associated exchange rate.
<u>Capital Gain Page</u>	ASSET_RETIRE_05	View the calculations for capital gains or losses for a retirement transaction.
<u>Bill Information Page</u>	ASSET_RETIRE_07	Define default values for PeopleSoft Billing.
AM/BI Interface (Asset Management - Billing interface) Page	RUN_AMBI_INTFC	Run the PeopleSoft Asset Management - Billing interface. See <u>Bill Information Page</u>
<u>Disposal Worksheet Page</u>	AM_EXPRESS_RET1	Identify and submit assets for disposal.
Asset Information, Retirement Information, Other Accounting Information	AM_DISPOSAL_00	Retrieve assets according to the search criteria entered. The system displays the Asset Information, Retirement Information, and Other Accounting Information tabs.
ChartField Search Criteria	AM_LOOKUP_CF_SEL	Select ChartFields to use as search criteria.
Ownership Details	AM_DISPOSAL_01	View the original asset owner selection attributes.
<u>Approving Disposals</u>	AM_DISP_APPR01	Deny or approve a retirement disposal, or place it on hold.

Page Name	Definition Name	Usage
Approval Map Page	AM_AF_APPR_MAP	Access a view-only approval flow map of all assets in the disposal request.

Retire Assets Page

Use the Retire Assets page (ASSET_RETIRE_01) to retire or reinstate an asset.

Click the appropriate button to access other fields based on your selection.

Navigation:

Asset Management > Asset Transactions > Asset Disposal > Retire/Reinstate Asset

This example illustrates the fields and controls on the Retire Assets page. You can find definitions for the fields and controls later on this page.

Field or Control	Description
Trans Date (transaction date)	The transaction date reflects the date that the retirement actually occurred. Usually, an actual transaction occurs before you enter it in PeopleSoft Asset Management. The transaction date and the prorate convention determine how much of the depreciation taken in PeopleSoft Asset Management must be recovered.
Acctg Date (accounting date)	The accounting date determines when the retirement transaction is posted to the general ledger.

Field or Control	Description
Rate Type	Select an exchange rate type for the transaction if you use multiple currencies in processing and the retirement transaction is not in the base currency of the business unit.
In Physical Use	<p>This flag is informational only on the Retire Assets page. Only those assets that are selected for physical use are included in the ITAM comparison process. If this flag was selected before retirement, it is automatically deselected after the asset is retired. This flag can be selected or deselected on the Basic Add page or the Define Asset Operational Info page.</p> <p>See “Understanding IT Assets and the Asset Repository” (PeopleSoft IT Asset Management).</p>
Book Name	Enter the book in which this asset retirement is recorded.
Retire As	<p>Specify the type of retirement transactions to process by selecting from the list of disposal codes. Then, depending on the asset's status, click GO or Reinstate. Until you click one of these buttons, you cannot enter information into other fields.</p> <hr/> <p>Note: To reinstate a specific retired transaction, scroll to the transaction and select the Reinstate check box before clicking the Reinstate button.</p> <hr/> <p>Note: The system automatically selects the ARO Settlement option for assets processed for Asset Retirement Obligations (asset type = ARO).</p> <hr/>
Copy Changes to Other Books	Selected by default, this option keeps all books in sync by copying this transaction to all other books that are defined for the asset. Deselect the check box if you do not want to copy changes to other books.
Base Currency, As of, Quantity, and Cost	<p>These fields display the corresponding information as defined for this asset in the selected book before you save your changes. You can use this information as a reference when you enter quantity or amount information to partially retire an asset.</p> <hr/> <p>Note: If you process asset transactions in multiple currencies, the retirement transaction can be performed in a currency different from that of the asset base currency or the book currency. The Base Currency field is informational. It displays the default currency from the selected asset's business unit.</p> <hr/>

Retirement

Disposal codes reflect the **Retire As** action that is selected to initiate the retirement transaction. PeopleSoft Asset Management calculates gain or loss amounts depending, in part, on the disposal code that you select.

Note: The disposal code value for assets with an asset type of ARO is automatically selected as ARO Settlement. The Retirement Amount field stores the settlement and the retirement amount field is displayed as Settlement Amount.

This table describes the available options in the **Retire As** field:

Code	Usage	Gain/Loss
<i>Abandonment</i>	Select when the asset has no resale value and it is left behind. For example, consider leasehold improvements. At the end of the lease term, the improvements are generally left behind and no removal costs are incurred when you turn over the improvement to the lessor.	Gain/loss calculations are based on the asset net book value.
<i>Auto-Retire Fully Depr Asset</i>	Select when the asset is fully depreciated.	Gain/loss calculations are based on the asset net book value.
<i>Cannibalize for Other Assets</i>	Select when the asset has been dismantled and the parts are reused within the organization. For example, if an employee reuses a monitor that is part of an unused computer, you would retire the monitor as cannibalized. Typically, cannibalized assets are partially retired. They have no proceeds and no removal costs.	Gain/loss calculations are based on the asset net book value.
<i>Casualty Loss</i>	Select when an asset is unintentionally destroyed. If the asset cannot be sold, you may incur removal costs disposing of it. Retiring an asset as a casualty may have tax consequences if you have tax credits and the asset is not fully depreciated.	PeopleSoft Asset Management deducts the accumulated depreciation from the retirement amount and adds the removal costs to determine the amount of the casualty loss.
<i>Disappeared Assets</i>	Select when an asset cannot be located and you are not sure whether the asset was abandoned or stolen. Disappeared assets have no proceeds or removal costs.	Gain/loss calculations are based on the asset net book value.

Code	Usage	Gain/Loss
<i>Disposal Due to Theft</i>	Select when an asset has been stolen.	Stolen assets have no proceeds and no removal costs.
<i>Donated to External Group</i>	Select when an asset is donated. You typically use this option when assets are donated to nonprofit organizations for tax purposes.	<p>PeopleSoft Asset Management deducts the accumulated depreciation from the retirement amount, treating proceeds and removal costs as appropriate, to determine the gain or loss.</p> <hr/> <p>Note: VAT is applicable for VAT business units.</p> <hr/>
<i>Expensed</i>	<p>Select when an asset has adjustments to the original cost that requires reclassification from capital asset to expensed asset due to its cost. If the Capitalization Threshold feature is enabled, Asset Management automatically assigns this disposal code through the Capitalization Threshold Validation process if the original cost falls below the capitalization threshold.</p> <p>See Capitalization Thresholds Page.</p>	<p>The accounting entry template for this disposal code reflects the loss account as the expense. Previous depreciation expense is recognized as expense too. The Interface Type is RET.</p>
<i>Like Kind Exchange</i>	Select to process like-kind exchanges under U.S. federal tax code.	See Like-Kind Exchange Processing Retiring Financial Assets .
<i>Missing Asset</i>	Select when an asset is missing. Missing assets have no proceeds and no removal costs.	Gain/loss calculations are based on the asset net book value.
<i>Retirement by Sale</i>	Select if you sell an asset. (If you sell the entity that owns the asset, you must retire all assets that are owned by the entity.) You can use the interface with PeopleSoft Billing to generate the bill.	<p>The proceeds and removal cost from the sale, less the net book value of the asset, determines the gain or loss.</p> <hr/> <p>Note: VAT is applicable for VAT business units.</p> <hr/>

Code	Usage	Gain/Loss
<i>Returned to Inventory</i>	Select when the asset is returned to a common internal pool where it is available for others to use.	<p>PeopleSoft Asset Management deducts the accumulated depreciation from the retirement amount, treating proceeds and removal costs as appropriate, to determine the gain or loss.</p> <hr/> <p>Note: VAT is applicable for VAT business units.</p> <hr/>
<i>Scrapped Assets</i>	Select when the asset is no longer useful and has no resale value.	The gain/loss calculations include removal costs; accumulated depreciation is deducted and then the removal costs are added to derive the amount of the gain or loss.
<i>Traded In for another Asset</i>	<p>Use when you are trading one asset for another.</p> <p>See Processing Trade-Ins.</p>	<p>PeopleSoft Asset Management deducts the accumulated depreciation from the retirement amount, treating proceeds and removal costs as appropriate, to determine the gain or loss.</p> <hr/> <p>Note: VAT is applicable for VAT business units.</p> <hr/>

Field or Control	Description
Quantity	<p>When you select a disposal code, the system automatically populates the Quantity field with the total number of units, and the Retirement Amount field with the total cost for all units. Adjust either the quantity or the cost for a partial retirement. If you adjust the number of units, the cost is recalculated. If you adjust the cost, the quantity is recalculated.</p> <p>When performing a full retirement, it is not necessary to adjust quantity or amount retired; enter any proceeds from the sale of this asset and any removal costs that you may have incurred. When performing a partial retirement, change either the quantity or cost that will be retired.</p>
Removal Cost and RC Curr (removal cost currency)	Enter the amount of any cost for removal and select the currency for the cost.
Proceeds and Pr Curr (proceeds currency)	Enter the amount of the proceeds for the transaction and select the currency of the proceeds.

Field or Control	Description
	<p>When you have transactions involving currencies other than base currency, click the Base Amounts and Exchange Rate icon to access the Proceeds and Removal Cost page. You can review base amounts and exchange rates. You cannot make changes on this page.</p>
Convention	<p>Specify the convention to use to calculate depreciation through retirement. Generally, the same depreciation convention is used to retire an asset as was used when the asset was in service. However, you can change the convention to manipulate depreciation processing. For example, assuming a calendar year, an asset retired on April 15 will be depreciated as follows:</p> <p><i>Actual Day:</i> (asset is depreciated through April 15)</p> <p><i>Actual Month:</i> (asset is depreciated through March 31)</p> <p><i>Following Month:</i> (asset is depreciated through April 30)</p>
Transaction Code	<p>Select to identify the reason for the retirement or reinstatement.</p>

Field or Control	Description
<p>Retire Option</p>	<p>Select the retirement calculation option to be processed for the transaction. Options are:</p> <ul style="list-style-type: none"> • <i>Calculate Gain/Loss</i> <p>Select to calculate gain or loss that is associated with the retirement of an asset without fully depreciating the asset. Select if assets should not be fully depreciated at retirement so that the accounting entries passed to the general ledger will include gain or loss information.</p> • <i>Fully Depr no Future Expense</i> <p>Select to process the asset as fully depreciated with no future depreciation expenses, regardless of how much depreciation has actually been calculated. The accounting entries passed to the general ledger will not include gain and loss information. (This remains true as long as no proceeds or removal cost have been assigned for that particular asset.)</p> <p>This option is used generally within the utility industry for group assets and assumes that assets are fully depreciated at retirement regardless of how much depreciation has actually been calculated. Depreciation expense is debited for the full cost basis of the asset at the time of retirement, resulting in no gain or loss. Net book value (NBV) will remain, however.</p> • <i>Fully Depr with Future Expense</i> <p>Select to process the asset as fully depreciated, regardless of how much depreciation has actually been calculated, but future depreciation expenses may be created. The accounting entries passed to the general ledger will not include gain and loss information. (This remains true as long as no proceeds or removal cost have been assigned for that particular asset.) The depreciation close process (AM_DPCLOSE) generates the accounting entries for any remaining expense.</p> <hr/> <p>Note: Fully depreciated assets are also called fully reserved assets.</p> <hr/> <p>For example, if you retire an asset with an original cost basis of 10,000 USD and accumulated depreciation of 8,000 USD, the NBV is 2,000 USD. When you run the Accounting Entry Creation process (AM_AMAEDIST) to create accounting entries, the system looks at the selection for the Retire Option field:</p>

Field or Control	Description
	<p>If you select <i>Calculate Gain/Loss</i>, the system creates the following accounting entries: Debit Accumulated Depreciation for 8,000 USD; Debit Loss for 2,000 USD; and Credit Fixed Asset for 10,000 USD.</p> <p>If you select <i>Fully Depr no Future Expense</i>, no gain or loss is recorded, and the accounting entries are Debit Accumulated Depreciation for 10,000 USD and Credit Fixed Asset for 10,000 USD.</p> <p>If you select <i>Fully Depr with Future Expense</i>, the accounting entries are Debit Accumulated Depreciation for 10,000 USD; Credit Fixed Asset for 10,000 USD; Debit Depreciation Expense for 2,000 USD; and Credit Accumulated Depreciation for 2,000 USD.</p> <hr/> <p>Note: When you select <i>Fully Depr with Future Expense</i>, the first two rows are created by the Accounting Entry Creation process (AM_AMAEDIST.) The last two rows are created by the Depreciation Close process (AM_DPCLOSE.)</p> <hr/> <p>Note: The default for the Retire Option is from the Asset Book level. If the Retire Option at the Asset Book level is blank, the default value comes from the Asset Profile table. If this is also blank, the default value is Calculate Gain/Loss.</p> <hr/>
Retirement Amt (retirement amount)	Displays the amount of the retirement transaction in the base currency.
Base Removal Cost	Displays the base removal cost, translated to the base currency.
Base Proceeds	Displays the base proceeds, translated to the base currency.
Accum Depr (accumulated depreciation)	Displays the accumulated depreciation for the asset, which is displayed after you have run the depreciation calculation process (AM_DEPR_CALC).
Gain/Loss	Displays the amount of the gain or loss on the transaction after you run the depreciation calculation process (AM_DEPR_CALC).

Field or Control	Description
Override Accum	Select this option to override accumulated depreciation for group assets. When you select this option, the Overridden Accum (Amount) field becomes available for entry.
Overridden Accum (Amount)	Enter the accumulated depreciation amount for the group asset.
Comments	Click the Comments link to access the Retire Assets - Comments page and view or add relevant supporting comments to an asset transaction.
Attachments	Click the Attachments link to access the Retire Assets - Attachments page and view or add relevant supporting documents to an asset transaction.

ARO Obligation

This section only displays when Asset Retirement Obligation data is recorded for the asset.

Field or Control	Description
ARO Settlement	Displays the actual ARO settlement amount. Note that partial AROs are possible, even if the asset is still in service.
ARO Settlement Comments	Optionally add comments regarding the ARO Settlement.
Currency	Displays the currency of the ARO Settlement.
ARO Liability	Displays the amount of the ARO liability balance that remains.
Base ARO Settlement	Displays the settlement amount in the base currency of the asset book.
Gain/Loss	Displays the difference between the ARO liability and the actual cash outflow to remove the asset is recorded as a gain or loss. The gain or loss is recorded only when the final obligation amount is recorded.

Customer/Ship from Information

This region of the Retire Assets page enables you to retrieve customer information that is related to a retirement-by-sale transaction.

The fields appear only when this value is selected as the retirement option or if the retirement option is *Traded In*, *Donated*, or *Returned to Inventory* and the business unit is VAT-enabled.

Field or Control	Description
Ship from Loc (ship from location)	The default ship-from location is the asset location. If no asset location is defined, the default is the business unit location. This field is required only for business units that are VAT-enabled.
Customer ID	Enter the customer ID for the customer who is billed for the transaction. The value that is entered determines VAT values. When you enter the customer ID, default values for customer location, bill-to-location, sold-to, and ship-to information are supplied automatically, if applicable. Click the Search button to view a list of the valid customer IDs for the business unit. When you enter a customer ID, the location is set to the default location and the ship-to and sold-to Customer IDs and locations are set to the same values.
Loc (location)	Enter the location ID for the customer location that is associated with the customer ID. <hr/> Note: Click the Search button to view a list of the valid customer location IDs for the business unit. <hr/>
Sold To Customer	Enter the customer ID for the customer that ordered and purchased the asset. This value is not necessarily the same as the value in the Customer ID field.
Sold Loc (sold location)	Enter the location ID for the customer that ordered or purchased the asset. This value is not necessarily the same as the location in the Loc field.
Ship To Customer	Enter the customer ID where the assets will be shipped. Depending on the PeopleSoft Billing interface options that you selected, this field appears when shipping information is associated with the selected customer ID. This value is not necessarily the same as the value in the Customer ID field.

Field or Control	Description
Ship Loc (buyer location)	Enter the location ID associated with the ship-to customer. Customers can have several location addresses associated with them, each identified by a location number.
Create Bill	Select to generate a PeopleSoft Billing invoice when the disposal method is Retirement by Sale. This option does not appear if PeopleSoft Asset Management is not integrated with PeopleSoft Billing or if you did not enable the interface at implementation.

See “Understanding PeopleSoft Billing and Asset Management Integration” (PeopleSoft Billing).

See “Integrating with PeopleSoft Billing” (Asset Lifecycle Management Fundamentals).

Retire Assets - Comments Page

Use the Retire Assets - Comments page (AM_COMMENTS_SEC) and view or add relevant supporting comments to an asset transaction.

Field or Control	Description
Comment	Enter comments for an asset.
User ID, Name and Date/Time Stamp	Displays the user ID, name, and date/time stamp related to the user who added the comment. You can edit the date/time stamp after saving the comment.
Source	Displays the transaction source for the asset, such as adjustment, transfer, and so forth.

Retire Assets - Attachments Page

Use the Retire Assets - Attachments page (AM_ADD_ATTACH_SEC) to view or add relevant supporting documents to an asset transaction.

Field or Control	Description
Add Attachment	Click this button to attach files as supporting documentation for an asset. Supply a description of the file or files that you attach.
File Name	Displays the attached file. Click the file-link to access the file.

Field or Control	Description
Description	Displays a description of the file attachment when one was provided by the user.
User, Name, and Date/Time Stamp	Displays the user ID, name, and date/time stamp related to the user who added the attachment.

General Info Page

Use the General Info page (CUST_GENERAL1) to search for and select customer information to add for retirements by sale or trade.

This section displays when you select the **Billing Interface Processing** option on the Interface Options page and the *Retirement by Sale* option for the **Retire As** field on this page.

Navigation:

Click the **Customer General Info** link on the Retire Assets page.

See “Understanding the Primary Customer Roles” (PeopleSoft Order to Cash Common Information).

VAT

To access the VAT page, click this link or select the VAT tab at the top of the page.

This tab and link appear only for VAT-enabled business units.

Note: The VAT default values are automatically applied the first time that you access the page by clicking the link. However, if you change the customer, ship-from, or ship-to information after the VAT default values are applied, the default values are not automatically updated. In this case, go to the VAT page and click the **Reset All VAT Defaults** button to redetermine all the defaults. This action is not necessary if only the proceeds information has changed.

The fields that appear on the VAT page are specific to the transaction that is recorded. In addition to depending on proceeds, the VAT default values that appear depend on the customer ID, location, ship-to ID, ship-to location, and ship-from location (or the ship-to country, ship-to state, buyer's registration country, and ship-from location if no customer information is available). The VAT drivers also determine which default values appear. The VAT drivers for assets are, in descending order of precedence: asset class, customer location, customer, PeopleSoft Asset Management business unit definition, VAT entity registration, and VAT country. The algorithm for the defaults selects information from asset class first, followed by customer location, followed by customer, and so on.

VAT is enabled based on the disposal code that is used in the transaction. VAT applies for the following disposal codes:

- *Retirement by Sale*
- *Traded In for Another Asset*
- *Donated to External Group*

- *Returned to Inventory*

See [VAT Page](#).

Like-Kind Exchange Processing

Use the Like Kind Exchange page (LIKE_KIND_EXCH) to enter fair values and descriptions for each asset to add multiple assets as part of a like-kind exchange.

This page appears when you select the *Like Kind Exchange* option for the **Retire As** field and click the **Like Kind Exchange Info** link.

Navigation:

Click the **Like Kind Exchange Info** (like-kind exchange information) link on the Retire Assets page. In the **Retire As** field, select the *Like Kind Exchange* option to display the link.

PeopleSoft Asset Management supports 1031 Like-Kind Exchange regulations under the U.S. federal tax code. It enables you to:

- Retire an asset using a like-kind disposal code, recognize the gain that results, and roll the correct tax basis over to the newly acquired asset.
- Verify, through a comparison of the disposition date and the replacement date, that the 180-day exchange rule is met.
- Generate appropriate accounting entries for like-kind exchanges.
- Run reports that detail each like-kind transaction and show the carry forward of the tax basis from the old assets to the new assets.

Click the **Like-Kind Exchange Info** link to enter retirement information that is specific to a retirement transaction.

This example illustrates the fields and controls on the Like Kind Exchange page. You can find definitions for the fields and controls later on this page.

Like Kind Exchange

Unit US001	Asset ID 000000000090	Book CORP	
Currency USD		Date/Time 12/18/2012 10:50:02AM	
Transaction Information		Base Information	
Cash	<input type="text" value="0.00"/>	Base Cash	0.00
FMV Like Kind	<input type="text" value="0.00"/>	Base FMV Like Kind	0.00
Net Liability	<input type="text" value="0.00"/>	Base Net Liability	0.00
FMV Non Like-Kind	<input type="text" value="0.00"/>	Base FMV Non Like Kind	0.00
Proceeds	0.00	Base Proceeds	0.00
		Base Recognized GL	0.00

Like Kind Exchange Info

One to Many ID

Trade-in List					Personalize Find View All	First 1 of 1 Last
Transaction	Trade-In Value	Currency	Trade In Value	Currency	Description	
	0.00	USD	0.00	USD	<input type="text"/>	<input type="button" value="+"/> <input type="button" value="-"/>

To process like-kind exchanges:

1. Retire an asset using the like-kind exchange disposal code.
 - Enter any cash that is received as part of the exchange in the **Cash** field. Cash that is received in a like-kind exchange is taxable and is often referred to as *boot*.
 - Enter the fair value of the like asset that you will be adding in the **FV Like-Kind** field.

For example, if you are retiring a building and adding another building that is valued at 60,000 USD, enter *60,000* into the **FV Like-Kind** field. If you plan to add more than one like asset, select **One to Many** to access the one-to-many list, where you can enter the values and descriptions of assets that you are adding.

- If you will also receive non-like property as part of this exchange, enter its fair value in the **FV Non Like-Kind** field.

A gain that is realized through the acquisition of non-like property is taxable.

- Enter the amount of your liability into the **Net Liability** field.

For example, if you are surrendering a building with a mortgage of 70,000 USD and acquiring a building with a mortgage of 30,000 USD, then enter 40,000 USD as the net liability.

The system sums the values in the Cash, FV and Net Liability fields and populates the **Proceeds** field with the result. You cannot change this amount.

PeopleSoft Asset Management prorates basis calculations when you perform a one-to-many exchange.

2. Run the Depreciation Calculation process, which calculates both the realized gain and the recognized gain.

You can view the result of this calculation in the **Gain/Loss** field on the Retire Assets page. Any realized loss is not recognized.

3. Add the new asset by using the Asset ExpressAdd component.

Select *Like-Kind Exchange* as the acquisition code, and select the asset ID of the retired asset.

The asset category automatically displays the category of the retired asset, and the cost fields are populated with the cost basis for the new asset. You cannot change either the category or the cost amounts.

Note: The FV entered on the Like Kind Exchange page is not automatically assigned as the fair value of the newly acquired asset.

See [Adding and Maintaining Asset Information](#).

PeopleSoft Asset Management prorates basis calculations when you perform a one-to-many exchange.

Field or Control	Description
One to Many ID	Enter a one-to-many ID to identify the exchange.

Field or Control	Description
Transaction Trade In Value/Description	For each asset that you add, enter a trade-in value and description.

Like-Kind Exchange Example

If the owner of Building A wants to exchange it for Building B, Building A is retired using the like-kind disposal code, and Building B is added through the Asset ExpressAdd component.

Transaction	Building A (Retiring)	Building B (Adding)
Cost	85,000 USD	60,000 USD
Liability (Mortgage)	70,000 USD	30,000 USD
Accumulated Depreciation	10,000 USD	None

PeopleSoft Asset Management calculates *boot*, which is any cash or non-like property that is involved in the transaction, like this:

$$(\text{Cash Received}) + (\text{FV of Non-like Property Received}) + (\text{Liability Assumed}) = \text{Boot}$$

Note: Boot is money or other property that does not qualify for nonrecognition of gain.

In this example, boot is calculated like this: $0 + 0 + 40,000 = 40,000$.

When you run the Depreciation Calculation process, the process identifies the recognized gain as the lesser of the boot amount or the realized gain.

In this example, in which the boot amount is 40,000 and the realized gain is 25,000, the recognized gain is 25,000.

PeopleSoft Asset Management calculates the cost basis of the property exchanged (retired) like this:

$$(\text{Cost}) - (\text{Accumulated Depreciation}) = (\text{Cost Basis of Property Exchanged})$$

In this example, it is calculated like this: $85,000 - 10,000 = 75,000$

PeopleSoft Asset Management calculates the cost basis of the added property added like this:

$$(\text{Basis of Retired Property}) - (\text{Boot Amount}) + (\text{Recognized Gain or Loss}) = (\text{Basis of the Added Property})$$

In this example, it is calculated like this: $75,000 - 40,000 + 25,000 = 60,000$

Retire/Reinstate Assets - Other Options Page

Use the Retire/Reinstate Assets - Other Options page (ASSET_RETIRE_02) to select assets to be retired based on gain or loss and on other options.

Navigation:

Asset Management > Asset Transactions > Asset Disposal > Retire/Reinstate Assets > Other Options

This example illustrates the fields and controls on the Retire/Reinstate Assets - Other Options page. You can find definitions for the fields and controls later on this page.

Gain/Loss Calculations

PeopleSoft Asset Management provides three methods for calculating retirement gain or loss. You can use these methods separately or in combination. Select the appropriate check box in the **Gain/Loss Calculations** group box.

Field or Control	Description
<p>Use Original Cost and Basis Reduction Code</p>	<p>Select to exclude certain kinds of transactions from the calculation. Do this by selecting a basis reduction code (this selection is required when Use Original Cost is selected).</p> <p>For example, if you revalued an asset but want to exclude the revaluation from the gain/loss calculation at retirement, then you would select the basis reduction code that you set up to exclude revaluations. PeopleSoft Asset Management reverses the revaluation and calculates gain/loss using the resulting net book value.</p> <hr/> <p>Note: For the Use Original Cost option to work correctly, any transaction types that you want to exclude must have distinct transaction codes.</p>

Field or Control	Description
Recalc Cost Using Index (recalculate cost using index), Index Name , and SubIndex	Select to adjust the cost of an asset, as well as any subsequent transactions, according to any index that you have set up in PeopleSoft Asset Management. For example, if you have set up an index to account for inflation, you can calculate gain/loss using the original cost and any subsequent transactions adjusted for inflation. This enables you to book the gain or loss adjusted for inflation. When you select this check box, you must enter an index and subindex to use in the recalculation.
Reference Code	Enter information to track the asset, such as retirement documentation or asset ID. This field is optional.
Include Non-Capitalized Costs	Select to include any non capitalized costs in the net book value of an asset.
Trade In Asset	Displays the ID of the new traded-in asset.
Auto-Retired	Indicates that the asset was automatically retired by the Auto-Retire process (AMRETFDA).

Conversion

Field or Control	Description
Voluntary and Involuntary	Select one or the other to indicate whether this is a Voluntary or Involuntary retirement. This selection is informational only

Type

Field or Control	Description
Ordinary and Extraordinary	Select to indicate how the gain or loss that results from the retirement should be reported. This selection is informational only.

Retire/Reinstate Assets - By ChartField Page

Use the Retire/Reinstate Assets - By ChartField page (ASSET_RETIRE_03) to override PeopleSoft Asset Management calculations when shared assets are partially retired.

Navigation:

Asset Management > Asset Transactions > Asset Disposal > Retire/Reinstate Assets > By Chartfield

This example illustrates the fields and controls on the By Chartfield page. You can find definitions for the fields and controls later on this page.

Quantity	Retire Amt	Refresh Amounts	Salvage Value
-1.0000	-8,543.00		

Override the system selections by entering an amount in the **Retire Amt** (retire amount) field or the **Quantity** field. Typically, you use this page only when assets are split between departments or partially retired.

For example, suppose that the Sales and Marketing departments share 40 color monitors worth a total of 10,000 USD, and these assets are added to PeopleSoft Asset Management. Based on projected use, the Sales department is allocated 70 percent of the total cost and quantity and Marketing is allocated 30 percent. After a couple of years, all the color monitors are upgraded to flat screen, resulting in the retirement of monitors with a total cost of 10,000 USD. Based on the original allocation of cost, the system fully retires the assets with 70 percent of the retirement amount allocated to Sales (department 21101) and 30 percent to Marketing (department 22001).

However, if Sales decides that some of their monitors are worth keeping, only 50 percent, rather than 70 percent, of the total cost is retired. To make these changes, either override the amount in the **Retire Amt** field with 5,000 USD allocated to the Sales department or override the amount in the **Quantity** field with 20 allocated to Sales.

Note: When you perform a retirement by ChartField, for each ChartField combination you can retire only a cost or quantity that is less than or equal to the amount that was originally apportioned to that ChartField combination.

Retire/Reinstate Asset - Child Assets Page

Use the Retire/Reinstate Asset - Child Assets page (CHILD_ASSETS) to select child assets to include in a retirement transaction that you have initiated against the parent on the Retire Assets page.

Navigation:

Asset Management > Asset Transactions > Asset Disposal > Retire/Reinstate Asset > Child Assets

This example illustrates the fields and controls on the Retire/Reinstate Asset - Child Assets page. You can find definitions for the fields and controls later on this page.

Selected	Tag Number	Description	Child Asset ID	Asset Status	Capitalized Asset	Cost	Currency	Acq Date	In Service Date	Child Details	Asset Information
<input checked="" type="checkbox"/>	P00000000501	Desk	EX_CHILD0002	In Service	<input checked="" type="checkbox"/>	7500.00	USD	03/01/1999		Child Details	Asset Information
<input checked="" type="checkbox"/>	P00000000506	Bookcase	EX_CHILD0013	In Service	<input checked="" type="checkbox"/>	1500.00	USD	02/03/2000		Child Details	Asset Information
<input checked="" type="checkbox"/>	P00000000507	Chairs	EX_CHILD0014	In Service	<input checked="" type="checkbox"/>	5000.00	USD	02/03/2000		Child Details	Asset Information
<input checked="" type="checkbox"/>	P00000000508	Lamps	EX_CHILD0015	In Service	<input checked="" type="checkbox"/>	2500.00	USD	02/03/2000		Child Details	Asset Information
<input type="checkbox"/>	P00000000550	Carpet	000000000220	In Service	<input type="checkbox"/>			03/01/1999	03/01/1999	Child Details	Asset Information

The Child Assets page appears in several different components of PeopleSoft Asset Management. Within the Asset Retirements component, use the Child Assets page to select child assets to include in the retirement transaction that you have initiated against its parent on the Retire Assets page. Also, you cannot view or perform transactions on child assets whose parent was created using the Asset Parent page.

Parent assets created on the Parent Asset page (parent-only assets) do not have cost or basic information. They cannot be viewed in the Parent Child Basic Information component, nor can they be viewed or transacted against in the Asset Cost/Adjust Transfers component, the Asset Retirements component, or the Parent-Child NBV component. If you want to use a parent asset as a reporting umbrella only and access these pages for manipulating child assets in mass, PeopleSoft suggests creating a zero-cost parent asset rather than a parent-only asset. Also, to transact against parent and child assets at one time, parent and child must use the same asset profile. Also, be aware that physical asset components will not be retired when the physical parent component is retired.

Click Select All to include all child assets with the parent in the transaction that you have initiated.

To include only some child assets, select the **Selected** check box for the appropriate rows.

You cannot select capitalized child assets that have a different status from their parent asset. That is, disposed child assets cannot be retired with their parent and child assets that are in-service cannot be reinstated with their parent.

Field or Control	Description
Tag Number	The tag that is assigned to the child asset. Parent and child assets can share the same tag number.
Description	The child asset description.
Child Asset ID	The asset ID that is assigned to the child asset.
Asset Status	Displays the status of the child asset, such as <i>In Service</i> .
Capitalized Asset	Indicates whether the child asset is capitalized or non capitalized.

Field or Control	Description
Cost	The cost of the child asset.
Currency	The currency in which child asset costs are stored.
Acq Date (acquisition date)	The date the asset was acquired.
In Service Date	Displays the In Service date of the child asset.
Child Details	Click a link to access the Child Asset Retire Overrides secondary page and specify additional child asset retirement options, such as retirement type, retirement conversion, and disposal code.
Asset Information	Click a link to access another copy of the Asset Information page of the Asset Basic Information component. The component is populated with the child asset information. The link accesses the Retire/Reinstate Non-Fin Asset page for non capitalized assets.
Include Parent Asset	This option is selected by default. Deselecting this option enables you to perform transactions on child assets while excluding the parent asset from the transactions. However, the transaction details must be specified on the parent.

Child Asset Retirement Options Page

Use the Child Asset Retirement Options page (AM_PARCHD_RET01) to specify retirement overrides for a specific child asset for the transaction, including disposal code, removal cost, proceeds, quantity, retire amount, transaction percentage, convention and retirement option.

For example, you might specify a different retirement disposal code for the child asset.

Navigation:

Click Child Details on the Child Assets page.

Asset Information

Click the **Asset Information** link to access another copy of the Retire Assets page. The page will open populated with the child asset.

Advanced Transaction Details Page

Use the Advanced Transaction Details page (FULL_PART_SEC) to specify transaction overrides for all child assets at once.

Navigation:

Click the **Advanced Txn Details** (advanced transaction details) link to access the Parent Asset Adv Txn Options page, where you can specify overrides that will be applied to all child assets at one time.

Proceeds and Removal Cost Allocation Page

Use the Proceeds and Removal Cost Allocation page (AM_PARCHD_ALLOC) to specify allocation options to calculate removal cost and proceeds for the parent (if selected) and selected children.

Navigation:

Click the **Allocation Option** link on the Proceeds and Removal Cost Allocation page. This link is only visible for retirements on the Chid Assets page.

This example illustrates the fields and controls on the Proceeds and Removal Cost Allocation page. You can find definitions for the fields and controls later on this page.

Proceeds and Removal Cost Allocation

Child Asset Allocation Options

<p>*Allocation Type <input style="width: 80%;" type="text" value="Proportioned"/> </p> <p>Removal Cost <input style="width: 80%;" type="text" value="0.000"/></p> <p>Proceeds <input style="width: 80%;" type="text" value="0.000"/></p> <p><input checked="" type="checkbox"/> Include Parent Asset</p>	<p>Alloc. Basis <input style="width: 80%;" type="text"/> </p> <p>RC Curr <input style="width: 40%;" type="text"/> </p> <p>Pr Curr <input style="width: 40%;" type="text"/> </p>
--	---

Field or Control	Description
Allocation Type	<p>Select one of the following allocation types:</p> <ul style="list-style-type: none"> • <i>Proportion</i>: The cost of the selected child assets is divided by the cost of the parent asset to determine the percent of removal cost and proceeds to allocate. The removal cost and proceeds are then multiplied by the respective percentages to determine the allocation ((child cost / parent cost) * proceeds or removal cost). • <i>Prorata</i>: This allocation type can be based on cost or quantity, depending upon your selection in the Alloc. Basis field. The total cost or quantity for all selected assets is summed. (If the Include Parent Asset check box is selected, the parent cost or quantity is also summed. For each child selected on the Child Asset page, include the cost or quantity. Then for each individual asset, the cost or quantity is divided by the summed amount to give the assets percentage of the total for all assets. This number will then be multiplied by the Removal Cost and/or Proceeds to determine that assets share of the amounts entered: ((asset cost / summed cost) * proceeds or removal cost). This can also be quantified as: (proceeds/parent cost) * child cost . • <i>Evenly</i>: The amounts entered for removal cost and proceeds are distributed evenly between the selected assets (children and parent, if selected). • <i>Copy</i>: The amounts entered for removal cost and proceeds are copied as is to the selected assets (children and parent, if selected).
Alloc. Basis (allocation basis)	<p>This option is only available when the Allocation Type field value is Prorata. Select to allocate proceeds and removal cost based on:</p> <ul style="list-style-type: none"> • <i>Cost</i> • <i>Quantity</i>
Removal Cost and RC Curr (removal cost currency)	<p>The default value is the parent's removal cost. Retain this original value or change the removal cost to be allocated.</p>
Proceeds and Pr Curr (proceeds currency)	<p>The default value is the parent's proceeds. Retain this value or change the proceeds to be allocated.</p>

Field or Control	Description
Include Parent Asset	This check box retains the value of the Include Parent selection from the Child Asset page. If the check box is not selected on the Child Asset page, the selection is not available for the Proceeds and Removal Cost Allocation page. This selection determines if the parent asset's cost or quantity will be considered for the allocation chosen. This only affects the Prorata and Evenly allocation types and determines if the parent asset value changes. If this option is not selected, the parent asset will not be considered in the calculation or disbursement.

Click OK to trigger the allocation calculation and disbursement of the removal cost and proceeds to the selected assets according to the options that are specified. The Child Asset page will then display. You can run the allocation as necessary; the latest values override any values that already exist on the selected assets. Rounding differences are placed in last asset child that is processed.

Capital Gain Page

Use the Capital Gain page (ASSET_RETIRE_05) to view the calculations for capital gains or losses for a retirement transaction.

Navigation:

Asset Management > Asset Transactions > Asset Disposal > Retire/Reinstate Assets > Capital Gain

This example illustrates the fields and controls on the Capital Gain page. You can find definitions for the fields and controls later on this page.

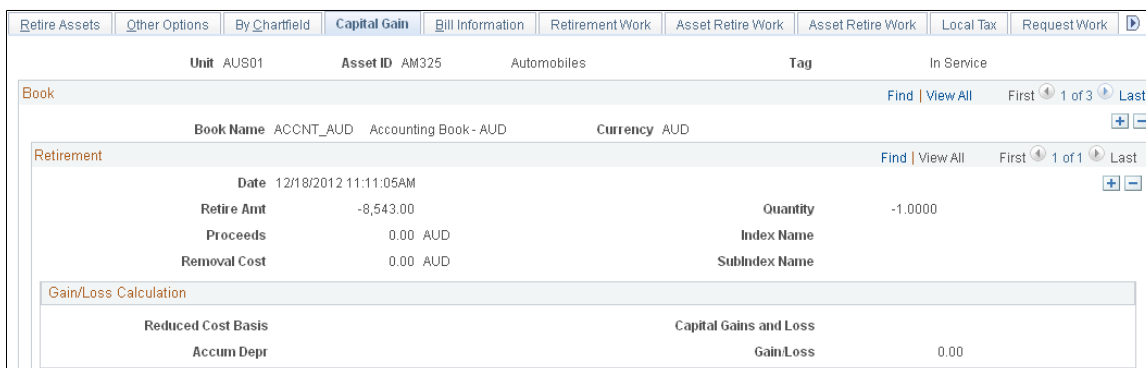

The Capital Gain tab appears when the business unit is enabled for Australian tax. The capital gains or losses for the retirement transaction are summarized on this page after retirement processes have run.

Bill Information Page

Use the Bill Information page (ASSET_RETIRE_07) to define default values for PeopleSoft Billing.

Navigation:

Asset Management > Asset Transactions > Asset Disposal > Retire/Reinstate Assets > Bill Information

This example illustrates the fields and controls on the Bill Information page. You can find definitions for the fields and controls later on this page.

Retire Assets	Other Options	By Chartfield	Capital Gain	VAT	Bill Information	Retirement Work	Asset Retire Work	Asset Retire Work	Local Tax	Request Work	D	
Unit	AUS01	Asset ID	AM325	Automobiles	Tag	In Service						
Book									Find View All	First	1 of 3	Last
Book Name	ACCNT_AUD	Accounting Book - AUD										
Retirement									Find View All	First	1 of 1	Last
Date	12/18/2012 11:11:05AM	Cust ID	1000	Proceeds	2,000.00	AUD						
Bill Data												
BI Unit						Trans Status						
Invoice						Line Seq						

Note: Only assets that are retired with the disposal code *Retirement by Sale* are affected.

PeopleSoft Asset Management can be fully integrated with PeopleSoft Billing to automatically create bills when you retire assets using the *Retirement by Sale* disposal code. If you have implemented PeopleSoft Billing with PeopleSoft Asset Management and you have activated the PeopleSoft Asset Management-Billing interface for the processing business unit, this additional retirement tab is enabled.

Field or Control	Description
BI Unit (billing business unit)	Select the PeopleSoft Billing business unit that processes the asset sale to generate an invoice for the sale transaction. The PeopleSoft Billing business unit is defined at the business unit level, but it can be overridden at the asset level.

Field or Control	Description
Trans Status (transaction status)	<p>Displays the transaction status of the invoice within the PeopleSoft Asset Management process. Values are:</p> <ul style="list-style-type: none"> <p><i>Pending</i></p> <p>When you opt to generate an invoice through PeopleSoft Billing for a retirement transaction, the default status is <i>Pending</i> until the transaction is processed by the PeopleSoft Asset Management-Billing interface (AM_BI_INTFC).</p> <p><i>In Progress</i></p> <p>When the PeopleSoft Asset Management - Billing interface is running, the transaction status is updated to <i>In Progress</i>.</p> <p><i>Complete</i></p> <p>When the retirement transaction has been loaded into PeopleSoft Billing for processing, the transaction status is updated to <i>Complete</i>.</p> <p><i>Ignore</i></p> <p>If you reinstate this asset before the PeopleSoft Asset Management-Billing interface is processed, the bill create and credit bill transactions appear in the interface. In this case, the PeopleSoft system cancels the initial retirement and the status of the billing request changes to <i>Ignore</i>. To proceed with the retirement, you must reenter the retirement transaction. You cannot generate a reinstatement until PeopleSoft Billing creates the invoice number (after BIIF0001 is run). If you reinstate this asset before the PeopleSoft Asset Management-Billing interface is processed but after running depreciation calculation for the retirement, the system cancels the initial retirement and the status of the billing request is changed to <i>Ignore</i>.</p>
Invoice	When the transaction has been processed in PeopleSoft Billing, the invoice number that is assigned appears for future reference.

Field or Control	Description
Line Seq (line sequence)	When the invoice for the sale transaction has been processed in PeopleSoft Billing, the line sequence number for this transaction appears. This value identifies the invoice line number for the asset sale, and it appears when the invoice is generated by PeopleSoft Billing.

PeopleSoft Asset Management sends retirement information to the PeopleSoft Asset Management-Billing business unit (usually the one with the same general-ledger business unit) and then PeopleSoft

Billing generates the invoice to the customer (also a general-ledger business unit). Depending on which PeopleSoft Payables business unit has been defined in the InterUnit billing definition (general ledger business unit definition), PeopleSoft Billing sends asset InterUnit information to PeopleSoft Payables, taking the vendor and location from the retired asset's general-ledger business unit.

If a retirement is processed due to an InterUnit transfer, the information is also sent to PeopleSoft Payables, including asset ID, asset profile, and cost type. When you are performing an InterUnit transaction, you must complete additional information.

Field or Control	Description
AM Unit	Enter the business unit where the system adds or adjusts the asset through the interface with PeopleSoft Payables.
Asset ID	By default, the value is <i>Next</i> , but you can select another existing asset ID.
Profile ID	Select the profile for the asset.
Cost Type	(Optional) Select a cost type.

When you click **Save**, the retirement-by-sale create bill transactions are assigned the transaction status *Pending*. Select the pending transactions to be included when you are ready to run the PeopleSoft Asset Management-Billing (AMBI_INTFC) interface.

AM/BI Interface Page

Use the AM/BI Interface page (RUN_AMBI_INTFC) to run the PeopleSoft Asset Management - Billing interface.

Navigation:

Asset Management > Send/Receive Information > Load Interface > Interface AM to Billing

After you enter retirement transactions for assets that PeopleSoft Billing invoices, you can initiate the process to load the transactions for the AM/BI Interface process (RUN_AMBI_INTFC). Before you launch this process, the retirement entries must be generated.

Enter the run control ID to use or add a new one. Enter the business unit and the asset ID range to be processed, and click **Run**.

The process assembles the pending transactions that you have entered, attaches an interface ID, changes the transaction status to *In Progress*, and displays the transactions in a view page (PS_INTFC_BI). The transactions are loaded into PeopleSoft Billing for processing.

You can run the AM/Billing Transaction Status report to review the transactions that were processed. You can review accounting entries before or after the PeopleSoft Asset Management-Billing interface has been run.

Note: Reinstatements are processed according to two rules. First, if the reinstatement is performed before sending the retirement information to PeopleSoft Billing, neither transaction is processed by the PeopleSoft Asset Management-Billing interface. Second, reinstatements cannot be performed until the PeopleSoft Asset Management-Billing interface application (BIIF0001) has been run for the asset's previous retirement.

When transactions between PeopleSoft Asset Management and PeopleSoft Billing occur, the system provides a clearing account, Proceeds to Billing, which accumulates the income from the transactions and matches the transactions to the PeopleSoft Asset Management accounting entries. This maintains balanced accounting entries between the applications.

Running the AM/Billing Transaction Status Report

Access the AM/Billing Transaction Status page (**Asset Management > Send/Receive Information > Load Interface > Interface AM/BI**)

Enter the appropriate PeopleSoft Asset Management business unit, and range of dates for the transactions that you want to review. Click Run to generate and view the report.

Note: When processing a retirement-by-sale for a parent asset, you cannot generate an invoice for each child asset in the same transaction. You have to dispose of each child asset separately.

Related Links

“Integrating with PeopleSoft Billing” (Asset Lifecycle Management Fundamentals)

VAT Page

Use the VAT page (AM_VAT_TRANS_RET) to specify options to use to calculate VAT on an asset retirement.

Navigation:

Asset Management > Asset Transactions > Asset Disposal > Retire/Reinstate Asset > VAT

This example illustrates the fields and controls on the VAT page (1 of 2). You can find definitions for the fields and controls later on this page.

Retire Assets	Other Options	By Chartfield	Capital Gain	VAT	Bill Information	Retirement Work	Asset Retire Work	▶
Unit	AUS01	Asset ID	AM325	Automobiles	Tag	In Service		
Book	ACCNT_AUD Accounting Book - AUD			Find	First	1 of 3	Last	
Retirement	Date 12/18/12 11:11:05AM			Proceeds	2,000.00	AUD		
Expand All Sections		Collapse All Sections						
▼ Physical Nature								
Physical Nature Goods								
▼ VAT Locations								
Ship From Country AUS			Ship From State					
Ship to Country USA			Ship to State					
VAT Defaults								
▼ VAT Registrations								
Reporting Country AUS			Defaulting State					
Customer Registration Country			Registration ID					
Customer Exception Type None			Certificate ID					
▶ VAT Controls								
▶ VAT Treatments								
▶ VAT Details								
▼ Adjust/Reset VAT Defaults								
Adjust Affected VAT Defaults		Click this button if you want the system to adjust the VAT Defaults on this page affected by changes you have made to this page. All changes you have made to VAT Defaults that affect other VAT Defaults will be retained.						
Levels This level only		Reset All VAT Defaults		Click this button if you want the system to reset all the VAT Defaults. All changes you have made to VAT Defaults will be lost.				
▶ VAT Calculations								

This example illustrates the fields and controls on the VAT page (2 of 2). You can find definitions for the fields and controls later on this page.

VAT Defaults

▼ VAT Registrations

▼ VAT Controls

Calculate at Gross or Net: Calculate at Gross (dropdown), Recalculate at Payment

Calculation Type: Exclusive (dropdown)

Declaration Point: At Invoice Time (dropdown)

Declaration Date: 12/18/2012 (calendar icon)

Rounding Rule: Round Down (dropdown)

▼ VAT Treatments

Treatment: Zero-Rated Goods Export (dropdown)

▼ VAT Details

Applicability: Taxable (dropdown)

VAT Code: AU2 (lookup icon)

Tax Rate: 0.0000

Transaction Type: AEXP (lookup icon)

▼ Adjust/Reset VAT Defaults

Adjust Affected VAT Defaults ⓘ Click this button if you want the system to adjust the VAT Defaults on this page affected by changes you have made to this page. All changes you have made to VAT Defaults that affect other VAT Defaults will be retained.

Levels: This level only **Reset All VAT Defaults** ⓘ Click this button if you want the system to reset all the VAT Defaults. All changes you have made to VAT Defaults will be lost.

▼ VAT Calculations

Transaction Amount	0.00 AUD	Transaction Amount Base	0.00 AUD
Basis Amount	0.00 AUD	Basis Amount Base	0.00 AUD
Tax Rate	0.0000		
Recorded Amount	0.00 AUD	Recorded Amount Base	0.00 AUD
Recalculate			

If asset transactions involve VAT, the Retire/Reinstate Assets component includes the VAT page.

You must complete the following tasks before you can access this page:

- Set up the VAT defaults.
 - Associate the business unit with a general ledger business unit that is associated with a VAT entity.
- Enter customer ship-from information.
- Enter a proceeds amount on the Retire Assets page.
- Select Create Accounting Entries on the Business Unit/Book Definition page.

When you retire an asset, the VAT information is recorded with a VAT account entry type of *VO* (VAT output). If you reinstate an asset that you have retired with VAT options, the reinstatement reverses the VAT entries. When you reinstate an asset, the reversal of the VAT is recorded with a VAT account entry type of *VORE* (VAT output reinstatement).

The VAT page contains several collapsible sections. Each section contains fields that are blank or that display default values. VAT entries are created for all books that generate accounting entries if the associated general ledger business unit is linked to a VAT entity.

The Book collapsible section displays information that is supplied by default from the book that is associated with this asset.

The Retirement collapsible section displays information that is supplied by default from the current retirement transaction that is being processed, or it contains blank fields. Within this section are several group boxes that contain blank and populated fields.

The VAT Calculations collapsible section shows the calculated totals for the VAT transaction based on the values that are selected on the page. It also displays the default VAT information for the business unit, customer, and location.

Physical Nature

This collapsible section describes the physical nature of transactions. Options are *Goods* and *Services*. PeopleSoft Asset Management manages transactions for goods only.

Field or Control	Description
Physical Nature	Indicates whether an object is a good or a service. In many countries, you must report the sale or purchase of goods separately from services.

VAT Locations

You use location information to directly determine the reporting country, defaulting state, customer registration country, and treatment. This information is in turn used to determine customer exception type, VAT controls, and VAT details.

Field or Control	Description
Ship From Country	By default, this field displays the same value that is entered in the Ship from Loc field on the Retire Assets page. This is the asset location or the PeopleSoft Asset Management business-unit location.
Ship From State	If the ship-from country is defined as tracking VAT by state or province, by default this field displays information (when available) based on the Ship from Loc field on the Retire Assets page.
Ship To Country	By default, this field displays the customer's shipping address. This field always has an initial value.
Ship To State	If the ship-to country is defined as tracking VAT by state or province, by default this field displays the information (when available) from the customer's shipping address. .

VAT Defaults

Field or Control	Description
VAT Registrations	<p>The fields in this collapsible section are:</p> <ul style="list-style-type: none"> • Reporting Country: Displays the country for which this VAT is reported. This is the VAT entity's VAT registration country, and it determines many of the VAT defaults. • Customer Registration Country and Customer Registration ID: Display the registration country and ID of the bill-to customer. • Customer Exception Type: Displays the exception that is granted to the customer. Options are <i>None</i>, <i>Exonerated</i>, and <i>Suspended</i>. This value is specified for the bill-to customer. • Defaulting State: If the reporting country requires that VAT be tracked by state or province, this field displays the state within the reporting country that is used to retrieve values from the VAT Defaults table. • Certificate ID: If applicable, displays the ID of the VAT exception certificate that may have been issued to the customer.

Field or Control	Description
VAT Controls	<ul style="list-style-type: none"> • Calculate at Gross or Net: Indicates how VAT is calculated. Options are: <ul style="list-style-type: none"> • <i>Gross:</i> The system calculates VAT before it applies any early payment discounts. • <i>Net:</i> The system calculates VAT after it deducts early payment discounts. If two percentage discounts exist, the system uses the larger of the two when it calculates VAT. The system does not use discount amounts, only discount percentages. <p>The default value comes from the VAT entity registration driver.</p> <hr/> <p>Note: PeopleSoft Asset Management does not manage payment discount. Consequently, net and gross produce the same result. When the retirement transaction is passed to PeopleSoft Billing and a prompt payment discount is available on the invoice, the final VAT that PeopleSoft Billing calculates differs from the estimated VAT that PeopleSoft Asset Management calculates.</p> <hr/> • Recalculate at Payment: Select to enable the recalculation of VAT at payment time to allow for any early payment discounts if you are calculating VAT at gross. This selection causes the system to adjust the VAT amount at the time of payment if the discount has been taken. This value is set by the VAT entity registration driver. <p>If you select <i>Net</i> as the VAT calculation method, recalculation at payment is not permitted.</p> <p>You can select recalculation at payment if the entry is passed to PeopleSoft Billing.</p> • Calculation Type: The default value comes from the PeopleSoft Asset Management business unit driver. Options are: <ul style="list-style-type: none"> • <i>Exclusive:</i> VAT is not included in the proceeds. The VAT basis amount is equal to the proceeds amount. The system calculates the VAT amount by multiplying the VAT basis amount by the VAT rate. • <i>Inclusive:</i> VAT is included in the proceeds. First, the system calculates the VAT basis amount by dividing the proceeds amount by 1 plus the VAT rate. The

Field or Control	Description
	<p>system then calculates the VAT amount by taking the difference between the VAT basis amount and the proceeds amount.</p> <hr/> <p>Note: When the retirement transaction is passed to PeopleSoft Billing, only the <i>Exclusive</i> option is allowed.</p> <hr/> <ul style="list-style-type: none"> • Declaration Point: Select to indicate when VAT transaction information is recognized for reporting purposes. Options are: <ul style="list-style-type: none"> • <i>Invoice:</i> VAT is recognized at time of invoice. • <i>Payment:</i> VAT is recognized at time of payment. • <i>Accounting:</i> VAT is recognized at the time of accounting. • <i>Delivery:</i> VAT is recognized on delivery. <p>This value is set by the VAT entity registration driver and by the defaults in the VAT hierarchy (specifically the PeopleSoft Asset Management business unit, customer, and customer location).</p> <hr/> <p>Note: A VAT declaration point of payment is not valid in PeopleSoft Asset Management.</p> <hr/> • Declaration Date: By default, displays the date of the retirement. You can override this to the actual delivery date. • Rounding Rule: Displays the VAT rounding rule. The value comes from the VAT country driver or VAT entity registration driver definition. Values are: <ul style="list-style-type: none"> • <i>Natural Round:</i> Amounts are rounded normally (up or down) to the precision that is specified for the currency code. For example, for a currency that is defined with two decimal places, 157.4659 would round up to 157.47, but 157.4649 would round down to 157.46. • <i>Round Down:</i> Amounts are rounded down. For example, for a currency that is defined with two decimal places, 157.4699 would round down to 157.46.

Field or Control	Description
	<ul style="list-style-type: none"> • <i>Round Up</i>: Amounts are rounded up with a rounding precision to one additional decimal place. For example, for a currency that is defined with two decimal places, 157.4659 would round up to 157.47, but 157.4609 would round down to 157.46.
VAT Treatments	<p>Treatment: Displays the VAT treatment. Options for asset retirements are:</p> <ul style="list-style-type: none"> • <i>Domestic Goods Sale</i>: Sale of goods where the supplier and customer are located in the same country. • <i>EU Distance Sale</i>: Sale of goods between European Union (EU) countries in which the supplier is registered in an EU country and the purchaser is not registered in an EU country. The VAT rate that is charged is the rate that applies in the supplier's country. • <i>EU Goods Sale</i>: Sale of goods between EU countries. • <i>EU Sale (Simplification)</i>: A transaction between an intermediary and the purchaser in which a sale of goods occurs between EU countries involving three parties: the purchaser, an intermediary (bill-from) supplier, and the actual goods supplier. Each party is located in a different EU country and registered in that country but not in either of the other two countries. This VAT treatment differs from normal EU sales in that the supplier is required to print a different message on the invoice referencing the statute that applies to triangulation, rather than the one that references the statute for normal EU sales. • <i>No VAT Processing</i>: Sale does not require VAT processing. • <i>Outside of Scope</i>: Sale is outside the scope of VAT. • <i>Zero-rated Goods Export</i>: Export of goods is subject to 0-rated VAT. <p>Within the PeopleSoft system, detail VAT treatment values on the transaction lines are used to apply the precise defaults that apply to the transaction lines. The treatment is determined based the rules that apply to the transaction. No VAT reporting or processing can take place without this value.</p>

Field or Control	Description
VAT Details	<p>The fields in this collapsible section are:</p> <ul style="list-style-type: none"> • Applicability: Options are: <ul style="list-style-type: none"> • <i>Taxable:</i> VAT is chargeable. This may be at a 0 or non-0 rate. • <i>Exempt:</i> Item is nontaxable or exempt from VAT, and no VAT is charged. • <i>Exonerated:</i> Item is subject to exoneration from VAT. • <i>Outside of Scope of VAT:</i> Item is outside the scope of VAT, and no VAT is charged. • <i>Suspended:</i> This option is used when the purchasing organization has been granted suspension from paying VAT. This is the same as taxable at a 0 rate. • <i>VAT Only:</i> This option does not apply to PeopleSoft Asset Management; it applies in PeopleSoft Payables only when you are entering a third-party voucher and within General Ledger when you are entering a journal line against a VAT account. • <i>N/A (not applicable):</i> This is valid only for transactions that are completely non-VAT applicable. • VAT Code: Displays the VAT code that defines the rate at which VAT is calculated for the line. These are established on the Tax Code VAT page. Select Set Up Financials/Supply Chain > Common Definitions > VAT and Intrastat > Value Added Tax. • Tax Rate: Displays the VAT percentage. • Transaction Type: Displays the code that categorizes and classifies the transaction for VAT reporting and accounting. These codes are established on the VAT Transaction Types page. Select Set Up Financials/Supply Chain > Common Definitions > VAT and Intrastat > Value Added Tax.

<i>Field or Control</i>	<i>Description</i>
Adjust/Reset VAT Defaults	<p>This collapsible section contains these elements:</p> <ul style="list-style-type: none"> • Adjust Affected VAT Defaults: When you change VAT defaults on this page, the VAT defaults might be associated with other unchanged VAT defaults on the page. For accuracy and consistency, click this button to have the system adjust the VAT defaults that are affected by those that you modified on this page. All changes to VAT defaults that affect other VAT defaults are retained. <hr/> <p>Note: Always click the Adjust Affected VAT Defaults button after changing defaults on the VAT page.</p> <hr/> <ul style="list-style-type: none"> • Levels: For asset retirement, you cannot select which levels to update. The Reset option always resets the defaults at this level only. • Reset All VAT Defaults: Click to have the system reset the VAT defaults based on the value at this level only. All changes that you made to VAT defaults will be lost.
	Click the Information button to list the fields that are adjusted when you select Adjust Affected VAT Defaults .

VAT Calculations

<i>Field or Control</i>	<i>Description</i>
Transaction Amount	Displays the amount of the transaction in the transaction currency. This is automatically calculated based on the proceeds amount.
Transaction Amount Base	Displays the amount of the transaction in the base currency.
Basis Amount	<p>Displays the amount on which the VAT is calculated in the transaction currency. If VAT is calculated at net, this amount is net of any discounts.</p> <hr/> <p>Note: PeopleSoft Asset Management does not manage billing discount functionality.</p> <hr/>
Basis Amount Base	Displays the amount on which the VAT is calculated in the base currency. If VAT is calculated at net, this amount is net of any discounts.

Field or Control	Description
Tax Rate	Displays the applicable VAT percentage.
Recorded Amount	Displays the amount of VAT that is recorded for this transaction in the transaction currency. This is an estimated amount. If PeopleSoft Asset Management is integrated with PeopleSoft Billing, this value is called the Estimated Amount .
Recorded Amount Base	Displays the amount of VAT that is recorded for the transaction in the base currency. If PeopleSoft Asset Management is integrated with PeopleSoft Billing, this value is called the Estimated Amount .
Recalculate	Click to recalculate the VAT for the line.

All VAT edits are applied when you click Save.

Note: In PeopleSoft Asset Management, if you retire an asset and pass the information to PeopleSoft Billing, the VAT Transaction Loader process does not retrieve the VAT information from PeopleSoft Asset Management but from the bill that is created in PeopleSoft Billing. However, if the retirement transaction remains in PeopleSoft Asset Management, the VAT Transaction Loader process gets the VAT information from PeopleSoft Asset Management.

When you run the Accounting Entry Distribution process (AM_AMAEDIST), use the accounting entry template that you would normally use for asset retirements. To make the VAT entry, the system uses an account from the VAT accounting entry template, based on the combination of VAT code, VAT account type, and VAT transaction type that is specified for the retirement. The system first determines whether VAT ChartFields are defined by the VAT code and general-ledger business unit. If no VAT accounting information is found at that level, the system then checks for VAT ChartFields that are defined at the VAT code level. If the retirement is passed to PeopleSoft Billing, PeopleSoft Asset Management does not generate accounting entries in connection with VAT because PeopleSoft Billing creates them.

Note: If PeopleSoft Asset Management is *not* integrated with PeopleSoft Billing, then although VAT is recorded when retiring an asset, PeopleSoft Asset Management does not generate a financial document such as a VAT invoice. If you also record the sale of an asset in PeopleSoft Billing or PeopleSoft Receivables, you might inadvertently record the applicable VAT a second time. In this case, you must ensure that the VAT is not reported on the VAT return twice.

Instead of using the VAT that is recorded in PeopleSoft Asset Management to generate the VAT return, you can use that information to enter the invoice for the sale of the asset in PeopleSoft Billing or PeopleSoft Receivables. In this case, you can copy the VAT into the VAT Transaction table. When running the VAT Transaction Loader process, do not run the process for all products and do not select Asset Management as a VAT transaction source.

Alternatively, you can exclude the PeopleSoft Asset Management VAT transactions from your VAT return. To do so, assign a specific VAT transaction type to asset retirement transactions. Then do not include that VAT transaction type on any line in the VAT report definition (or include it on an additional line in the VAT report definition but do not include the line in the report format).

Related Links

- “VAT Defaults Setup Page” (Asset Lifecycle Management Fundamentals)
- “Understanding VAT” (PeopleSoft Global Options and Reports)
- “Understanding General Ledger VAT Setup and Processing” (PeopleSoft General Ledger)
- “Understanding VAT in PeopleSoft Billing” (PeopleSoft Billing)

Auto-Retire Fully Depr Assets Page

Use the Auto-Retire Fully Depr (Depreciated) Assets page (RUN_AMRETFDA) to identify run-control parameters to initiate the Auto-Retire Fully Depreciated Assets process (RUN_AMRETFDA).

Navigation:

Asset Management > Asset Transactions > Asset Disposal > Auto-Retire Fully Depr Assets

This example illustrates the fields and controls on the Auto-Retire Fully Depr Assets page. You can find definitions for the fields and controls later on this page.

You can retire many assets without individually identifying them by running the Auto-Retire process (AMRETFDA). You enter selection criteria to qualify eligible assets for auto-retirement on the process request, and all selected assets are automatically retired by the process. Only fully depreciated assets can be retired by this process. Fully depreciated assets are assets with an end depreciation date that is less than or equal to the retirement transaction date.

Selection Criteria

Field or Control	Description
Business Unit	This field is required. Select a business unit from the drop-down list. Only business units that have been enabled with the auto-retire feature appear.

<i>Field or Control</i>	<i>Description</i>
Book Name	Select a business unit book from the drop-down list. Only books that have been enabled with the auto-retire feature appear.
Copy Changes to Other Books	Select to keep all books in sync. The system copies the transaction to all books that are set up for an asset.
Category, From Asset, and To Asset	Select as applicable to narrow the parameters by categories or by a range of asset IDs.
Cost Limit	Select assets that cost less than or equal to the cost limit.
Low Value Assets Only	Select this check box to retrieve only low-value assets.
Clustered Assets Only	Select this check box to retrieve only clustered assets.
Trans Date (transaction date) and Acctg Date (accounting date)	Enter the applicable transaction or accounting date to define the selection criteria.

Retirement Options

<i>Field or Control</i>	<i>Description</i>
Convention	Enter a retirement convention to override the asset profile default.
Transaction Code	Select a transaction code to identify the reason for the retirement.
Reference Code	(Optional) Enter information to track the asset, such as retirement documentation or an asset ID.

Disposal Worksheet Page

Use the Disposal Worksheet page (AM_EXPRESS_RET1) to identify and submit assets for disposal.

Navigation:

Asset Management > Asset Transactions > Asset Disposal > Disposal Worksheet

This example illustrates the fields and controls on the Disposal Worksheet page. You can find definitions for the fields and controls later on this page.

The screenshot shows the 'Disposal Worksheet' page in a web browser. The page is titled 'Employee Self Service' and 'Disposal Worksheet'. It features a search criteria section with various input fields: Unit (US001), Book (CORP), Parent ID, Category, Profile ID, FERC Code, From Asset ID, To Asset ID, Group ID, Tag Number, Serial ID, Asset Status (In Service), Location, Area ID, From In-Service Date, and To In-Service Date. There is a checkbox for 'Include Non Capitalized Assets' and a link for 'Chartfield Search Criteria'. Below the search criteria is an 'Acquisition Details' section with a 'Retrieve Next' button, a row count of '100 Rows 1 - 100 Of 559', and a 'New Search' button. At the bottom, there is an 'Asset Action' section with a 'Submit for Disposal' button, a 'Disposal Code' dropdown, 'Retire Date' (03/24/2019), 'Accounting Date' (03/24/2019), 'Adjust Retire Quantity By', 'Adjust Retire Amount By', and a 'Set All' button.

This example illustrates the fields and controls on the Disposal Worksheet page. You can find definitions for the fields and controls later on this page.

The screenshot shows the 'Search Results' table with the following columns: Dispose, Asset ID, Description, Capitalized Asset, Asset Type, Tag Number, Category, and Serial ID. The table contains 13 rows of data. The row with Asset ID 00000000104 is highlighted in yellow. Below the table is a 'Submit for Disposal' button.

Dispose	Asset ID	Description	Capitalized Asset	Asset Type	Tag Number	Category	Serial ID
<input type="checkbox"/>	00000000091	Automobile	<input checked="" type="checkbox"/>	Fleet		AUTO	
<input type="checkbox"/>	00000000092	High Speed Copier	<input checked="" type="checkbox"/>	Equipment		OFFCE	
<input type="checkbox"/>	00000000094	High Speed Copier	<input checked="" type="checkbox"/>	Equipment		OFFCE	
<input type="checkbox"/>	00000000095	High Speed Copier	<input checked="" type="checkbox"/>	Equipment		OFFCE	
<input type="checkbox"/>	00000000096	High Speed Copier	<input checked="" type="checkbox"/>	Equipment		OFFCE	
<input type="checkbox"/>	00000000100	L01	<input checked="" type="checkbox"/>	Fleet		LAUTO	
<input type="checkbox"/>	00000000102	L03	<input checked="" type="checkbox"/>	Fleet		LAUTO	
<input type="checkbox"/>	00000000104	L05	<input checked="" type="checkbox"/>	Fleet		LAUTO	
<input type="checkbox"/>	00000000105	Asset One	<input checked="" type="checkbox"/>	Fleet		AUTO	
<input type="checkbox"/>	00000000106	Asset_Two	<input checked="" type="checkbox"/>	Fleet		AUTO	
<input type="checkbox"/>	00000000108	Asset_Four	<input checked="" type="checkbox"/>	Fleet		AUTO	
<input type="checkbox"/>	00000000109	test	<input checked="" type="checkbox"/>	Fleet		AUTO	
<input type="checkbox"/>	00000000110	Automobile	<input checked="" type="checkbox"/>	Fleet		AUTO	
<input type="checkbox"/>	00000000111	Automobile	<input checked="" type="checkbox"/>	Fleet		AUTO	
<input type="checkbox"/>	00000000112	auto	<input checked="" type="checkbox"/>	Fleet		AUTO	

This page provides numerous selection options to retrieve assets for retirement. Assets that are available for retrieval are determined by asset ownership and user ID.

You can search for assets using ChartField search criteria, and you can view asset ownership information by clicking the **View Ownership Details** link.

When you click **Retrieve**, the result set appears in the tabbed grid at the bottom of the disposal worksheet. You can begin again by pressing the **New Search** button, and use the link to view ownership details.

Asset Search Criteria

Identify assets that are eligible for disposal based on the user's established asset ownership. Assets can be identified based on:

- **Unit**

- **Book**
- **Category**
- **Serial ID**
- **Asset ID**
- **Location**
- **Tag Number**
- **Profile ID**
- **More Filter Options** - select to further limit the search by ChartFields.

You can include non capitalized assets in your search using the **Include Non Capitalized Assets** option.

Acquisition Details

To further identify assets for disposal, complete the following fields:

- **PO Unit** (purchasing unit)
- **Receipt Unit**
- **AP Unit**(payables unit)
- **PC Bus Unit** (projects business unit)
- **PO No.**(PO number)
- **Receipt No**(Receipt number)
- **Voucher**
- **Project ID**

Asset Action

The system returns a list of assets that meet the search criteria. You can review and reselect options to create a new list of assets.

So that you can process assets for disposal, retirement information is specified to indicate the date and reason for an action.

<i>Field or Control</i>	<i>Description</i>
Disposal Code	(Optional) Select the disposal code for all assets in the worksheet list to identify the reason for the disposal of the assets.

<i>Field or Control</i>	<i>Description</i>
Retire Date	Enter a retirement date, which can be retroactive or future-dated. This date is applied to all assets in the worksheet list. The default is the current date.
Accounting Date	Enter the accounting date to be recorded if different from the current date. This date is applied to all assets in the worksheet list.
Adjust Retire Quantity By	Enter the adjust retire quantity, if desired.
Adjust Retire Amount by	Enter the adjust retire amount, if desired. <hr/> Note: Entering a value in the Adjust Retire Quantity By field blanks out the Adjust Retire Amount By Field, and vice versa. <hr/>
Set All	Click to apply the retirement information to all assets in the list.

The list is presented on three tabbed views: Asset Information, Retirement Information, and Optional Accounting Information (such as cost). The information may be hidden, depending on established permissions.

Asset Information

This tabbed view displays the asset ID, description, capitalization status, parent ID, asset type, and tag number.

<i>Field or Control</i>	<i>Description</i>
Submit for Disposal, Select All, and Deselect All	Select assets for disposal individually by selecting the Dispose check box, or select (or deselect) all.

Retirement Information

This tabbed view displays the asset ID, cost, currency, quantity, retire quantity, retirement amount, proceeds, proceeds currency, removal cost, removal cost currency, disposal code, retire date, and detail.

Field or Control	Description
Retire Quantity and Retirement Amount	<p>The fields are updated accordingly when you click the Set All button.</p> <hr/> <p>Note: The Retire Quantity and Retire Amount values are highlighted if their values exceeds the Cost and Quantity values.</p> <hr/>
Proceeds, PR Curr (proceeds currency), Removal Cost , and RC Curr (removal cost currency)	Enter any proceeds or removal cost along with the currency in which the proceeds or costs were incurred as applicable.
Disposal Code	Select disposal codes for each asset individually by entering the code in this field.
Retire Dt	Enter the retirement date.
Detail	Click to view the Asset Details (AM_DISPOSAL_02) page.

Optional Accounting Information

This tabbed view displays the asset ID and accounting date.

Field or Control	Description
Accounting Date	Enter the accounting date for the retirement transaction.
Trans Code (transaction code)	<p>Enter a transaction code to be applied to each asset individually.</p> <hr/> <p>Note: When Retirements by Disposal Code is set up in the Asset Management Business Unit/Book Definition, clicking the Set All button defaults the Trans Code values based on the Disposal Code entered in Asset Action. If you change the Disposal Code of an asset individually, its Trans Code value gets updated accordingly.</p> <hr/> <p>See “Creating PeopleSoft Asset Management Business Units” (Asset Lifecycle Management Fundamentals)</p>

Comments and Attachments

This tabbed view displays the comments and attachments for an asset.

Field or Control	Description
Comments	Click the Comments link to access the Asset Comments page. Use this page to view or add relevant supporting comments to an asset transaction.
Attachments	Click the Attachments link to access the Asset Attachments page. You can view or add relevant supporting attachments to an asset transaction.

Submit Asset Disposal Information

Click **Submit for Disposal** when you have completed the disposal worksheet. The disposal request is processed when you run the Transaction Loader process. It is routed for approval, if required, depending on the permissions that are established for the operator and the setup within the Approval Framework for Asset Management. For more information, see, *Asset Lifecycle Management Fundamentals*, “Understanding Approval Framework in Asset Management” (*Asset Lifecycle Management Fundamentals*)

See also, “Example of Approval Framework Setup for Asset Disposal” (*Asset Lifecycle Management Fundamentals*).

ARO Information

Field or Control	Description
ARO Liability	Displays the remaining balance of the ARO Liability.
ARO Settlement	Enter the actual ARO settlement amount. Note that partial AROs are possible and the ARO Settlement may not be recorded until after an asset is disposed.
ARO Settlement Comments	(Optional) Enter information related to the ARO Settlement.

Approving Disposals

Use the Approve Disposals page (AM_DISP_APPR01) to approve, deny, push back, or place on hold a retirement disposal.

Navigation:

Asset Management > Asset Transactions > Asset Disposal > Approve Disposals

or

Access this page from the approver user’s worklist (Worklist, Worklist):

This example illustrates the fields and controls on the Approve Disposals page. You can find definitions for the fields and controls later on this page.

Approve Disposals

Originator ⓘ

Originator: AMA1 Name: William Crawford Date Submitted: 09/24/2018

Retirement Overrides ⓘ

Retire Date: 09/24/2018 Disposal Code: Retirement by Sale Accounting Date: 09/24/2018 **Default**

Approval Action ⓘ

Comments: _____

 Approve **Deny** **Hold** **Pushback**

Disposals Pending Approval ⓘ

1-1 of 1

Select	Approver Status	Business Unit	Asset ID	Description	Capitalized Asset	Tag Number	Category	Serial ID	Approval Status
<input type="checkbox"/>	Not routed	US001	AB11	test asset	<input checked="" type="checkbox"/>		FF		Pending

Return to Search **Notify**

Approve Disposals | [Approval Map](#)

Access to this component is not restricted to asset owners. Using Approval Framework, you can assign any user (not just asset owners) as an approver. As always, system administrators can restrict access to specific users for the component via permissions lists.

The approval process is managed by the Approval Framework settings for your organization. If the worksheet that you submit for disposal requires approval before being processed by the Transaction Loader process, a worklist entry can be created and routed to the approver. Multiple assets can be associated with one worklist entry. The user who receives the worklist item can approve, deny, push back, or place on hold the requested asset.

The Approval Framework allows multi-level approvals for asset disposals and shows approval maps for a graphical display of the approval process.

For more information, see “Example of Approval Framework Setup for Asset Disposal” (Asset Lifecycle Management Fundamentals).

Originator

Originator is the user who requested the disposal of the listed assets from the Disposal Worksheet.

Retirement Overrides

Select the desired field values with which you want to replace for disposals pending approval, then click the Default button to update the selected asset rows.

Approval Action

Deselect all, select one, many, or all assets within the Disposals Pending Approval group box, enter any comments, and click the desired approval action button.

The approver can select to:

Field or Control	Description
<i>Approve</i>	The request is approved and routed to the next approver, if applicable. Once approved by all approvers, the item has a status of Approved and is loaded to the Transaction Loader process for processing.
<i>Deny</i>	The request is not approved and an email notification is sent to the disposal requestor.
<i>Hold</i>	The request is placed on hold and the approval status is On Hold until further approval action.
<i>Pushback</i>	The approver has pushed back the request to the previous approver for more information.

If no action has been taken on the item, the approval status is *Pending*.

The approver can then select **Mark As Worked** for the Worklist item.

Disposals Pending Approval

Select assets and enter field values, as appropriate, then click the desired approval action button. Some assets may not be selectable depending on the Approver and the Approval Status.

Field or Control	Description
Approver Status	Displays the approval status relative to the current user.
Approval Status	Displays the asset's overall approval status.
Capitalized Asset	Indicates whether the asset is capitalized or non capitalized.
	Select to view the approval flow diagram for the selected asset by line. You can view other approvers and add adhoc approvers from this page.
Comments	Click the Comments link to access the Asset Comments page. Use this page to view or add relevant supporting comments to an asset transaction.

Field or Control	Description
Attachments	Click the Attachments link to access the Asset Attachments page. You can view or add relevant supporting attachments to an asset transaction.

Note: Before applying PeopleSoft Image 4 to your environment, ensure that all Pending assets for disposal are either Approved or Denied. There should be no Pending assets for disposal. Search for assets with a Pending approval status from this page or use the following SQL statement to ensure that no rows are returned: `SELECT * FROM PS_AM_RET_APPR_VW;`

If rows are returned (Pending approval status), use this page to approve or deny them and only then proceed to applying PUM 4. If you deny any pending requests, make note of the assets denied because you must submit them again for disposal AFTER applying the enhancement. If you approve any pending assets, you must complete the Transaction Loader process for the approved assets BEFORE applying the enhancement.

For information about approving disposals using the PeopleSoft Fluid User Interface, see [Pending Approvals - Asset Disposal Page](#).

Approval Map Page

Use the Approval Map page (AM_AF_APPR_MAP) to access a view-only approval flow map of all assets in the disposal request.

Navigation:

Asset Management > Asset Transactions > Asset Disposal > Approve Disposals > Approval Map

or

Access this page from the approver user's worklist (Worklist, Worklist):

This example illustrates the fields and controls on the Approval Map page. You can find definitions for the fields and controls later on this page.

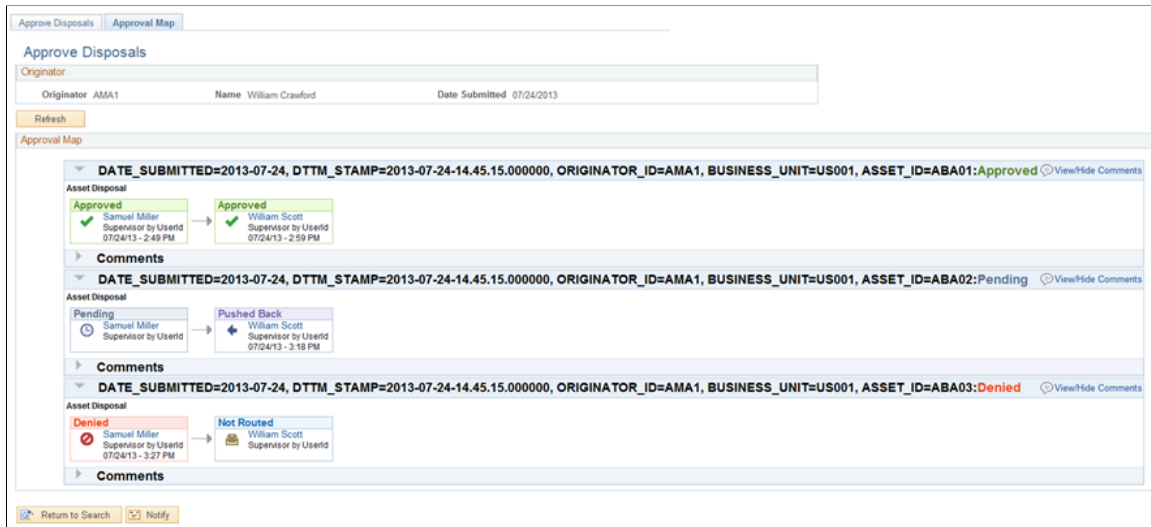

The map displays the approvers for each asset, the approval status for each step, associated dates and comments.

For more information, see *PeopleSoft: Approval Framework*.

Putting Assets up for Auction

When a bid is awarded through Strategic Sourcing, the bid price is returned to PeopleSoft Asset Management as proceeds for the asset that was sold. This transaction updates the asset with the appropriate information for completing the retirement transaction.

Note these points assets that are put up for auction:

- For you to enter an asset as a line item for sale in an auction event, the asset must *not* have the PeopleSoft Asset Management statuses other than *Disposed* and *Transferred*. It must not be a Lease Asset, or a Hazardous Asset. The auction status is equal to *Allowed to be auctioned*.
- When you post the event, the PeopleSoft Asset Management auction status changes to *Sent to Auction*.
- The auction status remains at *Sent to Auction* until the event is awarded or canceled.

If the event is not approved or is not awarded, you must set the status to *Allowed to be Auctioned* to remove the *Sent to Auction* status for the asset. When the event is awarded, Strategic Sourcing sends information to PeopleSoft Asset Management, and you must run the Transaction Loader (AMIF1000) process to finalize the retirement. Strategic Sourcing changes the auction status to *Sold in Auction*.

Note: PeopleSoft Asset Management does not allow PeopleSoft Strategic Sourcing to access data for hazardous materials, intangible assets, or partial retirements. Assets with a status of *Sent to Auction* are excluded from any transactions in PeopleSoft Asset Management until the status is changed by PeopleSoft Strategic Sourcing.

Related Links

“Understanding PeopleSoft Strategic Sourcing Events” (PeopleSoft Strategic Sourcing)

Retiring Non-Financial Assets

This topic discusses how to retire a non-financial asset.

Pages Used to Retire Non-Financial Assets

<i>Page Name</i>	<i>Definition Name</i>	<i>Usage</i>
Non-Financial Retire Page	ASSET_RET_NF_01	Retire non-financial assets.
Non-Financial Retire - Child Assets Page	CHILD_ASSETS	Select child assets to include in a retirement transaction that you have initiated against the parent on the Non-Financial Retire page. This page only appears when the non-financial asset being retired is a parent asset.

Non-Financial Retire Page

Use the Non-Financial Retire page (ASSET_RET_NF_01) to retire non-financial assets.

Navigation:

Asset Management > Asset Transactions > Asset Disposal > Retire/Reinstate Non-Fin Asset > Non-Financial Retire

This example illustrates the fields and controls on the Non-Financial Retire page.

The screenshot displays the 'Non-Financial Retire' page interface. At the top, there are two tabs: 'Non-Financial Retire' (selected) and 'Child Assets'. Below the tabs, the following fields are visible: Unit (US001), Asset ID (ABP04), Tag (test parent asset, noncap), In Service, Trans Date (04/20/2017), and Trans Code. A 'Retirement' section contains a 'Retire' button, a 'Reinstate' button, 'Acq Code' (Purchased), 'Date/Time' (04/20/2017 9:07:07PM), and '*Ret Type' (Retirement by Sale). A 'Lease Information' section includes 'Lease ID', 'Supplier ID', 'Supplier Contact', and 'Inception Date' (04/20/2017).

Select a **Trans Code** and **Ret Type** type. Because the asset is a non-financial asset, there is no gain or loss calculation result.

To retire the non-financial asset, click the **Retire** button.

Note: Nonfinancial assets and operating leased assets do not have cost information. The retirement process, therefore, only involves changing the status of the asset to *Inactive* (or *Disposed*.) In the case of an operating lease, any future lease payments are stopped.

Note: Financial transactions cannot be performed on the Lease Administration Lease Assets through Asset Management.

Reinstating Assets

This topic provides an overview of asset reinstatement and discusses how to retire and reinstate an asset.

Note: Financial transactions cannot be performed on the Lease Administration Lease Assets through Asset Management.

Pages Used to Reinstatement Assets

<i>Page Name</i>	<i>Definition Name</i>	<i>Usage</i>
Retire Assets Page	ASSET_RETIRE_01	Retire or reinstate an asset.
Non-Financial Retire Page	ASSET_RET_NF_01	Retire or reinstate non-financial assets.

Understanding Reinstatement of Assets

On occasion, you may need to reinstate an asset that has been retired.

When you reinstate an asset, all fields on the Retire Assets page become unavailable for data entry. If you want to subsequently retire this asset after reinstatement, you must access the page again.

Reinstatements generate credit lines in PeopleSoft Billing if the retirement has been passed to PeopleSoft Billing. You cannot generate a reinstatement until PeopleSoft Billing creates the invoice number (after the BIIF0001 process is run). If you reinstate an asset before the PeopleSoft Asset Management-Billing interface is processed but after running the depreciation calculation for the retirement, then the PeopleSoft system cancels the initial retirement and the status of the billing request changes to *G* (ignore). In the AM/Billing Transaction Status report, you can track the original invoice for each reinstatement.

Note: Reinstatement of non-financial assets involves changing the asset status to *In Service*. In the case of an operating lease, it involves restarting future lease payments.

Retire Assets Page

Use the Retire Assets page (ASSET_RETIRE_01) to retire or reinstate an asset.

Navigation:

Asset Management > Asset Transactions > Asset Disposal > Retire/Reinstate Asset

Scroll through the retired transactions and select the **Reinstate** check box for the retirement transaction that you want to reinstate for a financial asset. Then, click the **Reinstate** button. For a nonfinancial asset, from the **Non Financial Asset Retirement** page, select Reinstate.

Note: Only one retired asset transaction can be reinstated at a time. If several retired assets transactions are selected for reinstatement, only the first selected transaction in the list is reinstated.

If no retirement transaction is selected for reinstatement and you click the **Reinstate** button, the last retirement transaction against the assets is reinstated.

PeopleSoft Asset Management performs the reinstatement automatically. The **Proceeds**, **Removal Costs**, **Accumulated Depreciation**, and **Gain/Loss** fields are reset to 0, and the amount in the **Retire Amt** field is added back to the balance sheet (for financial assets only).

If depreciation has not been calculated for the gain/loss on retirement, selecting Reinstate causes the retirement rows that you previously created to be purged from the system.

All journal entries that were created by the retirement are reversed. To ensure that asset information posts correctly, the system generates a depreciation request when you reinstate assets. The transaction date is automatically set to the retirement date. If you accidentally or erroneously retired an asset in the wrong period, you have to deduct depreciation from the time the asset was actually retired. Any depreciation to which you were entitled during the accounting periods in which this asset was retired will be calculated and posted to the current accounting period as prior depreciation.

Accounting for Asset Retirement Obligations

This topic provides an overview of accounting for asset retirement obligations (ARO).

Understanding Accounting for Asset Retirement Obligations (ARO)

PeopleSoft Asset Management facilitates compliance with U.S. Generally Accepted Accounting Principles (GAAP) by automating the recognition of asset retirement obligations and the corresponding accretion and depreciation expense. When configured, PeopleSoft Asset Management:

- Flags assets with legal obligations that are associated with retirement to facilitate proper reporting and processing of the retirement obligations in accordance with GAAP.
- Captures the initial measurement of an asset retirement obligation.
- Calculates depreciation of the Asset Retirement Cost.
- Recognizes and measures the asset retirement obligation.
- Provides online schedule of expenses for asset retirement obligation for review.

- Provides accounting and settlement of asset retirement obligation.
- Compliance for leased assets, group assets, and asset impairment.
- Provides GAAP (Generally Accepted Accounting Principles) or IFRS (International Financial Reporting Standards) processing options.
- Provides reports for asset retirement obligation.

This diagram presents the Asset Retirement Obligation process flow within Asset Management:

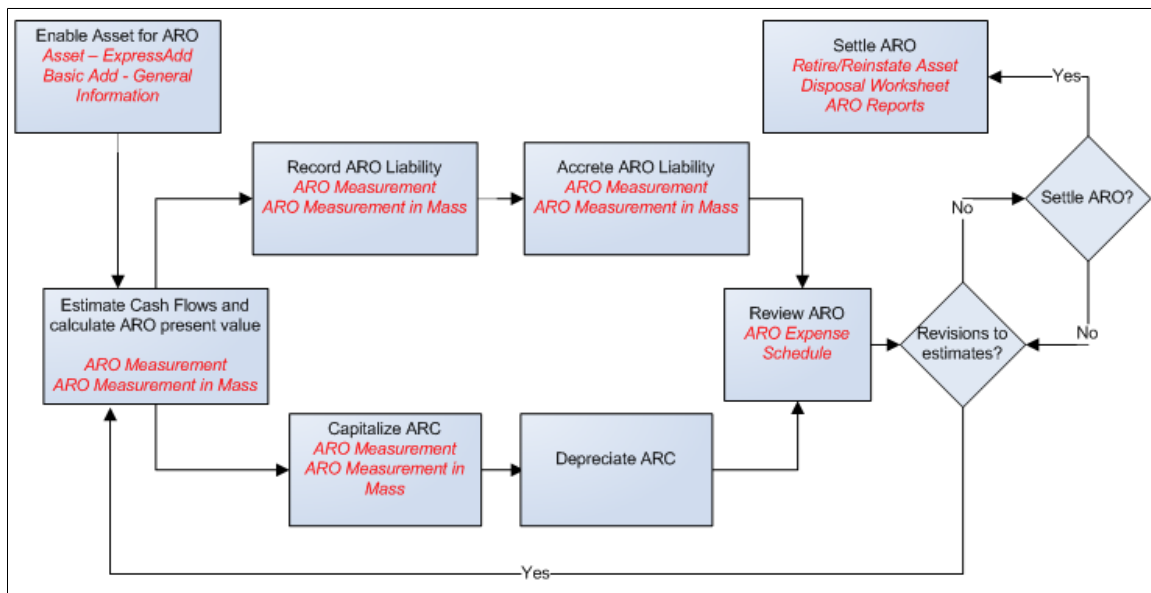

GAAP (Generally Accepted Accounting Principles) and IFRS (International Financial Reporting Standards) Processing Options

Asset Management enables you to process ARO using Generally Accepted Accounting Principles (GAAP) or International Financial Reporting Standards (IFRS). You specify which ARO processing option to use with the “AM Business Unit Definition Page” (Asset Lifecycle Management Fundamentals).

If you use the GAAP option to process ARO, no adjustments are made to the risk-adjusted rate over the life of the ARO asset; the obligation is adjusted only for changes in the amount or timing of cash flows (the obligation continues to be measured using the rate when the decommissioning obligation was incurred).

If you use the IFRS option to process ARO, the risk-adjusted rate is used at the outset, but the rate is adjusted at each reporting date thereafter (the decommissioning obligation is re-measured each reporting period giving consideration to changes in the amount or timing of cash flows and changes in the discount rate).

You can use GAAP option or the IFRS option, but not both—all ARO assets within the business unit must adhere to the same processing method.

The ARO Measurement and ARO Measurement en Masse - Process Parameters pages display different characteristics depending on whether you are processing ARO using GAAP or IFRS.

Common Terminology

The following table includes common terms used in Asset Retirement Obligation functionality:

Term	Definition
Asset Retirement Cost (ARC)	Amount capitalized that increases the carrying amount of the long-lived asset when a liability for an asset retirement obligation is recognized. The ARC is depreciated over the life of the lease as it is part of the asset cost basis and tracked by ARO sequence number.
Asset Retirement Obligation (ARO) Liability	Liability for the obligation associated with the retirement of a tangible long-lived asset. The associated liability is recognized upon capitalization of the related ARC.
Asset Retirement Obligation (ARO)	ARO is the obligation associated with the retirement of a tangible long-lived asset as defined by financial accounting standards.
Accretion Expense	Period-to-period changes in the ARO liability resulting from the passage of time, recognized as an increase in the carrying amount of the liability and an expense charged as an operating item on the income statement.
ARO Settlement	When the ARO-enabled asset is retired, the associated asset retirement obligation is settled (reduce the remaining ARO liability and record an ARO Settlement for the amount actually incurred. The difference between the asset retirement obligation liability and the amount actually incurred is to be recognized as either a gain or loss.
ARO Gain or Loss	Upon ARO Settlement, if the actual cost incurred for the expected liability is greater than the ARO liability recorded, a loss is recognized, and if the actual cost is less than the asset retirement obligation liability, a gain is recognized.

Accounting for Asset Retirement Obligations

The accounting entry templates that correspond to an asset that is flagged as eligible for asset retirement obligations include the distribution types required for ARO processing. Configuration of the ARO distribution types is available from the *Accounting Entry Templates* and the *Accounting Templates en Masse* components.

Transaction Types	Distribution Type
ADJ; RET	ARO Liability
ADJ	Accretion Expense
RET	ARO Settlement
RET	ARO Gain
RET	ARO Loss

For more information, see “Understanding Accounting Entry and Financial Processing” (Asset Lifecycle Management Fundamentals).

Note: The ARO distribution types are included in the Accounting Template Book Code Update process (AM_BKCD_TMPL) and the Book Code Discrepancy Report (AMAE1100).

The ARO distribution types are used to record the following ARO accounting events:

Event Description	Account	Account	Debit	Credit
1) Record initial fair value of the ARO liability:				
	Long-lived asset (ARC)		XX	
		ARO Liability		XX
2) Record accretion expense:				
	Accretion Expense		XX	
	ARO Liability			XX
3) Record revision in estimated ARO Liability (increase):				
	Long-lived Asset (ARC)		XX	
		ARO Liability		XX
4) Record revision in estimated ARO Liability (decrease):				

Event Description	Account	Account	Debit	Credit
	ARO Liability		XX	
		Long-lived Asset (ARC)		XX
5) Record ARO settlement. See Settling the Asset Retirement Obligation				

The following ARO accounting entries do not require ARO-specific distribution types.

1. Record depreciation expense.

See [Depreciating the Asset Retirement Cost](#)

2. Record removal after settlement.

See [Settling the Asset Retirement Obligation](#)

ARO Processing for Asset Impairment

PeopleSoft asset impairment functionality satisfies asset retirement obligation requirements. When asset retirement obligations are recorded in PeopleSoft, an asset cost adjustment recognizes the increase in the carrying value of the related long-lived asset. The carrying amount of the asset being tested for impairment should include amounts of capitalized asset retirement costs.

Note: In the event of a ChartField transfer for an ARO-enabled asset, all accounting entries associated with that asset reflect the new ChartField(s) as of the transaction date of the transfer with an accounting date in the current open period as specified on the transaction.

ARO Processing for Leased Assets

PeopleSoft supports the recording of asset retirement obligations in accordance with GAAP for leased assets. Leased assets are available for ARO selection and processing.

ARO Processing for Group Assets

PeopleSoft Asset Management provides the ability to record asset retirement obligations against group member assets. The asset search criteria on the Asset Retirement Obligations components recognize a business unit this is enabled for group asset processing and displays *Group Asset ID* as an additional search field.

ARO Processing and Document Sequencing

Asset Retirement Obligations should be recorded using a separate document type. All documents entered will be numbered sequentially.

Generating ARC

The **Generate ARC** button creates the entry to record the ARC and the corresponding ARO Liability:

Removal of Capitalized ARC	Debit	Credit
Long-lived Asset (ARC)	XXXX	
ARO Liability		XXXX

Pages Used to Account for Asset Retirement Obligations

Page Name	Definition Name	Usage
<u>ARO Cash Flows Page</u>	ARO_CFLOW_DEFN	Set up expected cash flow definitions to be used in the ARO measurement and describe the specific purpose for the ARO.
<u>ARO Measurement Page</u>	ARO_MEASUREMENT	Define the parameters to be used in the ARO calculations for an individual asset.
<u>Accretion Schedule Page</u>	ARO_ACCR_SCHED	Review the scheduled accretion expense as calculated by month over the life of the asset.
<u>ARO Measurement en Masse – Selection Criteria Page</u>	ARO_MASS_SEL	Retrieve a list of eligible ARO-enabled assets for which to define ARO measurement information.
<u>ARO Measurement en Masse – Process Parameters Page</u>	ARO_MASS_PAR	Define ARO measurement parameters for multiple assets at once.
<u>ARO Measurement en Masse – Accretion Schedule Page</u>	ARO_ACCR_MAS	Review the scheduled accretion expense as calculated by month over the life of the assets that were selected for ARO processing.
<u>Expense Schedule Page</u>	ARO_EXP_SCHED_YR	View the ARO-related accretion and depreciation expense for an asset by year to verify results.
<u>Expense Schedule by Period Page</u>	ARO_EXP_SCHED_PD	View the ARO-related accretion and depreciation expense for an asset by period to verify results.

Page Name	Definition Name	Usage
<u>ARO Reports Page</u>	AM_ARO_RPT_RQST	Run ARO reports that provide information for FAS-compliant disclosures.

Enabling Assets for ARO Processing

In order to facilitate reporting and processing of asset retirement obligations in PeopleSoft, assets with legal obligations associated with their retirement should be flagged as such. To enable assets for ARO processing:

1. Enable ARO processing at the system level (Installation Options – Asset Management page).
See “Installation Options - Asset Management Page” (Application Fundamentals).
2. Enable ARO processing at the business unit level and define ARO processing parameters, such as GAAP or IFRS processing and inclusion of asset retirement cost in the impairment calculation (AM Business Unit Definition Page).
See “AM Business Unit Definition Page” (Asset Lifecycle Management Fundamentals)
3. Use the delivered Cost Type for ARO (value = O) or establish your own to be used for identifying assets that require ARO processing.
See “Cost Types Page” (Asset Lifecycle Management Fundamentals).
4. Create an ARO asset profile (or profiles) to be used in assigning defaults for assets that you designate as subject to ARO processing.
See “Asset Profiles – Definition Page” (Asset Lifecycle Management Fundamentals).
5. Enable ARO for each business unit that has assets requiring ARO processing.
See “AM Business Unit Definition Page” (Asset Lifecycle Management Fundamentals).
6. When adding an asset using the Basic Add component, you can either select an ARO profile to designate the asset as one that requires ARO treatment, or if the profile defaults do not apply to the asset, you can identify the asset eligible for ARO processing by selecting the Asset Retirement Obligations check box.
See General Information Page.
7. When adding an asset using Express Add, you can select the Asset Retirement Obligations checkbox to designate assets eligible for ARO processing.
See Cost/Asset Information Page.

Capturing Asset Retirement Obligations

The initial measurement of an asset retirement obligation represents the amount by which the obligation could be settled in a current transaction between willing parties. An organization assesses whether an

obligating event has occurred and an asset retirement obligation should be recognized. Use the following components for measuring Asset Retirement Obligations (ARO):

- ARO Measurement (ARO_MEASUREMENT)
- ARO Measurement en Masse (ARO_MASS_RQST)
- ARO Expense Schedule (ARO_EXP_SCHED)

This section discusses how to

- Establish the ARO cash flow definition.
- Set up ARO Measurement
- Set up ARO Measurement en Masse

ARO Cash Flows Page

Use the ARO Cash Flows page (ARO_CFLOW_DEFN) to set up expected cash flow definitions to be used in the ARO measurement and describe the specific purpose for the ARO.

Set Up Financials/Supply Chaing > Product Related > Asset Management > Financials > ARO Cash Flows.

This example illustrates the fields and controls on the ARO Cash Flows Page. You can find definitions for the fields and controls later on this page.

Establish effective-dated ARO Cash Flow definitions by SetID to enable consistent data entry of estimated cash flow categories and descriptions.

Field or Control	Description
Status	Select to make the ARO cash flow definition Active or Inactive. This is a required field.
Description	Enter a long description that is to be available for selection from ARO Measurement and ARO Measurement en Masse components. This is a required field.
Short Description	Enter a short description. If blank, this field adopts the truncated long description to fit this field.
Comment	Enter detailed information related to this definition. This field is optional and used for information purposes only.

Measuring Asset Retirement Obligations

This section discusses how to:

- Define ARO Measurement by asset.
- Review the Accretion Schedule.
- Define ARO Measurement for multiple assets.

ARO Measurement Page

Use the ARO Measurement page (ARO_MEASUREMENT) to define the parameters to be used in the ARO calculations for an individual asset.

The ARO Measurement page displays slightly different characteristics depending on whether you are processing ARO using GAAP or IFRS.

Navigation:

Asset Management > Asset Transactions > Asset Disposal > ARO Measurement

This example illustrates the fields and controls on the ARO Measurement Page. You can find definitions for the fields and controls later on this page.

The screenshot shows the 'ARO Measurement' page with the following fields and controls:

- Unit:** ARO01
- Asset ID:** LARO1
- Tag:** LARO1
- In Service:** (checkbox)
- Sequence No:** 0
- *Measurement Date:** 03/30/2018
- Estimated Remediation Date:** (calendar icon)
- *Accounting Date:** 03/30/2018
- *Estimated Life in Periods:** (input field)
- Transaction Code:** (input field)
- Inflation Rate:** 0.000
- Status:** New
- Market Risk Premium Rate:** 0.000
- *Copy ARO To Other Books:** (checked checkbox)
- *Credit Adjusted Risk-Free Rate:** 0.000
- *Rate Type:** CRRNT
- *Book:** CORP
- Currency Code:** USD
- *Convention:** Actual Month
- ARO Comments:** (link)

Expected Cash Flows Table:

*ARO Cash Flow	Txn Unadjusted Cash Flow	*Transaction Currency	Unadjusted Cash Flow	Currency
1	0.00	USD		USD

This example illustrates the fields and controls on the ARO Measurement Page. You can find definitions for the fields and controls later on this page.

The screenshot shows the 'Calculate ARO' section with the following summary data:

Summary			
Txn Unadjusted Cash Flow	0.00	Adjusted Cash Flows- Mkt Risk	0.00
Adjusted Cash Flows- Inflation	0.00	ARO Liability	0.00

Buttons: Load Default Distribution, Recalculate Distribution

Chartfields Table:

*Cost %	Cost	Currency	Cost Type
100.00	0.00	USD	O

Buttons: Copy, Reverse, Generate ARC

Checkboxes: Select to Copy/Reverse, ARC Inherits ARO Parent's Life

Asset Retirement Obligations can only be measured for assets that have a status other than Disposed or Transferred. You can search for assets that are eligible for asset retirement obligation treatment (see [Enabling Assets for ARO Processing](#) and establish the ARO measurement by asset.

Field or Control	Description
Sequence No (sequence number)	Displays the ARO sequence number that is used to track incremental liability measurements, which are adjustments recorded in a period subsequent to the original measurement. The sequence number is generated upon saving the page.

Field or Control	Description
Adjusted Sequence Number	<p>Displays the ARO adjusted sequence number when you create an ARO adjustment.</p> <p>This field appears only when the selected business unit uses IFRS processing and you create a new ARO adjustment.</p>
Measurement Date	<p>Enter the date that the asset retirement obligation is initially recognized. This is the transaction date. The default value is the system date or the transaction date from the AM User Preferences page.</p>
Adjusted Measurement Date	<p>Displays the ARO adjusted measurement date when you create an ARO adjustment.</p> <p>This field appears only when the selected business unit uses IFRS processing and you create a new ARO adjustment.</p>
Estimated Remediation Date	<p>Enter an estimated remediation date for informational purposes only.</p>
Estimated Life in Periods	<p>Enter the period (months) to be used in calculating the ARO liability.</p>
Status	<p>Select a status for the ARO measurement. Values are:</p> <ul style="list-style-type: none"> • <i>Adjustment</i> • <i>New</i> • <i>On Hold</i> • <i>Processed</i> • <i>Error</i> • <i>Reversed</i> <p>The ARO measurement information can be updated for Adjustment, New, Error, or On Hold statuses.</p>
Inflation Rate	<p>Enter the percentage rate to be used to adjust expected cash flows for the ARO.</p>
Market-Risk Premium Rate	<p>Enter a market risk factor percentage to be used to adjust expected cash flows for the ARO. As this is usually difficult to assess, this field is not required.</p>
Credit-Adjusted Risk-Free Rate	<p>Enter the percentage to be used in calculating the accretion expense and the present value of the expected cash flows for the ARO.</p>

Field or Control	Description
Book	Displays the asset book information will be registered for only one Book since the measurement will be the same for all books.
Convention	Select the depreciation convention to be assigned to the resulting asset cost adjustment. The default value is the Actual Month convention.
Accounting Date	Enter the accounting date for the measurement of ARO. The default value is the system date or the accounting date from the AM User Preferences page.
Transaction Code	Select the value that identifies which accounting entry template to use for the transaction. This field is optional.
Rate Type	Enter the currency exchange rate type for the ARO if using multiple currencies.
Copy ARO to Other Books	Select this option to copy the asset retirement obligation to all other required books for the asset. If you selected the Keep All Books in Sync option at the business unit level, the system automatically selects this option.
ARO Comments	Click this link to access the ARO Comments modal page to optionally include additional information about assumptions used in estimating cash flows, for example.

Expected Cash Flows

Field or Control	Description
ARO Cash Flow	Select the ARO Cash Flow definitions that apply to this asset for calculation.
Txn Unadjusted Cash Flow (transaction unadjusted cash flow)	Enter the initial expected cash flow (in the transaction currency), which is an estimate of the amount for which an obligation could be settled in a current transaction between willing parties.
Transaction Currency	Select the transaction currency for the expected cash flows. The default value is the base currency of the asset book.
Unadjusted Cash Flows	Displays the expected cash flow in the base currency.

Field or Control	Description
Currency	Displays the base currency of the asset book.
Calculate ARO	Click this button to initiate the calculation of the ARO liability.

Summary

Field or Control	Description
Txn Unadjusted Cash Flow (transaction unadjusted cash flow)	Displays the sum of amounts entered in the Txn Unadjusted Cash Flow column.
Adjusted Cash Flows - Inflation	Displays the (sum of Txn Unadjusted Cash Flow) x (1+Inflation rate) ^ estimated life).
Adjusted Cash Flows - Market Risk	Displays the (sum of expected cash flows as adjusted for inflation) x (market risk premium).
ARO Liability	Displays the (sum of expected cash flows as adjusted for inflation) + (sum of expected cash flows as adjusted for market risk premium) x (1/(1+credit adjusted risk free rate) ^ estimated life).
Load Default Distribution	Click this button to load the default ChartFields for the accounting entries for ARO processing.
Recalculate Distribution	When making changes to the information, click this button to revise the distribution.

ChartFields

Field or Control	Description
Select to Copy, Reverse, or Adjust	Select this option to copy, reverse, or adjust the ARO measurement data. When you select this check box, click the corresponding button (Copy, Reverse, Adjustment).
Copy	Click to copy ARO measurements for another asset.

Field or Control	Description
Reverse	For assets whose ARO measurement status is Processed, you can select the Copy or Reverse option and click this button to revert any measurements already processed. This action marks the row as reverted and it creates a new sequence number with a status of Reversed. The reversed row is the same as the original, display only, and creates a negative ARC request.
Adjust	Click to create a new ARO measurement row that you can use to input new measurement values. This button is available only when the selected business unit uses IFRS processing.
Generate ARC	Click to insert the information into the INTFC_FIN and INTFC_PHY_A tables, which is then processed by the Transaction Loader to create the ARO asset. When the process is run to generate the Asset Retirement Cost (ARC) entries, the ARC amount is capitalized and increases the carrying amount of the long-lived asset when the ARO liability for an asset is recognized. This process records the initial fair value (or estimated future cash flow) of the ARO liability.
ARC Inherits ARO Parent's Life	Select this option for ARC to inherit ARO Parents life. When an Asset Retirement Cost (ARC) measurement asset is added to the original asset, the measurement asset will use the remaining life of the original asset.

Click the **Comments** link to access the ARO Measurement - Comments page and view or add relevant supporting comments to an asset transaction.

Click the **Attachments** link to access the ARO Measurement - Attachments page and view or add relevant supporting documents to an asset transaction.

ARO Measurement - Comments Page

Use the ARO Measurement - Comments page (AM_COMMENTS_SEC) and view or add relevant supporting comments to an asset transaction.

Field or Control	Description
Comment	Enter comments for an asset.

Field or Control	Description
User ID, Name and Date/Time Stamp	Displays the user ID, name, and date/time stamp related to the user who added the comment. You can edit the date/time stamp after saving the comment.
Source	Displays the transaction source for the asset, such as adjustment, transfer, and so forth.

ARO Measurement - Attachments Page

Use the ARO Measurement - Attachments page (AM_ADD_ATTACH_SEC) to view or add relevant supporting documents to an asset transaction.

Field or Control	Description
Add Attachment	Click this button to attach files as supporting documentation for an asset. Supply a description of the file or files that you attach.
File Name	Displays the attached file. Click the file-link to access the file.
Description	Displays a description of the file attachment when one was provided by the user.
User, Name, and Date/Time Stamp	Displays the user ID, name, and date/time stamp related to the user who added the attachment.

Accretion Schedule Page

Use the Accretion Schedule page (ARO_ACCR_SCHED) to review the scheduled accretion expense as calculated by month over the life of the asset. (Asset Management, Asset Transactions, Asset Disposal, ARO Measurement, Accretion Schedule):

Navigation:

Asset Management > Asset Transactions > Asset Disposal > ARO Measurement > Accretion Schedule

This example illustrates the fields and controls on the Accretion Schedule Page. You can find definitions for the fields and controls later on this page.

Year	Period	Beginning Balance	Accretion Expense	Ending Balance	Status
1	2013	9,086.95	37.86	9,124.81	Pending
2	2013	9,124.81	37.86	9,162.67	Pending
3	2013	9,162.67	37.86	9,200.53	Pending
4	2013	9,200.53	37.86	9,238.39	Pending
5	2013	9,238.39	37.86	9,276.25	Pending
6	2013	9,276.25	37.86	9,314.11	Pending
7	2013	9,314.11	37.86	9,351.97	Pending
8	2013	9,351.97	37.86	9,389.83	Pending
9	2013	9,389.83	37.86	9,427.69	Pending
10	2013	9,427.69	37.86	9,465.55	Pending
11	2013	9,465.55	37.86	9,503.41	Pending
12	2013	9,503.41	37.89	9,541.30	Pending
13	2014	9,541.30	39.76	9,581.06	Pending
14	2014	9,581.06	39.76	9,620.82	Pending
15	2014	9,620.82	39.76	9,660.58	Pending

The Accretion Schedule page displays the scheduled accretion expense, by period, over the asset life using the parameters from the ARO Measurement page. This page also displays the beginning balance of the ARO liability, increased by the accretion expense for each period, the ending balance of the ARO liability, and the ARO status.

See [Accreting the Asset Retirement Obligation](#).

When a correction is performed to the ARO Measurement and you create a reversal, the posted Accretion Expense rows are reversed and those rows not yet posted are deleted. Accretion Expense entries should use the same ChartField combinations that are entered for the ARO measurement.

Depreciating the Asset Retirement Cost

When an asset retirement obligation is measured, an asset retirement cost is capitalized by increasing the carrying amount of the long-lived asset by the same amount as the liability. Since the asset retirement cost is included in the cost basis of the asset, it is subject to the regular depreciation process. Depreciation that corresponds to asset retirement cost is identified by ARO sequence number.

Each ARO sequence number represents each incremental liability measured.

Note: Bonus depreciation does not apply to asset retirement cost.

<i>Record depreciation expense</i>		<i>Debit</i>	<i>Credit</i>
	Depreciation Expense (ARC)	XX	

Record depreciation expense			Debit	Credit
		Accumulated Depreciation		XX

Accreting the Asset Retirement Obligation

Organizations are to recognize period-to-period changes in the liability for the asset retirement obligation resulting from the passage of time, and revisions to either the timing or amount of the original estimated future cash flows.

The Accretion Expense is processed through the Depreciation Close program (*AM_DPCLOSE*).

Record accretion expense			Debit	Credit
	Accretion Expense		XX	
		ARO Liability		XX

Changes due to the passage of time are measured by recognizing accretion expense. The method commonly used to calculate accretion expense is the interest method of allocation. Using the interest method of allocation, accretion expense is determined by multiplying the carrying value of the liability at the beginning of each period by a constant effective interest rate. The interest rate used should be the credit-adjusted risk-free rate applied when the liability was measured initially. The rate should not change subsequent to the initial measurement.

Monthly Accretion = (Beginning ARO Liability Balance for year x Credit-Adjusted Risk-Free Rate)/ yearly calendar (similar to Depreciation Close process).

ARO Measurement en Masse – Selection Criteria Page

Use the ARO Measurement en Masse – Selection Criteria page (*ARO_MASS_SEL*) to retrieve a list of eligible ARO- enabled assets for which to define ARO measurement information. (Asset Management, Asset Transactions, Asset Disposal, ARO Measurement en Masse, Selection Criteria):

Navigation:

Asset Management > Asset Transactions > Asset Disposal > ARO Measurement en Masse > Selection Criteria

This example illustrates the fields and controls on the ARO Measurement en Masse - Selection Criteria page. You can find definitions for the fields and controls later on this page.

Asset Search Criteria

Enter your selection criteria to retrieve a list of ARO-enabled assets that are eligible for ARO accounting treatment and click the Retrieve button. Once you have selected the assets to process from the search results, defined the process parameters, and reviewed the accretion expense schedule, click the Run button to process the selected assets for ARO. The search criteria fields on this page are the same as those on the ARO Measurement page. See [ARO Measurement Page](#).

Search Results

Field or Control	Description
Select Asset	Select the assets that you want to include in the mass ARO process. You could also click the Select All button, the Deselect All button.
Default	Select this check box for the asset whose ChartField combinations are to be used as the default ChartField distribution on the Process Parameters page.
Remove From List	Select the Select Asset check box adjacent to the assets that you would like to remove from the search results grid for processing and click the Remove From List button.

ARO Measurement en Masse – Process Parameters Page

Use the ARO Measurement en Masse – Process Parameters page to define ARO measurement parameters for multiple assets at once.

Navigation:

Asset Management > Asset Transactions > Asset Disposal > ARO Measurement en Masse > Process Parameters

This example illustrates the fields and controls on the ARO Measurement en Masse - Process Parameters page. You can find definitions for the fields and controls later on this page.

The screenshot shows the 'Process Parameters' tab of the ARO Measurement en Masse interface. It includes a 'Run' button and various configuration options. The 'Expected Cash Flows' table is currently empty, showing only the header row. The 'Summary' section displays zero values for both unadjusted and adjusted cash flows. The 'Chartfields' section is also empty.

After selecting the assets to be processed for ARO accounting treatment from the Selection Criteria page, you can set your process parameters on this page for processing those assets at once.

The fields on the Process Parameters page are the same as to those on the ARO Measurement page. The ARO Measurement page, however, is used for processing individual assets as opposed to processing a group set of assets.

See [ARO Measurement Page](#).

When you have entered the process parameters on this page, click the Run button to process the selected assets. The AM_ARO_MASS Application Engine process then populates the tables that are defined in ARO Measurement component. You can review the output of this process from the inquiries and reports that are provided for meeting ARO reporting requirements. See [Reviewing ARO Processing Results and Reporting for Asset Retirement Obligations](#).

ARO Measurement en Masse – Accretion Schedule Page

Use the ARO Measurement en Masse – Accretion Schedule page (ARO_ACCR_MAS) to review the scheduled accretion expense as calculated by month over the life of the assets that were selected for processing. (Asset Management, Asset Transactions, Asset Disposal, ARO Measurement en Masse, Accretion Schedule):

This page is identical to the ARO Measurement - Accretion Schedule page.

See [Accretion Schedule Page](#)

Reviewing ARO Processing Results

PeopleSoft Asset Management delivers the following inquiries by which to review ARO processing results:

- Expense Schedule
- Expense Schedule by Period

Expense Schedule Page

Use the Expense Schedule page (ARO_EXP_SCHED_YR) to view the ARO-related accretion and depreciation expense for an asset by year to verify results

Navigation:

Asset Management > Asset Transactions > Asset Disposal > ARO Expense Schedule > Expense Schedule

This example illustrates the fields and controls on the Expense Schedule Page. You can find definitions for the fields and controls later on this page.

Expense Schedule		Expense Schedule by Period	
Unit	ARO01	Asset ID	RETOBG2
		RET0BG2	
Tag		In Service	
Book			
Find	View All	First	1 of 1 Last
Book	CORP	Corporate	Currency
			USD
ARO Liability			
ARO Liability Balance	11.04	As Of Fiscal Year	2013
		Period	1
Calculate Liability Balance			
ARO Expense Schedule		Personalize Find View All	
First	1 of 1	Last	
Fiscal Year	Accretion Expense	Depreciation Expense	Total Expense
1	2013	11.04	11.04
ARO Settlements		Personalize Find View All	
First	1 of 1	Last	
Fiscal Year	ARO Settlement		
1			

The schedule of expenses related to asset retirement obligations includes accretion expense for the liability and depreciation expense for the associated asset retirement cost. If the ARO liability has been settled, the ARO Settlement and associated fiscal year appear.

Field or Control	Description
ARO Liability Balance	Displays the resulting calculation for the asset ID: (Initial Measurement +/- Re-measurements or settlements) + Accretion Expense.)
Fiscal Year	Select the fiscal year for which you want to review resulting values for the asset.
Period	Enter the period for which you want to review resulting values for the asset.
Calculate Liability Balance	Click this button to calculate the ARO liability balance as of the selected fiscal year and period.

ARO Expense Schedule

View the Accretion, Depreciation, and Total Expense related to ARO for the asset by fiscal year. You can click the Fiscal Year link to access the expense detail for the entire year.

Expense Schedule by Period Page

Use the Expense Schedule by Period page (ARO_EXP_SCHED_PD) to view the ARO-related accretion and depreciation expense for an asset by period to verify results.

Navigation:

Asset Management > Asset Transactions > Asset Disposal > ARO Expense Schedule > Expense Schedule by Period

This example illustrates the fields and controls on the Expense Schedule by Period Page. You can find definitions for the fields and controls later on this page.

The screenshot displays the 'Expense Schedule by Period' page. At the top, it shows 'Unit ARO01', 'Asset ID RETOBG2', and 'Tag RETOBG2'. Below this, there's a 'Book' section with 'Book CORP Corporate' and 'Currency USD'. The 'ARO Liability' section shows 'ARO Year Liability Balance -1426.17' for 'Year 2013'. A 'Get Expense Schedule' button is present. The main 'ARO Expense Schedule' table has columns: Year, Period, Accretion Expense, Accretion Detail, Depreciation Expense, and Total Expense. It lists 12 periods for 2013, with Accretion Expense values ranging from 11.04 to 11.05. Below this is the 'ARO Settlements' table with columns: Year, Period, ARO Settlement, showing a settlement of -1558.66 for period 2 in 2013.

Field or Control	Description
ARO Year Liability Balance	Displays the resulting calculation for the asset ID: (Initial Measurement +/- Re-measurements or settlements) + Accretion Expense.)
Year	Select expense schedule year.
Get Expense Schedule	Click this button to populate or refresh the ARO Expense Schedule and ARO Settlements data for the selected year.

ARO Expense Schedule

Field or Control	Description
Year	Displays the selected year for viewing expense schedule detail.
Period	Displays the calendar periods within the selected year for which data exists.

Field or Control	Description
Accretion Expense, Depreciation Expense, and Total Expense	Displays the Accretion, Depreciation, and Total expenses for each period of the selected year.
Accretion Detail	Click the Accretion Detail icon to view the accretion expense detail by sequence number for the period. The sequence field represents the ARO sequence number that is used to identify incremental liability incurred subsequent to the initial measurement.

Settling the Asset Retirement Obligation

Asset retirement obligations can be settled partially or in full. When an asset is retired and the asset retirement obligation is settled, the difference between the asset retirement obligation liability and the amount actually incurred is to be recognized as either a gain or loss. If the actual cost is greater than the ARO liability, a loss is recognized, and if the actual cost is less than the asset retirement obligation liability, a gain is recognized.

Use the Retire/Reinstate Asset component or the Disposal Worksheet component to record the settlement of asset retirement obligations.

See [Retire Assets Page](#)

See [Understanding Asset Retirement Using the Disposal Worksheet](#)

Accounting Entities for Settlement of Asset Retirement Obligation

The following tables present the scenarios for accounting entries of ARO Settlement:

Settlement of ARO Without Recognized Gain or Loss:	Debit	Credit
ARO Liability	XXXX	
ARO Settlement		XXXX

Settlement of ARO with Recognized Gain	Debit	Credit
ARO Liability	XXXX	
ARO Settlement		XXXX
Gain on Settlement of ARO		XXXX

Settlement of ARO with Recognized Loss	Debit	Credit
ARO Liability	XXXX	
ARO Settlement		XXXX
Loss on Settlement of ARO	XXXX	

Removal of Capitalized ARC	Debit	Credit
Accumulated Depreciation	XXXX	
Long-lived Asset (ARC)		XXXX

Reporting for Asset Retirement Obligations

PeopleSoft Asset Management delivers the following ARO reports:

- Asset Retirement Obligations (AMARORPT01 BI Publisher report) – This report identifies the beginning and ending aggregate carrying amount of an asset retirement obligation and provides the information to assist in preparing disclosures in accordance with Financial Accounting Standards.
- ARO Pending Settlement (AMARORPT02 BI Publisher report) – This report identifies outstanding asset retirement obligation settlements and provides Asset Managers and Asset Accountants with visibility to those assets retired but pending remediation.

ARO Reports Page

Use the ARO Reports page (AM_ARO_RPT_RQST) to run reports that provide ARO compliance information.

Navigation:

Asset Management > Financial Reports > Cost and Depreciation > ARO Reports > ARO Reports

This example illustrates the fields and controls on the ARO Reports Page. You can find definitions for the fields and controls later on this page.

The screenshot shows the 'ARO Reports' interface. At the top, there are fields for 'Run Control ID' (set to 1), 'Report Manager', 'Process Monitor', and a 'Run' button. Below this is a 'Language' dropdown menu set to 'English'. The main section is titled 'Report Request Parameters' and contains several groups of input fields:

- Unit/Book/Asset Fields:** 'Unit' (US001), 'Book Name' (CORP), 'From Asset Id', and 'To Asset Id'.
- Fiscal Year/Period Range:** A table with 'From Fiscal Year' (2012), 'Period' (11), 'Thru Fiscal Year' (2012), and 'Period' (11).
- Date Range:** 'From' and 'Thru' date pickers.
- ChartField Fields:** A vertical list of fields including 'Category', 'Operating Unit', 'Fund Code', 'Department', 'Program Code', 'Class Field', 'Budget Reference', 'Product', 'PC Business Unit', 'Project', 'Activity', 'Source Type', 'Category', and 'Subcategory'.

Select from any or all of the report request parameters to produce the ARO reports by business unit, book name, and range of asset IDs. You can limit the report period by entering a range of fiscal years and periods or select any date range.

You can further limit your resulting report data by specifying any of the ChartField values, including the Project Costing ChartFields.

Running the Tax Retirement Capital Gains Report (AMTX3210)

This topic lists prerequisites and the pages used to run the Tax Retirement Capital Gains report.

Pages Used to Run the Tax Retirement Capital Gains Report

Page Name	Definition Name	Usage
Run Open Trans Tax (run open transaction tax)	RUN_AMTXOPEN	Run a process that assigns open transaction IDs to the transactions for assets that do not use the straight-line depreciation method.

<i>Page Name</i>	<i>Definition Name</i>	<i>Usage</i>
Calculate SL Depr for Tax	RUN_AMDPCALC_TAX	<p>Run the process that calculates straight-line depreciation for all the pending assets in the AMTXOPEN process and mark the status as complete.</p> <p>For corporations, you must select the Corporation Sec. 291 check box on the Book - Tax page to have the system calculate the ordinary gain and the Sec. 291 gain differently.</p>

Prerequisites

Before you can run the Tax Retirement Capital Gains report, you must run these processes:

- Open Trans - Tax Report

This process assigns open transaction IDs for the transactions of assets that do not use straight-line depreciation.

- Depreciation Calculation Tax

This process calculates straight-line depreciation for all the pending assets in the process and marks the status as complete.

Processing Asset Mass Transactions

Understanding Mass Transaction Manager

Regular business cycles sometime require you to make the same change to a large group of assets. The ability to adjust and transfer many assets at once is essential to efficient asset management. To help you with this aspect of asset management, PeopleSoft introduces the Mass Transaction Manager tool, which can used to carry out the necessary changes to your assets.

Suppose a business restructuring requires you to transfer all assets from the marketing department to the corporate communications department. Transferring these assets manually can be onerous and likely to introduce errors. Mass Transaction Manager, on the other hand, enables you to select a particular set of assets from the database, define the desired changes on those assets, and make those changes by running the Mass Transaction application engine.

You can use Mass Transaction Manager to define mass transactions and simplify mass transaction definition by storing information that enables you to select certain data from the database and modify it in specific ways. With Mass Transaction Manager, all the SQL necessary to retrieve rows for processing is defined within each transaction. Users can then define additional selection criteria using the run control page, which, when run, will create a dynamic where clause based on the additional criteria. Asset Management is delivered with a full complement of transactions that serve the needs of most business applications.

Note: All of the former Mass Change transactions are available in Mass Transaction Manager so you can seamlessly transition to Mass Transaction Manager.

Benefits of Mass Transaction Manager

Some of the benefits of using Mass Transaction Manager include:

- A user-centered design that is intuitive and easy to use, yet powerful.
- An uncomplicated, streamlined process that makes it easy to capture user input and retrieve requisite rows for processing mass transactions.

This simplified process also means you do not have to enter the same data twice.

- Enhanced prompts with subordinate keys.
- Ability to share common code, such as a rounding routine.

Setting Up and Processing Mass Transactions

The steps required to set up and process mass transactions vary slightly depending on whether you are creating your own transactions from scratch, reconfiguring PeopleSoft-delivered transactions, or processing unaltered PeopleSoft-delivered transactions.

Creating Your Own Transactions and Processing the Data

To create your own transactions and process the data in Asset Management:

1. Identify your requirements and the function the transaction must perform.
2. Identify the tables or views that will be used to retrieve the rows for processing.
3. Determine if user input is required.

If user input is required, ensure the *MTM_UEV_AM_SBR* subrecord includes the fields you need. If the subrecord does not contain the fields you need, use Application Designer to add them, then build the tables that use the subrecord.

4. In Application Designer, open the *MTM_LIB_AM* Application Engine.
5. Use the Definition tab to enter information for the new transaction.

It is useful to locate the last transaction you created and add the new transaction after it.

6. Enter a numerical value for the Section field.

Determine the number to use by adding 10 to the previous section value. For example, if the last transaction section value is 90000550, you would enter 90000560 for the new transaction.

Note: Customer created transactions should be assigned section values from 90000000. This will ensure that these custom sections will not be overwritten by delivered transactions which are assigned sections from 00000010.

7. Select the Public (Access) option.
8. Create as many steps as you need for the transaction.
9. If you allow the Set to Empty operator for user entered values, you must include the following PeopleCode:

```
PeopleCode (ApplEng): MTM_LIB_AM.00000030GBLdefault 1900-01-01.Step05.OnExecu=>
te
import AM_PSDMT:Enter:UserEnteredValues;
Local AM_PSDMT:Enter:UserEnteredValues &uev = create AM_PSDMT:Enter:UserEntere=>
dValues();;
Local Record &aet;
&aet = GetRecord(Record.MTM_LIB_AM AET);
MTM_LIB_AM_AET.PSDMT_UEV_LONG = &uev.GetUpdateStatement(MTMTTOOL_AET.OPRID,
MTMTTOOL_AET.PS_OWNER, MTMTTOOL_AET.PSDMUNIT_ID, MTMTTOOL_AET.RUN_CNTL_ID, &aet);=>
```

10. Enter the necessary SQL statement to retrieve the requisite rows for processing.

Ensure that you include the %Binds that include the dynamic where clause and other common %Binds that are used in several transactions, such as transaction date, interface ID, null date, null date-time, and so forth.

11. Save the new transaction.
12. Using the PeopleSoft classic desktop browser UI, define individual transactions and behavior using the Mass Transaction Definition component.

See [Mass Transactions List PageTransaction Definition Page](#)

13. Define the list of available field filters associated with a transaction and configure filter behavior using the Mass Transaction Configuration page.

See [Mass Transaction Configuration Page](#)

14. (Optional) Choose the filter fields to display for a transaction using the Mass Transaction Criteria page.

See [Mass Transaction Criteria Page](#)

15. Set up security for a transaction by associating permission lists with the transaction.

Note: This step can be performed any time after step 12.

See [Mass Transaction Security Page](#)

16. Using the Run Mass Transactions page run the Mass Transaction application engine (MTMTOOL) to generate the dynamic WHERE clause and process the transaction.

See [Run Mass Transactions Page](#)

17. Verify data in the loader tables.

Note: This step is only necessary if you do not use the *Auto Approval Status* option on the Run Mass Transactions run control page and the transaction you processed loads the Asset Management loader tables (INTFC_FIN, INTFC_PHY_A, and INTFC_PHY_B).

See [Pages Used to Verify Data in the Loader Tables](#)

18. Approve changes.

Note: This step is only necessary if you do not use the *Auto Approval Status* option on the Run Mass Transactions run control page and the transaction you processed loads the Asset Management loader tables (INTFC_FIN, INTFC_PHY_A, and INTFC_PHY_B).

See [Pages Used to Approve Changes](#)

19. Populate Asset Management tables with mass transaction data

Note: This step is only necessary if the transaction you processed loads the Asset Management loader tables (INTFC_FIN, INTFC_PHY_A, and INTFC_PHY_B).

See [Page Used to Populate Asset Management Tables with Mass Transaction Data](#)

Configuring PeopleSoft-Delivered Transactions and Processing the Data

To configure PeopleSoft-delivered transactions and process the data in Asset Management:

1. Using the PeopleSoft classic desktop browser UI, reconfigure transactions and behavior using the Mass Transaction Definition component.

See [Mass Transactions List PageTransaction Definition Page](#)

2. Reconfigure the list of available field filters associated with a transaction and modify filter behavior using the Mass Transaction Configuration page.

See [Mass Transaction Configuration Page](#)

3. (Optional) Choose the filter fields to display for a transaction using the Mass Transaction Criteria page.

See [Mass Transaction Criteria Page](#)

4. Configure security for a transaction by associating permission lists with the transaction.

Note: This step can be performed any time after step one.

See [Mass Transaction Security Page](#)

5. Using the Run Mass Transactions page run the Mass Transaction application engine (MTMTOOL) to generate the dynamic WHERE clause and process the transaction.

See [Run Mass Transactions Page](#)

6. Verify data in the loader tables.

Note: This step is only necessary if you do not use the *Auto Approval Status* option on the Run Mass Transactions run control page and the transaction you processed loads the Asset Management loader tables (INTFC_FIN, INTFC_PHY_A, and INTFC_PHY_B).

See [Pages Used to Verify Data in the Loader Tables](#)

7. Approve changes.

Note: This step is only necessary if you do not use the *Auto Approval Status* option on the Run Mass Transactions run control page and the transaction you processed loads the Asset Management loader tables (INTFC_FIN, INTFC_PHY_A, and INTFC_PHY_B).

See [Pages Used to Approve Changes](#)

8. Populate Asset Management tables with mass transaction data

Note: This step is only necessary if the transaction you processed loads the Asset Management loader tables (INTFC_FIN, INTFC_PHY_A, and INTFC_PHY_B).

See [Page Used to Populate Asset Management Tables with Mass Transaction Data](#)

Processing Unaltered PeopleSoft-Delivered Transactions

To process unaltered PeopleSoft-delivered transactions in Asset Management:

1. Configure security for a transaction by associating permission lists with the transaction.

See [Mass Transaction Security Page](#)

2. Using the Run Mass Transactions page run the Mass Transaction application engine (MTMTOOL) to generate the dynamic WHERE clause and process the transaction.

See [Run Mass Transactions Page](#)

- Verify data in the loader tables.

Note: This step is only necessary if you do not use the *Auto Approval Status* option on the Run Mass Transactions run control page and the transaction you processed loads the Asset Management loader tables (INTFC_FIN, INTFC_PHY_A, and INTFC_PHY_B).

See [Pages Used to Verify Data in the Loader Tables](#)

- Approve changes.

Note: This step is only necessary if you do not use the *Auto Approval Status* option on the Run Mass Transactions run control page and the transaction you processed loads the Asset Management loader tables (INTFC_FIN, INTFC_PHY_A, and INTFC_PHY_B).

See [Pages Used to Approve Changes](#)

- Populate Asset Management tables with mass transaction data

Note: This step is only necessary if the transaction you processed loads the Asset Management loader tables (INTFC_FIN, INTFC_PHY_A, and INTFC_PHY_B).

See [Page Used to Populate Asset Management Tables with Mass Transaction Data](#)

Reviewing PeopleSoft-Delivered Mass Transactions

This table lists the mass transactions that are delivered with Asset Management:

Mass Transaction	Description
ADJ - Asset Cost Adjustment	Changes the cost of a set of assets as a percentage of the current cost.
ADJ - Asset Cost Adjustment 2	Changes the cost of a set of assets by a specified amount.
Archive Asset Depr Rpt Entries	Archives the Asset Depreciation Reporting Entries stored in PS_DEPR_RPT table inserting its rows into PS_DEPR_RPT_ARCH table.
Archive NBV Entries	Archives Asset Net Book Value Entries. It inserts rows into table PS_ASSET_NBV_ARCH, selecting from table PS_ASSET_NBV_TBL. PS_ASSET_NBV_TBL is the production asset net book value entry table. PS_ASSET_NBV_ARCH can be used to hold the old net book value entries.
Archive Asset Open Trans	Archives Asset Open Transaction entries (table PS_OPEN_TRANS). It inserts into the Open Trans Archive table (PS_OPEN_TRANS_ARCH), selecting from PS_OPEN_TRANS.

Mass Transaction	Description
Archive Assets Acctng Entries (Archive Asset Acctng Entries)	Archives Asset Accounting Entries. It inserts rows into table PS_DIST_LN_ARCH, selecting from table PS_DIST_LN. PS_DIST_LN is the production asset accounting entry table. PS_DIST_LN_ARCH can be used to hold the old accounting entries.
ASD - Asset Deletion	Inserts asset records into the INTFC_FIN table for deletion.
AUP - Asset Update	This transaction is used to perform changes to the fields that are stored on the asset table (PS_ASSET). It inserts rows into the INTFC_PHY_A table that the Transaction Loader uses to update the asset table. Updates to the asset tag number (set equal to asset_id) and asset serial ID are some examples of how this mass transaction may be used. The physical inventory program uses this mass transaction to update several fields.
BA - Book Addition	This adds a new book to a business unit. This transaction deals with extracting the book and cost information from PeopleSoft Asset Management. Prerequisites include: <ul style="list-style-type: none"> You must add the asset profiles for the new book before running this transaction. The new book must be assigned to the business unit before running this transaction.
BC - Book Copy	This transaction is used to copy the book and cost information from one book to another. An example of when this may be used is when you want to do "what if" analysis. You may want to add a model book to a group of assets to do some reporting on. This transaction is used to copy the data you need from an existing book to your model book. The book to which you are copying must exist for the business unit before processing this transaction.
BKD - Book Deletion	This transaction is used to delete assets from a book/business unit combination. It loads one row into the INTFC_FIN table with the business unit and book combination. The Transaction Loader (AMIF1000) deletes all rows for that BU/Book from tables BOOK, BOOK_TAX_CR, COST, DEPRECIATION, DIST_LN, OPEN_TRANS, and RETIREMENT. The transaction does not alter the business unit setup (BU_BOOK_TBL) for the book. You may do this in the Establish Business Units pages.

Mass Transaction	Description
BKS - Asset Book Change	<p>Asset Book Change enables you to change the convention. For example, if you add over 40% of your assets in the final quarter, you must update the convention from Mid Year to Mid Quarter under certain US Regulations.</p> <p>You can configure the Convention, Adjust Convention, Retire Convention, Retire Option, Depreciation Status, Depreciate When In Service, and the In-Service Date on the Transaction Definition.</p> <p>Additional selection criteria are available for the Transaction Criteria, including asset identifiers such as Tag Number, Serial ID, and Description, as well as various Cost ChartFields.</p>
BSD - Selective Book Delete	<p>This transaction is used to selectively delete books for a group of assets. It differs from transaction BKD - Book Delete, in that BKD deletes book information for an ENTIRE Business Unit / Book combination. With this transaction, you may specify the Business Unit, Book, and range of Assets that you want to have deleted from the system.</p>
CC - Capitalize Into Composite	<p>This transaction is used to capitalize acquisition detail amounts into COMPOSITE assets.</p> <p>This transaction sums the not yet capitalized acquisition detail line amounts for the assets associated with a composite asset. This amount is then spread as the cost to be added for an asset by chartfield, based on the cost percentage of each set of chartfields.</p> <p>The cost for each set of chartfields is inserted into INTFC_FIN. INTFC_PHY_A rows are inserted for the composite member assets so that the acquisition detail lines can be updated as capitalized by the Transaction Loader.</p>
CC - JPN Capitalize Composite	<p>Capitalizes Japanese acquisition detail amounts into composite assets. This transaction sums the uncapitalized acquisition detail line amounts for the assets that are associated with a composite asset.</p>
CR - Composite Retirement	<p>This transaction is used to retire acquisition detail amounts from COMPOSITE assets.</p> <p>The capitalized acquisition detail line amounts for the assets associated with a composite asset are summed and spread across the cost to be retired for an asset by chartfield set, based on the cost percentage of each set of chartfields. It inserts the retirement cost for each set of chartfields into INTFC_FIN.</p>

Mass Transaction	Description
CR - JPN Composite Retirement	<p>This transaction is used to retire acquisition detail amounts from COMPOSITE assets.</p> <p>The capitalized acquisition detail line amounts for the assets associated with a composite asset are summed. That amount is then spread across the cost to be retired for an asset by chartfield set, based on the cost percentage of each set of chartfields. It inserts the retirement cost for each set of chartfields into INTFC_FIN.</p>
Delete Asset Acctng Entries (Delete Archived DIST_LN)	This transaction is used to delete entries from the assets accounting entry table (PS_DIST_LN) that have been archived.
Delete Asset Depr Rpt Entries	This transaction is used to delete entries from the Asset Depr Rpt tables PS_DEPR_RPT, PS_DEPR_RPT_PD_SUM, PS_DEPR_RPT_CF_SUM and PS_ARO_DEPR_RPT.
Delete Asset NBV Entries	This transaction is used to delete entries from the Asset Net Book Value table (PS_ASSET_NBV_TBL).
Delete Asset Open Trans	This transaction is used to delete Open Transaction entries. It should be used after they have been archived. It deletes data from the PS_OPEN_TRANS table.
EURO1 - InterUnit Trf – New Book	This transaction is used to perform mass interunit transfers to a new book. One example of when you'd use this is if you're changing from a 13 to a 12 period calendar.

Mass Transaction	Description
InterUnit RET/Add w/Curr Conv	<p>This mass transaction is used to perform financial asset transfers from one business unit to another, especially when the business units have different currencies and books.</p> <p>Assets are retired in the "From" business unit and added in the "To" business unit. This mass transaction differs from the IUF mass transaction in that IUF does not perform currency conversions.</p> <p>New asset IDs for the "To" business unit are assigned by the Transaction Loader, not by mass transaction. If you preview the load transactions prior to running the Transaction Loader, you will see that the "To" business unit assets have the "From" business unit asset IDs. Transaction Loader will assign new IDs when adding the assets to the "To" business unit.</p> <hr/> <p>Note: To perform currency conversion when moving assets from one business unit to another, the default profile option in the Transaction Loader is used. This means that profile IDs on the "To" business unit must exist for the assets that are being moved from the "From" business unit, and they must be the same profile IDs used in the "From" business unit. Books associated with the profile ID may be different.</p> <hr/> <p>Note: You cannot perform interunit transfers (retire/add) on group assets.</p> <hr/>
InterUnit TRF w/Currency Conv (InterUnit TRF w/Curr Conv)	<p>This transaction is used to perform financial asset transfers from one business unit to another, especially when the business units have different currencies and books.</p> <p>Assets are transferred out of the From business unit and transferred into the To business unit.</p> <p>New asset IDs for the "To" business unit are assigned by the Transaction Loader, not by this transaction. If you preview the load transactions prior to running the Transaction Loader, you will see that the "To" business unit assets have the "From" business unit asset IDs. Transaction Loader will assign new IDs when adding the assets to the "To" business unit.</p> <hr/> <p>Note: To perform currency conversion when moving assets from one business unit to another, the default profile option in the Transaction Loader is used. This means that profile IDs on the "To" business unit must exist for the assets that are being moved from the "From" business unit, and they must be the same profile IDs used in the "From" business unit. Books associated with the profile ID may be different.</p> <hr/> <p>Note: You cannot perform interunit transfers (retire/add) on group assets.</p> <hr/>
IRC - Increase Rate Change	Use this transaction to change the Increase Rate.

Mass Transaction	Description
<p>IUF - IU Transfer to Another BU (IUF- IU Transfer to Foreign BU)</p>	<p>This transaction is used to perform financial asset transfers from one business unit to another. Assets are retired in the "From" business unit and added in the "To" business unit.</p> <p>This transaction differs from the IUT-InterUnit Transfer one in that IUT does a transfer out of the "From" business unit and a transfer in to the "To" business unit.</p> <p>New asset IDs for the "To" business unit are assigned by the Transaction Loader, not by this transaction. If you preview the load transactions prior to running the Transaction Loader, you will see that the "To" business unit assets have the "From" business unit asset IDs. Transaction Loader will assign new IDs when adding the assets to the "To" business unit.</p> <hr/> <p>Note: To perform currency conversion when moving assets from one business unit to another, the default profile option in the Transaction Loader is used. This means that profile IDs on the "To" business unit must exist for the assets that are being moved from the "From" business unit, and they must be the same profile IDs used in the "From" business unit. Books associated with the profile ID may be different.</p> <hr/> <p>Note: You cannot perform interunit transfers (retire/add) on group assets.</p> <hr/>
<p>IUT - Inter-Unit Transfer</p>	<p>This transaction is used to perform mass inter-unit transfers. Two physical transactions and two financial transactions are created per asset, one for the 'From' business unit and one for the 'To' business unit. Acquisition detail records are also transferred.</p> <p>This transaction differs from the IUF-InterUnit Transfer to Another Business Unit in that IUF does a retirement from the "From" business unit and an add in the "To" business unit; IUT (this transaction) does a transfer out of the "From" business unit and a transfer in to the "To" business unit.</p> <hr/> <p>Note: You cannot perform interunit transfers on group assets.</p> <hr/>
<p>IUT - Non-Capital Assets</p>	<p>This transaction is used to perform mass inter-unit transfers of non-capital assets. Two physical transactions and two financial transactions are created per asset, one for the 'From' business unit and one for the 'To' business unit.</p> <p>The transaction loader only processes physical transactions and financial transactions are used as a reference during processing.</p>

Mass Transaction	Description
JVA - Joint Venture BU Addition	<p>This transaction is used to add a new business unit to a joint venture.</p> <p>For example, you currently have two business units involved in a joint venture (A at 40% and B at 60%); you want to add a third business unit (C). The new allocation percentages for A, B, and C will be 40%, 30%, and 30% respectively. This transaction will be used to retire 50% of the cost from the assets in B and it will add to C using the proceeds and removal cost specified by the end user.</p> <p>Using this transaction, the book table value defaults to the profile of the joint venture business unit. To have the book table values default from the new joint venture participant business unit profile, use the JVP - Joint Vent BU Add w/Prof transaction instead.</p>
JVP - Joint Venture BU Add (w/Prof)	<p>This transaction is used to add a new business unit to a joint venture.</p> <p>For example, you currently have two business units involved in a joint venture (A at 40% and B at 60%); you want to add a third business unit (C). The new allocation percentages for A, B, and C will be 40%, 30%, and 30% respectively. This transaction will be used to retire 50% of the cost from the assets in B and it will add to C using the proceeds and removal cost specified by the end user.</p> <p>Book table values that can be populated with defaults from the profile detail table are obtained from the profile ID for the new business unit.</p>
JVR - Joint Venture BU Removal	<p>Removes joint venture business units.</p> <p>For example, you have three joint venture business units, A at 20%, B at 70%, and C at 10%. You want to remove C as a joint venture business unit and add the cost from C to business unit A. This transaction will retire the assets in C and add the cost to the assets in business unit A so that your final JV allocation is A at 30% and B at 70%.</p>
JVT - JV Allocation Change	<p>Transfers the allocation percentage for a joint venture from one business unit to another.</p> <p>For example, you have two business units that make up a joint venture, A at 20% and B at 80%. You need to redistribute the allocation percentage so that it is 40% and 60% respectively. This transaction is used to retire 20% from business unit B and add that cost to business unit A.</p>

Mass Transaction	Description
<p>PAD - Parent Asset Cost Adjust</p>	<p>Changes the cost of a parent asset and some or all of its children.</p> <p>To have all children affected, leave the Child Asset ID criteria blank or apply some filter to affect only a subset.</p> <p>Enter the new desired cost as in the Cost Adjust component.</p> <p>The transaction creates the appropriate adjustments.</p>
<p>Parent Retire w/Pro/RC Absolut</p>	<p>This transaction is used to retire a parent asset and some or all of its children. The proceeds and removal cost for each asset are set equal to the proceeds and removal cost entered by the user.</p> <p>For example, if the user enters \$1000 and \$2000 for proceeds and removal cost, and 10 assets are retired, the proceeds and removal cost for each asset are \$1000 and \$2000. Total proceeds = \$10,000 and total removal cost = \$20,000.</p> <p>The transaction 'Retire Parents w/Pro/RC Distrib', distributes the proceeds and removal cost entered by the user proportionately by retirement amount; it is most likely the more common of the two to be used.</p> <p>The business unit, book(s), and department(s) to use as selection criteria for the retirements must be specified. The proceeds and removal cost should also be specified. To specify one or more children, you may use the "In List" or "Between" logical operators; otherwise, if you leave the Child Asset ID(s) criteria field blank, all children of the specified parent will be affected.</p>
<p>Parent Retire w/Pro/RC Distrib</p>	<p>This transaction performs full asset retirements for a parent asset and some or all of its children (children that are financial assets).</p> <p>To specify one or more children, you may use the "In List" or "Between" logical operators; otherwise, if you leave the Child Asset ID(s) criteria field blank, all children of the specified parent will be affected.</p> <p>The proceeds and removal cost specified are distributed proportionately over each asset based on the cost of each asset retired over the total cost of all assets being retired.</p> <p>For example, the user enters \$1,000 and \$2,000 for proceeds and removal cost, and 2 assets are retired. The cost of asset A is \$1,000 and the cost of asset B is \$9,000. The proceeds and removal cost for asset A are \$100 and \$200. The proceeds and removal cost for asset B are \$900 and \$1,800. Total proceeds = \$1,000 and total removal cost = \$2,000.</p>

Mass Transaction	Description
Partial Parent Asset Transfer	<p>The Partial Parent Asset Transfer transaction is used to perform partial asset transfers for a specific parent and some or all of its children.</p> <p>To specify one or more children, you may use the "In List" or "Between" logical operators; otherwise, if you leave the Child Asset ID(s) criteria field blank, all children of the specified parent will be affected.</p>
Partial Retire Parent Proc Abs	<p>This transaction is used to partially retire parent assets and some or all of their children (children that are financial assets).</p> <p>To specify one or more children, you may use the "In List" or "Between" logical operators; otherwise, if you leave the Child Asset ID(s) criteria field blank, all children of the specified parent will be affected.</p> <p>The percentage of the retirement is specified by the user. Also, the proceeds and removal cost for each asset are set equal to the proceeds and removal cost entered by the user.</p> <p>For example, the user enters 0.4 as the percentage of the retirement, and \$100 and \$200 for proceeds and removal cost, and 2 assets are retired. The cost of asset A is \$1,000 and the cost of asset B is \$9,000. The amount retired for asset A is \$400 and the proceeds and removal cost for asset A are \$100 and \$200. The amount retired for asset B is \$3,600 and the proceeds and removal cost for asset B are \$100 and \$200. Total proceeds = \$200 and total removal cost = \$400.</p>
Partial Retire Parent Proc Dis	<p>Partial Retire Parent Proceeds Distributed is used to partially retire a parent asset and some or all of its children.</p> <p>To specify one or more children, you may use the "In List" or "Between" logical operators; otherwise, if you leave the Child Asset ID(s) criteria field blank, all children of the specified parent will be affected.</p> <p>The percentage of the retirement is specified by the user. The proceeds and removal cost for each asset are distributed proportionately over each asset based on the cost of each asset retired over the total cost of all assets being retired.</p> <p>For example, the user enters 0.4 as the percentage of the retirement, \$1,000 and \$2,000 for proceeds and removal cost, and 2 assets are retired. The cost of asset A is \$1,000 and the cost of asset B is \$9,000. The amount retired for asset A is \$400 and the proceeds and removal cost for asset A are \$100 and \$200. The amount retired for asset B is \$3,600 and the proceeds and removal cost for asset B are \$900 and \$1,800. Total proceeds = \$1,000 and total removal cost = \$2,000.</p>

Mass Transaction	Description
Partial Retire Proceeds Absolu	<p>This transaction is used to partially retire assets. The percentage of the retirement is specified by the user. The proceeds and removal cost for each asset are set equal to the proceeds and removal cost that are entered by the user.</p> <p>For example, the user enters 0.4 as the percentage of the retirement, \$100 and \$200 for proceeds and removal cost, and 2 assets are retired. The cost of asset A is \$1,000 and the cost of asset B is \$9,000. The amount retired for asset A is \$400 and the proceeds and removal cost for asset A are \$100 and \$200. The amount retired for asset B is \$3,600 and the proceeds and removal cost for asset B are \$100 and \$200. Total proceeds = \$200 and total removal cost = \$400.</p>
Partial Retire Proceeds Dist (Part. Retirement Proceeds Dist)	<p>Partially retires assets. It is important that this transaction not be used to do full retirements—if it is, RETIRE_SW will be set incorrectly.</p> <p>The business unit, book(s), department(s), and percentage of the retirement are specified by the user. The proceeds and removal cost for each asset are distributed proportionately over each asset based on the cost of each asset retired over the total cost of all assets being retired.</p> <p>For example, the user enters 0.4 as the percentage of the retirement, \$1,000 and \$2,000 for proceeds and removal cost, and 2 assets are retired. The cost of asset A is \$1,000 and the cost of asset B is \$9,000. The amount retired for asset A is \$400 and the proceeds and removal cost for asset A are \$100 and \$200. The amount retired for asset B is \$3,600 and the proceeds and removal cost for asset B are \$900 and \$1,800. Total proceeds = \$1,000 and total removal cost = \$2,000.</p>
PHY - Physical Asset Changes	<p>Changes the physical side of assets. Two main examples include asset location changes and asset custodian changes.</p> <p>This mass transaction results in INTFC_PHY_A entries being created that the transaction loader (AMIF1000) then inserts into the physical asset tables (i.e. the asset location and custodian tables).</p>
PI Extract	<p>Extracts asset data from multiple Asset Management tables into one physical inventory extract table.</p> <p>This PI extract data may be reviewed before downloading to a bar code scanner file.</p>
PI NCP Extract	<p>Extracts asset data from multiple Asset Management tables pertaining to Non Capital assets into one physical inventory extract table.</p> <p>This PI extract data may be reviewed before downloading to a bar code scanner file.</p>

Mass Transaction	Description
PI NCP Scan Scope	Physical Inventory Scan Scope mass transaction for Non Capital Assets.
PI OPL Extract	<p>Extracts asset data from multiple Asset Management tables pertaining to Operating Lease assets into one physical inventory extract table.</p> <p>This PI extract data may be reviewed before downloading to a bar code scanner file.</p>
PI OPL Scan Scope	Physical Inventory Scan Scope mass transaction for Operating Lease Assets.
PI Scan Scope	Scans scope for physical inventory mass transaction.
PRC - Parent Recategorization	<p>Moves the cost of an asset from one asset category to another for a parent and some or all of its children.</p> <p>The parent ID, business unit, book, and category(s) to use as selection criteria must be specified as well as the new category value. If you leave the Child Asset ID(s) criteria field blank, All children of the parent will be affected; otherwise you may specify one or more children using the "In List" and "Between" logical operators.</p> <p>The cost of all assets in the specified selection category is transferred to the target category.</p>
PTF - Parent Asset Transfer	<p>Moves the cost of a Parent Asset and some or all of its children out of the From Values and into the To Values.</p> <p>The Cost Balance view gives the current cost at a chartfield level and enables you to change those chartfield values. If you do not change a value, it remains the same after the transfer.</p> <p>To specify action upon one or more children in addition to the parent, you may use the "In List" or "Between" logical operators; otherwise if you leave the Child Asset ID(s) criteria field blank, all children of the specified parent are affected.</p>
RCT – Recategorization	<p>Moves the cost of an asset from one asset category to another.</p> <p>You can configure the Asset Category, Cost Type, and Reporting Profile ID on the Transaction Definition.</p> <p>Additional selection criteria are available for the Transaction Criteria, including asset identifiers such as Tag Number, Serial ID, and Description, as well as various Cost ChartFields.</p>
REI - Reinstatement Assets (REI - Reinstatement)	Reinstates retired assets.

Mass Transaction	Description
REP - Reinstate Parent Assets	<p>Reinstates retired assets for a parent and some or all of its children.</p> <p>The Parent ID, business unit, book(s), and department(s) to be used as selection criteria must be entered.</p> <p>To specify one or more children, you may use the "In Subset" or "Between" logical operators; otherwise, if you leave the Child Asset ID(s) criteria field blank, all children of the specified parent will be affected.</p>
Retire Non-Capital Assets	<p>Retires non-capital assets. One physical transaction is created per asset.</p>
Retire w/Proceeds/RC Absolute	<p>Retires assets. The proceeds and removal cost for each asset are set equal to the proceeds and removal cost entered by the user.</p> <p>For example, if the user enters \$1000 and \$2000 for proceeds and removal cost, and 10 assets are retired, the proceeds and removal cost for each asset are \$1000 and \$2000. Total proceeds = \$10,000 and total removal cost = \$20,000.</p> <p>Transaction 'Retire w/Proceeds/RC Distrib' distributes the proceeds and removal cost entered by the user proportionately by retirement amount; it is most likely the more common of the two to be used.</p>
Retire w/Proceeds/RC Distribut	<p>Enables you to perform full asset retirement. The proceeds and removal cost for each asset are distributed proportionately over each asset, based on the cost of each asset divided by the total cost of all assets being retired.</p> <p>For example, the user enters \$1,000 and \$2,000 for proceeds and removal cost, and 2 assets are retired. The cost of asset A is \$1,000 and the cost of asset B is \$9,000. The proceeds and removal cost for asset A are \$100 and \$200. The proceeds and removal cost for asset B are \$900 and \$1,800. Total proceeds = \$1,000 and total removal cost = \$2,000.</p> <p>The transaction 'Retire w/Proceeds/RC Absolut' sets the proceeds and removal cost for each asset equal to the proceeds and removal cost entered by the user. This one, 'Retire w/Proceeds/RC Distribut', is most likely the more common of the two to be used.</p>
TM - Acctg Entry Template Copy	<p>Copies Accounting Entry (AE) templates from one SetID to another.</p>

Mass Transaction	Description
TM - Actg Ent Tmpl Copy w/in Set (TM - Acctg Entry Template Copy)	<p>Copies Accounting Entry (AE) templates from one category to another within the same Set ID.</p> <p>Defining AE templates can be tedious but if you have similar templates across some categories, this mass transaction can make the task easier.</p> <p>This transaction differs from "TM - Acctg Entry Template Copy" in that this one copies from one category to another within the same Set ID. "TM - Acctg Entry Template Copy" is used to copy Accounting Entry templates from one Set ID to another Set ID.</p>
TRF - Full Asset Transfer (TRF - Asset Transfer)	<p>Moves the cost of an asset out of the From Values and into the To Values. The Cost Balance views give the current cost at a chartfield level and enable you to change those chartfield values.</p> <p>If you do not change a value, it remains the same after the transfer.</p>
TRF - Partial Asset Transfer	<p>Performs partial asset transfers. A percentage of cost and quantity are transferred between the chartfields specified.</p> <p>The main difference between PTR - Partial Asset Transfer and TRF - Asset Transfer is that the activity switch on a full transfer (TRF) is set to 1 on the from side. It is set to 0 for partial transfers.</p>
Unload DIST_LN_ARCH to file (Archive DIST_LN_ARCH to file)	<p>Archives the table PS_DIST_LN_ARCH to a sequential file.</p> <p>The end user should enter the Archive ID and Archive Date as selection criteria.</p>
Unload Open Trans to file (Unload Open Trans Archive)	<p>Unloads entries from the Asset Open Transaction Archive table to a sequential file.</p> <p>The end user should enter the Archive ID and Archive Date to be used as selection criteria.</p>
Upload Asset Acctng Entries (Load Archived DIST_LN)	<p>Loads the production asset accounting entry table (PS_DIST_LN) from the accounting entry archive table (PS_DIST_LN_ARCH).</p>
Upload Asset Open Trans (Upload Archive Open Trans)	<p>Uploads open transactions into the PS_OPEN_TRANS table from the PS_OPEN_TRANS_ARCH table.</p>

Defining Mass Transactions

Before you run the Mass Transaction application engine that transfers and alters data, you can provide additional information about the changes that you want to make. Use the pages in the Mass Transaction setup (PSDMT) component to do so.

Note that when you have created your own transactions from scratch, you must use the Mass Transaction setup pages.

This topic discusses how to define Mass transactions.

Pages Used to Define Mass Transactions

<i>Page Name</i>	<i>Definition Name</i>	<i>Usage</i>
<u>Mass Transactions List Page</u>	PSDMT_UNITS_01	Define high-level transaction information.
<u>Transaction Definition Page</u>	PSDMT_UNITS_02	Define detailed transaction information.
<u>Mass Transaction Configuration Page</u>	PSDMT_UNIT_DTL	Define the list of field filters available on the run control page for a given transaction and configure the filter behavior.
<u>Mass Transaction Criteria Page</u>	PSDMT_UDC	Choose the filter fields to display on the run control page for a given transaction.
<u>Mass Transaction Security Page</u>	PSDMT_OSECURITY	Set up security for a transaction by associating permission lists with the transaction.

Mass Transactions List Page

Use the Mass Transactions List page (PSDMT_UNITS_01) to define high-level transaction information.

Navigation:

Set Up Financials/Supply Chain > Product Related > Asset Management > Mass Transaction Manager > Mass Transaction Definition > Mass Transactions List

This example illustrates the fields and controls on the Mass Transactions List page (1 of 2). You can find definitions for the fields and controls later on this page.

Mass Transactions List									
Transaction	Description	*Status	Public	Custom	View Notes	Definition	Copy	Allow Preview Mode	
ADJ - Asset Cost Adjustment	ADJ - Asset Cost Adjustment	Active	<input checked="" type="checkbox"/>	<input type="checkbox"/>				<input checked="" type="checkbox"/>	
ADJ - Asset Cost Adjustment2	ADJ - Asset Cost Adjustment by Amount	Active	<input checked="" type="checkbox"/>	<input type="checkbox"/>				<input checked="" type="checkbox"/>	
ASD - Asset Deletion	ASD - Asset Deletion	Active	<input checked="" type="checkbox"/>	<input type="checkbox"/>				<input checked="" type="checkbox"/>	
AUP - Asset Update	AUP - Asset Update	Active	<input checked="" type="checkbox"/>	<input type="checkbox"/>				<input checked="" type="checkbox"/>	
Archive Asset Depr Rpt entries	Archive Asset Depr Rpt entries	Active	<input checked="" type="checkbox"/>	<input type="checkbox"/>				<input checked="" type="checkbox"/>	
Archive Asset NBV entries	Archive Asset NBV entries	Active	<input checked="" type="checkbox"/>	<input type="checkbox"/>				<input checked="" type="checkbox"/>	
Archive Asset Open Trans	Archive Asset Open Trans	Active	<input checked="" type="checkbox"/>	<input type="checkbox"/>				<input checked="" type="checkbox"/>	
Archive Assets Acctng Entries	Archive Asset Acctng Entries	Active	<input checked="" type="checkbox"/>	<input type="checkbox"/>				<input checked="" type="checkbox"/>	
BA - Book Addition	BA - Book Addition	Active	<input checked="" type="checkbox"/>	<input type="checkbox"/>				<input checked="" type="checkbox"/>	
BC - Book Copy	BC - Book Copy	Active	<input checked="" type="checkbox"/>	<input type="checkbox"/>				<input checked="" type="checkbox"/>	
BKD - Book Deletion	BKD - Book Deletion	Active	<input checked="" type="checkbox"/>	<input type="checkbox"/>				<input checked="" type="checkbox"/>	
BKS - Asset Book Change	BKS - Asset Book Change	Active	<input checked="" type="checkbox"/>	<input type="checkbox"/>				<input checked="" type="checkbox"/>	
BSD - Selective Book Delete	BSD - Selective Book Delete	Active	<input checked="" type="checkbox"/>	<input type="checkbox"/>				<input checked="" type="checkbox"/>	
CC - Capitalize Into Composite	CC - Capitalize Into Composite	Active	<input checked="" type="checkbox"/>	<input type="checkbox"/>				<input checked="" type="checkbox"/>	
CC - JPN Capitalize Composite	CC - JPN Capitalize Composite	Active	<input checked="" type="checkbox"/>	<input type="checkbox"/>				<input checked="" type="checkbox"/>	
CR - Composite Retirement	CR - Composite Retirement	Active	<input checked="" type="checkbox"/>	<input type="checkbox"/>				<input checked="" type="checkbox"/>	
CR - JPN Composite Retirement	CR - JPN Composite Retirement	Active	<input checked="" type="checkbox"/>	<input type="checkbox"/>				<input checked="" type="checkbox"/>	
Delete Asset Acctng Entries	Delete Archived DIST_LN	Active	<input checked="" type="checkbox"/>	<input type="checkbox"/>				<input checked="" type="checkbox"/>	
Delete Asset Depr Rpt entries	Delete Asset Depr Rpt entries	Active	<input checked="" type="checkbox"/>	<input type="checkbox"/>				<input checked="" type="checkbox"/>	
Delete Asset NBV entries	Delete Asset NBV entries	Active	<input checked="" type="checkbox"/>	<input type="checkbox"/>				<input checked="" type="checkbox"/>	
Delete Asset Open Trans	Delete Asset Open Trans	Active	<input checked="" type="checkbox"/>	<input type="checkbox"/>				<input checked="" type="checkbox"/>	
EURO1-InterUnit Trf - New Book	EURO1-InterUnit Trf - New Book	Active	<input checked="" type="checkbox"/>	<input type="checkbox"/>				<input checked="" type="checkbox"/>	

This example illustrates the fields and controls on the Mass Transactions List page (2 of 2). You can find definitions for the fields and controls later on this page.

InterUnit TRF w/Currency Conv	InterUnit TRF w/Curr Conv	Active	<input checked="" type="checkbox"/>	<input type="checkbox"/>				<input checked="" type="checkbox"/>	
JVA-Joint Venture BU Addition	JVA-Joint Venture BU Addition	Active	<input checked="" type="checkbox"/>	<input type="checkbox"/>				<input checked="" type="checkbox"/>	
JVP-Joint Vent BU Add (w/Prof)	JVP-Joint Vent BU Add w/Prof	Active	<input checked="" type="checkbox"/>	<input type="checkbox"/>				<input checked="" type="checkbox"/>	
JVR - Joint Venture BU Removal	JVR-Joint Venture BU Removal	Active	<input checked="" type="checkbox"/>	<input type="checkbox"/>				<input checked="" type="checkbox"/>	
JVT - JV Allocation Change	JVT - JV Allocation Change	Active	<input checked="" type="checkbox"/>	<input type="checkbox"/>				<input checked="" type="checkbox"/>	
PAD - Parent Asset Cost Adjust	PAD - Parent Asset Cost Adjust	Active	<input checked="" type="checkbox"/>	<input type="checkbox"/>				<input checked="" type="checkbox"/>	
PHY-Physical Asset Changes	PHY-Physical Asset Changes	Active	<input checked="" type="checkbox"/>	<input type="checkbox"/>				<input checked="" type="checkbox"/>	
PI Extract	PI Extract	Active	<input type="checkbox"/>	<input type="checkbox"/>				<input type="checkbox"/>	
PI NCP Extract	PI NCP Extract	Active	<input type="checkbox"/>	<input type="checkbox"/>				<input type="checkbox"/>	
PI NCP Scan Scope	PI NCP Scan Scope	Active	<input type="checkbox"/>	<input type="checkbox"/>				<input type="checkbox"/>	
PI OPL Extract	PI OPL Extract	Active	<input type="checkbox"/>	<input type="checkbox"/>				<input type="checkbox"/>	
PI OPL Scan Scope	PI OPL Scan Scope	Active	<input type="checkbox"/>	<input type="checkbox"/>				<input type="checkbox"/>	
PI Scan Scope	PI Scan Scope	Active	<input type="checkbox"/>	<input type="checkbox"/>				<input type="checkbox"/>	
PRC - Parent Recategorization	PRC - Parent Recategorization	Active	<input checked="" type="checkbox"/>	<input type="checkbox"/>				<input checked="" type="checkbox"/>	
PTF - Parent Asset Transfer	PTF - Parent Asset Transfer	Active	<input checked="" type="checkbox"/>	<input type="checkbox"/>				<input checked="" type="checkbox"/>	
Parent Retire w/Pro/RC Absolut	Parent Retire w/Pro/RC Absolut	Active	<input checked="" type="checkbox"/>	<input type="checkbox"/>				<input checked="" type="checkbox"/>	
Parent Retire w/Pro/RC Distrib	Retire Parent w/Pro/RC Distrib	Active	<input checked="" type="checkbox"/>	<input type="checkbox"/>				<input checked="" type="checkbox"/>	
Partial Parent Asset Transfer	Partial Parent Asset Transfer	Active	<input checked="" type="checkbox"/>	<input type="checkbox"/>				<input checked="" type="checkbox"/>	
Partial Retire Parent Proc Abs	Partial Retire Parent Proc Abs	Active	<input checked="" type="checkbox"/>	<input type="checkbox"/>				<input checked="" type="checkbox"/>	
Partial Retire Parent Proc Dis	Partial Retire Parent Proc Dis	Active	<input checked="" type="checkbox"/>	<input type="checkbox"/>				<input checked="" type="checkbox"/>	
Partial Retire Proceeds Absolu	Partial Retire Proceeds Absolu	Active	<input checked="" type="checkbox"/>	<input type="checkbox"/>				<input checked="" type="checkbox"/>	
Partial Retire Proceeds Dist	Part. Retirement Proceeds Dist	Active	<input checked="" type="checkbox"/>	<input type="checkbox"/>				<input checked="" type="checkbox"/>	
RCT - Recategorization	RCT - Recategorization	Active	<input checked="" type="checkbox"/>	<input type="checkbox"/>				<input checked="" type="checkbox"/>	

Field or Control	Description
Transaction	Enter the ID, or name, of the transaction.
Description	Enter a brief description of the transaction.

Field or Control	Description
Status	Select <i>Active</i> or <i>Inactive</i> for the transaction. Only active transactions will be available to run from the run control page.
Public	Select this option to make the transaction public. Only public transactions will be available to run from the run control page.
View Notes	Click to access the Mass Transaction Notes page and enter additional transaction descriptions, comments, notes, or instructions.
Definition	Click the icon to access the Transaction Definition page and define detailed information for the transaction, such as user input parameters for the run control and the source records that will be used to build the list of filtering fields.
Copy	Click the icon to make a copy of the Transaction Definition.
Allow Preview Mode	Select this check box to enable preview mode for this transaction. There are some transactions that do not support the preview mode.

Tracking Customizations

The **Custom** field is used to indicate whether a transaction is PeopleSoft-delivered or user-created. When selected, the field indicates the transaction is user-created. When empty, the field indicates the transaction is PeopleSoft-delivered. You cannot edit this field, the system automatically selects the option when you add a new transaction or copy an existing transaction.

Warning! If you have added new transactions to your system or customized PeopleSoft-delivered transactions prior to applying the enhancement that allowed the copying of transaction definitions, you must use the copy transaction functionality to make copies of these transactions. This ensures the transactions are formally flagged as custom by the system. Transactions that are not flagged custom may be overwritten when you apply a new PeopleSoft Image. Copying your new and customized transactions will ensure they will not be overwritten the next time you apply a new image. Ensure that you update security for the copied transactions using the Mass Transaction Security page, and add them to the appropriate permission list.

Copying Transactions

Click the Copy icon to copy the transaction in the row. When you click the Copy icon, the Copy Transaction pagelet appears:

Copy Transaction pagelet

Copy Transaction

Transaction ADJ - Asset Cost Adjustment

Copy To... BA_ADJ - Asset Cost Adjustment

OK Cancel

The Copy Transaction pagelet enables you to enter a new name for the transaction you are copying. Enter a name for the new transaction using the **Copy To** field. The system automatically adds the existing transaction name, but you must alter it to differentiate it from the original.

Once you save the new transaction by clicking OK, it is added to the Mass Transaction List page and the Custom field is automatically selected.

Adding Notes

Click the View Notes icon on the Mass Transactions page to access the Mass Transaction Notes page and enter additional transaction descriptions, comments, notes, or instructions.

This example illustrates the fields and controls on the Mass Transactions Notes page.

Mass Transaction Notes

Transaction ADJ - Asset Cost Adjustment

Notes

Use Asset Cost Adjustment transaction to change the cost of a set of assets as a percentage of the current cost.
 Example:
 If current cost of the asset is 30000 (thirty thousand) and the adjustment percent is 0.25 (twenty five percent) a new cost row will be created by 7500, calculated like this $30000 * 0.25$.

OK Cancel

Transaction Definition Page

Use the Transaction Definition page (PSDMT_UNITS_02) to define detailed transaction information.

Navigation:

Set Up Financials/Supply Chain > Product Related > Asset Management > Mass Transaction Manager > Mass Transaction Definition > Transaction Definition

This example illustrates the fields and controls on the Transaction Definition page. You can find definitions for the fields and controls later on this page.

The screenshot shows the 'Transaction Definition' page for 'Transaction ADJ - Asset Cost Adjustment'. It includes sections for 'Requested Fields' (with checkboxes for Accounting Date, Approval Switch, Interface ID, Open Transaction ID, and Transaction Date), 'User Entered Values' (with a 'Field List' table), and 'Source Records' (with a table of source records).

Field Number	Field Name	Field Label ID	Edit Type	Prompt Table
10	PSDMT_COST_PCT	PSDMT_COST_PCT	No Table Edit	

Source Record	Record Alias
ASSET	ASSET
BOOK_CUR_VW	BOOK_CUR_VW
COST_BAL_VW	COST_BAL_VW

Field Control tab on the Transaction Definition page

This screenshot shows the 'Field Control' tab for the 'PSDMT_COST_PCT' field. It displays a table with control settings and the 'Step' configuration.

Field Number	Field Name	SetID from	Business Unit from	Subordinate to	Currency CD from	Required	Allow Empty	Field Order
10	PSDMT_COST_PCT					<input checked="" type="checkbox"/>	<input type="checkbox"/>	

Source Record	Record Alias
ASSET	ASSET
BOOK_CUR_VW	BOOK_CUR_VW
COST_BAL_VW	COST_BAL_VW

Requested Fields

This group box displays a list of fields that, when selected, will appear on the Run Mass Transactions page as requested input parameters for the run control. Typically these are fields that are common across Asset Management tables. The fields in this group box are populated automatically from the MTM_PRODUCT_CFG record and MTM_RQST_AM_SBR subrecord.

User Entered Values - Field List and Field Control Tabs

This group box enables you to define field-level user input parameters that will appear on the Run Mass Transactions page as required input parameters for the run control. These are fields that are specific to a particular transaction. Available fields are obtained from the MTM_PRODUCT_CFG record and MTM_UEV_AM_SBR subrecord are available for selection.

You can use the **Field List** tab to define basic field-level information and behavior, such as field name and edit type.

You can use the **Field Control** tab to refine field behavior, such as adding subordinate fields and requiring users to input data for the field on the Run Mass Transactions page.

<i>Field or Control</i>	<i>Description</i>
Field Number	<p>Enter a numerical value to uniquely identify the field.</p> <p>The number provides a sort order on this page as well as a field reference for the SetID from, Business Unit from, and Currency CD from fields.</p> <p>It also provides a default order on the Mass Transaction Criteria and Run Mass Transactions pages.</p>
Field Name	<p>Select a field you would like to use as user-defined input parameter on the Run Mass Transactions page.</p> <p>Available fields are obtained from the MTM_PRODUCT_CFG record and MTM_UEV_AM_SBR subrecord.</p>
Field Label ID	<p>Select a field label for the field.</p> <p>This will be populated automatically after you select a field for the Field Name.</p>

Field or Control	Description
Edit Type	<p>Specify the type of field edit or validation for the user-defined field.</p> <p>This impacts how users can select values against the field on the Run Mass Transactions page.</p> <p>Available options are:</p> <ul style="list-style-type: none"> • <i>No Table Edit</i> (usually used to enter percents) • <i>Currency Controlled</i> • <i>Prompt Table</i> • <i>Translate Table</i> • <i>Yes/No</i> <hr/> <p>Note: When you select the Prompt Table option, you must enter the associated prompt table using the Prompt Table field.</p> <hr/>
Prompt Table	<p>Enter the prompt table associated with the field.</p> <p>This field is required only when you select the Prompt Table option from the Edit Type field.</p>
SetID from	<p>When a field requires a SetID as a key for its prompt, enter the field number associated with the field you want to use to obtain the SetID.</p> <p>For example, assume the DEPTID field requires a SetID as a key for its prompt and you want to obtain this information from the BUSINESS_UNIT field, which you have labeled with the field number '10.' In this scenario you will enter '10' in this field.</p> <p>This field can be left empty when no SetID is required.</p>
Business Unit from	<p>When a field requires a business unit as a key for its prompt, enter the field number associated with the field you want to use to obtain the business unit.</p> <p>For example, assume the ASSET_ID field requires a business unit as a key for its prompt and you want to obtain this information from the BUSINESS_UNIT field, which you have labeled with the field number '10.' In this scenario you will enter '10' in this field.</p> <p>This field can be left empty when no business unit is required.</p>

Field or Control	Description
Subordinate to	<p>When a field is subordinate to another, that is, it contains a prompt that depends on another field, enter the field number associated with the governing field.</p> <p>For example, assume the ASSET_SUBTYPE field contains a prompt that depends on the ASSET_TYPE field, which you have labeled with the field number '50.' In this scenario you will enter '50' in this field.</p> <p>This field can be left empty when no governing field is required.</p>
Currency Code from	<p>When a field requires formatted currency amounts based on a currency field, enter the field number associated with the field you want to use to obtain the formatted amount.</p> <p>For example, assume the TXN_COST field requires a formatted currency amount based on a currency field and you want to obtain this information from the TXN_CURRENCY_CD field, which you have labeled with the field number '30.' In this scenario you will enter '30' in this field.</p> <p>This field can be left empty when no currency formatting is required.</p>
Required	<p>Select this option when you want to require users to input data for this field on the Run Mass Transactions page.</p> <p>If you do not select this option, inputting data for this field will be optional on the Run Mass Transactions page.</p>
Allow Empty	<p>Select this option when you want to allow users to select <i>Is Empty</i> for this field on the Run Mass Transactions page.</p> <p>When a user selects <i>Is Empty</i> for the field on the Run Mass Transactions page, the value field is hidden and the system removes the value of that field and replaces it with a space, a zero, or null, depending on the field type.</p>
Field Order	<p>Enter a numerical value to define the order of the field.</p> <p>The system will use values entered here for the field sort order, overriding the order as provided by the Field Number field.</p> <p>This field is optional.</p>

Step

Use the Step group box to provide an ordered sequence to execute transactions and define the source records that will be used to build the list of filtering fields on the Mass Transaction Configuration page.

Field or Control	Description
Sequence	Enter a numerical value to assign the transaction a step order.
Description	Enter a description of the step.
Section	Enter the Application Engine Library (MTM_LIB_AM) section associated with the transaction.
Source Record	Select the source record that will be used to build the list of filtering fields on the Mass Transaction Configuration page. The filtering fields on the Mass Transaction Configuration page will be used to create the FROM clause in the SQL statement, so it is important to include all the source records needed to create the desired statement.
Record Alias	Enter an alias for the record. This field is populated automatically after you enter the source record, but you can change it if you have a different alias in your SQL or need to leave it empty to use it in PeopleCode.

Mass Transaction Configuration Page

Use the Mass Transaction Configuration page (PSDMT_UNIT_DTL) to define the list of field filters available in the Selection Criteria portion of the run control page and configure the filter behavior.

Navigation:

Set Up Financials/Supply Chain > Product Related > Asset Management > Mass Transaction Manager > AM Mass Transaction Config

This example illustrates the fields and controls on the Mass Transaction Configuration page. You can find definitions for the fields and controls later on this page.

Mass Transaction Configuration

Transaction ADJ - Asset Cost Adjustment

Filter Fields Personalize | Find | First 1-16 of 16 Last

Field Number	Source Record	Field Name	Field Label ID	Edit Type	Prompt Table	
10	COST_BAL_VW	BUSINESS_UNIT	BUSINESS_UNIT	Prompt Table	SP_BU_AM_NONW	+ -
20	ASSET	ASSET_ID	ASSET ID	Prompt Table	MTM_ASSET_VW	+ -
30	COST_BAL_VW	BOOK	BOOK	Prompt Table	SP_BU_BK_NONW	+ -
40	COST_BAL_VW	DEPTID	DEPTID	Prompt Table	DEPT_TBL	+ -
50	COST_BAL_VW	FUND_CODE	FUND_CODE	Prompt Table	FUND_TBL	+ -
60	ASSET	ASSET_TYPE	ASSET_TYPE	Translate Table		+ -
70	ASSET	ASSET_SUBTYPE	ASSET_SUBTYPE	Prompt Table	MTM_AMSUBTYPEVW	+ -
80	COST_BAL_VW	OPERATING_UNIT	OPERATING_UNIT	Prompt Table	OPERUNIT_ALL_VW	+ -
90	COST_BAL_VW	PROGRAM_CODE	PROGRAM_CODE	Prompt Table	PROGRAM_TBL	+ -
100	COST_BAL_VW	CLASS_FLD	CLASS_FLD	Prompt Table	CLASS_CF_TBL	+ -
110	COST_BAL_VW	BUDGET_REF	BUDGET_REF	Prompt Table	BUD_REF_TBL	+ -
120	COST_BAL_VW	PRODUCT	PRODUCT	Prompt Table	PRODUCT_TBL	+ -
130	COST_BAL_VW	PROJECT_ID	PROJECT_ID	Prompt Table	PROJECT_ID_VW	+ -
140	ASSET	ASSET_CLASS	ASSET_CLASS	Prompt Table	ASSET_CLASS_TBL	+ -
150	ASSET	SERIAL_ID	SERIAL_ID	No Table Edit		+ -
160	ASSET	TAG_NUMBER	TAG_NUMBER	No Table Edit		+ -

Step Find | View All First 1 of 1 Last

Sequence 10
Description Asset Cost Adjustment

Filter Fields by Step Personalize | Find | First 1-16 of 16 Last

Source Record	Record Alias	Field Name	
ASSET	ASSET	ASSET_CLASS	+ -
ASSET	ASSET	ASSET_ID	+ -
ASSET	ASSET	ASSET_SUBTYPE	+ -

Field Control tab of the Mass Transaction Configuration page

Mass Transaction Configuration

Transaction ADJ - Asset Cost Adjustment

Filter Fields Personalize Find 1-16 of 16 Last

Field Number	Source Record	Field Name	SetID from	Business Unit from	Subordinate to	Currency CD from	Active Status	Required
10	COST_BAL_VW	BUSINESS_UNIT					Active	<input checked="" type="checkbox"/>
20	ASSET	ASSET_ID		10			Active	<input type="checkbox"/>
30	COST_BAL_VW	BOOK		10			Active	<input type="checkbox"/>
40	COST_BAL_VW	DEPTID	10				Active	<input type="checkbox"/>
50	COST_BAL_VW	FUND_CODE	10				Active	<input type="checkbox"/>
60	ASSET	ASSET_TYPE					Active	<input type="checkbox"/>
70	ASSET	ASSET_SUBTYPE	10		60		Active	<input type="checkbox"/>
80	COST_BAL_VW	OPERATING_UNIT	10				Active	<input type="checkbox"/>
90	COST_BAL_VW	PROGRAM_CODE	10				Active	<input type="checkbox"/>
100	COST_BAL_VW	CLASS_FLD	10				Active	<input type="checkbox"/>
110	COST_BAL_VW	BUDGET_REF	10				Active	<input type="checkbox"/>
120	COST_BAL_VW	PRODUCT	10				Active	<input type="checkbox"/>
130	COST_BAL_VW	PROJECT_ID	10				Active	<input type="checkbox"/>
140	ASSET	ASSET_CLASS	10				Active	<input type="checkbox"/>
150	ASSET	SERIAL_ID					Active	<input type="checkbox"/>
160	ASSET	TAG_NUMBER		ASSET			Active	<input type="checkbox"/>

The fields you define here will be available in the Selection Criteria portion of the run control page. You can indicate whether a certain field will require input by the user. You can also define the behavior of each field—for example, whether the user will prompt for field values and, if prompting is enabled, prompt using a prompt table or translate table.

Note: The fields on this page are identical in name and usage as those on the Transaction Definition page. Please refer to the documentation for the Transaction Definition page for detailed field definitions.





Mass Transaction Criteria Page

Use the Mass Transaction Criteria page (PSDMT_UDC) to choose the filter fields to display in the Selection Criteria portion of the run control page for a given transaction.

Navigation:

Set Up Financials/Supply Chain > Product Related > Asset Management > Mass Transaction Manager > AM Mass Transaction Criteria

This example illustrates the fields and controls on the Mass Transaction Criteria page. You can find definitions for the fields and controls later on this page.

Mass Transaction Criteria		
Transaction ADJ - Asset Cost Adjustment		
Selection Criteria Personalize Find   First  1-16 of 16  Last		
Field Label ID	Selectable	Field Order
Business Unit	<input checked="" type="checkbox"/>	<input type="text" value="1"/>
Asset ID	<input checked="" type="checkbox"/>	<input type="text" value="5"/>
Asset Book Name	<input checked="" type="checkbox"/>	<input type="text" value="4"/>
Department	<input checked="" type="checkbox"/>	<input type="text" value="7"/>
Fund Code	<input checked="" type="checkbox"/>	<input type="text" value="8"/>
Asset Type	<input checked="" type="checkbox"/>	<input type="text" value="2"/>
Asset Subtype	<input checked="" type="checkbox"/>	<input type="text" value="3"/>
Operating Unit	<input checked="" type="checkbox"/>	<input type="text" value="6"/>
Program Code	<input type="checkbox"/>	<input type="text"/>
Class Field	<input type="checkbox"/>	<input type="text"/>
Budget Reference	<input type="checkbox"/>	<input type="text"/>
Product	<input type="checkbox"/>	<input type="text"/>
Project	<input type="checkbox"/>	<input type="text"/>
Asset Class	<input type="checkbox"/>	<input type="text"/>
Serial ID	<input type="checkbox"/>	<input type="text"/>
Tag Number	<input type="checkbox"/>	<input type="text"/>

The Mass Transaction Criteria page enables you to select the filter fields to display in the Selection Criteria portion of the run control page for a given transaction.

Use the Selectable option to indicate the filter fields that will display on the run control page. Fields designated as required on the Mass Transaction Configuration page are automatically selected here and unavailable for editing.

Use Field Order to override the default order specified on the Mass Transaction Configuration page. Fields with no value will maintain its default order but display at the bottom.

Mass Transaction Security Page

Use the Mass Transaction Security page (PSDMT_OSECURITY) to set up security for a transaction by associating permission lists with the transaction.

Navigation:

Set Up Financials/Supply Chain > Product Related > Asset Management > Mass Transaction Manager > AM Mass Transaction Security

This example illustrates the fields and controls on the Mass Transaction Security page. You can find definitions for the fields and controls later on this page.

Mass Transaction Security
 Permission List: ALLPAGES
 Description: ALLPAGES

Personalize | Find | | First 1-55 of 55 Last

Transaction		
ADJ - Asset Cost Adjustment		
ASD - Asset Deletion		
AUP - Asset Update		
Archive Asset Depr Rpt entries		
Archive Asset NBV entries		
Archive Asset Open Trans		
Archive Assets Acctg Entries		
BA - Book Addition		
BC - Book Copy		
BKD - Book Deletion		
BKS - Asset Book Change		
BSD - Selective Book Delete		
CC - Capitalize Into Composite		
CC - JPN Capitalize Composite		
CR - Composite Retirement		
CR - JPN Composite Retirement		
Delete Asset Acctg Entries		
Delete Asset Depr Rpt entries		
Delete Asset NBV entries		
Delete Asset Open Trans		
EURO1-InterUnit Trf - New Book		
IRC - Increase Rate Change		
IUF-IU Transfer to Another BU		
IUT - Inter-Unit Transfer		
IUT - Non-Capital Assets		
InterUnit RET/Add w/Curr Conv		
InterUnit TRF w/Currency Conv		
JVA-Joint Venture BU Addition		
JVP-Joint Vent BU Add (w/Prof)		
JVR - Joint Venture BU Removal		
JVT - JV Allocation Change		
PAD - Parent Asset Cost Adjust		
PHY-Physical Asset Changes		
PRC - Parent Recategorization		
PTF - Parent Asset Transfer		

This example illustrates the fields and controls on the Mass Transaction Security page. You can find definitions for the fields and controls later on this page.

Parent Retire w/Pro/RC Absolut			
Parent Retire w/Pro/RC Distrib			
Partial Parent Asset Transfer			
Partial Retire Parent Proc Abs			
Partial Retire Parent Proc Dis			
Partial Retire Proceeds Absolu			
Partial Retire Proceeds Dist			
RCT - Recategorization			
REI - Reinstate Assets			
Retire Non-Capital Assets			
Retire w/Proceeds/RC Absolute			
Retire w/Proceeds/RC Distribut			
TM - Acctg Entry Template Copy			
TM-Actg Ent Tmpl Copy w/in Set			
TRF - Full Asset Transfer			
TRF - Partial Asset Transfer			
Unload DIST_LN_ARCH to file			
Unload Open Trans to File			
Upload Asset Acctng Entries			
Upload Asset Open Trans			

Use the Mass Transaction Security page to select a permission list, then add the transactions you want the permission list to access. Users will only be able to access transactions that are public and associated with their permission list.

Running Mass Transactions

This topic discusses how to run mass transactions.

Page Used to Run Mass Transactions

<i>Page Name</i>	<i>Definition Name</i>	<i>Usage</i>
Run Mass Transactions Page	PSDMT_RUN_AM	Run a mass transaction.

Run Mass Transactions Page

Use the Run Mass Transactions page (PSDMT_RUN_AM) to run mass transactions.

Navigation:

Asset Management > Asset Transactions > Mass Transactions > Run Mass Transactions

This example illustrates the fields and controls on the Run Mass Transactions page (1 of 2).

When you enter a new run control ID and access the Run Mass Transactions page, the page displays only the Run Control ID, Transaction, and Notes fields, and the Run button. The rest of the page is dynamically generated based on the transaction you select and each transaction will generate a different set of fields with unique properties (as defined on the mass transaction setup pages).

Select a transaction from the Transaction field to generate the rest of the page. You can only access transactions that are public and associated with your permission list.

Note: If you want to process approvals for mass transaction manager, you must select transactions that load interface tables INTFC_FIN and INTFC_PHY_A. Mass transaction manager approvals are not processed when you select non interface table transactions. Non interface table transactions are:

Archive Asset Depr Rpt

Archive Asset NBV

Archive Asset Open Trans

Archive Assets Accntg

Delete Asset Accntg

Delete Asset Depr Rpt

Delete Asset NBV

Delete Asset Open Trans

TM - Acctg Entry Template Copy

TM-Actg Ent Tmpl Copy w/in Set

Unload DIST_LN_ARCH to File

Unload Open Trans to File

Upload Asset Acctng Entries

Upload Asset Open Trans

See:

“AM Business Unit Definition Page” (Asset Lifecycle Management Fundamentals), Approval Options
[Approving Assets Using the PeopleSoft Fluid User Interface](#)

This example illustrates the fields and controls on the Run Mass Transactions page (2 of 2). You can find definitions for the fields and controls later on this page.

The screenshot shows the 'Run Mass Transactions' page with the following elements:

- Page Header:** 'Run Mass Transactions' tab, 'Run Control ID 1', 'Report Manager', 'Process Monitor', and a 'Run' button.
- Transaction Selection:** '*Transaction' dropdown set to 'ADJ - Asset Cost Adjustment', a search icon, and a 'Run in Preview Mode' checkbox.
- Notes Section:** A 'Notes' header with a right-pointing arrow.
- Date and Status Fields:** 'Transaction Date' (08/24/2016), 'Accounting Date' (08/24/2016), and 'Auto Approval Status' (checked).
- Increment Options:** 'Increment to Next Interface ID' (checked) and 'Increment to Next Open Trans' (checked).
- Interface and Open Trans IDs:** Input fields for 'Interface ID' and 'Open Trans ID'.
- Mass Transaction Section:** 'ADJ - Asset Cost Adjustment'.
- Selection Criteria Section:** Multiple dropdown menus for 'Business Unit', 'Asset Type', 'Asset Subtype', 'Asset Book Name', 'Operating Unit', 'Department', and 'Fund Code'. An 'Asset ID' field is set to 'Between' with values '000000000001' and '000000000100'.
- User Entered Values Section:** 'Cost Percent' dropdown set to 'Set equal to' with a value of '10.000' and a 'Clear' button.

Aside from the Run Control ID, Transaction, Notes, and Run button fields, all other fields displayed in the page header are specific to the selected transaction. Different fields and field properties display depending on the transaction properties defined on the mass transaction setup pages. For this reason, this documentation will not define all possible fields in this section.

The fields in the Selection Criteria section will be used to further narrow the row retrieval criteria, and fields in the User Entered Values section are required input parameters for the run control.

Field or Control	Description
Run	<p>Once you have populated all necessary fields on the page, click the Run button to run the Run Mass Transaction Manager Tool Application Engine (MTMTOOL), which generates the dynamic WHERE clause based on your field selections and processes the transactions.</p> <p>When the Run in Preview Mode option is not selected, the process will make changes to applicable tables (often these are the INTFC_FIN, INTFC_PHY_A and INTFC_PHY_B tables, but not always). When the Run in Preview Mode option is selected, the process will instead update the staging tables for display on the preview pages.</p>

Field or Control	Description
Run in Preview Mode	Select this check box to run the process in preview mode. The staging tables will be updated for display on the preview pages. Clear this check box to run the process in regular mode. The applicable tables will be updated.
Notes	Click to expand the notes section, which can display additional transaction descriptions, comments, notes, or instructions
Auto Approval Status	Select this option to automatically approve the data loaded to the Asset Management loader tables (INTFC_FIN, INTFC_PHY_A, and INTFC_PHY_B) and bypass the review and approval processes.

Selection Criteria

Use the fields in the Selection Criteria group box to create the dynamic WHERE clause of the SQL statement, which is used to retrieve the data specified by these fields.

The WHERE clause is created using only those fields with values selected. If a field is left empty, that field will not be used in the WHERE clause.

Use the ‘Is Empty’ operator to retrieve rows that have no values.

Note: The fields appearing in the Selection Criteria group box will vary depending on the transaction and its properties, as defined on the mass transaction setup pages.

Note: When mass transaction manager approvals are enabled, the selection criteria uses business unit to determine whether approvals are triggered. Some transactions do not include business unit as part of the selection criteria—these transactions are processed without approvals. In addition, some transactions enable you to select multiple business units—when implementing approvals for mass transaction manager all the business units you select must have approvals enabled. If approvals are not enabled for *all* business units, you cannot process the transaction.

See “AM Business Unit Definition Page” (Asset Lifecycle Management Fundamentals), Approval Options

User Entered Values



Use the fields in the User Entered Values group box to further constrain the selection criteria.

Note: The fields appearing in the User Entered Values group box will vary depending on the transaction and its properties, as defined on the mass transaction setup pages.

Preview

The Preview group box is displayed after the process is run in preview mode.

This example illustrates the fields and controls on the Preview Group Box. You can find definitions for the fields and controls later on this page.

Field or Control	Description
Preview Details	Click this link to display all the Preview tabs (Assets, Interfaces, and Prerequisites).
	Click to run the query for Financial, Physical A or Physical B.
	Click the icon to access the Delete Preview Data component to review and delete data. This icon is displayed only when there are preview data that can be deleted.

Note: You can also click the Help Preview icon for descriptions of the fields and controls.

Preview Assets

The Preview Assets page lists the assets affected (insert/delete/update) by the transaction.

This example illustrates the fields and controls on the Preview Assets page.

Business Unit	Asset Identification	Description	Prereq Exists	Tag Number	Serial ID	Profile ID	Asset Type	Asset Status
US001	000000000001	SOLARIS WORKSTATION	<input type="checkbox"/>		000000000001	COMPUTERS	IT Hardware	In Service
US001	000000000089	High Speed Copier	<input checked="" type="checkbox"/>			OFFICE EQT	Equipment	In Service
US001	000000000091	Automobile	<input type="checkbox"/>			AUTO	Fleet	In Service
US001	000000000092	High Speed Copier	<input type="checkbox"/>			OFFICE EQT	Equipment	In Service
US001	000000000094	High Speed Copier	<input type="checkbox"/>			OFFICE EQT	Equipment	In Service
US001	000000000095	High Speed Copier	<input type="checkbox"/>			OFFICE EQT	Equipment	In Service
US001	000000000096	High Speed Copier	<input type="checkbox"/>			OFFICE EQT	Equipment	In Service

Field or Control	Description
Assets	Displays assets affected by the transaction.
Prereq Exists	Indicates whether the asset has a pending transaction in the interface tables.

You can also click the Help Assets icon for descriptions of the fields and controls.

Preview Interfaces

The Preview Interfaces page displays the interface lines affected by the transactions in three grids - Financial, Physical A and Physical B.

This example illustrates the fields and controls on the Preview Interfaces page.

The screenshot shows the 'Preview Interfaces' page for a transaction. At the top, there are tabs for 'Run Mass Transactions', 'Preview Assets', 'Preview Interfaces', and 'Preview Prerequisites'. Below the tabs, it displays 'Run Control ID 1' and 'Transaction ADJ - Asset Cost Adjustment'. Summary statistics show 'Assets: 7', 'Total Interface Rows: 24', and 'Prerequisites: 1'. A 'Financial' section is active, showing a table with columns: Unit, Asset ID, Book Name, Load Type, Transaction In/Out, Auto Approval Status, and Transaction Code. The table contains 24 rows of data, all with 'Y' in the 'Auto Approval Status' column.

Unit	Asset ID	Book Name	Load Type	Transaction In/Out	Auto Approval Status	Transaction Code
US001	000000000001	CORP	ADJ		Y	
US001	000000000001	FEDERAL	ADJ		Y	
US001	000000000089	CORP	ADJ		Y	
US001	000000000089	CORP	ADJ		Y	
US001	000000000089	FEDERAL	ADJ		Y	
US001	000000000089	FEDERAL	ADJ		Y	
US001	000000000091	CORP	ADJ		Y	
US001	000000000091	FEDERAL	ADJ		Y	
US001	000000000092	CORP	ADJ		Y	
US001	000000000092	CORP	ADJ		Y	
US001	000000000092	FEDERAL	ADJ		Y	
US001	000000000092	FEDERAL	ADJ		Y	
US001	000000000094	CORP	ADJ		Y	
US001	000000000094	CORP	ADJ		Y	
US001	000000000094	FEDERAL	ADJ		Y	

Field or Control	Description
Financial	Displays list of financial interfaces lines affected by the transaction.

You can also click the Help Financial icon for descriptions of the fields and controls.

Preview Prerequisites

The Preview Prerequisites page displays the pending interface lines that affect the same assets as the transaction. These interface lines should be processed before this transaction. You can click the drill down icon to view the specific interface line.

This example illustrates the fields and controls on the Preview Prerequisites page.

Run Mass Transactions								Preview Assets		Preview Interfaces		Preview Prerequisites									
Run Control ID 1																					
Transaction ADJ - Asset Cost Adjustment																					
Assets			7			Total Interface Rows			24			Prerequisites			1						
Prerequisites ?												Personalize		Find		First		1 of 1		Last	
Interface ID	Interface Line Number	Drilldown to Interface	Business Unit	Asset Identification	Trans Load Type	Load Status	Record														
10000004	0		US001	000000000089	RET	NEW	INTFC_FIN														

Field or Control	Description
Prerequisites	Displays list of pending interface lines that affect the same assets as this transaction.

You can also click the Help Prerequisites icon for descriptions of the fields and controls.

Populating Asset Management Tables with Mass Transaction Data

This topic discusses how to populate Asset Management tables using the Transaction Loader process.

Note: This topic is applicable only when the transaction you processed loads the Asset Management loader tables.

Page Used to Populate Asset Management Tables with Mass Transaction Data

Page Name	Definition Name	Usage
Load into AM Page	RUN_AMIF1000	<p>Run the Transaction Loader process, which reads the loader tables and populates Asset Management tables with the data.</p> <p>Search for transactions to run based on system source, load type, load status, and whether transactions consist of physical or financial records. You can use as many or as few of these criteria as necessary. The more search criteria that you use, the narrower your search results become.</p>

Load into AM Page

Use the Load into AM page (RUN_AMIF1000) to run the Transaction Loader process, which reads the loader tables and populates Asset Management tables with the data.

Search for transactions to run based on system source, load type, load status, and whether transactions consist of physical or financial records. You can use as many or as few of these criteria as necessary. The more search criteria that you use, the narrower your search results become.

Navigation:

Asset Management > Send/Receive Information > Interface Transactions > Load into AM

This example illustrates the fields and controls on the Load into AM page. You can find definitions for the fields and controls later on this page.

The screenshot shows the 'Load into AM' page with the following sections:

- Run Control Parameters:** Includes fields for *Request ID (1), Interface ID (10000020), AM Business Unit, Process Frequency (Always), To Interface ID (10000020), System Source (PS/PC Batch), and a checkbox for Process AM Integration.
- Find Trans Load ID (optional):** Includes dropdowns for System Source, Load Type, and Load Status (Pending). It has radio buttons for Financial Record (selected) and Physical Records, and a Search button.
- Interface Information:** A table with columns: Interface ID, System Source, Load Type, AM Business Unit, Load Description, Load Status, and Total Items in Query.

Locate the **Find Trans Load ID** (find transaction loader ID) group box.

Field or Control	Description
System Source	If you do not know the transaction load IDs, enter the system source that generated the transactions that you want to load, such as <i>AM Batch</i> or <i>Strategic Sourcing</i> . Also, enter the load type.
Load Type	A load type is a more detailed version of a transaction type. One transaction type can generate several different load types. Specify the transactions to load, such as <i>Asset Add</i> or <i>Phys Add</i> (physical addition), if you know the range of transaction load IDs. You can specify transactions by system source, from transaction load ID, and to transaction load ID.

Field or Control	Description
AM Business Unit	Select a business unit if you want to limit the load process by business unit.
Load Status	Select from the following values: <ul style="list-style-type: none"> • <i>Consolidat</i>: (consolidated): Transactions consolidated. • <i>Errored</i>: Transaction errors. • <i>Excluded</i>: Transactions excluded. • <i>In Process</i>: Transactions in process. • <i>Loaded</i>: Transactions loaded. • <i>On Hold</i>: Transactions on hold. • <i>Pending</i>: Transactions pending. • <i>Replaced</i>: Replaced by other interface records. • <i>Unitized</i>: Transactions unitized (will not be loaded).
Financial Record or Physical Records	Select one depending on the type of transaction that you want to load.

Using Asset Management Reporting Options

Understanding Asset Management Reporting Options

PeopleSoft delivers several kinds of report options within Asset Management. This topic discusses:

- Reporting and formatting options.
- Online reporting via inquiry pages.
- Asset management financial chart generation.

Reporting and Formats

Asset Management reports are generated as the result of an asset management process or in response to an ad hoc request for asset information. Processes and reports can be generated as part of scheduled batch activities or as one-time requests, all of which are handled through the Process Scheduler. The type of report that is generated is usually the result of how the data is to be presented or of the kind of processing that is required to produce the desired results.

Asset Management provides reports to aid in tracking and reconciling asset transactions, capital acquisition planning, depreciation, account activity, accounting entries, physical inventory, asset disposal and retirement, and to meet tax reporting requirements. Reports supporting these same asset management activities on the global level as well as statutory requirements are also available for Australia, Canada, France, Germany, Italy, India, and Japan. All of the available reports that are associated with asset management are listed in the topic “Asset Management Reports” in this documentation.

Most of the reports that are used for different functions within Asset Management make use of the same data but report it from a different perspective. For example, depreciation is often reviewed by ChartField activity. It is, however, also useful to review depreciation based on a category or location. To that end, you may use a report template that enables you to define the reporting-by method to be used.

PeopleSoft delivers report templates that can be shared by all users to include or exclude information of your choosing. The ChartField Format Template and the Report Fields Format Template control the sort order, field length to display, field label overrides, amount field length, and subtotalling. To accommodate the varying needs of many users, print options are available to override the report title and to select the ChartField by which to report, using **Report By** as the key, with a report suffix added to the report ID to indicate what value is used for **Report By**.

Asset Management also provides the tools to produce reports in user-defined formats. Using report IDs or user IDs as keys to reporting templates, multiple groups or individuals use the same general information provided in a report but receive it in a dynamically defined format addressing the particular needs of the group or individual.

Online Reporting

Asset Management provides online inquiries of the depreciation reporting table (DEPR_RPT), which displays high level summary data for a period with details available via drill down functions that are defined at the business unit/book definition level. When enabled for online reporting, selection criteria includes Business Unit, Book, Fiscal Year, Period, Asset Category, Profile ID and ChartFields. The drill down feature provides the option to view the data presented to the lowest level available.

Asset Management Charts

Asset Management provides the ability to display some financial data in 2-D, or stacked bar charts. This option is available for generating data comparisons (for example, depreciation per operating units or by book). By selecting the values to be compared, a full color coded chart is generated, which provides an at-a-glance depiction of financial data.

Prerequisites

To use Asset Management reporting options, you must have:

- Established business units and book definitions.

The online reporting option is established at the business unit/book definition level. You must have enabled this option for each business unit and each book that is associated with that business unit for which you want to view online inquiries with drill down capability.

- Established ChartFields.

Report suffix is appended to the run control ID for a report and defaults to a ChartField order. If additional ChartFields are to be defined, the new ChartFields must be included.

Online reporting selects data based on ChartFields:

- Defined drill down fields.

Online reporting enables users to view details of costs and depreciation from high level summary views to the lowest reporting level available for reporting periods. Once you have defined the drill down fields, you can view the details in finer granularity.

Related Links

“Understanding Asset Management Business and Cash Generating Units” (Asset Lifecycle Management Fundamentals)

“Understanding Asset Processing” (Asset Lifecycle Management Fundamentals)

“Understanding PeopleSoft ChartField Configuration” (Application Fundamentals)

Using Flexible Reporting and Formats

PeopleSoft enables you to generate reports and print them using your report format templates for the following reports:

- Cost Activity (RUN_AMAS2000)
- Depreciation Activity (RUN_AMDP2000)
- Asset Net Book Value (RUN_AMDP2100)
- Asset Reclassifications (RUN_AMAS240)
- Asset Transfers (RUN_AMAS2300)
- Asset Acquisitions (RUN_AMAS2100 and RUN_AMAS2110)

Pages Used to Run Reports With Format Templates

<i>Page Name</i>	<i>Definition Name</i>	<i>Usage</i>
Parameters Page	RUN_*	Select a report and apply a report format template in the Report Print Options group box or update or add a report format template.
ChartField Format Template Page	RPT_FMT_TMPL_SBP	Update or add new ChartField format templates. See Parameters Page
Report Fields Format Template Page	RPT_FMT_TMPL2_SBP	Update or add new report field format templates. See Parameters Page

Related Links

“Setting Up Reporting Options” (Asset Lifecycle Management Fundamentals)

Parameters Page

Use the Parameters page (RUN_*) to select a report and apply a report format template in the Report Print Options group box or update or add a report format template.

Navigation:

Asset Management > Financial Reports

This example illustrates the fields and controls on the Asset Net Book Value page (Report Print Options). You can find definitions for the fields and controls later on this page.

Asset Net Book Value

Run Control ID: tst Report Manager Process Monitor Run

Language: English

Report Print Options

Report By: Asset Category Title Override: Asset NBV Report - IT Dept

CF Template ID: Update/Add CF Template Amount Length:

RF Template ID: Update/Add RF Template

Report Request Parameters

Unit: US001 Include Transfers

Book Name: Include Retirements

Fiscal Year/Period

As Of Fiscal Year: Period:

OR

Date Range

As of Date: 12/31/2012

Type of Report

Detail Summary

Stopped depreciation options

Assets with negative NBV only

Assets with NBV < Salvage

Location:

Category:

Operating Unit:

Fund Code:

Department: 11000

Program Code:

Class Field:

Budget Reference:

Product:

PC Business Unit:

Project:

Activity:

Source Type:

Category:

Subcategory:

Access the run control page for the report to be formatted with user-defined parameters and expand the **Report Print Options** group box.

Note: Not all Asset Management reports are enabled with the flexible report format template feature.

Report Print Options

<i>Field or Control</i>	<i>Description</i>
Report By	Select from the valid Report By values by which data is to be reported for this report type. For example, the report may use ChartFields and the information in the report can be presented by any ChartField value. If you select DEPTID, the data is grouped by department ID. If you select ACCOUNT, the same information is retrieved but is grouped by account. The purpose or audience for your report drives your selection.

Field or Control	Description
CF Template ID (ChartField Template ID)	<p>Select the template ID for this report from the saved templates by clicking the drop down arrow. Click the Update/Add CF Template link to go to the ChartField Format Template page where you can add a new template or update an existing template. The template contains the report format you have defined. For example, perhaps you need a list of departments and expense totals for a period. You can limit your report to include only the relevant fields for your task and save the selected options as a template for future use.</p> <hr/> <p>Note: To add a new CF template ID, the CF Template ID field must be blank before you select the Update/Add CF Template link.</p>
RF Template ID (Report Fields Template ID)	<p>Select the RF template ID for this report from the saved templates by clicking the drop down arrow. Click the Update/Add RF Template link to go to the Report Fields Format Template page where you can add a new template or update an existing template. This template contains the format you have defined for the report fields. Select which fields to include in your report, such as Cost Balance, Current Depreciation, and so on. You can override the field label as well.</p> <hr/> <p>Note: To add a new RF template ID, the RF Template ID field must be blank before you select the Update/Add RF Template link.</p>
Title Override	<p>Enter the title for the report. This field enables you to enter a meaningful report title for this run of the report. If you do not enter a title, the system selects a default value from the string table value of the technical value for the report. Instead, it is useful to name your report based on the current reason, date, or requester for the report.</p>
Amount Length	<p>Enter the maximum number of spaces that are required for the Amount fields to display. The default is 23 digits.</p>
Update/Add CF Template	<p>Click this link to update or add a new ChartField format template.</p>
Update/Add RF Template	<p>Click this link to update or add a new report fields format template.</p>

ChartField Format Template

Use the ChartField Format Template page (RPT_FMT_TMPL_SBP) to update or add new ChartField format templates.

Navigation:

Click the **Update/Add CF Template** link in the Report Print Options group box.

This example illustrates the fields and controls on the ChartField Format Template page. You can find definitions for the fields and controls later on this page.

ChartField Format Template

Report Template

Report ID

CF Template ID [Delete Template](#)

Chartfields

Field Name	Field Order	Display Length	Label Override	Include in Report	Print subtotals
Operating Unit	<input type="text" value="3"/>	<input type="text" value="8"/>	<input type="text" value="Oper Uni"/>	<input checked="" type="checkbox"/>	<input checked="" type="checkbox"/>
Fund Code	<input type="text" value="4"/>	<input type="text" value="5"/>	<input type="text" value="Fund"/>	<input checked="" type="checkbox"/>	<input checked="" type="checkbox"/>
Department	<input type="text" value="5"/>	<input type="text" value="10"/>	<input type="text" value="Dept"/>	<input checked="" type="checkbox"/>	<input checked="" type="checkbox"/>
Program Code	<input type="text" value="6"/>	<input type="text" value="5"/>	<input type="text" value="Progr"/>	<input checked="" type="checkbox"/>	<input checked="" type="checkbox"/>
Class Field	<input type="text" value="7"/>	<input type="text" value="5"/>	<input type="text" value="Class"/>	<input checked="" type="checkbox"/>	<input checked="" type="checkbox"/>
Budget Reference	<input type="text" value="8"/>	<input type="text" value="8"/>	<input type="text" value="Bud Ref"/>	<input checked="" type="checkbox"/>	<input checked="" type="checkbox"/>
Product	<input type="text" value="9"/>	<input type="text" value="6"/>	<input type="text" value="Produc"/>	<input checked="" type="checkbox"/>	<input checked="" type="checkbox"/>
PC Business Unit	<input type="text" value="10"/>	<input type="text" value="5"/>	<input type="text" value="PC Bu"/>	<input checked="" type="checkbox"/>	<input checked="" type="checkbox"/>
Project	<input type="text" value="11"/>	<input type="text" value="15"/>	<input type="text" value="Project"/>	<input checked="" type="checkbox"/>	<input checked="" type="checkbox"/>
Activity	<input type="text" value="12"/>	<input type="text" value="15"/>	<input type="text" value="Activity"/>	<input checked="" type="checkbox"/>	<input checked="" type="checkbox"/>
Source Type	<input type="text" value="13"/>	<input type="text" value="5"/>	<input type="text" value="Sourc"/>	<input checked="" type="checkbox"/>	<input checked="" type="checkbox"/>
Category	<input type="text" value="14"/>	<input type="text" value="5"/>	<input type="text" value="Categ"/>	<input checked="" type="checkbox"/>	<input checked="" type="checkbox"/>
Subcategory	<input type="text" value="15"/>	<input type="text" value="5"/>	<input type="text" value="Subca"/>	<input checked="" type="checkbox"/>	<input checked="" type="checkbox"/>
Asset Category	<input type="text" value="99"/>	<input type="text" value="5"/>	<input type="text" value="Categ"/>	<input checked="" type="checkbox"/>	<input checked="" type="checkbox"/>

Select the ChartFields to include within the report, the display order and length, a label override and which subtotals to print. You can also select to delete a template by clicking the **Delete Template** link.

Report Fields Format Template Page

Use the Report Fields Format Template page (RPT_FMT_TMPL2_SBP) to update or add new report field format templates.

Navigation:

Click the **Update/Add RF Template** link in the Report Print Options group box.

This example illustrates the fields and controls on the Report Fields Format Template page. You can find definitions for the fields and controls later on this page.

Report Fields Format Template

Report Template

Report ID

RF Template ID [Delete Template](#)

Report Fields

Field Label	Include in Report	Override Label	Label Override
Asset ID	<input checked="" type="checkbox"/>	<input type="checkbox"/>	Asset ID
Description	<input checked="" type="checkbox"/>	<input type="checkbox"/>	Description
Cost Type	<input checked="" type="checkbox"/>	<input type="checkbox"/>	Cost Type
Cost Balance	<input checked="" type="checkbox"/>	<input type="checkbox"/>	Cost Balance
Current Depr	<input checked="" type="checkbox"/>	<input type="checkbox"/>	Current Depr
YTD Depr	<input checked="" type="checkbox"/>	<input type="checkbox"/>	YTD Depr
LTD Depr	<input checked="" type="checkbox"/>	<input type="checkbox"/>	LTD Depr
Net Book Value	<input checked="" type="checkbox"/>	<input type="checkbox"/>	Net Book Value

Select the report fields to include within the report and override the labels if necessary.

<i>Field or Control</i>	<i>Description</i>
RF Template ID (report fields template ID)	Enter a template name and click the Add Template link.

<i>Field or Control</i>	<i>Description</i>
Add Template	Click this link to add a new report format template after entering a template name in the field. Once clicked, the report fields appear on the page from which to select. This link is replaced by the Delete Template link after you have defined a template.

<i>Field or Control</i>	<i>Description</i>
Delete Template	Click to delete an existing template.

See the product documentation for PeopleTools: PeopleSoft Process Scheduler

Related Links

[PeopleSoft Asset Management Reports](#)

Using Online Reporting

To use online reporting in Asset Management, you must first enable the option on the Asset Management Business Unit/Book Definition page. You may optionally use drill down features and link group IDs to user IDs to use with online reporting.

Page Used to Generate Online Reports

<i>Page Name</i>	<i>Definition Name</i>	<i>Usage</i>
<u>Cost and Depreciation Page</u>	AM_REPORT1	View summarized depreciation activity, cost activity and net book value from reporting tables and drill down to details.

Cost and Depreciation Page

You can define the drill down functions for online inquiries of the depreciation reporting table (DEPR_RPT). The report displays high level summary data for a period with details available for drill down to the lowest available level. The drill down definition is set up at the business unit, book definition level in the Financial Reports component.

Use the Cost and Depreciation page (AM_REPORT1) to view summarized depreciation activity, cost activity and net book value from reporting tables and drill down to details.

Navigation:

Asset Management > Financial Reports > Cost and Depreciation Summary

This example illustrates the fields and controls on the Cost and Depreciation page. You can find definitions for the fields and controls later on this page.

Cost and Depreciation

Selection Criteria

*Business Unit US001 NEW YORK OPERATIONS
 *Book Name Corporate
 *Fiscal Year Period
 Currency
 Group Type

Secondary Selection Criteria

Cost and Depreciation by Period Personalize | |

Period	Drill-down To	Current Depr	YTD Depr	LTD Depr	Cost	Salvage Value	NBV
1	--- Select Field ---			221,520.00	20,434,220.97	10,000.00	20,212,700.97
2	--- Select Field ---			221,520.00	20,449,459.94	12,000.00	20,227,939.94
3	--- Select Field ---			221,520.00	20,906,459.94	14,000.00	20,684,939.94
4	--- Select Field ---			221,520.00	20,906,459.94	14,000.00	20,684,939.94
5	--- Select Field ---			221,520.00	20,908,209.94	14,000.00	20,686,689.94
6	--- Select Field ---			221,520.00	20,908,209.94	14,000.00	20,686,689.94
7	--- Select Field ---			221,520.00	20,908,209.94	14,000.00	20,686,689.94
8	--- Select Field ---			221,520.00	20,908,209.94	14,000.00	20,686,689.94
9	--- Select Field ---			221,520.00	20,888,308.97	12,000.00	20,666,788.97
10	--- Select Field ---			221,520.00	20,888,308.97	13,080.00	20,666,788.97
11	--- Select Field ---			221,520.00	20,888,308.97	13,080.00	20,666,788.97
12	--- Select Field ---			221,520.00	20,888,308.97	13,080.00	20,666,788.97

Selection Criteria

Field or Control	Description
Business Unit, Book Name, Fiscal Year, and Currency	<p>All of these values are required.</p> <p>The business unit is based on the user ID options.</p> <p>The book name is the default book for the business unit, if the business unit is not blank.</p> <p>The fiscal year uses today's date from the calendar table, if the book name is not blank.</p> <p>CurrencyThe system uses the business unit, book name base currency for the default currency.</p>
Period	<p>Enter the period when the expected data is of high volume and selection criteria is entered. If you leave the field blank, all periods display after performing your search.</p>

Field or Control	Description
Group Type	This field is used only when the business unit/book name uses group assets. If group assets is not defined at the installation level, Group Type will not display. Select <i>Group Asset</i> , <i>Group Member</i> , or <i>None</i> .

Secondary Selection Criteria

Select any secondary criteria to further narrow the report results. The available options reflect the ChartFields, asset category, asset profile ID, and cost type.

After you have entered the selection criteria and performed the search, the resulting data is summarized by period. You can now drill down on any asset to the lowest level of data that can be viewed. This option is set when you create the group ID definition. Drill down enables bidirectional summary data, so that you can drill down and go back to a previous level of data. The system displays *breadcrumbs* to manage your drill down layers.

Related amounts are grouped and viewed in separate tabs.

Net Book Value

Net book value includes period depreciation, year-to-date (YTD) depreciation, LTD depreciation, cost, salvage value and net book value.

- Special term depreciation

Includes special depreciation, accelerated depreciation, increase depreciation, standard depreciation, and initial depreciation.

Note: When no special term depreciation is tracked, this tab is hidden.

- ChartFields

Includes ChartFields that are available for drill down when the *All Assets* option is selected.

- Other Information

Includes profile ID, location, fixed asset account, and accumulated depreciation account when the *All Assets* option is selected.

Depreciation Activity

Depreciation activity includes accumulated depreciation for additions, transfers, re-categorization, retirements, reinstatements, and prior depreciation.

Note: When the group type *Group Member* is selected, depreciation activity is hidden.

Cost Activity

Cost activity includes cost addition, adjustment, transfer, re-categorization, retirement, and reinstatement.

Note: When **Group Type** is *Group Asset*, Cost Activity is hidden.

Charting Financial Data

When using Asset Management charting features, you select your criteria and view the resulting online chart output.

Page Used to Chart Financial Data

<i>Page Name</i>	<i>Definition Name</i>	<i>Usage</i>
Selection Criteria Page	AMCHART1	Select criteria and create and view online charts of financial data.

Selection Criteria Page

Use the Selection Criteria page (AMCHART1) to select criteria and create and view online charts of financial data.

Navigation:

Asset Management > Financial Reports > Generate AM Charts

This example illustrates the fields and controls on the Selection Criteria page. You can find definitions for the fields and controls later on this page.

Selection Criteria

'Unit
Book Name

Compare Data

'Compare

Value1

USD

vs.

Value2

USD

Cost
 Accumulated Depr
 Net Book Value

ChartField Selection Criteria

From Year
To Year

Search Results

Personalize |
Find |

First
1-4 of 4
Last

	Fiscal Year	AUTO Cost	FF Cost	AUTO Net Book Value	FF Net Book Value
1	2005	461,963.00	273,678.96	253,324.93	273,678.96
2	2006	461,963.00	273,678.96	217,749.93	273,678.96
3	2007	461,963.00	273,678.96	182,174.93	273,678.96
4	2008	461,963.00	273,678.96	164,566.60	273,678.96

Chart Type:

The Selection Criteria page defines the parameters for the chart. Values are derived to compare business units, books, ChartFields, and totals for cost, accumulated depreciation, and net book value, and are depicted in the resulting chart.

Compare Data

<i>Field or Control</i>	<i>Description</i>
Compare	Select the values you want to compare in the chart. For example, if business unit is selected, you must select the business units to compare. The chart depicts the comparison between the business unit values that you enter.

Field or Control	Description
Cost, Accumulated Depr (accumulated depreciation), Net Book Value	<p>Select the summary totals to be compared. For example, to create a what-if scenario of business units for Germany and France operations, select Accumulated Depr to compare that value for each business unit. You must select at least one summary total to compare or any combination of the three.</p> <hr/> <p>Note: When using reporting functions that report multiple currencies, the comparison is always reported in the <i>from</i> business unit currency.</p>
ChartField Selection Criteria	Further define the chart to display subtotals by ChartField.
From Year and To Year	Enter the range of fiscal years to include in the chart.
Chart Type	Select the type of chart you want to assemble. The valid choices are <i>2-D Horizontal Bar</i> or <i>Stacked Bar</i> .

When you have selected all the appropriate criteria, gather the data by clicking the **Search** button. The data summary totals display, with one row for each fiscal year requested and one column for each field and value selected. Before you can view the chart, you must press the **Generate Chart** button.

The chart image displays automatically on a second page tab. A legend is included in the chart for each color-coded bar in the chart. A summary of the chart totals displays in the **Chart Creation Data** group box.

This illustration depicts a summary of the chart totals:

This example illustrates the fields and controls on the Example: Chart Image page. You can find definitions for the fields and controls later on this page.

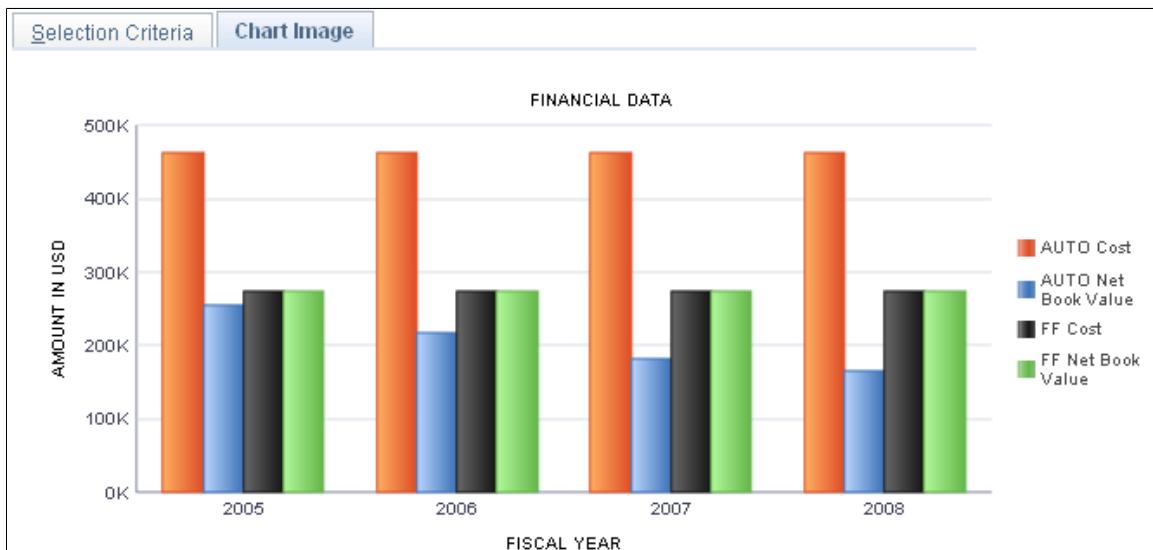

This example illustrates the fields and controls on the Example: Chart Summary Totals. You can find definitions for the fields and controls later on this page.

Chart Creation Data				Personalize	Find	First	1-16 of 16	Last
Year	Description	Amount	Currency					
2005	AUTO Cost	461,963.00	USD					
2005	AUTO Net Book Value	253,324.93	USD					
2005	FF Cost	273,678.96	USD					
2005	FF Net Book Value	273,678.96	USD					
2006	AUTO Cost	461,963.00	USD					
2006	AUTO Net Book Value	217,749.93	USD					
2006	FF Cost	273,678.96	USD					
2006	FF Net Book Value	273,678.96	USD					
2007	AUTO Cost	461,963.00	USD					
2007	AUTO Net Book Value	182,174.93	USD					
2007	FF Cost	273,678.96	USD					
2007	FF Net Book Value	273,678.96	USD					
2008	AUTO Cost	461,963.00	USD					
2008	AUTO Net Book Value	164,566.60	USD					
2008	FF Cost	273,678.96	USD					

Analyzing Asset Management Using PeopleSoft Insights

Analyzing Asset Management Using PeopleSoft Insights

PeopleSoft Asset Management delivers two Insights dashboards that help users with business intelligence analytics. These dashboards are *Asset Analytics* and *Year-Over-Year Asset Analytics*.

Pages Used to Analyze Asset Management Using PeopleSoft Insights

<i>Page Name</i>	<i>Definition Name</i>	<i>Usage</i>
<u>Asset Analytics Dashboard</u>		Analyze asset count, cost, depreciation/amortization expense, and net book value based on asset type and category.
<u>Year-Over-Year Asset Analytics Dashboard</u>		Analyze year-over-year comparisons of asset acquisitions, disposals, depreciation/amortization expense, and cost versus net book value.

Accessing Asset Management Insights Dashboards

To access Asset Management Insights Dashboards, add these tiles to any Fluid homepage:

This example illustrates the Asset Analytics tile



This example illustrates the Year-Over-Year Asset Analytics tile



For more information about how to add a tile to a PeopleSoft Fluid Home page, see:

‘Working with the Fluid User Interface’ in the *PeopleTools Accessibility Guide*.

‘Working with Fluid Homepages and Dashboards’ in the *PeopleTools Applications User’s Guide*.

“Adding Homepages and Tiles” (Application Fundamentals)

For more information about PeopleSoft delivered Insights dashboards, definitions, privileges, and roles, see “Understanding PeopleSoft Insights Using PeopleSoft Search Framework” (Application Fundamentals)

Asset Analytics Dashboard

Use the Asset Analytics dashboard to analyze asset count, cost, depreciation/amortization expense, and net book value based on asset type and category.

Navigation:

Select the Asset Analytics tile

This example illustrates the fields and controls on the Asset Analytics Dashboard (1 of 3)

Asset Analytics

Business Unit: US001 x Asset Book Name: CORP x Fiscal Year: 2021 x Accounting Period: 12 x + Add filter

Business Unit, Book, Fiscal Year and Accounting Period are mandatory filters.

Asset Filters

- Business Unit * (Select...)
- Book * (Select...)
- Fiscal Year * (Select...)
- Accounting Period * (Select...)
- Capitalization (Select...)
- Asset Type (Select...)
- Asset Subtype (Select...)
- Profile (Select...)
- Category (Select...)
- Acquisition Code (Select...)
- Location (Select...)
- Area (Select...)

All visualizations use the Book Currency: US Dollar

Asset Count 821	Total Cost 29,158,412	Net Book Value 13,377,818
---------------------------	---------------------------------	-------------------------------------

This example illustrates the fields and controls on the Asset Analytics Dashboard (2 of 3)



This example illustrates the fields and controls on the Asset Analytics Dashboard (3 of 3)

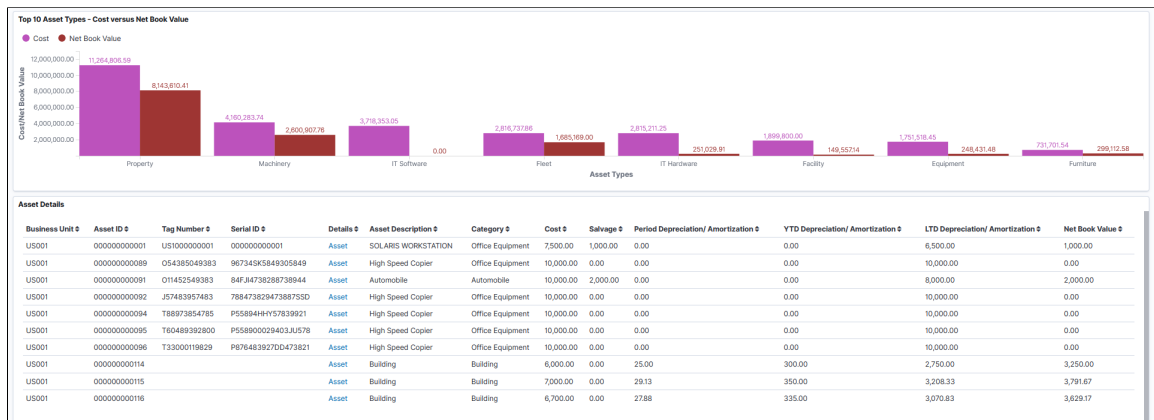

The visualizations and data displayed on the Asset Analytics dashboard are based on values selected for the **Business Unit**, **Book**, **Fiscal Year**, and **Accounting Period** filters, which are required. You can specify default Business Unit and Book values using the **Insights Reporting Preferences** section of the “Asset Management - User Preferences Page” (Application Fundamentals). **Fiscal Year** and **Accounting Period** values are based on the calendar for the selected business unit and book, and the current system date. You can override all of the aforementioned filter values at any time.

You can further filter visualizations and data based on additional delivered filters, such as **Capitalization**, **Profile** (Asset Profile), and more.

Data can also be filtered by selecting any categorical data within a visualization (for example, an individual bar in a bar graph).

The following visualizations are part of this dashboard:

- *Asset Count:* Provides count of total assets (capitalized and non-capitalized).
- *Total Cost:* Provides a snapshot of total asset cost (capitalized and non-capitalized).
- *Net Book Value:* Provides a snapshot of total net book value of your assets.

- *Top 10 Asset Types - Asset Count*: Provides an analysis of the top ten asset types that represent the total asset count. Each stacked bar provides a part-to-whole comparison of capitalized and non-capitalized assets.
- *Top 10 Categories - Asset Cost*: Provides an analysis of the top ten asset categories with the highest asset cost. The stacked bar chart displays a part-to-whole comparison of capitalized and non-capitalized asset cost.
- *Top 10 Categories - Period Depreciation/Amortization*: Provides an analysis of the top ten asset categories with the highest depreciation/amortization expense. The chart identifies depreciation/amortization expense by acquisition code.
- *Top 10 Categories - Net Book Value*: Provides an analysis of the top ten asset categories with the highest net book value. The chart identifies net book value by acquisition code.
- *Top 10 Asset Types - Cost versus Net Book Value* Provides a side-by-side comparison of cost and net book value for each of the top ten asset types.
- *Asset Details*: Displays a list of assets making up the data shown in the visualizations. Use the **Asset** link to access the Printable View of Asset page and view further details about the asset.

Each visualization can be viewed separately in full screen. You can also drill down for more information using the **Inspect** option. That data can be downloaded as a comma separated value (CSV) file.

Year-Over-Year Asset Analytics Dashboard

Use the Year-Over-Year Asset Analytics dashboard to analyze year-over-year comparisons of asset acquisitions, disposals, depreciation/amortization expense, and cost versus net book value.

Navigation:

Select the Year-Over-Year Asset Analytics tile

This example illustrates the fields and controls on the Year-Over-Year Asset Analytics Dashboard (1 of 4)

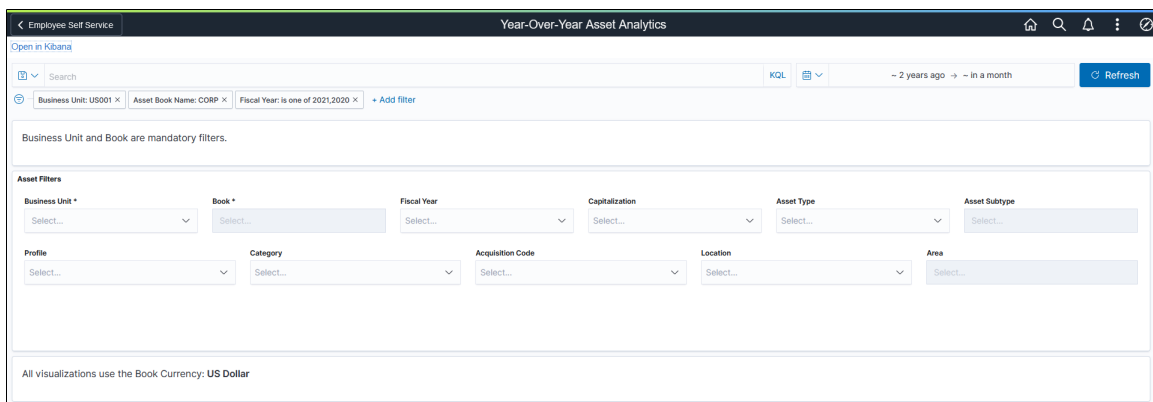

This example illustrates the fields and controls on the Year-Over-Year Asset Analytics Dashboard (2 of 4)

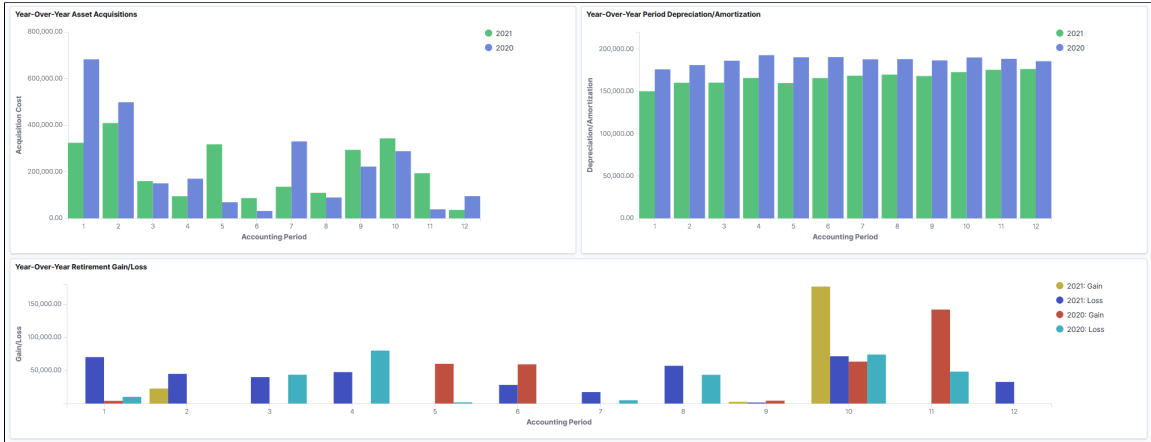

This example illustrates the fields and controls on the Year-Over-Year Asset Analytics Dashboard (3 of 4)

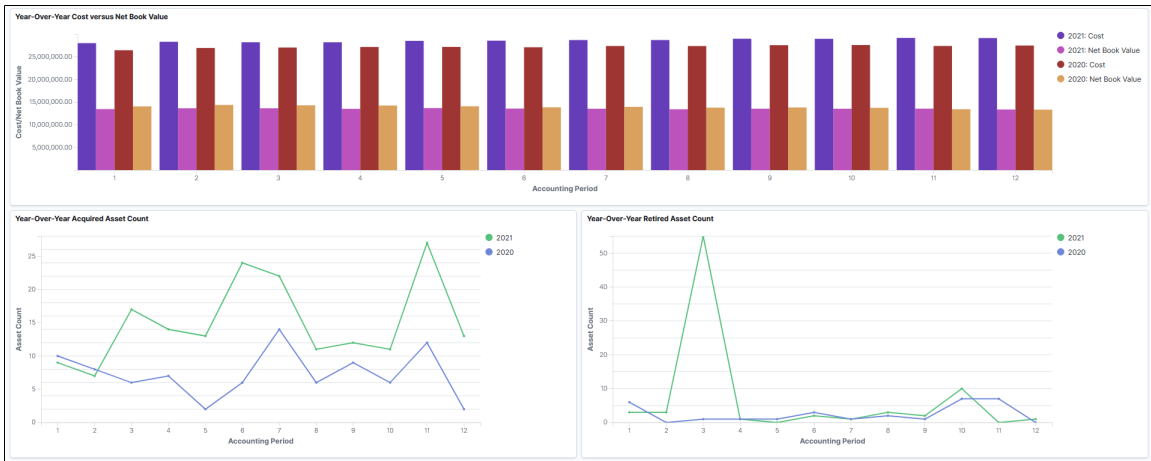

This example illustrates the fields and controls on the Year-Over-Year Asset Analytics Dashboard (4 of 4)

Fiscal Year	Accounting Period	Business Unit	Asset ID	Tag Number	Serial ID	Details	Asset Description	Category	Cost	Salvage	Period Depreciation/ Amortization	YTD Depreciation/ Amortization	LTD Depreciation/ Amortization	Net Book Value
2020	1	US001	000000000001	US1000000001	000000000001	Asset	SOLARIS WORKSTATION	Office Equipment	7,500.00	1,000.00	0.00	0.00	6,500.00	1,000.00
2020	1	US001	000000000089	OS4385049383	967345K5849305849	Asset	High Speed Copier	Office Equipment	10,000.00	0.00	0.00	0.00	10,000.00	0.00
2020	1	US001	000000000091	O11452549383	84FJ4738288738944	Asset	Automobile	Automobile	10,000.00	2,000.00	0.00	0.00	8,000.00	2,000.00
2020	1	US001	000000000092	J57483957483	78847382947388755D	Asset	High Speed Copier	Office Equipment	10,000.00	0.00	0.00	0.00	10,000.00	0.00
2020	1	US001	000000000094	T88973854785	P55894HHY57839921	Asset	High Speed Copier	Office Equipment	10,000.00	0.00	0.00	0.00	10,000.00	0.00
2020	1	US001	000000000095	T60489392900	P55890029403JLJ578	Asset	High Speed Copier	Office Equipment	10,000.00	0.00	0.00	0.00	10,000.00	0.00
2020	1	US001	000000000096	T3300019829	P8764839270D473821	Asset	High Speed Copier	Office Equipment	10,000.00	0.00	0.00	0.00	10,000.00	0.00
2020	1	US001	000000000104			Asset	L05	Leased Automobile	34,606.61	0.00	0.00	0.00	34,606.61	0.00
2020	1	US001	000000000105			Asset	Asset_One	Automobile	0.00	0.00	0.00	0.00	0.00	0.00
2020	1	US001	000000000106			Asset	Asset_Two	Automobile	0.00	0.00	0.00	0.00	0.00	0.00

The visualizations and data displayed on the Asset Analytics dashboard are based on values selected for the **Business Unit**, and **Book** filters, which are required. You can specify default Business Unit and Book values using the **Insights Reporting Preferences** section of the “Asset Management - User Preferences Page” (Application Fundamentals). Current and previous **Fiscal Year** values are based on the calendar for the selected business unit and book. You can override filter values at any time.

You can further filter visualizations and data based on additional delivered filters, such as **Capitalization**, **Profile** (Asset Profile), and more.

Data can also be filtered by selecting any categorical data within a visualization (for example, an individual bar in a bar graph).

The following visualizations are part of this dashboard:

- *Year-Over-Year Asset Acquisitions*: Provides a year-over-year comparison of asset acquisitions by acquisition cost and accounting period. Assets included are financial and non-financial. The horizontal axis represents the accounting period, and the vertical axis represents acquisition cost.
- *Year-Over-Year Period Depreciation/Amortization*: Provides a year-over-year comparison of asset depreciation and amortization by accounting period. The horizontal axis represents the accounting period, and the vertical axis represents the depreciation and amortization amount.
- *Year-Over-Year Retirement Gain/Loss*: Provides a year-over-year comparison of asset retirement gain and loss, by accounting period. The horizontal axis represents the accounting period, and the vertical axis represents retirement gain or loss.
- *Year-Over-Year Cost Versus Net Book Value*: Provides a year-over-year comparison of asset cost and net book value by accounting period. The horizontal axis represents the accounting period, and the vertical axis represents asset cost and net book value.
- *Year-Over-Year Acquired Asset Count*: Provides a year-over-year comparison of acquired asset count by accounting period. The horizontal axis represents the accounting period, and the vertical axis represents asset count.
- *Year-Over-Year Retired Asset Count*: Provides a year-over-year comparison of retired asset count by accounting period. The horizontal axis represents the accounting period, and the vertical axis represents retired asset count.
- *Asset Details*: Displays a list of assets making up the data shown in the visualizations. Use the **Asset** link to access the Printable View of Asset page and view further details about the asset.

Each visualization can be viewed separately in full screen. You can also drill down for more information using the **Inspect** option. That data can be downloaded as a CSV file.

Using Asset Management Self Service Web Components

Understanding Self Service Components in Asset Management

Self-service web applications provide your employees secure and convenient access to information. For many people, self-service applications provide an improved alternative to automated telephone prompting systems. In addition, they can help ease the workload for internal support staff.

PeopleSoft delivers several self-service web components as templates. You can use the PeopleTools Application Designer to modify these Web components just as you would any application components.

Asset Management provides four self-service web components:

Component	Description
Assets	Provides details for an individual asset, including the reference information (ID, tag number, and serial number), location, department, model, manufacturer, and custodian.
Asset Transfer Request	An employee can create and submit a request to indicate an asset has been lost, stolen, inappropriately assigned, or relocated to another department.
Asset Transfer Approval	A manager can approve, deny, or hold an asset transfer request that is submitted by an employee.
Department Assets	Provides a list of all assets that are assigned to a particular department for which the manager is responsible.

The information displayed in these pages derives directly from the tables in Asset Management.

Security

The user profile that is created for each individual who accesses the self-service web application determines the pages the user can access. Create user profiles in the User Profiles - General page within the User Profile component. Assign a role to each user profile and link roles to permission lists. Each permission list identifies the pages that individuals assigned to a role can access. To modify the access for specific web pages for each role, modify the permission list for the user's role.

Note: If a permission list is modified, it changes the access for all users who are assigned to roles to which the permission list is linked.

Use the user profile to define to which data the user has access. For example, you can associate the user profile for an employee with a specific employee ID. When employees sign on to the self-service web application, they only receive access to asset management information for the employee that is assigned to that employee ID. As another example, you can associate the user profile for a manager with a specific employee ID. The manager receives access to asset management information for assets to which they are assigned.

See the product documentation for *PeopleTools: Security Administration*.

Asset Management Roles

Asset Management provides self-service Web pages for the following roles:

- Employees
- Managers

PeopleSoft delivers definitions for each of these roles. You assign permission lists to each role.

Employees have access to self-service web pages where they can perform the following tasks:

- View asset details.
- Create asset transfer requests.

Managers have access to self-service web pages where they can perform the following tasks:

- View asset details.
- View assets by department.
- Approve, deny, or hold asset transfer requests.

See the product documentation for *PeopleTools: Security Administration*

Prerequisites to Using Self Service Web Components

Before using Asset Management, you must set up the product application.

To use employee and manager data, you must also transfer data from the Human Resources database to the Financials database. When using Human Capital Management applications, the system uses application messaging to retrieve data from the Human Capital Management tables to the Financials tables. The application messages that provide the data needed for Asset Management Self Service web components are PERSON_BASIC_SYNC and PERSON_BASIC_FULL_SYNC.

Additionally, you must define user or employee IDs, user profiles, roles, and permission lists.

See also the product documentation for *PeopleSoft Application Fundamentals*, *PeopleTools: Security Administration*, *PeopleTools: Supported Integration Technologies*

Related Links

“Understanding Asset Management Business and Cash Generating Units” (Asset Lifecycle Management Fundamentals)

“Understanding Asset Processing” (Asset Lifecycle Management Fundamentals)

Using Self Service Application Pages

This topic describes the web pages that employees or managers can access to view or modify information for Asset Management. The information that appears on the page and the use of the page might differ, depending on the user's role. Both employees and managers can review asset information and submit asset transfer requests. However, only managers can approve, hold, or deny asset transfer requests.

Note: Approvals on the self-service web application pages do not automatically generate transactions in Asset Management. An email or a work list is sent to a corresponding employee to enter the action manually in Asset Management.

Pages Used to Use Self Service Application Pages

<i>Page Name</i>	<i>Definition Name</i>	<i>Usage</i>
My Assets Page	AM_MY_ASSET	Employees view a list of assets that are assigned to them, access asset detail information, and submit asset transfer requests.
Asset Information Page	AM_MY_ASSET_DETAIL	Employees and managers view asset detail information and submit asset transfer requests. See My Assets Page
Asset Transfer Request Page	AM_MY_ASSET_RQST1	Employees submit an Asset Transfer Request to a manager. The Asset Transfer Request displays asset detail and transfer request information. See My Assets Page
My Departments	AM_MY_DEPT	Managers view a list of departments that are assigned to them and access department's asset information.
My Department	AM_MY_DEPT_ASSET	Managers view a list of assets that are assigned to their departments, access asset detail information, and submit asset transfer requests.

Page Name	Definition Name	Usage
Approve Asset Transfer	AM_MY_ASSETS_RQST2	Managers approve, deny, or hold asset transfer requests submitted by themselves or their employees.

My Assets Page

Use the My Assets page (AM_MY_ASSET) to allow employees to view a list of assets that are assigned to them, access asset detail information, and submit asset transfer requests.

Navigation:

Employee Self-Service > Assets > View/Transfer My Assets

This example illustrates the fields and controls on the My Assets page. You can find definitions for the fields and controls later on this page.

My Assets
Kenneth Schumacher

Click an Asset link to view asset detail information.
Click the Status link to view Approval Status or click Transfer to submit a Transfer Request.

Transaction Information				Personalize Find
Asset	Tag Number	Department	Status	
TOSHIBA EQUIUM 7100D		Engineering	-	Transfer
Dell Latitude C400		Engineering	-	Transfer
Dell Latitude C400	ITTAG149		-	Transfer

Employees view a list of assets that are assigned to them, access asset detail information, and submit asset transfer requests.

For information about approving self service requests using the PeopleSoft Fluid User Interface, see [Pending Approvals - Asset Self Service Page](#).

Using the Global Features of PeopleSoft Asset Management

Understanding PeopleSoft Asset Management in Global Settings

Requirements for asset tracking and the subsequent taxing and reporting on assets vary around the world. PeopleSoft Asset Management provides enhanced enterprise-wide global support.

This topic provides the information necessary to implement country-specific options to meet local tracking, taxation, and reporting requirements for Asset Management.

Note: You must have established the correct international options at implementation to display and use these pages.

Using PeopleSoft Asset Management in Australia

PeopleSoft Asset Management provides the options to identify assets for and calculate deductions of expenditures on assets for research and development (R&D) based on aggregate values.

The system provides options to manage Australian tax credit allowances related to capital investment projects that include provisions for rebates (often referred to as credits).

The system provides the options to track and report on the usage of assets requiring changes in creditable purpose (CCP), assets that may be subject to goods and services tax (GST) or value-added tax (VAT), and capital gains taxes (CGT).

The system provides the functionality to perform "net-method" asset revaluation in accordance with Australian accounting standards (AASB1010 and AASB1041), which require crediting to related asset accounts the balance of accumulated depreciation at the date on which an asset is revalued.

Using PeopleSoft Asset Management in Canada

PeopleSoft Asset Management enables you to calculate depreciation for tax purposes in Canada under the terms of the Capital Cost Allowance (CCA) Reporting. In Canada, all depreciation is calculated on the pool or class of assets by using the rate that is prescribed by the Income Tax Act.

The CCA calculation consists of several components. To calculate CCA, the undepreciated capital cost (UCC) of assets at the beginning of the taxation year is determined, and acquisitions and dispositions during the year are added and subtracted to obtain the balance that can be depreciated. A percentage depreciation and CCA rate is applied to this UCC balance to determine the maximum amount that can be claimed. The CCA that is claimed is deducted from the beginning UCC to calculate the UCC at the end of the year. The final balance is used at the beginning of the following year.

Using PeopleSoft Asset Management in France

PeopleSoft Asset Management supports the specialized derogatory depreciation methods commonly used in France.

The system provides the reporting features necessary to track and report the French business tax at the asset book level and the asset profile level.

The system provides the functionality to perform asset revaluation as necessary.

Using PeopleSoft Asset Management in Germany

PeopleSoft Asset Management supports commonly used practices in Germany, including Staffel depreciation, a half-year prorate convention, geometric digressive depreciation, a parameter-driven automatic retirement process, and management of capitalization limits for low-value assets. In addition, PeopleSoft Asset Management provides reports to meet German statutory requirements.

Using PeopleSoft Asset Management in India

PeopleSoft Asset Management provides asset processing features that correspond to the tax reporting requirements established by the Indian Tax Depreciation Act of 1961. This local standard requires that assets are grouped within a defined *tax block*. Currently India identifies four asset tax blocks: buildings, furniture and fixtures, machinery and plant, and intangibles. Each block of assets is further assigned a *tax group* or class, and each class maintains an individual tax rate. The Indian *tax year* is a fixed fiscal calendar starting April 1 and ending March 31. Tax depreciation is reported annually at the fiscal year to the tax authority per asset block.

The system takes into account the rules regarding the treatment of capital and operating leases by enabling you to designate them.

The system provides the Straight Line Percent depreciation method for India, which calculates depreciation based on rates, and useful life is calculated on cost, salvage value, and depreciation rate combined.

The system provides the India Asset Tax Register, which reports all booked transactions to show the cost, depreciation, and net book value of assets, as well as tax depreciation reporting options.

Using PeopleSoft Asset Management in Italy

PeopleSoft Asset Management enables you to produce a fixed-asset book, required by Italian regulations (article 16, D.P.R. 600/73), to record information regarding depreciable fixed assets. The fixed-asset book lists information that is relevant to fixed assets, including the date of purchase, original cost, accumulated depreciation (beginning of year balance), depreciation rate, year-to-date (YTD) depreciation (current year activity), retirement and disposal information, ending balance, and any revaluation and devaluation information in a particular fiscal year for either the economic or fiscal book. Most Italian business entities use an economic book to record depreciation that is not subject to fiscal constraints and a fiscal book to record specific rules and depreciation methods that are regulated by fiscal authorities.

Using PeopleSoft Asset Management in Japan

PeopleSoft Asset Management supports commonly used practices in Japan, including depreciation methods for fixed and leased assets, composite depreciation, and collateral assets. In addition, PeopleSoft Asset Management provides reports to satisfy tax reporting requirements.

Prerequisites

Before you can perform some of the functions discussed in this topic, you must have already performed some or all of the following country-specific tasks:

Country	Task
VAT countries	<p>Set up the appropriate value-added-tax (VAT) defaults and reporting options, and associate these defaults and options with business units or VAT-driven entities.</p> <p>See “VAT Defaults Setup Page” (Asset Lifecycle Management Fundamentals).</p> <p>See “Understanding VAT” (PeopleSoft Global Options and Reports).</p>
(AUS) Australia	

Country	Task
<p>Before processing asset revaluations, ensure that these conditions have been set up for Australia:</p>	<ul style="list-style-type: none"> • Select the Create Accounting Entries check box for the accounting book that you are using on the Business Unit/Book Definition page in the Asset Management Business Unit Definition component. See “Understanding Asset Management Business and Cash Generating Units” (Asset Lifecycle Management Fundamentals). • Set up the appropriate book definition for Australia on the Assets Books page. See “Business Unit/Book Definition Page” (Asset Lifecycle Management Fundamentals). • Verify that cost type <i>R</i> (revaluation) is available on the Cost Types page and set as the Revaluation process. See “Defining Asset Attributes” (Asset Lifecycle Management Fundamentals). • Add new accounts for <i>Provision for Revaluation (Equity)</i> and <i>Reversal of Depreciation (Expense)</i>. Do this on the Accounts page in the Design ChartFields component. See “Understanding PeopleSoft ChartField Configuration” (Application Fundamentals). • Define a set of accounting entry template IDs for each SetID that is affected by revaluation, and define accounting entry templates for each category of asset that is affected by the revaluation using cost type <i>R</i> on the Accounting Entry Template page. These are necessary to generate accounting entries. See “Defining Accounting Entries” (Asset Lifecycle Management Fundamentals). • Run the detailed Net Book Value report by category (AMDP2100). This is not required, but is recommended.
(CAN) Canada	

Country	Task
<p>Set up the following conditions to calculate CCA reporting for Canada:</p>	<ul style="list-style-type: none"> • Set up or modify CCA tax classes on the Tax Class page and specify the CCA percentage rate. <p>Asset pools or classes and CCA rates are set by governmental regulations. In the year that assets are acquired, use 50 percent of the normal rate. The value that you enter for an asset tax class for the CCA rate percent is used later when you run a process to calculate the CCA rate.</p> <ul style="list-style-type: none"> • On the Asset Book Definition - Book Tax page, select the tax guideline class that reflects the CCA tax class to which the asset belongs. <p>See “(CAN, IND, and USA) Defining and Maintaining Tax Classes” (Asset Lifecycle Management Fundamentals).</p>
(FRA) France	
<p>Set up the following conditions for France:</p>	<ul style="list-style-type: none"> • Establish your statutory book in the Business Unit/Book definition component. <p>See “Understanding Asset Management Business and Cash Generating Units” (Asset Lifecycle Management Fundamentals).</p> <ul style="list-style-type: none"> • To create accounting entries that include the derogatory accounts required by France, set up an accounting entry template ID with the derogatory feature selected. • Define asset profiles as business tax applicable by selecting the Business Tax check box in the Asset Profile component. • Define asset books as business tax applicable by selecting the Business Tax check box in the Asset Book Definition component. <p>See “Understanding Tax Processing and Reporting” (Asset Lifecycle Management Fundamentals).</p>
(DEU) Germany	

Country	Task
Set up the following tables to process tax and depreciation for Germany:	<ul style="list-style-type: none"> • Establish capitalization limit codes for low-value assets. • Create a user-defined Staffel depreciation method. • Define special depreciation terms for accelerated depreciation and associate the terms at the asset or book level. <p>See “Understanding Tax Processing and Reporting” (Asset Lifecycle Management Fundamentals).</p> <p>See “Understanding Depreciation Processing” (Asset Lifecycle Management Fundamentals).</p>
(IND) India	
Set up the following tables to process tax and depreciation for India:	<ul style="list-style-type: none"> • Asset blocks <ul style="list-style-type: none"> Define assets blocks that are equivalent to the <i>tax block</i> in India. • Tax classes <ul style="list-style-type: none"> Set up or modify India tax classes on the Tax Class page and specify the asset block and the tax percentage rate. Tax class is used to define tax rates by group for processing tax and depreciation in India. The tax group is a subcategory of the tax block in India. • Tax/report entities <ul style="list-style-type: none"> Define the tax/report entity. The tax/report entity comprises one or more business units. Tax reporting is disclosed per entity for India. <p>See “Understanding Tax Processing and Reporting” (Asset Lifecycle Management Fundamentals).</p> <p>See “User Preferences - Overall Preferences Page” (Application Fundamentals).</p>
(JPN) Japan	
Set up the following tables to process tax and depreciation for Japan:	<p>Set up the overall options for user preferences (OPR_DEF_TABLE_FS1) in the Common Definitions component:</p> <p>Set the Localization Country value to <i>JPN</i> (Japan), which enables the JPN Info (Japan information) link in the Define Business Units component for Asset Management.</p> <p>See “Understanding Asset Management Business and Cash Generating Units” (Asset Lifecycle Management Fundamentals).</p>

(AUS) Using PeopleSoft Asset Management Options to Meet Australian Requirements

This topic discusses how to use PeopleSoft Asset Management Options to meet Australian requirements.

Pages Used to Meet Australian Requirements

<i>Page Name</i>	<i>Definition Name</i>	<i>Usage</i>
<u>Defining Asset R&D Categorization</u>	BU_AGG_RD	Calculate research and development tax deductions for R&D plant assets.
Asset Profile Page	PROFILE_DEFN	Define asset profiles. See <u>Defining Asset R&D Categorization</u>
<u>General Information Page</u>	ASSET_GENERAL_01	Add asset basic information manually, or add or change existing asset information. Also access the Set R&D Info page.
<u>Cost/Asset Information Page</u>	ASSET_ENTRY_00	Enter information about how this asset will be capitalized. Also access the Set R and D Info page.
<u>Defining Asset R&D Categorization</u>	ASSET_RD_SP	Enter information about R&D assets. For Australian customers, use this page for tax reporting purposes. For others, this page is informational only.
Tax Information Page	ASSET_ENTRY_02	Specify property type and tax depreciation criteria to identify which investment credits are taken for the current asset. If the fields on this page are unavailable, you are working with a book that was not set up as a tax book. See <u>Using the Australian Tax Credit Allowance</u>
RD Deductions - AUS (research and development deductions - Australia)	RUN_AMTX10AU	Run a report to view the number of R&D concessions that can be claimed.
Tax Credits - AUS	RUN_AMTX20AU	Run the Tax Credit Allowance Structured Query Report (SQR) to produce a report of total tax credits by business units.
Australia CCP Report (Australia changes in creditable purpose report)	RUN_AMTX30AU	Report the apportionment of recoverable versus nonrecoverable VAT on invoices.

Defining Asset R&D Categorization

Enable R&D calculations and define assets as R&D eligible assets from the following pages:

- Asset Unit Aggregate RD page.
- Asset Profiles - Definition page.
- Set R and D Info page.

Asset Unit Aggregate Research and Development – Australia Page

Use the Asset Unit Aggregate RD - AUS (asset unit aggregate research and development - Australia) page (BU_AGG_RD) to calculate research and development tax deductions for R&D plant assets.

Navigation:

Set Up Financials/Supply Chain > Product Related > Asset Management > Taxes > Asset Unit Aggregate RD - AUS > Asset Unit Aggregate RD - AUS

To calculate the amount of deductions that it is possible to claim, enter the aggregate R&D amount for each fiscal year. Enter the fiscal year, expenditure, and description for the business unit.

Asset Profile Page

Use the Asset Profile page (PROFILE_DEFN) to define asset profiles.

Navigation:

Set Up Financials/Supply Chain > Product Related > Asset Management > Profiles > Asset Profiles

Asset profiles that are defined with R&D options that are selected indicate that all assets that are added to your system by using this profile are used for R&D and are entitled to R&D tax concessions.

<i>Field or Control</i>	<i>Description</i>
R and D Plant Asset (research and development plant asset)	Select if this asset is used for R&D and is entitled to R&D tax concessions.
R and D Start Date (research and development start date)	Enter the date on which the asset was first used exclusively for R&D. If you leave this field blank, the in-service date from the business unit's tax book is used as the start date. The start date determines the first year in which you can claim R&D concessions.
Use NBV for R and D (use net book value for research and development)	Select if you want to base the R&D concessions calculation on the net book value of the asset (at the R&D start date) instead of the book cost. This is useful when an asset previously being depreciated as a non-R&D asset subsequently becomes eligible for R&D concessions.

Asset R&D Information Page

Use the Asset R&D Information (asset research and development information) page (ASSET_RD_SP) to enter information about R&D assets.

For Australian customers, use this page for tax reporting purposes. For others, this page is informational only.

Navigation:

Click the **Set R and D Info** link from the General Information page or from the Asset Additional Information section on the Cost/Asset Information page in ExpressAdd.

Field or Control	Description
R and D Plant (research and development plant)	Select if you want to identify the asset as specifically allocated for R&D.
R and D Start Date (research and development start date)	Enter the R&D start date for this asset.
Use NBV (use net book value)	Select if appropriate for your tax reporting purposes. Click the OK button to return to the Asset Information or Cost/Asset Information page.

Related Links

[“Understanding Asset Processing” \(Asset Lifecycle Management Fundamentals\)](#)

[“Understanding Depreciation Processing” \(Asset Lifecycle Management Fundamentals\)](#)

[“Understanding Tax Processing and Reporting” \(Asset Lifecycle Management Fundamentals\)](#)

[Understanding Adding and Maintaining Assets](#)

Using the Australian Tax Credit Allowance

Australia tax law provides certain tax credit allowances related to capital investment projects that include provisions for rebates (often referred to as credits). Unlike allowable deductions, the tax credits are not part of the calculation of taxable income.

The tax credit allowance is calculated in this way:

Tax credit cost basis = book cost x basis reduction rate (%)

Tax credit = tax credit cost basis x tax credit (%)

To use this feature:

- Set up your own credit tables or modify the existing tables on the Tax Credits page.
- Assign a status to the defined tax credits.

The status enables you to classify assets when reporting credits. Use the Tax Credit Status page to enter or modify a tax credit status.

- Enter tax credits against assets.

Use the Asset Profiles, Asset Book Definition, or Asset ExpressAdd component.

See “Defining Tax Credits” (Asset Lifecycle Management Fundamentals).

Entering Tax Credits Against an Asset

Tax credits are entered against an asset in the Asset Book Definition or Asset ExpressAdd component, or at the asset profile level by using the Asset Profile Tax Credits page. You can enter tax credits against leased assets by using the Asset Book Definition page after the asset has been entered through Leased Asset Entry.

See “Creating PeopleSoft Asset Management Business Units” (Asset Lifecycle Management Fundamentals).

See [Understanding Leased Assets](#).

Entering Tax Credits in the Asset Book Definition Component

The Tax Credit Options region on the Tax page (PROFILE_BK_03) of the Asset Profiles component provides you with the options to identify which investment credits are taken for a selected asset. You must specify the tax criteria before you can enter tax credits.

After you enter the tax credit code, PeopleSoft Asset Management retrieves the percentage figures that are specified for the tax credit and calculates the computation amount using the following formula:

$$\begin{aligned} \text{Book cost} \times \text{basis reduction percentage} &= \text{amount qualifying for the tax credit} \\ \text{Amount qualifying} \times \text{tax credit percentage} &= \text{amount of tax credit} \end{aligned}$$

The sum of all tax credits that are defined in the current book appears in the **Tax Credit** field. The total tax credit amount is updated each time that you change tax credit information.

See “Setting Up Asset Profiles” (Asset Lifecycle Management Fundamentals).

Entering Tax Credits in the Asset ExpressAdd Component

The Asset ExpressAdd component enables you to identify which investment credits are taken for a selected asset from the Tax Credit Options region on the Tax Information page (ASSET_ENTRY_02). You must specify the tax criteria before you can enter tax credits.

Access the Tax Credit Options group box on the Tax Information page.

Enter the tax credit code. You can optionally enter a tax credit status.

After you enter the tax credit code, PeopleSoft Asset Management retrieves the percentage figures that are specified for the tax credit and calculates the computation amount by using the following formula:

$$\begin{aligned} \text{Book cost} \times \text{basis reduction percentage} &= \text{amount qualifying for the tax credit} \\ \text{Amount qualifying} \times \text{tax credit percentage} &= \text{amount of tax credit} \end{aligned}$$

The sum of all tax credits that are defined in the current book appears in the **Tax Credit** field. The total tax credit amount is updated each time that you change tax credit information.

If you change the cost information on the Cost/Asset Information page of the Asset ExpressAdd component after you have entered tax credits, click the **Calculate Credit** button to recalculate the amount of the credits. This reloads the percentage figures from the Tax Credit table and then recalculates the amounts for all tax credits that are defined for the current asset.

See [Adding Assets with the Asset ExpressAdd Component](#).

Tracking Changes in CCP

Australian financial services organizations are required to track the usage of fixed assets that are used in making input tax supply. Input tax that is not creditable is capitalized in the value of the asset and depreciated accordingly. Creditable tax is eligible for refund and is not included in the value of the asset. Because a single asset can be used by a business entity in multiple activities, some of which may be taxable or GST-free and some of which may be input taxed, the full amount of GST that is paid must be recorded and apportioned creditable and noncreditable based upon usage. Over the life of an asset, this apportionment must be reviewed annually and adjusted to reflect the asset's current usage. The time period during which an asset is subject to this review is determined by the cost of the asset. Review periods are maintained in the Asset Threshold-VAT table referenced when assigning the last date of mandatory review.

Recording GST in Payables and Passing GST on to Asset Management

To track the apportionment of GST that is relevant to an asset, four fields are passed to Asset Management from Payables using the Run Load Assets process (INTFAPAM):

- **Asset ID**
- **Merchandise Amount**
- **Non Recoverable VAT**
- **Total VAT**

Payables validates the information that you entered on the invoice before passing it to Asset Management.

Note: The invoice information must be validated in PeopleSoft Payables before it is passed to PeopleSoft Asset Management. Invoice information cannot be rejected once it has reached PeopleSoft Asset Management.

This diagram illustrates the interface process:

PeopleSoft Payables to PeopleSoft Asset Management GST process

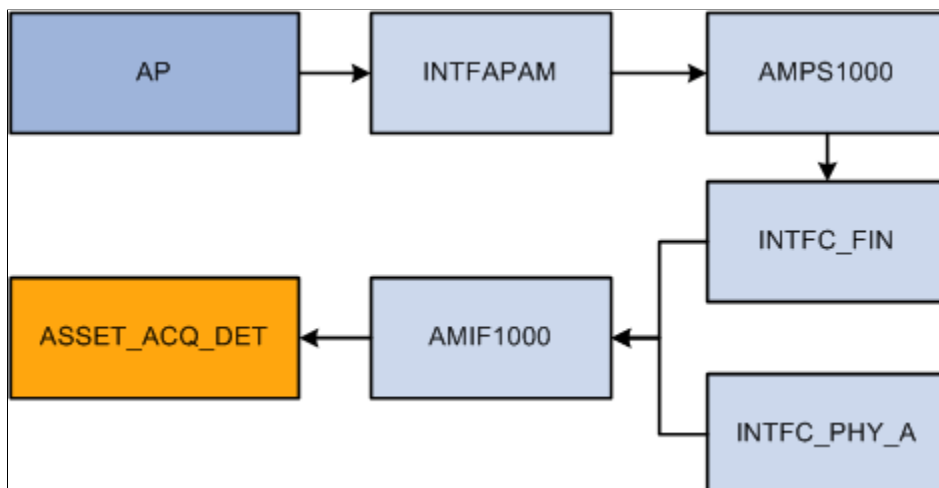

See “Understanding VAT Processing in PeopleSoft Payables” (PeopleSoft Payables).

Adding GST Online in Asset Management

You can enter GST information directly into Asset Management when entering an asset online through the Asset Basic Information component. Use the **Tax** link on the Asset Acquisition Detail page to enter tax amounts that are charged to the asset.

Changes in CCP are recorded on the same page that you use to enter an asset's GST amounts manually and to designate recoverable and nonrecoverable amounts. When changing the usage percentage of an existing asset, select the transaction type *Adjustment* rather than *Addition*; otherwise, the entry process is the same.

When working in a business unit that is identified for Australia, the **Calculate Last Date of Review** button appears on the Asset Information page. Select a schedule type code, and click the **Calculate Last Date of Review** button to generate the last date of mandatory review for the asset. The last date of mandatory review is stored on the Asset Basic Information page.

Related Links

[Adding and Maintaining Asset Information](#)

Reporting Changes in CCP

Some organizations must track fixed assets that are used in making input tax supply. You can track the change in the extent to which a fixed asset is used to make taxable supply from reporting period to reporting period, and you can make adjustments for any change. For instance, in Australia, Australian financial services organizations require a solution to record the apportionment of recoverable versus nonrecoverable VAT on invoices. This information is then sent to PeopleSoft Asset Management for capital assets.

Use the Australia CCP Report (Australia changes in creditable purpose report) page (RUN_AMTX30AU) to report the apportionment of recoverable versus nonrecoverable VAT on invoices.

Navigation:

Asset Management > Taxes > Reports > Tax CCP

Calculating CGT

CGT legislation in Australia requires payment of tax on certain capital gains that are realized at the time of an asset's sale, net of inflation, of all components of the cost basis. Tax deductions can also be realized in certain circumstances for losses. PeopleSoft Asset Management provides pages on which you designate the applicability of a gain or loss calculation for specific assets or for all of the assets in a book. When an asset on which gain or loss has been designated as applicable is retired, the system calculates the gain or loss and stores the results for later reporting. The gain or loss calculation is split into an assessable gain or loss and a capital gain or loss amount.

Specifying Capital Gain or Loss Options for an Asset

There are multiple components where you can indicate that an asset is CGT-applicable if you want the capital gain or loss calculated for an asset upon retirement:

- Asset Book Definition - Book Tax page (if the CGT calculation is applicable for assets on a book level).
- Asset Profile.
- ExpressAdd.

To be prompted to identify an asset as CGT-applicable, you must associate the book for the asset with the country (Australia) on the Asset Book Definition page.

If CGT is applicable for this asset, select the **CGT Applicable** check box on any of these pages.

Run the Australian Retirements reports to view the results of CGT-applicable assets. Use these calculations:

Capital gain or loss = asset proceeds – indexed revalued amount or original price – removal amount
Assessable gain/loss = asset proceeds or original price – net book value – removal amount

These calculations use existing indexing tables containing local consumer price indexes (CPI). A logical extension of this calculation is to determine the actual amount of tax to be paid, or in the case of a loss, the tax credit that you can later net against a future capital gain.

Related Links

[“Setting Up Asset Profiles” \(Asset Lifecycle Management Fundamentals\)](#)

[Understanding Adding and Maintaining Assets](#)

Calculation of CGT

Here are the elements that are used in the calculation of a capital gain or capital loss on the disposal of an asset:

- The cost base of the asset, which is used to determine the amount of a capital gain if the disposal of the asset occurs within 12 months of the taxpayer's acquisition of the asset.

- The indexed cost base of the asset, which is used to calculate the amount of a capital gain if the taxpayer disposes of the asset 12 months or more after the date of its acquisition.
- The reduced cost base of the asset, which is used to calculate the amount of a capital loss that arises on the disposal of the asset.

Using the Asset Retirements page, you can view the CGT that is calculated upon retirement for each asset by book.

The Retirement reports also contain CGT information.

Generating Asset Revaluation (Net Method)

In compliance with accounting standards, many companies must carry assets at fair value. As a result, frequent revaluation of assets may be necessary, depending on requirements. PeopleSoft Asset Management supports asset revaluations in accordance with Australian accounting standards, which require crediting to related asset accounts a balance of accumulated depreciation at the date on which an asset is revalued.

Steps to Generate Asset Revaluation (Net Method)

To process asset revaluations per Australian accounting standards:

1. Select the Net Method option on the Accounting Entry Template IDs page.

To prevent the generation of *Provision for Revaluation Contra* (RC) accounting lines as a result of revaluation—accounting lines which are invalid for Australian net method revaluation purposes—use the **Net Method** option on the Accounting Entry Template IDs page.

See “Accounting Entry Template IDs Page” (Asset Lifecycle Management Fundamentals)

2. (*Optional*) If necessary to your business process, you can use the Revaluation Worksheet page to revalue an asset downwards (per the Australian Accounting Standard AASB 116), so that fair market value is less than net book value.

See [Revaluation Worksheet Page](#)

3. Run Revaluation en Masse (AMAUSCAL):

- a. Select the net method as the revaluation method, define the run control parameters and click the Run button on the Process request page.

If you select the Include Current Period Depr (include current period depreciation) option, the process includes the depreciation in the revaluation accounting entries.

- b. Select the Australian Revaluation check box.

The process updates the Financial Loader table (PS_INTFC_FIN) with four rows for each asset included in the process request: one for retirement (RET) with the total cost, one for reinstatement (REI) with the total cost, one for an adjustment (ADJ) reflecting the difference between the original cost and the cost calculated with revaluation parameters, and one for book change (BKS).

See [Revaluation en Masse Page](#).

4. (*Optional*) Preview the data in the Asset Management loader table (INTFC_FIN).

See “Pages Used to Preview Data in the Loader Tables” (Asset Lifecycle Management Fundamentals)

- Run the Load Transactions into AM process (AMIF1000) to load the RET, REI, ADJ, and BKS transactions that are created by the revaluation.

Note: Unlike previous methods for generating asset revaluation, you only need to run the Load Transactions into AM process once.

See “Load into AM Page” (Asset Lifecycle Management Fundamentals)

- Use the Depreciation Calculation page (RUN_AMDPCALC) to run the Depreciation Calculation process (AM_DEPR_CALC).

See [Depreciation Calculation Page](#)

- Run the Accounting Entry Creation process (AM_AMAEDIST) to generate the appropriate accounting entries.

See [Create Accounting Entries Page](#)

- Run the Detail Net Book Value Report by Category (AMDP2110).

(CAN) Using Asset Management Options to Meet Canadian Requirements

This topic discusses how to use Asset Management options to meet Canadian requirements.

Pages Used to Meet Canadian Requirements

<i>Page Name</i>	<i>Definition Name</i>	<i>Usage</i>
Beginning of Year	CCA_UCC_BEGIN	(Optional) Change UCC beginning of year amounts or CCA amounts.
Update CCA Year End Page	AMCCAUPD_RQST	Run the CCA Year End Updates process (AMCCAUPD_RQST) to extract the components necessary for CCA calculation, and populate the CCA_YR_END_TBL. This process uses the extracted data to calculate all CCA amounts that are required by the CCA report.
CCA Year End CAN Page	RUN_AMTX10CA RUN_AM_TX11CA	Create the Revenue Canada Year End report. Also generate the CCA Year End Extract report.

CCA Year End CAN Page

Use the CCA Yr End - Canada Rpt (capital cost allowance year end - Canada report) page (RUN_AMTX10CA) to create the Revenue Canada Year End report. Also generate the CCA Year End Extract report.

Navigation:

Asset Management > Financial Reports > Accounting Entries > CCA Year End CAN

Asset Management enables you to calculate and report CCA amounts as required by Schedule 8 of Revenue Canada.

To calculate the CCA:

- Set up or modify CCA tax classes on the Tax Class page, and specify the CCA percentage rate.

Asset pools or classes and CCA rates are set by governmental regulations. In the year that assets are acquired, 50 percent of the normal rate should be used. The value that you enter for an asset tax class for the CCA rate percent is used later when you run a process to calculate the CCA rate.

- On the Asset Book Definition - Book Tax page, select the tax guideline class that reflects the CCA tax class to which the asset belongs.
- For each reporting fiscal year, associate a CCA UCC beginning year value with a CCA tax class.
- Run the CCA Year End Update process that extracts the data that is necessary for CCA calculation, populates the CCA_YR_END_TBL table, and calculates all amounts that are required by the CCA report.
- Run the CCA Year End reports.

Related Links

“(CAN, IND, and USA) Defining and Maintaining Tax Classes” (Asset Lifecycle Management Fundamentals)

Update CCA Year End Page

Use the CCA Year End Updates (capital cost allowance year end updates) page (AMCCAUPD_RQST) to run the CCA Year End Updates process (AMCCAUPD_RQST) to extract the components necessary for CCA calculation, and populate the CCA_YR_END_TBL.

This process uses the extracted data to calculate all CCA amounts that are required by the CCA report.

Navigation:

Asset Management > Taxes > Update CCA > Update CCA Year End

Enter the business unit, CCA book name, and applicable fiscal year. Select a process frequency. This process is iterative. Run it as many times as necessary to complete CCA reporting. To run the process for multiple business units, leave the **Unit** field blank.

The CCA Year End Update process populates the CCA_YEAR_END_TBL table with these values:

Business Unit	Acquisitions
Book	Adjustments
Fiscal Year	Transfers
CCA Tax Class	Net Proceeds
Currency Code	Capital Gains

The process calculates CCA amounts according to the following formula:

$$UCC = UCC \text{ beginning of year} + \text{additions} +/\text{-adjustments} - \text{retirements}$$

$$CCA = UCC - (50\% * \text{addition}) * CCA \text{ rate}$$

$$UCC \text{ end of year} = UCC - CCA$$

(FRA) Using PeopleSoft Asset Management Options to Meet French Requirements

PeopleSoft Asset Management supports asset management practices that are commonly used in France.

Pages Used to Meet French Requirements

Page Name	Definition Name	Usage
<u>Business Tax Report Page</u>	RUN_AMBT1000	Run the Business Tax report or the Business Tax by Alternate Account report.
<u>2054 2055 Reports Page</u>	EU_AM_RUNCNTRL	Obtain information on the asset, its cost and net book value, and all transactions that occurred in the specified reporting year, including depreciation and yearly depreciation.

Business Tax Report Page

Use the Business Tax Report page (RUN_AMBT1000) to run the Business Tax report or the Business Tax by Alternate Account report.

Navigation:

Asset Management > Taxes > Reports > Business Tax Report

To calculate and report a business tax that is assessed on the gross value of fixed assets:

- Define the business tax rates by country, year, and location.
- Define asset profiles as business tax applicable by selecting the **Business Tax** check box in the Asset Profile component.
- Define asset books as business tax applicable by selecting the **Business Tax** check box in the Asset Book Definition component.
- Run the Business Tax reports: Business Tax by Account or Business Tax by Alternate Account.

Related Links

“Setting Up Asset Profiles” (Asset Lifecycle Management Fundamentals)
[Maintaining Asset Book Information](#)

Depreciating Assets by Using the Derogatory Method

PeopleSoft Asset Management supports derogatory depreciation and enables you to generate appropriate accounting entries.

To use the derogatory method:

- Set up rates for use with the derogatory method by using the Depreciation Rate - User Defined page in the Establishing Asset Processing component.
- Define appropriate reporting books for France.

In the statutory book, select *France Derogatory Balance* as the depreciation method.

Creating Accounting Entries for Derogatory Depreciation

By setting up the appropriate accounting entry information using an accounting entry template, you can generate accounting entries and see the difference between depreciation that is reflected in the economic book and the statutory book.

To set up appropriate accounting entries:

- Define the economic and statutory books at the business unit level.

Select the **Derogatory Depreciation** check box on the Business Unit/Book Definition page for the statutory book.

- Add assets.

Identification of derogatory depreciation processing is defined at the business unit or book level.

- Select the **Derogatory Accounting entries** check box when setting the accounting entry template ID *Derogatory* to define the accounting treatment for derogatory depreciation.
- Run the Depreciation Calculation process (AM_DEPR_CALC) for both books.
- Run the Accounting Entry Creation process (AM_AMAEDIST).
- Review depreciation entries on the Asset Depreciation - Period Depreciation page.
- Review accounting entries for each book in the Asset Accounting Entries component.

The pages in this component provide the accounting date, transaction type, account, and amount of each entry.

- Run the French Net Book Value by Account report (AMFR2120) on the Report - Asset Net Book Value page.
- After you specify parameters for the report and click the **Run** button, select the **French Net Book Value by Account** check box from the process list that appears.
- Run the French Net Book Value by Alternate Account report (AMFR2121) on the Report - Alt Acct Activity Detail page.
- After you specify parameters for the report and click the **Run** button, select the **French Net Book Value by Alternate Account** check box from the process list that appears.

Related Links

“AM Business Unit Definition Page” (Asset Lifecycle Management Fundamentals)

“Defining Accounting Entries” (Asset Lifecycle Management Fundamentals)

Revaluing Assets

PeopleSoft Asset Management enables you to revalue assets as a whole by using an Application Engine process. You can also revalue one or more assets at one time using the Revaluation Worksheet page. The system enables you to track and report on the revalued amount separately.

Distribution types to support accounting entries for asset revaluation are available. When setting up accounting entry templates, you can use the *Derogatory* accounting entry template ID and select *Asset Adjustments and Transfers*. In the **Accounting Entries** column, Asset Management provides two entries: *Provision for Revaluation* and *Reversal of Depreciation*.

Related Links

“Defining Accounting Entries” (Asset Lifecycle Management Fundamentals)

[Revaluing Assets En Masse](#)

2054 2055 Reports Page

Use the 2054 2055 Reports page (EU_AM_RUNCNTRL) to obtain information on the asset, its cost and net book value, and all transactions that occurred in the specified reporting year, including depreciation and yearly depreciation.

Navigation:

Asset Management > Taxes > Reports > Statutory Report 2054/2055

French statutory reports EU_2054 and EU_2055 are attachments to the annual balance sheet and provide information about the history and activity of assets during the specified fiscal year. Asset categories on both reports are based on the French statutory chart of accounts. The system provides a reporting option to generate both of these statutory reports for France.

(DEU) Using PeopleSoft Asset Management Options to Meet German Requirements

This topic provides an overview of commonly used German depreciation methods.

Pages Used to Meet German Requirements

<i>Page Name</i>	<i>Definition Name</i>	<i>Usage</i>
<u>User-Defined Methods – Definition Page</u>	UD_METHOD_DEFN	Create a user-defined Staffel depreciation method.
<u>Auto-Retire Fully Depr Assets Page</u>	RUN_AMRETFDA	Identify run control parameters to automatically retire fully depreciated assets.
<u>Capitalization Limits Page</u>	DEPR_CAP_LIMIT	Specify asset value minimums and associate warning or error actions with assets whose values fall below those limits.
<u>Terms Definition Page</u>	DEPR_TERMS_DEFN	Define special depreciation terms for accelerated depreciation and associate the terms at the asset or book level.
Load History Report Table	LOAD_AM_HIST_TBL	<p>Run one of two SQR processes that load asset data into tables where it can be used for reports.</p> <p>The AMLDDPHI.SQR process loads depreciation history data into a table where it can be used to run the Depreciation History reports.</p> <p>The AMASHIST.SQR process loads asset history data into a table where it can be used by Asset History reports.</p> <p>Before running this process, you must run a process to load the depreciation report table.</p>
Asset History Reports	RUN_AMDE1000	Run the Asset History Sheet reports that are attached to annual balance sheets and provide information about the history of an asset and its transactions.
Reconciliation AP/AM (reconciliation accounts payable/asset management)	RUN_AMDE5000	Run a report to help you reconcile accounts payable asset vouchers with Asset Management asset transaction information.

Staffel Depreciation Method

The Staffel depreciation method is used for depreciating buildings in Germany and other countries. The Staffel depreciation method can be characterized as a "step straight line." For example, for a building with an acquisition cost of \$100,000 and a life of 25 years, the depreciation calculation is 10 percent (\$10,000) per year for years one through four, 5 percent (\$5,000) per year for years five through seven, and 2.5 percent (\$2,500) per year for years eight through twenty-five. These percentages vary due to legislation and the acquisition date of the building.

Three Staffel Depreciation Methods

There are three common Staffel depreciation methods.

The first Staffel method is for domestic buildings that are used by an organization for non-habitational purposes (for example, production buildings within Germany) and where the request to build was submitted to the local construction authorities after March 31, 1985, but before February 28, 1989:

Year	Percentage
Years 1–4	10% each year
Years 5–7	5% each year
Years 8–25	2.5% each year

Non-habitational buildings that do not fulfill the preceding criteria are depreciated according to this criteria:

Year	Percentage
Years 1–8	5% each year
Years 9–14	2.5% each year
Years 15–50	1.25% each year

Exceptions (all buildings that are used for habitational use and where the request to build was submitted to local construction authorities after February 28, 1989) are depreciated according to this criteria:

Year	Percentage
Years 1–4	7% each year
Years 5–10	5% each year

Year	Percentage
Years 11–16	2% each year
Years 17–40	1.25% each year

Depreciation periods in Germany are based on calendar years (January 1 – December 31). Because not all buildings are completed or purchased on January 1, if you activate an asset in a different month, you must prorate the depreciation for the first year, *including* the month of asset addition. For example, the depreciation amount for the first year is 36,000 EU if activated on January 1. But if the asset was activated on August 12, the depreciation amount for the first year is 15,000 EU, reflecting the months August through December.

Also, you must prorate the depreciation in the year of asset retirement (or sale) *excluding* the month in which it is retired. For example, the depreciation for the last year is 60,000 EU if the asset is retired at the end of the year. But if the asset was retired or sold on August 12, then the depreciation amount must be adjusted to 35,000 EU, reflecting the months January through July.

Creating a User-Defined Staffel Depreciation Method

To calculate depreciation by using the Staffel method, you can create a user-defined depreciation method for this formula. For example, in this case:

- The asset basis of the building is \$100,000 (EU).
- The asset life is 25 years (300 periods).
- The depreciation convention is AM (actual month).
- The user-defined depreciation method name is Staffel.

To create a Staffel user-defined depreciation method, use the User-Defined Method page. Enter a description for the method ID.

You must define the following four variables to create a Staffel user-defined depreciation method:

Result A = ALLOC_LIFE – Total Periods Depr

This calculation results in the number of remaining periods in weeks:

Result D = Result A / 52

This is the number of remaining periods in years.

Result C = No Periods to Depr / Alloc Total

This provides the number of periods for the year to be depreciated / total periods for the year, for example, 6 / 12 for the first year.

Result B = Asset basis x Percentage

This result is:

Asset basis – Salvage value x Appropriate Staffel Percentage

Finally, to calculate the depreciation proration for the first year and the year of retirement, specify the following in the formula:

Depreciation=Result B x Result C

Related Links

[Understanding User-Defined Depreciation](#)

Using a Half-Year Prorate Convention

PeopleSoft Asset Management supports the German half-year convention. The German half-year convention differs from the U.S. half-year convention in that an asset takes a full year's depreciation if it was acquired in the first half of the year. This convention is delivered in the tables shipped, but you can modify it as necessary to suit a specific requirement.

Related Links

“Setting Up Depreciation Conventions” (Asset Lifecycle Management Fundamentals)

Using Geometric Digressive Depreciation

Geometric digressive depreciation calculates depreciation up to three times the annual straight-line depreciation with a maximum of 30 percent of the asset cost per year. Asset Management supports this depreciation method by providing the declining balance with a *Switch to Straight Line* depreciation method option. To depreciate assets by using this method, select *DB w/SL By Limit%* on the Book-Tax page in the Asset Book Definition component, the Depreciation page in the Asset Profiles component, or the Depreciation Information page in the Asset ExpressAdd component. Specify *300* as the declining balance percent and *30* as the limit percent.

Related Links

[Declining Balance with Depreciation Limit](#)

Capitalization Limits Page

Use the Capitalization Limits page (DEPR_CAP_LIMIT) to specify asset value minimums and associate warning or error actions with assets whose values fall below those limits.

Navigation:

Set Up Financials/Supply Chain > Product Related > Asset Management > Financials > AM Capitalization Limits

PeopleSoft Asset Management supports low-value asset processing by providing a capitalization limit table where you can specify asset value minimums and associate warning or error actions with assets whose values fall below those limits. Additionally, you can set the limit at which an asset is marked as a low-value asset.

This example illustrates the fields and controls on the Capitalization Limits page. You can find definitions for the fields and controls later on this page.

Capitalization Limits

SetID SHARE

Cost Limit Code GERMANY *Currency Code EUR euro

Description Germany Depreciation Limits

Limits
Personalize | Find | |
First 1-2 of 2 Last

	Amount	Low Value Switch	Message Severity		
1	100.00	<input type="checkbox"/>	Error ▼	+	-
2	800.00	<input checked="" type="checkbox"/>	Warning ▼	+	-

After you have set up the necessary capitalization limits, select **Table Lim** (table limit) and the correct code as the capitalization limit method on the Business Unit/Book Definition page in the Establish Business Units - Asset Management Definition component.

When you add assets to that business unit and book combination, Asset Management checks the capitalization limits against the amounts that are stored by code in the capitalization limit table.

In Germany, assets marked as low value should be depreciated in one year.

PeopleSoft Asset Management provides the *PROG WG* asset profile that is defined with depreciation attributes that are appropriate for German low-value asset processing. These include depreciation using the straight-line method and a useful life of 12 periods. Also, Asset Management provides the German First Day Last Period depreciation convention that you can use to generate one accounting entry for the annual depreciation for a low-value asset.

Low-value assets can be retired in mass using the Auto-Retire feature to satisfy the requirement that low-value assets be fully depreciated and retired after the first year of service.

Related Links

- [“Creating PeopleSoft Asset Management Business Units” \(Asset Lifecycle Management Fundamentals\) Capitalization Limits Page](#)
- [“Setting Up Depreciation Conventions” \(Asset Lifecycle Management Fundamentals\)](#)
- [“Setting Up Asset Profiles” \(Asset Lifecycle Management Fundamentals\)](#)

Terms Definition Page

Use the Terms Definition page (DEPR_TERMS_DEFN) to define special depreciation terms for accelerated depreciation and associate the terms at the asset or book level.

Navigation:

Set Up Financials/Supply Chain > Product Related > Asset Management > Depreciation > Asset Depr Terms Definition

PeopleSoft Asset Management supports special depreciation methods that are used in Germany, such as accelerated depreciation, by enabling you to define special terms and associate them at the asset and book level.

This example illustrates the fields and controls on the Terms Definition page. You can find definitions for the fields and controls later on this page.

Terms Definition

SetID SHARE

Depreciation Special Terms SONDER_AFA

Depreciation Terms Find | View All First ◀ 1 of 1 ▶ Last

'Effective Date' + -

'Description'

Special Terms		Personalize Find	First ◀ 1-4 of 4 ▶ Last
	'Year of Life	Depreciation Percent (%)	
1	<input type="text" value="1"/>	<input type="text" value="5.000000"/>	+ -
2	<input type="text" value="2"/>	<input type="text" value="5.000000"/>	+ -
3	<input type="text" value="3"/>	<input type="text" value="5.000000"/>	+ -
4	<input type="text" value="4"/>	<input type="text" value="5.000000"/>	+ -

After you have defined special terms, associate them with an asset or book by selecting the **Special Depreciation** check box on the Depreciation Information page in the Asset ExpressAdd component.

Related Links

[“Understanding Asset Processing” \(Asset Lifecycle Management Fundamentals\)](#)

[“Understanding Depreciation Processing” \(Asset Lifecycle Management Fundamentals\)](#)

[Adding and Maintaining Asset Information](#)

(IND) Using PeopleSoft Asset Management Options to Meet Indian Requirements

PeopleSoft Asset Management addresses issues related to fixed-asset accounting in India. This topic provides an overview of asset depreciation processing for India and discusses how to process tax depreciation.

Pages Used to Meet Indian Requirements

Page Name	Definition Name	Usage
Calculate Balances IND Page	AM_DEPR_TAX	Calculate tax depreciation balances for India. See Processing India Tax Depreciation
Tax Depr Bal (tax depreciation balances) Page	TAX_DEPR_BAL	Displays tax depreciation balance for India that you can update. See Processing India Tax Depreciation
Assets Register - IND Page	RUN_AMDP2510	Reports historical depreciation for the fiscal year. See Processing India Tax Depreciation
Depreciation Balance - IND Page	TAX_DEPR_RQST	Generate tax depreciation balance report for the tax period. See Processing India Tax Depreciation

Understanding Asset Depreciation Processing for India

PeopleSoft Asset Management provides asset processing features that correspond to the tax reporting requirements established by Indian tax legislation. Indian tax law does not recognize depreciation on individual assets. Instead, it groups similar pools of assets under a prescribed *tax block*. There are only four tax blocks of assets provided for under the tax act: buildings, furniture and fixtures, machinery and plant, and intangibles. Further, each tax block of assets comprises *tax groups*, and each tax group has its own individual tax rate. The Indian tax *year* is fixed on a fiscal year calendar that runs from April 1 through March 31. Annual tax depreciation is reported to the tax authority per tax block per fiscal year .

To meet these requirements, PeopleSoft Asset Management allows for the grouping of assets by *asset blocks* for accumulating and reporting depreciation and taxes. Each asset block can have as many depreciation rates associated with it as necessary to delineate Indian tax groups. To meet reporting requirements, a *tax entity* is defined, associated with a specific book, and has as many business units and asset books associated with it as necessary.

The Straight Line Percent method of depreciation in PeopleSoft Asset Management uses the asset useful life to calculate the depreciation rate. India calculates useful life based on the depreciation rate guidelines published by the governmental finance authority. The rates established depreciate 95 percent of the cost over the useful life of the asset, at minimum: accelerated depreciation is allowed. India calculates depreciation based on the rates rather than useful life. In addition, these rates also consider the residual or salvage value at the end of the asset useful life. To determine useful life of an asset in India, the straight line percent method multiplies the depreciation rate by cost and this results in the useful life. Further, there are two different ways to calculate depreciation adjustments under the Indian Straight Line Percent method: *remaining value* and *life-to-date*. All transactions use an actual day (AD) convention for calculating depreciation. Assets are depreciated when they are placed in service. Processing for leased assets is included.

During the end-of-year processing of depreciation and taxes for India, assets are grouped into blocks based on the tax entity and asset profile definition in place for the asset. The opening written down value (WDV) is retrieved from the prior year WDV for the corresponding tax entity, asset block, and rate.

Asset Management provides these reporting processes to manage Indian tax and depreciation requirements:

- Produce the Asset Register - India: Reports an historical record of assets over the fiscal year period.
- Produce the Depreciation Balance - IND report: Displays the calculated opening WDV balance and reports depreciation during the year.
- Calculate and Update Depreciation Balance - IND processes: Calculates depreciation balances for India and provides an online update of balances (depending on your setup options).

The system provides functionality to process operating and capital leases when manually specified.

Processing India Tax Depreciation

When you accumulate assets subject to India's depreciation and tax guidelines, you must first assign an asset block, a guideline (tax) class, and a tax entity to each asset. Also, you should set up each asset to depreciate when in service. These attributes are defined in the Book Definition component and the Book - Depreciation (ASSET_BOOK_01) and Book - Tax (ASSET_BOOK_02) pages. When depreciation and tax processing commences, the system retrieves these designated assets for processing.

See [Adding and Maintaining Asset Information](#).

To process and report on depreciation and tax for India:

1. To process depreciation for India, request the depreciation calculation process (AM_DEPR_CALC).
See [Processing Depreciation](#).
2. To calculate depreciation balances for India for the tax period, request the process to calculate balances for India (AMTX2000).
3. To update depreciation balances for India for the tax period, request the process to update balances for India (TAX_DEPR_BAL).
4. To review the asset register for India, request the assets register for India (AMDP2510).

Calculating Tax Depreciation Balances for India

Use the Calculate Balances IND page (AM_DEPR_TAX) to calculate tax depreciation balances for India.

Navigation:

Asset Management > Taxes > Depreciation > Calculate Balances IND > Calculate Balances IND

This example illustrates the fields and controls on the Calculate Balances IND page. You can find definitions for the fields and controls later on this page.

Calculate Balances IND

Run Control ID 1 Report Manager Process Monitor Run

Tax/Reporting Entity

'Request ID

'Tax/Reporting Entity

'Entity Book

'Fiscal Year

Process Frequency

Process Once

Always Process

Don't Run

Field or Control	Description
Tax/Reporting Entity	Select the tax and reporting entity for this process. The available tax entities are defined by the asset blocks, tax class tax rates, setID calendar, and business unit/books that are associated with it.
Entity Book	Select the entity book for this process. The entity book defines how to group the tax or reporting information.

See “(IND) Defining Tax Entities and Tax Options” (Asset Lifecycle Management Fundamentals).

Updating Depreciation Balances for India

Use the Tax Depr Bal (tax depreciation balances) page (TAX_DEPR_BAL) to displays tax depreciation balance for India that you can update.

Navigation:

Asset Management > Taxes > Depreciation > Update Tax Depr Balances IND

This example illustrates the fields and controls on the Tax Depr Bal page (1 of 2). You can find definitions for the fields and controls later on this page.

Update Balances IND

Tax/Rpt Entity INDIA Entity Book TAX Asset Block BUILDING Fiscal Year 2012

Tax Depreciation Balance Personalize | Find | First 1-4 of 4 Last

Calculated Values	Depreciation and WDV					
Guide Cls	Opening Balance	Add/Adj (50% Rule)	Add/Adj (Regular)	Net Proceeds		
BU10%	0.00	0.00	0.00	10,000.00	+	-
BU100%	0.00	0.00	0.00	0.00	+	-
BU5%	0.00	3,000.00	3,000.00	0.00	+	-

This example illustrates the fields and controls on the Tax Depr Bal page (2 of 2). You can find definitions for the fields and controls later on this page.

Update Balances IND						
Tax Rpt Entity INDIA		Entity Book TAX		Asset Block BUILDING		Fiscal Year 2012
Tax Depreciation Balance						
Personalize Find First 1-4 of 4 Last						
Calculated Values Depreciation and WDV						
Guide Cls	Manual Adjustment	Depreciation Amount	Depreciation Amt - 50%	Rate%	Closing Balance	Currency
BU10	0.00	-1000.00	0.00		-9000.00	INR
BU10	0.00	0.00	0.00		0.00	INR
BU5%	0.00	150.00	75.00		5775.00	INR

If your setup options have enabled manual adjustments to depreciation balances, you can access calculated balances and enter adjustments in the **Manual Adjustment** column. No recalculations are processed on the basis of any manual adjustment entered, but the values are added to the WDV.

Assets Register - IND Page

Use the Assets Register - IND page (RUN_AMDP2510) to reports historical depreciation for the fiscal year.

Navigation:

Asset Management > Financial Reports > Cost and Depreciation > Asset Register India

This example illustrates the fields and controls on the Assets Register - IND page. You can find definitions for the fields and controls later on this page.

Assets Register - IND	
Run Control ID VP1	Report Manager
Language English	Process Monitor
Run	
Selection Request Parameters	
Report By	Report Entity
Report Entity	INDIA
Entity Book	TAX
Fiscal Year	
As Of Fiscal Year	2012
Type of Report	
<input checked="" type="radio"/> Detail <input type="radio"/> Summary	

Field or Control	Description
Selection Request Parameters	Define the parameters for the asset register to report by business unit or report entity. Complete these fields as dictated by your needs: <ul style="list-style-type: none"> • Unit. • Book. • Report Entity. • Entity Book. • As of Fiscal Year. • Detail or Summary (available only when you select to report by report entity).

Depreciation Balance - IND Page

Use the Depreciation Balance - IND page (TAX_DEPR_RQST) to generate tax depreciation balance report for the tax period.

Navigation:

Asset Management > Taxes > Reports > Depreciation Balance Rpt IND

When calculating the annual tax depreciation balances, the following rules apply:

- Tax depreciation is calculated for each tax group per the tax group tax rate.
- Opening balance (WDV) is required for each tax group each year.

The opening balance in the conversion year is entered; in subsequent years, the opening balance is processed by Asset Management and is equal to the ending balance of the previous year.

- Additions and adjustments for the fiscal year are lumped together.

However, these are subgrouped separately to include assets that have been in use for more than 180 days and those that have been in use for less than 180 days. For assets in use for less than 180 days, only 50 percent of the normal depreciation rate is allowed (per Section 32).

To determine the assets that fall in the category of Additions/Adjustments more than 180 days, the system calculates the difference between the fiscal year end date (March 31) and the in-service date for *ADD* and *ADJ* transaction types. For additions less than 180 days, the system calculates the difference between the year end (March 31) and the in-service date for *ADD* and *ADJ* transaction types. If the in-service date is in the current year but the acquisition date is in prior years, the asset is depreciated at the regular rate rather than at 50 percent of the prescribed rate.

- Proceeds for the assets sold during the year are calculated.
- Use the formula for calculating WDV depreciation, where:

- A = Opening WDV/Balance.
- B = Proceeds from sale of an asset.
- C = Additions/Adjustments > 180 days.
- D = Additions/Adjustments < 180 days.
- E = Rate of Depreciation, Depr Value.

$$(A-B+C) \times E + (D \times E / 2) = \text{Depreciation Value } (F)$$

$$\text{Closing WDV} = A - B + C + D - F$$

In case the entire tax block of assets ceases to exist (for example, all of the assets are sold or transferred), the net income is taxed as short term capital gain. In this case, the opening WDV of all the tax groups in this block becomes zero for the subsequent year.

Related Links

“Understanding Asset Processing” (Asset Lifecycle Management Fundamentals)

“Understanding Tax Processing and Reporting” (Asset Lifecycle Management Fundamentals)

[Adding and Maintaining Asset Information](#)

(ITA) Using PeopleSoft Asset Management Options to Meet Italian Requirements

This topic discusses how to generate the fixed-asset register for Italy.

Page Used to Meet Italian Requirements

<i>Page Name</i>	<i>Definition Name</i>	<i>Usage</i>
Fixed Asset Register Page for Italy	RUN_AMDP2500	Specify report request parameters to generate the Assets Register - ITA report.

Fixed Asset Register Page for Italy

Use the Fixed Asset Register page (RUN_AMDP2500) to specify report request parameters to generate the Assets Register - ITA report.

Navigation:

Asset Management > Financial Reports > Cost and Depreciation > Asset Register Italy

This example illustrates the fields and controls on the Assets Register - ITA page. You can find definitions for the fields and controls later on this page.

The screenshot shows the 'Assets Register - ITA' page with the following elements:

- Run Control ID: amdpcalci
- Report Manager
- Process Monitor
- Run button
- Language: English
- Report Request Parameters section:
 - Unit: ITLE1
 - Book: ASSETS_ITL
 - From Asset ID: 000000000001
 - To Asset ID: 000000000001
- Fiscal Year Period section:
 - As Of Fiscal Year: 2012
 - Period: 2
- OR
- Date section:
 - As of Date: 09/30/2012
- Anticipated Depreciation section:
 - None (selected)
 - Special Depr
 - Accelerated Depr
 - Initial Depr
- Category
- Operating Unit
- Fund Code
- Department
- Program Code
- Class Field
- Budget Reference
- Product
- PC Business Unit
- Project
- Activity
- Source Type
- Category
- Subcategory

Define the parameters to generate the register.

(JPN) Using PeopleSoft Asset Management Options to Meet Japanese Requirements

This topic discusses how to use PeopleSoft Asset Management options to meet Japanese requirements.

Pages Used to Meet Japanese Requirements

Page Name	Definition Name	Usage
Advanced Depreciation Page	RUN_AMAD1000	Specify report request parameters to generate the advanced Depreciation Amount or Advanced Depreciation Reversal Schedule report. See Using Advanced Depreciation

Page Name	Definition Name	Usage
Owner Information Page	OWNER_INFO_DEFN	Enter owner information that is printed on the Depreciable Asset Tax Return (Tax Roll) report. See Processing Local Tax Reports
Depreciation Rate-User Defined Page	UD_DEPR_RATE_TBL	Set up useful life and depreciation rate tables. See Using Japanese Depreciation Methods
Life and Rate Information Page	MR_AM_LIFERATE	Set up useful life and depreciation rate tables. See Using Japanese Depreciation Methods
Extended Depreciation Worksheet Page	AM_EXTENDED_DEPR	Search for candidate assets according to desired parameters. Select to extend or not extend the depreciation period, remove from the list and enter the dates to resume depreciation.
Return Information Page	RETURN_INFO_DEFN1	Enter information that is required for the Depreciable Asset Tax Return (Tax Roll) report. See Processing Local Tax Reports
Local Tax Return Page	LTAX_ADD_INFO_SEC	Enter local tax information when you acquire depreciable fixed assets. See Processing Local Tax Reports
NBV - Assessment Calculation Page	AMLTPROC_RQST	Run an SQR process to load asset data and calculate the theoretical net book value and assessment value for each asset. (Theoretical NBV is not needed since 2009, but still available for historical reporting). See Processing Local Tax Reports
Local Tax Information - Adjustment	LTAX_ADJ_01	Change the theoretical net book value and assessment value. (Theoretical NBV is not needed since 2009, but still available for historical reporting).

Page Name	Definition Name	Usage
Local Tax Report Page	RUN_LTAXPROCESS	Run local tax reports for Japan. See Processing Local Tax Reports
Local Tax Information	LTAX_COST_01	Change the local tax office where the return is filed and the asset return type.
Extended Depreciation Report	RUN_AMED1000	Run the Extended Depreciation report to analyze the Tangible/Straight Line and Tangible/Declining Balance asset depreciation in compliance with Japanese tax law, as reformed.
National Tax	RUN_AMNT1000	Run a report of the depreciation calculation details to be reported to the Japanese Tax Office. The report includes all required information for the National Depreciable Asset Tax Return Beppyo 16 (1), (2) in Japan.

Prerequisites

Many of the features for processing assets for Japan are dependent on the business unit information definitions established at the business unit level. You must establish these business unit definitions in order to complete processing for Japanese requirements.

Access the Business Unit Info for Japan page from the AM Business Unit Definition component (**Set Up Financials/Supply Chain > Business Unit Related > Assets > Asset Management Definition > AM Business Unit Definition**) > Click the **JPN Info** link.

Note: To enable the JPN Info link, you must set up the overall options for user preferences in the Common Definitions component: Set the Localization Country value to JPN (Japan). **Set Up Financials/Supply Chain > Common Definitions > User Preferences > Define User Preferences > Overall Preferences.**

Field or Control	Description
Corporate Book for Japan	Select the corporate book for Japan.
Tax Book for Japan	Select the tax book for Japan.

Field or Control	Description
Memorandum Amount and Currency	Enter the memorandum amount at the end of the useful life of the asset as required by the Japanese tax regulation. This value can be updated, as the law requires. This value is used in conjunction with the following depreciation methods: J6 - Tangible Declining Balance, J7 - Tangible Straight Line, and Japan Extended Straight Line. The memorandum amount reflects the currency of the tax book for Japan as the default. For books that use one of the aforementioned depreciation methods in a currency other than JPY, the memorandum amount is translated to the respective book's currency. The memorandum value is established for each asset business unit.
Advanced Depreciation	Select if advanced depreciation is used.
Japan Composite	Select if composite assets are used.
Use JPN Local Tax (use Japan local tax)	Select if local tax reporting is enabled.

See “Business Unit info for Japan Page” (Asset Lifecycle Management Fundamentals).

The following steps are recommended when implementing Japanese tax reform changes:

1. Establish the memorandum amount on the Business Unit Info for Japan page.
2. Verify that the proper and most current depreciation rates, guaranteed rates, and revised rates are represented on the Life and Rate information secondary page [MR_AM_LIFERATE].
3. Select the appropriate depreciation methods at the asset profile level or override them at the asset level.
4. Use the Extended Depreciation Worksheet to select the eligible assets for extended depreciation. As an alternative to the Extended Depreciation Worksheet, you can extend depreciation manually, asset by asset, from the Define Tax/Depr Book page.
5. Run the Transaction Loader process prior to calculating depreciation and closing. However, this step is not necessary if you have manually extended depreciation from the Define Tax/Depr Book page.

Using Japanese Depreciation Methods

PeopleSoft Asset Management supports depreciation methods that are used in Japan for both fixed assets and leased assets.

Fixed Assets

This table shows depreciation methods, the calculations used by the methods, and the types of assets to which these methods are applied:

Asset Depreciation Method	Asset Depreciation Method Translate Value	Depreciation Calculation
<p>Changes 200/250 Declining Balance to Straight Line (Changes 200/250 DB to SL)</p>	<p>J9</p>	<p>This depreciation method is used to convert the calculation method of assets using declining balance depreciations 200 (J8) and 250 (J6) to a straight line method.</p> <p>The calculation for this method is:</p> <p>(Beginning net book value at method change) * straight line depreciation rate (based on useful life, in years)</p> <p>This method adapts the depreciation rate based on useful life (years). This method is determined by regulations instead of the rate based on useful life for salvage year.</p>
<p>Changes Declining Balance to Straight Line 200 (Changes DB to SL 200)</p>	<p>J8</p>	<p>For assets placed in service on or after April 1, 2012 the calculation is:</p> <p>If (beginning net book value * declining balance depreciation rate of 200 percent) < (beginning net book value * guaranteed rate per Japanese law) then, switch to straight line method using the revised rate.</p> <hr/> <p>Note: Guarantee rates and revised rates are derived from the Life and Rate Information page for the Tangible/Declining Balance depreciation method. The final year's depreciation is the annual depreciation amount less the memorandum value (no salvage value).</p> <hr/> <p>“Understanding Depreciation Processing” (Asset Lifecycle Management Fundamentals)</p> <p><u>Using Japanese Depreciation Methods</u></p> <p>“Defining Depreciation Terms and Rates” (Asset Lifecycle Management Fundamentals)</p>

Asset Depreciation Method	Asset Depreciation Method Translate Value	Depreciation Calculation
Changes Declining Balance to Straight Line 250 (Changes DB to SL 250)	J6	<p>For assets placed in service on or after April 1, 2007 and prior to April 1, 2012:</p> <p>If (beginning net book value * declining balance depreciation rate of 250 percent) < (beginning net book value * guaranteed rate per Japanese law) then, switch to straight line method using the revised rate.</p> <hr/> <p>Note: Guarantee rates and revised rates are derived from the Life and Rate Information page for the Tangible/Declining Balance depreciation method. The final year's depreciation is the annual depreciation amount less the memorandum value (no salvage value).</p> <hr/> <p>See</p> <p>“Understanding Depreciation Processing” (Asset Lifecycle Management Fundamentals)</p> <p><u>Using Japanese Depreciation Methods</u></p> <p>“Defining Depreciation Terms and Rates” (Asset Lifecycle Management Fundamentals)</p>
Extended Straight Line (Extended/Strt Line)	JE	<p>This depreciation method is used for fully depreciated assets under Tangible/Straight Line and Tangible/Declining Balance methods that are subject to an extended depreciation useful life of five years using a Straight Line depreciation method starting from the first period of the following fiscal year. The basis for this extended depreciation is the original 5 percent salvage value. There is no salvage value for the new round of depreciation but the memorandum value is taken from the business unit definition.</p>
Lease Depreciation	J4	<p>Declining balance depreciation calculation result * 10/9.</p>

Asset Depreciation Method	Asset Depreciation Method Translate Value	Depreciation Calculation
Intangible/Straight Line (Intangible/Strt Line)	J3	Acquisition cost * straight line depreciation rate based on useful life (years)
Tangible/Declining Balance (Tangible/Declining Bal)	J1	For assets placed in service prior to April 1, 2007: Beginning net book value * declining balance depreciation rate based on useful life (years)
Tangible/Straight Line (Tangible/Strt Line)	J2	For assets placed in service prior to April 1, 2007 the calculation used is: (Acquisition cost – 10% of acquisition cost) * straight line depreciation rate based on useful life (years).
Changes Declining Balance to Straight Line (Changes DB to SL)	J5	This depreciation method is used to convert the calculation method of assets using declining balance depreciation (J1) to a straight line method. This depreciation method adapts the depreciation rate based on useful life (years), and is determined by regulations instead of the rate based on useful life for salvage year. The calculation for this method is: (Beginning net book value at method change – 10% of acquisition cost) * straight line depreciation rate (based on useful life, in years)

Asset Depreciation Method	Asset Depreciation Method Translate Value	Depreciation Calculation
Tangible/Straight Line Revenue (Tangible/Strt Line Rev)	J7	<p>For assets placed in service on or after April 1, 2007 the calculation used is:</p> <p>Cost basis * straight line rate effective on or after April 1, 2007.</p> <hr/> <p>Note: The straight line rates are derived from the Life and Rate Information page for the Tangible/Straight Line Revenue (J7) depreciation method. The final year's depreciation is the annual depreciation amount less the memorandum value (no salvage value). See "Understanding Depreciation Processing" (Asset Lifecycle Management Fundamentals) <u>Using Japanese Depreciation Methods</u> "Defining Depreciation Terms and Rates" (Asset Lifecycle Management Fundamentals)</p> <hr/>

See [Maintaining Asset Book Information](#)

Depreciation Rate - User Defined – Life and Rate Information Page

PeopleSoft Asset Management supports useful life in years as specified for Japan. This is applied from the Rate-User Defined table (UD_DEPR_RATE_TBL, MR_AM_LIFERATE) in the Depreciation Rate-User Defined component. To apply the appropriate depreciation rates, use the delivered depreciation methods for Japan or add new ones as needed.

Use the Depreciation Rate-User Defined page (UD_DEPR_RATE_TBL) to set up useful life and depreciation rate tables.

Navigation:

Set Up Financials/Supply Chain > Product Related > Asset Management > Depreciation > User-Defined Depreciation Rate

Select a setID and a depreciation method code matching the depreciation method to be used. Enter the effective date, and click the **Life and Rate Information** button. The Life and Rate Information page displays.

This example illustrates the fields and controls on the Life and Rate Information page. You can find definitions for the fields and controls later on this page.

SetID SHARE
Method J7
Effective Date 03/31/2007

Useful Life/Rates
Personalize | Find | | First 1-99 of 99 Last

	Useful Life	Rate	Guarantee Rate	Revised Rate		
1	2	0.50000			+	-
2	3	0.33400			+	-
3	4	0.25000			+	-
4	5	0.20000			+	-
5	6	0.16700			+	-
6	7	0.14300			+	-
7	8	0.12500			+	-
8	9	0.11200			+	-
9	10	0.10000			+	-
10	11	0.09100			+	-
11	12	0.08400			+	-
12	13	0.07700			+	-
13	14	0.07200			+	-
14	15	0.06700			+	-
15	16	0.06300			+	-

Enter the useful life and corresponding rates as determined by regulations issued from the Ministry of Finance. The **Guarantee Rate** and **Revised Rate** fields are only used in the Tangible/Declining Balance depreciation method.

Note: Useful Life rates also use the Residual Rate Definition.

See “Understanding Depreciation Processing” (Asset Lifecycle Management Fundamentals)

Leased Assets

PeopleSoft Asset Management supports the Declining Balance Depreciation Method - Finance Lease (excluding transfer of ownership) 10/9 method, which is calculated in this way:

Declining balance depreciation calculation resultx10/9

Use the Life and Rate Information page (MR_AM_LIFERATE) to set up useful life and depreciation rate tables and to modify rates for the lease depreciation method.

Navigation:

Set Up Financials/Supply Chain > Product Related > Asset Management > Depreciation > Rate-User Defined > Life and Rate Information

Example Values

This table shows the values used in an example using the Declining Balance Depreciation Method - Finance Lease (excluding transfer of ownership) 10/9 method:

Acquisition Cost	<i>1,000,000</i>
Useful Life	<i>5 years</i>
Depreciation Rate	<i>0.369</i>

Calculation Results for Example Values

Using the values from the previous table and applying the Declining Balance Depreciation Method (J6) - Finance Lease (excluding transfer of ownership) 10/9 method, the results are:

Year	<i>Depreciation Amount by Declining Balance Method</i>	<i>Depreciation Amount by 10/9 Method</i>
1	369,000	410,000
2	232,839	258,710
3	146,921	163,245
4	92,707	103,007
5	58,588	65,038
Total	900,000	1,000,000

Select the example depreciation methods on the Book-Tax page in the Asset Book Definition component, the Depreciation page in the Asset Profiles component, or the Depreciation Information page in the Asset ExpressAdd component.

Extended Depreciation Worksheet Page

Use the Extended Depreciation Worksheet page (AM_EXTENDED_DEPR) to search for candidate assets according to desired parameters.

Select to extend or not extend the depreciation period, remove from the list and enter the dates to resume depreciation.

Navigation:

Asset Management > Depreciation > Processing > Extended Depr Worksheet > Extended Depreciation Worksheet

The 2007 Japanese Tax Reform affects not only assets that are placed in service after March 31, 2007 but also increases the depreciation basis and expands the depreciation period for those fully depreciated assets that are using the Tangible/Straight Line and Tangible/Declining Balance depreciation methods. As a result, those depreciable assets acquired before April 1, 2007 are allowed, after having depreciated to the final depreciable limit, to depreciate the existing salvage value to the memorandum value of 1 JPY in five years using the Straight Line method.

Use the Extended Depreciation Worksheet to apply the extended depreciation calculation to assets after they have reached the depreciation limit under the Tangible/Straight Line and Tangible/Declining Balance depreciation methods. You can also identify assets that qualify for the extended depreciation using the Extended Depreciation Worksheet.

This example illustrates the fields and controls on the Extended Depreciation page. You can find definitions for the fields and controls later on this page.

Extended Depreciation

▼ Asset Search Criteria

<p>*Business Unit: <input type="text" value="JPN01"/> </p> <p>Method: <input type="text" value="J- Tan/DB"/></p> <p>Profile ID: <input type="text"/> </p> <p>Asset Class: <input type="text"/> </p> <p>From Date: <input type="text"/> </p> <p>From Asset ID: <input type="text"/> </p>	<p>*Book Name: <input type="text" value="LOCAL_JPY"/> </p> <p>Location: <input type="text"/> </p> <p>Cost Type: <input type="checkbox"/> </p> <p>Asset Category: <input type="text"/> </p> <p>To Date: <input type="text"/> </p> <p>To Asset ID: <input type="text"/> Chartfield Search Criteria</p>
---	--

▼ Transaction Information

<p>*Transaction Date: <input type="text" value="04/01/2007"/></p> <p>*Accounting Date: <input type="text" value="04/02/2007"/></p> <p>Life End Date: <input type="text" value="04/01/2012"/></p>	<p><input checked="" type="checkbox"/> Copy Extended to other Books</p> <p><input checked="" type="checkbox"/> Run Transaction Loader</p>
---	---

Retrieve Next **Rows** 1 - 2 Count Total New Search Refine Search

Use the buttons to mark assets for Extending, Not to Extend or Removing from the list.
 The changes will take effect after you click "Save" button.

Mark to Extend
 Mark to not Extend
 Remove From List

Mark	Extended Depr Status	Asset ID	Description	In Service Date	Profile ID	Cost	Accumulated Depreciation	Salvage Value
1	<input type="checkbox"/>	000000000111	Computer Hardware	07/25/2000	COMP01	100,380	95,361	5,019
2	<input type="checkbox"/>	000000000126	Computer Hardware	08/27/2000	COMP01	300,000	285,000	15,000

Enter the required fields **Business Unit**, **Book Name**, and **Method** to retrieve assets that are candidates for extended depreciation (those assets depreciated using the Tangible/Straight Line and Tangible/Declining Balance methods and are fully depreciated up to 95% of asset cost). You can also search by ChartField by clicking the **ChartField Search Criteria** link or use a date range to retrieve assets whose original transaction dates fall within the given period.

The Transaction Information section relates to the information needed to perform the extension of the asset useful life. It is applicable to the assets in the Results section. The Transaction Date should match the date that depreciation resumes for extended depreciation. The **Life End Date** field shows the calculated date in which the depreciation activity stops, including the additional period due to rounding down the remaining depreciation.

Note: It is important to run the Depreciation Reporting Table load process (AMDPREPT) as a prerequisite to retrieve fully depreciated assets from the Extended Depreciation page.

Using Special Depreciation and Increased Depreciation

PeopleSoft Asset Management supports special depreciation (initial and accelerated) and increased depreciation used in Japan. This table shows the types of special depreciations and their associated accounting methods, depreciation calculations, and additional notes as appropriate:

Depreciation Method	Type	Accounting Method	Depreciation Calculation	Notes
Special	Initial	Expense	Acquisition cost * special depreciation rate	Book the initial special depreciation amount as the depreciation amount, and add it to the standard depreciation amount.
Special	Initial	Reserve/Allowance	Acquisition cost * special depreciation rate	Do <i>not</i> add the initial special depreciation amount to the standard depreciation amount.
Special	Accelerated	Expense	Standard depreciation amount * accelerated depreciation rate	Book the accelerated depreciation amount as the depreciation amount, and add it to the standard depreciation amount.
Special	Accelerated	Reserve/Allowance	Standard depreciation amount * accelerated depreciation rate	Do <i>not</i> add the accelerated depreciation amount to the standard depreciation amount.
Increased	NA	NA	Standard depreciation amount * increased depreciation rate	

For the initial special depreciation and accelerated depreciation rate, specify the useful life in years and the depreciation rate on the Depreciation Terms Definition page.

For the increased depreciation rate, enter the specific rate on the Depreciation Details page.

See [Processing Depreciation](#)

See [Understanding How PeopleSoft Asset Management Calculates Depreciation](#).

Using Advanced Depreciation

You can also use advanced depreciation for Japan. This table shows the accounting methods that you can use with advanced depreciation:

Accounting Method	Action
Expense	Adds a cost line to the Corporate and Tax book for the advanced depreciation amount and enters a negative (–) cost as a compressed amount on the Asset/Cost Adjust Transfer page.
Allowance	Adds a cost line to the Corporate and Tax book for the advanced depreciation amount and enters a negative (–) cost as a compressed amount on the Asset Cost/Adjust Transfer page. You must select <i>A</i> (allowance) as the cost type.
Reserve	Adds a cost line to the Corporate and Tax book for the advanced depreciation amount and enters a negative (–) cost as a compressed amount on the Asset Cost Adjust/Transfer page. You must select <i>R</i> (reserve) as the reserve method.

Advanced Depreciation Reports

Use the Advanced Depreciation page (RUN_AMAD1000) to specify report request parameters to generate the advanced Depreciation Amount or Advanced Depreciation Reversal Schedule report.

Navigation:

Asset Management > Financial Reports > Cost and Depreciation > Advanced Depreciation Rpt JPN

When you adopt the advanced depreciation method by using the Allowance or Reserve method, you can verify the allowance or reserve amount for the compressed amount by using the Advanced Depreciation Amount of Advanced Depreciation Reversal Schedule report.

Run Mass Transactions

Composite depreciation, as practiced in Japan, is supported by calculating the useful life in years or by using the 5 percent retirement method.

Use the Run Mass Transactions page to process composite depreciation for Japan.

Navigation:

Asset Management > Asset Transactions > Mass Transactions > Run Mass Transactions

Note: To use the Composite Depreciation method for Japan, you must specify the Corporate and Tax book for Japan and select *Japan Composite* when you establish asset management business units.

You can add composite depreciable assets and individual assets by using the Asset Basic Information page. When you add composite depreciable assets, you must enter a profile ID, transaction date, and accounting date, and then click the **Capitalize** button on the Asset Acquisition Details page. When you add individual assets, you must enter the **Reporting Life**in periods on the Asset Information page.

After adding composite depreciable assets and individual assets for composite assets, you must capitalize by using the Mass Transaction CC-JPN Capitalize Composite.

Calculating the Automatic Useful Life in Years for Composite Depreciable Assets

The total acquisition cost includes the acquisition cost of each composite member asset divided by its respective useful life, calculating the depreciation amount for each composite member asset.

The acquisition costs of each composite member asset are then summed, and the total is divided by the summed depreciation amounts for each composite member asset.

This table displays the depreciation values calculated to find the total depreciation for 20,000,000 of asset costs:

Assets	Acquisition Cost (A)	Useful Life (B)	Depreciation Amount (A)/ (B)
Asset1	1,000,000	4 years	250,000
Asset2	3,000,000	5 years	600,000
Asset3	4,000,000	4 years	1,000,000
Asset4	7,000,000	10 years	700,000
Asset5	5,000,000	8 years	625,000
Totals	20,000,000	NA	3,175,000

The calculation of composite depreciation useful life is then:

$$20,000,000 / 3,175,000 = 6.29 \text{ or } 6 \text{ years (composite depreciation useful life)}$$

Using the 5 Percent Retirement Method

When using this method, depreciable composite member assets are retired, and the book value is 5 percent of the acquisition cost of each member asset retired.

Composite member assets can be retired by using the mass transaction CR-JPN Composite Retirement.

See [Understanding Mass Transaction Manager](#).

Identifying Collateral Assets

Japanese accounting principles require that assets that are offered as collateral be treated according to financial reporting regulations under commercial law. Collateral assets are identified on the Cost/Asset Information page in the Asset ExpressAdd component as one of these types in compliance with Japanese reporting requirements:

- Factory Foundation Mortgage.
- Fixed Mortgage.
- Mortgage.
- Other.

See [Adding Assets with the Asset ExpressAdd Component](#).

Using Currency Rounding Options

Rounding options are applied to depreciation calculations and asset salvage values. You can select rounding options to be used for depreciation calculations on the Business Unit/Book Definition page in the Establish Business Units - Asset Management Definition component, and for salvage value calculations on the Depreciation page in the Asset Profiles component.

Select a rounding rule, which determines the type of rounding that is performed. Select the *Currency* rounding type.

Select the rounding precision, rounding factor, and truncation. Round precision is the number of places to the right or left of the decimal point to which the amount or number is rounded. Rounding factor is the number to which the amount is rounded.

See “Creating PeopleSoft Asset Management Business Units” (Asset Lifecycle Management Fundamentals).

See “Setting Up Asset Profiles” (Asset Lifecycle Management Fundamentals).

Processing Local Tax Reports

Asset Management supports reporting requirements defined by Japanese local tax laws. The system provides these reports, including all required information for the local depreciable asset tax return:

- Depreciable Asset Tax Return (Tax Roll or Depreciable Assets) report (AMLT1000).
- Asset Detail (Increased Assets/All Assets) report (AMLT1100).

- Asset Detail (Decreased Assets) report (AMLT1200).

Use the Owner Information page ([Processing Local Tax Reports](#)OWNER_INFO_DEFN) to enter owner information that is printed on the Depreciable Asset Tax Return (Tax Roll) report.

Navigation:

Set Up Financials/Supply Chain > Product Related > Asset Management > Owner Information Definition

Use the Return Information page (RETURN_INFO_DEFN1) to enter information that is required for the Depreciable Asset Tax Return (Tax Roll) report.

Navigation:

Set Up Financials/Supply Chain > Product Related > Asset Management > Return Information Definition

To set up local tax reporting:

1. Define the localization country as Japan.

This enables the business unit information link for Japan. The link appears in the Establish Business Units component. Use the User Preferences component, and set the overall preferences localization country to *JPN*.

See “User Preferences - Overall Preferences Page” (Application Fundamentals).

2. Define business unit information for Japan.

This defines the corporate and tax default books for Japan, as well as enables advanced depreciation, composite asset functionality, and local tax usage. Specify the corporate and tax book that you use for Japan when you establish asset management business units, and select the **Use JPN Local Tax** check box.

See “Creating PeopleSoft Asset Management Business Units” (Asset Lifecycle Management Fundamentals).

3. Define owner information definition for Japanese assets.

This defines the information needed to process your local tax return.

See “Establishing Asset Ownership” (Asset Lifecycle Management Fundamentals).

4. Define local tax information in the Asset Information component.

See [Maintaining Asset Book Information](#).

5. Define the local tax return processing information.

To run the reports:

- Process the theoretical net book value and assessment value calculation. (Theoretical NBV is not needed since 2009, but still available for historical reporting).
- Process local tax reports.

Defining Local Tax Return Information

Use the Return Information page to define local tax return information.

Navigation:

Set Up Financials/Supply Chain > Product Related > Asset Management > Taxes > AM Return Information Defn JPN > Return Information Defn. - JPN.

This example illustrates the fields and controls on the Return Information Defn. - JPN page. You can find definitions for the fields and controls later on this page.

Return Information Defn. - JPN

SetID: SHARE Local Tax Office: JAPAN

Return Information Find | View All First 1 of 1 Last

Effective Date: 01/01/1900 Status: Active

Owner ID: Owner Code: Capital of Amount:

Recipient Name: Business Category: Year of Date: Year: Month:

Address

Address Line 1: Address Line 2: Address Line 3:

General Tax Information

Tax Exception Special/Advanced Depreciation Tax Free Asset

Life Reduction Increase Depreciation Notice Blue Returns

Tax Acct Depr: Building Category:

Contact

Reply Person: Telephone:

Licensed Tax Accountant: Telephone:

Rental Asset

Lessor Name: Telephone:

Notes

Description Line 1: Description Line 2: Description Line 3: Description Line 4: Description Line 5: Description Line 6:

Select an owner ID. Enter an owner code, capital amount (in millions of yen), recipient name of the taxation office where the return is filed, business category, and the year and month that the company commenced business.

Enter address information for up to three branch offices within the same city, district, or town (place of tax payment).

Note: If a branch office is located at the same address that is defined on the Owner Information page, you can leave these fields blank.

Field or Control	Description
Tax Exception	Select if you have assets to apply to the special treatment of the taxation standard.
Special/Advanced Depreciation	Select if you have assets to be applied to special depreciation under the Special Taxation Measures Law, or to be applied to advanced depreciation under Articles 42 to 50 and Article 142 of the Corporation Tax Law, or from Article 42 to 44 and Article 165, or Article 58 of the Tax on Income Law.
Tax Free Asset	Select if you have assets without taxation.
Life Reduction	Select if you have assets that have been applied a shorter useful life approved by the Director or the District Tax Office under the Corporate Tax Law – Govt. Order 57-1 and Tax on Income – Govt. Order 130-1.
Increase Depreciation Notice	Select if you have assets that have been submitted on a detailed statement for increased depreciation to the tax office under the Corporation Tax Law – Govt. Order 60 and Tax on Income Law – Govt. Order 133.
Blue Returns	Select if you file a blue return under the Corporation Tax Law, Article 122.
Tax Acct Depr (tax account depreciation)	Select a depreciation method in tax accounting.
Building Category	Select the possession classification of the building for the business place.
Reply Person	Enter the name and telephone number of the accounting representative.
Licensed Tax Accountant	Enter the name and telephone number of the licensed tax accountant.
Rental Asset	Select if you have rental assets.
Lessor Name and Telephone	Enter the name and telephone number of the lessor.

Use the **Notes** region to add any relevant descriptions, such as appendixes or remarks, or to identify any attachments.

Entering Asset Local Tax Return Information

Use the Local Tax Return page (LTAX_ADD_INFO_SEC) to enter local tax information when you acquire depreciable fixed assets.

Navigation:

Asset Management > Asset Transactions > Owned Assets > Asset ExpressAdd

or

Asset Management > Asset Transactions > Owned Assets > Asset Basic Add

Define the asset as *New* or *Used*, and select a local tax office.

Select one of these asset return type options:

- *Structure*
- *Machinery*
- *Ship*
- *Airplane*
- *Vehicle*
- *Tool*

Specify a numerator and denominator for the exception rate.

Specify a theoretical net book value and an assessment value for your information. (Theoretical NBV is not needed since 2009, but still available for historical reporting).

Note: The **Theoretical Net Book Value** and the **Assessment Value** fields are not required when you add a newly acquired asset in the current year, but you must enter the asset's assessment value reported in the *previous* year if you acquired assets in the previous year but added them to Asset Management for the first time.

Calculating Theoretical Net Book Value and Assessment Value

Use the NBV - Assessment Calculation page (AMLTPROC_RQST) to run an SQR process to load asset data and calculate the theoretical net book value and assessment value for each asset.

(Theoretical NBV is not needed since 2009, but still available for historical reporting).

Navigation:

Asset Management > Taxes > Calculate Local Taxes > Calculate Amounts JPN

Note: Enter the same local tax office code in both fields when you are reporting to a single tax office.

The results of this process populate the LTAX_INFO1_TBL.

Running Local Tax Reports

Select a range of local tax office codes to be declared for the theoretical net book value and assessment value.

Note: Enter the same local tax office code in both fields when you are reporting to a single tax office.

Use the Local Tax Report page (RUN_LTAXPROCESS) to run local tax reports for Japan.

Navigation:

Asset Management > Taxes > Reports > Local Tax Return Report JPN

Specify a return year.

Select one of the **Request Local Tax Return** options:

<i>Field or Control</i>	<i>Description</i>
All	Include all assets.
Increase	Include assets added and received by transfer in this fiscal year.

Changing the Local Tax Office and Asset Return Type

Enter the transaction date on which to change the local tax office and asset return type. Enter the new local tax office code for filing the return.

Select one of these new asset return types:

- *Structure*
- *Machinery*
- *Ship*
- *Airplane*
- *Vehicle*
- *Tool*

Changing the Local Tax Office and Asset Return Type While Transferring Assets

When you transfer assets, the operation process varies according to the transfer scenario. This table displays the various operation processes:

<i>Transfer Scenario</i>	<i>Operation Process</i>
Asset is partially transferred to another local tax office, or the asset return type is changed, or both.	Use <i>InterUnit Transfer</i> to change the local tax office, or the asset return type, or both.
Asset is fully transferred to another department ID and the local tax office where the return is filed, and the asset return type has changed.	Use <i>Transfer</i> to change the local tax office or asset return type.
Asset is partially transferred to another department ID and the local tax office where the return is filed, and the asset return type has changed.	Use <i>InterUnit Transfer</i> to change the local tax office and asset return type.

Entering Consumption Tax

Asset Management supports Japanese consumption tax on asset sales by using VAT functionality on the asset Retirement page. In addition to entering VAT information, you can enter customer information for asset sales.

See [VAT Page](#).

See “Creating PeopleSoft Asset Management Business Units” (Asset Lifecycle Management Fundamentals).

Archiving Asset Information

Understanding Archiving

The tables that store asset information accumulate large volumes of data over time. Eventually some of this data is no longer needed on a routine basis. You can use PeopleSoft Asset Management to archive inactive data on the cost and depreciation of assets, and if that data is ever needed again, you can use PeopleSoft Asset Management to restore the data that you archived. The benefits of archiving inactive data include improving the performance of reports and processes and reducing the space that your system needs to store asset data.

Before you archive inactive asset information, you should keep these general guidelines in mind. You cannot archive:

- Retired assets.
- Group assets.
- Assets with depreciation based on schedules.

You can archive active assets one at a time or by using a range of asset IDs. You must archive each asset book by book. The fiscal year must be closed before an asset can be archived. The archive period automatically defaults to the last period of the specified fiscal year.

You can archive an asset more than one time. If you archive an asset multiple times and later decide to restore the data, you will need to restore each archive one by one. For example, if you archive an asset two times, you will need to restore the asset information two times, one for each archive that was run.

The process that archives data actually moves application data from the application tables to the archive tables. The process then deletes data from the application tables.

The archive tables are just like other application tables. You can back up these archive tables using another disk or tape for storage and then manually delete the contents of the archive tables if desired. This approach allows you to use tools, such as PS/Query, to report and review the contents of the archived files. The data in the archived files can also be joined to the application tables to provide a complete picture of activity including active and archived data.

After you archive an asset, you cannot perform a transaction or a transfer involving that asset before the archival date unless you restore the archived asset. For example, if the asset has been archived through December 31 of the previous year, you will not be able to perform any transactions on the asset in the previous year.

All historical data showing transaction costs in multiple currencies is supported in the archive and restore processes. You can save transactions with multiple currencies just as they occurred and restore them as well.

You can archive, delete, and retrieve archived data, accumulated by a process that updates high volume asset management transaction tables: ASSET_NBV_TBL, DEPR_RPT, OPEN_TRANS, and DIST_LN.

Using the Run Mass Transactions component, you can use the delivered mass transaction for each transaction table to archive, delete, or view archived. This method enables improved performance for day-to-day transactions while maintaining historical data for reporting and audit purposes.

Note: When archiving is complete, you need to incrementally rebuild index tables to remove the records from the index. This applies to all tables that are part of the Search Definition (index) for this product.

Related Links

[Understanding Mass Transaction Manager](#)

Archiving Inactive Assets

This topic describes how to run a process that archives depreciation, cost, and book data.

Use the Archive Cost/Depreciation (AM_ARCHIV) component to archive asset management cost and depreciation transactions.

Page Used to Archive Data

<i>Page Name</i>	<i>Definition Name</i>	<i>Usage</i>
Archive Cost/Depreciation Page	RUN_ARCHIVE	Run the Asset Archive process (AMDPARCH) to archive inactive cost and depreciation data.

Archive Cost/Depreciation Page

Use the Archive Cost/Depreciation page (RUN_ARCHIVE) to run the Asset Archive process (AMDPARCH) to archive inactive cost and depreciation data.

Navigation:

Asset Management, Asset Transactions, History, Archive Cost/Depreciation, Archive Cost/Depreciation

Asset Management > Asset Transactions > History > Archive Cost/Depreciation > Archive Cost/Depreciation.

This example illustrates the fields and controls on the Archive Cost/Depreciation page. You can find definitions for the fields and controls later on this page.

Archive Cost/Depreciation

Run Control ID Jobs Report Manager Process Monitor
Run

Report Request Parameters

Unit

Book Name

From Asset ID

To Asset ID

Fiscal Year

Process Frequency

Archive ID

Field or Control	Description
Unit	Select the business unit from which records will be archived.
Book Name	You must archive an asset using each book it is associated with.
From Asset ID and To Asset ID	Use these fields to archive a range of asset IDs. To archive one asset, enter the asset ID in the From Asset field.
Fiscal Year	By default, the process will archive data up to the last period of the fiscal year you enter here. The fiscal year must be closed before an asset can be archived.
Archive ID	When you run the process, the system populates this field with the run control ID and stores the archive ID in the <i>ARCHIVE_NO</i> field on the depreciation table. You must keep a record of this archive ID if you want to restore archived data.

The Asset Archive Application Engine (AM_CSDP_ARCH) process copies inactive data from the application tables to archive tables. This process then deletes the archived data from the application tables and consolidates the rows that are left.

For cost rows, the Asset Archive process consolidates multiple cost rows of data into one row.

For depreciation rows, all the depreciation rows prior to the *Fiscal Year* are summed up to create one *ADD* row for accumulated depreciation. The archived records are stored in the depreciation history table.

Viewing Archived Data

You can use inquiry pages to look up different levels of information about archived data.

You can also use the following queries:

- COST_ARCHIVE
- DEPR_ARCHIVE
- BOOK_ARCHIVE

Use the Review Book (ASSET_BOOK_HIST) and the Review Cost (COST_HISTORY) components to view archived asset data.

Pages Used to View Archived Data

Page Name	Definition Name	Usage
Review Book – List	ASSET_BOOK_HIST1	Review book change history.
Review Book – Detail	ASSET_BOOK_HIST2	Review detailed book change history.
Cost History List	ASSET_TRANS_01	View a history of an asset's transactions, including assets that have been archived as an ADD transaction. For archived assets, the total cost includes the sum of the costs consolidated into one cost row.
Cost History Detail	ASSET_TRANS_02	View more detail about a specific transaction.
Non-Cap History List	ASSET_TRANS_03	View a history of a non-capitalized asset's transactions, including assets that have been archived as an ADD transaction. For archived assets, the total cost includes the sum of the costs consolidated into one cost row.
Non-Cap History Detail	ASSET_TRANS_04	View more detail about a specific transaction for a non-capitalized asset.

Restoring Archived Data

This topic describes how to run a process that restores archived data.

Use the Restore Cost/Depreciation (AM_RESTORE) component to restore archived asset cost and depreciation transactions.

Page Used to Restore Archived Data

<i>Page Name</i>	<i>Definition Name</i>	<i>Usage</i>
<u>Restore Cost/Depreciation Page</u>	RUN_RESTORE	Run the Asset Restore (AM_CD_RESTO) Application Engine process that copies data stored in the archive tables back to the application tables.

Restore Cost/Depreciation Page

Use the Restore Cost/Depreciation page (RUN_RESTORE) to run the Asset Restore (AM_CD_RESTO) Application Engine process that copies data stored in the archive tables back to the application tables.

Navigation:

Asset Management > Asset Transactions > History > Restore Cost/Depreciation > Run Restore

<i>Field or Control</i>	<i>Description</i>
Unit	Select the business unit from which records will be restored.
Book Name	You must restore an asset in each book associated with the asset.
From Asset ID and To Asset ID	Use these fields to restore a range of archived asset IDs. To restore one archived asset, enter the asset ID in the From Asset field.
Archive ID	Enter the run control ID that the system generated when the data was archived. By default, the system displays the most recent run control ID for the Asset Archive process.

The Asset Restore process restores the archived data by deleting the summed row in the application tables and replacing it with the multiple rows of data stored in the archive tables.

Archiving From Transaction Table Details

PeopleSoft provides the transactions for the Run Mass Transactions component to archive, delete, and retrieve data from high-volume transaction detail tables. The tables available for this process are:

- ASSET_NBV_TBL: Accumulates detail lines from net book value processing.
- DEPR_RPT: Accumulates detail lines from depreciation reporting.
- OPEN_TRANS: Accumulates detail lines from open transactions.
- DIST_LN: Accumulates information from creating accounting entries.

The transaction detail lines can also be deleted from the tables once they have been archived, or without archive if the transactions are set to be purged. Data that is archived is also available for retrieval as needed for reporting or audit purposes.

The steps for archiving, deleting or retrieving transaction detail from tables are:

1. Run Calculate Depreciation (AM_DEPR_CALC) process to generate depreciation calculations.
2. Run Depreciation Reporting (AMDPREPT) process and Load Net Book Value (AMLDNBVT) process to collect the information provided by AM_DEPR_CALC. (If you are working with the OPEN_TRANS or DIST_LN tables, you do not need to run these processes.)
3. Run the archive mass transaction for the table from which transactions are pulled.
4. Run the delete mass transaction for the table from which transactions are pulled.
5. Run the retrieve mass transaction for the table from which transactions are to be viewed.

The mass transactions to archive, delete and retrieve detail are:

- *Archive Asset Depr Rpt entries*
- *Archive Asset NBV entries*
- *Archive Asset Open Trans*
- *Archive Asset Acctng Entries*
- *Delete Asset Acctng Entries*
- *Delete Asset Depr Rpt entries*
- *Delete Asset NBV entries*
- *Delete Asset Open Trans*
- *Unload DIST_LN_ARCH to file*
- *Unload Open Trans to File*
- *Upload Asset Open Trans*
- *Upload Asset Acctng Entries*

Related Links

[Understanding Mass Transaction Manager](#)

Understanding the Loader Table Data Dictionary

Understanding the Loader Tables

This topic contains descriptions and explanations of the usage of the fields in PeopleSoft Asset Management loader tables INTFC_FIN, INTFC_PHY_A, and INTFC_PHY_B. This topic, in conjunction with the listing of these records in PeopleSoft Application Designer, provides all the information users need to load data into PeopleSoft Asset Management using these tables. Information about records in the Application Designer includes the field type, size, valid values, and other technical details. The field names used in this topic match the field names in the tables. For example, the field name for Interface ID in any table is always INTFC_ID.

If any of these fields is modified in the application tables, then they must also be modified in the loader tables if you will be using the Transaction Loader.

Loader Table INTFC_FIN

The following table describes the information found in Loader Table INTFC_FIN:

Field Name	Long Name	Use and Processing Considerations	Tables Updated	Required for Conversion
INTFC_ID	Interface ID	<p>Key to this table. An interface ID is typically assigned to a group of transactions with the same load type.</p> <p>Use a unique, previously unused INTFC_ID for each set of transactions with the same load type.</p> <p>When using a load type of CN1 and NEXT in the ASSET_ID field, use a unique INTFC_ID for each asset.</p> <p>For FADs and Conversions, if INTFC_ID is the same for multiple lines for an asset, increment the INTFC_LINE_NUM for each line.</p>	Internal use	Y
INTFC_LINE_NUM	Interface Line Number	<p>Key to this table. Interface Line Number is used as a key for multiple lines for the same Interface ID for transactions with similar keys (for example, multiple acquisition details, such as CAP).</p> <p>For FADs and Conversions, if INTFC_ID is the same for multiple lines for an asset, increment the INTFC_LINE_NUM for each line.</p>	Internal use	Y
BUSINESS_UNIT	Business Unit	Identifies the business unit of the financial transaction to be processed. (You should never have more than one business unit per interface ID.)	BOOK, COST, DEPRECIATION, RETIREMENT, OPEN_TRANS	Y

Field Name	Long Name	Use and Processing Considerations	Tables Updated	Required for Conversion
ASSET_ID	Asset Identification	Identifies the asset ID of the financial transaction to be processed. For add interface types (ADD, NAD, FAD, CN1, and so on), if this field contains the value 'NEXT' then Transaction Loader will assign the next asset ID for this business unit.	BOOK, COST, DEPRECIATION, RETIREMENT, OPEN_TRANS	Y
BOOK	Asset Book Name	<p>Identifies the asset book to be processed. All financial transactions must be assigned a book if the DEFAULT_PROFILE_SW = 'N'.</p> <p>The financial information for an asset (book, cost, depreciation, retirements) addition can be entered by creating transactions manually. To do this, enter one row into the INTFC_FIN table for each book to which an asset reports.</p> <p>This information can also be provided by default via the profile. The Transaction Loader will then populate the financial tables for all books specified in the profile from the one row in INTFC_FIN. When the DEFAULT_PROFILE_SW is set to 'Y', book can be left blank (" "). Books will be populated by default from the profile, which is populated in INTFC_PHY_A.</p> <p>If you are doing a CN1, set the DEFAULT_PROFILE_SW to 'N'.</p>	BOOK, COST, DEPRECIATION, RETIREMENT, OPEN_TRANS	Y when Default Profile Switch = N

Field Name	Long Name	Use and Processing Considerations	Tables Updated	Required for Conversion
DTTM_STAMP	Date/Time Stamp	<p>Populates the key field of datetime stamp in many tables. Represents the date and time that this transaction was added to the system. While Date/Time Stamp can be set to any value, PeopleSoft recommends that you set it to the date of the conversion to ensure that this date will be earlier than the date of any further transactions.</p> <p>This value is used as a key because INTFC_LINE_NUM is not always incremented. Making this a key is a safeguard against getting a duplicate insert.</p> <p>If a single asset has multiple cost rows, you may want to increment this field by one second for each subsequent row to prevent duplicate inserts into PS_COST.</p>	COST, DEPRECIATION, RETIREMENT, OPEN_TRANS	Y
VOUCHER_ID	Voucher ID	<p>Identifies the voucher associated with the financial transaction. This value is used in AP integration. This field can be used for PeopleSoft or non-PeopleSoft integration. This field is in this table so that the INTFC_FIN transactions can be easily queried by voucher. This field should be populated if the transaction is voucher related.</p>	Internal use	

Field Name	Long Name	Use and Processing Considerations	Tables Updated	Required for Conversion
VOUCHER_LINE_NUM	Voucher Line Number	Identifies the voucher line number associated with the financial transaction. This value is used in AP integration. This field can be used for PeopleSoft or non-PeopleSoft integration.	Internal use	
DISTRIB_LINE_NUM	Distribution Line Number	Identifies the voucher line distribution number associated with the financials transaction. This value is used in AP integration. This field can be used for PeopleSoft or non-PeopleSoft integration.	Internal use	
OPERATING_UNIT	Operating Unit	A ChartField that can be customized. See the online ChartField customization topic for further discussion. <i>See PeopleSoft Application Fundamentals, Understanding PeopleSoft ChartField Configuration.</i>	COST, DEPRECIATION	
DEPTID	Department	A ChartField that can be customized. See the online ChartField customization topic for further discussion. <i>See PeopleSoft Application Fundamentals, Understanding PeopleSoft ChartField Configuration.</i>	COST, DEPRECIATION	

Field Name	Long Name	Use and Processing Considerations	Tables Updated	Required for Conversion
PRODUCT	Product	<p>A ChartField that can be customized. See the online ChartField customization topic for further discussion.</p> <p><i>See PeopleSoft Application Fundamentals , Understanding PeopleSoft ChartField Configuration.</i></p>	COST, DEPRECIATION	
FUND_CODE	Fund Code	<p>A ChartField that can be customized. See the online ChartField customization topic for further discussion.</p> <p><i>See PeopleSoft Application Fundamentals, Understanding PeopleSoft ChartField Configuration.</i></p>	COST, DEPRECIATION	
CLASS_FLD	Class Field	<p>A ChartField that can be customized. See the online ChartField customization topic for further discussion.</p> <p><i>See PeopleSoft Application Fundamentals, Understanding PeopleSoft ChartField Configuration.</i></p>	COST, DEPRECIATION	
PROGRAM_CODE	Program Code	<p>A ChartField that can be customized. See the online ChartField customization topic for further discussion.</p> <p><i>See PeopleSoft Application Fundamentals, Understanding PeopleSoft ChartField Configuration.</i></p>	COST, DEPRECIATION	

Field Name	Long Name	Use and Processing Considerations	Tables Updated	Required for Conversion
BUDGET_REF	Budget Reference	<p>A ChartField that can be customized. See the online ChartField customization topic for further discussion.</p> <p><i>See PeopleSoft Application Fundamentals, Understanding PeopleSoft ChartField Configuration.</i></p>	COST, DEPRECIATION	
AFFILIATE	Affiliate	<p>A ChartField that can be customized. See the online ChartField customization topic for further discussion.</p> <p><i>See PeopleSoft Application Fundamentals, Understanding PeopleSoft ChartField Configuration.</i></p>	COST, DEPRECIATION	
AFFILIATE_INTRA1	Fund Affiliate	<p>A ChartField that can be customized. See the online ChartField customization topic for further discussion.</p> <p><i>See PeopleSoft Application Fundamentals, Understanding PeopleSoft ChartField Configuration.</i></p>	COST, DEPRECIATION	
AFFILIATE_INTRA2	Operating Unit Affiliate	<p>A ChartField that can be customized. See the online ChartField customization topic for further discussion.</p> <p><i>See PeopleSoft Application Fundamentals, Understanding PeopleSoft ChartField Configuration.</i></p>	COST, DEPRECIATION	

Field Name	Long Name	Use and Processing Considerations	Tables Updated	Required for Conversion
CHARTFIELD1	ChartField 1	<p>A ChartField that can be customized. See the online ChartField customization topic for further discussion.</p> <p><i>See PeopleSoft Application Fundamentals, Understanding PeopleSoft ChartField Configuration.</i></p>	COST, DEPRECIATION	
CHARTFIELD2	ChartField 2	<p>A ChartField that can be customized. See the online ChartField customization topic for further discussion.</p> <p><i>See PeopleSoft Application Fundamentals, Understanding PeopleSoft ChartField Configuration.</i></p>	COST, DEPRECIATION	
CHARTFIELD3	ChartField 3	<p>A ChartField that can be customized. See the online ChartField customization topic for further discussion.</p> <p><i>See PeopleSoft Application Fundamentals, Understanding PeopleSoft ChartField Configuration.</i></p>	COST, DEPRECIATION	
PROJECT_ID	Project	<p>A ChartField that can be customized. See the online ChartField customization topic for further discussion.</p> <p><i>See PeopleSoft Application Fundamentals, Understanding PeopleSoft ChartField Configuration.</i></p>	COST, DEPRECIATION	

Field Name	Long Name	Use and Processing Considerations	Tables Updated	Required for Conversion
CATEGORY	Asset Category	<p>An asset ChartField that is used to derive the GL accounts for any given financial transaction (used in conjunction with Cost Type, Trans Type, and Trans Code).</p> <p><i>See PeopleSoft Asset Management, Creating PeopleSoft Asset Management Accounting Entries, Accounting Entry Templates.</i></p>	COST, DEPRECIATION	Y
COST_TYPE	Cost Type	<p>An asset ChartField that is used to derive the GL accounts for any given financial transaction (used in conjunction with Trans Type, and Trans Code). See the Accounting Entries topic.</p> <p><i>See PeopleSoft Asset Management, Creating PeopleSoft Asset Management Accounting Entries, Accounting Entry Templates.</i></p>	COST, DEPRECIATION	

Field Name	Long Name	Use and Processing Considerations	Tables Updated	Required for Conversion
CF_SEQNO	Chartfield Sequence Number	Internal Use. Every combination of Chartfield values at the Asset/Book level has a unique ChartField sequence number (CF_SEQNO), and every ChartField sequence number value at the Asset/Book level represents one combination of ChartField values. The values of this field are not shared among assets. When the cost of the asset is transferred to a new combination of ChartFields, the ChartField sequence number is assigned a new value.	COST, DEPRECIATION	
INTFC_TYPE	Interface Type, also called Load Type	Identifies the type of transaction. Transaction Loader will process this transaction based on this field. A list of interface types and their usage is included at the end of this table.	Internal Use	Y default CN1 or CN2
SYSTEM_SOURCE	System Source	The source system that created this transaction. Valid values are listed in the translate table. This field is used extensively by Asset Management to drill back to source systems. You can add valid values to the translate table for your external systems, or you can use EXT. You can run Transaction Loader selectively for specific values of system source.	Internal Use	Y default CNV

Field Name	Long Name	Use and Processing Considerations	Tables Updated	Required for Conversion
APPROVAL_SW	Auto-approval Status	Identifies whether the transaction is approved or not. Transaction Loader will only load approved transactions. Valid values are 'Y' for approved and 'N' for not approved.	Internal Use	Y
PI_ID	Physical Inventory ID	Used for internal processing. Do not populate. The physical inventory ID that was entered when defining physical inventory is used here.	Internal Use	
INTFC_STATUS	Interface Status	Used for internal processing. Default this field to 'DON'.	Internal Use	Y default DON

Field Name	Long Name	Use and Processing Considerations	Tables Updated	Required for Conversion
LOAD_STATUS	Load Status	<p>Identifies the status of this transaction. Updated by the Transaction Loader. Valid values are:</p> <ul style="list-style-type: none"> • NEW Not processed. • ERR An error exists on this transaction and it will not be processed. • DON The transaction has been successfully processed. • CON The transaction has been consolidated into a different transaction and it will not be loaded. • UNI The transaction has been unitized into a different transaction and it will not be loaded. • HLD The transaction is on hold. This is used to prevent or delay the processing of an entry. • INP The transaction is in process. This is the status while the application engine is working with the row. 	Internal Use	Y NEW

Field Name	Long Name	Use and Processing Considerations	Tables Updated	Required for Conversion
ORIG_INTFC_ID	Original Interface ID	Used for internal processing. Do not populate.	Internal Use	
ORIG_LINE_NUM	Original Interface Line Number	Used for internal processing. Do not populate.	Internal Use	

Field Name	Long Name	Use and Processing Considerations	Tables Updated	Required for Conversion
DEFAULT_PROFILE_SW	Default Books from Profile	<p>Identifies whether a profile will be used for an asset add or capitalization by the Transaction Loader. When this switch is set to Y the fields in the BOOK table are defaulted from the profile tables rather than the loader tables (INTFC_). When this switch is set to Y, the category and group asset ID on the COST table, group asset ID on the OPEN_TRANS table, a few fields on the ASSET and ASSET_ACQ_DET tables, and the retirement convention on the RETIREMENT table will also be defaulted from the profile tables. The profile_id is identified on the INTFC_PHY_A table.</p> <p>When this switch is set to C, the category from the interface row is retained. If the switch is set to G, the group is retained. If the switch is set to B, both the category and the group are retained.</p> <p>When performing a CNI, you must set the DEFAULT_PROFILE_SW to N.</p> <p>The default value of DEFAULT_PROFILE_SW in INTFC_FIN must match the status of DEFAULT_PROFILE_SW in INTFC_PHY_A.</p> <p>The section on Setting Up Asset Profiles in the topic entitled Establishing Asset Processing, explains</p>	Internal Use	Y

Field Name	Long Name	Use and Processing Considerations	Tables Updated	Required for Conversion
		<p>profile processing, including which fields default from a profile. Remember, the values from a profile always override the values on this table if profile processing has been chosen.</p>		
TRANS_CODE	Transaction Code	<p>Used to identify special accounting treatment for the transaction. The category, cost type, transaction type, and transaction code together identify the accounting entry template that will be used for a given transaction. The transaction code allows you to specify an alternative template to be used for a transaction.</p> <p>If you add or modify a TRANS_CODE, you must set up an Accounting Entry Template for each additional Category/Cost Type/Trans Code/Trans Type combination it generates. For more information on Transaction Codes and Accounting Entry Templates, refer to Establishing Asset Processing.</p>	COST, DEPRECIATION	

Field Name	Long Name	Use and Processing Considerations	Tables Updated	Required for Conversion
TRANS_IN_OUT	Transaction In/Out	<p>Used to identify which side of a transfer or recategorization this transaction represents. Every such transaction contains two transactions.</p> <p>The <i>outside</i> of the transaction adjusts the asset being transferred/ recategorized from.</p> <p>The <i>inside</i> of the transaction adjusts the asset being transferred/ recategorized to. Valid values are 'O' and 'I'.</p>	COST, DEPRECIATION	
TRANS_DT	Transaction Date	<p>Denotes the date this transaction occurred.</p> <p>Example: An asset was purchased and placed into service on 15 April, 2007, but was added to the system on 5 June, 2007. The company wanted the add to hit the general ledger for period 5 (May). In this example the transaction date would be 15 April, 2007. The accounting date most likely would be 31 May, 2007.</p> <p>During conversion it is important that this field represent the last period for which depreciation has been calculated.</p> <p>For CN1 load types, the system increments the TRANS_DT and ACCOUNTING_DT you enter into INTFC_FIN by one day. So if you enter May 31, 2009 as your transaction and accounting dates, the system will use June 1, 2009.</p>	COST, DEPRECIATION, OPEN_TRANS	Y

Field Name	Long Name	Use and Processing Considerations	Tables Updated	Required for Conversion
ACCOUNTING_DT	Accounting Date	<p>Denotes the date this transaction was accounted for. This date is passed to the general ledger. It is the difference between the transaction date and the accounting date that identifies a retroactive transaction. Remember, the accounting date must always be greater than or equal to the transaction date.</p> <p>See the example of transaction date for an example.</p> <p>For CN1 load types, the system increments the TRANS_DT and ACCOUNTING_DT you enter into INTFC_FIN by one day. So if you enter 05/31/95 as your transaction and accounting dates, the system will use 06/01/95.</p>	COST, OPEN_TRANS	Y
IN_SERVICE_DT	In Service Date	<p>The date the asset was placed in service. This field is used in conjunction with the convention to determine the begin depreciation date. This field only relates to depreciable assets.</p>	BOOK	Y
IN_SERVICE_PD	In Service Period	<p>The calendar period in which the in service date falls. If this field is not populated, the depreciation calculation program will calculate it.</p>	BOOK	

Field Name	Long Name	Use and Processing Considerations	Tables Updated	Required for Conversion
IN_SERVICE_FY	In Service Fiscal Year	The calendar fiscal year in which the in service date falls. If this field is not populated, the depreciation calculation program will calculate it.	BOOK	
DEPR_IN_SERVICE_SW	Depreciate When in Service	This field marks whether the yearly depreciation in the year of acquisition should be spread from the in service date through the end of the year or from the begin depreciation date as calculated using the convention and the in service date. Example: In service date = 1 April 1997, convention = half year, begin depreciation date = 1 July, 1997, 1997 Depreciation = \$1,000. If this field = 'Y' then the \$1,000 will be spread from 1 April to 31 December. If this field = 'N' then the \$1,000 will be spread from 1 July to 31 December.	BOOK	Y default N
BEGIN_DEPR_DT	Begin Depreciation Date	The date the asset begins depreciating. This field is typically calculated by the depreciation calculation program (AM_DEPR_CALC) using the in service date and the convention, so you should leave this field blank.	BOOK	
BEGIN_DEPR_PD	Begin Depreciation Period	Used for internal processing. Do not populate.	BOOK	
BEGIN_DEPR_FY	Begin Depreciation Fiscal Year	Used for internal processing. Do not populate.	BOOK	

Field Name	Long Name	Use and Processing Considerations	Tables Updated	Required for Conversion
BEGIN_FRACTION	Begin Depreciation Period Fraction	Used for internal processing. Do not populate.	BOOK	
DEPR_CALC_SW	Depreciation Calculation Switch	Used for internal processing. Do not populate.	BOOK	
BEGIN_CALC_DT	Begin Depreciation Calculation Date	Used for internal processing. Do not populate.	BOOK	
BEGIN_CALC_PD	Begin Calculation Period	Used for internal processing. Do not populate.	BOOK	
BEGIN_CALC_FY	Begin Calculation Fiscal Year	Used for internal processing. Do not populate.	BOOK	
CALCULATION_TYPE	Calculation Type	<p>The type of depreciation calculation that will be performed by the depreciation calculation program (AM_DEPR_CALC). The valid values are 'R' for remaining value and 'L' for Life-to-Date. Most conversions will use a remaining value type. For a more detailed discussion of these calculation types, please refer to topic: Understanding Depreciation Calculations.</p> <p>In general, if the Remaining Value option is selected, depreciation will be calculated from the Transaction Date. If the Life-to-Date option is selected, depreciation will be calculated from the Begin Depreciation Date.</p>	BOOK	Y

Field Name	Long Name	Use and Processing Considerations	Tables Updated	Required for Conversion
LAST_CALC_TYPE	Last Calculation Type	Used for internal processing. Do not populate.	BOOK	
RSV_FRACTION	Reserve Fraction (RSV/ Cost)	Used for internal processing. Do not populate.	BOOK	
RECALC_RSV_SW	Recalculate RSV Fraction (RSV/Cost)	Used for internal processing. Do not populate.	BOOK	
SCHED_FRACTION	Fraction of Schedule Elapsed	Used for internal processing. Do not populate.	BOOK	
YEAR_REM_FRACTION	Year Remaining Fraction	Used for internal processing. Do not populate.	BOOK	
DEPR_STATUS	Depreciation Status	<p>Marks the asset book as depreciable or non-depreciable. The valid values are 'D' for depreciable and 'N' for non-depreciable. If an asset is marked non-depreciable, then the depreciation calculation program (AM_DEPR_CALC) will not process it and no depreciation will be posted. It can still be capitalized, however, and Cost and Book record rows will be tracked.</p> <p>If you mark an asset book as non-depreciable, you must still enter a life and convention for it.</p>	BOOK	Y
REGULATION	Depreciation Regulation	Identifies the U.S. tax regulation that covers this asset book. Valid values are in the translate table.	BOOK	

Field Name	Long Name	Use and Processing Considerations	Tables Updated	Required for Conversion
RECOVERY_LIFE	Recovery Life	Identifies the U.S. tax recovery life for this asset book.	BOOK	
RECOVERY_SUBTYPE	Recovery Sub-type	Identifies the U.S. tax recovery sub-type for this asset book.	BOOK	
CONVENTION	Prorate Convention	<p>Identifies the depreciation prorate convention to be used with this asset book.</p> <p>The convention is applied to the in service date to calculate the begin depreciation date for the asset book.</p> <p>The valid values must be set up on the convention table prior to implementation.</p> <p>PeopleSoft ships a 'MODEL' set of conventions with the system that can be shared by your business units.</p> <hr/> <p>Note: If you are using a calendar other than a standard, 12-period calendar, you may need to modify the MODEL set of conventions or create new convention definitions that match the calendar or calendars you are using.</p> <hr/>	BOOK	Y

Field Name	Long Name	Use and Processing Considerations	Tables Updated	Required for Conversion
LIFE	Life	Identifies the depreciable life of this asset book. If the asset is using a depreciation method that uses life (such as straight line, schedule, declining balance switching to straight line, and so on), then life is a required field. Life is measured in periods. If you are using a calendar that is 12 periods and the life of the asset is 5 years, then the life field would contain 60.	BOOK	Y for most depreciation methods
LIFE_REMAINING	Remaining Life	Used for internal processing. Do not populate.	BOOK	
TAX_CLASS_AM	Guideline Tax Class	Identifies the U.S. tax class associated with this asset book.	BOOK	
DEPR_PERCENT	Percent	Identifies the percent to be used. This field is only used when the depreciation method is flat rate or declining balance.	BOOK	Y for flat rate declining balance depreciation
DB_PERCENT	Declining Balance Percent	Identifies the declining balance percent. This field is only used when the depreciation method is declining balance with switch to straight line.	BOOK	Y for declining balance with a straight line switch depreciation
METHOD	Depreciation Method	Identifies the depreciation method to be used. Valid values are in the translate table.	BOOK	Y

Field Name	Long Name	Use and Processing Considerations	Tables Updated	Required for Conversion
DEPR_SCHED_CD	Depreciation Schedule Code	<p>Identifies the depreciation schedule to be used. This field is only used if the depreciation method is schedule. This field must reference a valid depreciation schedule. The schedules are defined by the user in the Establish Asset Processing window. PeopleSoft ships a number of sample schedules in the 'MODEL' TableSet.</p> <hr/> <p>Note: Life is a key field on the Depreciation Schedule Code table. Verify that the Depreciation Schedule Code selected is valid and life corresponds to the value entered in the life field.</p> <hr/>	BOOK	Y for depreciation method Schedule
DEPR_LIMIT_CD	Depreciation Limit Code	<p>Identifies the depreciation limits to be used. Depreciation limits are used to limit the amount of depreciation expense that can be taken in a given fiscal year. This field must reference a valid depreciation limit. The limits are defined by the user in the Establish Asset Processing window. PeopleSoft ships a number of sample limits in the 'MODEL' TableSet.</p>	BOOK	
PROPERTY_CD	Property Code	<p>Identifies what code of property the asset book falls into for U.S. tax processing purposes. Valid values are '1' for section 1245 property and '2' for section 1250 property.</p>	BOOK	

Field Name	Long Name	Use and Processing Considerations	Tables Updated	Required for Conversion
PROPERTY_TYPE	Property Type	Identifies the type of property the asset book represents. Valid values are 'R' for real property and 'P' for personal property.	BOOK	
SALVAGE_VALUE	Salvage Value	The salvage or residual value that is to be used in the depreciation calculation for this asset book. It is subtracted from the cost to determine the depreciable basis in depreciation calculations.	COST	
TAX_CREDIT_SW	Tax Credit Switch	Used for internal processing. Do not populate.	BOOK	
BASIS_RED_TOTAL	Basis Reduction Total	The total amount of the reduction in the cost basis for this asset book.	BOOK	
BASIS_RED_RECAP	Basis Reduction Recapture	The total amount of the recapture of the basis reduction for this asset book.	BOOK	
SEC179_TAKEN_SW	Section 179 Taken Switch	Identifies whether the asset book has qualified under the U.S. Tax regulation section 179. Valid values are 'Y' for yes and 'N' for no.	BOOK	
SEC179_AMT	Section 179 Taken Amount	If the asset book qualified for section 179 expense, how much was taken?	BOOK	

Field Name	Long Name	Use and Processing Considerations	Tables Updated	Required for Conversion
ACTIVITY_SW	Activity Switch	Identifies whether this transaction reflects an active ChartField combination for an asset. This field is numeric. When the sum of the activity switch for a ChartField combination for an asset = 0, then this ChartField combination is active. For asset adds, this field is always 0.	COST, DEPRECIATION	
RETIRE_SW	Retirement Switch	Identifies whether this ChartField combination for the asset book has been retired (fully) or not. This field is numeric and works the same as the activity switch.	COST	
QUANTITY	Asset Quantity	Represents the quantity of this transaction. Remember, each transaction's quantity is summed to provide a balance at a given point in time.	COST	
COST	Cost	Represents the cost of this transaction. Remember, each transaction's cost for an asset book is summed to provide a balance at a given point in time.	COST	Y
CURRENCY_CD	Currency Code	This field represents the transaction currency. This field is used to determine the currency conversion that will occur when populating each asset book, which may be in a different currency.	COST, RETIREMENT	Y

Field Name	Long Name	Use and Processing Considerations	Tables Updated	Required for Conversion
TRANSFER_BU	Transfer Business Unit	For an interunit asset transfer to transaction (transaction type='TRF' and Transaction in/out switch='I') this represents the business unit the asset was transferred from. For an interunit asset transfer from transaction (transaction type='TRF' and Transaction in/out switch='O') this represents the business unit the asset was transferred to.	COST	
TRANSFER_ASSET_ID	Transfer Asset ID	This field works just like the Transfer Business Unit, only it represents the asset ID used in the transfer transaction.	COST	
TRANSFER_BOOK	Transfer From Book	This field works just like the Transfer Business Unit, only it represents the book used in the transfer transaction.	COST	
OPRID	Operator ID	The operator ID that initiated this transaction.	COST, OPEN_TRANS	
FISCAL_YEAR	Fiscal Year	Represents the fiscal year in which the depreciation was taken. When converting depreciation you must identify the time period the depreciation covers. If converting an asset for which depreciation has been calculated through June 1997, then the fiscal year would be 1997, the start period would be 6 and the end period would be 6.	DEPRECIATION	Y if the asset has accumulated depreciation

Field Name	Long Name	Use and Processing Considerations	Tables Updated	Required for Conversion
START_PD	Start Period	Represents the start period for which the depreciation was taken. See the example above.	DEPRECIATION	Y if the asset has accumulated depreciation
END_PD	End Period	Represents the end period for which the depreciation was taken. See the example above.	DEPRECIATION	Y if the asset has accumulated depreciation
YTD_FLAG	Original Reserve	Set value to 'N' for Depreciation Amount that represents accumulated depreciation as of the conversion date. Default to 'Y' for other depreciation transactions.	DEPRECIATION	Y if the asset has accumulated depreciation
DEPR	Depreciation Amount	The depreciation amount of this transaction.	DEPRECIATION	Y if the asset has accumulated depreciation
DEPR_YTD	Year-to-Date Depreciation	Populate with Year To Date Depreciation	DEPRECIATION	Y if the depreciation method is Sum of Years, Declining Balance, Declining Balance with Switch to Straight line and you are doing a mid-year conversion.
RETIREMENT_DT	Retirement Date	The retirement date of the transaction. This field is used for retirement transactions only.	RETIREMENT	
RETIRE_CONVENTION	Retirement Convention	Represents the convention used for the retirement transaction. The convention is used to determine the end depreciation date for this asset book. This field is used for retirement transactions only.	RETIREMENT	

Field Name	Long Name	Use and Processing Considerations	Tables Updated	Required for Conversion
END_DEPR_DT	End Depreciation Date	The end depreciation date for this retirement transaction. This represents the date that depreciation will stop for this asset. The depreciation for that period is then prorated to determine the amount of accumulated depreciation being retired. This field is used for retirement transactions only.	RETIREMENT	
DISPOSAL_CODE	Disposal Code	Represents a memo field detailing the method that was used to dispose of this asset. The valid values for this field are in the translate table. This field is used for retirement transactions only.	RETIREMENT	
RETIREMENT_TYPE	Retirement Type	Represents whether this retirement transaction was ordinary or extraordinary according to U.S. Tax code. This field is used for retirement transactions only.	RETIREMENT	
RETIREMENT_STATUS	Retirement Status	Represents the status of the retirement transaction. The valid values are in the translate table. The initial value should be 'N' for a new retirement. This field is used for retirement transactions only.	RETIREMENT	

Field Name	Long Name	Use and Processing Considerations	Tables Updated	Required for Conversion
VOLUNTARY	Voluntary Conversion	Represents whether the retirement was voluntary or involuntary. This is required by U.S. tax code. The valid values are in the translate table. This field is used for retirement transactions only.	RETIREMENT	
TRADE_IN_ASSET_ID	Asset ID Bought with Trade In	Represents the asset ID that was bought using this asset as a trade-in. This field is only used for retirement transactions.	RETIREMENT	
TRADE_IN_DTTM_STMP	Trade In Date/Time Stamp	Represents the date/time stamp of the asset add transaction for the asset that was bought. This field is only used for retirement transactions.	RETIREMENT	
TRADE_IN_AMT	Trade In Amount	The amount received for the trade-in of an asset. This field is only used for retirement transactions.	RETIREMENT	
TRADE_IN_VALUE	Trade In value	To retire an asset by trading it for another asset.	RETIREMENT	Y
CASH	Cash Received/Paid	"Cash received in a like-kind exchange is taxable and is often referred to as "boot". "	RETIREMENT	Y
REFERENCE	Reference Code	A memo field that can be used to tie this retirement transaction to a reference document. This field is only used for retirement transactions.	RETIREMENT	

Field Name	Long Name	Use and Processing Considerations	Tables Updated	Required for Conversion
LIABILITY_ASSUMED	Liabilities Assumed	"If you are surrendering a building with a mortgage of USD 70,000 and acquiring a building with a mortgage of USD 30,000, you would enter 40,000 as the net liability. "	RETIREMENT	Y
NON_LIKE_KIND	FMV Non Like Kind Property	Fair Value for Non Like Kind Property.	RETIREMENT	Y
RETIRE_QUANTITY	Retirement Quantity	The quantify of the asset book being retired by this transaction. This field is only used for retirement transactions.	RETIREMENT	
RETIREMENT_AMT	Retirement Amount	The amount of cost for the asset book being retired by this transaction. This field is only used for retirement transactions.	RETIREMENT	
PROCEEDS	Retirement Proceeds	The proceeds received for this asset. This value is used in the depreciation calculation program to derive the gain/loss amount. This field is only used for retirement transactions.	RETIREMENT	
REMOVAL_COST	Removal Cost	The cost of removal for this asset. This value is used in the depreciation calculation program to derive the gain/loss amount. This field is only used for retirement transactions.	RETIREMENT	

Field Name	Long Name	Use and Processing Considerations	Tables Updated	Required for Conversion
RETIREMENT_RSV	Reserve Retired	The accumulated depreciation being retired by this transaction. This value is calculated by the depreciation calculation program. This field is only used for retirement transactions.	RETIREMENT	
GAIN_LOSS	Retirement Gain/Loss	The gain/loss amount for this retirement transaction. This value is calculated by the depreciation calculation program. This field is only used for retirement transactions.	RETIREMENT	
LEASE_REM_PAYMNTS	Lease Remaining Payments	The number of payments remaining at the time of the retirement. This field is calculated by the program AM_DEPR_CALC and does not have to be populated. This field is only used for retirement transactions.	RETIREMENT	
OPEN_TRANS_ID	Open Transaction ID	<p>The ID (key) for the OPEN_TRANS table. The OPEN_TRANS table is a "to do" list for several programs, such as AM_DEPR_CALC and AM_AMAEDIST. If this transaction requires processing by these programs, an entry is made to the OPEN_TRANS table.</p> <p>For performance reasons, this field should be populated for conversions. A single unique OPEN_TRANS_ID can be used for a group of the same transaction types, for example, CN1s.</p>	OPEN_TRANS	Y

Field Name	Long Name	Use and Processing Considerations	Tables Updated	Required for Conversion
CALC_DEPR_STATUS	Depreciation	<p>This field is used to determine whether depreciation needs to be calculated on this transaction. Only financial transactions need depreciation calculated. An open transaction (OPEN_TRANS) is created for those transactions that will have depreciation calculated. The OPEN_TRANS entry is then used by AM_DEPR_CALC as a "to do" list of transactions to process.</p> <p>Transaction Loader will populate this field. It can be left blank.</p> <hr/> <p>Note: Open Transactions are still generated for non-depreciable assets.</p>	OPEN_TRANS	
CALC_DIST_STATUS	Distribution	<p>This field is used to determine whether accounting entries need to be created for this transaction. Only financial transactions on a book marked for accounting entry creation need to have accounting entries created. An open transaction (OPEN_TRANS) is created for those transactions that will have accounting entries created. The OPEN_TRANS table entry is then used by AM_AMAEDIST as a "to do" list of transactions to process. Transaction Loader will populate this field. It can be left blank.</p>	OPEN_TRANS	

Field Name	Long Name	Use and Processing Considerations	Tables Updated	Required for Conversion
MESSAGE_SET_NBR	Message Set Number	Used for internal processing. Do not populate.	Internal Use	
MESSAGE_NBR	Message Number	Used for internal processing. Do not populate.	Internal Use	
BUSINESS_UNIT_JV	Joint Venture Business Unit	The parent JV business unit if the asset is part of a joint venture.	Internal Use	
LIFE_END_DT	Useful Life End Date	This field represents the end date of the useful life on the asset book. This field can be used as an alternate to the life field. Life and life end date are mutually exclusive. When you specify the life end date, the depreciation calculation program will calculate the life field and store it on the BOOK table.	BOOK	
DEPR_LOW_LIMIT	Depreciation Low Limit Amount	This field represents the low amount that net book value must reach before an asset stops depreciating. This field is only used by the declining balance depreciation method. Since the declining balance method does not use a life, the low limit is the way to specify when an asset should become fully reserved.	BOOK	
SUSPEND_STATUS	Suspend Status	Indicates whether the book is currently "mothballed". Default value for this field is blank. If the book is "mothballed", enter a value of 'Y' in this field.	BOOK	

Field Name	Long Name	Use and Processing Considerations	Tables Updated	Required for Conversion
SUSPEND_DT	Suspend Date	The date that depreciation was suspended.	BOOK	
RESUME_DT	Resume Date	The date that depreciation was resumed after a suspension.	BOOK	
SUSPENDED_PERIODS	Number of Suspended Periods	The number of periods that depreciation was suspended for.	BOOK	
COST_BASIS_LIMIT	Cost Basis Limit	The maximum amount that can be capitalized for this asset book.	BOOK	
DEPR_AVG_OPTION	Averaging Option	A special option that applies only to the flat rate depreciation method. Valid values are 'M' (Monthly), 'Y' (Yearly), or 'N' (None). If you're doing a conversion (CN1), you must set this field to a value, no matter what depreciation method you're using.	BOOK	Y default N
UOP_ID	Units of Production ID	Represents the ID of the Units of Production control table that specifies the units of production for this asset book.	BOOK	
IU_MAP_KEY	InterUnit Map Key	Used for InterUnit transfers.	Appears on COST.	
MC_DEFN_ID	Mass Change ID	Used for internal processing. Do not populate.	Internal Use	
GROUP_ASSET_ID	Group Asset ID	Used to identify which group asset group members report to.	BOOK, COST, DEPRECIATION, OPEN_TRANS	

Field Name	Long Name	Use and Processing Considerations	Tables Updated	Required for Conversion
UD_METHOD_ID	Method ID	Identifies the user-defined depreciation method to be used. This field must reference a valid user-defined depreciation method. The user defined methods are specified in the Establish Asset Processing window.	BOOK	Y for depreciation method user-defined
INCLUDE_CAP_GAINS	CGT Applicable	A flag which determines whether or not capital gains tax should be included in the gain/loss of a book. The INCLUDE_CAP_GAINS is for Australian customers.	BOOK	
REDUCED_COST	Reduced Cost Basis	Amount used in calculating gain/loss for Australian Customers.	RETIREMENT	
CAPITAL_G_L	Capital Gains and Loss	Amount used in calculating gain/loss for Australian Customers.	RETIREMENT	
RET_NON_CAP_AMT2	Non-Capitalized CGT amount.	Amount used in calculating gain/loss for Australian Customers.	RETIREMENT	
AM_BK_UD_CHAR1	User-Defined character field		BOOK	
AM_BK_UD_CHAR2	User-Defined character field		BOOK	
AM_BK_UD_DATE1	User-Defined date field		BOOK	
AM_BK_UD_NUM1	User-Defined numeric field		BOOK	
AM_BK_UD_NUM2	User-Defined numeric field		BOOK	

Field Name	Long Name	Use and Processing Considerations	Tables Updated	Required for Conversion
INCREASE_RATE	Increased Rate	Used to calculate special depreciation amount. You can enter a rate and the standard depreciation will be modified by this percentage along all the life of the asset. This rate is required for Japanese calculations but can be used for any country.	BOOK	
FULLY_DEPR_SW	Retire as Fully Depreciated	Used to retire assets as fully depreciated.	RETIREMENT	
ACCOUNTING_MTHD	Accounting Method	Supports 3 different accounting methods in Japan. In Expense method, the standard depreciation is modified with the special depreciation. The accounting entries in this method have standard + special depreciation in the same accounts. In Allowance and Reserve Method, the information must be in separate accounts.	BOOK	
FUTURE_DEPR_YEARS	Number of Future Depreciation Years	Number of future years of depreciation to create when AM_DEPR_CALC runs. For example: if value was 3 and accounting fiscal year is 2000, AM_DEPR_CALC will create years: 2000, 2001 and 2002. If left zero, AM_DEPR_CALC will create all years of the life of the asset.	BOOK	

Field Name	Long Name	Use and Processing Considerations	Tables Updated	Required for Conversion
SALVAGE_VAL	Salvage Value	Used to populate an absolute amount in COST.SALVAGE_VALUE by Book on future transactions – used only when default profile switch = No	BOOK	
SALVAGE_PCT	Salvage Percent	Used to calculate COST.SALVAGE_VALUE as a percentage of the cost by asset book on future transactions - used only when default profile switch = No	BOOK	
AUTO_RETIRED_SW	Auto-Retired Fully Depreciated	Internal	RETIREMENT	
RATE_DIV	Rate Divisor	Currency Conversion	RETIREMENT, COST, DEPRECIATION	Y
RATE_DIV_2	Rate Divisor	Currency Conversion	RETIREMENT, COST, DEPRECIATION	Y
RATE_MULT	Rate Multiplier	Currency Conversion	RETIREMENT, COST, DEPRECIATION	Y
RATE_MULT_2	Rate Multiplier	Currency Conversion	RETIREMENT, COST, DEPRECIATION	Y
RT_EFFDT	Rate Effective Date	Currency Conversion	RETIREMENT, COST, DEPRECIATION	Y
RT_TYPE	Rate Type	Currency Conversion	RETIREMENT, COST, DEPRECIATION	Y
BILL_TO_CUST_ID	Customer	Bill to Information.	RETIREMENT	Y
ADDRESS_SEQ_NUM	Address Sequence Number	Bill to Information.	RETIREMENT	Y
SHIP_TO_CUST_ID	Ship To Customer	Ship to Information.	RETIREMENT	Y

Field Name	Long Name	Use and Processing Considerations	Tables Updated	Required for Conversion
SHIP_TO_ADDR_NUM	Ship To Address Sequence Num	Ship to Information.	RETIREMENT	Y
SHIP_FROM_LOC	Ship From Location	Ship to Information.	RETIREMENT	Y
SOLD_TO_CUST_ID	Sold To Customer	Sold to Information.	RETIREMENT	Y
SOLD_TO_ADDR_NUM	Sold To Address Sequence Num	Sold to Information.	RETIREMENT	Y
BILL_SOURCE_ID	Bill Source	Billing Source.	AMBI_INTFC_BILL	Y
TOT_OBLIGATION	Lease Total Obligation	Leasing Obligation.	BOOK	Y
TXN_CASH	Transaction Cash	Cash in transaction currency.	COST	Y
TXN_COST	Transaction Cost	Cost in transaction currency.	COST	Y
TXN_CURRENCY_CD	Transaction Currency	Transaction Currency.	COST	Y
TXN_CURRENCY_CD2	Transaction Currency Display	Transaction Currency.	COST	Y
TXN_LIAB_ASSUMED	Transaction Liability Assumed	Liab Assumed in transaction currency.	RETIREMENT	Y
TXN_NON_LIKE_KIND	FV Non Like-Kind	Non Like Kind in transaction currency.	RETIREMENT	Y
TXN_PROCEEDS	Transaction Proceeds	Used to populate an amount for Billing - Asset Management transactions.		
TXN_REMOVAL_COST	Transaction Removal Cost	Removal Cost in transaction currency.	RETIREMENT	Y
TXN_TRADE_IN_VALUE	Transaction Trade-In Value	Trade in value in transaction currency.	RETIREMENT	Y

Field Name	Long Name	Use and Processing Considerations	Tables Updated	Required for Conversion
DEPR_BONUS_SW	Depreciation Bonus	Depreciation Bonus Switch for Depreciation Calculation.	BOOK	Y
DEPR_BONUS_PCT	Depreciation Bonus Percent	Depreciation Bonus Percentage for Depreciation Calculation.	BOOK	Y
PROCESS_INSTANCE	Process Instance	Internal field / Informational.		
SPECIAL_DEPR_SW	Special Depreciation	Depreciation Calculation.	BOOK	Y
ACCELERATED_TERMS	Accelerated Terms	Depreciation Calculation.	BOOK	Y
INITIAL_TERMS	Initial Terms	Depreciation Calculation.	BOOK	Y
SPECIAL_TERMS	Special Terms	Depreciation Calculation.	BOOK	Y
YEAR_CHANGE	Year of Change	Depreciation Calculation.	BOOK	Y
LIFE_IN_YRS	Life in Years	Depreciation Calculation.	BOOK	Y
MULTI_SHIFT_CODE	Multi-Shift Code	Depreciation Calculation.	BOOK	Y
MULTI_SHIFT_NBR	Shift Factor Number	Depreciation Calculation.	BOOK	Y
DEPR_LIMIT_PCT	Depreciation Limit Percent	Depreciation Calculation.	BOOK	Y
DEPR_PASS_LIFE_SW	Depreciate Pass Life SW	Depreciation Calculation.	BOOK	Y
DEROGATORY_SW	Derogatory Depreciation	Depreciation Calculation.	BOOK	Y

Field Name	Long Name	Use and Processing Considerations	Tables Updated	Required for Conversion
ACCEL_DEPR	Accelerated Depreciation	Depreciation Calculation.	BOOK	Y
INCREASE_DEPR	Increased Depreciation	Depreciation Calculation.	BOOK	Y
INITIAL_DEPR	Initial Depreciation	Depreciation Calculation.	BOOK	Y
SPEC_DEPR	Special Depreciation	Depreciation Calculation.	BOOK	Y
STANDARD_DEPR	Standard Depreciation	Depreciation Calculation.	BOOK	Y
IMPAIR_FLG	Impairment Process	Impairment Processing Switch.	BOOK	Y
CC_FLAG	Component Changeout Old/New	Internal Use		
ADJUST_CONVENTION	Adjust Convention	Adjustment transaction convention populated with values from the CONV_TBL table.	BOOK, COST	
CAPVAL_VALUE	Capitalization Value	Internal Use. The Capitalization Threshold Validation process populates this field. The value is used by the system to validate whether the asset still meets the conditions to remain at the status in which it was originally catalogued when it was added. Adjusting the original cost can make an asset fall into a different bracket and, therefore, the asset needs to be recategorized to a different capitalization status.		

Loader Table INTFC_PHY_A

The PeopleSoft platform limits the maximum number of columns allowed in a table. Because of this limitation, PeopleSoft created two physical interface tables. INTFC_PHY_A contains the most frequently used physical interface fields, and INTFC_PHY_B contains the least frequently used physical interface fields.

The following table describes the information contained in Loader Table INTFC_PHY_A:

Field Name	Long Name	Use and Processing Considerations	Tables Updated	Required for Conversion
INTFC_ID	Interface ID	<p>Key to this table. An interface ID is typically assigned to a group of transactions with the same load type.</p> <p>Use a unique, previously unused INTFC_ID for each set of transactions with the same load type.</p> <p>When using a load type of CN1 and NEXT in the ASSET_ID field, you'll need to use a unique INTFC_ID for each asset.</p> <p>For FADs and Conversions, if INTFC_ID is the same for multiple lines for an asset, increment the INTFC_LINE_NUM for each line.</p>	Internal use	Y

Field Name	Long Name	Use and Processing Considerations	Tables Updated	Required for Conversion
INTFC_LINE_NUM	Interface Line Number	<p>The key to this table. Interface Line Number is used as a key for multiple lines for the same Interface ID for transactions with similar keys (for example, multiple acquisition details such as CAP).</p> <p>For FADs and Conversions, if INTFC_ID is the same for multiple lines for an asset, increment the INTFC_LINE_NUM for each line.</p>	Internal use	Y
BUSINESS_UNIT	Business Unit	The business unit that identifies the asset to be processed. This field is required	ASSET, ASSET_ACQ_DET, ASSET_CUSTODIAN, ASSET_LOCATION, PARENT_ASSET	Y
ASSET_ID	Asset Identification	The asset ID that identifies the asset to be processed. This field is required. If this field contains the value NEXT and the interface type is FAD or CN1, then the Transaction Loader will assign the next asset ID for this business unit.	ASSET, ASSET_ACQ_DET, ASSET_CUSTODIAN, ASSET_LOCATION, and many others	Y
ASSET_TYPE	Asset Type	Asset classification.	ASSET	Y
ASSET_SUBTYPE	Asset Subtype	Asset classification.	ASSET	Y
DTTM_STAMP	Date/Time Stamp	Populates the key field of datetime stamp in many tables. Represents the date and time that this transaction was added to the system. During conversion, this field represents the period through which depreciation has been calculated.		Y

Field Name	Long Name	Use and Processing Considerations	Tables Updated	Required for Conversion
VOUCHER_ID	Voucher ID	Identifies the voucher associated with the financial transaction. This value is used in AP integration. This field can be used for PeopleSoft or non-PeopleSoft integrations. This field enables INTFC_FIN transactions to be easily queried by voucher. This value should be formatted if the transaction is voucher related.	Internal use ASSET_ACQ_DET	
VOUCHER_LINE_NUM	Voucher Line Number	Identifies the voucher line number associated with the financial transaction, which is used in AP integration. This field can be used for PeopleSoft or non-PeopleSoft integrations.	Internal use ASSET_ACQ_DET	
DISTRIB_LINE_NUM	Distribution Line Number	Identifies the voucher line distribution number associated with the financial transaction, which is used in AP integration. This field can be used for PeopleSoft or non-PeopleSoft integrations.	Internal use ASSET_ACQ_DET	
INTFC_TYPE	Interface Type, also called Load Type	Identifies the type of this transaction. The Transaction Loader will process this transaction based on this field. Valid values are listed in the translate table.	Internal use	Y
MC_DEFN_ID	Mass Change ID	Used for internal processing. Do not populate.	Internal use	

Field Name	Long Name	Use and Processing Considerations	Tables Updated	Required for Conversion
SYSTEM_SOURCE	System Source	The source system that created this transaction. Valid values are listed in the translate table. This field is used extensively by Asset Management to drill back to source system. You can add valid values to the translate table for your external systems. You can run the Transaction Loader selectively for specific values of system source.	ASSET_ACQ_DET	Y default CNV
APPROVAL_SW	Auto Approval Status	Identifies whether the transaction is approved or not. The Transaction Loader will only load approved transactions. Valid values are Y for approved and N for not approved.	Internal use	Y
INTFC_STATUS	Interface Status	Used for internal processing. The default for this field is DON.	Internal use	Y default DON
LOAD_STATUS	Load Status	Identifies the status of this transaction. Valid values are 'NEW' (not processed), 'ERR' (an error exists on this transaction and it will not be processed), 'DON' (the transaction was successfully processed), CON (the transaction was consolidated into a different transaction and it will not be loaded), UNI (the transaction was unitized into a different transaction and it will not be loaded).	Internal use	Y default NEW
ORIG_INTFC_ID	Original Interface ID	Used for internal processing. Do not populate.	Internal use	

Field Name	Long Name	Use and Processing Considerations	Tables Updated	Required for Conversion
ORIG_LINE_NUM	Original Interface Line Number	Used for internal processing. Do not populate.	Internal use	
DEFAULT_PROFILE_SW	Default Books from Profile	<p>Identifies whether a profile will be used for an asset add by the Transaction Loader.</p> <p>When this switch is set to 'Y,' the BOOK table will be populated by default from the profile tables rather than the load tables (INTFC...). The category in the cost table will also be populated by default from the profile tables.</p> <p>The profile_ID is identified in the INTFC_PHY_A table.</p> <p>When performing a CN1, you must set the DEFAULT_PROFILE_SW to 'N'.</p> <p>The value of DEFAULT_PROFILE_SW in INTFC_FIN must match the value of DEFAULT_PROFILE_SW in INTFC_PHY_A.</p>	Internal use	Y (Set = N for CN1)
TRANS_IN_OUT	Transaction In/Out	<p>Identifies which side of a transfer or recategorization this transaction represents. Every such transaction contains two transactions.</p> <p>The outside of the transaction adjusts the asset being transferred or recategorized <i>from</i>.</p> <p>The inside of the transaction adjusts the asset being transferred/ recategorized <i>to</i>.</p>	Internal use	

Field Name	Long Name	Use and Processing Considerations	Tables Updated	Required for Conversion
PARENT_ID	Parent Asset ID	Identifies the parent of this asset. You can build Parent/Child relationships using the Parent ID. A parent can be an existing asset (the parent ID is the asset ID of another asset) or a virtual asset (the parent ID is not an actual asset ID). The parent ID should always be a valid entry in the record Parent_Asset. If an entry does not exist in Parent_Asset for the parent ID, then the Transaction Loader will create one.	ASSET, PARENT_ASSET	
PARENT_DESCR	Parent Asset Description	Describes the parent asset that will be entered on the table parent_asset if an entry does not exist.	PARENT_ASSET	
PARENT_DESCRLONG50	Parent Asset Long Description	Indicates the long description of the parent asset that will be entered on the table parent_asset if an entry does not exist.	PARENT_ASSET	
COMPONENT_OF_ID	Component of Asset	Establishes the Asset Components structure.	ASSET	Y
ASSET_ASSIGNED_TO	Asset Assigned To		ASSET	Y
TAGGABLE_SW	Taggable Asset Switch	Indicates whether the asset is taggable or not. Valid values are Y or N. A tag is the physical tag that is affixed to an asset.	ASSET	
TAG_NUMBER	Tag Number	The tag number that is assigned to this asset.	ASSET	
DESCR	Description	Provides a 30-character description of the asset.	ASSET	

Field Name	Long Name	Use and Processing Considerations	Tables Updated	Required for Conversion
DESCRSHORT	Short Description	Provides a 10-character (short) description of the asset.	ASSET	
ASSET_STATUS	Asset Status	Indicates the status of the asset. The valid values are in the translate table. This field is generally for information purposes only. No accounting events are tied to this status.	ASSET	Y default to I (in service)
FINANCIAL_ASSET_SW	Capitalized Asset	Identifies whether this asset has been capitalized. Valid values are 'Y' for yes and 'N' for no. If an asset has not been capitalized, the asset can have no financial information or transactions, such as BOOK, COST, DEPRECIATION, RETIREMENT, OPEN_TRANS, and so on. However, it can have acquisition detail information (ASSET_ACQ_DET). Since acquisition detail is not tied to accounting events—it is an audit trail—you can store as much expense information as you like.	ASSET	Y
REPLACE_SW	Replacement Asset	Identifies whether this is a replacement asset.	ASSET	
REPLACE_ASSET_ID	Replaced Asset ID	If this is a replacement asset, identifies the Asset ID of the asset that was replaced.	ASSET	

Field Name	Long Name	Use and Processing Considerations	Tables Updated	Required for Conversion
CONVERSION_ID	Old Asset ID	Identifies the ID in an old system for this asset. PeopleSoft recommends that you do not try to convert your Asset IDs from your old system to Asset Management. Since Asset ID is only an internal key to this system, you should let Asset Management assign Asset IDs to your assets. Then, you can store the ID from the old system in this field.	ASSET	
NEW_ASSET_SW	New Asset	Indicates if this asset was acquired new. Valid values are 'Y' or 'N'.	ASSET	Y
AVAIL_SW	Asset is Available	Indicates if this asset is available for resale. Valid values are 'Y' or 'N'. When marked 'Y' this field can be queried to identify assets that are not being used by their custodians and are available for resale or internal transfer. A PS/Query is shipped with Asset Management as an example.	ASSET	Y
AVAIL_CONTACT	Availability Contact	Indicates who should be contacted if the asset is available and if someone is interested in it.	ASSET	
AVAIL_PHONE	Availability Phone	Indicates the phone number of the Availability Contact.	ASSET	
ACQUISITION_CD	Acquisition Code	Identifies how this asset was acquired. The valid values are in the translate table.	ASSET	

Field Name	Long Name	Use and Processing Considerations	Tables Updated	Required for Conversion
ACQUISITION_DT	Acquisition Date	Identifies the acquisition date of this asset. This field is memo-only and is not used for any calculations.	ASSET	Y
FINANCING_CD	Financing Code	Identifies the user-defined financing code. Should be a valid value in the FINANCE_CD_TBL.	ASSET	
ASSET_DTTM_STAMP	Asset Date/Time Stamp	Used for internal processing. Do not populate.	Internal use	
PROFILE_ID	Asset Profile ID	Identifies the profile to be used for providing default book information for an asset add. This field is only used if the INTFC_FIN_DEFAULT_PROFILE_SW = 'Y'. When that field is set to Y, then Profile ID must be populated with a valid, effective-dated Profile ID in the PROFILE_DET_TBL.	ASSET	Y
ASSET_CLASS	Asset Class	Identifies the asset class of this asset. This field is another way to categorize your assets. This field must be a valid value in the ASSET_CLASS_TBL, which is maintained in the Establish Asset Processing menu online.	ASSET	

Field Name	Long Name	Use and Processing Considerations	Tables Updated	Required for Conversion
CAP_NUM	Capital Acquisition Plan Number	Combined with CAP_SEQUENCE, this field identifies the Capital Acquisition Planning (C.A.P.) with which this asset is associated. C.A.P. is a way of specifying asset budgets or appropriations.	ASSET	
MFG_ID	Manufacturer ID	Identifies the Manufacturer ID of the asset.	ASSET	Y
MANUFACTURER	Manufacturer Name	Identifies the manufacturer of the asset.	ASSET	
MODEL	Model	Identifies the model of the asset.	ASSET	
PROD_VERSION	Product Version	Identifies the product version of the asset.	ASSET	
SERIAL_ID	Serial ID	Identifies the serial number of the asset.	ASSET	
PRODUCTION_DT	Production Date	Identifies the production date of the asset.	ASSET	
PLANT	Manufacturing Plant	Identifies the plant that manufactured the asset.	ASSET	
MANUFACTUR_CONTACT	Manufacturing Contact	Identifies the contact at the plant that manufactured the asset.	ASSET	
CAP_SEQUENCE	C.A.P. Sequence	Combined with CAP_NUM, this field identifies the C.A.P. with which this asset is associated. C.A.P. is a way of specifying asset budgets or appropriations.	ASSET	

Field Name	Long Name	Use and Processing Considerations	Tables Updated	Required for Conversion
REPLACEMENT_COST	Replacement Cost	Identifies the estimated replacement cost of the asset. This field can be processed by the Indexing feature in Asset Management. The indexing feature only updates replacement cost. It does not populate this field initially.	ASSET	
LEASE_ASSET_ID	Lease Asset ID	For a non capitalized asset that is associated with a lease, indicates the Asset ID of that lease. This field must identify a capitalized asset ID with an acquisition code of leased.	ASSET	
BUSINESS_UNIT_JV	Joint Venture Business Unit	Identifies the parent JV business unit if the asset is part of a joint venture.	Used internally	
INDEX_NAME	Index Name	Identifies which index to use in revaluing asset cost.	ASSET	
INDEX_DETAIL_NAME	Index Detail Name	Same as INDEX_NAME.	ASSET	
LAST_INDEX_VALUE	Last Index Value	Identifies the last index value used to revalue assets, such as the Consumer Price Index.	ASSET	Y
COMPOSITE_SW	Composite Asset	Indicates whether the asset is a composite asset. Although similar to parent/child assets, composite assets are not virtual assets. A composite asset exists as a standard asset record within the Asset Management system.	ASSET	

Field Name	Long Name	Use and Processing Considerations	Tables Updated	Required for Conversion
COMPOSITE_ID	Composite Asset ID	If applicable, enter the Asset ID of the composite asset that is associated with this asset record.	ASSET	
FERC_CD	FERC Code	Identifies the FERC code associated with this asset. The valid values must be set up on the FERC Code table before implementation. PeopleSoft ships a 'MODEL' set of FERC codes with the system that can be shared by your business units.	ASSET	
SEQUENCE_NBR_6	Sequence	Sequences the acquisition detail table. This field must be incremented for each acquisition detail row for an asset. The Transaction Loader does not increment this field, its value must be assigned correctly in the INTFC_PHY_A table. Therefore, the feeder system must set this field. For the Payables and Purchasing interface, this field is set by AMPS1000. <hr/> Note: The value of this field should be zero for ADD rows. <hr/>	ASSET_ACQ_DET	
ACQUISITION_DESCR	DESCR field for ACQ_DETAIL	Describes the acquisition detail for this transaction.	ASSET_ACQ_DET	

Field Name	Long Name	Use and Processing Considerations	Tables Updated	Required for Conversion
CAPITALIZATION_SW	Capitalized	Identifies whether this particular transaction should be capitalized. Valid values are in the translate table. This value must be set to 1, 2, 3, or 4 in order for acquisition detail records to be inserted.	ASSET_ACQ_DET	Y
BUSINESS_UNIT_AP	AP Business Unit	Identifies the business unit from Accounts Payable that generated this transactions.	ASSET_ACQ_DET	
TXN_CURRENCY_CD	Transaction Currency	Identifies the transaction Currency Code	ASSET_ACQ_DET	Y
CURRENCY_CD	Currency Code	Represents the currency of the transaction.	ASSET_ACQ_DET	Y
RATE_DIV	Rate Divisor	Identifies the currency conversion rate divisor.	ASSET_ACQ_DET	Y
RATE_MULT	Rate Multiplier	Identifies the currency conversion rate multiplier.	ASSET_ACQ_DET	Y
RT_TYPE	Rate Type	Identifies the currency conversion rate type.	ASSET_ACQ_DET	Y
BUSINESS_UNIT_PO	PO Business Unit	Identifies the business unit from Purchasing that is associated with this transaction.	ASSET_ACQ_DET	
PO_ID	Purchase Order Number	Identifies the PO number from Purchasing that is associated with this transaction.	ASSET_ACQ_DET	
PO_LINE_NBR	Purchase Order Line Number	Identifies the PO line number from Purchasing that is associated with this transaction.	ASSET_ACQ_DET	

Field Name	Long Name	Use and Processing Considerations	Tables Updated	Required for Conversion
SCHED_NBR	Schedule Number	Identifies the schedule number from Purchasing that is associated with this transaction.	ASSET_ACQ_DET	
PO_DIST_LINE_NUM	PO Distribution Line Number	Identifies the distribution line number from Purchasing that is associated with this transaction.	ASSET_ACQ_DET	
REFERENCE_ID	Reference Number	Identifies a general reference number associated with the acquisition of this asset.	ASSET_ACQ_DET	
INVOICE_DT	Invoice Date	Represents the date of the invoice associated with this transaction.	ASSET_ACQ_DET	
VENDOR_ID	Vendor ID	Identifies the vendor ID from Accounts Payable or Purchasing that is associated with this transaction.	ASSET_ACQ_DET	
VENDOR_NAME	Vendor Name	Identifies the name of the vendor associated with this transaction. This field is used only when an external purchasing or payable system is used.	ASSET_ACQ_DET	
INVOICE_ID	Invoice Number	Identifies the invoice number of the invoice associated with this transaction.	ASSET_ACQ_DET	
TXN_AMOUNT	Transaction Amount	Identifies the amount in the transaction currency.	ASSET_ACQ_DET	

Field Name	Long Name	Use and Processing Considerations	Tables Updated	Required for Conversion
AMOUNT	Amount	Identifies the amount of this transaction. This amount will be capitalized if capitalization is requested. The Transaction Loader does not use this field for inserting cost. It uses the amount field on Acq Detail. The AMOUNT field should match the COST field on INTFC_FIN.	ASSET_ACQ_DET	Y
QUANTITY	Quantity	Identifies the quantity of this transaction. This quantity will be capitalized if capitalization was requested. The Transaction Loader does not use this field for inserting cost. It uses the quantity field on Acq Detail. The QUANTITY field should match the QUANTITY field on INTFC_FIN.	ASSET_ACQ_DET	
SALETX_AMT	Sales Tax Distribution Amount	Identifies the amount of sales tax associated with this transaction.	ASSET_ACQ_DET	
SALETX_AMT_BSE	Base Sales Tax Amount	Identifies the Sale Tax Amount in the transaction currency	ASSET_ACQ_DET	
SALETX_CD	Sales Tax Code	Identifies the code representing the sales taxing authority associated with this transaction.	ASSET_ACQ_DET	
USETAX_AMT	Use Tax Distribution Amount	Identifies the amount of use tax associated with this transaction.	ASSET_ACQ_DET	
USETAX_AMT_BSE	Base Use Tax Amount	Identifies the Use Tax Amount in the transaction currency.	ASSET_ACQ_DET	

Field Name	Long Name	Use and Processing Considerations	Tables Updated	Required for Conversion
USETAX_CD	Use Tax Code	Identifies the code that represents the use taxing authority associated with this transaction.	ASSET_ACQ_DET	
FREIGHT_AMT	Freight Amount	Identifies the amount of freight associated with this transaction.	ASSET_ACQ_DET	
FREIGHT_AMT_BSE	Base Freight Amount	Identifies the Freight Amount in the transaction currency.	ASSET_ACQ_DET	
BUSINESS_UNIT_RECV	Business Unit Receive	Identifies the Purchasing receiving business unit with which this transaction is associated.	ASSET_ACQ_DET	
RECEIVER_ID	Receiver ID	Identifies the Purchasing receiving receiver ID with which this transaction is associated with.	ASSET_ACQ_DET	
RECV_LN_NBR	Receiver Line Number	Identifies the Purchasing receiving line number with which this transaction is associated.	ASSET_ACQ_DET	
RECV_SHIP_SEQ_NBR	Receiver Shipping Sequence Number	Identifies the Purchasing receiving shipping sequence number with which this transaction is associated.	ASSET_ACQ_DET	
RECV_DIST_LINE_NUM	Receiver Distribution Line Number	Identifies the Purchasing receiving distribution line number with which this transaction is associated.	ASSET_ACQ_DET	

Field Name	Long Name	Use and Processing Considerations	Tables Updated	Required for Conversion
DISTRIB_SEQ_NUM	Distribution Sequence Number	Identifies the Purchasing receiving distribution sequence number with which this transaction is associated.	ASSET_ACQ_DET	
INV_ITEM_ID	Inventory Item ID	Identifies the inventory item ID with which this transaction is associated.	ASSET_ACQ_DET	
OPERATING_UNIT	Operating Unit	Identifies the operating unit (ChartField) associated with this transaction. This field should be the same as the corresponding ChartField in the INTFC_FIN table. See the online ChartField customization topic for further discussion.	ASSET_ACQ_DET	
DEPTID	Department	Identifies the department (ChartField) associated with this transaction. This field should be the same as the corresponding ChartField on the INTFC_FIN table.	ASSET_ACQ_DET	
PRODUCT	Product	Identifies the product (ChartField) associated with this transaction. This field should be the same as the corresponding ChartField on the INTFC_FIN table.	ASSET_ACQ_DET	
FUND_CODE	Fund Code	Identifies a customizable ChartField. See the online ChartField customization topic for further discussion.	ASSET_ACQ_DET	Y

Field Name	Long Name	Use and Processing Considerations	Tables Updated	Required for Conversion
CLASS_FLD	Class Field	Identifies a customizable ChartField. See the online ChartField customization topic for further discussion.	ASSET_ACQ_DET	Y
PROGRAM_CODE	Program Code	Identifies a customizable ChartField. See the online ChartField customization topic for further discussion.	ASSET_ACQ_DET	Y
BUDGET_REF	Budget Reference	Identifies a customizable ChartField. See the online ChartField customization topic for further discussion.	ASSET_ACQ_DET	Y
AFFILIATE	Affiliate	Identifies a customizable ChartField. See the online ChartField customization topic for further discussion.	ASSET_ACQ_DET	Y
AFFILIATE_INTRA1	Fund Affiliate	Identifies a customizable ChartField. See the online ChartField customization topic for further discussion.	ASSET_ACQ_DET	Y
AFFILIATE_INTRA2	Operating Unit Affiliate	Identifies a customizable ChartField. See the online ChartField customization topic for further discussion.	ASSET_ACQ_DET	Y
CHARTFIELD1	ChartField 1	Identifies a customizable ChartField. See the online ChartField customization topic for further discussion.	ASSET_ACQ_DET	Y

Field Name	Long Name	Use and Processing Considerations	Tables Updated	Required for Conversion
CHARTFIELD2	ChartField 2	Identifies a customizable ChartField. See the online ChartField customization topic for further discussion.	ASSET_ACQ_DET	Y
CHARTFIELD3	ChartField 3	Identifies a customizable ChartField. See the online ChartField customization topic for further discussion.	ASSET_ACQ_DET	Y
PROJECT_ID	Project ID	Identifies the project (ChartField) associated with this transaction This field should be the same as the corresponding ChartField on the INTFC_FIN table.	ASSET_ACQ_DET	
CATEGORY	Asset Category	Identifies the category associated with this transaction. This field should be the same as the category on the INTFC_FIN table.	ASSET_ACQ_DET	Y
COST_TYPE	Cost Type	Identifies the cost type associated with this transaction. This field should be the same as the cost type on the INTFC_FIN table.	ASSET_ACQ_DET	
BUSINESS_UNIT_PC	Projects Business Unit	Identifies the business unit in Projects that generated this asset transaction. This value can also come from the Purchasing/Payables integration.	ASSET_ACQ_DET	
MASTER_PROJECT	Master Project	Identifies the master project in Projects that generated this asset transaction.	ASSET_ACQ_DET	

Field Name	Long Name	Use and Processing Considerations	Tables Updated	Required for Conversion
ACTIVITY_ID	Activity ID	Identifies the activity ID in Projects that generated this asset transaction. This value can also come from the Purchasing/Payables integration.	ASSET_ACQ_DET	
RESOURCE_TYPE	Resource Type	Identifies the resource type in Projects that generated this asset transaction. This value can also come from the Purchasing/Payables integration.	ASSET_ACQ_DET	
RESOURCE_SUB_CAT	Resource subcategory	Identifies the resource subcategory from Projects, Purchasing or Payables.	ASSET_ACQ_DET	
ANALYSIS_TYPE	Resource Analysis type	Identifies the resource analysis type in Projects that generated this asset transaction. This value can also come from the Purchasing/Payables integration.	ASSET_ACQ_DET	
RESOURCE_CATEGORY	Resource category	Identifies the resource category in Projects that generated this asset transaction. This value can also come from the Purchasing/Payables integration.	ASSET_ACQ_DET	

Field Name	Long Name	Use and Processing Considerations	Tables Updated	Required for Conversion
CUSTODIAN_EFFDT	Asset Custodian Effective Date	Identifies the date the custodian of this asset became effective. If the transaction is an add, the date should be the same as the trans_dt. This field must be formatted with a valid date on an add transaction, whether or not the custodian is known. The Transaction Loader uses this value when inserting custodian entries. If it is null, no custodian entry is loaded.	ASSET_CUSTODIAN	Y
EFFSEQ	Effective Sequence	Identifies the sequence number of the custodian. This value will be zero unless the asset has had more than one custodian for a given effective date.	ASSET_CUSTODIAN	
CUSTODIAN	Custodian	Identifies the name of the custodian of this asset.	ASSET_CUSTODIAN	
EMPLID	Asset Custodian Employee ID	Identifies the employee ID of the custodian of this asset.	ASSET_CUSTODIAN	
CUSTODIAN_DEPTID	Asset Custodian Department	Identifies the department of the custodian of this asset.	ASSET_CUSTODIAN	
CUSTODIAN_PROJECT	Asset Custodian Project	Identifies the project associated with the custodian of this asset.	ASSET_CUSTODIAN	
OFFSITE_SW	This Asset is Offsite	Is this asset offsite? Valid values are 'Y' or 'N'.	ASSET_CUSTODIAN	
AUTH_STATUS	Authorization Status	The status of the authorization for this asset to be assigned to this custodian.	ASSET_CUSTODIAN	

Field Name	Long Name	Use and Processing Considerations	Tables Updated	Required for Conversion
AUTHORIZATION_NAME	Authorization Name	The name of the person will has authorized this asset to be assigned to this custodian.	ASSET_CUSTODIAN	
AUTHORIZATION_DT	Authorization Date	The date of the authorization for this asset to be assigned to this custodian.	ASSET_CUSTODIAN	
LOCATION_EFFDT	Location Effective Date	The date the location of this asset became effective. If the transaction is an add, the date should be the same as the trans_dt. This field must be formatted with a valid date on an add transaction, whether or not the location is known. Transaction loader uses this when inserting location entries. If it is null, a location entry is not loaded.	ASSET_LOCATION	Y
LOCATION_EFFSEQ	Location Effective Sequence	The sequence number of the location. This will be zero unless the asset has been in more than one location for a given effective date.	ASSET_LOCATION	
LOCATION	Location	The location of this asset. Should be a valid value on the LOCATION_TBL.	PI_ASSET_HIST	
PI_ID	Physical Inventory ID	Used for internal processing. Do not populate. The physical inventory ID that was entered when defining physical inventory is used here.	ASSET_LOCATION	
INVENTORY_DT	Last Inventory Date	The last date that this asset was inventoried at this location.	PI_ASSET_HIST	

Field Name	Long Name	Use and Processing Considerations	Tables Updated	Required for Conversion
PERFORMED_BY	Performed By	The name of the person who performed the last inventory.	PI_ASSET_HIST	
DOCUMENT_ID	Document	A reference document ID associated with this asset.	ASSET_LOCATION	
LOC_AUTH_STATUS	Location Authorization Status	The authorization status for this asset at this location.	ASSET_LOCATION	
LOC_AUTH_NAME	Location Authorization Name	The name of the person who authorized this asset to be at this location.	ASSET_LOCATION	
LOC_AUTH_DT	Location Authorization Date	The date the authorization was given for this asset to be at this location.	ASSET_LOCATION	
REPLACE_COST_DT	Replacement Cost Date	Same as INDEX_NAME.	ASSET	
GROUP_ASSET_FLAG	Group Asset Flag	Used for Group Asset Processing.	ASSET	
GROUP_ASSET_ID	Group Asset ID	Used to identify which group asset group members report to.	BOOK, COST, DEPRECIATION, OPEN_TRANS	
RD_PLANT_ASSET	R&D Plant Asset	Flag to indicate this asset is used for R&D.	ASSET	
RD_START_DATE	R&D Start Date	Date asset became used for R&D.	ASSET	
RD_USE_NBV	Use NBV for R&D	Use net book value in gain/loss calculations for R&D assets.	ASSET	
INCENTIVE_ID	Incentive ID	An incentive ID, as would be assigned to a grant. Assigned in Projects and sent to Asset Management.	ASSET_ACQ_DET	

Field Name	Long Name	Use and Processing Considerations	Tables Updated	Required for Conversion
IP_ADDRESS	IP Address	The Internet Protocol address of an asset, such as a computer or printer. Can be uploaded from Tangram's Asset Insight during Physical Inventory.	ASSET	
IP_ALIAS	IP Alias	May be used to capture the name of a user associated with an asset, since IP addresses may be dynamic. Can be uploaded from Tangram's Asset Insight during Physical Inventory.	ASSET	
MERCH_AMT_BSE	Merchandise amount	Used in Payables/ Assets integration.	ASSET_ACQ_DET	
VAT_INV_AMT	VAT Invoice Amount	Vat Invoice in Transaction Currency.	ASSET_ACQ_DET	Y
VAT_INV_AMT_BSE	VAT invoice amount	Used in Payables/ Assets integration.	ASSET_ACQ_DET	
VAT_NRCVR_AMT	VAT Non Recoverable Amount	Vat Non Recoverable in Transaction Currency.	ASSET_ACQ_DET	Y
VAT_NRCVR_AMT_BSE	VAT Nonrecoverable amount	Used in Payables/ Assets integration.	ASSET_ACQ_DET	
VAT_RCVRY_AMT	VAT Recovery Amt	Vat Recoverable in Transaction Currency.	ASSET_ACQ_DET	Y
VAT_RCVRY_AMT_BSE	VAT recovery amount	Used in Payables/ Assets integration.	ASSET_ACQ_DET	
MISC_AMT	Misc Charge Amount	Miscellaneous Charges in transaction Currency.	ASSET_ACQ_DET	Y
MISC_AMT_BSE	Base Misc. Amount	Used in Payables/ Assets integration.	ASSET_ACQ_DET	Y

Field Name	Long Name	Use and Processing Considerations	Tables Updated	Required for Conversion
AM_AST_UD_CHAR1	User-defined Asset character field		ASSET	
AM_AST_UD_CHAR2	User-defined Asset character field		ASSET	
AM_AST_UD_DATE1	User-defined Asset date field		ASSET	
AM_AST_UD_NUM1	User-defined Asset numeric field		ASSET	
AM_AST_UD_NUM2	User-defined Asset numeric field		ASSET	
PROCESS_INSTANCE	Process Instance	Internal		
MERCHANDISE_AMT	Merchandise Amt	Merchandise Amount in Transaction Currency.	ASSET_ACQ_DET	Y
SKU	Stock Keeping Unit	Used to identify IT Software	ASSET	
UPC_ID	Uniform Product Code ID	Used to identify IT Software	ASSET	
VIN	VIN	Vehicle Identification Number	ASSET	
ASSET_RESOURCE_SW	Asset Resource Switch	Used by Maintenance Management. Indicates if Asset is "used as a tool".	ASSET	
ALLOW_OVERBOOK_SW	Allow Overbooking	Used by Maintenance Management to check if an asset can be double booked for scheduling. MM passes this to RM for Scheduling	ASSET	

Field Name	Long Name	Use and Processing Considerations	Tables Updated	Required for Conversion
CHARGE_BACK_SW	Charge Back Switch	Used by Maintenance Management. Allow chargebacks - this is one of the default levels for chargebacks	ASSET	
SCHEDULABLE_SW	Schedulable Switch	Used by Maintenance Management. Asset to be used in WO is able to be scheduled for maintenance.	ASSET	
EPL_TMPL_ID	Parts List Template	Used by Maintenance Management. Equipment and Parts list.	ASSET	
REPAIRABLE_FLG	Repairable Flag	Used by Maintenance Management. Asset is repairable.	ASSET	
REPAIR_STATUS	Repair Status	Used by Maintenance Management. Field values are: None, Needs Repair, In Repair.	ASSET	
BUSINESS_UNIT_WO	Business Unit	Used by Maintenance Management. The Business Unit of the Work Order where this asset could be used.	ASSET	
SHOP_ID	Shop	Used by Maintenance Management. hop/ Location where the work order tasks are to be done. The shop for which this asset is used.	ASSET	
UNOWNED_FLG	Non-Owned Asset	Used by Maintenance Management. Asset not owned by the organization	ASSET	

Field Name	Long Name	Use and Processing Considerations	Tables Updated	Required for Conversion
WO_LOCATION_FLG	Work Order Location	Used by Maintenance Management. This field is used to determine what Location appears by default in the Work Location field on the Work Order Task. It contains three values: 'Asset' provides the Asset Location specified in the Asset definition; 'Shop' provides the Shops Location, and 'Other' leaves the Work Location blank for user entry.	ASSET	
OFFLINE_FLG	Asset Offline	Used by Maintenance Management. An indicator to indicate whether it needs to be taken offline for maintenance.	ASSET	
ASSET_CRITICALITY	Asset Criticality	Used by Maintenance Management. Indicator of how critical the asset is to help managers identify the priority of maintenance.	ASSET	
CREW_ID	Crew	Used by Maintenance Management to represent the Crew definition associated with the asset.	ASSET	
AVAIL_FOR_USE	Available For Use	Used by Maintenance Management. Asset is available to be used by a Work Order request.	ASSET	
PROPERTY_ID	Property I	Used by Lease Administration. Identifier for an asset property	ASSET_PROPERTY	
PROPERTY_DESCR	Property Description	Used by Lease Administration. Description of asset property	ASSET_PROPERTY	

Field Name	Long Name	Use and Processing Considerations	Tables Updated	Required for Conversion
PROPERTY_NM	Property Name	Used by Lease Administration. Name of the asset property.	ASSET_PROPERTY	
PROPERTY_CLASS	Property Class	Used by Lease Administration. Indicator that the property is a SITE, BUILDING, FLOOR, AREA, or SPACE.	ASSET_PROPERTY	
PROPERTY_SUBCLASS	Property Subclass	Used by Lease Administration. Subcategory of Property Class.	ASSET_PROPERTY	
PARENT_PROPERTY_ID	Parent Property ID	Used by Lease Administration. Parent Asset of the property.	ASSET_PROPERTY	
SITE_PROPERTY_ID	Site ID	Used by Lease Administration. Property ID of the SITE for the property hierarchy of the asset.	ASSET_PROPERTY	
BLDG_PROPERTY_ID	Building ID	Used by Lease Administration. Property ID of the SITE for the property hierarchy of the asset.	ASSET_PROPERTY	
FLOOR_PROPERTY_ID	Floor ID	Used by Lease Administration. Property ID of the BUILDING for the asset property hierarchy.	ASSET_PROPERTY	
AREA_PROPERTY_ID	Area ID	Used by Lease Administration. Property ID of the BUILDING for the asset property hierarchy.	ASSET_PROPERTY	

Field Name	Long Name	Use and Processing Considerations	Tables Updated	Required for Conversion
SPACE_PROPERTY_ID	Space ID	Used by Lease Administration. Property ID of the AREA for the property hierarchy of the asset.	ASSET_PROPERTY	
PARCEL_NUMBER	Parcel Number	Used by Lease Administration. Property ID of the SPACE for the property hierarchy of the asset.	ASSET_PROPERTY	
LOT	Lot Number	Used by Lease Administration. Used to record legal description from surveyors when recorded in Lots and Blocks.	ASSET_PROPERTY	
BLOCK	Block Number	Used by Lease Administration. Used to record legal description from surveyors when recorded in Lots and Blocks.	ASSET_PROPERTY	
TOTAL_AREA	Total Area	Used by Lease Administration. Total measurement of the asset in square feet or square meters for the asset.	ASSET_PROPERTY	
SPACE_UOM	Space Unit of Measure	Used by Lease Administration. Used in conjunction with Total Area. Indicates square feet and square meters.	ASSET_PROPERTY	
CURRENT_OCCUPANCY	Current Occupancy	Used by Lease Administration. Number of people currently occupying the asset property.	ASSET_PROPERTY	
MAX_OCCUPANCY	Maximum Occupancy	Used by Lease Administration. Maximum number of people who can be assigned to the asset property.	ASSET_PROPERTY	

Field Name	Long Name	Use and Processing Considerations	Tables Updated	Required for Conversion
OCCUPANCY_STATUS	Occupancy Status	Used by Lease Administration. Indicates whether the asset is occupied or unoccupied.	ASSET_PROPERTY	
OWNERSHIP_STATUS	Ownership Status	Used by Lease Administration. Indicates whether the asset is owned or leased.	ASSET_PROPERTY	
LEGAL_DESCR	Legal Description	Used by Lease Administration. Legal description of asset property using metes and bounds.	ASSET_PROPERTY	
IT_UD_CHAR1	IT User Defined Char Field 1	ITAM user-defined fields	ASSET	
IT_UD_CHAR2	IT User Defined Char Field 2	ITAM user-defined fields	ASSET	
IT_UD_DATE1	IT User Defined Date Field	ITAM user-defined fields	ASSET	
IN_SERVICE_DT	In Service Date	Used to determine if the asset is still under warranty.	ASSET	
REGION_CD	Region Code	Used by Lease Administration for Space Utilization metrics. Prompt allows for values for RPT Region Types.		
CC_FLAG	Component Changeout Old/New	Internal		
DESCR_LONG	Description	Long description for informational purposes.	ASSET	
AREA_ID	Area ID	Detailed asset location information used to identify areas.	ASSET, LOCATION	

Field Name	Long Name	Use and Processing Considerations	Tables Updated	Required for Conversion
LINEAR_ASSET_SW	Linear Asset	Identifies linear assets and facilitates potential third-party integrations.	ASSET	
NBR_OF_CPU	Number of CPU's	Used by ITAM. Identifies the number of CPUs in servers and desktop computers. A separate software license is needed for each CPU.	ASSET	
CAP_THRSHLD_ID	Capitalization Threshold ID	Used by Asset Management to automatically capitalize assets based upon user-defined capitalization thresholds.	ASSET, PROFILE_TBL	
IN_PHY_USE	In Physical Use	This flag is used by ITAM to process nonfinancial IT assets through the comparison process between discovery and asset repository. This designation is available via the Basic Add page and the Define Asset Operational Info page.	ASSET	
CAPVAL_VALUE	Capitalization Value	This value is used to validate whether the asset still meets the conditions to remain in the status at which it was originally catalogued when it was added. Adjustment to the original cost can make an asset fall into a different bracket and, therefore, the asset needs to be recategorized to a different capitalization status.		
VAT_SETID	Value Added Tax SetID	VAT SetID		

Field Name	Long Name	Use and Processing Considerations	Tables Updated	Required for Conversion
VAT_USE_ID	Value Added Tax Use ID	VAT Use Type can be used to specify the ratio of taxable activity to nontaxable activity. The system uses the VAT Use Type and the VAT Apportionment to store the temporary recoverable VAT at purchase time.		
BUSINESS_UNIT_VAT	VAT business unit	VAT business unit		
CHARTFIELD_PR1_VAL	ChartField Priority 1 Value	VAT mixed apportionment is a mechanism that enables VAT recoverability to be determined based on either the VAT apportionment control business unit or one of the two priority ChartFields that you specify on the VAT Apportionment page and to which a transaction is posted. For each business unit, Priority 1 or Priority 2 ChartField value, you enter the percentage of activity that is taxable or exempt.		

Field Name	Long Name	Use and Processing Considerations	Tables Updated	Required for Conversion
CHARTFIELD_PR2_VAL	ChartField Priority 2 Value	VAT mixed apportionment is a mechanism that enables recoverability to be determined based on either the VAT apportionment control business unit or one of the two priority ChartFields you specify on the VAT Apportionment page and to which a transaction is posted. For each business unit, Priority 1 or Priority 2 ChartField value, you enter the percentage of activity that is taxable or exempt.		
VAT_RECOVERY_PCT	VAT Coefficient of Recoverability	This coefficient is used to calculate yearly adjustments or global adjustments for assets; it is made up of the product of reference coefficient of constraint, coefficient of taxation, and coefficient of admission. Those reference coefficients are the ones used to calculate the recoverable VAT amount at invoice time or import time. They can be modified over time based on well-identified events justifying reconsideration of status.		

Field Name	Long Name	Use and Processing Considerations	Tables Updated	Required for Conversion
VAT_CONSTRAINT_PCT	VAT Coefficient of Constraint	This coefficient is the first component of the Recoverability formula made of the product the Coefficient of Constraint, Coefficient of Taxation, and Coefficient of Admission. This coefficient measures the proportion of a good or service use for purpose of taxable operations.		
VAT_TAXATION_PCT	VAT Coefficient of Taxation	This coefficient is the second component of the Recoverability formula made of the product the Coefficient of Constraint, Coefficient of Taxation, and coefficient of Admission. This coefficient translates the fact that only VAT putting a strain on a good or service allows in turn to determine the recoverable VAT amount related to this good or service.		
VAT_ADMISSION_PCT	VAT Coefficient of Admission	This coefficient is the last component of the Recoverability formula made of the product the Coefficient of Constraint, Coefficient of Taxation, and coefficient of Admission. This coefficient of Admission takes into account the existence of exclusions or restrictions to the deductions of VAT. Restrictions and exclusions are set by tax authorities.		
TAX_CD_VAT	VAT Code	VAT Code		

Loader Table INTFC_PHY_B

When used, INTFC_PHY_B fields are most commonly loaded at conversion. They are not currently interfaced from Purchasing, Payables, or Projects, but they could be with some customization.

Note: This table does not need to be inserted for conversion. However, if you insert any values into it, the ones marked **Y** are required.

<i>Field Name</i>	<i>Long Name</i>	<i>Use and Processing Considerations</i>	<i>Tables Updated</i>	<i>Required for Conversion</i>
INTFC_ID	Interface ID	<p>Key to this table. An interface ID is typically assigned to a group of transactions with the same load type.</p> <p>Use a unique, previously unused INTFC_ID for each set of transactions with the same load type.</p> <p>When using a load type of CN1 and NEXT in the ASSET_ID field, use a unique INTFC_ID for each asset.</p> <p>For FADs and Conversions, if INTFC_ID is the same for multiple lines for an asset, increment the INTFC_LINE_NUM for each line.</p>	Internal use	Y
INTFC_LINE_NUM	Interface Line Number	<p>Key to this table. Interface Line Number is used as a key for multiple lines for the same Interface ID for transactions with similar keys (for example, multiple acquisition details, such as CAP).</p> <p>For FADs and Conversions, if INTFC_ID is the same for multiple lines for an asset, increment the INTFC_LINE_NUM for each line.</p>	Used Internally.	Y

Field Name	Long Name	Use and Processing Considerations	Tables Updated	Required for Conversion
BUSINESS_UNIT	Business Unit	Identifies the business unit of the transaction to be processed. This field is required.	ASSET_ATTRIBUTE, ASSET_COMMENTS, ASSET_LICENSE, ASSET_WARRANTY	Y
ASSET_ID	Asset ID	Identifies the asset ID of the transaction to be processed. This field is required. If this field contains the value NEXT and the interface type is FAD, then Transaction Loader will assign the next asset ID for this business unit.	ASSET_ATTRIBUTE, ASSET_COMMENTS, ASSET_LICENSE, ASSET_WARRANTY	Y
INTFC_TYPE	Interface Type, also called Load Type	Identifies the type of this transaction. Transaction Loader will process this transaction based on this field. Valid values are listed in the translate table.	Internal use	Y
SYSTEM_SOURCE	System Source	The source system that created this transaction. Valid values are listed in the translate table. This field is used extensively by Asset Management to drill back to source system. You can add valid values to the translate table for your external systems. You can run Transaction Loader selectively for specific values of system source.	Internal use	Y
MC_DEFN_ID	Mass Change ID	Used for internal processing. Do not populate.	Internal use	
APPROVAL_SW	Auto Approval Status	Identifies whether or not the transaction is approved. Transaction Loader will only load approved transactions. Valid values are 'Y' for approved and 'N' for not approved.	Internal use	Y

Field Name	Long Name	Use and Processing Considerations	Tables Updated	Required for Conversion
INTFC_STATUS	Interface Status	Used for internal processing. Do not populate.	Internal use	
LOAD_STATUS	Load Status	Identifies the status of this transaction. Valid values are 'NEW' (not processed), 'ERR' (an error exists on this transaction and it will not be processed), 'DON' (the transaction was successfully processed), 'CON' (the transaction was consolidated into a different transaction and it will not be loaded), 'UNI' (the transaction was unitized into a different transaction and it will not be loaded).	Internal use	Y enter NEW
ATTRIBUTE_EFFDT	Asset Attribute Effective Date	<p>These fields relate to the Asset_Attributes record. This information is optional. If you do not populate these fields, then a row of asset attribute information will not be created for the asset (thus saving space). You can populate the asset attributes for as many (or as few) assets as you like. If you do not plan to track attributes (color, weight, height, width, length, capacity, power rating) for an asset, then do not populate these fields for that asset.</p> <p>The effective date of the attributes of this asset. If the asset is being added, this value should be the same as the trans_dt.</p>	ASSET_ATTRIBUTE	

Field Name	Long Name	Use and Processing Considerations	Tables Updated	Required for Conversion
ASSET_COLOR	Asset Color	The color of the asset.	ASSET_ATTRIBUTE	
ASSET_WEIGHT	Asset Weight	The weight of the asset.	ASSET_ATTRIBUTE	
WEIGHT_UM	Asset Weight Unit of Measure	The unit of measure used for the asset weight. Should be a valid unit of measure defined on the units of measure table.	ASSET_ATTRIBUTE	
ASSET_HEIGHT	Asset Height	The height of the asset.	ASSET_ATTRIBUTE	
HEIGHT_UM	Asset Height Unit of Measure	The unit of measure used for the asset height. Should be a valid unit of measure defined on the units of measure table.	ASSET_ATTRIBUTE	
ASSET_WIDTH	Asset Width	The width of the asset.	ASSET_ATTRIBUTE	
WIDTH_UM	Asset Width Unit of Measure	The unit of measure used for the asset width. Should be a valid unit of measure defined on the units of measure table.	ASSET_ATTRIBUTE	
ASSET_LENGTH	Asset Length	The length of the asset.	ASSET_ATTRIBUTE	
LENGTH_UM	Asset Length Unit of Measure	The unit of measure used for the asset length. Should be a valid unit of measure defined on the units of measure table.	ASSET_ATTRIBUTE	
ASSET_CAPACITY	Asset Capacity	The capacity of the asset.	ASSET_ATTRIBUTE	
CAPACITY_UM	Asset Capacity Unit of Measure	The unit of measure used for the asset capacity. Should be a valid unit of measure defined on the units of measure table.	ASSET_ATTRIBUTE	

Field Name	Long Name	Use and Processing Considerations	Tables Updated	Required for Conversion
POWER_RATING	Asset Power Rating	The power rating of the asset.	ASSET_ATTRIBUTE	
POWER_RATING_UM	Asset Power Rating Unit of Measure	The unit of measure used for the asset power rating. Should be a valid unit of measure defined on the units of measure table.	ASSET_ATTRIBUTE	
COMMENT_DTTM_STAMP	Asset Comments Date/ Time Stamp	The date/time stamp of the comments for this asset. This value is used as a key to the Asset_Comments record.	ASSET_COMMENTS	
NAME	Name	The name of the person who entered the comments.	ASSET_COMMENTS	
COMMENTS50	Comments 50 Characters	The comments for the assets. This field is long on the Asset_Comments record, but it is a 50-byte character field because of database restrictions. Online, you can enter up to 32K of information into this field.	ASSET_COMMENTS	

Field Name	Long Name	Use and Processing Considerations	Tables Updated	Required for Conversion
AGENCY_ID	Agency ID	<p>These fields relate to the Asset_License record. This record is used to track the license or registration of an asset with a given agency or vendor. Examples are a vehicle registration with the state or a software registration with a vendor. This information is optional. If you do not populate these fields, then a row of asset license information will not be created for the asset (thus saving space). You can populate asset license information for as many (or as few) assets as you like. If you do not plan to track license information for an asset, then do not populate these fields for that asset.</p> <p>This field is the agency that the asset is registered with and is mutually exclusive of the asset license vendor ID. This value should be valid value on the Agency_Tbl record.</p>	ASSET_LICENSE	
LICENSE_VENDOR_ID	Asset License Vendor ID	<p>The vendor to which the asset is registered. This value is mutually exclusive with the agency ID. This value should appear in the VNDR_FS record.</p>	ASSET_LICENSE	
REGISTRATION_NO	Registration Number	<p>The registration number for the asset.</p>	ASSET_LICENSE	
INSPECTION_SW	Inspection Required	<p>Indicates if an inspection of the asset is required. Valid values are 'Y' or 'N'.</p>	ASSET_LICENSE	

Field Name	Long Name	Use and Processing Considerations	Tables Updated	Required for Conversion
LIC_START_DT	License Effective Date	The effective date of the license or registration.	ASSET_LICENSE	
LIC_END_DT	License Expiration Date	The expiration date of the license or registration.	ASSET_LICENSE	
REGISTER_NAME	Name	The name of the person to whom the asset is registered.	ASSET_LICENSE	
COUNTRY	Country	The country in which the asset is registered.	ASSET_LICENSE, COUNTRY	
ADDRESS1	Address 1	The address line 1 under which the asset is registered.	ASSET_LICENSE	
ADDRESS2	Address 2	The address line 2 under which the asset is registered.	ASSET_LICENSE	
ADDRESS3	Address 3	The address line 3 under which the asset is registered.	ASSET_LICENSE	
ADDRESS4	Address 4	The address line 4 under which the asset is registered.	ASSET_LICENSE	
CITY	City	The city in which the asset is registered.	ASSET_LICENSE	
NUM1	Number 1		ASSET_LICENSE	
NUM2	Number 2		ASSET_LICENSE	
HOUSE_TYPE	House Type	The type of house, for example, houseboat or trailer.	ASSET_LICENSE	
ADDR_FIELD1	Address Field 1	An address field.	ASSET_LICENSE	
ADDR_FIELD2	Address Field 2	An address field.	ASSET_LICENSE	

Field Name	Long Name	Use and Processing Considerations	Tables Updated	Required for Conversion
ADDR_FIELD3	Address Field 3	An address field.	ASSET_LICENSE	
COUNTY	County	The county in which the asset is registered.	ASSET_LICENSE	
STATE	State	The state in which the asset is registered.	ASSET_LICENSE	
POSTAL	Postal Code	The postal code in which the asset is registered.	ASSET_LICENSE	
GEO_CODE	Tax Vendor Geographical Code	The tax vendor geographical code.	ASSET_LICENSE	
IN_CITY_LIMIT	In City Limit	Indicates if the vendor is within city limit.	ASSET_LICENSE	
JURISDICTION	Jurisdiction	Identifies the municipal authority of which it is a part. Can be used by property tax to identify a taxing authority.	ASSET_LICENSE	
LICENSE_COMMENTS50	Asset License Comments 50 Characters	Comments about the license or registration for the asset.	ASSET_LICENSE	

Field Name	Long Name	Use and Processing Considerations	Tables Updated	Required for Conversion
WARRANTY_EFFDT	Warranty Effective Date	<p>The following fields relate to the Asset_Warranty record. This information is optional. If you do not populate these fields, then a row of asset warranty information will not be created for the asset (thus saving space). You can populate asset warranty information for as many (or as few) assets as you like. If you do not plan to track warranty information for an asset, then do not populate these fields for that asset.</p> <p>This field represents the date the warranty for this asset became effective.</p>	ASSET_WARRANTY	
EFF_STATUS	Status as of Effective Date	The status of the warranty as of the effective date. Valid values are 'A' for active or 'I' for inactive.	ASSET_WARRANTY	
WARRANTY_VENDOR_ID	Warranty Vendor ID	The vendor ID that provided the warranty. This value should appear in the VNDR.FS record.	ASSET_WARRANTY	
WARRANTY_NUM	Warranty Number	The number of the warranty.	ASSET_WARRANTY	
WARRANTY_DURATION	Warranty Duration (Months)	The duration of the warranty in months.	ASSET_WARRANTY	
COVERAGE50	Asset Warranty Coverage 50 Characters	The comments on the coverage of the warranty. This field is a long field on the Asset_Warranty record, but it is only 50 characters here. Online, you can enter up to 32K of information into this field.	ASSET_WARRANTY	

Field Name	Long Name	Use and Processing Considerations	Tables Updated	Required for Conversion
AM_AST_UD_CHAR1	User Defined Char Field 1	User-defined field.	ASSET	
AM_AST_UD_CHAR2	User Defined Char Field 2	User-defined field.	ASSET	
AM_AST_UD_DATE1	User Defined Date Field 1	User-defined field.	ASSET	
AM_AST_UD_NUM1	User Defined Number Field 1	User-defined field.	ASSET	
AM_AST_UD_NUM2	User Defined Number Field 2	User-defined field.	ASSET	
PROCESS_INSTANCE	Process Instance	Internal use.		

When converting a blank character field (a character field with a null value), you should assign it a value of a single space, regardless of the field length. For example, to convert a blank character field with a length of five characters, you should give it a value of one space, not five spaces. This conversion is particularly important for ChartFields.

When converting character fields, do not add any trailing spaces to the field value. For example, the value in Book should be *CORP*, not *CORP* .

When loading rows into any interface tables, the `intfc_id`, `intfc_line_num`, and `dtm_stamp` must be the same across all used loader tables (that is, `INTFC_FIN`, `INTFC_PHY_A`).

Transaction Loader Inserts

Depending on what transaction type you are processing and which loader table it is reading, the Transaction Loader inserts field values into various Asset Management tables and performs any additional processing noted in the following table. It inserts all fields that the target table and the loader table have in common.

From `INTFC_FIN`

The following table describes the information inserted from the `INTFC_FIN` table:

Transaction Type (Load Type)	Inserts into These Tables	Additional Processing
FAD	Book* Book Profile # Cost * Cost Profile # Depreciation * Depreciation Profile # Open Trans * Open Trans Profile #	
ADD	Book * Book Profile # Cost * Cost Profile # Depreciation * Depreciation Profile # Open Trans * Open Trans Profile #	
CN1	Book * Book Profile # Cost * Cost Profile # Depreciation * Depreciation Profile #	Process Conversion Open Trans 1
CN2	Book * Book Profile # Cost * Cost Profile # Depreciation * Depreciation Profile #	Process Conversion Open Trans 1
CAP	Book * Book Profile # Cost * Cost Profile # Depreciation * Depreciation Profile # Open Trans * Open Trans Profile #	
CIC	Book * Book Profile # Cost * Cost Profile # Open Trans * Open Trans Profile #	Validate Distribution Templates
AAD	Cost * Cost Profile # Open Trans * Open Trans Profile #	
IUI	Book * Cost # Open Trans *	Set Trans Type to TRF Set Trans_In_Out to I Validate Distribution Templates Process IUI Asset ID
IUO	Cost * Open Trans *	Set Trans Type to TRF Set Trans_In_Out to O Validate Distribution Templates
TRF	Cost (positive amount for transfer in) * Cost (negative amount for transfer out) * Open Trans *	
ADJ	Cost * Open Trans *	
RCT	Cost * Open Trans *	
RET	Cost * Retirement Open Trans *	Set Asset Status to Disposed

Transaction Type (Load Type)	Inserts into These Tables	Additional Processing
PRT	Cost * Retirement Open Trans *	
REI	Cost * Retirement Open Trans *	Update Asset Status to In Service
BKS	Open Trans *	Update Book Processing
BKD		Delete Book
BSD		Delete only BU/Book/Asset ID combinations
OPT	Open Trans *	
ASD	Deletes from all base tables	Check DIST_LN Delete Asset Processing
ADQ	Cost * Cost Profile # Open Trans * Open Trans Profile #	
ARA	Book * Book Profile # Cost * Cost Profile # Depreciation * Depreciation Profile # Retirement * Retirement Profile #	
LAD	Book * Book Profile # Cost * Cost Profile # Depreciation * Depreciation Profile # Retirement * Retirement Profile # Open Trans *	
ADP	Depreciation * Open Trans	

* When Default Profile Switch = N

When Default Profile Switch = Y and PHY_A.PROFILE_ID is valid in the profile detail table, the system gets book, cost, depreciation, and open trans information from the profile detail table rather than INTFC_FIN.

From INTFC_PHY_A

The following table describes the information inserted from the INTFC_PHY_A table:

<i>Transaction Type</i>	<i>Inserts into These Tables</i>	<i>Additional Processing</i>
FAD	Asset, Asset Acquisition Detail, Asset Custodian, Asset Location	
NAD	Asset, Asset Acquisition Detail, Asset Custodian, Asset Location	
IUI	Asset, Asset Acquisition Detail, Asset Custodian, Asset Location	
CN1	Asset, Asset Acquisition Detail, Asset Custodian, Asset Location	
AUP		Update Asset
PHY	Asset Acquisition Detail Asset Custodian Asset Location	
CAP	Asset Acquisition Detail	Capitalize Asset Acquisition Detail
ACQ	Asset Acquisition Detail	
ADQ	Asset Acquisition Detail	
CLC	Asset Custodian Asset Location	
LAD	Asset, Asset Custodian, Asset Location	
CIC		Update Asset Acquisition Detail = CIC
IHI	Physical Inventory History	
RAQ	Asset Acquisition Detail	Replace Acquisition Detail - Used solely by AMIF1000
ARA	Asset Custodian, Asset Location, Physical Inventory History, Parent Asset	

From INTFC_PHY_B

The following table describes the information inserted from the INTFC_PHY_B table:

Transaction Type	Inserts into These Tables	Additional Processing
FAD	Asset Attribute Asset Comments Asset License Asset Warranty	
NAD	Asset Attribute Asset Comments Asset License Asset Warranty	
PHY	Asset Attribute Asset Comments Asset License Asset Warranty	
CN1	Asset Attribute Asset Comments Asset License Asset Warranty	
ARA	Asset Attribute Asset Comments Asset License Asset Warranty	
LAD	Asset Attribute Asset Comments Asset License Asset Warranty	

Interface Types (Load Types)

The following table defines Interface Types:

Interface Type	Long Name	Usage	Tables Updated
AAD	Additional Cost Add	Rarely used. Adds cost information to an asset. Mainly used for joint venture and composite rollups.	Cost, Open Trans
ACQ	Insert Acquisition Detail	Inserts into Acquisition Detail.	Acquisition Detail
ADD	Asset Add	Asset add - Financial only. For details, see load type CN2.	Book, Cost, Depr, Open Trans
ADJ	Asset Cost Adjustment	Adjusts the cost of an existing asset.	Cost, Open Trans
ADP	Asset Depreciation	Inserts depreciation information created by the Revaluation en Masse programs.	Depreciation, Open Trans

Interface Type	Long Name	Usage	Tables Updated
ADQ	Adjust Cost and Acquisition Detail	Adjusts the cost and acquisition details of an existing asset.	Acquisition Detail, Cost, Open Trans
ARA	Add Retired Asset	Adds an asset that has been fully reserved and retired.	Book, Cost, Depr, Asset, and if applicable Custodian, Asset Location, Warranty, Attribute, License, Comments, and Acquisition Detail
ASD	Asset Deletion	Deletes an existing asset. Only assets that have not been used to generate any journals will be deleted.	Asset, Acquisition Detail, Asset Fair Value, Attribute, Comments, Custodian, Location, Maintenance, Warranty, Book, Book Tax Credit, Cost, Depr, Dist Line, Open Trans, Retirement, Lease, Lease Schedule, PI Asset History,
AUP	Asset Information Update	Updates the asset table only. Rarely used, except in physical inventory.	Asset, Component of Asset History
BKD	Book Deletion	Deletes a book for an asset or business unit. For example, you can use it to delete dummy books used for performing "what if" analyses.	Book, Book Tax Credit, Depr, Dist Line, Retirement, Open Trans
BKS	Book Change	Makes any change to an asset book.	Book, Open Trans
BSD	Selective Book Delete	Deletes a book from a range of asset IDs. Similar to BKD.	Book, Book Tax Credit, Depr, Dist Line, Retirement, Open Trans
CAP	Asset Capitalization	Adds a line of acquisition detail and capitalizes it. If the acquisition detail line is originally uncapitalized, the interface will insert book, cost, and open trans as well as acquisition detail. If it is originally capitalized, the book information will not be inserted.	Acquisition Detail, Book, Cost, Open Trans
CIC	Capitalize into Composite	Capitalizes composite assets. Similar to CAP.	Acquisition Detail, Book, Cost, Open Trans

Interface Type	Long Name	Usage	Tables Updated
CLC	Custodian/Location Change	Updates custodian/location information.	Custodian, Location
CN1	Conversion of First Book	During conversion, converts the first asset book. Inserts into all asset tables, as well as financial tables.	Book, Cost, Depr, Open Trans, Asset, Acquisition Detail, Location, PI Asset History, Component of Asset History, Parent Asset, Attribute, Comments, License, Warranty
CN2	Conversion of Subsequent Books	During conversion, converts any subsequent books. Inserts only into financial tables.	Book, Cost, Depr, Component of Asset History, Open Trans
FAD	Financial and Physical Add	Adds assets with both physical and financial information. This Interface Type is used most commonly for adding assets.	Book, Cost, Depr, Open Trans, Asset, Acquisition Detail, Location, PI Asset History, Component of Asset History, Parent Asset, Attribute, Comments, License, Warranty
IHI	Physical Inventory History Insert	Inserts asset history. Used by the Physical Inventory SQR (AMP11000).	PI Asset History
IUI	InterUnit Transfer, In Side	<p>Provides the IN side of an InterUnit Transfer. Valid values for ACTIVITY_SW are:</p> <p>1 Full Transfer 0 Active ChartField combination – 1 Reactivated ChartField combination</p> <p>For example, one ChartField combination is fully transferred out of a department (ACTIVITY_SW = 1), and an identical ChartField combination is transferred into the same department (ACTIVITY_SW = -1). The activity switch values for the two transactions then cancel each other, resulting in an active ChartField combination (ACTIVITY_SW = 0).</p>	Asset, Book, Cost, Asset Fair Value, Open Trans, Component of Asset History

Interface Type	Long Name	Usage	Tables Updated
IUO	InterUnit Transfer, Out Side	<p>Used for the OUT side of an InterUnit Transfer. Valid values for ACTIVITY_SW are:</p> <p>1 Full Transfer 0 Active ChartField combination – 1 Reactivated ChartField combination</p> <p>For example, one ChartField combination is fully transferred out of a department (ACTIVITY_SW = 1), and an identical ChartField combination is transferred into the same department (ACTIVITY_SW = -1). The activity switch values for the two transactions then cancel each other, resulting in an active ChartField combination (ACTIVITY_SW = 0).</p>	Cost, Open Trans
LAD	Leased Asset Add	Adds leased assets.	Lease, Lease Schedule, Book, Cost, Depr, Open Trans, Asset, Acquisition Detail, Asset Fair Value, Location, PI Asset History, Parent Asset, Attribute, Comments, License, Warranty
NAD	Non-Financial Add	Adds an asset with only physical information.	Asset, Custodian, Location, PI Asset History, Component of Asset History, Parent Asset, Attribute, Comments, License, Warranty, Open Trans
OPT	Open Transaction Generator	Creates open transactions for a set of assets. Rarely used.	Open Trans
PHY	Physical Asset Change	Performs inserts to any physical asset tables other than the Asset Table, for example, location, custodian, or manufacturer.	Acquisition Detail, Custodian, Location, Attribute, Comments, License, Warranty
PRT	Partial Retirement	Performs partial retirements.	Cost, Retirement, Open Trans, Asset

Interface Type	Long Name	Usage	Tables Updated
RAQ	Replace Acquisition Detail	Replaces acquisition details using AMIF1000.	Acquisition Detail
RCT	Asset Recategorization	Performs recategorizations.	Cost, Open Trans
REI	Asset Reinstatement	Performs reinstatements.	Cost, Retirement, Open Trans, Asset
RET	Asset Retirement	Performs full retirements.	Cost, Retirement, Open Trans, Asset
RNA	Non-Financial Retirements	Performs retirements of non-financial assets.	Asset, Asset Retirement
TRF	IntraUnit Transfer	<p>Performs transfers within the same business unit. Valid values for ACTIVITY_SW are:</p> <p>1 Full Transfer 0 Active ChartField Combination – 1 Reactivated ChartField Combination</p> <p>For example, one ChartField combination is fully transferred out of a department (ACTIVITY_SW = 1), and an identical ChartField combination is transferred into the same department (ACTIVITY_SW = -1). The activity switch values for the two transactions then cancel each other, resulting in an active ChartField combination (ACTIVITY_SW = 0).</p>	Cost, Open Trans

Related Links

“Previewing Data in the Loader Tables” (Asset Lifecycle Management Fundamentals)

“Running the Transaction Loader” (Asset Lifecycle Management Fundamentals)

Understanding Depreciation Calculations

Understanding How PeopleSoft Asset Management Calculates Depreciation

PeopleSoft Asset Management determines depreciation amounts using either tables or formulas. If you have a large number of assets, you will probably want to use formula-based depreciation, because this is considerably faster and uses less storage space. To help you more fully understand how PeopleSoft Asset Management calculates depreciation, this topic includes a discussion of how formulas are used.

When you add an asset to PeopleSoft Asset Management, you decide the cost basis that you want to depreciate—you can include the basic cost of the asset as well as any freight and taxes that were paid. If you do not want to include freight and tax charges in the depreciable cost basis, you can still track these charges in the Acquisition Detail page.

If allowed by the depreciation method, the cost basis is reduced by either salvage value or tax credits.

Salvage Value

You can enter the salvage value as a percentage of the cost or the actual amount. Typically, you specify salvage value when you add the asset in PeopleSoft Asset Management. If allowed, salvage value is deducted from the cost basis for depreciation calculations. When the salvage value changes after depreciation begins, PeopleSoft Asset Management automatically adjusts the cost basis and depreciation from that time forward to reflect the change.

See [Calculating Depreciation When Salvage Value Exceeds Net Book Value \(NBV\)](#).

Tax Credits

Tax methods such as ACRS and MACRS determine which tax credits are available in PeopleSoft Asset Management. When you specify a Qualified Investment Code, PeopleSoft Asset Management uses this code to determine which tax credits apply to your assets. If you fail to specify a Qualified Investment Code for any reason, PeopleSoft Asset Management deduces the applicable code from the tax method that you elect.

If you do not specify a tax system, PeopleSoft Asset Management considers the date that the assets were placed in service to determine which method applies. Based on the tax method that you select and the recovery life, PeopleSoft Asset Management derives the corresponding qualified investment code and the tax credits that available under that code, and elects the applicable tax credits for you.

If a Basis Reduction Percentage applies, the depreciable basis of the asset is reduced. The calculation is based on the Qualified Investment Code, the Tax Credit, and the Basis Reduction Percentage.

Calculating Tax Credits

PeopleSoft Asset Management uses the Qualified Investment Code, together with the Recovery Life and in-service date, to determine the Qualified Investment Percentage—the rate that is applied to the book cost—to determine the amount that qualifies for tax credits.

The Tax Credit Percentage is derived from the Tax Credit Type, Tax Credit Code, Recovery Life, and in-service date.

The amount of the tax credit is based on the following calculations:

$$\begin{aligned} \text{Book Cost} \times \text{Qualified Investment Percentage} &= \text{Amount qualifying for the tax credit} \\ \text{Amount qualifying} \times \text{Tax Credit Percentage} &= \text{Amount of tax credit} \end{aligned}$$

Cost Basis Reduction

After the amount of the tax credit is calculated, a corresponding reduction in the basis is calculated as required:

$$\text{Amount of tax credit} \times \text{Basis Reduction Percentage} = \text{Amount the basis will be reduced}$$

If you dispose of the asset before it has completely depreciated, PeopleSoft Asset Management calculates the recapture of the credit and adds it to the depreciable cost basis.

Section 179 Expense

If you elect to expense all or a portion of the cost, you should select the **Section 179 Expense Taken** check box on the Asset Book Definition - Tax page. Investment credits are automatically calculated based on the criteria that you enter in the Asset Book Definition - Tax Credit page.

Listed Property Assets

If an asset is considered a listed property asset for tax purposes, then the allowable depreciable basis is reduced by the percentage of business use. For example:

$$\begin{aligned} \text{Business Use \%} &= 75\% \\ \text{Cost} &= 10,000 \text{ USD} \\ \text{Depreciable basis} &= 7500 \text{ USD} \end{aligned}$$

Listed property is certain kinds of assets that are conducive to mixed business and personal use such as:

- Passenger automobiles under a certain weight.
- Any other property that is used for transportation such as trucks, buses, boats, airplanes, motorcycles, and any other vehicles for transporting persons or goods.
- Any property of a type that is generally used for entertainment, recreation, or amusement such as photographic, phonographic, communication, and video recording equipment.
- Any computer and related peripheral equipment unless it is used only at a regular business establishment and owned or leased by the person operating the establishment.
- Any cellular telephone (or similar telecommunications equipment) placed in service or leased in a tax year beginning after 1989.

The Depreciation Calculation Process

PeopleSoft Asset Management performs five basic steps to calculate depreciation for an asset. It calculates:

1. The asset's *beginning depreciation date*.
2. The asset's *remaining life* and *remaining value*.
3. The asset's yearly depreciation.
4. The asset's period depreciation allocation.
5. The asset's prior period depreciation.

PeopleSoft Asset Management depreciation calculation process flow.

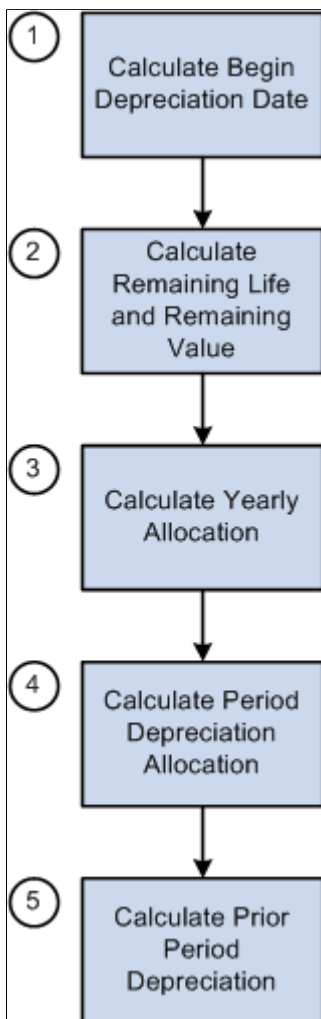

The following sections provide illustrative examples of how PeopleSoft Asset Management handles all of these calculations in a variety of different scenarios.

Note: PeopleSoft Asset Management calculates depreciation yearly, not by month or by period. It then allocates yearly depreciation among the year's periods, except when you select the Declining Balance depreciation method or the Declining Balance method with a switch to the Straight Line method *and* the monthly depreciation option is selected.

Calculating the Begin Depreciation Date

PeopleSoft Asset Management uses two asset attributes to begin calculating depreciation:

- In-service date.
- Convention.

The combination of the in-service date and the prorate convention is the factor that actually determines when depreciation begins.

Overriding the Begin Depreciation Field

When you use the *Depreciate When in Service* date option, PeopleSoft Asset Management allocates depreciation based on the date that the asset was placed in service. This option is valid only in the year that the asset is acquired.

Calculating Remaining Value

PeopleSoft Asset Management calculates remaining value and remaining life using five asset attributes:

- Begin Depr Date
- Transaction Date
- Life
- Cost
- Accumulated Depreciation

Calculations differ depending on which calculation type is used and the relationship between the beginning depreciation date and the transaction date. The following examples show how the calculation is performed for each method.

Remaining Value Calculation for Add Transactions

The following table shows data that is used in the calculation examples that follow it.

Attributes	Data
Transaction Date	10/1/2006

Attributes	Data
Accounting Date	10/1/2006
In-Service Date	3/1/2006
Life	60 periods
Cost	6,000 USD
Accumulated Depreciation	500 USD
Calculation Type	Remaining Value
Convention	Half-Year
Method	Straight-Line
Depreciate When In Service Switch	N
Begin Depr Date	7/1/2006
Remaining Value	5,500 USD
Remaining Life	60 periods

Remaining Value

The following example illustrates remaining value:

$$\text{Remaining Value} = \text{Cost} - \text{Accumulated Depreciation}$$

$$6,000 \text{ USD cost} - 500 \text{ USD accumulated depreciation} = 5,500 \text{ remaining value}$$

Life to Date Calculation for Add Transactions

The following table shows data that is used in the calculation example that follows it.

Attributes	Data
Transaction Date	10/1/2006
Accounting Date	10/1/2006

Attributes	Data
In-Service Date	3/1/2006
Life	60 periods
Cost	6,000 USD
Accumulated Depreciation	500 USD
Calculation Type	Life to Date
Convention	Half-Year
Method	Straight-Line
Depreciate When In Service Switch	N
Begin Depr Date	7/1/2006
Remaining Value	6,000 USD
Remaining Life	60 periods

Remaining Value

The following example illustrates remaining value:

$$\text{Remaining Value} = \text{Cost}$$

6,000 USD cost

Calculating Yearly Depreciation

PeopleSoft Asset Management calculates yearly depreciation using two asset attributes:

- Begin Depr Date
- Depreciation Method

Other information that is used in this calculation includes the following information:

- Adj Trans Date
- Remaining Life

- Remaining Value

Calculations differ depending on which calculation type is used: *Remaining Value* or *Life to Date*. The following examples show how this calculation is performed for each method. The base information is the same in both cases.

Remaining Value Calculation for Add Transactions

The following table introduces the data used in the calculation example that follow it.

Attributes	Data
Transaction Date	10/1/2006
Accounting Date	10/1/2006
In-Service Date	3/1/2006
Life	60 periods
Cost	6,000 USD
Accumulated Depreciation	500 USD
Calculation Type	Remaining Value
Convention	Half-Year
Method	Straight-Line
Depreciate When In Service Switch	N
Begin Depr Date	7/1/2006
Remaining Value	5,500 USD
Remaining Life	60 periods
Yearly Depreciation (First year)	550 USD

Yearly Depreciation for 2006

Here is yearly depreciation for 2006 using the Remaining Value calculation type:

$$\text{Number of Periods in a Year} = \text{Year End} - \text{Begin Depr Date}$$

$6 = \text{December 31, 2006} - \text{July 1, 2006}$

$\text{Percentage Depreciation for Year} = \text{Number of Periods in a year} / \text{Remaining Life}$

$10 \text{ percent} = 6 / 60$

$\text{Yearly Depreciation} = \text{Percentage depreciation for the year} \times \text{Remaining value}$

$550 \text{ USD} = 10 \text{ percent} \times 5,500 \text{ USD}$

Life to Date Calculation for Add Transactions

The following table introduces the data that is used in the calculation example that follow it.

Attributes	Data
Transaction Date	10/1/2006
Accounting Date	10/1/2006
In-Service Date	3/1/2006
Life	60 periods
Cost	6,000 USD
Accumulated Depreciation	500 USD
Calculation Type	Life to Date
Convention	Half-Year
Method	Straight-Line
Depreciate When In Service Switch	N
Begin Depr Date	7/1/2006
Remaining Value	6,000 USD
Remaining Life	60 periods
Yearly Depreciation (First year)	600.00 USD

Yearly Depreciation for 2006

Here is yearly depreciation for 2006 using the Life to Date calculation type:

$\text{Number of periods in a year} = \text{Year End} - \text{Begin Depr Date}$

$6 = \text{December 31, 2006} - \text{July 1, 2006}$

$\text{Percentage depreciation for year} = \text{Number of periods in year} / \text{Remaining life}$

$10 \text{ percent} = 6 / 60$

$\text{Yearly depreciation} = \text{Percentage depreciation for year} \times \text{Remaining value}$

$600 \text{ USD} = 10 \text{ percent} \times 6,000 \text{ USD}$

Calculating Period Allocation

PeopleSoft Asset Management calculates period allocation using three asset attributes:

- In-Service Date
- Begin Depr Date
- Transaction Date

Other information that is used in this calculation includes the following, derived from previous calculations:

- Calculation Type
- Adjusted Transaction Date
- Yearly Depreciation
- Number of Periods in Year

Life to Date calculations differ depending on whether the **Depreciate When in Service** option is set to *N* or *Y*. The following examples illustrate how PeopleSoft Asset Management calculates period allocation using the *Remaining Value* and *Life to Date* calculations. All examples use the same base information.

When a remaining balance exists due to rounding in the year, PeopleSoft Asset Management allocates that amount to the last period of the fiscal year. For example, 2000 USD to be allocated over 12 periods, periods 1 through 11 will have 166.67 each and period 12 will have 166.63 USD (2000 USD - (166.67 x 11)).

1	2	3	4	5	6	7	8	9	10	11	12	Period
166.67	166.67	166.67	166.67	166.67	166.67	166.67	166.67	166.67	166.67	166.67	166.63	Amount

Remaining Value Calculation for Add Transactions: Depreciate When In Service Off

The following table shows data that is used in the calculation.

Attributes	Data
Transaction Date	10/1/2006

Attributes	Data
Accounting Date	10/1/2006
In-Service Date	3/1/2006
Life	60 periods
Cost	6,000 USD
Accumulated Depreciation	500 USD
Calculation Type	Remaining Value
Convention	Half-Year
Method	Straight-Line
Depreciate When In Service Switch	N
Begin Depr Date	7/1/2006
Remaining Value	5,500 USD
Remaining Life	60 periods
Yearly Depreciation (First year)	550 USD
Period Allocation (First year)	91.66 USD

Period Depreciation Allocation

Here is the period depreciation allocation:

$$\text{Period depreciation allocation} = \text{Yearly depreciation} / \text{Number of periods remaining in a year}$$

$$550 \text{ USD yearly depreciation} / 6 \text{ periods} = 91.66 \text{ USD per period}$$

Remaining Value Calculation for Add Transactions: Depreciate When In Service On

The following table shows data that is used in the calculation example that follows it.

Attributes	Data
Transaction Date	10/1/2006
Accounting Date	10/1/2006
In-Service Date	3/1/2006
Life	60 periods
Cost	6,000 USD
Accumulated Depreciation	500 USD
Calculation Type	Remaining Value
Convention	Half-Year
Method	Straight-Line
Depreciate When In Service Switch	Y
Begin Depr Date	7/1/2006
Remaining Value	5,500 USD
Remaining Life	60 periods
Yearly Depreciation (First year)	550 USD
Period Allocation (First year)	55 USD

Period Depreciation Allocation

Here is the period depreciation allocation:

Period Depreciation Allocation = Yearly Depreciation / Periods from In-Service Date

Periods from In-Service Date = Year End - In-Service Date

550 USD Yearly Depreciation / 10 periods from In-Service Date = 55 USD per period

Life to Date Calculations for Add Transactions: Depreciate When in Service Off

The following table shows data that is used in the calculation example that follows it.

Attributes	Data
Transaction Date	5/1/2006
Accounting Date	5/1/2006
In-Service Date	3/1/2006
Life	60 periods
Cost	6,000 USD
Accumulated Depreciation	500 USD
Calculation Type	Life to Date
Convention	Half-Year
Method	Straight-Line
Depreciate When In Service Switch	N
Begin Depr Date	7/1/2006
Remaining Value	6,000 USD
Remaining Life	60 periods
Yearly Depreciation (First year)	600.00 USD
Period Allocation (First year)	100 USD

Period Depreciation Allocation

Here is the period depreciation allocation:

Period Depreciation Allocation = Yearly Depreciation / Number of Periods in Year

600 USD Yearly Depreciation / 6 periods = 100 USD per period

Life to Date Calculation for Add Transactions: Calculate When in Service On

The following table shows data that is used in the calculation example that follows it.

Attributes	Data
Transaction Date	3/1/2006
Accounting Date	3/1/2006
In-Service Date	3/1/2006
Life	60 periods
Cost	6,000 USD
Accumulated Depreciation	500 USD
Calculation Type	Life to Date
Convention	Half-Year
Method	Straight-Line
Depreciate When In Service Switch	Y
Begin Depr Date	7/1/2006
Remaining Value	6,000 USD
Remaining Life	60 periods
Yearly Depreciation (First year)	600.00 USD
Period Allocation (First year)	60 USD

Depreciation Results

The following table shows yearly depreciation by period for 2006.

1	2	3	4	5	6	7	8	9	10	11	12	Period
		60	60	60	60	60	60	60	60	60	60	Amount

Remaining life is 60 periods; remaining value is 6,000 USD; yearly depreciation for 2006 is 600 USD.

Calculating Prior Period Depreciation

Prior period depreciation is generally calculated only for *Life to Date* calculations. In *Remaining Value* calculations, prior period depreciation is calculated only if the accounting date occurs after transaction date.

Prior period depreciation is keyed by a derived beginning calculation date. For remaining value calculations in which the accounting date occurs after the transaction date, the beginning calculation date equals the transaction date. For life to date calculations, the beginning calculation date depends on a combination of the following items:

- Transaction Date
- Begin Depr Date

Note: One overriding factor that is used to derive the beginning calculation date is that it can never occur before the beginning depreciation date. If according to all calculations it should, it is automatically made to equal the beginning depreciation date.

PeopleSoft Asset Management calculates prior period depreciation using the derived beginning calculation date as well as the following items:

- Period Depreciation Allocation
- Accumulated Depreciation

The following examples illustrate how PeopleSoft Asset Management calculates prior period depreciation.

Case 1: Add Transactions

The following table shows data that is used in the calculation example that follows it.

Attributes	Data
Transaction Date	10/1/2006
Accounting Date	10/1/2006
In-Service Date	3/1/2006

Attributes	Data
Life	60 periods
Cost	6,000 USD
Accumulated Depreciation	
Calculation Type	Life to Date
Convention	Half-Year
Method	Straight-Line
Depreciate When In Service Switch	N
Begin Depr Date	7/1/2006
Begin Calc Date	7/1/2006
Remaining Value	6,000 USD
Remaining Life	60 periods
Yearly Depreciation (First year)	600.00 USD
Period Allocation (First year)	100 USD
Prior Period Depreciation	300 USD

Depreciation Results

The following table shows yearly depreciation by period for 2006. Prior period depreciation occurred in periods 7 through 9.

1	2	3	4	5	6	7	8	9	10	11	12	Periods
						100	100	100				Allowed
									100	100	100	Taken
						100	100	100				Difference

Prior Period Depreciation

Here is the prior period depreciation:

Difference Per Period = Period Depreciation Allocation (allowed) - Depreciation Taken

Example Period 7: 100 USD - 0 = 100 USD

Begin Calc Date = Begin Depr Date

Periods from Begin Calc Date to Accounting Date = 7, 8, 9 = Periods within 7/1/2006⇒ to 10/1/2006

Prior Period Depreciation = Sum of Difference Per Period for all periods within Beg⇒ in Calc Date to Accounting Date

\$300 = \$100 + \$100 + \$100

Case 2: Add Transactions

The following table shows data that is used in the calculation example that follows it.

Attributes	Data
Transaction Date	10/1/2006
Accounting Date	10/1/2006
In-Service Date	3/1/2006
Life	60 periods
Cost	6,000 USD
Accumulated Depreciation	500 USD
Calculation Type	Life to Date
Convention	Half-Year
Method	Straight-Line
Depreciate When In Service Switch	N
Begin Depr Date	7/1/2006
Begin Calc Date	7/1/2006

Attributes	Data
Remaining Value	6,000 USD
Remaining Life	60 periods
Yearly Depreciation (First year)	600.00 USD
Period Allocation (First year)	100 USD
Prior Period Depreciation	(200) USD

Depreciation Results

The following table shows yearly depreciation by period for 2006. Prior period depreciation occurred in periods 7 through 9.

1	2	3	4	5	6	7	8	9	10	11	12	Period
						100	100	100	100	100	100	Allowed
					500				100	100	100	Taken
					(500)	100	100	100				Difference

Prior Period Depreciation

Here is the prior period depreciation:

Difference Per Period = Period Depreciation Allocation (allowed) - Depreciation Taken

Example Period 7: 100 USD - 0 = 100 USD

Begin Calc Date = Begin Depr Date

Periods from Begin Calc Date to Accounting Date =

7, 8, 9 = Periods within 7/1/2006 to 10/1/2006

Prior Period Depreciation = Sum of Difference Per Period for all periods within Begin Calc Date to Accounting Date - Accumulated Depreciation

(200) USD = (500)USD + 100 USD + 100 USD + 100 USD

Case 3: Add Transactions

The following table shows data that is used in the calculation example that follows.

Attributes	Data
Transaction Date	10/1/2006
Accounting Date	10/1/2006
In-Service Date	3/1/2006
Life	60 periods
Cost	6,000 USD
Accumulated Depreciation	
Calculation Type	Life to Date
Convention	Half-Year
Method	Straight-Line
Depreciate When In Service Switch	Y
Begin Depr Date	7/1/2006
Begin Calc Date	7/1/2006
Remaining Value	6,000 USD
Remaining Life	60 periods
Yearly Depreciation (First year)	600.00 USD
Period Allocation (First year)	60 USD
Prior Period Depreciation	420 USD

Depreciation Results

The following table shows yearly depreciation by period for 2006. Prior period depreciation occurred in periods 3 through 9.

1	2	3	4	5	6	7	8	9	10	11	12	Period
		60	60	60	60	60	60	60	60	60	60	Allowed
									60	60	60	Taken
		60	60	60	60	60	60	60				Difference

Prior Period Depreciation

Here is the prior period depreciation:

Difference Per Period = Period Depreciation Allocation (allowed) - Depreciation Taken

Example Period 7: 60 USD - 0 = 60 USD

Begin Calc Date = Begin Depr Date

Periods from In Service Date to Accounting Date =

7, 8, 9, 10= Periods within 3/1/2006 to 10/1/2006

Prior Period Depreciation = Sum of Difference Per Period for all periods within In Service Date to Accounting Date

420 USD = 60 USD + 60 USD + 60 USD + 60 USD + 60 USD + 60 USD + 60 USD

Case 4: Add Transactions

The following table shows data that is used in the calculation example that follows it.

Attributes	Data
Transaction Date	10/1/2006
Accounting Date	10/1/2006
In-Service Date	3/1/2006
Life	60 periods
Cost	6,000 USD
Accumulated Depreciation	500 USD
Calculation Type	Life to Date

Attributes	Data
Convention	Half-Year
Method	Straight-Line
Depreciate When In Service Switch	Y
Begin Depr Date	7/1/2006
Begin Calc Date	7/1/2006
Remaining Value	6,000 USD
Remaining Life	60 periods
Yearly Depreciation (First year)	600.00 USD
Period Allocation (First year)	60 USD
Prior Period Depreciation	(80) USD

Depreciation Results

The following table shows yearly depreciation by period for 2006. Prior period depreciation occurred in periods 3 through 9.

1	2	3	4	5	6	7	8	9	10	11	12	Period
		60	60	60	60	60	60	60	60	60	60	Allowed
					500				60	60	60	Taken
		60	60	60	(440)	60	60	60				Difference

Prior Period Depreciation

Here is the prior period depreciation:

$$\text{Difference Per Period} = \text{Period Depreciation Allocation (allowed)} - \text{Depreciation Tak}\rightarrow$$

en

Example Period 7: 60 USD - 0 = 60 USD

Begin Calc Date = Begin Depr Date

Periods from In Service to Accounting Date =

3, 4, 5, 6, 7, 8, 9 = Periods within 3/1/2006 to 10/1/2006

Prior Period Depreciation = Sum of Difference Per Period for all periods within In Service Date to Accounting Date

(80) USD = 60 USD + 60 USD + 60 USD + (440) USD + 60 USD + 60 USD + 60 USD

Case 5: Add Transactions

The following table shows data that is used in the calculation example that follows it.

Attributes	Data
Transaction Date	3/1/2006
Accounting Date	10/1/2006
In-Service Date	3/1/2006
Life	60 periods
Cost	6,000 USD
Accumulated Depreciation	
Calculation Type	Remaining Value
Convention	Half-Year
Method	Straight-Line
Depreciate When In Service Switch	N
Begin Depr Date	7/1/2006
Begin Calc Date	7/1/2006
Remaining Value	6,000 USD
Remaining Life	60 periods

Attributes	Data
Yearly Depreciation (First year)	600.00 USD
Period Allocation (First year)	100 USD
Prior Period Depreciation	300 USD

Depreciation Results

The following table shows yearly depreciation by period for 2006. Prior period depreciation occurred in periods 7 through 9.

1	2	3	4	5	6	7	8	9	10	11	12	Period
						100	100	100	100	100	100	Allowed
									100	100	100	Taken
						100	100	100				Difference

Prior Period Depreciation

Here is the prior period depreciation:

Difference Per Period = Period Depreciation Allocation (allowed) - Depreciation Taken

Example Period 7: 100 USD - 0 = 100 USD

Begin Calc Date = Begin Depr Date

Periods from Begin Calc Date to Accounting Date =

7, 8, 9 = Periods within 7/1/2006 to 10/1/2006

Prior Period Depreciation = Sum of Difference Per Period for all periods within Begin Calc Date to Accounting Date

300 USD = 100 USD + 100 USD + 100 USD

Formula-Based Depreciation Methods

PeopleSoft Asset Management is equipped to use the following different formula-based depreciation methods:

- Straight Line

- (IND) Straight Line Percent
- Declining Balance with a Switch to Straight Line
- Declining Balance with Depreciation Limit
- Declining Balance
- Flat Rate
- Sum of the Year's Digits

PeopleSoft Asset Management can calculate depreciation for each of the first six methods using either a schedule or a formula. The formulas that it uses to calculate yearly depreciation for each of these methods are explained in the following pages.

Straight Line

Yearly Straight Line depreciation is calculated using the following formula:

$$NBV \times (\text{Number of Periods to Depreciate} / \text{Remaining Life})$$

Straight Line Depreciation Example

The following table shows data that is used in the depreciation example that follows.

Attributes	Data
Asset Cost	11,000.00 USD
Salvage Value	1,000.00 USD
Asset Basis	10,000.00 USD (Cost - Salvage Value)
Life	60 periods (5 years)
Begin Depr Dt.	07/01/2006

Depreciation Results

The following table shows yearly depreciation and the calculation that is used to produce the result.

Year	Depreciation Calculation	Depreciation Expense
2006	10,000 x (6/60)	= 1000.00

Year	Depreciation Calculation	Depreciation Expense
2007	9000 x (12/54)	= 2000.00
2008	7000 x (12/42)	= 2000.00
2009	5000 x (12/30)	= 2000.00
2010	3000 x (12/18)	= 2000.00
2011	1000 x (6/6)	= 1000.00

(IND) Straight Line Percent

The Straight Line Percent method that is used in India differs from the Straight Line method. Depreciation is calculated based on rates rather than useful life. In addition, the rates also consider the residual or salvage value at the end of the asset useful life. In India the following assumptions are made:

- Assets are depreciated as of the in-service date.
- The minimum rates that are established by statute depreciate 95 percent of the asset cost over the asset useful life.
- An entity is entitled to depreciate at a higher rate, but not lower.

When using Straight Line Percent as the method, you complete the **Percent** field with the depreciation rate. The **Useful Life** field is unavailable. Other fields are ignored for this depreciation calculation. Although residual value is included in the rate, you have to enter salvage value.

Salvage Value acts as a limit. When the NBV reaches this amount, it automatically allocates the rest of the depreciable amount to the last period. Life in Years reflects both years and fractions, such as 8.4. Useful Life and Life in Years are displayed after you save or refresh the page. AM_DEPR_CALC recalculates these fields when it runs. Those assets that are coming from batch processes will calculate only Useful Life and Life in Years when you run AM_DEPR_CALC.

The formula to calculate Useful Life is:

$$(Cost - Salvage Value) / (Cost \times Depr Rate)$$

For example, an asset that is worth \$1,000 and a salvage value of \$50, with a 4.75% annual depreciation rate, using the actual month convention, will have a useful life of 20 years or 240 periods. Sometimes useful life may result in fractional periods.

Year	NBV Begin	Rate	Depr	NBV End
2001	1,000.00	0.0475	47.50	952.50

Year	NBV Begin	Rate	Depr	NBV End
2002	952.50	0.0475	47.50	905.00
2003	905.00	0.0475	47.50	857.50
2004	857.50	0.0475	47.50	810.00
2005	810.00	0.0475	47.50	762.50
2006	762.50	0.0475	47.50	715.00
2007	715.00	0.0475	47.50	667.50
2008	667.50	0.0475	47.50	620.00
2009	620.00	0.0475	47.50	572.50
2010	572.50	0.0475	47.50	525.00
2011	525.00	0.0475	47.50	477.50
2012	477.50	0.0475	47.50	430.00
2013	430.00	0.0475	47.50	382.50
2014	382.50	0.0475	47.50	335.00
2015	335.00	0.0475	47.50	287.50
2016	287.50	0.0475	47.50	240.00
2017	240.00	0.0475	47.50	192.00
2018	192.00	0.0475	47.50	145.00
2019	145.00	0.0475	47.50	97.50
2020	97.50	0.0475	47.50	50.00
		<i>Total Depreciation</i>	950.00	

Remaining Value and Life to Date

Two different ways are available to calculate depreciation adjustments under Indian Straight Line Percent Method:

- Remaining Value
- Life to Date

For instance, in the preceding example, suppose that in the sixth year, the rate must change to 5.28 percent because the government adopts a new rate according to Schedule XIV. Using Remaining Value, the system calculates the useful life. It takes into account the new rate on the original cost. It calculates depreciation based on the NBV minus any residual value over the remaining new useful life, where remaining new useful life means the new useful life minus periods that are already depreciated.

Revised Useful Life:

$$(Cost - Salvage Value) / (Cost \times Depr Rate) \text{ Revised Useful Life: } (1000 - 50) / (1000 \times .0528) = 17.992424$$

Rounded up to 18 years or 216 months.

New Depreciation Amount:

$$(Net Book Value - Limiting Value) / (Revised useful life - Years Depreciated)$$

New Depreciation Amount:

$$(762.5 - 50) / (18 - 5) = 54.8076$$

In the last period, the remaining value will be residual value.

The following table shows the depreciation with the adjustment in the sixth year.

Yearly Start Date	Original Cost	Schedule XIV Rates	Effective Depreciation	Net Book Value	Number of Years
01 JAN 2003	1000.00	0.0475	47.50	952.50	1
01 JAN 2004	952.50	0.0475	47.50	905.00	2
01 JAN 2005	905.00	0.0475	47.50	857.50	3
01 JAN 2006	857.50	0.0475	47.50	810.00	4
01 JAN 2007	810.00	0.0475	47.50	762.50	5
01 JAN 2008	762.50	0.0528	54.81	707.69	6
01 JAN 2009	707.69	0.0528	54.81	652.88	7

Yearly Start Date	Original Cost	Schedule XIV Rates	Effective Depreciation	Net Book Value	Number of Years
01 JAN 2010	652.88	0.0528	54.81	598.08	8
01 JAN 2011	598.08	0.0528	54.81	543.27	9
01 JAN 2012	543.27	0.0528	54.81	488.46	10
01 JAN 2013	488.46	0.0528	54.81	433.65	11
01 JAN 2014	433.65	0.0528	54.81	378.85	12
01 JAN 2015	378.85	0.0528	54.81	324.04	13
01 JAN 2016	324.04	0.0528	54.81	269.23	14
01 JAN 2017	269.23	0.0528	54.81	214.42	15
01 JAN 2018	214.42	0.0528	54.81	159.62	16
01 JAN 2019	159.62	0.0528	54.81	104.81	17
01 JAN 2020	104.82	0.0528	54.81	50.00	18

In the case of Life to Date, the useful life is again recalculated. This method takes into account the new rate on the original cost. Depreciation is based on what the system had calculated if the rate would have been the new rate from the beginning. An adjustment to the prior depreciation amounts is required in this method to reflect the change retroactively. It consists of summarizing all depreciation amounts until the change and comparing with the amount that would have been obtained if the asset had always been calculated based on the new rate.

Useful Life:

$$(Cost - Salvage Value) / (Cost \times Depr Rate)$$

Useful Life:

$$(1000 - 50) / (1000 \times .0528) = 17.992424$$

Rounded up to 18 years or 216 months.

The following table depicts the depreciation if the rate had always been 5.28 percent.

Yearly Start Date	Original Cost	Schedule XIV Rates	Effective Depreciation	Net Book Value	Number of Years	Total Depreciation
01 JAN 2003	1000.00	0.0528	52.80	947.20	1	
01 JAN 2004	947.20	0.0528	52.80	894.40	2	
01 JAN 2005	894.40	0.0528	52.80	841.60	3	
01 JAN 2006	841.60	0.0528	52.80	788.80	4	
01 JAN 2007	788.80	0.0528	52.80	736.00	5	264.00
01 JAN 2008	736.00	0.0528	52.80	683.20	6	
01 JAN 2009	683.20	0.0528	52.80	630.40	7	
01 JAN 2010	630.40	0.0528	52.80	577.60	8	
01 JAN 2011	577.60	0.0528	52.80	524.80	9	
01 JAN 2012	524.80	0.0528	52.80	472.00	10	
01 JAN 2013	472.00	0.0528	52.80	419.20	11	
01 JAN 2014	419.20	0.0528	52.80	366.40	12	
01 JAN 2015	366.40	0.0528	52.80	313.60	13	
01 JAN 2016	313.60	0.0528	52.80	260.80	14	
01 JAN 2017	260.80	0.0528	52.80	208.00	15	
01 JAN 2018	208.00	0.0528	52.80	155.20	16	
01 JAN 2019	155.20	0.0528	52.80	102.40	17	
01 JAN 2020	102.40	0.0528	52.40	50.00	18	

Compare the preceding table that shows what the amount would have been with a constant rate of 5.28 percent versus the following table that shows what the amounts are with a change and an adjustment in the sixth year.

Yearly Start Date	Original Cost	Schedule XIV Rates	Effective Depreciation	Net Book Value	Number of Years	Adjustment
01 JAN 2003	1000.00	0.0475	47.50	952.50	1	
01 JAN 2004	952.50	0.0475	47.50	952.50	2	
01 JAN 2005	905.00	0.0475	47.50	905.00	3	
01 JAN 2006	857.50	0.0475	47.50	857.50	4	
01 JAN 2007	810.00	0.0475	47.50	762.50	5	237.50
31 DEC 2007			26.50	736.00		264.00
01 JAN 2008	736.00	0.0528	52.77	683.23	6	
01 JAN 2009	683.23	0.0528	52.77	630.46	7	
01 JAN 2010	630.46	0.0528	52.77	577.69	8	
01 JAN 2011	577.69	0.0528	52.77	524.92	9	
01 JAN 2012	524.92	0.0528	52.77	472.15	10	
01 JAN 2013	472.15	0.0528	52.77	419.38	11	
01 JAN 2014	419.38	0.0528	52.77	366.62	12	
01 JAN 2015	366.62	0.0528	52.77	313.85	13	
01 JAN 2016	313.85	0.0528	52.77	261.08	14	
01 JAN 2017	261.08	0.0528	52.77	208.31	15	
01 JAN 2018	208.31	0.0528	52.77	155.54	16	

Yearly Start Date	Original Cost	Schedule XIV Rates	Effective Depreciation	Net Book Value	Number of Years	Adjustment
01 JAN 2019	155.54	0.0528	52.77	102.77	17	
01 JAN 2020	102.77	0.0528	52.77	50.00	18	

Adjustment PDP:

Total Depreciation at new rate – Total Depreciation at former rate

Adjustment PDP:

$264 - 237.50 = 26.50$ for the first 5 years.

New Depreciation Amount:

(Net Book Value – Adj PDP - Limiting Value) / (Revised useful life – Years Depreciated)

New Depreciation Amount:

$(762.5 - 26.5 - 50) / (18 - 5) = 52.7692$

Declining Balance with a Switch to Straight Line

Declining Balance with a Straight Line Switch performs two simultaneous equations to calculate yearly depreciation. One equation calculates declining balance depreciation and the other calculates straight line depreciation. PeopleSoft Asset Management then compares the two yearly depreciation amounts and applies whichever is greater.

Note that in this type of calculation the asset's net book value is multiplied by the declining balance percentage times the straight line depreciation percentage.

$NBV \times ((\text{Number of Periods to Depreciate} / \text{Life}) \times \text{DB}\%)$

Declining Balance with a Switch to Straight Line Example

The following table shows data that is used in the depreciation example that follows it.

Attributes	Data
Asset Cost	10,000.00 USD
Life	60 periods (5 years)
Begin Depr Dt.	07/01/2006

Attributes	Data
Declining Balance %	200%

Depreciation Results

The following table shows yearly depreciation and the calculation that is used to produce the result.

Year	Depreciation Calculation	Depreciation Expense
2006	$10,000 \times ((6/60) \times (200/100))$	= 2000.00
2007	$8000 \times ((12/60) \times (200/100))$	= 3200.00
2008	$4800 \times ((12/60) \times (200/100))$	= 1920.00
2009	$2880 \times ((12/60) \times (200/100))$	= 1152.00
2010 x (SL)	$1728 \times (12/18)$	= 1152.00
2011 x (SL)	$576 \times (6/6)$	= 576.00

In this example, in 2010, the straight line depreciation is greater than the declining balance depreciation. Therefore, switch to straight line depreciation. The declining balance calculation for 2010 is $1728 \times ((12/60) \times (200/100)) = 691.20$. In 2011, the straight line depreciation is equal to the declining balance depreciation.

Declining Balance with Depreciation Limit

This calculation type enables you to specify annual depreciation limits based on a percentage of an asset's cost. This method supports asset management practices that are commonly used in some European countries. In environments in which this is legally acceptable, the advantage to this method is that it provides greater decreases in value in the first years of an asset's service. In some environments, a company may use this depreciation method initially and then switch to straight-line when that method provides a greater write-off.

This method runs three calculations and performs comparisons between the results.

First, it calculates using the formula that is already documented for Declining Balance with a Switch to Straight Line:

$$NBV \times ((\text{Number of Periods to Depreciate/Life}) \times DB\%)$$

(See DB column in the table provided with the following example.)

It then calculates using the specified limit percentage of original cost or bet book value:

$NBV \times \text{Limit}\%$

(See MAX column in the table provided with the following example.)

The results of these two calculations are compared and the system determines which amount is lesser. (See Comparison 1 column in the table provided with following example.)

Finally, it calculates using the Straight Line formula:

$NBV \times (\text{Number of Periods to Depreciate} / \text{Remaining Life})$

(See SL column in the table provided with following example.)

Results of the Straight Line calculation are compared with the lesser amount from the first comparison. (Column SL compared with column Comparison 1 in the following table. Comparison 2 column shows when the Straight Line method produces the greater result.)

The greater amount between this final comparison is the annual depreciation amount. (See Depr column in the table after the following table.)

Declining Balance with Depreciation Limit Example

The following table shows data that is used in the depreciation example that follows it.

Attributes	Data
Asset Cost	10,000.00 USD
Life	96 periods (8 years)
Begin Depr Dt.	01/01/2006
Declining Balance %	300%
Limit %	30%

Depreciation Results

The following table shows yearly depreciation and the calculation that is used to produce the result.

Year	NBV	DB	Max (Limit %)	Comparison 1	SL	Comparison 2	Depr.
Year 1	100000	37500	30000	30000	12500		30000
Year 2	70000	26250	21000	21000	10000		21000

Year	NBV	DB	Max (Limit %)	Comparison 1	SL	Comparison 2	Depr.
Year 3	49000	18375	14700	14700	8167		14700
Year 4	34300	12862	10290	10290	6860		10290
Year 5	24010	9004	7203	7203	6003		7203
Year 6	16807	6303	5042	5042	5602	SW	5602
Year 7	11205	4201	3361	3361	5602	SW	5602
Year 8	5602	2101	1681	1681	5602	SW	5602

Declining Balance

For this type of calculation, the declining balance percentage represents a percentage of NBV.

$$NBV \times DB\%$$

When you are depreciating an asset with a declining balance method, the life of the asset is irrelevant. Note that if you used this method alone, an asset would never be fully depreciated. To fully depreciate an asset using the Declining Balance method, you must enter either a book low limit or an end depreciation date. When an asset's NBV reaches its book low limit or end depreciation date, the remaining value is taken in depreciation for that year.

Declining Balance Example

The following table shows data that is used in the depreciation example that follows it.

Attributes	Data
Asset Cost	10,000.00 USD
Salvage Value	1,000.00 USD (not used for calculating asset basis)
Asset Basis	10,000.00 USD
Life	60 periods (5 years)
Begin Depr Dt.	01/01/94

Attributes	Data
Declining Balance %	20%

Depreciation Results

The following table shows yearly depreciation and the calculation that is used to produce the result.

Year	Depreciation Calculation	Depreciation Expense
1994	10,000 x (20/100)	= 2000.00
1995	8000 x (20/100)	= 1600.00
1996	6400 x (20/100)	= 1280.00
1997	5120 x (20/100)	= 1024.00
1998	4096 x (20/100)	= 819.20
1999	3276.80 x (20/100)	= 655.54
2000	2621.21 x (20/100)	= 524.24

Calculations continue in this manner until the book low limit or end depreciation date is reached. If no book low limit or end depreciation date is specified, the asset never fully depreciates.

Flat Rate

The formula for calculating Flat Rate depreciation is simple.

$$\text{Basis} \times \text{Flat \%}$$

Flat Rate with an Averaging Option

You can combine the Flat Rate depreciation method with either a monthly or yearly averaging option. These options are typically used by utility companies to depreciate composite assets. When these options are used, PeopleSoft Asset Management uses up to three separate formulas to calculate depreciation for adjustments—one for calculating current period depreciation, one for calculating following period depreciation, and one for calculating depreciation for all subsequent periods.

These formulas are used only for calculating additional depreciation resulting from adjustments to the average balance. And these adjustments are applied only to the current year. For all subsequent years, as well as the first time it is done, the system calculates depreciation by applying the flat rate percentage to the average balance and allocating this amount among the periods.

Because of the averaging option, all adjustment transactions must take effect from the beginning of the year to its end. Therefore, current period depreciation is calculated after each transaction on a year-to-date basis.

As adjustments are made, additional depreciation is posted for each period that is affected.

Note: Using the flat rate depreciation method causes any depreciation to be posted to the end of the calendar. If this is not your intention, you must enter a low limit of .01 when you first select the depreciation method on the Asset Book Definition page group for this asset. If you have not already done this, update the **Depreciation Method** field on the General 2 page by selecting *Flat Rate* and entering .01 in the **Low Limit** additional field that appears.

Monthly Averaging Option

Review the following examples of monthly averaging calculations resulting from a \$2000 adjustment made in period 3. The asset is depreciated at 12%.

((Adjustment Amount / 2) x Flat Rate %) x Period Allocation

Calculation for the current period (YTD):

((2,000 USD / 2) x 12%) x 3/12 = 30 USD

Current Period Depreciation + ((Adjustment Amount x Flat Rate %) x Period Allocation)

Calculation for the following period:

30 USD + ((2,000 USD x 12%) x 1/12) = 50 USD

(Adjustment Amount x Flat Rate %) x Period Allocation

Calculation for Subsequent Periods:

(2,000 USD x 12%) x 1/12 = 20 USD

Note: The only exception to this rule occurs when the following period crosses into another fiscal year. When this is the case, all periods but the current one are calculated using the full value of the transaction. Current Period depreciation is not added to the following period depreciation.

Yearly Averaging Option

When using the yearly averaging option, you'll want to estimate financial activity for the year. The original estimate should be posted as an add transaction in the first period of the year and subsequently adjusted as the actual figures become available.

Review the following example of the yearly averaging option using the same 2,000 USD adjustment in Period 3. The asset is depreciated at 12 percent.

((Adjustment Amount / 2) x Flat Rate %) x Period Allocation

Calculation for the current period (YTD):

((2,000 USD / 2) x 12%) x 3/12 = 30 USD

((Adjustment Amount / 2) x Flat Rate %) x Period Allocation

Calculation for all subsequent periods:

$$((2,000 \text{ USD} / 2) \times 12\%) \times 1/12 = 10 \text{ USD}$$

Sum of the Years' Digits

Yearly Sum of the Years' Digits depreciation is calculated using the following formula:

$$((\text{Remaining Years of Life} / \text{Sum of Years Remaining}) \times \text{NBV}) \times \% \text{ of Year to Depreciate}$$

Sum of the Years Digits Example

The following table shows data that is used in the depreciation example that follows it.

Attributes	Data
Asset Cost	3700.00
Salvage Value	100.00
Asset Basis	3600.00
Life	36 periods (3 years)
Begin Depr Dt.	07/01/2006

Depreciation Results

The following table shows yearly depreciation and the calculation that is used to produce the result.

Year	Depreciation Calculation	Depreciation Expense
2006	$3600 \times (3/(1+2+3)) \times (6/12)$	= 900.00
2007	$2700 \times (2.5/(1+2+3/2)) \times (12/12)$	= 1500.00
2008	$1200 \times (1.5/(1+ 2/2)) \times (12/12)$	= 900.00
2009	$300 \times (0.5/(1/2)) \times (6/6)$	= 300.00

Calculation for the first year Sum of Years Remaining = $3/(1+2+3)$

Units of Production

Units of production depreciation differs from other methods in that it does not depreciate an asset based on its periods of life, but rather on its production detail. In this method, an asset is assumed to have a

fixed lifetime production capacity—a maximum number of units it can produce. Thus, a fixed amount of depreciation is allotted to each unit of production. The net book value of the asset is then multiplied by the number of units that are produced in a period over the remaining units to be produced to determine how much depreciation to take for that period.

$$NBV \times (\text{Units Produced} / \text{Units Remaining})$$

Production detail for the asset is entered into the Units of Production table (**Set Up Financials/Supply Chain > Product Related > Asset Management > Depreciation > Units of Production**). Each time new detail is added to this table, open transactions are created for each asset that is associated with it. You should recalculate depreciation each time you add to or change the detail in the Units of Production table.

Units of Production Example

The following table shows data that is used in the depreciation example that follows it.

Attributes	Data
Asset Cost	10,000.00 USD
Total Estimated Production Units	40,000
Production Units for each month	10,000

Depreciation Results

The following table shows yearly and monthly depreciation and the calculation that is used to produce the result.

Year, Month	Depreciation Calculation	Depreciation Expense
Year 1, Month 1	$10,000 \times (10,000/40,000)$	= 2500.00
Year 1, Month 2	$7500 \times (10,000/30,000)$	= 2500.00
Year 1, Month 3	$5000 \times (10,000/20,000)$	= 2500.00
Year 1, Month 4	$2500 \times (10,000/10,000)$	= 2500.00

Note: Units remaining are calculated by summing the production units for all remaining periods that are set up on the Units of Production page (**Set Up Financials/Supply Chain > Product Related > Asset Management > Depreciation > Units of Production**).

Calculating Depreciation When Salvage Value Exceeds Net Book Value (NBV)

There are instances when the residual value (salvage value) of an asset may increase to an amount equal to or greater than the asset's carrying amount (NBV.) If that situation arises, PeopleSoft provides the following treatments for depreciation calculation, depending upon statutory requirements:

- Stop depreciation calculation when salvage value exceeds NBV.
- Allow negative depreciation when salvage value exceeds NBV.

Stop Depreciation When Salvage Value Exceeds NBV

In compliance with International Accounting Standards (IAS) and Generally Accepted Accounting Principles (GAAP), PeopleSoft provides the option to stop the depreciation calculation in the event the salvage value of an asset exceeds that of its NBV.

See “Enabling Options to Stop Negative Depreciation” (Asset Lifecycle Management Fundamentals).

Stop Depreciation Example

The following table shows data that is used in the depreciation example that follows it:

Attributes	Data
Transaction Date	January 1, 2006
Accounting Date	January 1, 2006
In Service Date	January 1, 2006
Calculation Type	Life to Date
Convention	Actual Month
Method	Straight Line
Asset Cost	75,000.00
Salvage Value (Increased from 0 to 50,000 on January 1, 2008)	50,000.00
Accumulated Depreciation (24 months in service)	30,000.00

Attributes	Data
Net Book Value at January 1, 2008	45,000.00
Asset Useful Life	60 months

Depreciation Result - Stop Depreciation

The following table shows the result of the depreciation calculation when the Stop Depr option is selected:

Year	Depreciation Calculation	Depreciation Expense
January 1 through December 31, 2006	$75,000 \times (12/60 \text{ months})$	15,000.00
January 1 through December 31, 2007	$60,000 \times (12/48 \text{ months})$	15,000.00
January 1 through December 31, 2008	Depreciation stopped	0
January 1 through December 31, 2009	Depreciation stopped	0
January 1 through December 31, 2010	Depreciation stopped	0

Stop Depreciation Example with Additional Adjustment of Salvage Value

The following table shows data that is used in the depreciation example that follows it:

Attributes	Data
Transaction Date	January 1, 2006
Accounting Date	January 1, 2006
In Service Date	January 1, 2006
Calculation Type	Life to Date
Convention	Actual Month
Method	Straight Line

Attributes	Data
Asset Cost	75,000.00
Salvage Value (Increased from 0 to 50,000 at January 1, 2008)	50,000.00
Accumulated Depreciation (24 months in service)	30,000.00
Net Book Value at January 1, 2008	45,000.00
New Salvage Value - (Reduced to zero at January 1, 2009)	0
Asset Useful Life	60 months

Depreciation Result - Stop Depreciation with Additional Adjustment of Salvage Value

The following table shows the result of the depreciation calculation when the Stop Depr option is selected and there is an additional adjustment of salvage value:

Year	Depreciation Calculation	Depreciation Expense
January 1 through December 31, 2006	$75,000 \times (12/60 \text{ months})$	15,000.00
January 1 through December 31, 2007	$60,000 \times (12/48 \text{ months})$	15,000.00
January 1 through December 31, 2008	Depreciation stopped	0
January 1 through December 31, 2009 (salvage value reduced to zero at January 1, 2009)	(NBV - Salvage Value = 45,000) (45,000 - 0 = 45,000) $45,000 \times (12/24 \text{ months})$	22,500.00
January 1 through December 31, 2010	$22,500 \times (12/12 \text{ months})$	22,500.00

Allow Negative Depreciation

The alternate approach to handling an asset when the NBV becomes less than the salvage value is to allow the system to generate negative depreciation until the NBV equals the salvage value at the end of the asset's useful life. To use this approach, simply do not select the **Stop Depr when NBV < Salvage** options.

Allow Negative Depreciation

The following table shows data that is used in the depreciation example that follows it:

Attributes	Data
Transaction Date	January 1, 2006
Accounting Date	January 1, 2006
In Service Date	January 1, 2006
Calculation Type	Life to Date
Convention	Actual Month
Method	Straight Line
Asset Cost	75,000.00
Salvage Value (Increased from 0 to 50,000 at January 1, 2008)	50,000.00
Accumulated Depreciation (24 months in service)	30,000.00
Net Book Value at January 1, 2008	45,000.00
Asset Useful Life	60 months

Depreciation Result - Allow Negative Depreciation

The following table shows the result of the depreciation calculation when the Stop Depr option is not selected:

Year	Depreciation Calculation	Depreciation Expense
January 1 through December 31, 2006	$75,000 \times (12/60 \text{ months})$	15,000.00
January 1 through December 31, 2007	$60,000 \times (12/48 \text{ months})$	15,000.00
January 1 through December 31, 2008 (Salvage Value increase on January 1, 2008)	$(\text{NBV} - \text{Salvage Value}) \times (12/36 \text{ months})$ $(45,000 - 50,000) \times (12/36 \text{ months})$	- 1,666.67

Year	Depreciation Calculation	Depreciation Expense
January 1 through December 31, 2009	(NBV - Salvage Value) x (12/24 months) (46,666.67 - 50,000) x (12/24 months)	- 1,666.67
January 1 through December 31, 2010	(NBV - Salvage Value) x (12/12 months) (48,333.33 - 50,000) x (12/12 months)	- 1,666.67

Allow Negative Depreciation with Additional Adjustment of Salvage Value

The following table shows data that is used in the depreciation example that follows it:

Attributes	Data
Transaction Date	January 1, 2006
Accounting Date	January 1, 2006
In Service Date	January 1, 2006
Calculation Type	Life to Date
Convention	Actual Month
Method	Straight Line
Asset Cost	75,000.00
Salvage Value (Increased from 0 to 50,000 at January 1, 2008)	50,000.00
Accumulated Depreciation (24 months in service)	30,000.00
Net Book Value at January 1, 2008	45,000.00
New Salvage Value - (Reduced to zero at January 1, 2009)	0
Asset Useful Life	60 months

Depreciation Result - Allow Negative Depreciation with Additional Adjustment to Salvage Value

The following table shows the result of the depreciation calculation when the Stop Depr option is not selected and there is an additional adjustment to salvage value:

Year	Depreciation Calculation	Depreciation Expense
January 1 through December 31, 2006	$75,000 \times (12/60 \text{ months})$	15,000.00
January 1 through December 31, 2007	$60,000 \times (12/48 \text{ months})$	15,000.00
January 1 through December 31, 2008 (Salvage value increase on January 1, 2008)	$(\text{NBV} - \text{Salvage Value}) \times (12/36 \text{ months})$ $(45,000 - 50,000) \times (12/36 \text{ months})$	- 1,666.67
January 1 through December 31, 2009 (Salvage value reduced to zero on January 1, 2009)	$(\text{NBV} - \text{Salvage Value}) \times (12/24 \text{ months})$ $(46,666.67 - 0) \times (12/24 \text{ months})$	23,333.34
January 1 through December 31, 2010	$(\text{NBV} - \text{Salvage Value}) \times (12/12 \text{ months})$ $(23,333.33 - 0) \times (12/12 \text{ months})$	23,333.33

PeopleSoft Asset Management Reports

PeopleSoft Asset Management Reports

These tables list the PeopleSoft Asset Management reports, sorted alphanumerically by report ID within each of the following report categories. If you need more information about a report, refer to the report details at the end of this topic.

Note: You may see both of the terms XML Publisher (XMLP) and BI Publisher, depending on the version of your PeopleTools installation and the bundle version of your application. As of PeopleTools 8.52, references to XML Publisher (XMLP) have changed to BI Publisher. This does not denote a change to the reports; only the naming convention has changed.

Note: For samples of these reports, see the Portable Document Format (PDF) fields that are published with your online documentation.

Asset Set Up Lists

<i>Report ID and Report Name</i>	<i>Description</i>	<i>Run Control Page</i>
AMBU1000 Asset Management Units/Books	Lists all valid business units and asset books. (BI Publisher)	RUN_AMBU1000
AMAE1000 List of Accounting Entry Templates	Lists all accounting entry templates by category. (BI Publisher)	RUN_AMAE1000
AMAE1100 Book Code Discrepancy Report	Lists book code discrepancies where accounting entry templates do not meet the book code validations for pairs distribution types. (SQR)	RUN_AMAE1000
AMAS1100 Asset Categories Report	Lists Asset Categories (BI Publisher).	RUN_AMAS1100

Transaction Reports

Report ID and Report Name	Description	Run Control Page
AMAS1600 List of Asset Warranties	Lists all of the warranties that are in place for a specified business unit as of a date that you select. (BI Publisher)	RUN_AMAS1600
AMAS1700 List of Asset Licenses	Lists asset licenses. (BI Publisher)	RUN_AMAS1700
AMAS2000 Cost Activity	Sorts cost activity by ChartField, by Category, or by Account (SQR). Use the PeopleSoft Asset Management report formatting features to include/exclude data and append suffixes to identify report types.	RUN_AMAS2000
AMAS2100 Asset Acquisitions by ChartField	Lists asset information and also includes Cost, LTD and YTD Depreciation and Net Book Value with ChartField, Book and Report totals. (SQR)	RUN_AMAS2100
AMAS2110 Asset Acquisitions by In Service Date	Lists asset information and also includes Cost, LTD and YTD Depreciation and Net Book Value with ChartField, In-service Period/Year, Book and Report totals. (SQR)	RUN_AMAS2100
AMAS2200 Assets by Location	Lists information on assets by location. (SQR)	RUN_AMAS2200
AMAS2210 Assets by Asset ID	Lists assets by Asset ID. (SQR)	RUN_AMAS2200
AMAS2300 Asset Transfers by ChartField	Lists asset transfers transactions ordered by ChartField. (SQR)	RUN_AMAS2300
AMAS2400 Asset Reclassifications	Lists asset reclassifications ordered by ChartField. (SQR)	RUN_AMAS2400
AMAS2201 Hazardous Assets by Location	List assets designated as hazardous, sorted by location. (SQR)	RUN_AMAS2201

Report ID and Report Name	Description	Run Control Page
AMCH1000 Asset Component Hierarchy Move	List asset component hierarchy moves made through the Manage Component Hierarchy transaction (SQR)	RUN_AMCH1000

Capital Acquisition Planning Reports

Report ID and Report Name	Description	Run Control Page
AMCP2000 Capital Acquisition Plans	Lists capital acquisition planning information. (SQR)	RUN_AMCP2000
AMCP2010 Capital Acquisition Plans by Department	Lists capital acquisition planning by department. (SQR)	RUN_AMCP2000
AMCP2100 Capital Acquisition Planning Assets	Lists capital acquisitions planning by asset ID. (SQR)	RUN_AMCP2000

Depreciation Reports

Report ID and Report Name	Description	Run Control Page
AMDP2000 Depreciation Activity	Sorts cost activity by ChartField. (SQR), by Category, or by Account. Use the PeopleSoft Asset Management report formatting features to include/exclude data and append suffixes to identify report types.	RUN_AMDP2000
AMDP2021 Depreciation Activity by Alternate Account	Sorts depreciation activity by alternate account. (SQR)	RUN_AMDP2000
AMDP2100 Net Book Value	Sorts cost activity by ChartField, by Category, Location, or by Account (SQR). Use the PeopleSoft Asset Management report formatting features to include/exclude data and append suffixes to identify report types. This report also provides options for assets that have had their depreciation stopped.	RUN_AMDP2100

Report ID and Report Name	Description	Run Control Page
AMDP2121 Asset Net Book Value by Alternate Account	Sorts asset net book value information by alternate account. (SQR)	RUN_AMDP2100
AMDP2150 Group Member Estimated NBV	Lists estimated depreciation accumulation of the member. (SQR)	RUN_AMDP2150_RQST
AMDP2200 Depreciation by Period	Sorts assets by period depreciation at asset, category, department, book, or project levels. (SQR) Use the PeopleSoft Asset Management report formatting features to include/exclude data.	RUN_AMDP2200
AMDP2300 Depreciation by Fiscal Year	Sorts assets by fiscal year depreciation at asset, category, project, department, or book levels. (SQR) Use the PeopleSoft Asset Management report formatting features to include/exclude data.	RUN_AMDP2300
AMGL1000 AM to GL Reconciliation by Department (BI Publisher)	Reconciles AM to GL by ChartField. (BI Publisher) BI Publisher reports require manual changes when there are ChartField configurations. BI Publisher reports do not require manual changes to support ChartField configuration.	RUN_RPT_TBLS_REPS
AMGL1010 AM to GL Reconciliation by Category (BI Publisher)	Reconciles AM to GL by category. (BI Publisher) BI Publisher reports require manual changes when there are ChartField configurations. BI Publisher reports do not require manual changes to support ChartField configuration.	RUN_RPT_TBLS_REPS
AMNB1000 Asset NBV by ChartField (BI Publisher)	Sorts net book value by ChartField. (BI Publisher) BI Publisher reports require manual changes when there are ChartField configurations. BI Publisher reports do not require manual changes to support ChartField configuration.	RUN_RPT_TBLS_REPS

Report ID and Report Name	Description	Run Control Page
AMNB1010 Asset NBV by Category (BI Publisher)	Lists net book value related amounts sorted by category. (BI Publisher) BI Publisher reports require manual changes when there are ChartField configurations. BI Publisher reports do not require manual changes to support ChartField configuration.	RUN_RPT_TBLS_REPS
AMNB1030 Asset NBV by Location (BI Publisher)	Lists net book value related amounts sorted by location. (BI Publisher) BI Publisher reports require manual changes when there are ChartField configurations. BI Publisher reports do not require manual changes to support ChartField configuration.	RUN_RPT_TBLS_REPS

Impairment Reports

Report ID and Report Name	Description	Run Control Page
AMIMP001 Impaired Asset Value Report by Category	Lists impaired asset values summarized by asset category. (BI Publisher)	AM_IMP_RPT_RUN_CTL
AMIMP002 Impaired Asset Value Report by CGU	Lists impaired asset values summarized by asset CGU. (BI Publisher)	AM_IMP_RPT_RUN_CTL

Account Activity Reports

Report ID and Report Name	Description	Run Control Page
AMAS2030 Account Activity Summary - Cost	Lists cost and related transaction amounts per account with ChartFields, book, and report totals. (SQR)	RUN_AMAE2000
AMDP2030 Account Activity Summary - Depreciation	Lists depreciation and related transaction amounts per account with ChartFields, book, and report totals. (SQR)	RUN_AMAE2000

Report ID and Report Name	Description	Run Control Page
AMDP2130 Account Activity Summary - Net Book Value	Lists cost balance, YTD, LTD, depreciation and NBV amount per account. (SQR)	RUN_AMAE2000
AMAS2031 AltAccount Activity Summary - Cost	Lists cost and related transaction amounts per account with ChartFields, book, and report totals. (SQR)	RUN_AMAE2001
AMAS2021 Cost Activity by Alt Account	Sorts cost activity by Alternate Account. (SQR)	RUN_AMAS2000
AMDP2031 AltAccount Activity Summary - Depreciation	Lists depreciation and related transaction amounts per account with ChartFields, book, and report totals. (SQR)	RUN_AMAE2001
AMDP2131 AltAccount Activity Summary - Net Book Value	Lists cost, depreciation and net book value amounts per account with ChartFields, book, and report totals. This report is similar to the Account Activity Summary Report. (SQR)	RUN_AMAE2001

Accounting Entry Reports

Report ID and Report Name	Description	Run Control Page
AMAE2100 Accounting Entry Detail	Lists accounting entry details. (SQR)	RUN_AMAE2100
AMAE2101 Alternate Account Entry Detail	Retrieves alternate account entry information with ChartField, alternate account and report totals. (SQR)	RUN_AMAE2101
AMAE2102 Retired as Expensed Accounting Entry	Retrieves accounting entry information for assets that are disposed as expensed. (SQR)	RUN_AMAE2102
AMAE2110 Accounting Entry Detail - Cost	Lists cost and related transaction amounts per asset, with ChartFields, book, and report totals. (SQR)	RUN_AMAE2000
AMAE2120 Accounting Entry Detail - Depreciation	Lists depreciation and related transaction amounts per asset, with ChartFields, book, and report totals. (SQR)	RUN_AMAE2000

Report ID and Report Name	Description	Run Control Page
AMAE2130 Accounting Entry Detail - Net Book Value	Lists cost balance, YTD, and LTD depreciation and NBV amounts per asset. (SQR)	RUN_AMAE2000
AMAE2111 Alt Acct Entry Detail – All	Gather alternate account entry detail information. Lists cost beginning and ending balance with related transaction amounts. (SQR)	RUN_AMAE2001
AMAE2121 Alt Acct Entry Detail – Depr	Gather alternate account entry detail information. Lists cost beginning and ending balance with related transaction amounts. (SQR)	RUN_AMAE2001
AMAE2131 Alt Acct Entry Detail – NBV	Lists Cost Balance, YTD, and LTD Depreciation and NBV amount per asset. (SQR)	RUN_AMAE2001

Physical Inventory Reports

Report ID and Report Name	Description	Run Control Page
AMPI2000 Physical Inventory Extract	Gathers PI extract data. (SQR)	RUN_AMPI2000
AMPI2100 Physical Inventory Scan Data	Gathers PI scan data. (SQR)	RUN_AMPI2000
AMPI2200 Physical Inventory Results - INVENTORIED	Gathers PI inventoried results. (SQR)	RUN_AMPI2000
AMPI2210 Physical Inventory Results - UNDER	Gathers PI unders results for financial and non-financial assets. (SQR)	RUN_AMPI2000
AMPI2220 Physical Inventory Results - OVER	Gathers PI overs results. (SQR)	RUN_AMPI2000
AMDE4001 Inventory Report (Detail Version)	Lists detailed information about assets within inventory. (BI Publisher)	RUN_AMAS2200

Report ID and Report Name	Description	Run Control Page
AMDE4002 Inventory Report (Short Version)	Lists summarized information about assets within inventory. (BI Publisher)	RUN_AMAS2200

Lease Reports

Note: If you have migrated your Asset Management lease data into Lease Administration (per PeopleSoft's compliance with ASC 842 and IFRS 16 lease accounting standards), these reports no longer apply.

Report ID and Report Name	Description	Run Control Page
AMLE2000 Lease Summary Information	Lists lease summary information. (SQR)	RUN_AMLE2000
AMLE2100 Lease Detail Information	Lists lease detail information. (SQR)	RUN_AMLE2000
AMLE2200 Lease Amortization Schedule	Lists lease detail information. (SQR)	RUN_AMLE2200
AMLE2310 Lease Footnote Disclosure Summary	Lists all outstanding lease commitments for five years and provides the monthly lease payment and yearly totals. (SQR)	RUN_AMLE2300
AMLE2300 Lease Footnote Disclosure Detail	Lists all outstanding lease commitments for five years and provides the monthly lease payment and yearly totals. (SQR)	RUN_AMLE2300
AMLE2400 Lease Expiration	Lists all leases expiring in a certain number of days from a specified date, or leases expiring within a date range that you select. (SQR)	RUN_AMLE2400
AMAP1001 AP/AM Lease Payment Reconciliation Report	Compares information about the lease payments from the Asset Management tables with the voucher information that is automatically generated and stored in the Payables tables.	RUN_AMAPPYMNTREC

Retirement Reports

Report ID and Report Name	Description	Run Control Page
AMRT2000 Retirement by ChartField	Sorts retirement information by ChartField. (SQR)	RUN_AMRT2000
AMRT2010 Retirement by In Service Date	Lists retirement information with totals per in service year/period. (SQR)	RUN_AMRT2000
AMRT2100 Retirement Activity	Lists retirement related information. (SQR)	RUN_AMRT2100
AMBI1000 AM/Billing Transaction Status	Create the Assets Pending to Bill and Invoiced report. Lists the status of the transactions sent to Billing.	RUN_AMBI1000
AMRET001 Auto-Retired Assets	Lists all auto-retired assets. (SQR)	RUN_AMRET001

U.S. Tax Reports

Report ID and Report Name	Description	Run Control Page
AMTX3000 Tax Acquisitions	Lists acquisition information for tax purposes. (SQR) <hr/> Note: This report can be run in detail or summary mode. <hr/>	RUN_AMTX3000
AMTX3100 Tax Adjustments	Lists adjustment information for tax purposes. (SQR)	RUN_AMTX3000
AMTX3200 Tax Retirements	Lists adjustment information for tax purposes. (SQR) This report can be run in detail or summary mode.	RUN_AMTX3000
AMTX3210 Tax Retirement Capital Gains	Lists retirement capital gains information for tax purposes. (SQR)	RUN_AMTX3000
AMTX3220 Like Kind Exchanges Activity	Use this report to review LKE activity. (SQR).	RUN_AMTX3000

Report ID and Report Name	Description	Run Control Page
AMTX3500 Tax Depreciation	Gathers depreciation information for tax purposes. (SQR)	RUN_AMTX3000
AMTX3610 Tax Depreciation for Current Year Assets	Similar to Tax Depreciation report, ordered by fiscal year/period or date range. (SQR)	RUN_AMTX3000
AMTX3620 Tax Depreciation for Prior Year Assets	Similar to Tax Depreciation report, ordered by fiscal year/period or date range. (SQR)	RUN_AMTX3000
AMTX3630 Tax Depreciation – Listed Property	Gathers depreciation information relevant to listed property. (SQR)	RUN_AMTX3000
AMTX3640 Generate Bonus Depreciation Tax Reports	This report is used in conjunction with the bonus depreciation. Use to review bonus depreciation amounts for Non-Listed Property.	RUN_AMTX3000
AMTX3650 Generate Bonus Depreciation Tax Reports	This report is used in conjunction with the bonus depreciation. Use to review bonus depreciation amounts for Listed Property with business use over 50%.	RUN_AMTX3000
AMTX4000 Alternative Minimum Tax (AMT)	Gathers alternative minimum tax information. (SQR) <hr/> Note: This report can be run in detail or summary mode. <hr/>	RUN_AMTX4000
AMTX4100 Adjusted Current Earnings Worksheet (ACE)	Lists adjusted current earnings information. (SQR)	RUN_AMTX4000
AMTX4200 40% Rule Analysis Report	Run to comply with the US Tax 40% Rule. (SQR) <hr/> Note: If you add over 40% of your assets in the 4 th quarter, you must update the convention from mid-year to mid-quarter under certain US requirements. <hr/> This report can be run in detail or summary mode.	RUN_AMTX4200

Report ID and Report Name	Description	Run Control Page
AMTX4300 AMT Retirements	Gathers alternative minimum tax information from retirements. (SQR)	RUN_AMTX4000
AMTX4400 ACE Retirements	Gathers adjusted current earnings information from retirements. (SQR)	RUN_AMTX4000

Global Reports

Report ID and Report Name	Description	Run Control Page
AMTX10AU AUS RD Tax Deductions	View the amount of research and development concessions that can be claimed. (SQR)	RUN_AMTX10AU
AMTX20AU Tax Credits by Category (Australia)	Lists total tax credits by business unit. (SQR)	RUN_AMTX20AU
AMRT10AU Retirement Activity (AUS)	Lists retirement related information relevant to Australian Retirements for a business unit and book. (SQR)	RUN_AMRT10AU
AMRT20AU Retirement Detail by ChartField (Australia)	Lists assets that have been partially or fully retired in the periods specified for Australia sorted by ChartField. (SQR)	RUN_AMRT20AU
AMTX10CA CCA Year End Updates CAN	(CAN) Creates and prints columns of information required by Revenue Canada and CCA year end results. (BI Publisher)	RUN_AMTX10CA
AMTX11CA CCA Report	(CAN) Creates and prints columns of information required by Revenue Canada and CCA year end results. (BI Publisher)	RUN_AMTX10CA
AMTX30AU Tax CCP – AUS	Monitors CCP adjustments and the review process. (SQR)	RUN_AMTX30AU
AMFR2100 French Retirement Activity	Lists retirement related information relevant to French Retirements. (SQR)	RUN_AMDP2100

Report ID and Report Name	Description	Run Control Page
AMFR2120 French Net Book Value Account	Reports French asset net book value information.	RUN_AMDP2100
AMFR2121 French Net Book Value by Alternate Account	Similar to Asset Net Book Value by Alternate Account, listing French depreciation related information. (SQR)	RUN_AMDP2100
AM_FV_REPORT Fair Value Report	Facilitates in the required disclosures of detail and summarized fair value activity.	AM_FV_RUN_CTL
AMDE1000 Asset History Sheet by Category	(DEU) Shows the original asset cost beginning in year 2 of the asset's life. (BI Publisher)	RUN_AMDE1000
AMDE1001 Asset History Sheet by Account	(DEU) Shows the original Asset Cost beginning in year 2 of the asset's life. (BI Publisher)	RUN_AMDE1000
AMDE1002 Asset History Sheet Summary	(DEU) Shows the original Asset Cost beginning in year 2 of the asset's life. (BI Publisher)	RUN_AMDE1000
AMDE1101 Depreciation History	(DEU) Lists chronological history of asset depreciation, including any extraordinary depreciation. (BI Publisher)	RUN_AMDE1000
AMDE1102 Extraordinary Depreciation History	(DEU) Lists chronological detailed history of extraordinary asset depreciation. (BI Publisher)	RUN_AMDE1000
AMDE5001 Reconciliation AP/AM (BI Publisher)	(DEU) Reconciles AP Asset Vouchers with AM asset transaction information. (BI Publisher) BI Publisher reports require manual changes when there are ChartField configurations. BI Publisher reports do not require manual changes to support ChartField configuration.	RUN_AMDE5000
AMBT1000 Business Tax	(JPN) Gathers business tax information on a specific account and location. (SQR)	RUN_AMBT1000

Report ID and Report Name	Description	Run Control Page
AMBT1010 Business Tax by Alternate Account	(JPN) Gathers business tax information on a specific alternate account and location. (SQR)	RUN_AMBT1000
AMED1000 Extended Depreciation	(JPN) Gathers business tax information on assets that have extended depreciation. (SQR)	RUN_AMED1000
AMAD1000 Advanced Depreciation Amount	Obtains the advanced depreciation amount for the specified asset ID range. (BI Publisher)	RUN_AMAD1000
AMAD1010 Advanced Depreciation Reverse Amount	Obtains reversal amounts for the specified asset ID range. (BI Publisher)	RUN_AMAD1000
AMIMP001 Imp Asset Value Report by Category	Review impairment asset values by category. (BI Publisher)	RUN_AMIMP001
AMIMP002 Imp Asset Value Report by CGU	Review impairment asset values by CGU. (BI Publisher)	RUN_AMIMP001
AMSP1000 Reserve Detail by Asset ID	Obtains reversal amounts for the specified Asset ID range. (BI Publisher)	RUN_AMSP1000
AMSP1010 Reserve Summary by Category	Lists reserve amounts and details for fiscal years by asset ID. (BI Publisher)	RUN_AMSP1000
AMSP1020 Reverse Detail by Asset ID	Lists reverse amounts and details for fiscal years by Asset ID. (BI Publisher)	RUN_AMSP1000
AMSP1030 Reverse Summary by Category	Lists summarized reverse information by category. (BI Publisher)	RUN_AMSP1000
EU_2054 2054ab Reports by Account	(FRA) View information on the asset, its cost and net book value, information on all transactions that occurred in the specified reporting year, including depreciation and yearly depreciation. (BI Publisher)	EU_AM_RUNCNTRL

Report ID and Report Name	Description	Run Control Page
EU_2055A 2055a Reports by Account	(FRA) View information on the asset, its cost and net book value, information on all transactions that occurred in the specified reporting year, including depreciation and yearly depreciation. (BI Publisher)	EU_AM_RUNCNTRL
EU_2055B 2055b Reports by Account	(FRA) View information on the asset, its cost and net book value, information on all transactions that occurred in the specified reporting year, including depreciation and yearly depreciation. (BI Publisher)	EU_AM_RUNCNTRL
EU_205X1 2054ab Reports by Alt Account	(FRA) View information on the asset, its cost and net book value, information on all transactions that occurred in the specified reporting year, including depreciation and yearly depreciation. (BI Publisher)	EU_AM_RUNCNTRL
EU_205X2 2054a Reports by Alt Account	(FRA) View information on the asset, its cost and net book value, information on all transactions that occurred in the specified reporting year, including depreciation and yearly depreciation. (BI Publisher)	EU_AM_RUNCNTRL
EU_205X3 2054b Reports by Alt Account	View information on the asset, its cost and net book value, information on all transactions that occurred in the specified reporting year, including depreciation and yearly depreciation. (BI Publisher)	EU_AM_RUNCNTRL
AMLT1000 Japanese Local Tax Roll	(JPN) Local tax report. (SQR)	RUN_AMLT1000
AMLT1100 Japanese Local Tax Increase All Asset List	(JPN) Local tax increase report. (SQR)	RUN_AMLT1100
AMLT1200 Japanese Local Tax Decrease All Asset List	(JPN) Local tax decrease report. (SQR)	RUN_AMLT1100

Report ID and Report Name	Description	Run Control Page
AMNT1000 Japanese National Tax	(JPN) List depreciation calculation details to be reported to the Japanese Tax Office. The report includes all required information for the National Depreciable Asset Tax Return called Beppyo 16(1), (2) in Japan. (SQR)	RUN_AMNT1000
AMDP2500 Fixed Assets Register Report	(ITA) Run to comply with Italian article 16, D.P.R. 600/73. The fixed asset book lists information relevant to fixed assets. (SQR)	RUN_AMDP2500
AMDP2510 Assets Register INDIA	(IND) Run to generate an historical record of assets over the fiscal year period to comply with The Indian Tax Depreciation Act (Indian Income Tax Act 1961). Can generate by business unit or tax/reporting entity. (SQR).	RUN_AMDP2510
AMTX2000 Depreciation Balance IND	(IND) Calculate the annual tax depreciation balances for India. (BI Publisher)	RUN_AMTX2000

Using Oracle Business Intelligence (BI) Publisher Reports to Support Configured ChartFields

Oracle BI Publisher (formerly XMLP) technology streamlines report and form generation and is accessible from PeopleTools 8.52 PS Query and all PeopleTools 8.52-based applications and beyond. This technology enables PeopleSoft to deliver BI Publisher reports. The BI Publisher reports do not require manual changes to support ChartField configuration. The report listing in this topic indicates in the usage paragraph if a report is delivered in BI Publisher format.

See For more information: *PeopleTools: BI Publisher for PeopleSoft*

