

---

# PeopleSoft FSCM 9.2: PeopleSoft Lease Administration

---

**July 2024**

PeopleSoft FSCM 9.2: PeopleSoft Lease Administration  
Copyright © 1988, 2024, Oracle and/or its affiliates.

This software and related documentation are provided under a license agreement containing restrictions on use and disclosure and are protected by intellectual property laws. Except as expressly permitted in your license agreement or allowed by law, you may not use, copy, reproduce, translate, broadcast, modify, license, transmit, distribute, exhibit, perform, publish, or display any part, in any form, or by any means. Reverse engineering, disassembly, or decompilation of this software, unless required by law for interoperability, is prohibited.

The information contained herein is subject to change without notice and is not warranted to be error-free. If you find any errors, please report them to us in writing.

If this is software, software documentation, data (as defined in the Federal Acquisition Regulation), or related documentation that is delivered to the U.S. Government or anyone licensing it on behalf of the U.S. Government, then the following notice is applicable:

U.S. GOVERNMENT END USERS: Oracle programs (including any operating system, integrated software, any programs embedded, installed, or activated on delivered hardware, and modifications of such programs) and Oracle computer documentation or other Oracle data delivered to or accessed by U.S. Government end users are "commercial computer software," "commercial computer software documentation," or "limited rights data" pursuant to the applicable Federal Acquisition Regulation and agency-specific supplemental regulations. As such, the use, reproduction, duplication, release, display, disclosure, modification, preparation of derivative works, and/or adaptation of i) Oracle programs (including any operating system, integrated software, any programs embedded, installed, or activated on delivered hardware, and modifications of such programs), ii) Oracle computer documentation and/or iii) other Oracle data, is subject to the rights and limitations specified in the license contained in the applicable contract. The terms governing the U.S. Government's use of Oracle cloud services are defined by the applicable contract for such services. No other rights are granted to the U.S. Government.

This software or hardware is developed for general use in a variety of information management applications. It is not developed or intended for use in any inherently dangerous applications, including applications that may create a risk of personal injury. If you use this software or hardware in dangerous applications, then you shall be responsible to take all appropriate fail-safe, backup, redundancy, and other measures to ensure its safe use. Oracle Corporation and its affiliates disclaim any liability for any damages caused by use of this software or hardware in dangerous applications.

Oracle®, Java, MySQL, and NetSuite are registered trademarks of Oracle and/or its affiliates. Other names may be trademarks of their respective owners.

Intel and Intel Inside are trademarks or registered trademarks of Intel Corporation. All SPARC trademarks are used under license and are trademarks or registered trademarks of SPARC International, Inc. AMD, Epyc, and the AMD logo are trademarks or registered trademarks of Advanced Micro Devices. UNIX is a registered trademark of The Open Group.

This software or hardware and documentation may provide access to or information about content, products, and services from third parties. Oracle Corporation and its affiliates are not responsible for and expressly disclaim all warranties of any kind with respect to third-party content, products, and services unless otherwise set forth in an applicable agreement between you and Oracle. Oracle Corporation and its affiliates will not be responsible for any loss, costs, or damages incurred due to your access to or use of third-party content, products, or services, except as set forth in an applicable agreement between you and Oracle.

## **Documentation Accessibility**

For information about Oracle's commitment to accessibility, visit the Oracle Accessibility Program website at <https://docs.oracle.com/pls/topic/lookup?ctx=acc&id=docacc>.

## **Access to Oracle Support**

Oracle customers that have purchased support have access to electronic support through My Oracle Support. For information, visit <https://docs.oracle.com/pls/topic/lookup?ctx=acc&id=info> or visit <https://docs.oracle.com/pls/topic/lookup?ctx=acc&id=trs> if you are hearing impaired.

# Contents

- Preface: Preface..... xiii**
  - Understanding the PeopleSoft Online Help and PeopleBooks..... xiii
  - Hosted PeopleSoft Online Help.....xiii
  - Locally Installed PeopleSoft Online Help.....xiii
  - Downloadable PeopleBook PDF Files..... xiii
  - Common Help Documentation..... xiii
  - Field and Control Definitions..... xiv
  - Typographical Conventions..... xiv
  - ISO Country and Currency Codes..... xv
  - Region and Industry Identifiers.....xv
  - Translations and Embedded Help..... xvi
  - Using and Managing the PeopleSoft Online Help..... xvi
  - PeopleSoft FSCM Related Links.....xvi
  - Contact Us.....xvi
  - Follow Us.....xvii
- Chapter 1: Getting Started with PeopleSoft Lease Administration..... 19**
  - PeopleSoft Lease Administration Business Process..... 19
  - PeopleSoft Lease Administration Integrations..... 21
  - PeopleSoft Lease Administration Implementation..... 21
  - Related Product Documentation..... 22
  - Common Elements Used in Lease Administration..... 22
- Chapter 2: Navigating in PeopleSoft Lease Administration..... 27**
  - Navigating in PeopleSoft Lease Administration..... 27
  - Pages Used to Navigate in PeopleSoft Lease Administration..... 27
  - Lease Administration Center..... 29
- Chapter 3: Understanding PeopleSoft Lease Administration Implementation Issues.....33**
  - PeopleSoft Lease Administration Implementation Tasks..... 33
  - Mapping Enterprise Data Flow..... 33
  - Recognizing Your Business Structure..... 33
  - Defining an FTP Server for Document Attachments..... 34
  - Generating Site Acquisition Requests..... 35
  - Creating and Administering Leases..... 35
- Chapter 4: Integrating with Other Applications.....37**
  - Understanding Product Integration..... 37
  - Integrating with PeopleSoft General Ledger..... 37
  - Integrating with PeopleSoft Asset Management..... 38
  - Understanding Shared Product Functionality for Asset Management Leases..... 38
  - Integrating with PeopleSoft Contracts..... 41
  - Integrating with PeopleSoft Payables..... 41
  - Integrating with PeopleSoft Billing..... 41
  - Integrating with PeopleSoft Asset Lifecycle Management Portal Pack..... 42
  - Integrating with PeopleSoft Project Costing..... 42
- Chapter 5: Establishing Lease Administration Business Units and Accounting Rules..... 43**
  - Understanding PeopleSoft Lease Administration Business Units..... 43
  - Understanding PeopleSoft Lease Administration Accounting Rules..... 44
  - Understanding Accounting for Foreign Currency Leases..... 46

Transaction Currency Translation Installation Option.....	47
Currency Realized Gain and Loss.....	47
Rent Expense.....	47
Lease Modifications.....	48
Lease Interest Accruals.....	48
Asset ChartField Transfers, Recategorizations, and Retirements Transactions.....	48
Unrealized Gains and Losses.....	48
Creating Lease Administration Business Units.....	49
Pages Used to Establish Lease Administration Business Units.....	49
Prerequisites.....	49
Lease Administration Business Unit Definition - General Page.....	49
Lease Administration Business Unit - Transaction Settings Page.....	59
Lease Administration Business Unit Definition - Options and Critical Dates Page.....	65
Establishing Accounting Rules for Lease Administration.....	65
Page Used to Establish Accounting Rules.....	66
Accounting Rules for Lease Administration Page.....	66
<b>Chapter 6: Securing Your PeopleSoft Lease Administration System.....</b>	<b>69</b>
Understanding PeopleSoft Lease Administration Security.....	69
Setting Up Basic Security.....	69
Setting Up Roles and Permission Lists.....	72
Setting Up Row-Level Security.....	73
Setting Up Lease Administration Security.....	73
<b>Chapter 7: Setting Up Property Site Acquisition.....</b>	<b>75</b>
Understanding Property Site Acquisition Setup.....	75
Setting Up Site Types.....	76
Page Used to Set Up Site Types.....	76
Site Type Page.....	76
Setting Up Attributes.....	77
Pages Used to Set Up Attributes.....	77
Site Attributes Page.....	77
Unit of Measures Page.....	84
Setting Up Supplemental Data.....	85
Pages Used to Set Up Supplemental Data.....	86
Register Record Page.....	86
Register Component Page.....	87
Record Page.....	88
Fields Summary Page.....	89
Fields Detail Page.....	89
Define Display Group Page.....	91
Assign Display Group Page.....	92
Creating Sites.....	93
Pages Used to Create Sites.....	93
General Information Page.....	94
Location Page.....	97
Operation/Maintenance Page.....	99
Physical Attributes Page.....	100
Schedule Page.....	101
Value Page.....	103
Supplemental Data Page.....	105
Contacts Page.....	106
Search for Contacts Page.....	106

Site Map Page.....	108
<b>Chapter 8: Structuring Leases.....</b>	<b>109</b>
Understanding PeopleSoft Lease Administration Structure.....	109
Common Elements Used in Structuring Leases.....	109
Defining Lease Abstract Sections to Print.....	109
Page Used to Define Lease Abstract Sections to Print.....	110
Understanding Lease Abstract Sections to Print.....	110
Lease Abstract Page.....	110
Defining Amendment Types.....	112
Page Used to Define Amendment Types.....	112
Understanding Amendment Types.....	112
Amendment Types Page.....	112
Defining Lease Types.....	114
Page Used to Define Lease Types.....	114
Understanding Lease Types.....	114
Lease Types Page.....	114
Defining Prorata Basis.....	115
Page Used Create a Prorata Basis Definition.....	115
Prorata Basis Page.....	115
Defining Region Codes.....	116
Understanding Region Codes.....	116
Defining User-Defined Fields.....	117
Page Used to Define User-Defined Fields.....	117
Understanding User-Defined Fields.....	117
User Defined Fields Page.....	117
Defining User-Defined Fields for Clauses.....	118
Page Used to Define User-Defined Fields for Clauses.....	118
Clause User Defined Fields (Setup) Page.....	119
Defining Related Lease Type Setup.....	119
Page Used to Define the Relation Between Two Leases.....	120
Related Lease Type Setup Page.....	120
Defining Borrowing Interest Rate.....	121
Pages Used to Define Borrowing Interest Rate.....	121
Borrowing Rate Default Page.....	121
Defining Transaction Routing Codes.....	121
Page Used to Define Transaction Routing Codes.....	122
Understanding Transaction Routing Codes.....	122
Transaction Routing Codes Page.....	122
Defining Operating Expense Categories.....	124
Page Used to Define Operating Expense Categories.....	124
Understanding Operating Expense Categories.....	124
Operating Expense Categories Page.....	125
Defining Sales Categories.....	125
Page Used to Define Sales Categories.....	126
Understanding Sales Categories.....	126
Defining Miscellaneous Rent Types.....	126
Page Used to Define Miscellaneous Rent Types.....	126
Understanding Miscellaneous Rent Types.....	126
Miscellaneous Rent Types Page.....	127
Defining Security Deposit Types.....	128
Page Used to Define Security Deposit Types.....	128

Understanding Security Deposit Types.....	128
Security Deposit Types Page.....	128
Defining Manual Fee Types.....	129
Page Used to Define Manual Fee Types.....	129
Understanding Manual Fee Types.....	129
Defining Economic Index Values.....	129
Page Used to Define Economic Index Values.....	130
Understanding Economic Index Values.....	130
Economic Index Values Page.....	130
Defining Clause Types.....	132
Page Used to Define Clause Types.....	132
Understanding Clause Types.....	132
Clause Types Page.....	132
Defining Lease Administration Options.....	133
Pages Used to Define Lease Options.....	133
Understanding Lease Administration Options.....	134
Lease and SAR Options Page.....	134
Lease and SAR Option Mail Template Page.....	135
Copy Mail Template Page.....	136
Insert Mail Fields Page.....	137
Defining Critical Date Templates.....	139
Pages Used to Define Critical Date Templates.....	139
Understanding Critical Date Templates.....	139
Define Critical Date Template Page.....	140
Define Option Notifications Page.....	141
Defining Role Types.....	143
Page Used to Define Role Types.....	143
Understanding Role Types.....	144
Role Types Page.....	144
Defining Lease Administration Roles.....	144
Page Used to Define Lease Administration Roles.....	145
Understanding Lease Administration Roles.....	145
Lease Administration Roles Page.....	145
<b>Chapter 9: Generating Site Acquisition Requests.....</b>	<b>147</b>
Understanding Site Acquisition Request Generation.....	147
Uploading Sites Under Consideration.....	148
Generating Site Acquisition Requests.....	148
Pages Used to Generate Site Acquisition Requests.....	149
SAR Details Page.....	149
Comparison Matrix Page.....	153
Options and Critical Dates Page.....	155
Critical Dates Details Page.....	157
SAR Analytic Page.....	160
Approving Site Acquisition Requests.....	160
Pages Used to Approve SARs.....	161
Manage SAR Approval Page.....	161
Site Acquisition Request Approval Page.....	162
Finalizing Site Acquisition Requests.....	162
Page Used to Finalize Site Acquisition Requests.....	162
Finalize Site(s) Acquired Page.....	163
<b>Chapter 10: Creating Lease Abstracts.....</b>	<b>165</b>

Understanding Lease Abstracts.....	165
Prerequisites.....	165
Creating and Printing Lease Abstract Worksheets.....	166
Page Used to Create Lease Abstract Worksheets.....	166
Lease Abstract Worksheet Page.....	166
Reviewing Lease Abstracts.....	172
Page Used to Review Lease Abstracts.....	172
Understanding Reviewing Lease Abstracts.....	173
Lease Abstract Page.....	173
<b>Chapter 11: Creating and Maintaining Leases.....</b>	<b>177</b>
Understanding Leases.....	177
Payables Leases.....	177
Receivables Leases.....	178
Process Flow Overview for Creating a Lease.....	179
Prerequisites.....	180
Common Elements Used in Leases.....	180
Defining General Lease Information.....	183
Pages Used to Define General Information.....	183
Understanding General Lease Information.....	183
Create New Lease - General Information Page.....	188
Add Asset Page.....	195
Defining Lease Financial Terms.....	196
Pages Used to Define Financial Terms.....	196
Understanding Lease Financial Terms.....	198
Create New Lease - Financial Terms Page.....	199
Financial Terms - Base Rent Details Page.....	206
Financial Terms - Miscellaneous Rent Details Page.....	223
Accounting Distribution Page.....	224
Preview Payment Schedule Page.....	226
Defining Lease Clauses.....	228
Pages Used to Define Lease Clauses.....	228
Understanding Lease Clauses.....	228
Prerequisite.....	229
Create New Lease - Clauses Page.....	229
Clauses - Clause Details Page.....	230
Clause User Defined Fields Page.....	232
Clause Supplemental Data Page.....	232
Adding Notes and Attachments.....	233
Pages Used to Add Notes and Attachments.....	233
Create New Lease - Notes and Attachments page.....	234
Notes - Note Detail Page.....	237
Reviewing Basic Lease Information.....	238
Pages Used to Review Basic Lease Inquiries.....	238
Basic Lease Information Page.....	238
Managing My Lease Portfolio.....	239
Page Used to Manage My Lease Portfolio.....	239
My Lease Portfolio Page.....	239
Add to My Portfolio Page.....	240
Third Party Integration of Leases.....	241
Pages Used to Manage Lease Interfaces.....	241
Importing Lease Information with the Excel to Component Interface Utility.....	241

Process Lease Interface Page.....	242
Review Lease Interface - Lease Details Page.....	243
Review Lease Interface - Lease Term Details Page.....	245
Review Lease Interface - Lease Other Details Page.....	246
Review Lease Interface - Error Details Page.....	248
Lease Activation En Masse Page.....	248
Lease Activation En Masse Log Page.....	249
<b>Chapter 12: Lease Migration and Transition.....</b>	<b>251</b>
Understanding the Data Migration and Transition Process.....	251
Using the Activity Guide.....	251
Initial Assessment of Asset Management.....	253
Pre-Migration Configuration.....	255
Migration Process.....	258
Preparing to Transition to the New Standard.....	261
Transition to the New Standard.....	270
<b>Chapter 13: Managing Straightline Accounting.....</b>	<b>275</b>
Understanding Straightline Accounting.....	275
Prerequisites.....	279
Generating Straightline Accounting Schedules.....	279
Page Used to Generate Straightline Accounting Schedule.....	280
Performing Manual Straightline Adjustments.....	280
Pages Used to Perform Manual Straightline Adjustments.....	280
Manual Straightline Adjustment Page.....	280
Accounting Distributions Page.....	282
Posting Straightline Entries.....	284
Page Used to Post Straightline Entries.....	285
Understanding Posting Straightline Entries.....	285
Post Straightline Entries Page.....	285
Viewing Posted Straightline Accounting Entries.....	286
Pages Used to View Posted Straightline Accounting Entries.....	286
Understanding Posted Straightline Accounting Entries.....	286
Posted Straightline Accounting Page.....	287
Review Journal Entries Page.....	288
<b>Chapter 14: Amending Leases.....</b>	<b>291</b>
Understanding Lease Amendments.....	291
Maintaining Leases.....	291
Amending Leases.....	291
Understanding Amendment Status.....	292
Prerequisites.....	293
Working with Amendments.....	293
Pages Used to Work with Amendments.....	293
Amendments - Amendment History Page.....	294
Amendments - Edit Amendment Details Page.....	295
Amending Lease Details.....	297
Amendments - Review Amendment Details Page.....	299
<b>Chapter 15: Setting Up Operating Expenses.....</b>	<b>301</b>
Understanding Operating Expenses.....	301
Understanding Catch Up Payments.....	301
Prerequisites.....	301
Establishing Operating Expenses for a Lease.....	302
Pages Used to Establish Operating Expenses for a Lease.....	302



Financial Terms - Operating Expenses Details Page.....	302
Accounting Distributions Page.....	309
Prorata Share Details - Basis Page.....	310
Cap/Minimum Details Page.....	312
Operating Expense Approval Page.....	314
Performing Operating Expense Audits for a Payables Lease.....	315
Pages Used to Audit Operating Expenses.....	316
Understanding Operating Expense Audits.....	316
Prerequisites.....	316
Audit Operating Expenses - Operating Expense Audit Page.....	317
Audit Operating Expenses - Compare Operating Expenses with Previous Audit Page.....	323
Reconciling Operating Expenses for Receivables Leases.....	325
Pages Used to Reconcile Operating Expenses.....	326
Understanding Operating Expense Reconciliation.....	326
Reconcile Operating Expenses - Operating Expense Statement Page.....	326
Reconcile Operating Expenses - Compare Operating Expenses with Prior Statement Page.....	327
<b>Chapter 16: Setting Up and Calculating Percent Rent.....</b>	<b>329</b>
Understanding Percent Rent Terms.....	329
Prerequisites.....	353
Setting Up Percent Rent Terms.....	353
Pages Used to Set Up Percent Rent Terms.....	353
Financial Terms - Percent Rent Page.....	353
Reporting Sales and Calculating Percent Rent.....	358
Pages Used to Report Sales and Calculate Percent Rent.....	359
Understanding Sales Reporting and Percent Rent Calculation.....	359
Report Sales - Sales Reports Page.....	362
Report Sales - Find Missing Sales Reports Page.....	363
Report Sales - Create New Sales Reports Page.....	365
Report Sales - Sales Report (import) Page.....	367
Process Sales Reports Page.....	368
<b>Chapter 17: Setting Up Security Deposits.....</b>	<b>371</b>
Understanding Security Deposits.....	371
Setting Up Security Deposits.....	372
Pages Used to Set Up Security Deposits.....	372
Financial Terms - Security Deposit Page.....	372
Accounting Distributions Page.....	376
Refunding Security Deposits.....	377
Page Used to Refund Security Deposits.....	378
Understanding Security Deposit Refunds.....	378
Refund Security Deposit - Final Security Deposit Refund Worksheet Page.....	378
Accounting Distributions Page.....	381
<b>Chapter 18: Setting Up Options and Critical Dates.....</b>	<b>383</b>
Understanding Options and Critical Dates.....	383
Prerequisites.....	384
Setting Up Options and Critical Dates.....	385
Pages Used to Set Up Options and Critical Dates.....	385
Options and Critical Dates Page.....	386
Critical Date Detail Page.....	387
Generate Critical Date Notifications Page.....	391
Critical Date Inquiry Page.....	391
Managing Your Critical Dates.....	392

Pages Used to Manage Your Critical Dates.....	392
Understanding the My Critical Dates Page.....	392
My Critical Dates Page.....	392
<b>Chapter 19: Defining Contacts for Lease Administration.....</b>	<b>395</b>
Understanding Lease Administration Contacts.....	395
Prerequisites.....	397
Establishing Contacts for Sites and SARs.....	397
Pages Used to Set Up Contacts Repository.....	397
General Information Page.....	397
Establishing Contacts for a Lease.....	398
Pages Used to Set Up Supplemental Contacts.....	398
Contacts Page.....	398
<b>Chapter 20: Processing Invoices for Receivables Leases.....</b>	<b>401</b>
Understanding Invoices for Receivables Leases.....	401
Prerequisites.....	402
Working with the Transaction Generator.....	402
Page Used to Manage the Transaction Generator.....	402
Understanding the Transaction Generator.....	402
Prerequisites.....	403
Manage Transaction Generator Page.....	403
Managing Transactions for Invoice Processing.....	404
Pages Used to Manage Transactions for Invoice Processing.....	404
Understanding Invoice Processing.....	405
Prerequisites.....	405
Billing Transactions Page.....	406
Billing Transactions - Create Receivable Manual Fees Page.....	409
Creating Manual Invoice Transactions.....	410
Pages Used to Create Manual Invoice Transactions.....	410
Understanding Manual Invoice Transactions.....	411
Billing Transactions - Create Receivable Manual Fees Page.....	412
Accounting Distributions Page.....	417
Running the Interface to AP/Billing Process.....	419
Page Used to Run Manage Interface to AP/Billing.....	419
Understanding the Interface to AP/Billing Process.....	419
Accessing Billing Information.....	421
Prerequisites.....	421
Manage Interface to AP/Billing Page.....	421
Viewing Pending Lease Receivables.....	423
Pages Used to View Pending Lease Receivables.....	423
Pending Lease Receivables Page.....	423
<b>Chapter 21: Processing Payments for Payables Leases.....</b>	<b>427</b>
Understanding Processing Payments for Payables Leases.....	427
Prerequisites.....	428
Working with the Transaction Generator.....	428
Page Used to Manage the Transaction Generator.....	428
Understanding the Transaction Generator.....	428
Manage Transaction Generator Page.....	429
Managing Transactions for Payment Processing.....	429
Pages Used to Manage Transactions for Payment Processing.....	430
Understanding Payment Processing.....	430
Prerequisites.....	431

Payment Transactions Page.....	431
Creating Manual Payment Transactions.....	435
Pages Used to Create Manual Payment Transactions.....	435
Understanding Manual Payment Transactions.....	436
Payment Transactions - Create Payable Manual Fees Page.....	437
Overriding Accounting Distributions.....	442
Payment Transactions - Create Payable Manual Fees Page.....	444
Running the Interface to AP/Billing Process.....	445
Page Used to Manage Interfaces to AP/Billing.....	446
Understanding the Interface to AP/Billing Process.....	446
Prerequisites.....	447
Manage Interfaces to AP/Billing Page.....	447
Viewing Pending Lease Payables.....	448
Page Used to View Pending Lease Payables.....	448
Pending Lease Payables Page.....	449
<b>Chapter 22: Analyzing Lease Administration Using PeopleSoft Insights.....</b>	<b>451</b>
Understanding PeopleSoft Insights for Lease Administration.....	451
Setting up Insights Dashboards for Lease Administration.....	451
Adding Lease Administration Tiles for Insights Dashboards.....	452
Analyzing Lease Administration Using PeopleSoft Insights.....	453
Pages Used to Analyze Lease Administration Using PeopleSoft Insights.....	453
Lease Payment Insights Dashboard.....	454
Lease Payment Forecast Dashboard.....	455
<b>Chapter 23: Configuring Batch Processes.....</b>	<b>459</b>
Configuring Temporary Tables for Batch Processing.....	459
<b>Chapter 24: Scenarios for PeopleSoft Lease Administration.....</b>	<b>463</b>
Understanding Troubleshooting.....	463
Scenario: Set up for Creating a Contract from a Lease.....	463
Bill Cycle Page.....	463
Lease Administration Business Unit Setup.....	464
Contracts Business Unit Setup.....	465
Customer Validation.....	467
Contract Status Setup.....	468
Unit of Measure Setup.....	468
<b>Chapter 25: PeopleSoft Lease Administration Reports.....</b>	<b>469</b>
PeopleSoft Lease Administration Reports: A-Z.....	469



# Preface

---

## Understanding the PeopleSoft Online Help and PeopleBooks

The PeopleSoft Online Help is a website that enables you to view all help content for PeopleSoft applications and PeopleTools. The help provides standard navigation and full-text searching, as well as context-sensitive online help for PeopleSoft users.

### Hosted PeopleSoft Online Help

You can access the hosted PeopleSoft Online Help on the [Oracle Help Center](#). The hosted PeopleSoft Online Help is updated on a regular schedule, ensuring that you have access to the most current documentation. This reduces the need to view separate documentation posts for application maintenance on My Oracle Support. The hosted PeopleSoft Online Help is available in English only.

To configure the context-sensitive help for your PeopleSoft applications to use the Oracle Help Center, see [Configuring Context-Sensitive Help Using the Hosted Online Help Website](#).

### Locally Installed PeopleSoft Online Help

If you're setting up an on-premises PeopleSoft environment, and your organization has firewall restrictions that prevent you from using the hosted PeopleSoft Online Help, you can install the online help locally. Installable PeopleSoft Online Help is made available with selected PeopleSoft Update Images and with PeopleTools releases for on-premises installations, through the [Oracle Software Delivery Cloud](#).

Your installation documentation includes a chapter with instructions for how to install the online help for your business environment, and the documentation zip file may contain a README.txt file with additional installation instructions. See *PeopleSoft 9.2 Application Installation* for your database platform, "Installing PeopleSoft Online Help."

To configure the context-sensitive help for your PeopleSoft applications to use a locally installed online help website, see [Configuring Context-Sensitive Help Using a Locally Installed Online Help Website](#).

### Downloadable PeopleBook PDF Files

You can access downloadable PDF versions of the help content in the traditional PeopleBook format on the [Oracle Help Center](#). The content in the PeopleBook PDFs is the same as the content in the PeopleSoft Online Help, but it has a different structure and it does not include the interactive navigation features that are available in the online help.

### Common Help Documentation

Common help documentation contains information that applies to multiple applications. The two main types of common help are:

- Application Fundamentals

- Using PeopleSoft Applications

Most product families provide a set of application fundamentals help topics that discuss essential information about the setup and design of your system. This information applies to many or all applications in the PeopleSoft product family. Whether you are implementing a single application, some combination of applications within the product family, or the entire product family, you should be familiar with the contents of the appropriate application fundamentals help. They provide the starting points for fundamental implementation tasks.

In addition, the *PeopleTools: Applications User's Guide* introduces you to the various elements of the PeopleSoft Pure Internet Architecture. It also explains how to use the navigational hierarchy, components, and pages to perform basic functions as you navigate through the system. While your application or implementation may differ, the topics in this user's guide provide general information about using PeopleSoft applications.

## Field and Control Definitions

PeopleSoft documentation includes definitions for most fields and controls that appear on application pages. These definitions describe how to use a field or control, where populated values come from, the effects of selecting certain values, and so on. If a field or control is not defined, then it either requires no additional explanation or is documented in a common elements section earlier in the documentation. For example, the Date field rarely requires additional explanation and may not be defined in the documentation for some pages.

## Typographical Conventions

The following table describes the typographical conventions that are used in the online help.

<b><i>Typographical Convention</i></b>	<b><i>Description</i></b>
<b>Key+Key</b>	Indicates a key combination action. For example, a plus sign (+) between keys means that you must hold down the first key while you press the second key. For <b>Alt+W</b> , hold down the <b>Alt</b> key while you press the <b>W</b> key.
... (ellipses)	Indicate that the preceding item or series can be repeated any number of times in PeopleCode syntax.
{ } (curly braces)	Indicate a choice between two options in PeopleCode syntax. Options are separated by a pipe ( ).
[ ] (square brackets)	Indicate optional items in PeopleCode syntax.
& (ampersand)	When placed before a parameter in PeopleCode syntax, an ampersand indicates that the parameter is an already instantiated object.  Ampersands also precede all PeopleCode variables.

<b>Typographical Convention</b>	<b>Description</b>
⇒	This continuation character has been inserted at the end of a line of code that has been wrapped at the page margin. The code should be viewed or entered as a single, continuous line of code without the continuation character.

## ISO Country and Currency Codes

PeopleSoft Online Help topics use International Organization for Standardization (ISO) country and currency codes to identify country-specific information and monetary amounts.

ISO country codes may appear as country identifiers, and ISO currency codes may appear as currency identifiers in your PeopleSoft documentation. Reference to an ISO country code in your documentation does not imply that your application includes every ISO country code. The following example is a country-specific heading: "(FRA) Hiring an Employee."

The PeopleSoft Currency Code table (CURRENCY\_CD\_TBL) contains sample currency code data. The Currency Code table is based on ISO Standard 4217, "Codes for the representation of currencies," and also relies on ISO country codes in the Country table (COUNTRY\_TBL). The navigation to the pages where you maintain currency code and country information depends on which PeopleSoft applications you are using. To access the pages for maintaining the Currency Code and Country tables, consult the online help for your applications for more information.

## Region and Industry Identifiers

Information that applies only to a specific region or industry is preceded by a standard identifier in parentheses. This identifier typically appears at the beginning of a section heading, but it may also appear at the beginning of a note or other text.

Example of a region-specific heading: "(Latin America) Setting Up Depreciation"

### Region Identifiers

Regions are identified by the region name. The following region identifiers may appear in the PeopleSoft Online Help:

- Asia Pacific
- Europe
- Latin America
- North America

### Industry Identifiers

Industries are identified by the industry name or by an abbreviation for that industry. The following industry identifiers may appear in the PeopleSoft Online Help:

- USF (U.S. Federal)

- E&G (Education and Government)

## Translations and Embedded Help

PeopleSoft 9.2 software applications include translated embedded help. With the 9.2 release, PeopleSoft aligns with the other Oracle applications by focusing our translation efforts on embedded help. We are not planning to translate our traditional online help and PeopleBooks documentation. Instead we offer very direct translated help at crucial spots within our application through our embedded help widgets. Additionally, we have a one-to-one mapping of application and help translations, meaning that the software and embedded help translation footprint is identical—something we were never able to accomplish in the past.

---

## Using and Managing the PeopleSoft Online Help

Select About This Help in the left navigation panel on any page in the PeopleSoft Online Help to see information on the following topics:

- Using the PeopleSoft Online Help.
- Managing hosted Online Help.
- Managing locally installed PeopleSoft Online Help.

---

## PeopleSoft FSCM Related Links

[Oracle Help Center](#)

[Hosted Online Help](#)

[PeopleSoft Information Portal](#)

[My Oracle Support](#)

Financial and Supply Chain Management information for Search Framework search engine can be found in PeopleSoft Application Fundamentals documentation. For application specific information, see the “Understanding Keyword Search within Components ” (Application Fundamentals) topic.

[PeopleSoft Training from Oracle University](#)

[PeopleSoft Video Feature Overviews on YouTube](#)

[PeopleSoft Business Process Maps \(Microsoft Visio format\)](#)

[PeopleSoft Spotlight Series](#)

---

## Contact Us

Send your suggestions to [psoft-infodev\\_us@oracle.com](mailto:psoft-infodev_us@oracle.com).



Please include the applications update image or PeopleTools release that you're using.

---

## Follow Us

<i>Icon</i>	<i>Link</i>
	<a href="#">Watch PeopleSoft on YouTube</a>
	<a href="#">Follow @PeopleSoft_Info on X.</a>
	<a href="#">Read PeopleSoft Blogs</a>
	<a href="#">Connect with PeopleSoft on LinkedIn</a>



## Chapter 1

# Getting Started with PeopleSoft Lease Administration

---

## PeopleSoft Lease Administration Business Process

The following graphic lists the PeopleSoft Lease Administration business processes including site acquisition, and financial processing:

The business process sections in this documentation discusses these business processes.

The following graphic lists the PeopleSoft Lease Administration business processes.

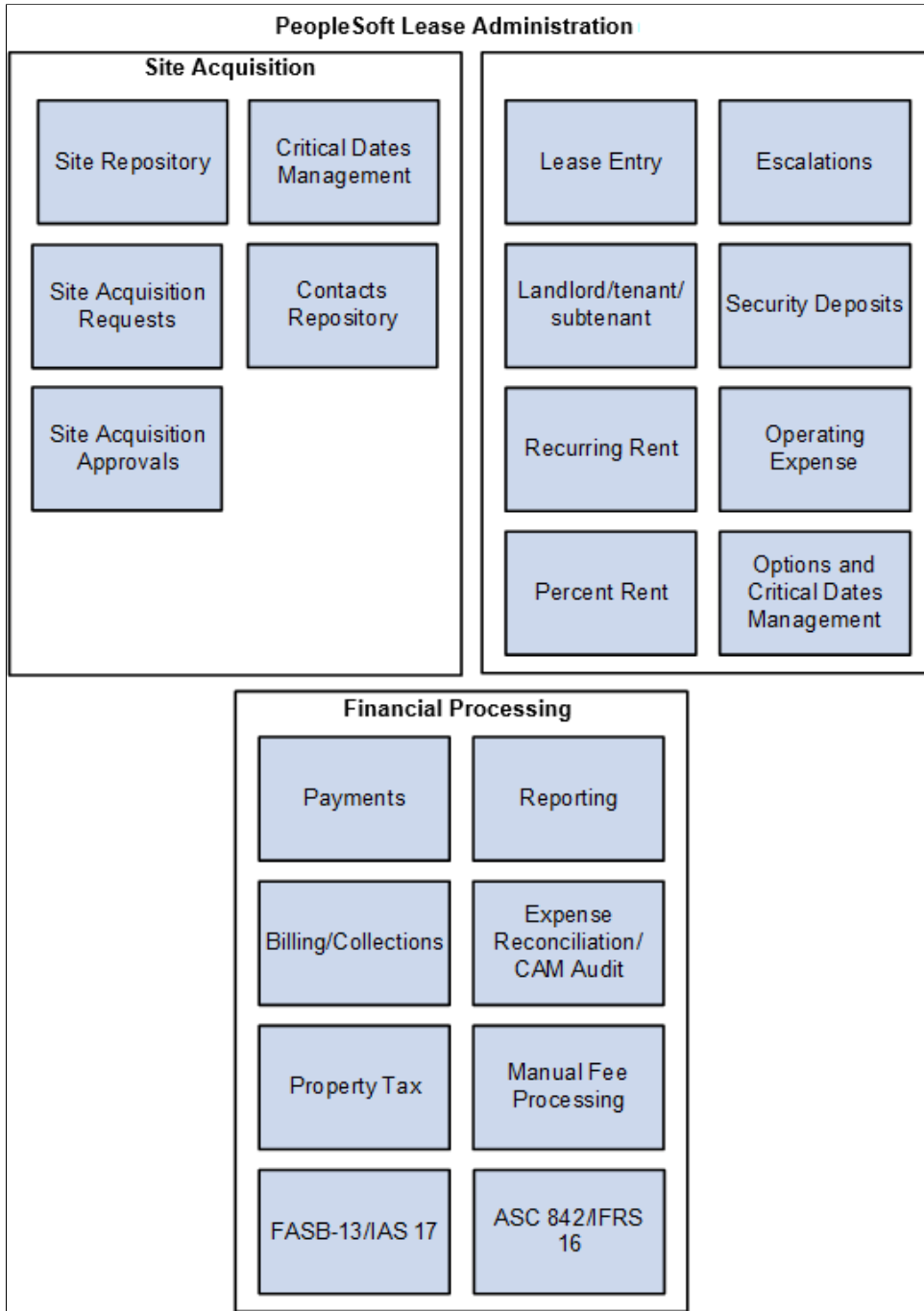

## PeopleSoft Lease Administration Integrations

The following graphic illustrates how PeopleSoft Lease Administration integrates with other PeopleSoft applications.

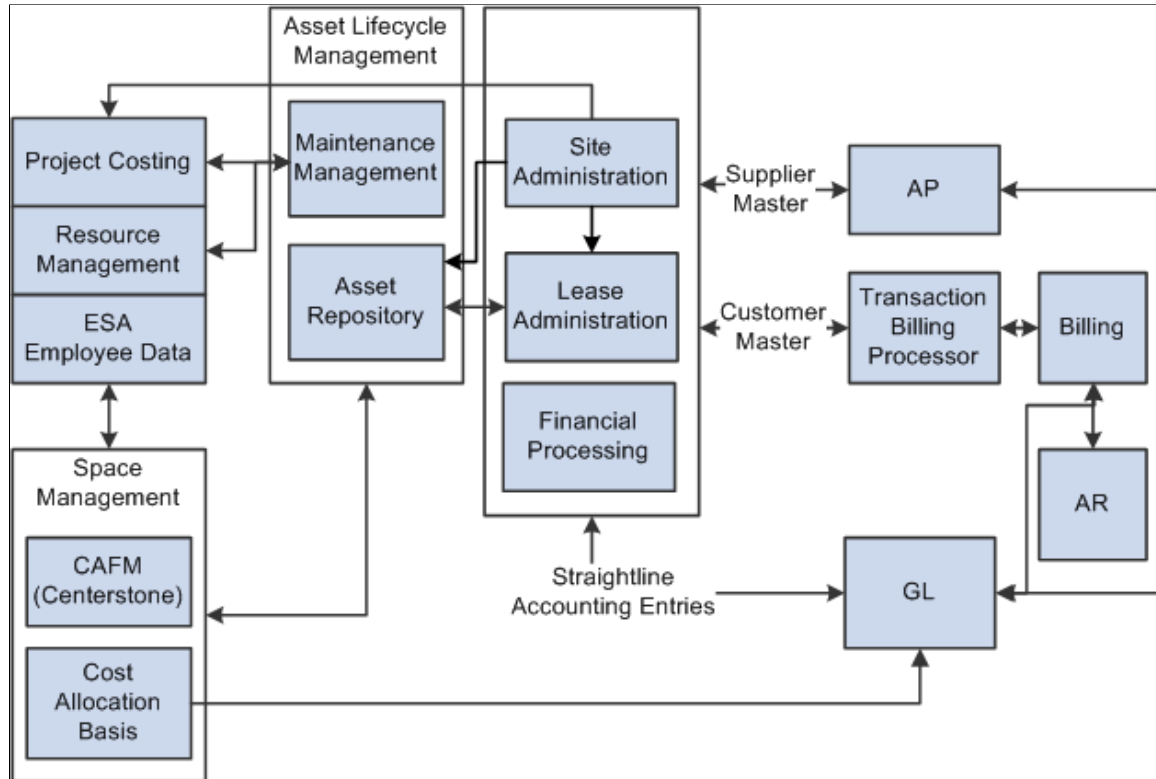

The implementation topics in this documentation discuss the integration considerations.

Supplemental information about third-party application integrations is located on Oracle's My Oracle Support website.

## PeopleSoft Lease Administration Implementation

PeopleSoft Setup Manager enables you to review a list of setup tasks for your organization for the products that you are implementing. The setup tasks include the components that you must set up, listed in the order in which you must enter data into the component tables, and links to the corresponding documentation.

PeopleSoft Lease Administration also provides component interfaces to help you load data from your existing system into PeopleSoft Lease Administration tables. Use the Excel to Component Interface utility with the component interfaces to populate the tables.

<b>Component</b>	<b>Component Interface</b>	<b>References</b>
Region Code (REGION_CD)	REGION_CD_CI	See “Establishing Regions and Region Codes” (Application Fundamentals).
Establish Business Units AP (BUS_UNIT_TBL_AP)	EM_BUS_UNIT_AP	See “Understanding PeopleSoft Payables Business Units” (PeopleSoft Payables).

## Other Sources of Information

In the planning phase of your implementation, take advantage of all PeopleSoft sources of information, including the installation guides, table-loading sequences, data models, and business process setup maps. A complete list of these resources appears in *PeopleSoft Application Fundamentals for Financials, Enterprise Service Automation, and Supply Chain Management* documentations with information about where to find the most current version of each.

*PeopleTools: Component Interfaces*

---

## Related Product Documentation

The *PeopleSoft Lease Administration* provides you with implementation and processing information for your PeopleSoft Lease Administration system. However, additional, essential information describing the setup and design of your system resides in companion documentation. The companion documentation consists of important topics that apply to many or all PeopleSoft applications across the Financials, Enterprise Service Automation, and Supply Chain Management product lines. You should be familiar with the contents of these documentations:

The following companion documentations apply specifically to PeopleSoft Lease Administration.

- *PeopleSoft Application Fundamentals*
- *PeopleSoft Global Options and Reports*
- *PeopleSoft Order to Cash Common Information*
- *PeopleSoft Asset Lifecycle Management Fundamentals*

---

## Common Elements Used in Lease Administration

<b>Field or Control</b>	<b>Description</b>
<b>Business Unit</b>	Identification code that represents a high-level organization of business information. Use a business unit to define regional or departmental units within a larger organization.

<b>Field or Control</b>	<b>Description</b>
<b>Effective Date</b>	<p>Date on which a table row becomes effective; the date that an action begins. For example, if you want to close out a ledger on June 30, the effective date for the ledger closing would be July 1. This date also determines when you can view and change the information. Pages or panels and batch processes that use the information use the current row.</p> <p>See <i>PeopleTools: Applications User's Guide</i></p>
<b>Effective Status</b>	<p>Indicates whether a row in a table is <i>Active</i> or <i>Inactive</i>. You cannot display inactive rows on transaction pages or use them for running batch processes. Inactivate rather than delete data you no longer use in order to maintain an audit trail.</p>
<b>Fund</b>	<p>An accounting entity established for the purpose of carrying on specific activities or attaining certain objectives in accordance with special regulations, restrictions, or limitations. This is a delivered PeopleSoft ChartField, specific use of which is typically defined by your organization during implementation of PeopleSoft General Ledger.</p>
<b>Fund Affiliate</b>	<p>ChartField used to correlate transactions between funds when using a single intraunit account.</p>
<b>Landlord</b>	<p>An entity that owns and rents land, buildings, or dwelling units.</p>
<b>Language or Language Code</b>	<p>The language in which you want the field labels and report headings of your reports to print. The field values appear as you enter them.</p> <p>Language also refers to the language spoken by an employee, applicant, or non-employee.</p>
<b>Lease</b>	<p>Legally binding agreement between a landlord and a tenant where the tenant rents all or part of a physical property from the landlord.</p>
<b>Operating Unit</b>	<p>ChartField used to identify a location, such as a distribution warehouse or sales center.</p>
<b>Payee</b>	<p>The entity to whom a payment must be made.</p>
<b>Payor</b>	<p>The entity who is required to make a payment.</p>

<b>Field or Control</b>	<b>Description</b>
<b>Process Frequency</b>	<p>Select the appropriate frequency from the drop-down box:</p> <p><i>Process Once:</i> Executes the request the next time the batch process runs. After the batch process runs, the process frequency is automatically set to <i>Don't Run</i>.</p> <p><i>Don't Run:</i> Ignores the request when the batch process runs.</p> <p><i>Always Process:</i> Executes the request every time the batch process runs.</p>
<b>Process Monitor</b>	<p>A link that accesses the Process List page, where you can view the status of submitted process requests.</p> <p>See <i>PeopleTools: Process Scheduler</i></p>
<b>Product</b>	ChartField that captures additional information useful for profitability and cash flow analysis by product sold or manufactured.
<b>Program</b>	ChartField that identifies groups of related activities, cost centers, revenue centers, responsibility centers, and academic programs. Tracks revenue and expenditures for programs.
<b>Project</b>	ChartField that captures information for project/grants accounting.
<b>Report ID</b>	Unique identification code for a report.
<b>Report Manager</b>	A link that accesses the Report List page, where you can view report content, check the status of a report, and see content detail messages (which show you a description of the report and the distribution list).
<b>Request ID</b>	A request identification that represents a set of selection criteria for a report or process.
<b>Right-of-Use (ROU) Asset</b>	An asset that represents a lessee's right to use an underlying asset for the lease term.
<b>Run</b>	This button takes you to the Process Scheduler request page, where you can specify the location where a process or job runs and the process output format.
<b>Run Control ID</b>	An identification code that identifies the run parameters for a report or process.
<b>Select All</b>	Click this button to select all options on the page.



<b><i>Field or Control</i></b>	<b><i>Description</i></b>
<b>SetID</b>	An identification code that represents a set of control table information or TableSets. A TableSet is a group of tables (records) necessary to define your company's structure and processing options.
<b>Short Description</b>	Any text up to 15 characters.
<b>Tenant</b>	An entity that pays rent to use or occupy land, a building, or other property owned by another.
<b>User Defaults</b>	User preferences and defaults used for PeopleSoft Lease Administration.
<b>User ID</b>	The system identifier for the individual who generates a transaction.



## Chapter 2

# Navigating in PeopleSoft Lease Administration

---

## Navigating in PeopleSoft Lease Administration

PeopleSoft Lease Administration provides custom navigation pages that contain groupings of folders that support a specific business process, task, or user role.

---

**Note:** In addition to the PeopleSoft Lease Administration custom navigation pages, PeopleSoft provides menu navigation and standard navigation pages.

---

## Pages Used to Navigate in PeopleSoft Lease Administration

This table lists the custom navigation pages that are used to navigate in PeopleSoft Lease Administration:

### Lease Administration Center

The Lease Administration Center custom navigation pages provide access to lease administration setup as well as lease administration acquisition business processes and reports:

<i>Page Name</i>	<i>Navigation</i>	<i>Usage</i>
Lease Administration Center	<b>Main Menu &gt; Lease Administration &gt; Lease Administration Center</b>	Access primary Lease Administration menu options as well as pages pertinent to administering leases from other PeopleSoft applications.
My Information	Click the <b>My Information</b> link on the Lease Administration Center page.	Access the My Lease Portfolio, My Critical Dates, and My Preferences pages.
Payables Leases	Click the <b>Payables Leases</b> link on the Lease Administration Center page.	Access the Lease Inquiry, Create New Lease, Maintain Lease, Enter Sales Report, and Audit Operating Expenses pages.

<b>Page Name</b>	<b>Navigation</b>	<b>Usage</b>
Receivables Leases	Click the <b>Receivables Leases</b> link on the Lease Administration Center page.	Access the Create New Lease, Maintain Lease, Enter Sales Report, Reconcile Operating Expense, and Refund Security Deposits pages.
Contact Repository	Click the <b>Contact Repository</b> link on the Lease Administration Center page	Access the Contacts page to manage or add new contacts.
Manage Payments	Click the <b>Manage Payments</b> link on the Lease Administration Center page.	Access the Process Payments, Manage Transaction Generator, Create Manual Payables, and Maintain Manual Payables pages as well as the interface to Payables.
Manage Billing/AR	Click the <b>Manage Billing/AR</b> link on the Lease Administration Center page.	Access Process Invoices, Manage Transaction Generator, Review Invoices, Create Manual Receivables, Maintain Manual Receivables, and Review Outstanding Receivables pages.
Manage Accounting	Click the <b>Manage Accounting</b> link on the Lease Administration Center page.	Access Allocation, Accounting Rules, and Straightline Accounting pages.
Reports	Click the <b>Reports</b> link on the Lease Administration Center page.	Access the Lease Abstract, Critical Dates, Property/Asset Inquiry, Pending Lease Payables, Pending Lease Receivable, Reported Sales, Minimum Lease Obligation, Lease Abstract Worksheet pages, Rent Variance and Leased Property reports.
Lease Administration Setup	Click the <b>Lease Administration Setup</b> link on the Lease Administration Center page.	Access all the setup pages necessary for PeopleSoft Lease Administration across the applications: Transaction Routing Codes, Amendment Types, LA Business Unit Definition, Clause Types, Economic Index, Lease Options, Lease Abstract, Critical Dates Templates, Customer Setup, Lease Administration Roles, Lease Types, Supplier Setup, Manual Fee Types, Market Rate Index, Miscellaneous Rent Types, Region Codes, Role Types, Sales Categories, Security Deposit Types, Operating Expense Categories, and Schedule pages.

<b>Page Name</b>	<b>Navigation</b>	<b>Usage</b>
Asset Repository	Click the <b>Asset Repository</b> link on the Lease Administration Center page.	Access the Add/Maintain Property, Space Utilization, Property Tax, CAFM Property Integration, CAFM Department Integration and CAFM Employee Integration pages.
Site Repository	Click the <b>Site Repository</b> link on the Lease Administration Center page.	Access the Create Site and Manage Sites pages.
Site Acquisition Request	Click the <b>Site Acquisition Request</b> link on the Lease Administration Center page.	Access the Site Acquisition Request, Manage SAR Approval pages and critical dates pages.
Site Acquisition Setup	Click the <b>Site Acquisition Setup</b> link on the Lease Administration Center page.	Access all the setup pages necessary for PeopleSoft Site Acquisition including supplemental data.
Options and Template Setup	Click the <b>Options and Template Setup</b> link on the Lease Administration Center page.	Access the pages necessary to manage options and critical data templates.
Lease Administration Center	Click the NavBar and select the Lease Administration link.	Access various lease administration components.

## Lease Administration Center

Use the Lease Administration navigation collection to access various lease administration components.

This page can be accessed by adding link on the NavBar.

This example illustrates the fields and controls on the Lease Administration Center Page. You can find definitions for the fields and controls later on this page.

The screenshot shows the 'Lease Administration Center' interface. On the left is a navigation menu with categories like 'My Information', 'My Lease Portfolio', 'Payables Leases', etc. The main area is titled 'My Lease Portfolio' and contains search criteria fields for Business Unit, Region, Lease Administrator, Portfolio Manager, Lease Type, Lease Number, Lease Name, and Lease Status. Below the search fields are buttons for 'Search', 'Clear All', 'Add to My Lease Portfolio', and 'Remove from My Lease Portfolio'. A table below shows the lease portfolio items with columns for Business Unit, Lease Number, Lease Type, Lease Name, Region, and Lease Status.

Business Unit	Lease Number	Lease Type	Lease Name	Region	Lease Status
<input type="checkbox"/> FRA01	0000000021	Retail Location	417 Rue Madeleine	Western Sales Region	Active
<input type="checkbox"/> FRA01	0000000022	Retail Location	12 Boulevard Gautier	Northeast Sales	Active
<input type="checkbox"/> FRA01	0000000023	Retail Location	277 Rue Cler	Midwest Sales Region	Expired
<input type="checkbox"/> FRA01	0000000024	Retail Location	67-5 Rue de la Chamonix	Southern Sales Region	Active
<input type="checkbox"/> US001	0000000025	Sublease	5000 Yellowstone Parkway	Western Sales Region	Pending
<input type="checkbox"/> FRA01	0000000027	Retail Location	775 Boulevard Volterre	Southern Sales Region	Active
<input type="checkbox"/> US001	0000000028	Sublease	9499 Sheridan Avenue	Western Sales Region	Pending
<input type="checkbox"/> US001	0000000029	Easement	Space 1013 - 56 Second Street	Northern North America	Active
<input type="checkbox"/> US001	0000000030	Office Lease	Space 1021 - 56 Second Street	Northern North America	Active

This navigation collection enables users to access frequently-used lease administration components from a single location. The left panel of this page lists all the collected components in the following categories:

- My Information
- Payables Leases
- Asset Repository
- Receivables Leases
- Site Repository
- Contact Repository
- Manage Payments
- Manage Billing/AR
- Manage Accounting
- Reports
- Lease Administration Setup
- Site Acquisition Request

- Site Acquisition Setup
- Options and Template Setup

The right pane displays the component details that is selected on the left panel.





## Chapter 3

# Understanding PeopleSoft Lease Administration Implementation Issues

---

## PeopleSoft Lease Administration Implementation Tasks

To implement PeopleSoft Lease Administration, you first need to design the business structure of the system and put that structure in place. You must determine the best way to map your new system to your organization's business structures, practices, and procedures.

PeopleSoft Lease Administration provides the ability to acquire sites and the functionality for management of the leasing life cycle.

---

## Mapping Enterprise Data Flow

You need to determine the flow of data into and out of PeopleSoft Lease Administration. Mapping which applications integrate with PeopleSoft Lease Administration and how to carry out that integration helps you with setup decisions.

Here are some questions to help with this mapping:

- What applications which integrate with PeopleSoft Lease Administration do you want to utilize?

See [Understanding Product Integration](#).

- Are these applications currently implemented?

If not, when are they scheduled for implementation?

Both PeopleSoft General Ledger and PeopleSoft Asset Management need to be implemented prior to or at the same time as the implementation of PeopleSoft Lease Administration. Additionally, PeopleSoft Payables must be used for processing of transactions to the landlords, and the Transaction Billing Processor and PeopleSoft Billing must be used for processing transactions to subtenants.

- What do you want to track in your PeopleSoft Lease Administration system?
  - Do you want to create projects or assets from acquired sites?
- 

## Recognizing Your Business Structure

Implementing PeopleSoft Lease Administration requires an iterative method of examining your business processes and investigating the software. When designing your system, take into account your policies,

procedures, and existing structures. Assess how they can be incorporated into PeopleSoft Lease Administration. Ask questions such as:

- How do you acquire your properties?
- How do you control lease management?

How does this relate to your legal and financial organizational structure?

Is it centralized or decentralized?

- To what extent do you want to take advantage of the hierarchical structure afforded by using a combination of leases and subleases?
- How do you want to control the security of your system?

Will you want the leases to be automatically approved or will someone in the management organization have to review and approve the leases?

Which users can create, approve or finalize site acquisition requests.

- Who is involved in the lease administration processes at your company?

## Defining an FTP Server for Document Attachments

PeopleSoft Lease Administration uses an FTP server to store document attachments. You must establish an FTP server with adequate disk storage to store your documents. The RE\_ATTACHMENTS URL and RE\_ABSTRACT are delivered with PeopleSoft Lease Administration, but you must update the data in the URL field so that the path to the appropriate FTP server is specified. To designate the path to the FTP server, use the URL Maintenance page.

The syntax for this URL is ftp://<username>:<password>@<machinename>.

<i>Field or Control</i>	<i>Description</i>
<username>	Name of the user account under which you want all users to connect to the FTP server for adding, updating, viewing, and deleting documents.
<password>	Password associated with the user account under which you want all users to connect to the FTP server.

<i>Field or Control</i>	<i>Description</i>
<machinename>	The name by which the FTP server is identified on your network. You may want to create a directory on the server where your documents are stored. If you create an optional directory, then include this directory name when citing your path. You can also store the attachments in the root directory of the FTP server.

---

**Warning!** The user name and password specified here are critical. The system uses these to connect all users to the FTP attachment server.

---

---

## Generating Site Acquisition Requests

The following is a high-level overview of the steps involved in generating site acquisition requests:

- Setup Site Types  

Site types enable the user to predefine the types of sites which are to be acquired. Site types can be of Retail, Commercial, Residential etc.
- Create attributes for each site type.
- Create supplemental data for each site type.
- Create or upload sites under consideration.
- Enter contact address book information for quick retrieval of contacts.
- Create a site acquisition request (SAR). Attach sites, contacts, and documents relevant to this transaction. Generate the Comparison Matrix.
- Approve/deny site acquisition request (SAR). Select site(s) as finalists, change site ranks manually.
- (optional) Create an asset, lease or project from the final site(s) selected.

---

## Creating and Administering Leases

The following is a high-level overview of the steps involved in creating and administering a lease:

- (Optional) Create a lease abstract for a lease.  

Before you create a new lease, you must extract the terms and conditions of that lease to be captured and administered in the system. A lease abstract provides a work template and/or summarization of those terms and conditions, thus streamlining lease entry.
- Create a lease in PeopleSoft Lease Administration.  

Each lease you add, whether it is a payables or receivables lease, enables you to define the timetable of the lease commencement and termination date along with the term of the lease. Each lease can include one or multiple properties. You also can designate the administrator, portfolio manager and other operational information such as region.
- Capture base rent, operating expenses and other financial terms for a lease.  

As a lease administrator, you define the base rent and operating expenses for a lease. Operating expenses can be defined for shared maintenance costs. These costs are for the common area maintenance of the property such as: landscaping, cleaning, lobby staff, and so on, and these operating expense categories can be predefined in setup.

Once you have defined these terms, PeopleSoft Billing can generate an invoice or a payment can be made through PeopleSoft Payables, depending on the lease type.

- Define rent escalations for a lease.

You can associate a financial index or assign a periodic stepped increase for escalation of rents in a lease.

- Setup periodic billing and payments according to lease terms.

Recurring monthly rent can be setup for periodic billing according to lease terms. The information is sent to PeopleSoft Billing or PeopleSoft Payables on a periodic basis, simplifying the administration of that lease.

- Define percent rent terms.

You can establish leases with variable rent payments based on reported periodic sales. Lower rent payments can be negotiated in exchange for a portion of sales. As sales reach specified thresholds (breakpoints) the percentages change, thus altering the final rent amount. You can predefine these sales categories in setup.

- Select clause types and clause subtypes to be associated to the lease.

You can predefine clause types and clause subtypes to associate to a lease. Leases can have multiple clauses defining the terms of conditions of that lease.

- Define options and critical dates in a lease.

Leases can have many events, options and key milestones dates that may be of significant importance and might require reminders of actions that need to be taken. The options and critical dates feature acts as a early warning of when these dates become due so you can take the appropriate action. Additionally, templates can be setup to expedite entry and enforce consistency in notification rules.

- Manage notes and contacts.

Enter notes to serve as a contact history of the lease, with optional attachments, if desired. From the defined Landlord or Tenant in the general information, customer or supplier contact information can be accessed from the customer or supplier master and referenced on the lease. You can also set up either internal or external lease administration contacts specific to that lease.

- Manage lease changes through amendment processing.

Amendment processing enables you to make changes to an active lease while keeping a historical record of the original lease and any prior amendments to that lease.

See [Understanding Leases](#).

## Chapter 4

# Integrating with Other Applications

---

## Understanding Product Integration

To fully take advantage PeopleSoft Lease Administration, you should understand the points of integration between PeopleSoft Lease Administration and the other PeopleSoft applications that you have purchased. Because applications share information, you must plan to work closely with the implementation teams that install other PeopleSoft applications to ensure that the PeopleSoft applications provide the full functionality and efficiency that your company requires.

PeopleSoft Lease Administration is designed to fully integrate with PeopleSoft Asset Management (through the Asset Repository Manager), Payables, Billing (through the Transaction Billing Processor), and General Ledger. PeopleSoft Lease Administration does not require the installation of some of these products; however, you cannot take advantage of asset management, lease administration, and financial processing functionality unless you have installed the corresponding PeopleSoft applications.

PeopleSoft Lease Administration also integrates with third-party Computer Aided Facilities Management (CAFM) applications through the centralized asset repository in PeopleSoft Asset Management and enables you to manage the facilities maintenance and moves using PeopleSoft Maintenance Management also through the centralized asset repository in PeopleSoft Asset Management.

---

## Integrating with PeopleSoft General Ledger

As with all financial applications, PeopleSoft General Ledger provides the foundation for how information is processed financially. As a result, you must define the general ledger ChartFields and other standard PeopleSoft General Ledger setup, such as general ledger business units, for reference in PeopleSoft Lease Administration. Additionally, because organizations are required to account for lease obligations based on compliance standards, PeopleSoft Lease Administration provides straightline accounting that integrates directly with PeopleSoft General Ledger to facilitate entries for compliance. You can set up straightline accounting defaults when you create your lease administration business units or it can be performed manually when you create a lease. After the straightline amounts are calculated and staged, the system assigns predefined general ledger ChartFields, such as account and department, to the accrual, deferral, and adjustment amounts. After the adjustments are complete, you can apply the accrual or deferral into the general ledger.

See “Understanding Journal Generator” (Application Fundamentals).

### Related Links

[Understanding Straightline Accounting](#)

---

## Integrating with PeopleSoft Asset Management

The integration between PeopleSoft Asset Management and PeopleSoft Lease Administration is through the centralized asset repository in PeopleSoft Asset Management. The asset repository enables you to set up properties manually or through the CAFM integration. These properties are generated into the repository in a controlled manner: through the capitalization processes between PeopleSoft Project Costing and PeopleSoft Asset Management, through the asset manager's entry as a new acquisition, or through the third-party CAFM integration.

The property data in the asset repository enables PeopleSoft Lease Administration to create and manage a lease between a landlord and a tenant by pulling the property asset data within the centralized asset repository. The asset repository store property data in this hierarchical order: site, building, floor, area, and space. For example, when you create a lease is for a building, the floor, area, and space are unavailable for another lease after that lease is activated. The same is true when a floor of the building is leased, the areas and spaces in that floor are unavailable. The only exception to this is when a sublease to the parent lease is created. Additionally, you cannot select properties that are designated as owned in the repository on payables leases. This minimizes chances of error as well as simplifies lists of properties for selection. However, you can select owned properties and subleases on receivables leases.

Other data stored in the asset repository includes: location of the property assets, measurement of site, building, floor, area or space, location of assets, and the department or employee assignments as well as property tax information on sites. This data is used for tracking and statistical reporting.

During the finalization of sites, users have the option of creating an asset in Asset Management. Any data that can be transferred from the Site record (in the site repository), or from the SAR will be copied to the asset definition.

See “Understanding General Ledger Standard Budgets” (PeopleSoft General Ledger), “Understanding How PeopleSoft Asset Management Integrates with Other Applications” (Asset Lifecycle Management Fundamentals).

### Related Links

“Adding and Maintaining Asset Information” (PeopleSoft Asset Management)

---

## Understanding Shared Product Functionality for Asset Management Leases

PeopleSoft Asset Management shares functionality with PeopleSoft Lease Administration to leverage the features and functions within Lease Administration that specifically address the core accounting requirements for payables leases (lessee agreements). Organizations licensed only for PeopleSoft Asset Management are not required to install Lease Administration, but there will be limited access to functionality in PeopleSoft Lease Administration. More specifically, customers licensed only for Asset Management can only access pages under the Asset Management navigation and the required high-level configurations. .

Customers licensed only for Asset Management will be able to enter multiple financial terms, integrate payments with Accounts Payable, perform straight-line accounting, use amendment processing and create manual fees. Customers licensed only to Asset Management will not have access to clauses, options

and critical dates, operating expenses, percent rent, security deposits, site selection and acquisition, my lease portfolio, and lease reports such as the lease abstract. In addition, customers licensed only for Asset Management are limited to only one asset per lease, and the tracking of lease options is limited to only those that are reasonably certain to be exercised.

Customers licensed only for Asset Management will have access to the following common components:

<b>Shared Product Configuration</b>	<b>Navigation</b>	<b>LA PeopleBook Sections to Refer</b>
Lease Administration Business Unit	Setup Financials/Supply Chain > Business Unit Related > Lease Administration > LA Business Unit Definition	<a href="#"><u>Creating Lease Administration Business Units</u></a>
LA Accounting Rules	Setup Financials/Supply Chain > Product Related > Lease Administration > Accounting > LA Accounting Rules	<a href="#"><u>Establishing Accounting Rules for Lease Administration</u></a>
Amendment Types	Setup Financials/Supply Chain > Product Related > Lease Administration > General Definitions > Amendment Types	<a href="#"><u>Defining Amendment Types</u></a>
Lease Types	Setup Financials/Supply Chain > Product Related > Lease Administration > General Definitions > Lease Types	<a href="#"><u>Defining Lease Types</u></a>
Prorata Basis	Setup Financials/Supply Chain > Product Related > Lease Administration > General Definitions > Prorata Basis	<a href="#"><u>Defining Prorata Basis</u></a>
Related Lease Type Setup	Setup Financials/Supply Chain > Product Related > Lease Administration > General Definitions > Related Lease Type Setup	<a href="#"><u>Defining Related Lease Type Setup</u></a>
Borrowing Interest Rate	Setup Financials/Supply Chain > Product Related > Lease Administration > General Definitions > Borrowing Interest Rate	<a href="#"><u>Defining Borrowing Interest Rate</u></a>
Transaction Routing Codes	Setup Financials/Supply Chain > Product Related > Lease Administration > Financial Terms > Transaction Routing Codes	<a href="#"><u>Defining Transaction Routing Codes</u></a>
Miscellaneous Rent Types	Setup Financials/Supply Chain > Product Related > Lease Administration > Financial Terms > Miscellaneous Rent Types	<a href="#"><u>Defining Miscellaneous Rent Types</u></a>

<b>Shared Product Configuration</b>	<b>Navigation</b>	<b>LA PeopleBook Sections to Refer</b>
Manual Fee Types	Setup Financials/Supply Chain > Product Related > Lease Administration > Financial Terms > LA Manual Fee Types	<a href="#"><u>Defining Manual Fee Types</u></a>
Economic Index	Setup Financials/Supply Chain > Product Related > Lease Administration > Financial Terms > Economic Index	<a href="#"><u>Defining Economic Index Values</u></a>
Role Types	Setup Financials/Supply Chain > Product Related > Lease Administration > User Roles > Role Types	<a href="#"><u>Defining Role Types</u></a>
Lease Administration Roles	Setup Financials/Supply Chain > Product Related > Lease Administration > Financial Terms > Lease Administration Roles	<a href="#"><u>Defining Lease Administration Roles</u></a>
Options	Setup Financials/Supply Chain > Product Related > Lease Administration > Options	<a href="#"><u>Defining Lease Administration Options</u></a>

In addition, customers licensed only for Asset Management will have access to the following pages for lease entry and processing residing under the Asset Management navigation:

<b>Shared Product Functionality</b>	<b>Navigation</b>	<b>PeopleBook Sections to Refer</b>
Migration and Transition	Asset Management > Asset Transactions > Leased Assets > Migration and Transition	<a href="#"><u>Understanding the Data Migration and Transition Process</u></a>
Create New Lease	Asset Management > Asset Transactions > Leased Assets > Create New Lease	<a href="#"><u>Defining General Lease Information</u></a>
Maintain Lease	Asset Management > Asset Transactions > Leased Assets > Maintain Lease	<a href="#"><u>Defining General Lease Information</u></a>
Generate Straightline Schedule	Asset Management > Asset Transactions > Leased Assets > Generate Straightline Schedule	<a href="#"><u>Generating Straightline Accounting Schedules</u></a>
Manual Straightline Adjustment	Asset Management > Asset Transactions > Leased Assets > Manual Straightline Adjustment	<a href="#"><u>Performing Manual Straightline Adjustments</u></a>
Processing Payments	Asset Management > Asset Transactions > Leased Assets > Processing Payments	<a href="#"><u>Managing Transactions for Payment Processing</u></a>



<b><i>Shared Product Functionality</i></b>	<b><i>Navigation</i></b>	<b><i>PeopleBook Sections to Refer</i></b>
Pending Lease Payables	Asset Management > Asset Transactions > Leased Assets > Pending Lease Payables	<a href="#"><u>Managing Transactions for Payment Processing</u></a>
Manage Transaction Generator	Asset Management > Asset Transactions > Leased Assets > Manage Transaction Generator	<a href="#"><u>Working with the Transaction Generator</u></a>
Manage Interface to AP/Billing	Asset Management > Asset Transactions > Leased Assets > Manage Interface to AP/Billing	<a href="#"><u>Running the Interface to AP/Billing Process</u></a>

---

## Integrating with PeopleSoft Contracts

PeopleSoft Lease Administration uses the Transaction Billing Processor to integrate with PeopleSoft Contracts to automatically generate invoices in PeopleSoft Billing for rents, operating expenses and specific maintenance fees on a predefined lead-time. The Transaction Billing Processor interface sends invoice requests from PeopleSoft Lease Administration to PeopleSoft Billing with the appropriate customer, tax, and accounting information in the right structure to display in the right grouping and format on the invoice.

See “Understanding Integration Messages for Transaction Billing” (PeopleSoft Contracts).

---

## Integrating with PeopleSoft Payables

Recurring rent, security deposits, operating expense reconciliations, percent rent sales reports, and manual fees are sent from PeopleSoft Lease Administration to PeopleSoft Payables for payment. PeopleSoft Payables then generates vouchers for the payments and sends information regarding the payments back to PeopleSoft Lease Administration. To make this integration seamless, you must establish PeopleSoft Payables setup information such as payables business units, withholding tax codes, and suppliers in the Supplier Information component (VNDR\_ID) for use in PeopleSoft Lease Administration setup and lease creation.

See “Understanding the PeopleSoft Payables Payment Interface” (PeopleSoft Payables).

---

## Integrating with PeopleSoft Billing

In PeopleSoft Lease Administration, a tenant is also known as a customer. You must set up customers in the Customer Information component (CUSTOMER\_GENERAL) before they can be attached to a lease and billed for their leases.

Recurring rent, security deposits, operating expense audits, percent rent sales reports, and manual fees are sent from PeopleSoft Lease Administration to PeopleSoft Billing through the Transaction Billing

Processor. PeopleSoft Billing then generates invoices for these payments and provides information regarding the invoices to PeopleSoft Lease Administration. Similar to the PeopleSoft Payables integration, PeopleSoft Billing setup information such as billing business units, bill type, bill by, and tax codes must be established for use in PeopleSoft Lease Administration setup.

---

**Note:** A Bill Cycle of *ON-DEMAND* needs to be setup in PeopleSoft Billing prior to activating a receivables lease.

---

See “Understanding the Billing Interface Data Structure” (PeopleSoft Billing).

---

## Integrating with PeopleSoft Asset Lifecycle Management Portal Pack

The PeopleSoft ALM portal pack provides a series of pagelets that reside on the portal and reference summarized data from PeopleSoft Lease Administration, the asset repository, and other financial applications for visibility to pertinent property and lease information.

See “Setting Up PeopleSoft Lease Administration for the PeopleSoft ALM Portal Pack” (PeopleSoft Financials, ESA, ALM, and SCM Portal Packs).

---

## Integrating with PeopleSoft Project Costing

During finalization users have the option of creating a project with basic information in Project Costing. Any data that can be transferred from the Site record (in the site repository), or from the SAR will be copied over to the project.

# Establishing Lease Administration Business Units and Accounting Rules

---

## Understanding PeopleSoft Lease Administration Business Units

To define PeopleSoft Lease Administration business units, use the LA Business Unit Definition component (RE\_BUS\_UNIT).

PeopleSoft Lease Administration defines a business unit as an operational subset of your organization that enables you to plan your operations around the way that you work. You can use a business unit to define regional or departmental units in an organization.

Before you begin the day-to-day operation of your PeopleSoft Lease Administration system, you must create a lease administration business unit which is the backbone of your PeopleSoft Lease Administration system. You associate each lease to a lease administration business unit, and the system populates many lease attributes by default from the values that you define for that business unit.

As you plan the optimal structure for your PeopleSoft Lease Administration system, keep in mind its position in Oracle's PeopleSoft suite of applications. A lease administration business unit reads property data from the asset repository based on the asset management business unit and supplies payment data to PeopleSoft Payables based on the payables business unit, invoice data through the Transaction Billing Processor to PeopleSoft Billing based on the contracts business unit, and accounting information to the general ledger based on the general ledger business unit. Therefore, you must establish business units for PeopleSoft Asset Management, Payables, Contracts, and General Ledger before you establish lease administration business units.

After you establish business units for the other PeopleSoft applications, PeopleSoft Lease Administration can map to the applications. Be careful when selecting the appropriate business units. Make sure that all of the mappings make sense within the suite and that the other products map to the same business units in their respective setup components. For example, assume that you establish a lease administration business unit of US001 and map it to a general ledger business unit of US001 for straightline accounting entries. Most likely the payables business unit and billing business unit match the same general ledger business unit of US001 because PeopleSoft Payables and PeopleSoft Billing also post accounting entries to PeopleSoft General Ledger for lease commitments in the Lease Administration feature.

*PeopleTools: Applications User's Guide*

See “Understanding Asset Management Business and Cash Generating Units” (Asset Lifecycle Management Fundamentals).

See “Defining General Ledger Business Units” (PeopleSoft General Ledger).

See “Understanding PeopleSoft Payables Business Units” (PeopleSoft Payables).

## Understanding PeopleSoft Lease Administration Accounting Rules

To define PeopleSoft Lease Administration accounting rules, use the LA Accounting Rules Definition component (CA\_ACCT\_RULES).

Accounting rules for PeopleSoft Lease Administration are essential for providing lease transactions with appropriate accounting entries sent to PeopleSoft Payables, Billing, and General Ledger. PeopleSoft Payables and Billing provide the offsetting entries to the expense or revenue accounting passed over. You must specify default accounting rules for each transaction destination with an option of providing defaults for each transaction group. You can further define accounting for specific transaction codes within a transaction group that requires its own set of accounting rules. For example, you can set up a standard accounting rule for the transaction group of operating expenses with a transaction destination of PeopleSoft Payables.

When operating expense transactions are generated and are sent to PeopleSoft Payables the defined standard accounting rule for those transactions are applied and sent as well. If a specific operating expense such as janitorial services has a unique account requirement, you can set up an accounting rule for the transaction destination of PeopleSoft Payables, transaction group of operating expenses, and a transaction routing code for janitorial services with the accounting specific to janitorial services.

Three sets of debit/credit pairs are defined in the lease administration accounting rules for PeopleSoft Lease Administration:

- Transactions sent to the PeopleSoft Billing (BI) destination contain accounting rules that credit the revenue.

The offset of Accounts Receivable is determined in PeopleSoft Billing setup.

- Transactions sent to the PeopleSoft Payables (AP) destination contain the debit to expenses.

The offset of Payable is determined in PeopleSoft Payables setup.

- Transactions sent to the PeopleSoft General Ledger (GL) destination contain both the debit and credit accounts as these are the straightline accounting entries generated from PeopleSoft Lease Administration.

The following table shows the valid and invalid combinations that can exist in the accounting rules for PeopleSoft Lease Administration. Edit checking is added to the Accounting Rules for Lease Administration page to ensure that only valid combinations are saved:

<i>Transaction Destination</i>	<i>Transaction Group</i>	<i>Valid Combination?</i>
AP	Base Rent	Yes
BI	Base Rent	Yes
GL	Base Rent	No

<b>Transaction Destination</b>	<b>Transaction Group</b>	<b>Valid Combination?</b>
AP	Security Deposit	Yes
BI	Security Deposit	Yes
GL	Security Deposit	No
AP	Straightline Accounting	No
BI	Straightline Accounting	No
GL	Straightline Accounting	Yes
AP	Operating Expense	Yes
BI	Operating Expense	Yes
GL	Operating Expense	No
AP	Percent Rent	Yes
BI	Percent Rent	Yes
GL	Percent Rent	No
AP	Miscellaneous Rent	Yes
BI	Miscellaneous Rent	Yes
GL	Miscellaneous Rent	No
AP	Manual Fee	Yes
BI	Manual Fee	Yes
GL	Manual Fee	No

The lease accounting hierarchy provides flexible defaulting for lease payment-related accounting entries. The lease payment (LPY) and the prior period lease payment (PLP) accounting entry templates in Asset Management serve as the highest level of the lease payment accounting entry default hierarchy. The lease obligation (LO) can be overridden by the lowest level of Transaction Group/ Routing code combination LA Accounting Rule, followed by ChartField Override at the lease term level.

The following graphic illustrates the PeopleSoft Lease Accounting Hierarchy.

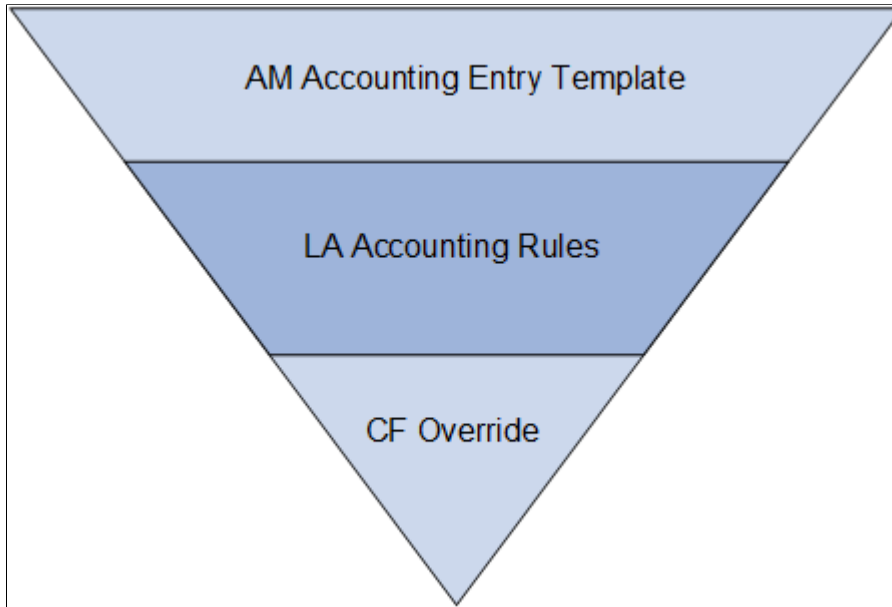

---

**Note:** Accounting Hierarchy is applicable only for payable leases.

---

For additional information, refer “Understanding Accounting Entry Setup” (PeopleSoft Asset Management)

### Implementation Considerations

Considerations when implementing lease accounting include:

- The highest level in the default hierarchy is the AM accounting entry templates. A LA business unit option permits can be enabled to limit the default hierarchy to LA accounting rules and ChartField override at the lease term level.
- The default hierarchy applies to the recognition of the lease obligation reduction only.
- LA accounting rules must be configured for percent rent, operating expenses, manual fees, miscellaneous rent, and straightline accounting, as these payments do not typically share the same accounting as lease payments recorded under base rent.
- Multiple ChartField distributions are configured at the ChartField Override level.

### Related Links

[Creating Lease Administration Business Units](#)

---

## Understanding Accounting for Foreign Currency Leases

Lease Administration supports foreign currency leases. A foreign currency lease is a lease with a currency code on the financial terms page that is different from the currency code for the Lease Administration business unit. Foreign currency lease transactions capture two amounts:

- *Transactional Currency Amount*, denominated in the lease currency.
- *Base Currency Amount*, which is calculated by applying a currency exchange rate to the transactional currency amount for a specified date.

The following sections describe the unique accounting requirements for foreign currency leases.

For details about foreign currency accounting, see the *Accounting for Foreign Currency Payable Leases in PeopleSoft* white paper on My Oracle Support ([support.oracle.com](https://support.oracle.com)).

---

**Important!** The foreign currency lease accounting guidance provided in this documentation is based on Oracle-PeopleSoft's interpretation of accounting guidance and assumptions in how accounts are typically used by an organization. Please review account revaluation accounting policies with your internal accounting department.

---

## Transaction Currency Translation Installation Option

The Transaction Currency Translation option on the “Installation Options - Asset Management Page” (Application Fundamentals) controls how the Create Accounting Entries and Depreciation Close processes manage foreign transaction currency amounts.

If you select the option, the transaction currency detail is not retained. Consequently, accounts such as the lease obligation account cannot be revalued in PeopleSoft General Ledger because the currency transaction amounts are not being tracked.

If you do not select the option, the transaction amount, currency code, and exchange rate are retained, permitting accounts such as the lease obligation account to be revalued in PeopleSoft General Ledger.

## Currency Realized Gain and Loss

Currency realized gain and loss accounting entries are created at the time of lease payment for both operating leases and finance leases. These entries are stored in the Asset Management Accounting Line Distribution (DIST\_LN) table and sent to PeopleSoft General Ledger for posting.

## Rent Expense

Rent expense for operating leases is bifurcated into two components:

- *Amortization of Right-of-Use Asset*: Uses a fixed rate associated with the amortization of the right-of-use asset.

The accounts associated with this component should not be revalued in PeopleSoft General Ledger.

- *Interest*: Calculates interest for right-of-use assets and uses a conversion rate at month end.

The accounts associated with this component should be revalued in PeopleSoft General Ledger.

Straight-line adjustments provide an equal pattern of expense recognition over the life of the lease when lease payment amounts change over time and use the currency conversion rate associated with amortization of the right-of-use asset.

## Lease Modifications

Lease modifications can impact the accounting for both operating and finance leases as follows.

### Asset Cost and Foreign Currency Realized Gain and Loss

An asset has one exchange rate at any given time. The rate starts as the rate in effect at lease commencement. The lease commencement rate is used in monthly accounting of rent expense and depreciation to reduce the cost of the asset until an amendment is processed. At the time of lease amendment, the exchange rate associated with the asset is updated to reflect the new exchange rate in effect at the time of the amendment. The new exchange rate is reflected in the monthly reductions to the cost of the asset through rent expense and depreciation.

Existing functionality provides options to identify whether a modification impacts only a newly added asset or existing assets too. For those assets impacted by the amendment, the system creates a cost adjustment in the Asset Management *COST* table to reflect any new or changed payments using the currency exchange rate in effect at the time of lease amendment.

In addition, if the impacted asset was already in existence at the time of amendment, the system creates a cost adjustment to revalue the net book value of the asset to reflect the currency exchange rate at the time of the lease amendment with an offset to foreign currency gain and loss.

---

**Note:** Currency exchange gains and losses are identified with a separate cost type. Use the **Currency Exchange Gain/Loss** option on the “Cost Types Page” (Asset Lifecycle Management Fundamentals) to set up a currency exchange cost type.

---

### Lease Obligation

Adjustments to the lease obligation resulting from lease amendments use the exchange rate at the commencement date of the lease. The revaluation of the lease obligation account in base currency should be performed in General Ledger using existing revaluation functionality.

## Lease Interest Accruals

Lease interest accruals are recorded when payments are made less frequently than monthly (for example, quarterly or annually) and are measured using the rate at month end. This applies to financial terms calculated in advance and arrears. Based on Oracle-PeopleSoft's interpretation of the accounting guidance, the lease interest accrual account may be revalued in PeopleSoft General Ledger.

## Asset ChartField Transfers, Recategorizations, and Retirement Transactions

ChartField transfers, recategorizations, and retirement transactions retain lease obligation amounts in the transaction currency of the lease. This facilitates the revaluation of the lease obligation account balance from transaction currency to base currency in general ledger at month-end.

## Unrealized Gains and Losses

Unrealized gains and losses on accounts such as the lease obligation account, that result from the passage of time are calculated using existing revaluation functionality in PeopleSoft General Ledger.



PeopleSoft provides the query, *RE\_UNREALIZED\_GL*, which details the unrealized currency gains and loss by leased asset.

## Creating Lease Administration Business Units

After you determine how many business units that you use and how to organize them, you must define PeopleSoft Lease Administration-specific business unit definitions. A business unit definition specifies the transaction processing defaults and configuration options associated with the business unit. Two pages are used to define lease administration business units:

- The Business Unit Definition General page.
- The Business Unit Definition Transaction Settings page.

This topic lists prerequisites and discusses how to define lease administration business units and transaction settings.

### Pages Used to Establish Lease Administration Business Units

<i>Page Name</i>	<i>Definition Name</i>	<i>Usage</i>
<u>Lease Administration Business Unit Definition - General Page</u>	RE_BU_CFG1	Create or update a Lease Administration business unit definition. This page enables you to set various configuration options, such as the mappings to other business units, the auto-straightline option, the general limits and measures, and lease expiration notifications.
<u>Lease Administration Business Unit - Transaction Settings Page</u>	RE_BU_CFG2	Define transaction processing options, such as processing lead time and default transaction routing codes.

### Prerequisites

You must establish at least one assets, billing, contract, payables, and general ledger business unit in each of those respective applications to map to the Lease Administration business unit when it is created. You must also set up a PeopleSoft calendar to define the term calendar ID and percent rent calendar ID to define the proration method.

### Lease Administration Business Unit Definition - General Page

Use the Lease Administration Business Unit Definition - General page (RE\_BU\_CFG1) to create or update a Lease Administration business unit definition.

This page enables you to set various configuration options, such as the mappings to other business units, the auto-straightline option, the general limits and measures, and lease expiration notifications.

Navigation:

**Set Up Financials/Supply Chain > Business Unit Related > Lease Administration > LA Business Unit Definition > General**

This example illustrates the fields and controls on the Lease Administration Business Unit Definition - General page (1 of 3). You can find definitions for the fields and controls later on this page.

General
Transaction Settings
Options and Critical Dates

Business Unit Definition - Lease Administration  
**Lease Administration Business Unit Definition - US001**

<b>Business Unit</b> US001	
<b>*Short Description</b> <input style="width: 80%;" type="text" value="US001"/>	<b>*Description</b> <input style="width: 80%;" type="text" value="US001 NEW YORK OPERATIONS"/>

**Mapping**

**Business Units**

*General Ledger	<input style="width: 40%;" type="text" value="US001"/> <input type="button" value="Q"/>
*Asset Management	<input style="width: 40%;" type="text" value="US001"/> <input type="button" value="Q"/>
*Accounts Payable	<input style="width: 40%;" type="text" value="US001"/> <input type="button" value="Q"/>
Contracts	<input style="width: 40%;" type="text" value="US001"/> <input type="button" value="Q"/>

**Journal Templates**

General Ledger	<input style="width: 40%;" type="text" value="REM"/> <input type="button" value="Q"/>
----------------	---

**Lease Payments Accounting**

 Use AM Accounting Templates

**Other Lease Payments Accounting**

 Use AM Accounting Templates

**Auto Straightline**

<input checked="" type="checkbox"/> Rent & Miscellaneous Rent	<input checked="" type="checkbox"/> Operating Expenses
---	--

This example illustrates the fields and controls on the Lease Administration Business Unit Definition - General page (2 of 2). You can find definitions for the fields and controls later on this page.

**Limits, Measures, and Calendars** ⓘ

Unit of Measure  Square Feet \*Proration Method

\*Base Currency  US Dollar \*Rate Type  Current Rate

Percent Rent Calendar ID  Monthly \*Lease Calendar

Recognize Monthly Expense

Tolerances:  
 Percent Rent  % Operating Expenses  %

**Lease Expiration Notification**

Notify Only  Update Only  Notify and Update

**Automated Workflow**

Lease Transactions  Critical Dates

Transaction Queue Monitoring TQM Outstanding Days

Sales Amount Monitoring  Operating Expense Monitoring

Lease Activation Approval  Lease Amendment Approval

**Thresholds for Lease Classification** ⓘ

▼ Finance Leases for Lessees (Payables)

\*Lease Period To Useful Life  %

\*Present Value Lease Payments to Asset Fair Value  %

Percentage of Fair Value Considered a Bargain Purchase  %

Recognize Capitalized Assets as Finance Under IFRS:

Recognize Capitalized Assets as Finance Under GASB:

<b>Field or Control</b>	<b>Description</b>
<b>Business Unit</b>	When you add a business unit, you must provide a description and specify a value in the <b>Default SetID</b> field.

## Business Units

<b>Field or Control</b>	<b>Description</b>
<b>General Ledger</b>	<p>Displays general ledger business unit. This general ledger business unit defines the accounting processing for the associated lease administration business unit for straightline accounting entries. All leases with straightline accounting entries created for this lease administration business unit post to the general ledger business unit specified here.</p> <hr/> <p><b>Note:</b> Transactions generated through the PeopleSoft Payables and PeopleSoft Billing interfaces are posted through those respective applications.</p>
<b>Asset Management</b>	<p>Displays asset management business unit. The asset management business unit (AMBU) defines the asset information associated with this lease administration business unit.</p> <p>All leases created use the PeopleSoft Asset Management asset information to manage the life cycle of the lease for the asset specified on the lease from the AMBU. Because PeopleSoft Asset Management might post accounting entries to the general ledger for its own purposes (such as capitalization), assets selected on leases under this lease administration business unit are restricted to only the assets under the business unit mapped here.</p> <hr/> <p><b>Note:</b> General Ledger and Asset Management business units are display only. Lease Administration always uses the GL Business Unit mapped in the AM Business Unit Book Definition for the accounting entries created from the Lease Administration product. Lease Administration will map with AM Business Unit in a one to one manner. You cannot edit this business unit mapping.</p>
<b>Accounts Payable</b>	<p>Select a payables business unit. All payments made for leases under a lease administration business unit are sent to Payables for processing using this business unit.</p>
<b>Contracts</b>	<p>Select a contracts business unit. When creating a lease in the lease administration business unit, a contract header and line is also created in the contracts business unit. This initiates the transaction billing processor within the contracts business unit to determine the routing of the rent to be billed.</p>

## Journal Templates

<i>Field or Control</i>	<i>Description</i>
<b>General Ledger</b>	Select the general ledger template to be associated with the lease administration business unit. Accounting entries created for this lease administration business unit use this general ledger accounting template to generate the journal in PeopleSoft General Ledger.

## Lease Payments Accounting

<i>Field or Control</i>	<i>Description</i>
<b>Use AM Accounting Templates</b> (Use Asset Management Accounting Templates)	<p>Select this check box to disable GL account overrides for lease-level asset cost distributions. All GL account distributions related to the lease liability and right-of-use asset default from the Asset Management Accounting Entry Template.</p> <p>When you select this check box, the <b>Account</b> and <b>Prior Period Accounts</b> tabs do not appear on the Asset Cost Distribution page.</p> <p>For more information about Accounting Entry Templates, see “Defining Accounting Entries” (Asset Lifecycle Management Fundamentals).</p>

## Other Lease Payments Accounting

<i>Field or Control</i>	<i>Description</i>
<b>Use AM Accounting Templates</b>	<p>Select this check box to create payables lease entries by the Depreciation Close process in Asset Management.</p> <p>If the check box is not selected, then Lease Administration accounting rules will be used to send Payables and Receivables accounting entries needed to record the voucher and bill, respectively.</p> <p>See “Creating Accounting Entries” (PeopleSoft Asset Management)</p>

## Auto Straightline

PeopleSoft Lease Administration provides the ability to support the accounting and reporting for operating leases by allowing you to enable or disable the straightline processing at the business unit level.

For example, let's say that a tenant agrees to rent a space from the landlord. Under FASB-13 Operating Lease provisions, if the rent amount or recurring expense amount for the rented space is not evenly termed across periods, or free rent (zero rent) is applicable for certain periods, those amounts must be reported in the PeopleSoft General Ledger on a *straightline* basis (an even distribution).

See [Understanding Straightline Accounting](#).

<b>Field or Control</b>	<b>Description</b>
<b>Rent &amp; Miscellaneous Rent</b>	Select to enable base rent and miscellaneous rent transactions to use the straightline accounting process by default for this lease administration business unit. This mechanism assists with lease entry. When a new lease or recurring rent term is added, the straightline check box is automatically selected or cleared based on the setting defined here. You can deselect the check box on the lease from the default value defined on the business unit to enable or disable straightline processing on specific financial terms on a specific lease.
<b>Operating Expenses</b>	Select to enable operating expense transactions to automatically perform straightline accounting processing for this lease administration business unit. When a new lease or an operating expense is added, the straightline check box is selected or cleared by default based on the setting defined here. You can deselect the check box on the lease from the default value defined on the business unit to enable or disable straightline processing on specific financial terms on a specific lease.

### Limits, Measures, and Calendars

<b>Field or Control</b>	<b>Description</b>
<b>Unit of Measure</b>	Select the default unit of measure for referencing the space measurement of a property in a lease for this lease administration business unit.

<b>Field or Control</b>	<b>Description</b>
<b>Proration Method</b>	<p>Defines the rule that the system uses to determine how much to apportion to the recurring rent based on the term calendar and the proration method that you define on the lease. The term calendar determines the start and end date of the billing period. If the term start date does not correspond with the calendar period start date, the payment for the first period will be for the prorated period. For example, if you use the normal monthly calendar, January to December, and base rent starts on 01/12/2005, then the first payment must be for the prorated amount for the time frame 01/12/2005 to 01/31/2005. The system also performs proration when the term end date does not correspond to the calendar period end date.</p> <p>The selection drives the default while setting up the recurring terms on the lease. You can override the default. Available methods for proration are:</p> <p><i>360 Days:</i> Select to prorate on monthly frequencies, where each month has only 30 days.</p> <p><i>365 Days:</i> Select to prorate according to a standard 365 day Gregorian calendar using each of the 12 months as the start and end dates (31 days in January, 28 or 29 days in February, 31 days in March, and so on). This method supports weekly, monthly, quarterly, and annual frequencies.</p> <p><i>No Proration:</i> Select if you do not want the proration method for the rent provided by default. You can define the proration method at the lease level.</p>
<b>Base Currency</b>	<p>Select the default base currency for this lease administration business unit. Lease transactions created in this lease administration business unit automatically inherit this base currency, although you can override the base currency on the lease.</p> <p>The currency specified on the lease is the currency used for invoicing or payment by PeopleSoft Billing and PeopleSoft Payables, respectively.</p>
<b>Rate Type</b>	<p>Select the currency exchange rate type to be used when the system must perform currency translations for this business unit.</p> <hr/> <p><b>Note:</b> The most commonly used rate type is <i>CRRNT</i> (current).</p> <hr/>

<b>Field or Control</b>	<b>Description</b>
<b>Percent Rent Calendar ID</b>	<p>Select the detail calendar ID. Percent rent sales reporting uses a specific calendar with distinct periods and start and end dates. The detail calendar that you select provides the system with the appropriate information to understand the frequency with which you report or receive sales reports. In addition, this calendar structure enables the system to search for and determine when sales reports are missing, as well as to prevent duplicate sales reports for the same period.</p> <p>See “Defining Detail Calendars” (Application Fundamentals).</p>
<b>Lease Calendar</b>	<p>Define the lease calendar, which the system populates on all financial terms of the lease by default for this business unit. The lease calendar determines the start and end date of billing periods for recurring financial terms. You must select a calendar with a 12 period monthly allocation type.</p> <p>See “Setting Up Calendar Builder” (Application Fundamentals).</p>
<b>Recognize Monthly Expense</b>	<p>Select this option to enable the <b>Recognize Monthly Expense</b> option on the <a href="#">Create New Lease - Financial Terms Page</a>.</p> <p>You can still manually deselect the option on the Create New Lease - Financial Terms page, should you wish to do so.</p> <p>This option prorates non-monthly financial terms (such as quarterly schedules) by period. Lease interest for finance leases and the amortization of the underlying assets for operating leases are recognized on a monthly basis.</p>
<b>Tolerances: Percent Rent</b>	<p>Define the percentage tolerances for a sales category amount for this lease administration business unit. This value is used for visual purposes on the sales report only. If a sales report category amount has changed significantly over the previous month, the system displays a warning message on the sales reporting entry worksheet to indicate that it has exceeded the tolerance.</p>
<b>Tolerances: Operating Expenses</b>	<p>Define the percentage tolerance for operating expense amounts for this lease administration business unit. This value is used for visual purposes on the operating expense audit page only. If an operating expense category amount has changed significantly over the previous year, the system displays an icon on the operating expense audit/reconciliation worksheet to indicate that it has exceeded the tolerance.</p>



## Lease Expiration Notification

The Transaction Generator Application Engine (RE\_GENTRANS) includes a process that automates lease expiration. The automated lease expiry process sets the status of any active lease to expired when the lease end date precedes the execution date of the transaction generator. The Lease Expiration Notification option determines how the automated lease expiry process treats leases attached to the current business unit.

<b>Field or Control</b>	<b>Description</b>
<b>Notify Only</b>	Select to have the lease expiry process send an email notification when a lease is due to expire. The status of the lease is not changed. The notification email is sent to the Lease Administrator and Portfolio Manager named on the lease.
<b>Update Only</b>	Select to automatically set the status of a lease to <i>Expired</i> when the lease end date has passed. No notifications are issued, however, a system generated note is added to the lease to record the expiration.
<b>Notify and Update</b>	Select this option to automatically set the status of a lease to <i>Expired</i> when the lease end date has passed. A notification email is sent to the Lease Administrator and Portfolio Manager named on the lease. In addition, a system-generated note is added to the lease to record the expiration.  See <a href="#">Define Option Notifications Page</a> .

## Automated Workflow

<b>Field or Control</b>	<b>Description</b>
<b>Lease Transactions</b>	Select this check box to enable workflow for lease transactions based on events setup on the workflow configuration. Tasklists will be created for the Lease Administrator or Portfolio manager based on the role which would enable them to review the lease.

<b>Field or Control</b>	<b>Description</b>
<b>Critical Dates</b>	Select this check box to enable workflow for critical dates. The reviewer of the critical date notification will be directed to the Lease Abstract worksheet to review the cause of the notification and take appropriate action based on the upcoming event.

<b>Field or Control</b>	<b>Description</b>
<b>Transaction Queue Monitoring</b>	Select this check box to enable workflow for transaction queue monitoring. A batch process will identify all the transactions in the queue which are beyond a threshold setup in BU level and send notifications to the Lease Administrator or Portfolio Manager about the pending approval.

<b>Field or Control</b>	<b>Description</b>
<b>TQM Outstanding Days</b>	If Transaction Queue Monitoring is enabled, the outstanding days has to be entered.

<b>Field or Control</b>	<b>Description</b>
<b>Sales Amount Monitoring</b>	Select this check box to enable workflow to create tasklists if the sales billing amount exceeds tolerance. The approver will be directed to an approval page from the tasklist. The transactions will only be sent to the Transaction Queue after approval.

<b>Field or Control</b>	<b>Description</b>
<b>Operating Expense Monitoring</b>	Select this check box to enable workflow to create tasklists if the operating expense for a category exceeds tolerance. The approver should be directed to an approval page from the tasklist. The transactions should be sent to the Transaction Queue only after approval.

<b>Field or Control</b>	<b>Description</b>
<b>Lease Activation Approval</b>	Select this check box to enable approval workflow for lease activations.
<b>Lease Amendment Approval</b>	Select this check box to enable approval workflow for lease amendments.

## Thresholds for Lease Classification

Allows you to establish thresholds for capitalizing a lease component based on your internal accounting policies. The system uses the thresholds entered to suggest a lease classification for each lease component (asset ID). The lease classification can be overridden.

<b>Field or Control</b>	<b>Description</b>
<b>Lease Period to Useful Life</b>	Enter a percentage to compare the lease period to remaining useful life.
<b>Present Value Lease Payments to Asset Fair Value</b>	Enter a percentage to compare the present value lease payments to the asset's current fair value.
<b>Percentage of Fair Value Considered a Bargain Price</b>	Enter a percentage to compare a purchase option as a percentage of expected asset fair value at end of the lease. The default value is 0.
<b>Recognize Capitalized Assets as Finance Under IFRS</b>	<p>Select this option to identify leases within the selected business unit as IFRS.</p> <hr/> <p><b>Note:</b> You can chose only one leasing guidance for the selected business unit—FASB, GASB, or IFRS. If you do not select either the IFRS or GASB option on this page, the selected business unit uses FASB standards.</p> <hr/>
<b>Recognize Capitalized Assets as Finance Under GASB</b>	<p>Select this option to identify leases within the selected business unit as GASB.</p> <hr/> <p><b>Note:</b> You can chose only one leasing guidance for the selected business unit—FASB, GASB, or IFRS. If you do not select either the IFRS or GASB option on this page, the selected business unit uses FASB standards.</p> <hr/>

## Lease Administration Business Unit - Transaction Settings Page

Use the Lease Administration Business Unit Definition - Transaction Settings page (RE\_BU\_CFG2) to define transaction processing options, such as processing lead time and default transaction routing codes.

Navigation:

**Set Up Financials/Supply Chain > Business Unit Related > Lease Administration > LA Business Unit Definition > Transaction Settings**

This example illustrates the fields and controls on the Lease Administration Business Unit Definition - Transaction Settings page. You can find definitions for the fields and controls later on this page.

General		Transaction Settings		Options and Critical Dates	
Business Unit Definition - Lease Administration Lease Administration Business Unit Definition - US001					
Business Unit US001					
<b>Billing Options</b> Lead Time (Days) <input type="text" value="10"/> <input checked="" type="checkbox"/> Auto Approve Straightline Accounting Routing Codes: *Accrual <input type="text" value="FASB_R_ACCRUAL"/> *Deferral <input type="text" value="FASB_R_DEFERRAL"/> *Adjustment <input type="text" value="FASB_R_ADJUST"/>			<b>Accounts Payable Options</b> Lead Time (Days) <input type="text" value="10"/> <input type="checkbox"/> Auto Approve Straightline Accounting Routing Codes: *Accrual <input type="text" value="FASB_P_ACCRUAL"/> *Deferral <input type="text" value="FASB_P_DEFERRAL"/> *Adjustment <input type="text" value="FASB_P_ADJUST"/>		
<b>Item Routing Codes</b> *Base Rent <input type="text" value="RENT"/> Security Deposits: *Issue <input type="text" value="SECDEP_ISSUE"/> *Interest <input type="text" value="SECDEP_INTEREST"/> *Deduction <input type="text" value="SECDEP_DED"/> *Refund <input type="text" value="SECDEP_REFUND"/>					
<b>Group Routing Codes</b> *Operating Expenses <input type="text" value="OPEX_DEFAULT"/> *Miscellaneous Rent <input type="text" value="MISC_DEFAULT"/> *Percent Rent <input type="text" value="PRENT_DEFAULT"/> *Manual Fees <input type="text" value="MAN_DEFAULT"/>					
<b>Billing Defaults</b> Billing Type <input type="text" value="RE"/> Bill By <input type="text" value="CONTRACT"/> Bill Source <input type="text" value="SERVICE"/>					

## Billing Options

<i>Field or Control</i>	<i>Description</i>
<b>Lead Time (Days)</b>	Specify the billing default transaction lead time for automatically generated transactions for this lease administration business unit. The date specified determines the number of days before the billing date that you want the automatically generate process to occur. If the invoice due date is the end of the month and it takes your organization approximately 10 days to process the invoice, then set the lead time to <i>10</i> . This setting is used to compensate for processing times needed for invoices to reach the tenant before the due date. Then, on each lease, the Transaction Generator picks up any recurring transactions based on the lease due date, less the lead time established here. Each recurring rent page includes an <b>Anticipated Process Date</b> field, which takes this setting into account.
<b>Auto Approve</b>	Select to automatically approve transactions in the transaction queue. The system sets the transactions to <i>Pending</i> status if nothing is selected. You need to approve each transaction before the transactions can be processed.

## Billing Options - Straightline Accounting Routing Codes

<i>Field or Control</i>	<i>Description</i>
<b>Accrual</b>	Enter the transaction routing code for the system to use as a default for straightline accruals in this lease administration business unit. The routing code for accruals determines the processing for receivables lease transactions in the general ledger.
<b>Deferral</b>	Enter the transaction routing code for the system to use as a default for straightline deferrals in this lease administration business unit. The routing code for deferrals determines the processing of receivables lease transactions in the general ledger.
<b>Adjustment</b>	Enter the transaction routing code for the system to use as a default for straightline adjustments in this lease administration business unit. The routing code for adjustments determines the processing of receivables lease transactions in the general ledger.

## Accounts Payable Options

<b>Field or Control</b>	<b>Description</b>
<b>Lead Time (Days)</b>	Specify the payables default transaction lead time for auto-generated transactions for this lease administration business unit. The date specified determines the number of days prior to the due date that you want the auto-generate process to occur. If the due date is the end of the month and it takes your organization approximately 10 days to process (from vouchering to mailing), then set the lead time to <i>10</i> . This setting is used to compensate for processing times needed to ensure that a payment reaches the landlord by the due date. Then, on each lease, the Transaction Generator picks up any recurring transactions based on the lease due date, less the lead time established here. Each recurring rent page includes an <b>Anticipated Process Date</b> field, which takes this setting into account.

<b>Field or Control</b>	<b>Description</b>
<b>Auto Approve</b>	Select to automatically approve transactions in the transaction queue. The system sets the transactions to <i>Pending</i> status if nothing is selected. You need to approve each transaction before the transactions can be processed.

## Accounts Payable Options - Straightline Accounting Routing Codes

<b>Field or Control</b>	<b>Description</b>
<b>Accrual</b>	Enter the transaction routing code for the system to use as a default for straightline accruals in this lease administration business unit. The routing code for accruals determines the processing for payables lease transactions in the general ledger.
<b>Deferral</b>	Enter the transaction routing code for the system to use as a default for straightline deferrals in this lease administration business unit. The routing code for deferrals determines the processing of payables lease transactions in the general ledger.
<b>Adjustment</b>	Enter the transaction routing code for the system to use as a default for straightline adjustments in this lease administration business unit. The routing code for adjustments determines the processing of payables lease transactions in the general ledger.

## Item Routing Codes

<i>Field or Control</i>	<i>Description</i>
<b>Base Rent</b>	Select the routing code for base rent transactions for this lease administration business unit. All rent transactions generated for this lease administration business unit use this routing code to generate entries that are interfaced into the general ledger.  See <a href="#">Understanding Transaction Routing Codes</a> .

## Security Deposit

<i>Field or Control</i>	<i>Description</i>
<b>Issue</b>	Enter the routing code to be used for standard security deposit transactions.
<b>Deduction</b>	Select the routing code for security deposit deductions. Security deposit deduction transactions that you create use this default to generate entries that are interfaced into the general ledger. Deductions are used only in the security deposit refund process. Any deductions for damages also use this code.
<b>Interest</b>	Select the routing code for security deposit interest. Security deposit transactions that you create use this routing code to generate entries that are interfaced into the general ledger. Interest is used only in the security deposit refund process. Any interest earned on security deposits held use this code.
<b>Refund</b>	Select the routing code for security deposit refunds. Security deposit refund transactions that you create use this default to determine processing in the general ledger. Refund is used only in the security deposit refund process to reverse the initial issue amount.

## Group Routing Codes

The Lease Administration application uses transaction groups to link certain classes of transaction. The transaction groups—Operating Expense, Percentage Rent, Manual Fees and Miscellaneous Rent are collections of transaction categories. The **Group Routing Codes** field enables you to define the default routing code for each transaction group if you elect not to specify a routing code at the transaction category level. For example, let's say that you have defined an Operating Expense category called Garbage Removal and you choose not to provide a specific routing code for Garbage Removal. When an Operating Expense transaction is generated for Garbage Removal, the transaction generator attempts to locate the category's routing code. Since the routing code is not specified at the category level, the

transaction generator looks for a routing code specified at the transaction group level, and the system picks up the default routing code for Operating Expenses.

**Note:** Transaction Group default routing codes are all required fields. A transaction cannot be processed unless a routing code exists and the transaction group is the top level of the defaulting chain.

<i>Field or Control</i>	<i>Description</i>
<b>Operating Expense</b>	Select the default routing code for all operating expenses. The system provides this routing code by default when a specific routing code is not defined for an operating expense.
<b>Percent Rent</b>	Select the default routing code for all percent rent transactions. The system provides this routing code by default when a specific percent rent routing code is not defined for percent rent transactions.
<b>Miscellaneous Rent</b>	Select the default routing code for all miscellaneous rent. The system provides this routing code by default when a specific routing code is not defined for miscellaneous rent transactions.
<b>Manual Fees</b>	Select the default routing code for all manual fees. The system provides this routing code by default when a specific routing code is not defined for manual fee transactions.

## Billing Defaults

<i>Field or Control</i>	<i>Description</i>
<b>Bill Type</b>	<p>Select a default bill type for leases created under this lease administration business unit. The bill type represents a category of activity being billed.</p> <p>This is prompted from Billing Setup. This is not a required field in RE BU setup. If this is left blank, this will be defaulted from the Contracts BU setup. If this is null for that BU in Contracts also this will raise an error on Lease Activation.</p>
<b>Bill Source</b>	<p>Select the default billing source. The billing source is used to identify where the billing activity came from and to then associate default billing information with that billing activity.</p> <p>This is prompted from Billing Setup. This is not a required field in RE BU setup. If this is left blank, this will be defaulted from the Contracts BU setup. If this is null for that BU in Contracts also this will raise an error on Lease Activation.</p>



<b>Field or Control</b>	<b>Description</b>
<b>Bill By</b>	<p>Select a default bill by for leases created under this lease administration business unit. The <b>Bill By</b> field enables you to group bill lines on invoices.</p> <p>This is prompted from Billing Setup. This is not a required field in RE BU setup. This can be blank in the Contracts side also.</p>

## Lease Administration Business Unit Definition - Options and Critical Dates Page

Access the Lease Administration Business Unit Definition - Options and Critical Dates page (Set Up Financials/Supply Chain, Business Unit Related, Lease Administration, LA Business Unit Definition, Options and Critical Dates)

This example illustrates the fields and controls on the Lease Administration Business Unit Definition - Options and Critical Dates page. You can find definitions for the fields and controls later on this page.

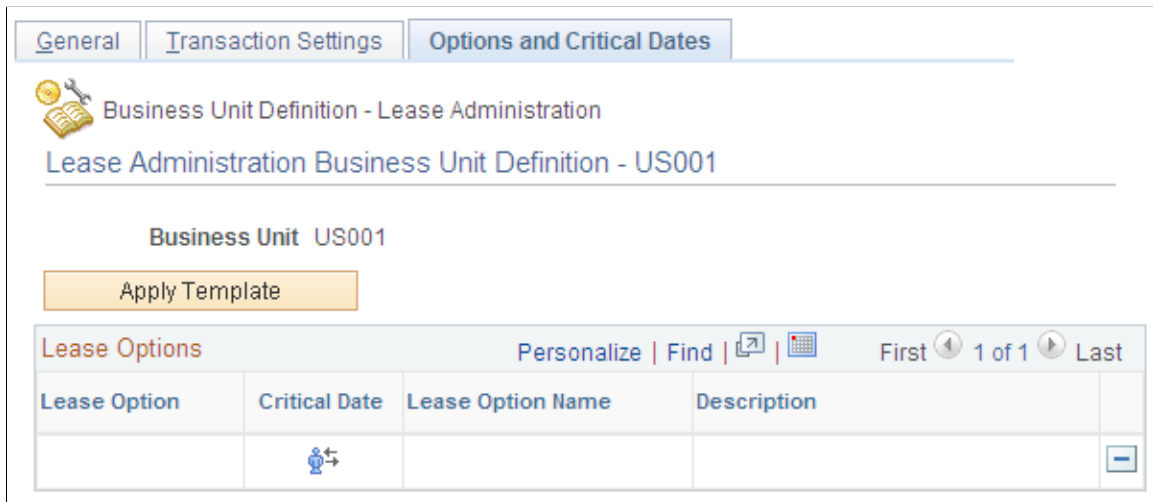

The options setup here will be defaulted onto the lease. Users can add additional lease-level critical dates to the lease that are in addition to the business unit defined defaults.

## Establishing Accounting Rules for Lease Administration

This topic discusses how to define lease administration accounting rules for lease administration.

## Page Used to Establish Accounting Rules

<b>Page Name</b>	<b>Definition Name</b>	<b>Usage</b>
<u>Accounting Rules for Lease Administration Page</u>	CA_ACCT_RULES	Define accounting rules for transaction destinations and transaction groups for lease transactions.

## Accounting Rules for Lease Administration Page

Use the Accounting Rules for Lease Administration page (CA\_ACCT\_RULES) to define accounting rules for transaction destinations and transaction groups for lease transactions.

Navigation:

Set Up Financials/Supply Chain, Product Related, Lease Administration, LA Accounting Rules

**Note:** When you add a new accounting rule for a lease administration business unit, you should use the same general ledger business unit that you selected on the Lease Administration Business Unit Definition - General page in the **General Ledger** field for that lease administration business unit.

This example illustrates the fields and controls on the Accounting Rules for Lease Administration page (partial). You can find definitions for the fields and controls later on this page.

Accounting Rules for Lease Administration

LA Business Unit US001  
GL Business Unit US001

Description: Operating Expenses Default  
\*Status: Active

Transaction Destination: 1 AP  
Transaction Routing Code: %

Transaction Group: 4 Op Ex

Copy Accounting Entries To...

Seq Nbr	Debit/Credit	*Account Type	*Account	Alternate Account	Operating Unit	Fund Code	Department	Program Code	Class Field	Budget Reference	Product
1	Debit	Expense	641500		%	%	%	%	%	%	%

The Credit side of the entry will be created by AP

When you define the lease administration accounting rules, you must keep in mind that the lease administration business unit can only be mapped to a single general ledger business unit. PeopleSoft Lease Administration does not support interunit accounting, therefore, only the accounting rules defined for the lease administration business unit and general ledger business unit combination can be used to generate accounting entries. For example, the lease administration business unit of *US001* mapped to general ledger business unit *US001* uses only those accounting rules that are defined by this business unit combination. Accounting rules defined for any other business unit combination cannot be used for processing.

<b>Field or Control</b>	<b>Description</b>
<b>Transaction Destination</b>	<p>Enter the destination where the transaction is sent. The value that you enter determines the accounting rules for an expense or revenue transaction. Values are:</p> <p><i>AP</i> (PeopleSoft Payables): If the transaction destination is <i>AP</i>, then PeopleSoft Payables uses the accounting rule that you define. When the transaction goes to PeopleSoft Payables, the accounting rule specifies the expense debit side of the accounting entry.</p> <p><i>BI</i> (PeopleSoft Billing): If the transaction destination is <i>BI</i>, then PeopleSoft Billing uses the accounting rule that you define. When the transaction goes to PeopleSoft Billing, the accounting rule specifies the revenue credit side of the accounting entry that the transaction needs to offset the PeopleSoft Receivables side of the entry that they create.</p> <p><i>GL</i> (PeopleSoft General Ledger): If the transaction destination is <i>GL</i>, then PeopleSoft General Ledger uses the accounting rule that you define. When the transaction goes to PeopleSoft General Ledger, the accounting rule specifies the expense debit side of the accounting entry.</p>
<b>Transaction Group</b>	Select the transaction group to define the type of transactions being sent to create the proper journal entries. Possible values for this field are <i>Base Rent</i> , <i>Security Deposit</i> , <i>Straightline Accounting</i> , <i>Operating Expense</i> , <i>Miscellaneous Expense</i> , <i>Manual Fee</i> and <i>Percent Rent</i> .
<b>Transaction Routing Code</b>	Select the transaction routing code. You can define unique accounting rules by specifying the transaction routing code for a specific transaction group.
<b>Copy Account Entries To</b>	Click to copy accounting rules to create a new accounting rule.

## Accounting Entries

Use the fields in this group box to define your accounting entries for your lease transactions. By using the % (wildcard), the system accepts the default entries for that field.

<b>Field or Control</b>	<b>Description</b>
<b>Debit/Credit</b>	Displays whether the accounting entry is a debit or credit. This field corresponds with the value that you selected in the <b>Account Type</b> field.
<b>Account Type</b>	Select the account type for this accounting entry.
<b>Account</b>	Enter the account number for the account type.



# Securing Your PeopleSoft Lease Administration System

---

## Understanding PeopleSoft Lease Administration Security

PeopleSoft applications use the capabilities and flexibility of multilevel security to provide a solution to security issues. PeopleSoft Lease Administration provides security at the row level, lease approval, and roles and permission lists.

Security rules enable you to establish which security events can be performed on transactions independent of any specific user until such time as you apply the rules to a user or users. For example, you can create one security rule to enable access to payables or receivables leases, lease entry, amendments, and inquiry. You can create a different security rule that enables only lease entry and maintenance for a particular user (lease entry clerk). After you define your security rules, you can assign these rules to a specific user ID or all the users and roles assigned to a permission list.

---

**Note:** The content of this section is only a part of what you need to know to secure your system. Other relevant information is located in the *PeopleSoft Application Fundamentals* documentation.

---

## Setting Up Basic Security

PeopleSoft applications provide basic access and data security. Access to PeopleSoft applications is implemented through the use of user IDs, roles, and permission lists. Data security is implemented through SetIDs. To learn more about access and data security, refer to the relevant section in the *PeopleSoft Application Fundamentals* documentation.

In addition to the basic security infrastructure, the PeopleSoft Lease Administration product provides a number of extra security features that enable you to limit certain activities to specific job roles. PeopleSoft Lease Administration provides two features to help you manage roles and responsibilities: role types and lease administration roles.

### Role Types

Role types enable you to define any number of job roles. These job roles are categorized as either internal or external roles:

- An internal role is assigned to users who can sign in to the application enter and update lease information.
- An external role is assigned to users who perform a task within the lease administration process.

These users do not have sign-in access. An external role can be a service employee, supplier, tenant, and so on.

The four role type categories are:

- *Internal Administrator*: A person who performs day-to-day operational activities associated with adding, updating, and maintaining lease information.
- *Internal Manager*: A person who performs day-to-day operational activities, in addition to general operational duties, and might be required to approve certain activities such as activating a lease or approving a transaction.
- *External Contact*: A person, such as a service employee, whom you want to track as a contact.
- *Principal Contact*: A person or organization that is associated with a lease.

When you define a new role type, you can use any name for that role type. However, you must assign a category to that role type. For example, the person who performs lease maintenance in your organization in one region might be known as a lease administrator while another region might refer to this job role as a contract manager. You can define both role types and designate them as internal administrators.

## Lease Administration Roles

Lease administration roles associate application users defined by the base PeopleSoft security architecture with specific lease administration job roles. After you define your lease administration roles, you can modify the PeopleSoft Lease Administration application to limit certain activities based on the role type category of the user who is signed on.

## Automated Workflow Engine Roles

With release 9.1 the users can also define their own roles and define workflows based on the Approval Workflow Engine. The users need to change the Approval definitions provided to add their own roles based on their business process. These are the list of features supported by AWE:

- Lease state changes
- Sales amount monitoring
- Operating expense monitoring
- Transaction Queue monitoring
- Clause monitoring
- Critical date monitoring
- Site acquisition request approvals
- Site acquisition finalization

PeopleSoft Lease Administration delivers the following predefined roles and associated members for the Automated Workflow Engine process:

<b>Role</b>	<b>Default Member</b>
RE_APPROVER - This role is provided for the Lease Management Review and Approval Process.	SVP1
SITE_ADMIN - This role is provided for Site Acquisition approvers.	SVP1
SAR_FINALIST - This role is provided for Site Acquisition finalists.	CUST

## Automated Workflow Engine Process Definitions

PeopleSoft Lease Administration delivers the following predefined process definitions for the Automated Workflow Engine process:

<b>Process Name</b>	<b>Process Definition</b>	<b>Roles</b>	<b>Default User</b>	<b>Event</b>
Lease state changes	RE_LEASE_TRANS	RE_APPROVER	SVP1	Route for Review
Sales amount monitoring	RE_SALES_REPORT	RE_APPROVER	SVP1	Route for Approval
Audit expense monitoring	RE_AUDIT_OPEX	RE_APPROVER	SVP1	Route for Approval
Transaction queue monitoring	RE_TRAN_QUEUE	RE_APPROVER	SVP1	Route for Review
Lease clause monitoring	RE_CLAUSE_COMP	RE_APPROVER	SVP1	Route for Review
Critical date monitoring	RE_CRDT_NOTIFY	RE_APPROVER	SVP1	Route for Review
SAR approval	RE_SAR_DETAIL	SITE_ADMIN	SVP1	Route for Approval
Finalist sites	RE_SAR_FINALIZE	SAR_FINALIST	CUST	Route for Approval

## Setting Up Roles and Permission Lists

PeopleSoft applications enable you to control user access on a feature-by-feature basis, using the roles and permission lists. This list shows the basic structure of access security:

- System users can be assigned one or more roles.
- A role can be allocated to one or more permission lists.
- A permission list identifies the features accessible to the role.

---

**Note:** A more detailed explanation of roles and permission lists can be found in the *PeopleSoft Application Fundamentals* documentation.

---

PeopleSoft Lease Administration delivers the following predefined roles:

- RE\_ADMIN - Real Estate Administrator

This role enables users to perform the general day-to-day operations involved in creating, updating, and administering leases. This also includes the management and processing of all lease-based financial transactions.

- RE\_SUPER - Real Estate Super User

This role is designed to be used by a super user for setting up and configuring the PeopleSoft Lease Administration application. The super user also has access to all of the permissions available to the role of RE\_ADMIN.

PeopleSoft Lease Administration delivers the following predefined permission lists:

- EPRE1000 - Real Estate Configuration

Provides access to all of the Real Estate Setup components.

- EPRE2000 - Lease Administration

Provides access to all operational lease administration features.

- EPRE3000 - Real Estate Portal Administration

Provides access to administering the PeopleSoft Lease Administration portal pagelets.

- EPRE3500 - Real Estate Portal User

Provides views to the PeopleSoft Lease Administration portal pagelets.

<i>Permission List/Roles</i>	<i>RE_SUPER</i>	<i>RE_ADMIN</i>
EPRE1000 - Real Estate Configuration	Yes	No
EPRE2000 - Lease Administration	Yes	Yes



<i>Permission List/Roles</i>	<i>RE_SUPER</i>	<i>RE_ADMIN</i>
EPRE3000 - Real Estate Portal Administration	Yes	No
EPRE3500 - Real Estate Portal User	Yes	Yes

---

## Setting Up Row-Level Security

To establish security within PeopleSoft Lease Administration, you must decide which level of security to establish throughout your system, which key fields to secure, and whether security is handled through user IDs or roles. You can implement security to restrict individual users or roles to specific rows of data that are controlled by such key fields as SetIDs or business units. You can also limit users to access only a specific subset of rows.

---

## Setting Up Lease Administration Security

When a user approves the lease, the financial processing of that lease, such as billing and payments processing, begins. Consequently, you can limit the list of users who can activate a lease. These are the three key elements to setting up Lease Administration security features:

- **Role Types:** Specify the different types of job role used by your organization.

A role type represents a job role. The Lease Administration feature uses job roles to associate specific details with leases and, in some cases, determine which roles may perform certain operations.

- **Lease Administration Roles:** Specify the internal job roles you use and associate the roles with specific system users.

The lease administration role associates system users with the various job roles that are associated with adding, updating, and maintaining leases.

- **Lease Activation Policy:** Specifies how and by whom a lease can be activated.

When you create a new lease, financial processing such as billing and payments processing does not begin until the lease is activated. To protect the integrity of your financial processes, the PeopleSoft Lease Administration application enables you to prevent a lease from being activated until a manager approves it. This approval step is controlled by the automatic lease approval option on the Installation Options - Lease Administration page. When you disable the automatic lease approval option, only users who are assigned the Lease Administration role based on the Internal Manager role type category can activate a lease. If automatic lease approval is enabled, any lease administration role can activate a lease.

---

**Note:** This application is delivered with the automatic lease approval feature enabled.

---

The Automated Workflow Engine can be configured for the following:

- **Sales Amount Approval:** Using AWE, users can setup their own roles and set of users who are authorized to approve sales amounts that have surpassed the tolerance limit setup at the business unit level.
- **Operating Expense Approval:** Using AWE, users can setup their own roles and set of users who are authorized to approve operating expense amounts that have surpassed the tolerance limit setup at the business unit level.
- **TQM Monitoring:** Transaction Queue approvals can be used to notify specific user roles setup in the AWE configuration.
- **Clauses Monitoring:** Lease clauses can be monitored for compliance based on specified user roles setup in the AWE configuration.
- **Critical Dates Monitoring:** Critical date notifications can be sent to user defined roles setup in the AWE configuration.
- **SAR Approval Policy:** SAR approvers can be defined as user roles and setup in the AWE approval definitions.
- **SAR Finalization Policy:** User roles, who can finalize the SAR, can be setup in the AWE configuration.

See [Understanding Role Types](#).

See [Understanding Lease Administration Roles](#).

# Setting Up Property Site Acquisition

---

## Understanding Property Site Acquisition Setup

Supplemental data is valuable when you want to capture information about a subset of object instances with fields that are relevant only to these particular object instances. Objects include records, pages, and components, which you must configure specifically to accept supplemental data. Supplemental data may be in a field that is embedded in the page or appears on a secondary page. Oracle defines and registers both the supplemental data store records associated with a base record and the components to be used for supplemental data. Be aware that adding any additional objects is regarded as a customization and requires familiarity with PeopleTools.

When you set up supplemental data, you define records and fields and map them to a data storage record. These definitions are not stored in the PeopleTools metadata tables but in the metadata tables for the supplemental data. You define supplemental data page elements to appear on the page in two columns. You must also group supplemental data fields within a display group for display purposes. You assign display groups to pages that are enabled for supplemental data. Once you have made this designation, you can define the conditions under which the application should use the supplemental data. You can perform a search on one display group. The pages within the Supplemental Data component enable you to accomplish these tasks.

### Considerations and Limitations

The decision to add supplemental data to your application should be based on how applicable the data objects are to instances of the object. If the data objects apply to a significant number of instances of the object, then it may want to add a field to the table using Application Designer instead of using attributes to capture the data. If the data elements apply to a much smaller percentage of the objects, then attributes may be the solution. While supplemental data provides a large amount of flexibility in terms of adding data elements without changing the underlying data model, you should consider the following limitations when you are evaluating whether to implement supplemental data:

- Supplemental data does not fall under the normal upgrade capabilities that are provided with PeopleTools.

Because supplemental data records are not a type of PeopleTools object, you cannot use the standard upgrade facilities that are provided by PeopleTools, such as the Upgrade Copy or Upgrade Compare process, to upgrade supplemental data from one database to another. The mechanism for migrating supplemental data is to extract the data from the source database and move the data to the target database, which you can accomplish, for example, by using Data Mover or a similar tool. Oracle does not deliver any utilities, such as data mover scripts, for migrating sample supplemental data.

- Because supplemental data records are stored in separate tables (distinct from the base table), incorporating supplemental information into reports may be difficult.
- Supplemental data can be displayed only in a two-column format.
- Performance issues can occur if you have too many supplemental data records in the system.

Use supplemental data only if the data elements are truly dynamic in nature or if they apply to certain instances of an object. Never use supplemental data simply because creating it is easier than using standard PeopleTools fields.

## Setting Up Site Types

Site types are effective-dated and SetID-driven. You can define as many types as your business needs.

This topic discusses how to set up site types.

### Page Used to Set Up Site Types

<i>Page Name</i>	<i>Definition Name</i>	<i>Usage</i>
<a href="#">Site Type Page</a>	RE_SITE_TYPE	Set up site types for use when defining sites.

### Site Type Page

Use the Site Type page (RE\_SITE\_TYPE) to set up site types for use when defining sites.

Navigation:

**Set Up Financials/Supply Chain > Product Related > Lease Administration > Site Acquisition > LA Property Site Type**

This example illustrates the fields and controls on the Site Type page. You can find definitions for the fields and controls later on this page.

The screenshot shows the 'Site Type' page in PeopleTools. At the top, there is a breadcrumb trail: 'Product Related Setup - Site Acquisition' followed by 'Site Type'. Below this, there is a table with columns for 'SetID' and 'Site Type'. The table contains one record with SetID 'SHARE' and Site Type 'COR'. Below the table, there is a 'Details' section for the selected record. It includes the following fields and controls:

- \*Effective Date: 01/01/2000 (with a calendar icon)
- \*Status: Active (with a dropdown arrow and +/- buttons)
- Site Type Name: Corporate (text input field)
- Description: Corporate Site (text input field)

Enter a site type and description for use when defining sites and site acquisition requests.

## Setting Up Attributes

You must set up site types before you can define site attributes.

For each site type and business unit combination, users can access a setup page where they can select among the delivered site acquisition fields for inclusion in the SAR Comparison Matrix chart.

This topic discusses how to set up attributes.

### Pages Used to Set Up Attributes

<i>Page Name</i>	<i>Definition Name</i>	<i>Usage</i>
<u>Site Attributes Page</u>	RE_SITE_ATTR	Define attributes for sites and assign weightings to be used to display values on the comparison matrix.
<u>Unit of Measures Page</u>	RE_SITE_ATTR_UOM	Define the units of measures to be used when defining sites.

### Site Attributes Page

Use the Site Attributes page (RE\_SITE\_ATTR) to define attributes for sites and assign weightings to be used to display values on the comparison matrix.

Navigation:

**Set Up Financials/Supply Chain > Product Related > Lease Administration > Site Acquisition > LA Maintain Site Attributes > Site Attributes**

This example illustrates the fields and controls on the Site Attributes page (1 of 6). You can find definitions for the fields and controls later on this page.

Site Attributes
Unit of Measures

SetID SHARE
Site Type Corporate

Select All     ClearAll

General Attributes
Personalize | Find | | 
First 1-11 of 11 Last

Attributes	Compare	Weighting
ADA compliant	<input checked="" type="checkbox"/>	1.00
Description	<input checked="" type="checkbox"/>	1.00
Manager Rating	<input checked="" type="checkbox"/>	1.50
Occupant Name	<input checked="" type="checkbox"/>	1.00
Offered By	<input checked="" type="checkbox"/>	1.00
Ownership Type	<input checked="" type="checkbox"/>	1.00
Landlord/Tenant	<input checked="" type="checkbox"/>	1.00
Property Manager	<input checked="" type="checkbox"/>	1.00
Property Owner	<input checked="" type="checkbox"/>	1.00
Primary Use	<input checked="" type="checkbox"/>	1.00
Site Name	<input checked="" type="checkbox"/>	1.00





This example illustrates the fields and controls on the Site Attributes page (2 of 6). You can find definitions for the fields and controls later on this page.

Select All     ClearAll





Location Attributes
Personalize | Find | | 
First 1-21 of 21 Last

Attributes	Compare	Weighting
Address Line 1	<input checked="" type="checkbox"/>	1.00
Adjacent Uses	<input checked="" type="checkbox"/>	1.00
Anchor 100 Feet	<input checked="" type="checkbox"/>	1.25
Anchor 250 Feet	<input checked="" type="checkbox"/>	1.10
Anchor 500 Feet	<input checked="" type="checkbox"/>	1.00
City	<input checked="" type="checkbox"/>	1.00
Country	<input checked="" type="checkbox"/>	1.00
County	<input checked="" type="checkbox"/>	1.00
Nearest Company Office	<input checked="" type="checkbox"/>	1.00
Nearest Competitor	<input checked="" type="checkbox"/>	1.40
Latitude	<input checked="" type="checkbox"/>	1.00
Location Rating	<input checked="" type="checkbox"/>	2.00
Location Type	<input checked="" type="checkbox"/>	0.75
Neighborhood Quality	<input checked="" type="checkbox"/>	1.20
Visibility	<input checked="" type="checkbox"/>	1.10

This example illustrates the fields and controls on the Site Attributes page (3 of 6). You can find definitions for the fields and controls later on this page.

Maintenance Attributes		
		Personalize   Find    
		First  1-12 of 12  Last
Attributes	Compare	Weighting
Construction Type	<input checked="" type="checkbox"/>	<input type="text" value="1.20"/>
Construction Year	<input checked="" type="checkbox"/>	<input type="text" value="1.50"/>
HVAC Condition	<input checked="" type="checkbox"/>	<input type="text" value="1.20"/>
Operating Days	<input checked="" type="checkbox"/>	<input type="text" value="1.00"/>
Operating Hours	<input checked="" type="checkbox"/>	<input type="text" value="1.00"/>
Property Age	<input checked="" type="checkbox"/>	<input type="text" value="2.00"/>
Property Condition	<input checked="" type="checkbox"/>	<input type="text" value="1.00"/>
Renovation Year	<input checked="" type="checkbox"/>	<input type="text" value="1.00"/>
Risk Category	<input checked="" type="checkbox"/>	<input type="text" value="1.00"/>
Site Access	<input checked="" type="checkbox"/>	<input type="text" value="1.00"/>
Utilities Condition	<input checked="" type="checkbox"/>	<input type="text" value="1.00"/>
Wire Condition	<input checked="" type="checkbox"/>	<input type="text" value="2.00"/>

This example illustrates the fields and controls on the Site Attributes page (4 of 6). You can find definitions for the fields and controls later on this page.

Physical Attributes		
		Personalize   Find    
		First  1-12 of 12  Last
Attributes	Compare	Weighting
Ceiling Height	<input checked="" type="checkbox"/>	<input type="text" value="0.75"/>
No. of Elevators	<input checked="" type="checkbox"/>	<input type="text" value="1.00"/>
Floor Levels	<input checked="" type="checkbox"/>	<input type="text" value="1.00"/>
No. of Floors	<input checked="" type="checkbox"/>	<input type="text" value="1.00"/>
Maximum Occupancy	<input checked="" type="checkbox"/>	<input type="text" value="1.00"/>
No. of Parking Spaces	<input checked="" type="checkbox"/>	<input type="text" value="1.00"/>
Plot Size	<input checked="" type="checkbox"/>	<input type="text" value="1.00"/>
Property Rentable Area	<input checked="" type="checkbox"/>	<input type="text" value="1.00"/>
Property Usable Area	<input checked="" type="checkbox"/>	<input type="text" value="1.00"/>
Space Divisible	<input checked="" type="checkbox"/>	<input type="text" value="1.00"/>
No. of Stairs	<input checked="" type="checkbox"/>	<input type="text" value="1.00"/>
Total Area	<input checked="" type="checkbox"/>	<input type="text" value="1.00"/>

This example illustrates the fields and controls on the Site Attributes page (5 of 6). You can find definitions for the fields and controls later on this page.

Schedule Attributes		Personalize	Find	First	1-16 of 16	Last
Attributes	Compare	Weighting				
Allowance Due Date	<input checked="" type="checkbox"/>	<input type="text" value="1.00"/>				
Allowance Received Date	<input checked="" type="checkbox"/>	<input type="text" value="1.00"/>				
Audit Report Date	<input checked="" type="checkbox"/>	<input type="text" value="1.00"/>				
Availability Date	<input checked="" type="checkbox"/>	<input type="text" value="1.00"/>				
Construction Approval Date	<input checked="" type="checkbox"/>	<input type="text" value="1.00"/>				
Construction Date	<input checked="" type="checkbox"/>	<input type="text" value="1.00"/>				
Follow-up Date	<input checked="" type="checkbox"/>	<input type="text" value="1.00"/>				
Lease End Date	<input checked="" type="checkbox"/>	<input type="text" value="1.00"/>				
Lease Start Date	<input checked="" type="checkbox"/>	<input type="text" value="1.00"/>				
Lease Term (Periods)	<input checked="" type="checkbox"/>	<input type="text" value="1.00"/>				
Month to Month Lease	<input checked="" type="checkbox"/>	<input type="text" value="1.00"/>				
Occupancy Date	<input checked="" type="checkbox"/>	<input type="text" value="1.00"/>				
Date Opened	<input checked="" type="checkbox"/>	<input type="text" value="1.00"/>				
Option to Renew	<input checked="" type="checkbox"/>	<input type="text" value="1.00"/>				
Signed Date	<input checked="" type="checkbox"/>	<input type="text" value="1.00"/>				

This example illustrates the fields and controls on the Site Attributes page (6 of 6). You can find definitions for the fields and controls later on this page.

Value Attributes		Personalize	Find	First	1-19 of 19	Last
Attributes	Compare	Weighting				
Admin Fee Percentage	<input checked="" type="checkbox"/>	<input type="text" value="1.00"/>				
Annual Operating Expenses	<input checked="" type="checkbox"/>	<input type="text" value="1.00"/>				
Appraised Value	<input checked="" type="checkbox"/>	<input type="text" value="1.00"/>				
Closing Costs	<input checked="" type="checkbox"/>	<input type="text" value="1.00"/>				
Commission %	<input checked="" type="checkbox"/>	<input type="text" value="1.00"/>				
Construction Cost	<input checked="" type="checkbox"/>	<input type="text" value="1.00"/>				
Current Selling Price	<input checked="" type="checkbox"/>	<input type="text" value="1.00"/>				
Deposit Amount	<input checked="" type="checkbox"/>	<input type="text" value="1.00"/>				
Estimated Annual Insurance	<input checked="" type="checkbox"/>	<input type="text" value="1.00"/>				
Estimated Annual Maintenance	<input checked="" type="checkbox"/>	<input type="text" value="1.00"/>				
Estimated Annual Utilities	<input checked="" type="checkbox"/>	<input type="text" value="1.00"/>				
Estimated Annual Sales	<input checked="" type="checkbox"/>	<input type="text" value="1.00"/>				
Original Selling Price	<input checked="" type="checkbox"/>	<input type="text" value="1.00"/>				
Remodel Costs	<input checked="" type="checkbox"/>	<input type="text" value="1.00"/>				
Rent Amount	<input checked="" type="checkbox"/>	<input type="text" value="1.00"/>				

By default, all fields are selected. When selected, the weighting field enables users to assign a numerical value, which will be used in the calculations for the total weighted score of each site.



The page is broken into grids that match the Site Repository pages and the SAR Comparison Matrix grids. The page contains a status field and has three fields per row:

<b>Field or Control</b>	<b>Description</b>
<b>Attribute</b>	The particular field attribute (location type, manager rating, and so on)
<b>Compare</b>	Select to include this attribute on the Comparison Matrix
<b>Weighting</b>	Entering a weighting is required if you select the <b>Compare</b> check box. The weightings defined here will be entered by default in the grids on the SAR Comparison Matrix page, based on business unit and site type.

The general attributes are listed here:

- Manager Rating
- Occupant Name
- Landlord/Tenant
- Name
- Description
- Property Owner
- Property Manager
- Ownership Type
- Priority Use
- Offered By
- ADA Compliant

The location attributes are listed here:

- Location Rating
- Visibility
- Neighborhood Quality
- Adjacent Uses
- Address Line 1
- Latitude
- Longitude

- Region Code
- County
- Country
- Postal Code
- Tax Authority
- Tax Group
- Parcel Number
- Location Type
- Anchor 100 Feet
- Anchor 250 Feet
- Anchor 500 Feet
- Nearest Company Office
- Nearest Competitor
- City

The maintenance attributes are listed here:

- Property Age
- Property Condition
- Risk Category
- Site Access
- Construction Type
- Construction Year
- Operating Days
- Operating Hours
- HVAC Condition
- Utilities Condition
- Wire Condition
- Renovation Year

The physical attributes are listed here:

- Maximum Occupancy

- No. of Stairs
- No. of Elevators
- Floor Levels
- No. of Floors
- Plot Size
- Ceiling Height
- Total Area
- Property Rentable Area
- Property Usable Area
- No. of Parking Spaces
- Space Divisible

The schedule attributes are listed here:

- Availability Date
- Signed Date
- Lease Start Date
- Lease End Date
- Lease Term (Periods)
- Occupancy Date
- Date Opened
- Audit Report Date
- Option to Renew
- Surrender Date
- Construction Date
- Follow-up Date
- Allowance Due Date
- Allowance Received Date
- Construction Approval Date
- Month to Month Lease

The value attributes are listed here:

- Construction Cost
- Current Selling Price
- Closing Costs
- Remodel Costs
- Original Selling Price
- Unit Price
- Rent Amount
- Annual Operating Expenses
- Deposit Amount
- Estimated Annual Sales
- Tax Amount
- Estimated Annual Utilities
- Estimated Annual Maintenance
- Estimated Annual Insurance
- Tenant Allowance
- Commission %
- Sale Price (Clean)
- Appraised Value
- Admin Fee Percentage

## Unit of Measures Page

Use the Unit of Measures page (RE\_SITE\_ATTR\_UOM) to define the units of measures to be used when defining sites.

Navigation:

**Set Up Financials/Supply Chain > Product Related > Lease Administration > Site Acquisition > LA Maintain Site Attributes > Unit of Measures**

This example illustrates the fields and controls on the Unit of Measures page. You can find definitions for the fields and controls later on this page.

Site Attributes
Unit of Measures

SetID SHARE
Site Type Corporate

**GroupBox Label**

\*Space Unit of Measure  Square Feet

Supplemental Data Weighting

Currency

Length Units

Height Units

Width Units

\*Distance Type

<i>Field or Control</i>	<i>Description</i>
<b>Space Unit Of Measure</b>	The UOMs set here will be entered on the site page based on the business unit and site type. Select a unit of measure from the list of options available.
<b>Length Units</b>	Enter the number of units in length.
<b>Height Units</b>	Enter the number of units in height.
<b>Width Units</b>	Enter the number of units in width.
<b>Distance Type</b>	Select a distance type: <ul style="list-style-type: none"> <li>• <i>Kilometers</i></li> <li>• <i>Meters</i></li> <li>• <i>Miles</i></li> </ul>

## Setting Up Supplemental Data

To set up supplemental data, use the following components:

- Register Record (FS\_SD\_REG\_REC).
- Register Component (FS\_SD\_REG\_COMP).

Copyright © 1988, 2024, Oracle and/or its affiliates.

85

- Define Record (FS\_SD\_RECDEFN).
- Define Display Group (FS\_SD\_GRPDEFN).
- Assign Display Group (FS\_SD\_PAGE\_GRP).

This topic discusses how to set up supplement data.

## Pages Used to Set Up Supplemental Data

<i>Page Name</i>	<i>Definition Name</i>	<i>Usage</i>
<u>Register Record Page</u>	SD_REG_REC	Register the supplemental database record and optionally register the record that saves the search criteria for the base record.
<u>Register Component Page</u>	SD_REG_COMP	Register and enable the component and the pages for supplemental data.
<u>Record Page</u>	SD_RECDEFN	Define the supplemental data record to associate with the base record and identify where to store this record.
<u>Fields Summary Page</u>	SD_RECFLD	Map fields to the data storage fields.
<u>Fields Detail Page</u>	SD_RECFLD_DTL	Define detail information for a field.
<u>Define Display Group Page</u>	SD_GRPDEFN	Define a display group and associate any records and fields, as well as identify the order in which the fields appear on the page.
<u>Assign Display Group Page</u>	SD_PAGE_GRP	Assign one or more display groups to a supplemental data-enabled component and page.

## Register Record Page

Use the Register Record page (SD\_REG\_REC) to register the supplemental database record and optionally register the record that saves the search criteria for the base record.

Navigation:

**Set Up Financials/Supply Chain > Product Related > Lease Administration > Site Acquisition > Site Supplemental Data > MM Register Record**

This example illustrates the fields and controls on the Register Records page. You can find definitions for the fields and controls later on this page.

### Register Record

---

Base Record RE\_SITE

Saved Search Record

**Data Store Records** Personalize | Find | View All | |

First 1 of 1 Last

	*Data Store Record	Saved Search Record	
1	<input type="text" value="RE_SITE_SD"/>	<input style="width: 100%;" type="text"/>	

Recycle Cache

<i><b>Field or Control</b></i>	<i><b>Description</b></i>
<b>Base Record</b>	Select a base record on the Define Record page to associate with this supplemental data record.
<b>Data Store Record</b>	Select one of the data store records that you previously registered that you want to use to store this supplemental data record.

## Register Component Page

Use the Register Component page (SD\_REG\_COMP) to register and enable the component and the pages for supplemental data.

Navigation:

**Set Up Financials/Supply Chain > Product Related > Lease Administration > Site Acquisition > Site Supplemental Data > LA Register Component**

This example illustrates the fields and controls on the Register Component page. You can find definitions for the fields and controls later on this page.

You can enter components on this page.

## Record Page

Use the Record page (SD\_RECDEFN) to define the supplemental data record to associate with the base record and identify where to store this record.

Navigation:

**Set Up Financials/Supply Chain > Product Related > Lease Administration > Site Acquisition > Site Supplemental Data > Define Supplemental Data LA > Record**

This example illustrates the fields and controls on the Record page. You can find definitions for the fields and controls later on this page.

<b>Field or Control</b>	<b>Description</b>
<b>Status</b>	Select either <i>In Design</i> or <i>Activated</i> .



<b>Field or Control</b>	<b>Description</b>
<b>Data Store Record</b>	Select one of the data store records that you previously registered that you want to use to store this supplemental data record.

## Fields Summary Page

Use the Fields Summary page (SD\_RECFLD) to map fields to the data storage fields.

Navigation:

**Set Up Financials/Supply Chain > Product Related > Lease Administration > Site Acquisition > Site Supplemental Data > Define Supplemental Data LA > Fields Summary**

This example illustrates the fields and controls on the Fields Summary page. You can find definitions for the fields and controls later on this page.

Record RES		Status Activated				
Fields	Personalize	Find	View All	First	1-2 of 2	Last
Field Name	Use Type	Length	Mapped to	Field Status		
1 AIRPORT_DISTANCE	Number	7.2	SD_NUM9_1	Activated		
2 SCHOOL_DISTANCE	Number	7.2	SD_NUM9_2	Activated		

Values must be entered on the Fields Detail page before you can map the field to a value.

## Fields Detail Page

Use the Fields Detail page (SD\_RECFLD\_DTL) to define detail information for a field.

Navigation:

**Set Up Financials/Supply Chain > Product Related > Lease Administration > Site Acquisition > Site Supplemental Data > Define Supplemental Data LA > Fields Detail**

This example illustrates the fields and controls on the Fields Detail page. You can find definitions for the fields and controls later on this page.

The screenshot shows the 'Fields Detail' page for a record with ID 'RES' and status 'Activated'. The main section, titled 'Field Details', contains the following information:

- Field Name:** AIRPORT\_DISTANCE
- Field Status:** Activated
- Description:** Airport Distance
- \*Field Label:** Airport Distance (with a 'Required' checkbox checked)
- Long Label:** (empty text box)
- Use Type:** Number
- Field Length:** 7.2
- Mapped to:** SD\_NUM9\_1
- Uppercase:** (checkbox unchecked)

Below this is a 'Prompt Control' section with a table for defining prompts:

*Record Name	*Field Name		
1			

<b>Field or Control</b>	<b>Description</b>
<b>Field Name</b>	Enter a name for the supplemental data field and a description of the field.
<b>Field Label</b>	Enter the a label to display on the page for this field.
<b>Use Type</b>	<p>Values selected here affect the display of columns on the Fields Summary page and values displayed on this page. Values are:</p> <ul style="list-style-type: none"> <li>• <i>Code</i></li> <li>• <i>Date</i></li> <li>• <i>Number</i></li> <li>• <i>Signed</i></li> <li>• <i>Text</i></li> <li>• <i>Time</i></li> <li>• <i>Y/N</i></li> </ul>

<b>Field or Control</b>	<b>Description</b>
<b>Field Length</b>	Depending on what value you select as a use type, this field becomes editable or is populated with predefined values.  If you select the <i>Number</i> or <i>Signed</i> use type, select either <i>15.4</i> , <i>7.2</i> , or <i>9</i> .  If you select the <i>Text</i> use type, select <i>20</i> , <i>4</i> , or <i>50</i> .
<b>Mapped To:</b>	Select the data store field to which you want to map this field.

## Codes

If you select the use type of Code, the **Codes** group box appears.

<b>Field or Control</b>	<b>Description</b>
<b>Sequence</b>	Enter a number to represent the order in which you want to see these codes listed in a drop-down list box or lookup page.
<b>Field Value</b>	Enter each valid code in this list.
<b>Translate Long Name</b>	Enter the text that you want to appear on the list when the drop-down list box appears.

## Define Display Group Page

Use the Define Display Group page (SD\_GRPDEFN) to define a display group and associate any records and fields, as well as identify the order in which the fields appear on the page.

Navigation:

**Set Up Financials/Supply Chain > Product Related > Lease Administration > Site Acquisition > Site Supplemental Data > LA Define Display Group**

This example illustrates the fields and controls on the Define Display Group page. You can find definitions for the fields and controls later on this page.

### Define Display Group

---

Display Group **RESIDENTIAL** Base Record **RE\_SITE**

Description

Label  \*Occurs

Left Column		Personalize   Find   View All   <span style="float: right;">First 1 of 1 Last</span>	
*Sequence	*Record	*Field Name	Label
1	RES	AIRPORT_DISTANCE	Airport Distance <span style="float: right;">+ -</span>

Right Column		Personalize   Find   View All   <span style="float: right;">First 1 of 1 Last</span>	
*Sequence	*Record	*Field Name	Label
1	RES	SCHOOL_DISTANCE	School Distance <span style="float: right;">+ -</span>

Recycle Cache

<i><b>Field or Control</b></i>	<i><b>Description</b></i>
<b>Label</b>	Enter a label for the <b>display group data</b> group box.
<b>Occurs</b>	Enter the number of rows of data to display in the group box.
<b>Sequence</b>	Enter a sequence number to determine the order in which the fields appear on the page for each column.
<b>Field Name</b>	Don't forget to provide a definition.
<b>Label</b>	Enter a label that you want to appear on the page for the field name for each supplemental data field.

## Assign Display Group Page

Use the Assign Display Group page (SD\_PAGE\_GRP) to assign one or more display groups to a supplemental data-enabled component and page.

Navigation:

**Set Up Financials/Supply Chain > Product Related > Lease Administration > Site Acquisition > Site Supplemental Data > LA Assign Display Group**

This example illustrates the fields and controls on the Assign Display Group page. You can find definitions for the fields and controls later on this page.

### Assign Display Group

Component Name RE\_SITE
Market Global

Enabled Pages Find | View All | First 1 of 1 Last

Page Name RE\_SITE\_SUPPLEMENT
Base Record RE\_SITE

Display Groups Personalize | Find | View All | First 1 of 1 Last

*Sequence	*Display Group	*Use	User-friendly Text	Edit	Clear
1	RESIDENTIAL	Editable		✎	✎

Reorder

Recycle Cache

<b>Field or Control</b>	<b>Description</b>
<b>Sequence</b>	Enter the sequence you want the group to display.
<b>Display Group</b>	Add a supplemental data display group that you want to associate with this component and this page.
<b>Edit</b>	Select whether you want the text associated with the display group to be <i>Editable</i> or <i>Read-only</i> .

## Creating Sites

This topic discusses how to create sites.

### Pages Used to Create Sites

<b>Page Name</b>	<b>Definition Name</b>	<b>Usage</b>
<u>General Information Page</u>	RE_SITE_GENERAL	Enter general information about the site.
<u>Location Page</u>	RE_SITE_LOCATION	Enter location information for this site. You must enter a value for the longitude and latitude fields to view the map on the Site Map page.
<u>Operation/Maintenance Page</u>	RE_SITE_OPERATION	Enter operation and maintenance information about this site.
<u>Physical Attributes Page</u>	RE_SITE_ATTRIBUTES	Enter physical attributes, such as size.

<b>Page Name</b>	<b>Definition Name</b>	<b>Usage</b>
<u>Schedule Page</u>	RE_SITE_SCHEDULE	Enter information such as site schedules or construction schedules.
<u>Value Page</u>	RE_SITE_VALUE	Enter value information for the site.
<u>Supplemental Data Page</u>	RE_SITE_SUPPLEMENT	Enter additional site data.
Notes	RE_SITE_NOTE	Enter notes about the site.
<u>Contacts Page</u>	RE_SITE_CONTACT	Select contacts from suppliers, customers, or the address book. You can add supplemental contacts on this page.
<u>Search for Contacts Page</u>	RE_CNTCT_SRCH	Search for or add contacts.
<u>Site Map Page</u>	RE_SITE_MAP	View the site map.

## General Information Page

Use the General Information page (RE\_SITE\_GENERAL) to enter general information about the site.

Navigation:

**Lease Administration > Site Acquisition > Site Repository > Create Site > General Information**

This example illustrates the fields and controls on the General Information page. You can find definitions for the fields and controls later on this page.

<b>Field or Control</b>	<b>Description</b>
<b>Action</b>	<p>The values available in the drop-down list box depend upon the status of the site and your authorization level. Select:</p> <ul style="list-style-type: none"> <li>• <i>Validate Site</i>: Select to have the system validate that all the required fields are populated.</li> <li>• <i>Activate Site</i>: Select to have the system run the Activation process. This process sets the Site status to <i>Open</i>. Other than the Contacts and Notes pages, the fields on the other pages are now read-only.</li> <li>• <i>Archive Site</i>: Select to archive the site when the asset is archived during the Asset Management Archive process.</li> <li>• <i>Dispose Site</i>: Select to dispose of the site.</li> </ul>

<b>Field or Control</b>	<b>Description</b>
<b>Site Status</b>	<p>Displays the status of the site. Values are:</p> <ul style="list-style-type: none"> <li>• <i>New</i>: A pending site that has not been activated by a user with appropriate access. Sites with this status cannot be selected for use in a SAR.</li> <li>• <i>Open</i>: An active site that has not been acquired. Sites with this status can be used in any combination of SARs.</li> <li>• <i>Evaluating</i>: The status changes to this status after it is added to any SAR for evaluation. Sites with this status can be added to additional SARs.</li> <li>• <i>Negotiating</i>: The status changes to this status after the site is selected as a SAR finalist and the SAR is submitted or approved. Sites with this status can be added to additional SARs.</li> <li>• <i>Operating</i>: The status changes to this status after it is selected as the final site to be acquired and the SAR is finalized (closed). Sites with this status cannot be selected for any future SARs. Existing SARs that have this site selected for evaluation will no longer allow the site to be selected as a finalist. You create assets, leases, or projects at this point.</li> <li>• <i>Disposing</i>: The status changes to this status when the lease has expired. (If the lease is renewed, put into holdover, and so on, then the site status changes to <i>Operating</i>.) Sites with this status can be added again to SARs.</li> <li>• <i>Archive</i>: The site changes to this status when the lease is closed or the asset is archived. Sites with this status can be added to SARs. Sites with this status can never can go back to <i>Open</i> to illustrate that it was previously owned or leased by the organization.</li> </ul>
<b>Site Type</b>	<p>Displays the site type selected on the Add a New Value page. The value selected here determines the supplemental data fields that will appear.</p>
<b>Name</b>	<p>Enter the name of this site. This field is required.</p>
<b>Offered By</b>	<p>Enter the name of the entity offering this site for sale or lease.</p>
<b>Ownership Type</b>	<p>Select how this property is being offered:</p> <ul style="list-style-type: none"> <li>• <i>Leased</i></li> <li>• <i>Owned</i></li> </ul>
<b>Landlord/Tenant</b>	<p>Enter the name of the current landlord or tenant of this site.</p>



<b>Field or Control</b>	<b>Description</b>
<b>Occupant Name</b>	Enter the name of the current tenant.
<b>Primary Use</b>	Select a primary use for this site: <ul style="list-style-type: none"> <li>• <i>Apartment</i></li> <li>• <i>Commercial</i></li> <li>• <i>Individual</i></li> <li>• <i>Mixed Use</i></li> <li>• <i>Other</i></li> <li>• <i>Residential</i></li> <li>• <i>Retail</i></li> <li>• <i>Serviced Apartments</i></li> <li>• <i>Warehouse</i></li> </ul>
<b>Property Owner</b>	Enter the name of the property owner.
<b>Property Manager</b>	Enter the name of the property manager.
<b>ADA Compliant</b>	Select this check box if this site is ADA-compliant.
<b>Manager Rating</b>	Select a rating for this site from these values: <i>Excellent, Good, Avg., Fair, or Poor.</i>

## Location Page

Use the Location page (RE\_SITE\_LOCATION) to enter location information for this site.

You must enter a value for the longitude and latitude fields to view the map on the Site Map page.

Navigation:

**Lease Administration > Site Acquisition > Site Repository > Create Site > Location**

This example illustrates the fields and controls on the Location page. You can find definitions for the fields and controls later on this page.

<b>Field or Control</b>	<b>Description</b>
<b>Location Type</b>	Enter a type for this site location.
<b>Location Rating</b>	Select a rating for this site from these values: <i>Excellent, Good, Avg., Fair, or Poor.</i>
<b>Latitude</b>	Enter the latitude of the site. This value is used to render the site map.
<b>Longitude</b>	Enter the longitude of the site. This value is used to render the site map.
<b>Accessibility</b>	Select an accessibility rating for this site from these values: <i>Excellent, Good, Avg., Fair, or Poor.</i>
<b>Nearest Competitor</b>	Enter the distance of the nearest competitor from this site.
<b>Visibility</b>	Select the visibility for this site from these values: <i>Excellent, Good, Avg., Fair, or Poor.</i>

<b>Field or Control</b>	<b>Description</b>
<b>Nearest Company Office</b>	Enter the distance of the nearest company office.
<b>Neighborhood Quality</b>	Select the quality of the neighborhood for this site from these values: <i>Excellent, Good, Avg., Fair, or Poor.</i>
<b>Adjacent Uses</b>	Enter any adjacent uses for this site.
<b>Tax Authority</b>	Enter the tax authority that governs this site. This value is informational only. Values entered here are not used for any processing.
<b>Tax Group</b>	Enter the tax group for this site. This value is informational only. Values entered here are not used for any processing.
<b>Parcel Number</b>	Enter the parcel number for this site.
<b>Anchor 100 Feet. Anchor 250 Feet. and Anchor 500 Feet</b>	If this property is in a retail location, enter the number of anchors within the respective distances.

## Operation/Maintenance Page

Use the Operation/Maintenance page (RE\_SITE\_OPERATION) to enter operation and maintenance information about this site.

Navigation:

**Lease Administration > Site Acquisition > Site Repository > Create Site > Operation/Maintenance**

This example illustrates the fields and controls on the Operation/Maintenance page. You can find definitions for the fields and controls later on this page.

<b>Field or Control</b>	<b>Description</b>
<b>Property Age</b>	Enter the property age in months.
<b>Construction Type</b>	Select the construction type of the site: <ul style="list-style-type: none"> <li>• <i>Other</i></li> <li>• <i>Steel</i></li> <li>• <i>Wood</i></li> </ul>
<b>Construction Year</b>	Enter the year the site was constructed.
<b>Renovation Year</b>	Enter the year the site was last renovated, if any.
<b>Site Access</b>	Select a site access time: <ul style="list-style-type: none"> <li>• <i>24 Hours</i></li> <li>• <i>Business Hours Only</i></li> </ul>
<b>Operating Hours</b>	Enter the hours the site operates.
<b>Operating Days</b>	Enter the days the site operates
<b>HVAC Condition</b>	Select the condition of the HVAC for this site from these values: <i>Excellent, Good, Avg., Fair, or Poor.</i>
<b>Utilities Condition</b>	Select the condition of the utilities for this site from these values: <i>Excellent, Good, Avg., Fair, or Poor.</i>
<b>Wire Condition</b>	Select the condition of the wires for this site from these values: <i>Excellent, Good, Avg., Fair, or Poor.</i>
<b>Risk Category</b>	Select any potential risks for this site.
<b>Property Condition</b>	Select the condition of the property for this site from these values: <i>Excellent, Good, Avg., Fair, or Poor.</i>

## Physical Attributes Page

Use the Physical Attributes page (RE\_SITE\_ATTRIBUTES) to enter physical attributes, such as size.

Navigation:

**Lease Administration > Site Acquisition > Site Repository > Create Site > Physical Attributes**

This example illustrates the fields and controls on the Physical Attributes page. You can find definitions for the fields and controls later on this page.

<a href="#">General Information</a>	<a href="#">Location</a>	<a href="#">Operation/Maintenance</a>	<b><a href="#">Physical Attributes</a></b>	<a href="#">Schedule</a>	<a href="#">Value</a>	<a href="#">Supplemental Data</a>	<a href="#">Notes</a>	<a href="#">Contacts</a>	<a href="#">Site Map</a>
Action <input type="text" value="...Choose Action..."/>				<input type="button" value="Go"/>	Site Status <input type="text" value="Open"/>				
Business Unit <input type="text" value="US001"/>		Site ID <input type="text" value="000000000000001"/>		Site Type <input type="text" value="Residential"/>					
<b>Area Details</b>									
Plot Size <input type="text"/>			Square Feet		Ceiling Height <input type="text"/>			Square Feet	
Usable Area <input type="text"/>			Square Feet		Rentable Area <input type="text"/>			Square Feet	
Total Area <input type="text" value="1600.000"/>			Square Feet		Space Divisible <input type="text"/>			Square Feet	
<b>Occupancy Details</b>									
Maximum Occupancy <input type="text" value="5"/>			No. of Floors <input type="text" value="2"/>		Floor Levels <input type="text"/>				
No. of Parking Spaces <input type="text"/>			No. of Elevators <input type="text"/>		No. of Stairs <input type="text"/>				

<b>Field or Control</b>	<b>Description</b>
<b>Plot Size</b>	Enter the size of the plot.
<b>Ceiling Height</b>	Enter the ceiling height of the site.
<b>Usable Area</b>	Enter the usable area of the site.
<b>Rentable Area</b>	Enter the rentable area of the site.
<b>Total Area</b>	Enter the total area of the site. This field is required.
<b>Space Divisible</b>	Indicate if this space can be divided into multiple spaces.
<b>Maximum Occupancy</b>	Enter the maximum occupancy of the site.
<b>No. of Floors</b> (number of floors)	Enter the number of floors for this site.
<b>Floor Levels</b>	Enter the number of sub-levels for each floor of this site.
<b>No. of Parking Spaces</b> (number of parking spaces)	Enter the number of parking spaces for this site.
<b>No. of Elevators</b> (number of elevators)	Enter the number of elevators for this site.
<b>No. of Stairs</b> (number of stairs)	Enter the number of stair cases for this site.

## Schedule Page

Use the Schedule page (RE\_SITE\_SCHEDULE) to enter information such as site schedules or construction schedules.

Navigation:

**Lease Administration > Site Acquisition > Site Repository > Create Site > Schedule**

This example illustrates the fields and controls on the Schedule page. You can find definitions for the fields and controls later on this page.

General Information	Location	Operation/Maintenance	Physical Attributes	<b>Schedule</b>	Value	Supplemental Data	Notes	Contacts	Site Map
Action <input type="text" value="...Choose Action..."/> <input type="button" value="Go"/>					Site Status Negotiating				
Business Unit US001			Site ID 000000000000005		Site Type Residential				
<b>Site Schedules</b>									
Availability Date <input type="text" value="12/31/2008"/> <input type="button" value="B1"/>			Signed Date <input type="text"/> <input type="button" value="B1"/>						
Surrender Date <input type="text"/> <input type="button" value="B1"/>			Date Opened <input type="text"/> <input type="button" value="B1"/>						
Option to Renew <input type="text"/> <input type="button" value="B1"/>			Occupancy Date <input type="text" value="01/11/2009"/> <input type="button" value="B1"/>						
Date of Audit <input type="text"/> <input type="button" value="B1"/>									
<b>Construction Schedules</b>									
Construction Date <input type="text"/> <input type="button" value="B1"/>			Follow-up Date <input type="text"/> <input type="button" value="B1"/>						
Allowance Received Date <input type="text"/> <input type="button" value="B1"/>			Construction Approval Date <input type="text"/> <input type="button" value="B1"/>						
Allowance Due Date <input type="text"/> <input type="button" value="B1"/>									
<b>Lease Schedules</b>									
Lease Start Date <input type="text" value="01/01/2009"/> <input type="button" value="B1"/>			Lease End Date <input type="text" value="12/31/2015"/> <input type="button" value="B1"/>						
<input type="checkbox"/> Month to Month Lease			Lease Term (Periods) 84						

<b>Field or Control</b>	<b>Description</b>
<b>Availability Date</b>	Enter the date the site is available for lease or purchase.
<b>Signed Date</b>	Enter the date the contract was signed.
<b>Occupancy Date</b>	Enter the date the site is available for occupancy.
<b>Surrender Date</b>	Enter the date that the current tenants vacate the property.
<b>Date Opened</b>	Enter the date when the site officially opens.
<b>Date of Audit</b>	Enter the date of any required audits.
<b>Option to Renew</b>	Indicate if tenants are given the option to renew leases at the end of the term.
<b>Construction Date</b>	Enter the date construction is set to start.
<b>Follow-up Date</b>	Enter the date for the follow-up.
<b>Allowance Due Date</b>	Enter the date any allowances are due.

<b>Field or Control</b>	<b>Description</b>
<b>Allowance Received Date</b>	Enter the date the allowance was received.
<b>Construction Approval Date</b>	Enter the construction approval date.
<b>Lease Start Date</b>	Enter the lease start date. This value is informational only. The system does not use the date entered here when creating a new lease.
<b>Lease End Date</b>	Enter the lease end date.
<b>Lease Term (Periods)</b>	Enter the number of periods for the lease.
<b>Month to Month Lease</b>	Select this check box if this is a month-to-month lease.

## Value Page

Use the Value page (RE\_SITE\_VALUE) to enter value information for the site.

Navigation:

**Lease Administration > Site Acquisition > Site Repository > Create Site > Value**

This example illustrates the fields and controls on the Value page. You can find definitions for the fields and controls later on this page.

The screenshot displays the 'Value' page of a software application. At the top, there are navigation tabs: General Information, Location, Operation/Maintenance, Physical Attributes, Schedule, Value (selected), Supplemental Data, Notes, Contacts, and Site Map. Below the tabs, there is an 'Action' dropdown menu set to '...Choose Action...', a 'Go' button, and a 'Site Status' field set to 'Open'. Below this, there are fields for 'Business Unit' (US001), 'Site ID' (000000000000001), and 'Site Type' (Residential). The main content area is divided into two sections: 'Site Value' and 'Estimated Annual Expenses'. The 'Site Value' section contains fields for Currency Code (US Dollar), Original Selling Price, Unit Price, Remodel Costs, Sale Price, Current Selling Price, Rent Amount (10,000,000), Appraised Value, Closing Costs, and Construction Cost. The 'Estimated Annual Expenses' section contains fields for Deposit Amount (100,000,000), Tax Amount, Estimated Annual Utilities, Commission %, Annual Operating Expenses (10,000,000), Admin Fee Percentage, Estimated Annual Insurance, Estimated Annual Sales, Estimated Annual Maintenance, and Tenant Allowance.

## Site Value

<b><i>Field or Control</i></b>	<b><i>Description</i></b>
<b>Currency Code</b>	This value populates from the site type attributes setup.
<b>Sale Price</b>	Enter the sale price of the property.
<b>Appraised Value</b>	Enter the appraised value of the property.
<b>Original Selling Price</b>	Enter the price the original selling price of the site.
<b>Current Selling Price</b>	Enter the current selling price of the site.
<b>Closing Costs</b>	Enter any closing costs for the site.
<b>Unit Price</b>	Enter the per unit price.
<b>Rent Amount</b>	Enter the rent amount.
<b>Construction Cost</b>	Enter the cost of construction for this site.
<b>Remodel Costs</b>	Enter the amount of costs to remodel.

## Estimated Annual Expenses

This information is not required and is informational only.

<b><i>Field or Control</i></b>	<b><i>Description</i></b>
<b>Deposit Amount</b>	Enter the deposit amount for this site.
<b>Annual Operating Expenses</b>	Enter the estimated operating expenses amount for this site.
<b>Estimated Annual Sales</b>	Enter the estimated annual sales amount for this site.
<b>Tax Amount</b>	Enter the estimated annual tax amount for this site.
<b>Admin Fee Percentage(administration fee percentage)</b>	Enter the administration fee percentage for this site.



<b>Field or Control</b>	<b>Description</b>
<b>Estimated Annual Maintenance</b>	Enter the estimated annual maintenance amount for this site.
<b>Estimated Annual Utilities</b>	Enter the estimated annual utilities amount for this site.
<b>Estimated Annual Insurance</b>	Enter the estimated annual insurance amount for this site.
<b>Tenant Allowance</b>	Enter any predetermined amount provided by the landlord to cover certain costs, like remodeling or construction.
<b>Commission %</b>	Enter the commission percentage for this site.

## Supplemental Data Page

Use the Supplemental Data page (RE\_SITE\_SUPPLEMENT) to enter additional site data.

Navigation:

**Lease Administration > Site Acquisition > Site Repository > Create Site > Supplemental Data**

This example illustrates the fields and controls on the Supplemental Data page. You can find definitions for the fields and controls later on this page.

The fields that appear on this page depend upon the Site Type selected on the Add a New Value page.

<b>Field or Control</b>	<b>Description</b>
<b>Supplemental Data Weightings</b>	Enter the weighting amount to be applied to the supplemental data.
<b>Airport Distance</b>	Enter the distance to the nearest airport.

<b>Field or Control</b>	<b>Description</b>
<b>School Distance</b>	Enter the distance to the nearest school.

## Contacts Page

Use the Contacts page (RE\_SITE\_CONTACT) to select contacts from suppliers, customers, or the address book.

Navigation:

**Lease Administration > Site Acquisition > Site Repository > Create Site > Contacts**

This example illustrates the fields and controls on the Contacts page. You can find definitions for the fields and controls later on this page.

The screenshot shows the Contacts page interface. At the top, there are navigation tabs: Location, Operation/Maintenance, Physical Attributes, Schedule, Value, Supplemental Data, Notes, **Contacts**, and Site Map. Below the tabs is an 'Action' dropdown menu with a 'Go' button and 'Site Status' set to 'Negotiating'. A summary bar displays 'Business Unit: US001', 'Site ID: 000000000000005', and 'Site Type: Residential'. A 'Search and Add Contacts' button is present with the instruction 'Click on Contact Name for Contact details.' Below this is a 'Contact Details' table with columns for Source, Supplier / Customer, Contact Name, Title, and Email ID. The table currently shows one row with 'Contact Name' in the Contact Name column. Navigation controls for the table include 'Personalize', 'Find', 'View All', and 'First 1 of 1 Last'.

This page displays the contacts associated with this site. You can delete contacts or add contacts by clicking the **Search and Add Contacts** button.

## Search for Contacts Page

Use the Search for Contacts page (RE\_CNTCT\_SRCH) to search for or add contacts.

Navigation:

Click the **Search and Add Contacts** button on the SAR Contacts page.

This example illustrates the fields and controls on the Search for Contacts page. You can find definitions for the fields and controls later on this page.

**Contacts Search**

Enter any information you have and click Search. Leave fields blank for a list of all values.

**Search For Contacts**

Business Unit US001

\*Source Supplier

Supplier

begins with Supplier Name

Supplier Contact

begins with Contact Name

Select All  Clear All

**Contact Details** Personalize | Find | View All |

Select	Supplier Name	Contact Name	Title	Email ID
<input type="checkbox"/>				

First ◀ 1 of 1 ▶ Last

<b>Field or Control</b>	<b>Description</b>
<b>Source</b>	Select the source of the contact to search for: <ul style="list-style-type: none"> <li>• <i>Supplier</i></li> <li>• <i>Customer</i></li> <li>• <i>My Contacts</i></li> </ul>
<b>Supplier</b>	If you selected <i>Supplier</i> as the source, you can enter the supplier ID here to search for contacts related to this supplier. If you do not enter a value here, all suppliers will be returned.
<b>Supplier Name</b>	If you selected <i>Supplier</i> as the source, you can use this field to search for suppliers by name. You can enter partial names if you are unsure of the complete supplier name. For example, if you enter <i>BUY%</i> and select the <i>begins with</i> search type, then all suppliers whose name begins with <i>BUY</i> will be returned.
<b>Supplier Contact</b>	You can add a specific contact here if you know which contact you want to add. You must complete the supplier field before you add a value in this field. Leave this field blank if you want the system to return all contacts associated with the supplier.
<b>Contact Name</b>	If you know part or all of the contact name, you can add it here to search for contacts based on contact name.

<b>Field or Control</b>	<b>Description</b>
Select	Select this check box next to the contacts you want to associate with the site and click the <b>Add</b> button to add these contacts to the site.

## Site Map Page

Use the Site Map page (RE\_SITE\_MAP) to view the site map.

Navigation:

**Lease Administration > Site Acquisition > Site Repository > Create Site > Site Map**

This example illustrates the fields and controls on the Site Map page. You can find definitions for the fields and controls later on this page.

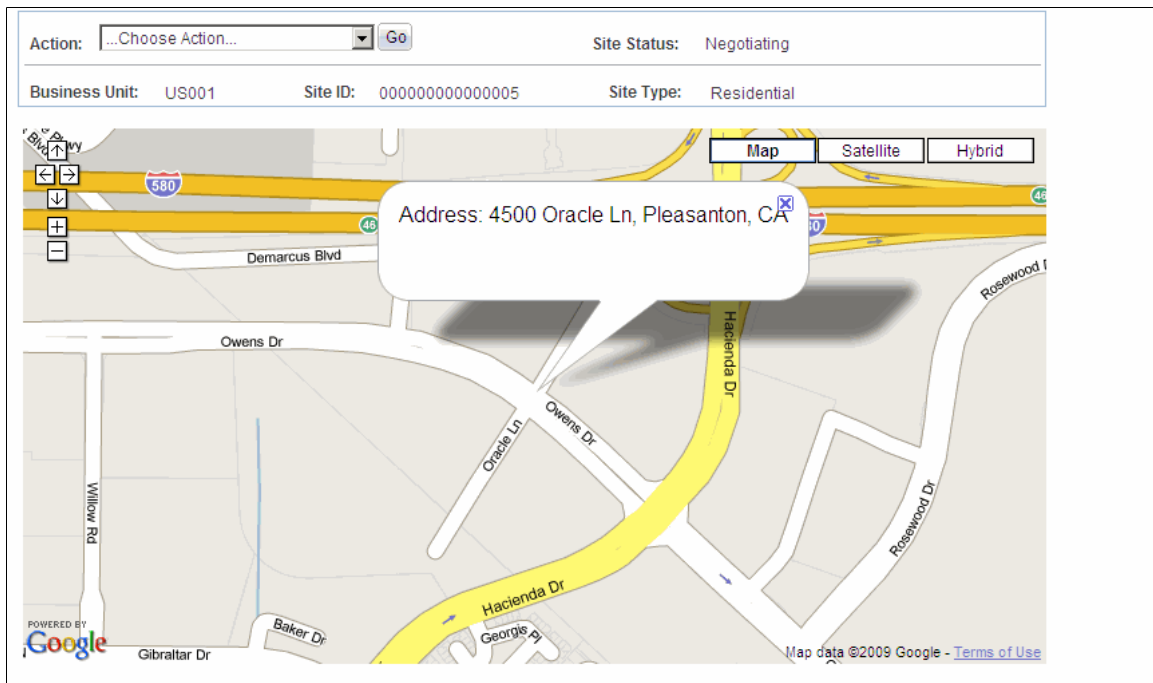

This page displays a map of the site location.

---

**Note:** You must define the longitude and latitude on the Location page before you can view a map on this page.

---

## Chapter 8

# Structuring Leases

---

## Understanding PeopleSoft Lease Administration Structure

Before you can enter or process a lease for billing or payment, you must set up the tables that form the foundation of the PeopleSoft Lease Administration system.

All tables and setup information specific to PeopleSoft Lease Administration are discussed in this section.

---

## Common Elements Used in Structuring Leases

<i>Field or Control</i>	<i>Description</i>
<b>Effective Date</b>	The date on which a table row becomes effective; the date that an action begins. For example, if you want to close out a ledger on June 30, the effective date for the ledger closing would be July 1. This date also determines when you can view and change the information. Pages and batch processes that use the information use the current row.
<b>SetID</b>	An identification code that represents a set of control table information or tablesets. A tableset is a group of tables (records) that are necessary to define your company's structure and processing options.
<b>Status</b> (effective status)	Indicates whether a row in a table is active or inactive. You cannot display inactive rows on transaction pages or use them for running batch processes. You should inactivate data that you no longer use rather than delete it to maintain an audit trail.

---

## Defining Lease Abstract Sections to Print

To define the lease abstract sections to print, use the lease abstract sections component (RE\_ABST\_SECT).

This topic provides an overview of lease abstract sections and discusses how to define the lease abstract sections to print.

## Page Used to Define Lease Abstract Sections to Print

<i>Page Name</i>	<i>Definition Name</i>	<i>Usage</i>
<u>Lease Abstract Page</u>	RE_ABST_SECT	Specify the lease sections that you want to view or print.

## Understanding Lease Abstract Sections to Print

PeopleSoft Lease Administration enables you to use a lease abstract worksheet to assist in quick entry of the terms and conditions of the lease. You can also print the lease abstract when you have completed lease entry to provide you with a summary.

The lease sections on the Lease Abstract page are specific pages from the Maintain Lease pages. You can specify all sections or only the sections that you choose to use.

## Lease Abstract Page

Use the Lease Abstract page (RE\_ABST\_SECT) to specify the lease sections that you want to view or print.

Navigation:

**Set Up Financials/Supply Chain > Product Related > Lease Administration > General Definitions > Lease Abstract**

This example illustrates the fields and controls on the Lease Abstract page (1 of 2). You can find definitions for the fields and controls later on this page.





Product Related Setup - Lease Administration

**Lease Abstract**

---

SetID SHARE

Lease Abstract Sections		Personalize   Find      
Print	Lease Section	Description
<input checked="" type="checkbox"/>	General Information	Includes all the fields displayed on the General Information page of the Lease Maintenance component including Timetable & Properties.
<input checked="" type="checkbox"/>	Financial Terms	Includes the general financial details of the Lease Maintenance component.
<input checked="" type="checkbox"/>	Base Rent	Includes the Base Rent Schedule from the Financial Terms page of the Lease Maintenance component.
<input checked="" type="checkbox"/>	Operating Expenses	Includes the Operating Expenses Schedule from the Financial Terms page of the Lease Maintenance component.
<input checked="" type="checkbox"/>	Miscellaneous Rent	Includes all scheduled Miscellaneous Rents from the Financial Terms section of the Lease.
<input checked="" type="checkbox"/>	Security Deposits	Includes the Security Deposit Information from the Financial Terms section of the Lease.
<input checked="" type="checkbox"/>	Percent Rent	Includes the details of any Percent Rent Schedule defined on the Lease.
<input checked="" type="checkbox"/>	Clauses	Includes all the Clauses from the Clauses section of the Lease.

This example illustrates the fields and controls on the Lease Abstract page (2 of 2). You can find definitions for the fields and controls later on this page.

<input checked="" type="checkbox"/>	User Defined Fields	Includes any User Defined Fields that have been configured through the setup pages.
<input checked="" type="checkbox"/>	Options and Critical Dates	Includes all Options and Critical Dates defined for the Lease.
<input checked="" type="checkbox"/>	Contacts	Includes the details of all the Contacts defined on the Lease.
<input checked="" type="checkbox"/>	Amendments	Includes all current and pending Amendments defined for the Lease.
<input checked="" type="checkbox"/>	Notes	Includes the details of all the Notes defined on the Lease.
<input checked="" type="checkbox"/>	Attachments	Includes the details of all the Attachments defined on the Lease.

<b>Field or Control</b>	<b>Description</b>
<b>Print</b>	Select the check box to enable printing of a section. You cannot view or print sections if you do not select the check box.

<b>Field or Control</b>	<b>Description</b>
<b>Lease Section</b>	Displays the sections within a lease that you can view or print on the lease abstract worksheet.
<b>Description</b>	Describes the content to be printed within the lease section.

## Defining Amendment Types

To define amendment types, use the Amendment Type and Reasons component (RE\_AMND\_TYPE).

This topic provides an overview of amendment types and discusses how to define amendment types.

### Page Used to Define Amendment Types

<b>Page Name</b>	<b>Definition Name</b>	<b>Usage</b>
<u>Amendment Types Page</u>	RE_AMND_TYPE	Define an amendment type and amendment reason. Use amendment reasons that are defined for this amendment type only to further categorize this amendment type.

## Understanding Amendment Types

PeopleSoft Lease Administration requires that any changes you make to active lease terms and conditions be processed through an amendment. When you create an amendment, the system creates a copy of the current lease details and preserves this as a historical record. The system then creates a new amendment, whereby you can define the changes.

Amendment types work with amendment reasons to provide the lease viewers with a quick explanation as to why an amendment is being made. A parent-child relationship exists between the amendment type and amendment reason. For example, you might have an amendment type of *Financial Terms Increase* and a reason of *Increased Parking Fees*. You must define the amendment reasons that are specific to the amendment type to view the amendment reason for that type. Before you can create amendments to a lease, you must define amendment types and amendment reasons.

---

**Note:** The amendment type is informational only—no processing occurs.

---

## Amendment Types Page

Use the Amendment Types page (RE\_AMND\_TYPE) to define an amendment type and amendment reason.

Use amendment reasons that are defined for this amendment type only to further categorize this amendment type.



Navigation:

**Set Up Financials/Supply Chain > Product Related > Lease Administration > General Definitions > LA Amendment Types**

This example illustrates the fields and controls on the Amendment Types page. You can find definitions for the fields and controls later on this page.

<i>Field or Control</i>	<i>Description</i>
<b>Amendment Type Name</b>	Enter an amendment type name to categorize the amendment activity.

**Amendment Reasons**

<i>Field or Control</i>	<i>Description</i>
<b>Amendment Reasons</b>	Further identify the reason that you are creating an amendment.

<i>Field or Control</i>	<i>Description</i>
<b>Add Reason</b>	Click to insert a new row to capture additional amendment reasons.

<i>Field or Control</i>	<i>Description</i>
<b>Remove Reason(s)</b>	Select the amendment reason that you want to remove and click the button to delete that row.

## Defining Lease Types

To define lease types, use the Lease Types component (RE\_LEASE\_TYPE).

This topic provides an overview of lease types and discusses how to define lease types.

### Page Used to Define Lease Types

<i>Page Name</i>	<i>Definition Name</i>	<i>Usage</i>
<u>Lease Types Page</u>	RE_LEASE_TYPE	Define lease types.

## Understanding Lease Types

Lease types enable you to categorize leases for processing and reporting purposes. You may have many lease types, such as operating leases, warehouse leases, and subleases. You can also use lease types for statistical reporting. You can select a sublease type for a lease and run a report to track all subleases associated with a lease.

When you create a lease type, you associate it with a lease category. The lease category determines the processing of that lease type. For example, if you have a lease type of *Reporting*, the system recognizes that the lease associated with this lease type is for analytical reporting. No further processing occurs.

## Lease Types Page

Use the Lease Types page (RE\_LEASE\_TYPE) to define lease types.

Navigation:

**Set Up Financials/Supply Chain > Product Related > Lease Administration > General Definitions > Lease Type**

This example illustrates the fields and controls on the Lease Types page. You can find definitions for the fields and controls later on this page.

<b>Field or Control</b>	<b>Description</b>
<b>Lease Category</b>	<p>Select the lease category for the lease type. The category determines how to sort or report the various lease types. Values are:</p> <p><i>Reporting:</i> No processing occurs.</p> <p><i>Sub Lease:</i> When you create a sublease, you must enter the associated parent lease number. The system validates the <b>Parent Lease</b> field to ensure that a parent lease is associated with the sublease.</p>

## Defining Prorata Basis

Use the Prorata Basis page to create a Prorata Basis definition.

### Page Used Create a Prorata Basis Definition

<b>Page Name</b>	<b>Definition Name</b>	<b>Usage</b>
<a href="#">Prorata Basis Page</a>	RE_PRORATA_BASIS	Used to create a Prorata Basis definition.

## Prorata Basis Page

Use the Prorata Basis page (RE\_PRORATA\_BASIS) to create a Prorata Basis definition. Prorata Basis is assigned to each Operating Expense category based on which the prorate share is calculated for each Operating Expense category.

Navigation:

**Set Up Financials/Supply Chain > Product Related > Lease Administration > General Definitions > LA Prorata Basis**

This example illustrates the fields and controls on the Prorata Basis page. You can find definitions for the fields and controls later on this page.

<i>Field or Control</i>	<i>Description</i>
<b>Prorata Basis Name</b>	Enter a prorata basis name to assign to the Prorata Basis definition.
<b>Description</b>	Provide detailed description on the Prorata Basis.

## Defining Region Codes

To define regions, use the Region Codes component (REGION\_CD).

This topic provides an overview of region codes.

## Understanding Region Codes

Regions can be physical entities or geographical areas. When a region represents a physical entity, the region code has the same characteristics as a business, that is, address and language. In PeopleSoft Lease Administration, you must associate a region with a lease to enable cost reporting by the various regions with which your organization does business. For example, you may require a report for all leased

properties in the Midwest region and in the Northeast region. By assigning a region to your lease, you can capture the data as required.

When creating or updating an existing region, be sure to select the category of *Reporting* as the default category. After you define the region, you can select the region for your lease and begin capturing the data for your reports.

See “Establishing Regions and Region Codes” (Application Fundamentals).

---

## Defining User-Defined Fields

To define user-defined fields, use the User Defined Fields components (RE\_USR\_DEF\_FLDS).

This topic provides an overview of user-defined fields and discusses how to define user-defined fields.

### Page Used to Define User-Defined Fields

<i>Page Name</i>	<i>Definition Name</i>	<i>Usage</i>
<u>User Defined Fields Page</u>	RE_USR_DEF_FLD	Define user-defined fields. Create a new user-defined field to capture additional reporting data as required by your organization.

### Understanding User-Defined Fields

Because not all businesses have the same reporting needs, PeopleSoft Lease Administration enables you to define additional fields (up to 10) to meet your reporting requirements. When you establish a user-defined field, the field is populated on your Clauses page in the PeopleSoft Lease Administration system, enabling you to enter the information that you want to track.

---

**Note:** User-defined fields are used for information or reporting purposes only.

---

### User Defined Fields Page

Use the User Defined Fields page (RE\_USR\_DEF\_FLD) to define user-defined fields.

Create a new user-defined field to capture additional reporting data as required by your organization.

Navigation:

**Set Up Financials/Supply Chain > Product Related > Lease Administration > General Definitions > LA User Defined Fields**

This example illustrates the fields and controls on the User Defined Fields page. You can find definitions for the fields and controls later on this page.

<i>Field or Control</i>	<i>Description</i>
<b>Field Name</b>	Identify the label name that should appear on the Clauses page.
<b>Description</b>	Enter the description for your user-defined field. The description defines how the field is used.

## Defining User-Defined Fields for Clauses

This topic discusses how to define user-defined fields for clauses.

### Page Used to Define User-Defined Fields for Clauses

<i>Page Name</i>	<i>Definition Name</i>	<i>Usage</i>
Clause User Defined Fields (Setup) Page	RE_CLS_USR_DEF_FLD	Define user-defined fields for clauses to capture additional reporting data as required by your organization.

## Clause User Defined Fields (Setup) Page

Use the Clause User Defined Fields page (RE\_CLS\_USR\_DEF\_FLD) to define user-defined fields for clauses.

Navigation:

**Set Up Financials/Supply Chain > Product Related > Lease Administration > General Definitions > Clause User Defined Fields**

This example illustrates the fields and controls on the Clause User Defined Fields page. You can find definitions for the fields and controls later on this page.

**Clause User Defined Fields**

 Product Related Setup - Lease Administration  
[Clause User Defined Fields](#)

SetID    SHARE

**Clause User Defined Fields** ?

Field Name	Description
<input type="text" value="Insurance"/>	<input type="text" value="Property Insurance"/>
<input type="text" value="Sub Lease"/>	<input type="text" value="Sub Lease"/>
<input type="text" value="Notice Period"/>	<input type="text" value="Termination Notice Period"/>
<input type="text"/>	<input type="text"/>
<input type="text"/>	<input type="text"/>
<input type="text"/>	<input type="text"/>
<input type="text"/>	<input type="text"/>
<input type="text"/>	<input type="text"/>
<input type="text"/>	<input type="text"/>
<input type="text"/>	<input type="text"/>

<i><b>Field or Control</b></i>	<i><b>Description</b></i>
<b>Field Name</b>	Identify the label name that should appear on the clause user defined field.
<b>Description</b>	Enter the description for your clause user-defined field.

## Defining Related Lease Type Setup

Use the Related Lease Type Setup page to define the relation between multiple leases.

## Page Used to Define the Relation Between Two Leases

<i>Page Name</i>	<i>Definition Name</i>	<i>Usage</i>
<u>Related Lease Type Setup Page</u>	RE_RLS_TYPE	Used to define the relation between multiple leases.

### Related Lease Type Setup Page

Use the Related Lease Type Setup page (RE\_RLS\_TYPE) to define the relation between multiple leases.

Navigation:

**Set Up Financials/Supply Chain > Product Related > Lease Administration > General Definitions > Related Lease Type Setup**

This example illustrates the fields and controls on the Related Lease Type Setup page. You can find definitions for the fields and controls later on this page.

The screenshot shows the 'Product Related Setup - Lease Administration' page. The main heading is 'Related Lease Type'. Below the heading, there are two columns: 'SetID' with the value 'SHARE' and 'Related Lease Type' with the value 'PER'. A 'Details' section contains a search bar and navigation controls. The form fields are:
 

- \*Effective From: 03/07/2018 (with a calendar icon)
- \*Effective Status: Active (with a dropdown arrow)
- \*Related Lease Type Name: (empty text box)
- Default Type for IU Transfers
- Description: (empty text area with a copy icon)

 At the bottom of the description area, it says '150 characters remaining'.

<i>Field or Control</i>	<i>Description</i>
<b>Related Lease Type Name</b>	Enter related lease type name to assign to the related lease.
<b>Description</b>	Provide detailed description for the Related Lease Type.



## Defining Borrowing Interest Rate

To define default borrowing rates, use the Borrowing Rate Default component (RE\_BORROW\_RATE).

### Pages Used to Define Borrowing Interest Rate

<i>Page Name</i>	<i>Definition Name</i>	<i>Usage</i>
<u>Borrowing Rate Default Page</u>	RE_BORROW_RATE	Define a default borrowing rate to be used in the classification of a lease.

### Borrowing Rate Default Page

Use the Borrowing Rate Default page (RE\_BORROW\_RATE) to define effective dated borrowing rates to be assigned to new leases.

Navigation:

**Set Up Financials/Supply Chain > Product Related > Lease Administration > General Definitions > LA Borrowing Interest Rate**

This example illustrates the fields and controls on the Borrowing Rate Default Page. You can find definitions for the fields and controls later on this page.

Product Related Setup - Lease Administration  
Borrowing Rate Default

SetID	SHARE
Details	
Effective Date	01/01/1900
*Effective Status	Active
Borrowing Rate Percent	5.0000

\* Required Field

<i>Field or Control</i>	<i>Description</i>
<b>Borrowing Rate Percent</b>	If an interest rate is not entered on the lease, then the borrowing rate percent is used to calculate the present value of lease payments. The borrowing rate percent default value can be overridden during lease entry.

## Defining Transaction Routing Codes

To define transaction routing codes, use the Transaction Routing Code components (RE\_TXN\_ROUTE).

This topic provides an overview of transaction routing codes and discusses how to define transaction routing codes.

## Page Used to Define Transaction Routing Codes

<i>Page Name</i>	<i>Definition Name</i>	<i>Usage</i>
<a href="#">Transaction Routing Codes Page</a>	RE_TXN_ROUTE	Define transaction routing codes.

## Understanding Transaction Routing Codes

Use transaction routing codes to define the routing of transactions to PeopleSoft Billing, Payables, and General Ledger. The transaction routing codes also provide the default ChartFields and taxation rules to be used by each financial application. You can associate a transaction routing code with one or more transaction types or transaction groups, providing default handling for any transaction item that belongs to a group that does not have an explicit routing code assigned.

## Transaction Routing Codes Page

Use the Transaction Routing Codes page (RE\_TXN\_ROUTE) to define transaction routing codes.

Navigation:

**Set Up Financials/Supply Chain > Product Related > Lease Administration > Financial Terms > LA Transaction Routing Codes**

This example illustrates the fields and controls on the Transaction Routing Codes page. You can find definitions for the fields and controls later on this page.

Product Related Setup - Lease Administration  
Transaction Routing Codes

SetID: SHARE      Transaction Routing Code: RENT

Details Find | View All    First 1 of 1 Last

\*Effective From: 01/01/1900      \*Status: Active

Description: Base Rent

Billing Charge: Local Service - Charge Code 1

---

**Withholding**

\*Withholding Applicable: Yes      Withholding Code: Rents

---

**Sales and Use Tax**

Tax Applicability: Sales Tax Applicable      Tax Code: New York City

## Details

<i>Field or Control</i>	<i>Description</i>
<b>Billing Charge</b>	<p>Select a billing charge. PeopleSoft Billing uses the billing charge code to process transactions for PeopleSoft Lease Administration. The billing charge classifies lease administration transactions.</p> <hr/> <p><b>Note:</b> Billing charges apply only to receivables lease transactions.</p> <hr/>

## Withholding Code

<i>Field or Control</i>	<i>Description</i>
<b>Withholding Applicable</b>	<p>Select whether withholding is applicable. The withholding applicable determines whether the voucher that is generated in PeopleSoft Payables is applicable to tax withholding. Values are:</p> <p><i>Yes:</i> Select if withholding applies on transactions associated with this transaction routing code. Withholding does not apply if the supplier on the lease does not withhold. Withholding from PeopleSoft Lease Administration overrides the withholding in PeopleSoft Payables.</p> <p><i>No:</i> Select if withholding does not apply.</p> <hr/> <p><b>Note:</b> Withholding applies only to payables lease transactions.</p> <hr/> <p>See “Understanding the Withholding Process” (PeopleSoft Payables).</p>

<i>Field or Control</i>	<i>Description</i>
<b>Withholding Code</b>	<p>Select the withholding code for the associated withholding applicable. The system applies the withholding code to the voucher in PeopleSoft Payables to determine the withholding amount for the lease transaction. If <b>Withholding Applicable</b> is set to <i>Yes</i>, and no value is selected for the withholding code, PeopleSoft Payables applies the standard default when the supplier is set up for withholding.</p>

**Note:** Set up supplier information accordingly on the Procurement Control - Withholding page for proper withholding defaults.

See “Understanding the Withholding Process” (PeopleSoft Payables).

## Sales & Use Tax Default

<b>Field or Control</b>	<b>Description</b>
<b>Tax Applicability</b>	Select the tax that is applicable to payables transactions. Use this field to determine the excise duty and sales tax applicability details. Values are <i>Direct Pay</i> , <i>Exempt</i> , <i>Exonerated</i> , <i>Sales Tax</i> , and <i>Use Tax</i> .  <b>Note:</b> Tax applicability applies only to payables lease transactions.
<b>Tax Code</b>	Select the tax code to determine the tax percentage for a county. If <b>Tax Applicability</b> is set to <i>Yes</i> , and no value is selected for the tax code, PeopleSoft Payables applies the standard default from supplier.

See “Understanding PeopleSoft-Only Sales and Use Tax Processing” (PeopleSoft Payables).

---

## Defining Operating Expense Categories

To define operating expense categories, use the Operating Expense Categories component (RE\_EXP\_CLASS).

This topic provides an overview of operating expense categories and lists the pages used to define operating expense categories.

### Page Used to Define Operating Expense Categories

<b>Page Name</b>	<b>Definition Name</b>	<b>Usage</b>
Operating Expense Categories	RE_EXP_CLASS	Create an operating expense category.

## Understanding Operating Expense Categories

When landlords lease properties to tenants, terms for recoverable expenses that are incurred on general operations and maintenance of the building are written into the lease. *Operating expenses* is also commonly referred to as common area maintenance (CAM). You can identify the different recoverable expenses incurred by assigning them to an operating expense category. Operating expense categories enable you to associate a transaction routing code to ensure that financial processing occurs to handle the expense.

## Operating Expense Categories Page

Use the Operating Expense Categories page (RE\_EXP\_CLASS) to create an operating expense category.

Navigation:

**Set Up Financials/Supply Chain > Product Related > Lease Administration > Financial Terms > LA Operating Exp Categories**

This example illustrates the fields and controls on the Operating Expense Categories. You can find definitions for the fields and controls later on this page.

<i>Field or Control</i>	<i>Description</i>
<b>Include in Lease Payments</b>	<p>Select to include the payment in both ROU (Right Of Use) Asset and Lease payments.</p> <p>If the check box is selected for an operating expense category, then the payments generated from the lease financial term having that operating expense category are included in the capitalized lease amount. If the check box is not selected, then the expense accounting using the LA accounting rules will be used to send the debit entry to the Accounts Payable.</p>

## Defining Sales Categories

To define sales categories, use the Sales Categories component (RE\_SALE\_CAT).

This topic provides an overview of sales categories and lists the pages used to define sales categories.

## Page Used to Define Sales Categories

<i>Page Name</i>	<i>Definition Name</i>	<i>Usage</i>
Sales Categories	RE_SALES_CAT	Define sales categories.

## Understanding Sales Categories

Use sales categories to identify merchandise classifications for percentage rent calculations. Tenants can negotiate a lower monthly base rent in exchange for a percentage of their sales, broken down by categories. For example, a tenant may lease a building for retail sale for a set base rent, selling items such as clothing, shoes, and accessories. These items are set up as sales categories, enabling the tenant to provide the landlord a monthly report of sales by category and amount of sales. The amount or percentage of the sales paid to the landlord is determined during lease negotiations.

After you define the sales categories and percentage sales terms are negotiated, you can enter the percent rent terms specifying the breakpoints for each category. Use breakpoints to determine the percentage or amount to bill. Landlords can calculate or recalculate the billable amount by using the percent rent sales feature.

See [Understanding Percent Rent Terms](#).

---

## Defining Miscellaneous Rent Types

To define miscellaneous rent types, use the Miscellaneous Rent Types component (RE\_MISC\_FEES).

This topic provides an overview of miscellaneous rent types and lists the pages used to define miscellaneous rent types.

## Page Used to Define Miscellaneous Rent Types

<i>Page Name</i>	<i>Definition Name</i>	<i>Usage</i>
Miscellaneous Rent Types	RE_MISC_FEES	Define miscellaneous rent types.

## Understanding Miscellaneous Rent Types

Define miscellaneous rent types for miscellaneous recurring payments, such as monthly parking fees and storage fees on your lease. You can define miscellaneous rent types with a date range, schedule, amount, billing frequency, and any potential escalations.

In addition, to separate a miscellaneous rent type as a distinct bill line on an invoice, you can associate miscellaneous rent types with a transaction routing code that is specifically defined with a unique bill code.

## Miscellaneous Rent Types Page

Use the Miscellaneous Rent Types page (RE\_MISC\_FEES) to define miscellaneous rent types.

Navigation:

**Set Up Financials/Supply Chain > Product Related > Lease Administration > Financial Terms > LA Miscellaneous Rent Types**

This example illustrates the fields and controls on the Miscellaneous Rent Types page. You can find definitions for the fields and controls later on this page.

<b>Field or Control</b>	<b>Description</b>
<b>Rent Type</b>	<p>The available options are:</p> <ul style="list-style-type: none"> <li><i>Initial Direct Cost:</i> Payments that are initial direct cost or fees to third parties. Initial Direct Costs are included in the ROU Asset, but not in the lease liability.</li> <li><i>Other:</i></li> </ul>
<b>Include in Lease Payments</b>	<p>Select to indicate whether the amount must be included in the ROU Asset and Lease payments or not.</p> <p>If the Include in Lease Payments check box is selected for a miscellaneous rent type, then the payments generated from the lease financial term having that miscellaneous rent type are included in the capitalized lease amount.</p> <hr/> <p><b>Note:</b> The check box is displayed only if the Rent Type option is Other.</p> <hr/>

<i>Field or Control</i>	<i>Description</i>
<b>Interim/Prepaid Rent</b>	For an interim/prepaid rent payment schedule, interest expense is always zero and the entire rent amount will be the obligation reduction.

## Defining Security Deposit Types

To define security deposit types, use the Security Deposit Types component (RE\_SECURITIES).

This topic provides an overview of security deposit types and discusses how to define security deposit types.

### Page Used to Define Security Deposit Types

<i>Page Name</i>	<i>Definition Name</i>	<i>Usage</i>
<u>Security Deposit Types Page</u>	RE_SCTY_DEP_TYP	Define security deposit types.

## Understanding Security Deposit Types

Using the security deposit type enables the system to track whether the security deposit is a bank guarantee, cash, or prepaid. Security deposit types enable you to track the deposits received and also the interest that is generated by security deposits.

Security deposit types facilitate the processing of security deposits received or paid. By selecting the appropriate category for each security deposit type, the PeopleSoft Lease Administration system determines how the security deposit is handled. There are three security deposit categories: *Charge*, *Guarantee* and *Prepaid*. You can create and assign a deposit type to categories.

## Security Deposit Types Page

Use the Security Deposit Types page (RE\_SCTY\_DEP\_TYP) to define security deposit types.

Navigation:

**Set Up Financials/Supply Chain > Product Related > Lease Administration > Financial Terms > LA Security Deposit Types**



<b>Field or Control</b>	<b>Description</b>
<b>Category</b>	<p>Select a category from this list of values:</p> <p><i>Charge:</i> The security deposit has been received for a receivables lease or paid by for a payables lease and the status of the deposit is pending .</p> <p><i>Guarantee:</i> Bank guarantee or letter of credit issued by a bank. No processing occurs; cash is not collected.</p> <p><i>Prepaid:</i> Tracks prepaid security deposits paid through PeopleSoft Payables prior to lease activation. These deposits are treated as cash during deposit refund.</p>

---

## Defining Manual Fee Types

To define manual fee types, use the Manual Fee Types components (RE\_SUNDRY\_CHG).

This topic provides an overview of manual fee types and lists the pages used to define manual fee types.

### Page Used to Define Manual Fee Types

<b>Page Name</b>	<b>Definition Name</b>	<b>Usage</b>
Manual Fee Types	RE_MISC_FEES	Define manual fee types.

## Understanding Manual Fee Types

You create manual fee types to classify ad hoc payments for things such as repair of a broken window, rekeying a lock for an office, or items not related to the monthly operating expense fees. When creating manual fee types, you can link these manual fee types to specific transaction routing codes for processing in PeopleSoft Billing or PeopleSoft Payables.

Use manual fee types to create ad hoc payments for transactions that are one-time only payments.

---

## Defining Economic Index Values

To define economic index values, use the Economic Index Values component (RE\_INDEX).

This topic provides an overview of economic index values.

## Page Used to Define Economic Index Values

<i>Page Name</i>	<i>Definition Name</i>	<i>Usage</i>
<u>Economic Index Values Page</u>	RE_IDX_VALUE	Define the economic index values. Rent increases are based on the economic index values defined.

## Understanding Economic Index Values

You set up the economic index values so that the lease rent amounts or miscellaneous fees increase from time to time or from year to year. Some leases are set up so that the rent amounts increase regularly, based on an index such as the Consumer Price Index (CPI), Porters' Wage, or a user-defined index.

---

**Note:** You cannot set up the economic index without first setting up the market rate index and market rates. Perform maintenance of the index values based on the frequency defined by your organization.

---

See “Defining Market Rates” (PeopleSoft Global Options and Reports)

## Economic Index Values Page

Use the Economic Index Values page (RE\_IDX\_VALUE) to define the economic index values.

Rent increases are based on the economic index values defined.

Navigation:

**Set Up Financials/Supply Chain > Product Related > Lease Administration > Financial Terms > LA Economic Index**

This example illustrates the fields and controls on the Economic Index Values page. You can find definitions for the fields and controls later on this page.

Product Related Setup - Lease Administration

### Economic Index Values

SetID	SHARE	Index	BAYAREA	Description	Bay Area Metropolitan Area CPI	View Index Definition
Index Values <span style="float: right;">Personalize   Find      First 1-28 of 28 Last</span>						
*From Date		*To Date		*Value		
01/01/2000		02/29/2000			176.50000000	
03/01/2000		04/30/2000			178.70000000	
05/01/2000		06/30/2000			179.10000000	
07/01/2000		08/31/2000			181.70000000	
09/01/2000		10/31/2000			183.40000000	
11/01/2000		12/31/2000			184.10000000	
01/01/2001		02/28/2001			187.90000000	
03/01/2001		04/30/2001			189.10000000	
05/01/2001		06/30/2001			190.90000000	
07/01/2001		08/31/2001			191.00000000	
09/01/2001		10/31/2001			191.70000000	
11/01/2001		12/31/2001			190.60000000	
01/01/2002		02/28/2002			191.30000000	
03/01/2002		04/30/2002			193.00000000	
05/01/2002		06/30/2002			193.20000000	

\* Required Field

Field or Control	Description
<b>View Index Definition</b>	Click to view the Market Rate Index. This page provides the highest level of organization for market rates in the PeopleSoft system. These indices define general categories of market rates, such as exchange rates, interest rates, and commodity exchange rates.

### Index Values

Field or Control	Description
<b>Date From</b>	Select the start date.

<b>Field or Control</b>	<b>Description</b>
<b>Date To</b>	Select the end date.
<b>Field or Control</b>	<b>Description</b>
<b>Value</b>	Enter the current index value for the period. These values are based on monthly updates received from an index subscription.

## Defining Clause Types

To define clause types, use the Clause Types component (RE\_CLAUSE\_STYPE).

This topic provides an overview of clause types and discusses how to define clause types.

### Page Used to Define Clause Types

<b>Page Name</b>	<b>Definition Name</b>	<b>Usage</b>
<a href="#">Clause Types Page</a>	RE_CLAUSE_TYPE	Define the clause type. From this page, you can define specific clauses that you want to track.

## Understanding Clause Types

You can capture and classify pertinent lease information, such as right to assign the lease, first right of refusal, parking privileges, number of parking spaces, and so on. Clause types enable you to categorize and store this information in a logical format, which can be shared with other leases. After you establish the parking privileges clause type, you can further define the clause subtype with the corresponding detail of number of parking spaces.

### Clause Types Page

Use the Clause Types page (RE\_CLAUSE\_TYPE) to define the clause type.

From this page, you can define specific clauses that you want to track.

Navigation:

**Set Up Financials/Supply Chain > Product Related > Lease Administration > Clauses and Options > Clause Type**

This example illustrates the fields and controls on the Clause Types page. You can find definitions for the fields and controls later on this page.

<b>Field or Control</b>	<b>Description</b>
<b>Clause Subtypes</b>	Enter corresponding names and descriptions that further define the clause types. You can add multiple clause subtypes for the clause type.

## Defining Lease Administration Options

To define a lease administration option definition and mail template, use the Option Definition (RE\_LEASE\_OPTION) and Mail Template (RE\_OPTION\_MAIL) components.

This topic provides an overview of lease administration options discusses how to define lease options.

## Pages Used to Define Lease Options

<b>Page Name</b>	<b>Definition Name</b>	<b>Usage</b>
<a href="#">Lease and SAR Options Page</a>	RE_LEASE_OPTION	Enter the option name.
<a href="#">Lease and SAR Option Mail Template Page</a>	RE_OPTION_MAIL	Enter a message to be associated with the option.

<b>Page Name</b>	<b>Definition Name</b>	<b>Usage</b>
<a href="#">Copy Mail Template Page</a>	RE_CPYMAIL_TMPLT	Select the option that you want to copy into the mail template.
<a href="#">Insert Mail Fields Page</a>	RE_OPT_TAG	Select the template marker for values that you want to insert into your option description.
Lease and SAR Option Mail Sample Page	RE_OPTION_MPRV	Preview a sample of your mail message.  <a href="#">Lease and SAR Option Mail Template Page</a>

## Understanding Lease Administration Options

Lease and SAR (site acquisition request) options are used to identify clauses. Lease Administration options can be the same as a clause with a critical date as a reminder to take action for that option. You can define whether you receive a reminder when an action is required. Options are usually associated with critical dates (dates by which the option is exercised). Lease renewals, terminations, and early terminations are options that may require an action that is defined in the lease.

When you define your lease administration options, you can also create a mail template with standard messaging to notify a user when an action is to take place. The mail template enables you to enter your own message, copy from an existing option message, or combine your message with field inserts.

Click the **Copy From Option** button to select a message from an existing option. For example, you can have multiple termination options; however, the message that you have associated with each option can be the same. Copying from an existing option eliminates data entry redundancy.

---

**Note:** Critical dates cause the system to send email notifications to specified users, as well as generate entries in a user's tasklist. However, do not confuse a tasklist with the worklist in PeopleSoft Workflow. Critical dates do not use standard PeopleSoft Workflow. When entries are created in My Tasklist, they are there for informational purposes only. They do not initiate any further downstream processing, nor does any rerouting or validation indicate that specific tasks are completed. Users can choose to mark entries in their tasklists as complete; however, this is for their own information. The system does not use the data in the same way that PeopleSoft Workflow might. Email notifications are generated through the Critical Dates Template - Template Option Details page setup.

---

See [Understanding Critical Date Templates](#).

## Lease and SAR Options Page

Use the Lease and SAR Options page (RE\_LEASE\_OPTION) to enter the option name.

Navigation:

**Set Up Financials/Supply Chain > Product Related > Lease Administration > LA Options**

This example illustrates the fields and controls on the Lease and SAR Options Page. You can find definitions for the fields and controls later on this page.

<b>Field or Control</b>	<b>Description</b>
<b>Mail Template</b>	Click to access the <b>Lease and SAR Option Mail Template</b> page.
<b>Option Name</b>	Enter the option name that describes the option.
<b>Option Type</b>	<p>Enter the option type to distinguish between lease options and SAR options.</p> <p>The available options are the following :</p> <ul style="list-style-type: none"> <li>• Other</li> <li>• Penalties</li> <li>• Purchase Option</li> <li>• Renewal Option</li> </ul>

## Lease and SAR Option Mail Template Page

Use the Lease and SAR Option Mail Template page (RE\_OPTION\_MAIL) to enter a message to be associated with the option.

Navigation:

Click the **Mail Template** link on the **Lease and SAR Options** page.

This example illustrates the fields and controls on the Lease and SAR Option Mail Template page. You can find definitions for the fields and controls later on this page.

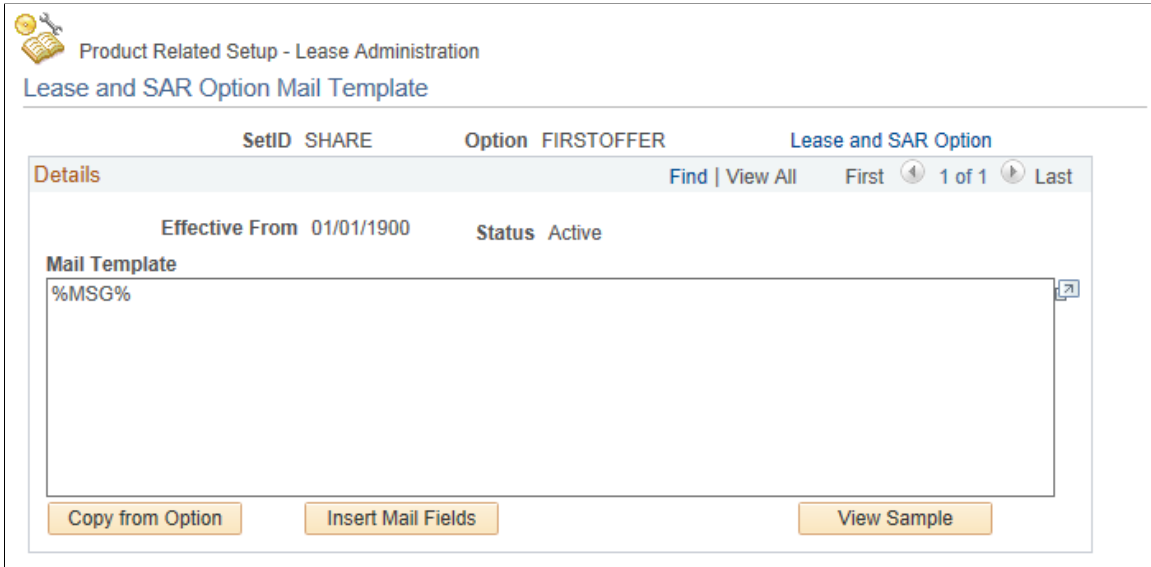

<b>Field or Control</b>	<b>Description</b>
<b>Lease and SAR Option</b>	Click to return to the Lease and SAR Options page.
<b>Mail Template</b>	Enter the mail message that you want to associate with the option. Using the template keeps email formats consistent and also reduces data entry redundancy.
<b>Copy from Option</b>	Click to view a list of predefined values to copy into the mail message. To obtain a list of lease and SAR options template values, enter partial values and click the <b>Search</b> button.
<b>Insert Mail Fields</b>	Click to view a list of predefined values to insert into the mail template.
<b>View Sample</b>	Click to view a sample of the predefined mail message.

## Copy Mail Template Page

Use the Copy Mail Template page (RE\_CPYMAIL\_TMPLT ) to select the option that you want to copy into the mail template.

Navigation:

Click the **Copy from Option** button on the **Lease and SAR Option Mail Template** page.



This example illustrates the fields and controls on the Copy Mail Template page. You can find definitions for the fields and controls later on this page.

**Copy Mail Template**

 Product Related Setup - Lease Administration

**Copy Mail Template**

( Begins With )      Option Name      

Copy From		
	Lease Option Name	Description
<input type="radio"/>	Lease Renewal	<input type="button" value="View Sample"/>
<input type="radio"/>	Lease Termination	<input type="button" value="View Sample"/>

<b>Field or Control</b>	<b>Description</b>
<b>Option Name</b> (begins with)	Enter a partial name or the name of the option that you want to search for and click the <b>Search</b> button.
<b>Lease Option Name</b>	Displays a list of available lease options to copy into a new message. Select the lease option to insert message text.
<b>View Sample</b>	Click to view the message text associated with that option.

## Insert Mail Fields Page

Use the Insert Mail Fields page (RE\_OPT\_TAG) to select the template marker for values that you want to insert into your option description.

Navigation:

Click the **Insert Mail Fields** button on the **Lease and SAR Option Mail Template** page.

This example illustrates the fields and controls on the Insert Mail Fields page. You can find definitions for the fields and controls later on this page.

**Mail Fields**

 Product Related Setup - Lease Administration

**Insert Mail Fields**

<b>Mail Fields</b>			
	Name	Marker	Description
<input type="checkbox"/>	Lease Number	Lease Number	Replaced by the Lease Number when the Option is used on a lease.
<input type="checkbox"/>	Lease Title	Lease Title	Replaced by the Lease Title when the Option is used on a lease.
<input type="checkbox"/>	SAR ID	SAR ID	Replaced by the SARID when the Option is used on a SAR.
<input type="checkbox"/>	SAR Title	SAR Title	Replaced by the SAR Title when the Option is used on a SAR.
<input type="checkbox"/>	Option Name	Option Name	Replaced by the Event Name when the Option is used on a lease.
<input type="checkbox"/>	Action Date	Action Date	Replaced by the Action Date of the Critical Date when the Option is used.
<input type="checkbox"/>	Message	Message	Replaced by the Message assigned to the Critical Date when the Option is used.

<b>Field or Control</b>	<b>Description</b>
<b>Name</b>	<p>Select the name fields to be inserted into the mail template. When you create a lease, you select the lease options to associate with that lease. The fields that you select insert specific field data into the message template.</p> <p>For example, if you select <i>Lease Number</i> as the marker in the message, the lease number from the lease that you associate with the lease option replaces the marker in the message field.</p>

<b>Field or Control</b>	<b>Description</b>
<b>Marker</b>	<p>Display the place holder for specific text on the message template. Whether you select <i>Lease Number</i>, <i>Lease Title</i>, <i>Action Date</i>, and so on, the associated information is supplied by default onto the message template when the option is used on a lease.</p> <p>For example, by inserting the marker in your message (<i>This is a notice to inform you that the %LSNBR% will expire in 30 days</i>), your message will read <i>This is to inform you that the lease number A30178 will expire in 30 days</i>.</p>

<i>Field or Control</i>	<i>Description</i>
<b>Description</b>	Displays the description for each marker.

## Defining Critical Date Templates

To define lease critical date templates, use the critical date template component (RE\_CRDT\_TMPLT).

This topic provides an overview of critical date templates.

## Pages Used to Define Critical Date Templates

<i>Page Name</i>	<i>Definition Name</i>	<i>Usage</i>
<a href="#">Define Critical Date Template Page</a>	RE_TMPLT_NM	Enter the critical date option definition.
<a href="#">Define Option Notifications Page</a>	RE_TMPLOPT_DTL	Define a notification schedule and the recipients for the notification. An email notification goes out to the role defined here.

## Understanding Critical Date Templates

A lease may have a variety of events that occur throughout the lease life cycle. Some of these events may require intervention by various interested parties associated with the lease. These events are usually, but not always, associated with an option clause contained in the lease.

You can use lease events to track key milestones (such as security deposits and lease termination), lease options (such as renewals and right of first offer), or other activities (such as lease activation approval). Because each interested party needs to have early warning when these dates become due, the critical date template enables you to set up alerts to remind you to take the appropriate actions.

When you need to be alerted of dates for an event that requires an action or decision, you can do so by associating the critical dates template with that lease. You must define the critical date template and schedule the template to alert you once, on a specific date, or using a timetable. You can also select the lease options and the recipients that are to receive the alerts.

For example, if you want to be notified when a lease is up for renewal before it expires, you can set the critical date notification to notify you six months in advance, again every month for the final three months, once a week in the final month, and then every other day in the last two weeks.

This table describes how to set up the critical dates notification from the example above:

<b>Enable</b>	<b>Notification</b>	<b>Recurring</b>	<b>Every</b>	<b>On</b>
Y	6 Months Prior	Never		
Y	3 Months Prior	Month	1 Month	15 <sup>th</sup> of the Month
Y	4 Weeks Prior	Weekly	1 Week	Monday
Y	14 Days	Daily	2 Days	

## Define Critical Date Template Page

Use the Define Critical Date Template page (RE\_TMPLT\_NM) to enter the critical date option definition.

Navigation:

**Set Up Financials/Supply Chain > Product Related > Lease Administration > LA Critical Date Templates**

This example illustrates the fields and controls on the Define Critical Date Template page. You can find definitions for the fields and controls later on this page.

**Product Related Setup - Lease Administration**  
**Define Critical Date Template**

SetID	SHARE	Critical Date Template	RENEW_TMPLT
<b>Details</b> Find   View All First 1 of 1 Last			
*Effective From		01/01/1900	*Status Active
*Template Name		Renewal Template	
Description		Critical Date Template for Lease Renewal	
110 characters remaining			
<input checked="" type="checkbox"/> Select All <input type="checkbox"/> Clear All			
<b>Template Options</b>			
*Option Name			
<input type="checkbox"/>	Lease Renewal	Define Notifications	
Add Option		Remove Option(s)	

\* Required Field

<b>Field or Control</b>	<b>Description</b>
<b>Template Name</b>	Enter the name that best defines this critical date template.
<b>Option Name</b>	Select the option for which you want to define notifications.
<b>Define Notifications</b>	Click to access the Define Option Notifications page.

## Define Option Notifications Page

Use the Define Option Notifications page (RE\_TMPLOPT\_DTL ) to define a notification schedule and the recipients for the notification.

An email notification goes out to the role defined here.

Navigation:

Click the **Define Notifications** button on the Define Critical Date Template page.

This example illustrates the fields and controls on the Define Option Notifications page. You can find definitions for the fields and controls later on this page.

The screenshot shows the 'Define Option Notifications' page. At the top, there's a breadcrumb 'Product Related Setup - Lease Administration' and a sub-header 'Define Option Notifications'. Below this is the 'Schedule Details' section, which includes a checked 'Enable Notifications' checkbox. Underneath, there are three radio button options for when to send the initial notification: '2 Days prior to Option Date' (selected), 'On the Lease Start Date', and 'On a Specific Date'. A 'Recurring' section is partially visible below. At the bottom, there's a 'Recipient Roles' table with columns for 'Role Type' and 'Role', and a search icon.

### Schedule Details

<b>Field or Control</b>	<b>Description</b>
<b>Enable Notifications</b>	Select to enable the notification.

## Send initial notification

<b>Field or Control</b>	<b>Description</b>
<b>prior to Option Date</b>	<p>Enter the number, and then select days, months, or years prior to the option date that you want to receive the notification.</p> <p>Enter a number in the blank field and select one of these values:</p> <p><i>Days</i></p> <p><i>Months</i></p> <p><i>Years</i></p>
<b>On the Lease Start Date</b>	Select if you want to receive the notification upon the date that the lease is activated.

<b>Field or Control</b>	<b>Description</b>
<b>Specific Date</b>	Enter or select a specific date.

## Recurring

You can send recurring notifications based on the following criteria:

<b>Field or Control</b>	<b>Description</b>
<b>Never</b>	Select to never send recurring notifications.

<b>Field or Control</b>	<b>Description</b>
<b>Daily</b>	Select to send daily notices. You can enter a number in the blank field in the <b>Daily</b> row to indicate the notification frequency. For example, if you enter 2, the system sends a notification every two days until the option date occurs.

<b>Field or Control</b>	<b>Description</b>
<b>Weekly</b>	Select to send notices weekly. You can enter a number in the blank field in the <b>Weekly</b> row to define the notification frequency and you can specify which day or days of the week to send the notifications. For example, if you enter 2 for the notification frequency and select Monday and Friday, the system sends notifications on Monday and Friday every two weeks until the option date occurs. If you specify a day of the week, you must enter the notification frequency.
<b>Monthly</b>	Select to send notices monthly. You can enter a number in the blank field on the <b>Monthly</b> row to define the notification frequency and you can specify on which day of the month the notification is sent.
<b>Yearly</b>	Select to send notices yearly. Select from the <i>Month</i> list and define the number in the <b>On Day</b> field for a specific day within that month. For example, notifications can be sent in January on the fifth day of the month until the option date occurs.

<b>Field or Control</b>	<b>Description</b>
<b>Role Type</b>	Select the role type or recipient to receive notifications. Notification are sent out to any individual in your organization who is assigned to this role type.  See <a href="#">Understanding Role Types</a> .

## Defining Role Types

To define role types, use the role types component (RE\_PARTY\_TYPE).

This topic provides an overview of role types and discusses how to define role types.

### Page Used to Define Role Types

<b>Page Name</b>	<b>Definition Name</b>	<b>Usage</b>
<a href="#">Role Types Page</a>	RE_PTY_TYPE	Define role types.

## Understanding Role Types

Role types enable you to define the many contacts stored within your PeopleSoft Lease Administration system. They are also used to identify critical date recipients. You can set up a role as a role type. Role types can be a lease administrator, portfolio manager, landlord, tenant, billing clerk, payables clerk, bank contact, and so on.

After you set up the role type, you associate the role category to determine approval processing. When auto-approval is enabled, roles that are assigned the role type of *Internal Administrator* and *Internal Manager* can activate leases. If auto-approval is disabled, only the role that is assigned to the *Internal Manager* role type can activate leases.

---

**Note:** You must define at least one role type for your PeopleSoft Lease Administration system.

---



---

**Note:** Role types are not used as a security feature in PeopleSoft applications.

---

## Role Types Page

Use the Role Types page (RE\_PTY\_TYPE) to define role types.

Navigation:

**Set Up Financials/Supply Chain > Product Related > Lease Administration > User Roles > LA Role Types**

<i>Field or Control</i>	<i>Description</i>
<b>Role Category</b>	<p>Your selection determines the actions for each role that you define. Four role categories are available:</p> <p><i>External Contact:</i> A contact that is not an employee of your organization. A contact can be a supplier or service personnel, such as a sale representative from a janitorial supply company or a repair man.</p> <p><i>Internal Administrator:</i> An employee of your organization who has access to the PeopleSoft Lease Administration system to enter or maintain a lease. A lease administrator or a lease entry clerk is an example of an internal administrator.</p> <p><i>Internal Manager:</i> A manager of your organization who has access to the PeopleSoft Lease Administration system to validate a lease. A portfolio manager is an example of an internal manager.</p> <p><i>Lease Principal:</i> A landlord or tenant for a lease.</p>

## Defining Lease Administration Roles

To define lease administration roles, use the Lease Administration Roles component (RE\_LA\_ROLES).



This topic provides an overview of lease administration roles and discusses how to define lease administration roles.

## Page Used to Define Lease Administration Roles

<i>Page Name</i>	<i>Definition Name</i>	<i>Usage</i>
<a href="#">Lease Administration Roles Page</a>	RE_LA_ROLES	Define a lease administration role.

## Understanding Lease Administration Roles

Lease administration roles enable you to associate individuals in your organization with a particular role type within the PeopleSoft Lease Administration system. You can associate multiple individuals in your organization with one role type. For example, several individuals may be able to create and maintain a lease. By assigning a role type of *Lease Administrator* to each of them, each individual can perform the tasks associated with a lease administrator.

---

**Note:** You must set up role types before you set up lease administration roles.

---

## Lease Administration Roles Page

Use the Lease Administration Roles page (RE\_LA\_ROLES) to define a lease administration role.

Navigation:

**Set Up Financials/Supply Chain > Product Related > Lease Administration > Users Roles > Lease Administration Role**

<i>Field or Control</i>	<i>Description</i>
<b>User ID</b>	Select the User ID of the individual in your organization who generates a transaction.
<b>Role Name</b>	Displays the long description from the Role Types page.
<b>Approve Transaction</b>	Select to allow the user to approve transactions for payables, put them on hold, unhold them or cancel them on the Payment Transactions page. If you do not select this option, those buttons will be unavailable for clicking and users will not be able to approve any transaction in the Transaction Queue Manager.
<b>Create Transaction</b>	Select to allow the user to create payables manual fees and to update selected manual fees on the Payment Transactions page. If you do not select this option, those buttons will be unavailable for clicking. If this option is not selected, the user will not be able to create any manual transactions.

---

**Note:** If you inactivate a lease administration role, the user will no longer be able to be added to the Create Lease page. If this user is already added on a lease, it will remain unchanged, but they will not be able to add this user to another lease.

---

# Generating Site Acquisition Requests

---

## Understanding Site Acquisition Request Generation

The typical flow to generate a site acquisition request (SAR) is:

1. The project manager (PM), after approving that a new site acquisition project be undertaken, assigns team members to execute the project.
2. The PM or Real Estate Specialist creates a new SAR and enters beginning data.
3. After sufficient SAR data is entered, a Specialist attempts to activate the SAR.
  - If a Specialist does not have the appropriate security level to activate the SAR, then she or he can only validate and correct errors; she will need to submit the SAR to the PM for activation.
  - If a Specialist has the appropriate security level to activate the SAR, then he can do so immediately.

After activation, a SAR is still open for editing. Users can add to or delete sites from the SAR until the approval submission stage, when the final list of candidates is selected.

4. During finalization, a user can create an asset in Asset Management, a lease with basic information in Lease Administration, and a project with basic information in Project Costing.

Any data that can be transferred from the site record (in the site repository) or from the SAR is copied to the asset definition, lease, or project.

### Comparison Matrix

After a SAR is Active, the user can check which sites in the Comparison Matrix are proposed as finalists. The list of sites populates the columns, and the attributes populate the rows. The user can rate each attribute on a scale of 1 to 5; 1 being the least suitable and 5 being the most suitable. After the user enters the ratings for all the attributes, the system calculates the most suitable site by multiplying the score with the weighting for that row, and then summing the attributes for each site (total score). Each grid (category) lists an individual total as well as a final summarization box at the bottom of the page providing grand totals.

The system calculates a total possible score for each grid. Essentially, this value is the sum of all the fields in the grid with the weighting value multiplied by 5 (the highest score possible for each attribute).

### SAR Submission and Approval Processing

The approval step allows the project team to proceed with acquiring the sites under consideration based on rankings in the Comparison Matrix. You use the Approval Workflow Engine for this approval, and you can configure it to require one or many approvers based on customer needs. Both the PM and the individual selected as the Requestor/Approver can approve the SAR for acquisition.

After the finalists are researched and documented, you can adjust the rankings of the sites to be acquired in order to identify the final order. Based on the Adjusted Ranking and the comments field below it, the Approver can identify the order in which the sites are to be acquired and whether the team should acquire one or all of the sites.

All fields at the Evaluating Finalists status remain open for editing. In addition, the Approver can override the finalists proposed by the submitter.

## Finalization of Sites Acquired

After sites are selected for acquisition, the project team attempts final negotiations and acquires one or many sites, as defined in the SAR. The negotiation and final acquisition processes occur outside the system. When confirmation is received that a site or sites were actually acquired, then the finalization process takes place.

When you click the **Confirm and Finalize Acquisition** button, the following actions are triggered:

- The status of the acquired sites changes to *Operating*.
- The status of the SAR changes to *Finalized*.
- The actual completion date is updated to the current date.
- The duration changes to reflect the new duration based on the change in the actual completion date.
- If you select to create an asset, it is created in PeopleSoft Asset Management with the Asset Type of Property and the Property Class of Site. The system copies the asset description and name from the Site. The Asset ID created appears on the integration tab of the Comparison Matrix.
- If you select to create a lease, the system validates that the asset was created before the lease was created. The lease is created with the basic information at a *Pending* status. The site acquired is populated in the property details.

If a lease is to be created, you must provide the Lease Commencement date, Termination date, and the Lease Obligation date.

- If you select to create a project, the system uses the project template defined at setup to define a basic project shell with activities and resources.

---

## Uploading Sites Under Consideration

To upload sites under consideration, use the Excel to CI utility. Users are provided with a template to fill in the Site data. The upload process is similar to any Excel to CI run. If Supplemental data is being uploaded, then users must know which database field maps to which Supplemental data field. For example, in the sample data provided, the Airport Distance field maps to the SD\_NUM9\_1 database field. You define this mapping under Site Supplemental Data, Define Record.

---

## Generating Site Acquisition Requests

This topic discusses how to generate site acquisition requests.

## Pages Used to Generate Site Acquisition Requests

<i>Page Name</i>	<i>Definition Name</i>	<i>Usage</i>
<u>SAR Details Page</u>	RE_SAR	Enter SAR detail information
<u>Comparison Matrix Page</u>	RE_SAR_METRICS	View the comparison matrix.
<u>Options and Critical Dates Page</u>	RE_SAR_OPTIONS	Enter options and critical dates.
<u>Critical Dates Details Page</u>	RE_SAR_CRDT_DTL	Enter schedule details and recipient information for critical date notifications.
SAR Notes	RE_SAR_NOTES	Add notes to the SAR.
<u>SAR Analytic Page</u>	RE_SAR_ANALYTIC	View the SAR analytic graphic.
SAR Contact	RE_SAR_CONTACT	Add contacts to the request.
Search For Contacts	RE_CNCT_SRCH	Search for contacts to add to the request.

### SAR Details Page

Use the SAR Details page (RE\_SAR) to enter SAR detail information.

Navigation:

**Lease Administration > Site Acquisition > Site Acquisition Request(s) > SAR Details**

This example illustrates the fields and controls on the SAR Details page. You can find definitions for the fields and controls later on this page.

SAR Details
Comparison Matrix
Options and Critical Dates
SAR Notes
SAR Analytic
SAR Contact

<b>Unit</b> US001	<b>Status</b> Evaluating Finalists	
<b>SAR ID</b> 000000000000001	<b>Site Type</b> Residential	<b>Site Acquisition Request Name</b> SAR with 2 Sites

**Comments**

Residential Sites Acquisition

<p><b>Timetable</b> ?</p> <table style="width: 100%; border-collapse: collapse;"> <tr> <td style="text-align: right;"><b>Commencement</b></td> <td>01/01/2007</td> <td style="text-align: right;"><b>Duration:</b></td> <td></td> </tr> <tr> <td style="text-align: right;"><b>Estimated Completion</b></td> <td>12/31/2008</td> <td style="text-align: right;">730</td> <td>Day(s)</td> </tr> <tr> <td style="text-align: right;"><b>Actual Completion</b></td> <td></td> <td></td> <td></td> </tr> </table>	<b>Commencement</b>	01/01/2007	<b>Duration:</b>		<b>Estimated Completion</b>	12/31/2008	730	Day(s)	<b>Actual Completion</b>				<p><b>Primary Contacts</b></p> <table style="width: 100%; border-collapse: collapse;"> <tr> <td style="text-align: right;"><b>Real Estate Specialist</b></td> <td>Kenneth Schumacher</td> </tr> <tr> <td style="text-align: right;"><b>Portfolio Manager</b></td> <td>Kenneth Schumacher</td> </tr> </table>	<b>Real Estate Specialist</b>	Kenneth Schumacher	<b>Portfolio Manager</b>	Kenneth Schumacher
<b>Commencement</b>	01/01/2007	<b>Duration:</b>															
<b>Estimated Completion</b>	12/31/2008	730	Day(s)														
<b>Actual Completion</b>																	
<b>Real Estate Specialist</b>	Kenneth Schumacher																
<b>Portfolio Manager</b>	Kenneth Schumacher																

**Site Under Consideration**

Add Site

<b>Site List</b> ?	Personalize   Find   View All	First 1-2 of 2 Last			
Site Name	Site Status	Address 1	Property Owner	Offered By	Availability Date
Site-11	Negotiating	Whitefield	SCHUMACHER	SMITH	12/31/2008
Site-12	Negotiating	Whitefield	SCHUMACHER	SMITH	12/31/2008

<b>Created By</b> Theresa Monroe <b>Created On</b> 05/11/2009 10:14:02PM	<b>Last Updated By</b> Theresa Monroe <b>Last Updated On</b> 05/11/2009 10:15:26PM
---	---

<b>Field or Control</b>	<b>Description</b>
<b>Action</b>	<p>After completing the SAR, select the appropriate action:</p> <ul style="list-style-type: none"> <li>• <i>Activate SAR</i>: If you have the security ability to activate, then do so. Otherwise, an appropriate user must open the SAR, review the data, and activate the SAR. The status of the SAR will change to Active. The SAR can still be edited. All the Sites attached to the SAR will be in the Evaluating state. This action is only available for SARs in a <i>Pending</i> status.</li> <li>• <i>Submit for Approval</i>: Change the SAR status to Evaluating Finalists. Submit the SAR for approval. Make the SAR read—only. This action is available only for SARs in an <i>Active</i> status.</li> <li>• <i>Approve SAR</i>: Change the status to Sites Selected. This action is available only for SARs in an <i>Evaluating Finalists</i> status.</li> <li>• <i>Cancel SAR</i>: Change the status back to Active. This action is available only for SARs in an <i>Evaluating Finalists</i> status.</li> <li>• <i>Validate SAR</i>: Check for all required fields before activating a SAR. This action is available only for SARs in a <i>Pending</i> status.</li> <li>• <i>Finalize SAR</i>: Close the SAR and confirm the sites were acquired. This finalization process creates assets, leases, projects, and so on. Change the status of the site to Operating, and the SAR status to Finalized. This action is available only for SARs in a <i>Site(s) Selected</i> status.</li> </ul>

<b>Field or Control</b>	<b>Description</b>
<b>Status</b>	<p>Displays the current status of the SAR. Values are:</p> <ul style="list-style-type: none"> <li>• <i>Pending</i>: Newly created SARs have this status. You can save the SAR at this point without any validation. The validation of the data entered will be done when the SAR is validated or when the SAR is activated.</li> <li>• <i>Active</i>: At least one site must be attached to the SAR in order to become <i>Active</i>. The SAR is editable even after activation.</li> <li>• <i>Evaluating Finalists</i>: The SAR will be in this status after it is submitted for approval with a smaller subset of candidates for further negotiation, analysis, and so on. Data can still be modified by the approver before approval or denial. A denial will return the SAR to an <i>Active</i> status so that it can continue to be modified by the submitter. The approver can enter comments before denial so the submitter knows what additional information is needed.</li> <li>• <i>Site(s) Selected</i>: SARs have this status when the SAR is approved for acquiring the sites. The site status changes to <i>Negotiating</i>.</li> <li>• <i>Finalized</i>: SARs have this status when the finalization process has run. The site acquired status changes to <i>Operating</i>. Any sites in an <i>Evaluating</i> or <i>Negotiating</i> status on this SAR change back to <i>Open</i> or <i>Archive</i> (based on previous history) unless they are under evaluation or negotiation on another SAR.</li> </ul>
<b>Site Acquisition Request Name</b>	Enter a unique name for this request.
<b>Commencement</b>	Enter the commencement date of the site acquisition process. This field is required.
<b>Estimated Completion</b>	Enter the date you anticipate this request will be complete. This date must be later than the commencement date.
<b>Real Estate Specialist</b>	Select the real estate specialist assigned to this request.
<b>Portfolio Manager</b>	Select the portfolio manager assigned to this request.
<b>Add Site</b>	Click this button to insert a new row and add more sites to the <b>Sites Under Consideration</b> grid. You can add up to 50 sites to each request. Users can select any sites from the Site Repository that are not in a <i>New</i> or <i>Operating</i> status. At least one site must be attached to the SAR to activate it.
<b>Site Name</b>	Select the sites you want to consider for this request.



# Comparison Matrix Page

Use the Comparison Matrix page (RE\_SAR\_METRICS) to view the comparison matrix.

Navigation:

**Lease Administration > Site Acquisition > Site Acquisition Request(s) > Comparison Matrix**

This example illustrates the fields and controls on the Comparison Matrix page (1 of 2). You can find definitions for the fields and controls later on this page.

SAR Details	Comparison Matrix	Options and Critical Dates	SAR Notes	SAR Analytic	SAR Contact
Unit US001	Status Evaluating Finalists				
SAR ID 000000000000001	Site Type Residential	Site Acquisition Request Name SAR with 2 Sites			
<p>You can assign a score (1 through 5, 5 being best) for each of the site comparison data fields below. The individual scores, combined with the Weighting listed for each field(defined at Setup), will determine a total score summarized at bottom, with a rank listed based on the highest to lowest scores. The approver will be able to specify their own ranking irrespective of the system-generated totals, which should be considered a desired override of the score-based rankings.</p>					
<b>General Attributes</b> ?					
Attributes	Weighting	Site 000000000000015 Site-11	Rating	Site 000000000000016 Site-12	Rating
Site Name	1.00	Site-11	2	Site-12	4
Offered By	1.00	SMITH	3	SMITH	3
Property Owner	1.00	SCHUMACHER	1	SCHUMACHER	1
<b>Total Score for General Attributes:</b>	<b>15.00 (Possible)</b>		<b>6.00</b>		<b>8.00</b>
<b>Location Attributes</b>					
Attributes	Weighting	Site 000000000000015 Site-11	Rating	Site 000000000000016 Site-12	Rating
Address Line 1	1.00	Whitefield	3	Whitefield	3
Location Rating	1.00	Good	4	Good	1
Location Type	1.00	R3	1	R3	5
<b>Total Score for Location Attributes:</b>	<b>15.00 (Possible)</b>		<b>8.00</b>		<b>9.00</b>
<b>Maintenance Attributes</b>					
Attributes	Weighting	Site 000000000000015 Site-11	Rating	Site 000000000000016 Site-12	Rating
Construction Year	1.00	2005	2	2005	1
Property Age	1.00	36	2	36	3
Property Condition	1.00	Excellent	1	Excellent	4
<b>Total Score for Maintenance Attributes:</b>	<b>15.00 (Possible)</b>		<b>5.00</b>		<b>8.00</b>
<b>Physical Attributes</b>					
Attributes	Weighting	Site 000000000000015 Site-11	Rating	Site 000000000000016 Site-12	Rating
No. of Floors	1.00	2	3	2	1
Maximum Occupancy	1.00	5	5	5	2
Total Area	1.00	1600	1	1600	1
<b>Total Score for Physical Attributes:</b>	<b>15.00 (Possible)</b>		<b>9.00</b>		<b>4.00</b>

This example illustrates the fields and controls on the Comparison Matrix page (2 of 2). You can find definitions for the fields and controls later on this page.

Schedule Attributes					
Attributes	Weighting	Site 0000000000000015 Site-11	Rating	Site 0000000000000016 Site-12	Rating
Availability Date	1.00	2008-12-31	5	2008-12-31	1
Occupancy Date	1.00	2009-01-11	1	2009-01-11	4
Signed Date	1.00		1		1
Total Score for Schedule Attributes:		15.00 (Possible)	7.00		6.00
Value Attributes					
Attributes	Weighting	Site 0000000000000015 Site-11	Rating	Site 0000000000000016 Site-12	Rating
Annual Operating Expenses	1.00	10000	1	10000	1
Deposit Amount	1.00	100000	4	100000	3
Rent Amount	1.00	10000	5	10000	1
Total Score for Value Attributes:		15.00 (Possible)	10.00		5.00
Supplemental Attributes					
Attributes	Weighting	Site 0000000000000015 Site-11	Rating	Site 0000000000000016 Site-12	Rating
Airport Distance	1.00	2	2	1	1
School Distance	1.00	2	1	1	2
Total Score for Supplemental Attributes:		10.00 (Possible)	3.00		3.00
Calculate					
Site Comparison Matrix Grand Total Score (Weighted):			48.00		43.00
Total Points Possible (Weighted):		100.00			
Overall Rank (Score Based):			1		2
Select Site Acquisition Finalist(s):			<input checked="" type="checkbox"/>		<input checked="" type="checkbox"/>

The **Comparison Matrix** grid displays all of the generic and supplemental fields defined for a site. The attributes appear in individual grids categorized based on functionality, as they were defined in the site repository. The categories and individual grids are:

- Location Details
- Physical Attributes
- Site Value
- Operation/Maintenance
- Schedule
- Supplemental Data

The site comparison matrix displays all the sites and the attributes for the given SAR in the form of multiple grids, categorized according to the Site Repository component. Any fields that are defined in Supplemental Data will appear in the Comparison Matrix, regardless of site type.

You can assign a score (1 through 5, 5 being the best) for each of the site comparison data fields. The individual scores, combined with the weighting listed for each field (defined at setup), determine a total score summarized at the bottom, with a rank listed based on the highest to lowest scores. The approver can specify their own rankings, which override system-generated, score-based rankings.

Although you are required to set up the weightings and field selection by site type page, the use of the weightings to generate the scores is optional. If you do not assign weightings, then the default weighting value for all fields is 1.0, which essentially means no additional weight.

The **Calculate** button sums all of the weighted ratings and alters the **Overall Rank** field based on the score attained by each site. The site with the maximum rating usually is the site best suited for acquisition. However, the **Adjusted Rank** field is open to the approver or PM for override of the order with which the sites should be pursued, despite the scoring that generated the system rank.

Comments can be entered against each row, as well as in a large comments box at the bottom of the page.

<b>Field or Control</b>	<b>Description</b>
<b>Weighting</b>	Displays the weighting assigned when setting up the site attributes.
<b>Rating</b>	Select a rating for each attribute.
<b>Calculate</b>	Click this button to recalculate the scores based on the rankings entered in the <b>Rating</b> fields.
<b>Activate Site Acquisition Request</b>	When the SAR is in a Pending state, all of the data fields are open and this button is available. This button duplicates the Activate functionality in the <b>Action</b> drop-down list box on the SAR Details page.
<b>Overall Rank (Score Based)</b>	Displays the ranking of each site based on this system calculation: the weighting × the rating + the value for each attribute
<b>Select Site Acquisition Finalists</b>	Select the check box under the appropriate sites to select these sites as finalists for review. While in a <i>Pending</i> status, you cannot update which sites should be finalists.

## Options and Critical Dates Page

Use the Options and Critical Dates page (RE\_SAR\_OPTIONS) to enter options and critical dates.

Navigation:

**Lease Administration > Site Acquisition > Site Acquisition Request(s) > Options and Critical Dates**

This example illustrates the fields and controls on the Options and Critical Dates page. You can find definitions for the fields and controls later on this page.

<b>Field or Control</b>	<b>Description</b>
<b>Add Option</b>	Click this button to insert a new row and add another option to this request.  <b>Note:</b> You must complete the <b>Option Date</b> and <b>Option Name</b> fields before you can insert a new row.
<b>Apply Template</b>	Click this button to apply a predefined critical date template to the page. Option and critical date information within the template is copied into the SAR.
<b>Option Date</b>	Enter the date that this option occurs or expires. The date that you enter must occur on or after the current date and cannot occur before the commencement date. This field is required.
<b>Option Name</b>	Select the option for which you want to establish a critical date.
<b>Option Status</b>	Displays the status of the option. The values are: <ul style="list-style-type: none"> <li><i>Inactive</i>: The critical date schedule for the option is inactive.</li> <li><i>Active</i>: Critical date notifications are processed when you run the critical date notification process. The options becomes active after you enable notifications on the Options and Critical Dates - Critical Date Detail page.</li> </ul>

## Critical Dates Details Page

Access the Critical Dates Details page (click the **Critical Date** icon on the Options and Critical dates page).

This example illustrates the fields and controls on the Critical Dates Details page. You can find definitions for the fields and controls later on this page.

<b>Field or Control</b>	<b>Description</b>
<b>Option Name</b>	Select the option for which you want to establish for a critical date. This field is required.
<b>Option Date</b>	Enter the date that this option occurs or expires. The date that you enter must occur on or after the current date and cannot occur before the site commencement date. This field is required.
<b>Message Text</b>	Enter the text to insert into the email notification.

<i>Field or Control</i>	<i>Description</i>
<b>Email Text</b>	Click to display a sample of the email content that is generated and sent to recipients. You cannot edit the email text from this view. The email text is specified when you define the option during setup. You may, however, tailor the <b>Message Text</b> field to customize the message for a specific request.

### Schedule Details

<i>Field or Control</i>	<i>Description</i>
<b>Enable Notifications</b>	Select to enable email notifications.
<b>Send initial notification</b>	<p>Select the option for sending initial notifications. Critical date notifications operate within a date range. The options in this group determine the timing of the start date. Options include:</p> <p><b>Prior to Option Date:</b> Use this option to begin notifications on a specific number of days, months, or years before the option date.</p> <p><b>On the Lease Start Date:</b> Use this option to begin sending notifications from the request <b>Commencement Date</b> field that is specified on the SAR Details page.</p> <p><b>On a Specific Date:</b> Use this option to begin sending notifications on a specific date. The date that you select must precede the option date.</p>

### Recurring - Send Recurring Notifications

<i>Field or Control</i>	<i>Description</i>
<b>Never</b>	Use this option if the notification is not recurring. For example, only one notification is sent on the date that is specified by selecting <b>Send Initial Notification</b> .
<b>Daily</b>	Select this option to generate notifications daily. For example, setting the number value to 1 generates a notification every day from the initial notification until the option date occurs.

<b>Field or Control</b>	<b>Description</b>
<b>Weekly</b>	Select this option to generate notifications weekly or at regular intervals on specific days of the week. For example, specify a value of 2 and select <i>Mon</i> and <i>Wed</i> for the system to generate notifications on Mondays and Wednesdays, every other week, between the start date and the option date.
<b>Monthly</b>	Select this option to generate notifications every month on a specific day of the month. For example, you can generate a notification every three months on the 31st day of the month between the start date and the option date. If you select the 29th, 30th, or 31st and the notification date occurs within a month that has fewer days, then the notification is sent on the last day of the month.
<b>Yearly</b>	Select this option to generate notifications annually on a specific day within a specific month. For example, you can generate notifications every two years on June 30.

## Recipients

This section enables you to specify the interested parties to whom critical date notifications are sent. The recipient list is role based. Notifications are sent only when a specific person is assigned to that role within the context of the site.

You use the Contacts section of the request to specify the roles and specific users who are assigned to those roles. You can select a role to which no one is currently assigned; however, no notification is actually sent. Conversely, if someone is assigned to that role and they are removed from the contact list, the system displays the role as the recipient; however, the person assigned to the role no longer exists and no notification is generated.

See [Understanding Lease Administration Contacts](#).

<b>Field or Control</b>	<b>Description</b>
<b>Role Name</b>	Select the role for whom you want to receive notifications. You can select from any of the predefined Lease Administration roles. If no one is assigned to this role, then the <b>Name</b> field is blank.

<b>Field or Control</b>	<b>Description</b>
<b>Email Notify</b>	<p>Indicates that email notifications are sent to the roles that are defined.</p> <hr/> <p><b>Note:</b> This field does not indicate whether the recipient's email address is configured correctly. The system assumes that all email recipients are able to receive mail.</p>

## SAR Analytic Page

Use the SAR Analytic page (RE\_SAR\_ANALYTIC) to view the SAR analytic graphic.

Navigation:

**Lease Administration > Site Acquisition > Site Acquisition Request(s) > SAR Analytic**

This example illustrates the fields and controls on the SAR Analytic page. You can find definitions for the fields and controls later on this page.

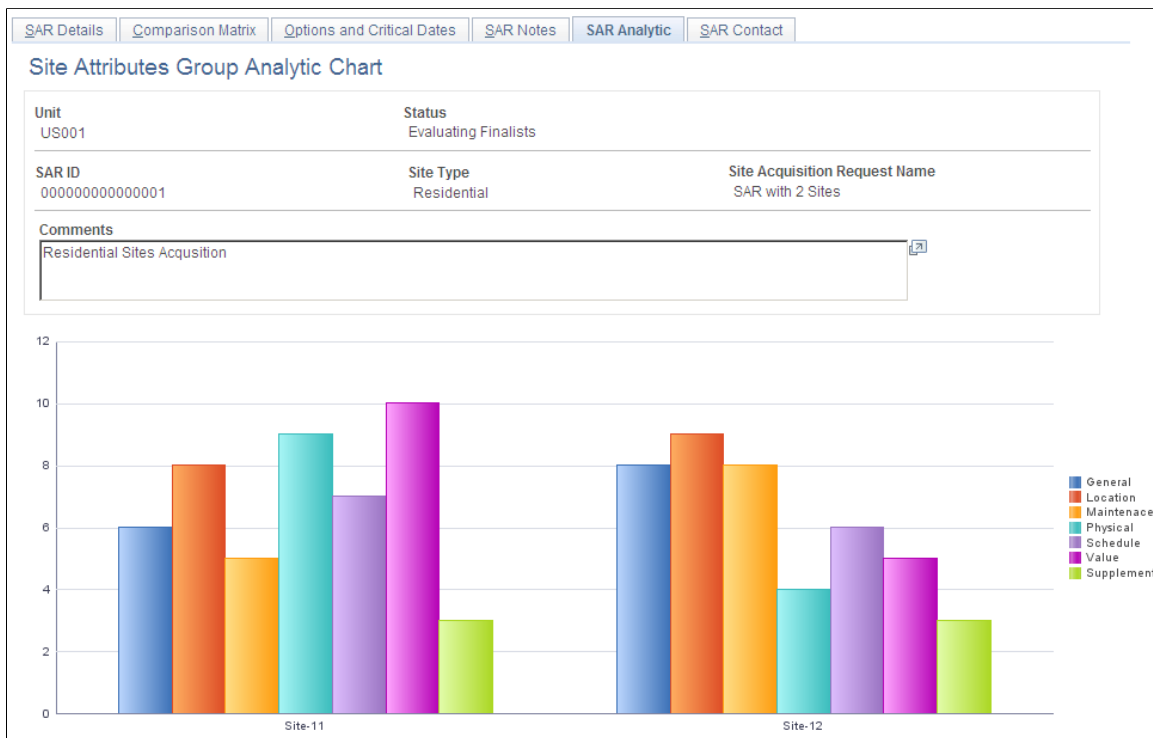

This analytic is a graphical display of the sites and their respective total scores for each section of the Comparison Matrix.

## Approving Site Acquisition Requests

This topic discusses how to approve site acquisition requests.



## Pages Used to Approve SARs

<i>Page Name</i>	<i>Definition Name</i>	<i>Usage</i>
<u>Manage SAR Approval Page</u>	RE_SAR_MANAGE_APPR	Manage the approval of SARs.
<u>Site Acquisition Request Approval Page</u>	RE_SAR_APPR	Approve or deny SARs.

## Manage SAR Approval Page

Use the Manage SAR Approval page (RE\_SAR\_MANAGE\_APPR) to manage the approval of SARs.

Navigation:

**Lease Administration > Site Acquisition > Manage SAR Approval**

This example illustrates the fields and controls on the Manage SAR Approval page. You can find definitions for the fields and controls later on this page.

<i>Field or Control</i>	<i>Description</i>
<b>SAR ID</b>	Enter the SAR ID to search for a specific request.
<b>Site Type</b>	Enter a site type to search for requests with specific site types.
<b>Search</b>	Select the requests you want to search for: <ul style="list-style-type: none"> <li>• <b>Pending My Approval</b></li> <li>• <b>Approved By Me</b></li> <li>• <b>Denied By Me</b></li> </ul>
<b>SAR ID</b>	Click a SAR ID to access the Site Acquisition Request Approval page to add ratings and approve or deny a SAR.

## Site Acquisition Request Approval Page

Use the Site Acquisition Request Approval page (RE\_SAR\_APPR) to approve or deny SARs.

Navigation:

**Lease Administration > Site Acquisition > Manage SAR Approval**

Click a **SAR ID** on the Manage SAR Approval page.

The approver can add his or her own ratings and then view the Comparison Matrix with these new ratings applied. The ratings entered here update the values in the SAR. The ratings fields become read-only after the SAR is approved.

<i>Field or Control</i>	<i>Description</i>
<b>Select Site Acquisition Finalists</b>	Select check boxes to select one or more sites as finalists.
<b>Adjusted Rank (Approver Selected)</b>	Approvers can change the ranks manually for each site.
<b>Approve</b>	Click this button to approve this SAR. The SAR will be in an approved status and a user with appropriate access will finalize the property selection.
<b>Deny</b>	Click this button to deny this request and send it back to the creator. You can enter comments that will help explain the updates needed to approve this request.
<b>Approval Map</b>	This group box displays a graphical map of the approval process. You can click links to view more information about the persons assigned to the request or send emails requesting information.

---

## Finalizing Site Acquisition Requests

This topic discusses how to finalize SARs and create assets, leases, or projects from sites.

### Page Used to Finalize Site Acquisition Requests

<i>Page Name</i>	<i>Definition Name</i>	<i>Usage</i>
<u>Finalize Site(s) Acquired Page</u>	RE_SAR_FINALIZE	Finalize SARs and create assets, leases, or projects from sites.

## Finalize Site(s) Acquired Page

Use the Finalize Site(s) Acquired page (RE\_SAR\_FINALIZE) to finalize SARs and create assets, leases, or projects from sites.

Navigation:

**Lease Administration > Site Acquisition > Manage SAR Approval**

Click a SAR ID on the Manage SAR Approval page.

This example illustrates the fields and controls on the Finalize Site(s) Acquired page. You can find definitions for the fields and controls later on this page.

### Finalize Site(s) Acquired

---

Unit: US001
Status: Finalised

---

SAR ID:  
000000000000003

Site Type:  
Corporate

Site Acquisition Request Name:  
Atlanta Sales Office Evaluation

---

Comments: [?]

---

#### Timetable

Commencement:	07/01/2009	Duration:	92 Day(s)
Estimated Completion:	10/01/2009		92 Day(s)
Actual Completion:	10/08/2009		99 Day(s)

#### Primary Contacts

Real Estate Specialist:	Kenneth Schumacher
Portfolio Manager:	Kenneth Schumacher

---

#### Site Finalists

Site List
Customize | Find | [?] | [?]
First 1-2 of 2 Last

Site List
Integration Details
[?]

Site Name	Site Status	Address 1	Finalist Ranking	Acquired	Acquisition Date
<a href="#">000000000000031 - Atlanta Main Street Office Park</a>	Negotiating	100 Main Street		<input type="checkbox"/>	
<a href="#">000000000000032 - PeachTree Office Park Atlanta</a>	Negotiating	900 PeachTree Street		<input checked="" type="checkbox"/>	10/08/2009

---

#### Integrations

<input checked="" type="checkbox"/> Create Asset	<input checked="" type="checkbox"/> Create Lease
<input checked="" type="checkbox"/> Create Project	

#### Lease Information

Commencement: 10/08/2009 [?]	<input checked="" type="radio"/> Payables Lease
Termination: 10/31/2009 [?]	<input type="radio"/> Receivables Lease

Confirm and Finalize Acquisition

**Note:** This page is visible only when a SAR is in a finalized status.

<i>Field or Control</i>	<i>Description</i>
<b>Acquired</b>	Select this check box to acquire this site.

<i><b>Field or Control</b></i>	<i><b>Description</b></i>
<b>Acquisition Date</b>	If you selected the <b>Acquired</b> check box, you must enter an acquisition date.
<b>Confirm and Finalize Acquisitions</b>	Click this button to finalize the request and have the system create the required IDs. At least one site must be selected as acquired and have a value in the <b>Acquisition Date</b> field before you click the <b>Confirm and Finalize Acquisition</b> button. Otherwise, the system displays an error.

## Integration Details

This tab displays the asset ID, project ID, or lease ID that the system created if you selected to have the system create these values before you clicked the **Confirm and Finalize Acquisition** button.

## Integrations

This group box enables you to create an asset, project, or lease ID from the acquired sites.

<i><b>Field or Control</b></i>	<i><b>Description</b></i>
<b>Create Asset, Create Lease, or Create Project</b>	Select one or all of these check boxes to enable the system to create the required IDs in the system.

## Chapter 10

# Creating Lease Abstracts

---

## Understanding Lease Abstracts

The lease abstract provides a method to capture and present lease information in a summarized, at-a-glance format. Because leases are usually lengthy and difficult to read, the lease abstract provides lease administrators with a short reference that is referred to more frequently. The sections printed vary by SetID and are based on the setup on the Lease Abstract component (RE\_ABST\_SECT). The layout of the lease abstract matches with the online entry flow of the lease in the system to assist with faster data entry (after the handwritten lease abstract worksheet is completed and is ready for input).

These are the two versions of lease abstracts:

- Lease abstract worksheet.
- Lease abstract.

A lease abstract worksheet is a blank template that you can print and use to record data from a paper lease. The lease abstract worksheet has fields and sections that are similar in order and logical grouping as in the Lease Maintenance component. This enables you to read the worksheet in a linear fashion and enter the information into the Lease Maintenance component. Although the lease abstract worksheet is meant to assist with the typical lease abstraction process done by lease administrators, it is an optional step and depends on the lease administration procedures or your organization.

The Lease Abstract page is a system-generated summary of the lease. After you enter a lease in the system, you can review the lease data by looking at the lease abstract. You can view the lease abstract online or print it for your records.

To transfer lease details from the lease to the PeopleSoft Lease Administration system, you perform these tasks:

1. Print the lease abstract worksheet.
2. Manually enter the lease information on the worksheet.
3. Use the lease abstract worksheet to enter lease information in the Lease Maintenance component.
4. Review the lease abstract on the Lease Abstract page.

---

## Prerequisites

Before you can print a lease abstract, you must first set up the sections to print in the lease abstracts for each SetID through the Lease Abstract setup component. For each SetID used in PeopleSoft Lease Administration, you can choose which sections appear on the lease abstract.

## Creating and Printing Lease Abstract Worksheets

This topic discusses how to print lease abstract worksheets.

The lease abstract worksheet provides you with spaces between fields to enable you to hand write lease information on the worksheet. The flow of the worksheet is designed so that you can quickly extract the information from a hard copy lease and input the data into the PeopleSoft Lease Administration system.

### Page Used to Create Lease Abstract Worksheets

<i>Page Name</i>	<i>Definition Name</i>	<i>Usage</i>
<u>Lease Abstract Worksheet Page</u>	RE_ABS_WRKSHEET	<p>Print a worksheet used to record lease information for entry in the PeopleSoft Lease Administration system.</p> <p>You can print the worksheet from your web browser. To maximize viewing and printing of the worksheets, you should use the user interface standard of 800 × 600 screen resolution.</p>

### Lease Abstract Worksheet Page

Use the Lease Abstract Worksheet page (RE\_ABS\_WRKSHEET) to print a worksheet used to record lease information for entry in the PeopleSoft Lease Administration system.

Navigation:

**Lease Administration > Reports > Lease Abstract Worksheet**

**Note:** These screen shots display the standard lease abstract worksheet with all options selected on the Lease Abstract setup page.

This example illustrates the fields and controls on the Lease Abstract Worksheet page (1 of 11).

### Lease Abstract Worksheet

#### General Information

Payables       Receivables  
 Business Unit US001  
 Lease Name \_\_\_\_\_ Lease Type \_\_\_\_\_  
 Lessor/Lessee \_\_\_\_\_  
 Location \_\_\_\_\_ Region \_\_\_\_\_

#### Lease Time Table

Commencement \_\_\_\_\_  
 Termination \_\_\_\_\_  
 Lease Signed \_\_\_\_\_

#### Lease Administration

Lease Administrator \_\_\_\_\_  
 Portfolio Manager \_\_\_\_\_  
 Parent Lease \_\_\_\_\_

#### Property Information

Unit of Measure \_\_\_\_\_

Property	Property Name	Total Area	Usable Area	Rentable Area	Occupancy Date

This example illustrates the fields and controls on the Lease Abstract Worksheet page (2 of 11).

### Financial Terms

#### Financial Summary

Lease Currency	Proration Method	Reference
Max Op. Ex. Increase/Year	Amount	Prorata Share
Max Lease Rent Escalation	Amount	Percent
<input type="checkbox"/> Exclude Base Year	Base Year	Base Year Amount

#### Schedule of Recurring Rent

Start Date	End Date	Financial Term	Rent Type	Amount	Schedule	Straightline	Description	Payor/Payee	Ship To

This example illustrates the fields and controls on the Lease Abstract Worksheet page (3 of 11).

### Base Rent

#### Escalation Details

Escalation Type				Base Index			
Start Date	Index	Escalation Amount	Calc Method	Min Amount	Max Amount	Min Percent	Max Percent

This example illustrates the fields and controls on the Lease Abstract Worksheet page (4 of 11).

### Operating Expenses

Agreement Number:

#### Operating Expense Details

<p>Prorata Share Method:</p> <p>Admin Fee Percentage:</p> <p><input type="checkbox"/> Exclude Base Year</p> <p style="margin-left: 20px;">Base Year:</p> <p style="margin-left: 20px;">Base Year Amount:</p> <p style="margin-left: 20px;">Base Year Percentage:</p>	<p>Admin Fee Method:</p> <p>CAP/MIN:</p> <p><input type="checkbox"/> Expense Gross Up</p> <p style="margin-left: 20px;">Gross Up Percentage:</p> <p style="margin-left: 20px;">Gross Up Method:</p>
--	---

#### Prorata Share Details - Basis

Prorata Basis	Tenant Area	Total Area	Floor Percentage



This example illustrates the fields and controls on the Lease Abstract Worksheet page (5 of 11).

### Caps/Minimum Details

CAP Applied To:	CAP Basis:
CAP Applied:	
Subsequent Year Cap	
Method:	Percentage:
Compare To:	Index Name:
Subsequent Year Minimum	
Method:	Percentage:
Compare To:	Index Name:

### Operating Expense Categories

Operating Expense	Estimated Amount	Min Amount	Max Amount	Total Administration Fee	Straightline

This example illustrates the fields and controls on the Lease Abstract Worksheet page (6 of 11).

## Miscellaneous Rent

### Escalation Details

Escalation Type		Base Index					
Start Date	Index	Escalation Amount	Calc Method	Min Amount	Max Amount	Min Percent	Max Percent

This example illustrates the fields and controls on the Lease Abstract Worksheet page (7 of 11).

### Security Deposits

Payor/Payee

Deposit Date	Deposit Type	Guarantor	Deposit Amount	Reference

This example illustrates the fields and controls on the Lease Abstract Worksheet page (8 of 11).

### Percent Rent

Sales Estimation Method	Minimum Fee	Reference
Sales Adjustment Factor	Maximum Fee	Payor/Payee
<input type="checkbox"/> Partial Year Proration	Calendar ID	Calculation Method

#### Lease Breakpoints

From Breakpoint	To Breakpoint	Amount	Percent

#### Sales Reporting Categories

Sales Category Name	From Breakpoint	To Breakpoint	Amount	Percent

This example illustrates the fields and controls on the Lease Abstract Worksheet page (9 of 11).

<b>Clauses</b>			
Clause Type	Clause Subtype	Description	Reference

This example illustrates the fields and controls on the Lease Abstract Worksheet page (10 of 11).

<b>User Defined Fields</b>	
Field Description	User Defined Value
Last Owner of the property	
Local Council for the Property	
Property Latitude	
Property Location	
Property Longitude	
Property Tax Authority	

This example illustrates the fields and controls on the Lease Abstract Worksheet page (11 of 11).

**Options and Critical Dates**

Option Date	Name	Description	Option Recipient	Schedule

---

**Contacts**

Name	Company	Role	Pref Communication	Phone	Fax	Email ID	Address

See [Defining Lease Abstract Sections to Print](#), [Create New Lease - General Information Page](#), [Create New Lease - Financial Terms Page](#), [Financial Terms - Base Rent Details Page](#), [Create New Lease - Clauses Page](#), [Financial Terms - Operating Expenses Details Page](#), [Financial Terms - Percent Rent Page](#), [Understanding Security Deposits](#), [Understanding Options and Critical Dates](#).

## Reviewing Lease Abstracts

This topic provides an overview of reviewing lease abstracts and discusses how to review lease abstracts.

### Page Used to Review Lease Abstracts

<i>Page Name</i>	<i>Definition Name</i>	<i>Usage</i>
<a href="#">Lease Abstract Page</a>	RE_SUMMARY_INQ	Displays a summary of the lease.

## Understanding Reviewing Lease Abstracts

PeopleSoft Lease Administration enables you to review the lease abstract in any lease status, including pending leases prior to activation. You can review the summary of the lease online or you can print a copy. This feature also enables you to view all the terms and conditions for typographical and miscellaneous errors in the lease before you activate it. Any changes to the terms and conditions of the lease, after it is activated, requires a lease amendment.

### Lease Abstract Page

Use the Lease Abstract page (RE\_SUMMARY\_INQ) to displays a summary of the lease.

Navigation:

- **Lease Administration > Payables Leases > Maintain Payables Lease**

Select *View Lease Abstract* in the **Action** field and click the **Go** button.

- **Lease Administration > Receivables Leases > Maintain Receivables Lease**

Select *View Lease Abstract* in the **Action** field and click the **Go** button.

- **Lease Administration > Reports > Lease Abstract**

---

**Note:** The screen shots display the lease abstract of a completed lease.

---

This example illustrates the fields and controls on the Lease Abstract page (1 of 7).

**Lease Abstract**  
**General Information**

Business Unit US001	Status Active
Payables Lease 000000011	Lease Name 9499 Sheridan Avenue
Lease Type Retail Location	Lessor Western Life and Annuity
Location HRMS	Region Northeast Sales
Address 435 Salvio St., Concord, CA, 94520, USA	
Commencement 08/01/2003	Termination 07/31/2013
Lease Signed 08/01/2003	Lease Term 10 years 0 months 0 days
Parent Lease	Remaining Term 0 years 0 months 0 days
Lease Administrator Jean-Patrick Martin	Portfolio Manager Kenneth Schumacher
Unit of Measure Square Feet	Prorata Share 22.150000

Property List					
Property	Property Name	Total Area	Usable Area	Rentable Area	Occupancy Date
	68 Space 1051	0.000	800.000	800.000	08/01/2003

**Primary Property**      Space 1051      Combined Total Area 800.000 Square Feet  
 56 Second Street      Combined Usable Area 800.000 Square Feet  
 Denver      Combined Rentable Area 800.000 Square Feet  
 United States



This example illustrates the fields and controls on the Lease Abstract page (4 of 7).

Clauses			
Clause Type	Sub Type	Description	Reference
Maintenance Clause		Landlord maintains all property in the Center other than the leased premises and Tenant pays its prorata share of the Center's CAM charges, including a 15% administrative fee. Increases of CAM Charges are capped at 10% per year.	
Assignment Clause		Assignment agreement from XYZ Investments, Inc, a Delaware Corporation, to Wings & Cheese.	
Go Dark Clause		Tenant may go "Go Dark" any time after the 5th Lease Year (leased commenced 10/15/98), for a period of 9 months. Tenant is required to pay base rent during any go dark period.	

This example illustrates the fields and controls on the Lease Abstract page (5 of 7).

User Defined Fields	
Field Description	User Defined Value
Last Owner of the property	
Local Council for the Property	
Property Latitude	
Property Location	
Property Longitude	
Property Tax Authority	

Options and Critical Dates					
Lease Options					
Option Date	Name	Option Status	Description	Message Text	Enabled
01/31/2013	1st Renewal Option	Active	1st Renewal Option	1st Renewal Option	<input type="checkbox"/>
01/31/2018	2nd Renewal Option	Active	2nd Renewal Option	2nd Renewal Option	<input type="checkbox"/>
01/31/2023	3rd Renewal Option	Active	3rd Renewal Option	3rd Renewal Option	<input type="checkbox"/>
07/31/2013	Right of First Refusal	Active	Right of First Refusal	Tenant has right of first refusal of purchase for \$2,054,950.	<input checked="" type="checkbox"/>

This example illustrates the fields and controls on the Lease Abstract page (6 of 7).

**Notes**

Title	Date	Description	Created By
Common Area (Definition)	07/01/2003	The part of the Center for the common use of all owners/tenants	Kenneth Schumacher
Misc. Charges	07/01/2003	Grand Opening Assessment: \$2,100.	Kenneth Schumacher
Special Notes	07/01/2003	Lot 18 and 1 shown on the Tract Map (34089) are owned by Mervyns. Lot 5 is owned by the Landlord. Lots 2 and 3 (consisting of a portion of the common area) are owned by the city and subleased to Landlord (Sublease dated 12/01/02).	Kenneth Schumacher

**Attachments**

File Name	Description	Created On	Created By	Updated On	Updated By

This example illustrates the fields and controls on the Lease Abstract page (7 of 7).

**Contacts**

**Supplier Contacts**

General | Address |

Contact Name	Role	Contact Type	Preferred	Email ID	Phone Type	Telephone	Extension

**Supplemental Contacts**

General | Address |

Name	Company Name	Role	Pref Comm	Telephone	Fax Number	Email ID

**Amendments**

Amendment	Amendment Type	Reason	Status	Activation Date
1	Properties on Leases have been changed	New property added to lease	Replaced	06/07/2006 9:56PM
2	Financial Terms Update	Adjusted Base Rent Amount	Replaced	06/09/2006 3:54AM
3	Correction	Data Entry Error	Active	07/07/2006 2:46AM



## Chapter 11

# Creating and Maintaining Leases

---

## Understanding Leases

PeopleSoft Lease Administration is an integrated solution that effectively manages the entire life cycle of equipment and corporate real estate leases, from lease execution and financial processing through lease expiration and termination.

A lease is an agreement between a lessee and a lessor that defines the terms of the rental. The lease is the basis for invoices or vouchers and receipts or payments. You create a lease to enable processing for an invoice or payment for recurring rent and operating expenses for that lease.

You can process everything from a single invoice or payment to the most complex recurring invoices or payments as required by the lease. You can perform cost allocations, rent escalations, and capacity planning for your organization, and establish critical date alerts to notify you when you must take action on or make a decision about a particular lease.

Before you create a lease, you must determine the type. There are two types of leases: payables leases and receivables leases. Your role—lessee or lessor—determines the type of lease that you create.

This section discusses:

- Payables leases.
- Receivables leases.

## Payables Leases

Payables leases enable a tenant (lessee) to manage and report on rent, operating expenses, and miscellaneous rents. Lease classification can be tested to determine if a lease should be treated as capital/finance or operating. You can set up recurring payment schedules to facilitate the lease. You can set up percent rent terms based on sales reported by tenant. You can capture specific lease clauses and lease options, and set up critical date alerts for important events related to the lease, such as lease expiration. You can also audit operating expenses, comparing with previous years to ensure continuity of spending. Select the *View Audit Log* action on the General Information page to view the search audit logs page, where users can review the audit log information for the leases.

---

**Note:** View Audit logs action is displayed only when at least one lease audit log event is enabled on the Enable Audit Logging page (Set Up Financials/ Supply Chain, Common Definitions, Audit Logging, Enable Audit Logging).

---

You create a payables lease when your organization is the tenant (or lessee) and you are issuing rent payments to a landlord (or lessor) for space or equipment that you are using. You enter the lease terms from your signed lease agreement as a payables lease and set it up for payment processing through PeopleSoft Payables. As a result, the majority of your transactions are payables transactions or payments that you are issuing through PeopleSoft Payables to be paid to your lessor.

When you enter the lease, you can establish recurring rent payments that the system processes on a periodic basis of your choosing. When processing rent payments, the system generates transactions with PeopleSoft Payables as the transaction destination. Even manual payments, which include ad-hoc entries, security deposits, operating expense audits, and percent rent sales reports, can be sent through PeopleSoft Payables with their associated accounting ChartFields, as determined by the transaction routing code and accounting rule setup. You can also send through PeopleSoft Payables (first as a negative reversal entry of the originating transaction and then as a new entry for the revised payment amount) any adjustment entries caused by changes in security deposits, operating expense audit adjustments, or percent rent sales reports.

Payables leases allow you to capture clause-specific user-defined fields, notes, attachments, and supplemental data.

For payables leases, the integration points to consider for processing are PeopleSoft General Ledger (for straightline accounting), Payables, and Asset Management (for the Asset Repository). Since PeopleSoft Billing integration is not needed for payables leases, any adjustment transactions are sent through PeopleSoft Payables as negative voucher entries.

See [Transaction Routing Codes Page](#).

See [Understanding PeopleSoft Lease Administration Accounting Rules](#).

See “Setting Up Financials Audit Framework (Audit Logging)” (Application Fundamentals)

## Receivables Leases

Corporate lease administration sometimes requires landlord billing capabilities for leasing owned property and subleasing leased property. Accounting for all costs and lease income associated with lease management is critical to a landlord (lessor). Receivables leases enable you to collect rent, manage your expenditures, and allocate them proportionately to the departments or other entities.

When you create a receivables lease, you set up recurring invoices that generate automatically in the frequency defined in the lease. You can track lease clauses and options, and set up critical dates to remind you of important events related to the lease, such as lease expiration. You can also set up simple to complex rent terms, track percent rent schedules, and upload percent rent sales reports to determine the percent increase to bill for monthly rent.

You create a receivables lease when your organization is the landlord (or lessor) and you are submitting rent bills to a tenant (or lessee). For a receivables lease, you enter the lease terms from your signed lease agreements and set up the terms for processing as the landlord. As a result, the majority of your transactions are billing transactions or bills that you are issuing through PeopleSoft Billing to your tenant.

When entering the lease, you can establish recurring rent bills that the system processes on a periodic basis of your choosing. When processing rent invoices, the system generates transactions with PeopleSoft Billing as the transaction destination. Even manual bills, which include ad hoc entries, security deposits, operating expense reconciliations, and percent rent sales reports, are sent through PeopleSoft Billing with their associated accounting ChartFields, as determined by the transaction routing code and accounting rule setup. You can also send through PeopleSoft Billing (first as a negative reversal entry of the originating transaction and then as a new entry for the revised payment amount) any adjustment entries caused by changes in security deposits, operating expense audit adjustments, or percent rent sales reports.

Security deposit refund processing, which is available on receivables lease processing (outside of the lease component) can potentially divert the security deposit refund to PeopleSoft Payables if, during

lease expiration, the refund has not been depleted by sufficient deductions to cover the remaining amount outstanding and money is owed back to the tenant.

Receivables leases also allow you to capture clause-specific user-defined fields, notes, attachments, and supplemental data.

For Receivables leases, the integration points to consider for processing are PeopleSoft General Ledger (for straightline accounting), Billing, and Asset Management (for the Asset Repository). Although, for the most part, any adjustment transactions are sent through PeopleSoft Billing as negative invoice lines, a PeopleSoft Payables integration is also available (and potentially necessary) to handle security deposit refund processing during lease expiration.

See [Understanding Transaction Routing Codes](#).

See [Understanding PeopleSoft Lease Administration Accounting Rules](#).

## Process Flow Overview for Creating a Lease

The high-level business process flow for creating a lease consists of these steps:

1. Define the general lease information.
2. Enter the lease timetable and lease administration information.
3. Add the property information.
4. Define the financial terms of a lease.
5. Add base rent.
6. Add the operating expenses.
7. Add miscellaneous rent.
8. Allocate total lease payments across assets (multi-asset leases).
9. Define percent rent information.
10. Enter security deposits.
11. Add lease clauses.
12. Establish options and set critical dates.
13. Add and attach pertinent notes.
14. Define internal and external contacts for the lease.
15. Validate and activate lease.

See [Establishing Operating Expenses for a Lease](#), [Setting Up Percent Rent Terms](#), [Setting Up Security Deposits](#), [Setting Up Options and Critical Dates](#), [Understanding Lease Administration Contacts](#).

---

## Prerequisites

Before creating leases, you must:

- Set up schedules and calendar IDs.
- Structure lease component setup.
- Set up supplier and customer (landlord and tenant)

See “Entering Supplier Identifying Information” (PeopleSoft Source to Settle Common Information)

### Related Links

[Understanding Leases](#)

---

## Common Elements Used in Leases

<i>Field or Control</i>	<i>Description</i>
<b>Commencement</b>	Enter the begin date that the lease goes into effect.

<b>Field or Control</b>	<b>Description</b>
<p><b>Lease Actions</b></p>	<p>A lease can change significantly throughout the course of its typically long life cycle. With the Lease Administration feature, you can change the lease status throughout this life cycle using lease actions within the lease component. The list of available actions changes based on the current state of the lease and what can be processed against the lease. For example, you can put an active lease into a dispute status if there is a dispute between the landlord and tenant. If a lease is in dispute, you can hold it from any financial processing. Any transactions in the transaction queue is also put on hold. When the dispute is resolved, you must manually approve the transactions put on hold to enable processing.</p> <p>Select from the list of values below:</p> <ul style="list-style-type: none"> <li>• <i>Activate Lease</i></li> <li>• <i>Add to My Portfolio</i></li> <li>• <i>Cancel Lease</i></li> <li>• <i>Close Lease</i></li> <li>• <i>Copy From Existing Lease</i></li> <li>• <i>Delete Lease</i></li> <li>• <i>Dispute Lease</i></li> <li>• <i>Expire Lease</i></li> <li>• <i>InterUnit Transfer</i></li> <li>• <i>Holdover Lease</i></li> <li>• <i>Manage Amendments</i></li> <li>• <i>Resolve Dispute</i></li> <li>• <i>Submit for Review</i></li> <li>• <i>Validate Lease</i></li> <li>• <i>View Lease Abstract</i></li> </ul> <p>See <a href="#">Understanding Leases</a>.</p>
<p> <b>Go to Error</b></p>	<p>Click to view and resolve validation and/or activation error. The icon works in conjunction with the highlighted field for visual clue.</p>

<b>Field or Control</b>	<b>Description</b>
<b>Landlord and Tenant</b>	<p>Select the name of the landlord or tenant.</p> <p>This field changes depending on your role (landlord or tenant) and the navigation that you use.</p> <hr/> <p><b>Note:</b> The landlord must be set up as a supplier on the supplier table, and the tenant must be set up as a bill to customer on the customer table with the <b>Primary Bill-To</b> check box selected.</p> <hr/> <p>See “Entering Supplier Identifying Information” (PeopleSoft Source to Settle Common Information)</p>
<b>Lease Type</b>	<p>Select the <i>Sub Lease</i> or <i>Reporting</i> lease type. If you select <i>Sub Lease</i>, you must enter the parent lease number associated with that sub lease.</p> <p>See <a href="#">Lease Types Page</a>.</p>
<b>Location</b>	<p>Select the geographical site identifying a city, state, or office. This location code is based on the supplier or customer master and is not established in the Lease Administration feature.</p>
<b>Payables Lease or Receivables Lease</b>	<p>Displays the lease number. This field is dynamic and changes depending on the type of lease (payables or receivables) and the navigation you use. You can either enter a lease number when you create a new lease or let the system generate it from the next available number. If you enter a lease number, it can both letters and numbers.</p>
<b>Region</b>	<p>Select the geographical site that identifies a group of locations, such as <i>Midwest</i> or <i>Northeast</i>. You must enter a region before you validate or activate a lease.</p>
<b>Reference</b>	<p>Specify sections within a lease where the term of the lease is defined. For example, when adding a base rent, you can use the <b>Reference</b> field to specify the section in the lease where the rent terms are located.</p>
<b>Straightline Accounting</b>	<p>Select to specify straightline accounting for rent. When selected, the system applies straightline accounting rules to the rent.</p> <p>See <a href="#">Understanding Straightline Accounting</a>.</p>
<b>Termination</b>	<p>Enter the end date of the lease. The end date is used to define when the lease expires.</p>

## Defining General Lease Information

This topic provides an overview of general lease information and discusses how to define general information for a lease.

### Pages Used to Define General Information

<i>Page Name</i>	<i>Definition Name</i>	<i>Usage</i>
<a href="#">Create New Lease - General Information Page</a>	RE_LS_GENERAL	Select to create a payables lease or receivables lease.
<a href="#">Maintain Lease - General Information Page</a>	RE_LS_GENERAL	Select to maintain a payables lease or a receivables lease.  <a href="#">Create New Lease - General Information Page</a>  <b>Note:</b> As part of the shared product functionality, the Maintain Lease page can also be accessed through the Asset Management navigation as follows: Asset Management > Asset Transactions > Leased Assets > Maintain Lease.
<a href="#">Add Asset Page</a>	RE_LS_ASSET_SEC	Enter additional asset information for the payables or receivables lease.

### Understanding General Lease Information

Defining lease terms and underlying assets in the lease is the first step in setting up a new lease. You can create a new lease or copy from an existing lease.

You can associate a one-to-many relationship between a lease and leased assets. For example, a lease can include multiple properties or a single property with multiple floors, areas, or space. To define assets, populate the Asset List. Information displayed in the grid depends on asset type.

---

**Note:** After the lease is activated, you must create an amendment to change the property information.

---

Before you create a lease, you need to understand the underlying actions of some of the fields and how they affect the overall processing of the lease. This section provides an overview of:

- Lease actions.
- Lease statuses.
- Proration method.

## Lease Actions

You can specify various actions for a lease. The **Action** field is dynamic and works in conjunction with the lease **Status** field, enabling you to change the status of a lease at various stages.

For example, to activate a lease, you select *Activate Lease* from the **Actions** field (if you have user authority). After the lease status is *Active*, the only available actions are *Cancelled*, *Expired*, and *Dispute*.

The available values are:

- *Activate Lease*: You can activate leases if all the necessary lease information is correctly entered and validated by the system. Once a lease is activated, you can begin financial processing, make rent payments, and generate invoices. Activation of the lease validates the lease to ensure that all of the data entered is accurate. If errors are encountered, the system provides information for each error. You must correct these errors before you can reactivate the lease.

Validation errors, when detected, appears in a list towards the top of the page, showing all the errors the system detected. The system also highlights the fields that contain invalid data as a further visual clue. To view and resolve the error, you click the **Go to Error** link. Errors found on other pages have the **Go to Error** icon with the page name displayed. Clicking on the icon takes you to the named page.

The approval for Lease Activations is enabled at the Lease Administration BU definition level. The Lease Activation Approval is configurable by a variety of lease attributes and includes multi-level approval capabilities. If the Lease Activation Approval is enabled, the lease is not activated until an approver validates and approves the activation.

- *Add to My Portfolio*: Select to add the lease to your portfolio page. This action is only available if the lease is not currently in your portfolio.
- *Cancel Lease*: Select to cancel a lease if the lease was entered in error. This action is only available if the lease status is in pending or active status, and the lease does not have any existing financial transactions generated.
- *Close Lease*: Select to close a lease that has expired and for which all final closing transactions are complete. When a lease is closed, you cannot process any financial transaction for that lease. Before closing a lease, Oracle recommends that you leave a lease in expired status for a period of time to allow for ad-hoc transactions, such as security deposit refunds, final bill payments, end of the year operating expense reconciliations, and so on.

---

**Note:** You may consider keeping the lease in expired status for one year to ensure that all transactions for that lease are completed.

---

- *Copy From Existing Lease*: Select to copy from an existing lease. You can copy from another lease only if your lease is in pending status and the leases share the same exemption status. For example, you can create an exempt lease from another exempt lease or a non-exempt lease from another non-exempt lease, but not an exempt lease from a non-exempt lease.
- *Delete Lease*: Select to delete a lease. You must be in update mode and the status of the lease must be pending.
- *Dispute Lease*: Select to set a lease to dispute. The status of the lease must be in either active or holdover before you can set the status in dispute. Once a lease is in dispute, all financial transactions are put on hold. You cannot process recurring or ad hoc transactions until the dispute is resolved.



- *Expire Lease*: Select to set the lease status to expire. To expire a lease, the status must be active, in dispute, or holdover. Once a lease expires, all recurring rents are no longer automatically generated. However, you can still issue ad hoc transactions, such as security deposit refunds, percent rent sales reports, and operating expense reconciliations.

---

**Note:** If a lease, with straightline accounting specified, is manually expired, under straightline accounting rules, the accrual or deferral must be written off during the termination period. A one-time adjustment is made to end the general ledger entry and balance out the lease for all paid amounts.

---

- *Holdover Lease*: Select to set a lease to holdover. When the lease is set to holdover, the lease has already expired. You can complete negotiations or enable the tenant to continue to occupy the property for a short time beyond the expiration date. To extend the lease you need to create an amendment. If the lease's termination date is 6 months beyond the date on which the amendment is activated you are given the option to set the lease back into an active state.
- *InterUnit Transfer*: Select to initiate an interunit transfer. You need to provide the new business unit and lease number to complete the transfer of the asset in the lease. Lease amendment history will not be copied.

---

**Note:** Only active leases can be transferred. A Lease which has either a Security Deposit or a Percent Rent or an Operating Expense attached to it, cannot be transferred.

---

- *Manage Amendments*: Select to create an amendment on the lease or view past amendment history. Creating an amendment changes the terms and conditions of a lease, storing new terms along with historical terms. To create an amendment, the lease status should be *Active* or *Holdover*.
- *Resolve Dispute*: Select this value after the dispute is resolved. The lease is set to the original status before the dispute.
- *Submit for Review*: Select this action to submit the lease for review. If workflow is setup for Lease Administration, the system will send an email with a link to the lease abstract.
- *Validate Lease*: Select to validate the lease to ensure that all required fields are populated. Because you can enter the lease in pending status with little required information, the system must perform an extensive validation of all lease data entered to ensure that all of the appropriate entries are correct. During validation, if any errors are encountered, the system provides information on each of them.

Validation errors, when detected, appears in a list towards the top of the page, showing all the errors the system detected. The system also highlights the fields that contain invalid data as a further visual clue. To view and resolve the error, you click the **Go to Error** link. Errors found on other pages have the **Go to Error** icon with the page name displayed. Clicking on the icon takes you to the subsequent pages.

- *View Lease Abstract*: Select to view the lease abstract. You cannot view the lease abstract if the lease status is cancelled.

## Lease Status

The lease status is a system-defined value that provides a visual indicator of the lease status within the lease life cycle. The lease status also controls what processing can occur against the lease. When creating a lease, the status is set to *Pending*. You can save a lease with only the description; however, you cannot activate the lease until you enter and validate all fields. Use lease amendments to create changes against an active lease.

The available values are:

- *Pending*: Initial entry point in a lease life cycle. You must enter only the description of the lease. No financial processing occurs at this state. Leases can be set to *Activate* in the **Action** field if all the data is complete and successfully validated.
- *Active*: You can change the status of the lease from pending to active based on an installation option and your role. If auto approval is enabled at the installation level, then any user with the Internal Administrator role can activate a lease. If auto approval is disabled at the installation level, then only users with the Internal Manager role can activate the lease. If any other user activates a lease, then the system presents the user with an option to send an email message to the portfolio manager of the lease to request lease activation.

---

**Note:** If the Lease Activation Approval is enabled, the lease status remains *Pending* until the activation is approved. Once approved, the lease status changes to *Active*.

---

When a lease is activated, financial processing of the lease begins.

See “Setting Up Application-Specific Installation Options” (Application Fundamentals).

- *Cancelled*: You can cancel a lease in pending or active status if there are no transactions associated with the lease. After the lease is cancelled, the lease is stored for future reference only.
- *Expired*: A lease can expire if the end date on the lease lapses.
- *Holdover*: You can manually move an expired lease into holdover status if negotiations are in process or the tenant requests an extension for a short period of time to occupy the property beyond the expiration date.

If the tenant requests an extension, the lease term becomes a month-to-month obligation. Users can delete the new MTM terms till the transaction generator process generates a lease transaction from that MTM term. If the MTM details are changed during the MTM extension period, transaction generator generates the future MTM lease transactions based on the updated MTM details. Existing MTM lease transactions which are in pending status in the Transaction Queue Manager are deleted and users are required to run the transaction generator process to regenerate the transactions with the updated MTM Details. Any processed MTM lease transaction will be unaffected with the updated MTM details.

- *Dispute*: You can put a lease in dispute status if it is in litigation or negotiation. No financial processing occurs until it is resolved.
- *Closed*: You can close an expired lease. Once a lease is closed, no financial processing can occur. The lease is stored in the system for historical reference only.

As the lease moves through various stages and as the status is updated, it triggers certain events in other areas of the application. Lease statuses determine the financial progress of a lease. Statuses also determine the various actions that you can take on a lease.

This table lists available actions and statuses that you can select for a lease based on the lease's current status listed in the left column:

<b>Current Lease Status</b>	<b>Available Actions</b>	<b>Available Lease Statuses</b>
<i>Pending</i>	<p><i>Activate</i></p> <p><i>Add to My Portfolio</i></p> <p><i>Cancel Lease</i></p> <p><i>Copy From Existing Lease</i></p> <p><i>Delete Lease</i></p> <p><i>Submit for Review</i></p> <p><i>Validate Lease</i></p> <p><i>View Lease Abstract</i></p>	<p><i>Active:</i> All data entry is complete and successfully passes validation edits.</p> <p><i>Cancelled:</i> You can cancel a lease if there are no existing manual Payables payments associated with the lease.</p>
<i>Active</i>	<p><i>Add to My Portfolio</i></p> <p><i>Manage Amendments</i></p> <p><i>Cancel Lease</i></p> <hr/> <p><b>Note:</b> You cannot cancel a lease if active transactions exist.</p> <hr/> <p><i>Dispute Lease</i></p> <p><i>InterUnit Transfer</i></p> <p><i>Expire Lease</i></p> <p><i>View Lease Abstract</i></p>	<p><i>Cancelled:</i> You can cancel a lease if there are no existing manual payments associated with the lease.</p> <p><i>Expired:</i> A lease can expire through the course of the normal lease cycle where the end date lapses. You can also manually expire a lease for early termination.</p> <p><i>Dispute:</i> Stops all processing until a lease amendment is created.</p>
<i>Cancelled</i>	<i>Delete</i>	None: You can only delete the lease.
<i>Expired</i>	<p><i>Manage Amendments</i></p> <p><i>Close Lease</i></p> <p><i>Dispute Lease</i></p> <p><i>View Lease Abstract</i></p>	<p><i>Holdover:</i> The lease administrator can manually set a lease to holdover status if negotiations are in process or a tenant extends the lease term beyond the expiration date at a higher previously negotiated rent.</p> <p><i>Closed:</i> A lease has expired and has not been renewed.</p> <p><i>Dispute:</i> A lease can go into dispute if holdover terms are unclear or negotiations are in process.</p>

<b>Current Lease Status</b>	<b>Available Actions</b>	<b>Available Lease Statuses</b>
<i>Holdover</i>	<i>Manage Amendments</i> <i>Expire Lease</i> <i>Dispute Lease</i> <i>View Lease Abstract</i>	<i>Active:</i> If a lease in holdover status is amended so that the lease termination is more than 6 months into the future it can be set to active.  <i>Dispute:</i> A lease can go into dispute if holdover terms are unclear or negotiations are in process.
<i>Dispute</i>	<i>Manage Amendments</i> <i>Expire Lease</i> <i>Resolve Dispute</i> <i>View Lease Abstract</i>	<i>Active:</i> You can set the lease back to active status when the dispute is resolved.  <i>Expired:</i> A lease can be expired if the dispute is resolved.  <i>Holdover:</i> A lease can be in holdover status only if it was previously in holdover status and the dispute is resolved.
<i>Closed</i>	<i>Manage Amendments</i> <i>View Lease Abstract</i>	None: No further processing allowed.

### Exempt Leases

You can add exempt leases (typically short-term or low value leases) by selecting the *Exempt from Recognition* option when creating a new lease. The lease classification field displays *Exempt from Capitalization* for exempt leases on the Create New Lease - General Information page. Exempt leases are not capitalized.

---

**Note:** You cannot add exempt leases until you transition to the new accounting standard (select the *Apply ASC 842, IFRS 16 and GASB 87 Accounting* option on the Installation Options - Lease Administration page).

---

Click to watch a short video about [PeopleSoft Lessee Accounting for GASB](#).

### Create New Lease - General Information Page

Use the Create New Lease - General Information page (RE\_LS\_GENERAL) to select to create a payables lease or receivables lease.

Navigation:

**Lease Administration > Payables Leases > Create New Payables Lease > General Information**

Navigation:

**Asset Management > Asset Transactions > Leased Assets > Create New Lease**

This example illustrates the fields and controls on the Create New Lease - General Information page. You can find definitions for the fields and controls later on this page.

This example illustrates the fields and controls on the Create New Lease - General Information page. You can find definitions for the fields and controls later on this page.

Asset ID	Asset Description	Classification	Capitalized Cost
LOA20053	Contract Administrator	Operating	

Combined Total Area: 88.300  
 Combined Usable Area: 88.300  
 Combined Rentable Area: 88.300  
 Unit of Measure: Square Feet

<b>Field or Control</b>	<b>Description</b>
<b>Classification</b>	Displays the lease type.  The options are: <ul style="list-style-type: none"> <li>• <i>Capital / Finance</i></li> <li>• <i>Operating</i></li> <li>• <i>Exempt from Capitalization</i></li> </ul>

## Lease Timetable

<i>Field or Control</i>	<i>Description</i>
<b>Commencement</b>	<p>Select the lease start date.</p> <p>Any financial term start date must not be before this date.</p> <p>If you want to change the commencement date after lease activation, you must cancel the lease and create a new one with the new date.</p>

<i>Field or Control</i>	<i>Description</i>
<b>Termination</b>	Select the lease end date. Any changes to this date after lease activation requires an amendment. Any financial term end date must not be after this date.
<b>Lease Signed</b>	Select the lease signed date. This date must occur on or before the commencement date.

<i>Field or Control</i>	<i>Description</i>
<b>Lease Term</b>	Displays the total number of months for this lease.
<b>Remaining Term</b>	Displays the number of months remaining on this lease.
<b>MTM Extension (Month to Month Extension)</b>	<p>Select this check box to display the MTM Extension button and MTM Extension check box for existing and applicable financial terms in the financial terms tab. MTM Extension icon is displayed next to the check box indicating that the lease is in MTM extension. MTM is applicable only for receivables lease.</p> <hr/> <p><b>Note:</b> MTM Extension check box is displayed only when the Lease is in the Holdover state.</p> <hr/>

## Lease Administration

<i>Field or Control</i>	<i>Description</i>
<b>Lease Administrator</b>	<p>Enter the individual who manages and administers this lease. The lease administrators available in this list are set up under Lease Administration User Roles.</p> <p>See <a href="#">Defining Role Types</a>.</p>
<b>Portfolio Manager</b>	<p>Select the manager of the lease administrator. Depending on your organization, this role may be the same as the lease administrator. The portfolio managers available in this list are set up under Lease Administration User Roles.</p> <p>See <a href="#">Defining Role Types</a>.</p>
<b>Related Leases</b>	<p>Click this link to display the Related Leases window that allows you to enter a parent lease and view its child leases. Click the Related Lease Viewer icon or link on the Related Leases page to view a hierarchical chart that displays the relationship between the leases.</p>

## Asset Information

The Asset Information grid is displayed only when you are adding a non-property lease. Once the lease is activated, the asset related fields cannot be edited from Lease Administration.

<b>Field or Control</b>	<b>Description</b>
<b>Action</b>	<p>Select an action from the following options:</p> <ul style="list-style-type: none"> <li>• Add Equipment</li> <li>• Add Property</li> <li>• Classify Assets</li> <li>• Select Equipment</li> <li>• Select Property</li> <li>• Update UOM</li> </ul> <p>Click <b>Go</b> to perform the selected action.</p> <hr/> <p><b>Note:</b> If you are working with a GASB or IASB business unit and add <i>equipment</i> or <i>property</i>, you should select a depreciable profile ID. If you select a non-depreciable profile, you receive a warning message that the cost assigned to the leased asset will not be depreciated. However, you can proceed if you desire to do so.</p> <hr/>
<b>Lease Payment Allocation</b>	<p>Use the Lease Payment Allocation section to calculate the allocation, enable overrides or remove allocation overrides.</p>
<b>Update Classification Criteria</b>	<p>Use the Update Classification Criteria section to update the Transfer of Ownership and Specialized Asset check boxes for assets in mass. Select All or Clear All option is available. Asset level classifications can be marked as reviewed in mass by selecting the Mark Classifications Reviewed check box. All asset classifications must be marked as reviewed before a lease can be activated. This can be done in mass using this grid or individually at the asset level.</p>
<b>Select Asset</b>	<p>Click to display the Asset Search page. See “Searching for Asset Information” (PeopleSoft Asset Management)</p>
<b>Asset ID</b>	<p>Displays Next as the default Asset ID. You can also enter a value in the Add Asset page.</p>
<b>Asset Description</b>	<p>Displays description of the asset.</p>
<b>Classification</b>	<p>Select Classify Assets in the Action drop-down to validate the lease classification by lease component. The classification value will be either Operating or Finance.</p>



<b>Field or Control</b>	<b>Description</b>
<b>Reviewed</b>	Select to indicate that the asset classification is reviewed.
<b>Lease Term</b>	Displays <i>Yes</i> if the asset meets the lease term criteria.
<b>Purchase Option</b>	Displays <i>Yes</i> if a purchase option for a specific asset is reasonably certain to be exercised.
<b>Classification Overriden</b>	Displays whether the asset classification has been overridden or not.
<b>Specialized Asset</b>	Displays <i>Yes</i> if the asset was identified as specialized.
<b>Transfer of Ownership</b>	Displays <i>Yes</i> if the asset was identified as having a transfer of ownership.
<b>ROU Asset Cost</b>	Displays the ROU (Right of Use) asset cost.
<b>Initial Direct Costs And Other</b>	Displays the initial direct cost and fees to third parties.
	Click to access the Asset Cost Distribution page. Use this page to override the default accounting hierarchy for the Business Unit.
<b>Fair Value</b>	<p>Displays the fair value of the asset.</p> <p>The system uses the fair value to verify the lease type. It also records this value on the AM_FMV table to use in the asset revaluation process. The system calculates the capitalized lease amount using the lesser of the Present Value Lease Payments and Fair Value field values.</p> <p>If the present value of the lease payments is less than the fair value, the capitalized lease amount equals the present value of the minimum lease payment (MLP). If the fair value is less than the present value of lease payments, the capitalized lease amount equals the fair value.</p>
<b>Fair Value at End Date</b>	Enter a fair value of the asset to help the user identify if they have been given a bargain purchase option.

<b>Field or Control</b>	<b>Description</b>
<b>Category</b>	Displays the category associated with the leased asset. If the lease has been reclassified, then the category has to be updated for the underlying asset(s). During lease amendment the category value can be edited. After amendment the lease can be activated only if the selected category has the correct depreciable status for the lease classification.
<b>Asset Type</b>	Indicates the type of the asset.
<b>Asset Subtype</b>	Displays the subtype of the asset. Subtypes are optionally user-defined and directly related to the asset type.
<b>Tag Number</b>	Displays the tag number. Asset Management performs physical inventory using the asset tag number.
<b>Serial ID</b>	Displays the serial number of the asset.
<b>Probable Guar. Residual Value</b> (Probable Guaranteed Residual Value)	Display summarized amount for the probable guaranteed residual value.
<b>Present Value Lease Payments</b>	Displays the discounted amount and represents the lease liability for the asset.
<b>Undiscounted ROU Asset</b>	Displays the sum of the allocated Lease Payments with the initial direct cost and the third party fees.

### Asset List

<b>Field or Control</b>	<b>Description</b>
<b>Asset ID, Asset Description, Classification, and Capitalized Cost</b>	Displays the asset related information. You can click on the Asset ID hyperlink to display the Define Asset Operational Information page.
<b>Decrease in ROU</b> (Decrease in Right of Use)	Select each asset associated with the decrease in lease scope.  Enter the decrease in the rentable area (property) or quantity (equipment).
<b>Unit of Measure</b>	Displays unit of measure for the asset.

<b>Field or Control</b>	<b>Description</b>
<b>Combined Total Area</b>	Displays the total combined size of the properties listed on this lease.
<b>Combined Usable Area</b>	Displays the total sum of combined usable size of the properties on this lease.
<b>Combined Rentable Area</b>	Displays the total sum of combined rentable size of the properties on this lease.

## Add Asset Page

Use the Add Asset page (RE\_LS\_ASSET\_SEC) to enter additional asset information for the payables or receivables lease.

Navigation:

**Lease Administration > Payables or Receivables Leases > Create New Receivables Lease > General Information > Select Add Equipment and click the Go button in the Asset Information grid.**

This example illustrates the fields and controls on the Add Asset page (Create New Payables Lease).

The screenshot shows the 'Add Asset' page with the following fields and values:

- AM Business Unit: US001
- \*Profile ID: PROF4
- \*Asset Description: ARO PROFILE FOR LEASED ASSETS
- Location Code: US001
- CAP #: [Empty]
- \*Asset Type: Furniture
- Tag Number: [Empty]
- Currency: USD
- Transaction Code: [Empty]
- Transfer of Ownership:
- ROU Asset Cost: 0.00
- Asset ID: NEXT
- Asset Category: LARO
- \*Estimated Life: 24 Periods
- Area ID: [Empty]
- Seq #: [Empty]
- Asset Subtype: [Empty]
- Serial ID: [Empty]
- Quantity: 1.0000
- Fair Value: [Empty]
- FV Template ID: [Empty]
- FV Group ID: [Empty]
- Fair Value at End Date: [Empty]
- Probable Guar. Residual Value: [Empty]

Buttons: OK, Cancel, Help

This page varies slightly depending on whether adding equipment for a Payables lease or Receivables lease. This page demonstrates a Payables lease.

<b>Field or Control</b>	<b>Description</b>
<b>Profile ID</b>	<p>Enter a profile ID to define this asset with the default information from the asset profile.</p> <p>If you are working with a GASB or IASB business unit and adding <i>equipment</i> or <i>property</i> asset, you should select a depreciable profile ID. If you select a non-depreciable profile, you receive a warning message that the cost assigned to the leased asset will not be depreciated. However, you can proceed if you desire to do so.</p> <p>If you are working with an exempt lease, you must select a profile that is capitalized and non-depreciable.</p>
<b>Transfer of Ownership</b>	<p>Select this option to indicate there is an ownership transfer of the asset to the lessee at the end of the lease period.</p> <p>If you select this option while working with a GASB business unit, you should select a transaction code indicating that the contract is a financed purchase.</p> <p>If you save the lease without selecting a transaction code, you receive a warning message. However, you can proceed if you desire to do so.</p> <hr/> <p><b>Note:</b> You cannot select this option for exempt leases.</p> <hr/>

**Related Links**

“Adding Capital and Operating Leases” (PeopleSoft Asset Management)

**Defining Lease Financial Terms**

This topic provides an overview of the lease financial terms.

See [Understanding Security Deposits](#).

See [Understanding Operating Expenses](#).

See [Understanding Percent Rent Terms](#).

**Pages Used to Define Financial Terms**

<b>Page Name</b>	<b>Definition Name</b>	<b>Usage</b>
<a href="#">Create New Lease - Financial Terms Page</a>	RE_LS_TERMS	Define lease financial terms.

<b>Page Name</b>	<b>Definition Name</b>	<b>Usage</b>
<a href="#">Financial Terms - Base Rent Details Page</a>	RE_LS_TRM_SEC	Enter base rent details, rent escalation, and escalation schedules for the lease.
Financial Terms - Operating Expense Details Page	RE_LS_TRM_SEC	Enter operating expense details, select operating expense categories, and establish billing frequency.  <a href="#">Create New Lease - Financial Terms Page</a>
<a href="#">Financial Terms - Miscellaneous Rent Details Page</a>	RE_LS_TRM_SEC	Enter miscellaneous rent details, rent escalations, and escalation schedules for the lease.
Financial Terms - Initial Direct Cost Payment Page	RE_LS_TRM_SEC	Enter initial direct cost payment details for the lease.  <a href="#">Create New Lease - Financial Terms Page</a>
Financial Terms - Lease Incentives Payment Page	RE_LS_TRM_SEC	Enter lease incentives received from the lessor.  <a href="#">Create New Lease - Financial Terms Page</a>
Financial Terms - Prepaid Rent Page	RE_LS_TRM_SEC	Enter prepaid rent details for the lease.  <a href="#">Create New Lease - Financial Terms Page</a>
Financial Terms - Security Deposit Page	RE_DEPOSIT_SEC	Enter the security deposit type, amount, and guarantor for the lease.  <a href="#">Create New Lease - Financial Terms Page</a>
Financial Terms - Percent Rent Page	RE_LS_PCT_RENT_SEC	Enter the sales estimation method, sales categories, and breakpoints.  <a href="#">Create New Lease - Financial Terms Page</a>
<a href="#">Accounting Distribution Page</a>	RE_LS_TRM_DST_SEC	Override business unit accounting distribution values for the specific financial terms. If the financial term follows the business unit default accounting rule, this page can be ignored.

<b>Page Name</b>	<b>Definition Name</b>	<b>Usage</b>
<a href="#">Preview Payment Schedule Page</a>	RE_PRVW_PYMNT_SEC	View the schedule date, amount, currency, proration rate and the transaction status of the payments to be done for the selected lease.

## Understanding Lease Financial Terms

Setting up the financial terms on a lease is critical to the overall processing of the lease. You can define the billing or payment frequency of rent, operating expenses, and miscellaneous rent. Establish recurring payments or invoices and specify the specific date that payments or invoices should be processed.

You can establish rent escalations that increase at specific date intervals throughout the life cycle of the lease. When adding base rent, you can set up a recurring invoice or payment. You can create rent escalations using a predefined index or standard stepped increase. The index escalation method typically can use the Consumer Price Index (CPI) or any other index to help determine the rent increase. Escalations usually occur on an annual basis with an optional defined maximum limit capacity.

With operating expenses, you can set maximum increases by amount or percent. As a tenant, you can audit those expenses annually to ensure continuity of spending. As a landlord, you can reconcile the operating expenses and bill or credit the difference to your tenants.

You can also set up a recurring schedule for miscellaneous rent. Recurring miscellaneous rent can include such items as monthly parking fees, administrative fees, and storage fees. You can establish a recurring schedule to reduce data entry redundancy.

You may have leases that are set up on a percent rent schedule, where the monthly rent is reduced in exchange for a portion of the tenant's sales. With percent rent schedule, you can upload tenant sales reports to determine the variable monthly rent the tenant pays.

See [Understanding Percent Rent Terms](#).

### Proration Methods

PeopleSoft Lease Administration enables you to calculate the prorated amount for recurring charges when the start date or end date of the recurring charges do not coincide with the calendar period start date or end date. PeopleSoft Lease Administration supports two proration methods: *365 Days* and *360 Days*.

- 365 day proration:  
 This method is based on the number of days in the calendar period, where the period can be weekly, monthly, quarterly, or yearly.
- 360 day proration:  
 This is a 30 day month proration where the billing frequency can only be monthly with 30 days in each month.

The system applies these rules to the proration methods:

- The system uses the PeopleSoft calendar for all lease terms.

You create calendars at the SetID level by using the menu navigation Setup Financials/Supply Chain, Common Definitions, Calendars/Schedules.

See “Understanding Accounting Calendars Based on Open and Close Periods” (Application Fundamentals).

- The system uses the calendar to determine the start date and end date for the recurring transaction.
- The schedule and calendar frequencies must be the same.

For example, if base rent starts on January 11, 2011, the calendar is monthly and the schedule for payment is monthly (starting on the 15th each month). The term start date (January 11, 2011) does not correspond with the calendar period start date (January 1, 2011). The system performs proration for a period of 21 days (January 31 – January 11 = 21 days). The system generates a bill for 21 days on January 15, 2011. At the end of the lease term for that recurring rent, if the end date also does not correspond with the calendar, then the system prorates the last payment.

The proration method applies to all recurring terms of the lease. The proration method defaults onto the lease from the business unit setup and you can change the method when the lease is in pending status. After you activate the lease, you must create an amendment to change the proration method.

When calculating the prorated amount at end date of the financial term, the system first calculates the term schedule amount including any escalation and related boundaries, and then applies the proration ratio to deduct the prorated amount.

The calculation of the financial term schedule dates and related amounts is essentially the same as for activating a new term as it is for an amendment. The difference is in assessing what constitutes the true start date of the term. When an amendment is activated, the system finds the date of the last schedule generated to the transaction queue, deletes all existing schedules whose date is greater than that last generated date, and if the start date of the amended version of the term is greater than the end date of the calendar period for which transactions are already generated, then the new schedule is generated exactly like for a new term with possible application of the proration rule at term start date and term end date. If the start date of the amended version of the term is less than the end date of the calendar period for which transactions are already generated, the real start date of the amendment is the first day after the calendar period for which transactions are already generated schedule date greater than the last generated schedule date. Proration at start date is not applied but proration for the end date may be applied. If both the start and end dates of the amended term are prior to the last generated schedule date, then no new schedule is generated.

The system also supports the proration of mid-period lease escalations. This enables the proration of a rent increase amount for the number of days applicable in the current period. This applies to both index and stepped escalation types. For example, if a lease with a base rent of \$100 has a stepped escalation of \$15 starting on July 15th, the July rent is prorated and calculated as  $\$107.74 = 100 + 15 * (16/31)$ .

## Create New Lease - Financial Terms Page

Use the Create New Lease - Financial Terms page (RE\_LS\_TERMS) to define lease financial terms.

Navigation:

**Lease Administration > Payables Leases > Create New Payables Lease > Financial Terms**

This example illustrates the fields and controls on the Create New Lease - Financial Terms page. You can find definitions for the fields and controls later on this page.

### Financial Summary

<b>Field or Control</b>	<b>Description</b>
<b>Accounting Date</b>	Enter the Accounting date. Current date is used as the default option. Accounting date is used in transactions with Asset Management.
<b>Interest Rate Percent</b>	<p>Displays the approximate percentage of profit the lessor gains by leasing the asset. This number must be an annual interest rate percentage in whole numbers.</p> <p>As a lessee on a payable lease, the discount rate for the lease should be the rate implicit in the lease (the Interest Rate Percentage field) unless that rate cannot be readily determined.</p> <p>If the rate cannot be determined, the lessee is required to use its incremental borrowing rate (the Borrowing Rate Percentage field). The Borrowing Rate Percentage defaults from the <a href="#">Borrowing Rate Default Page</a>.</p>





<b>Field or Control</b>	<b>Description</b>
<b>Borrowing Rate Percent</b>	Displays the interest rate incurred at the inception of the lease if you had borrowed the necessary funds to purchase the leased asset. This number must be an annual interest rate percentage in whole numbers.
<b>Total Lease Payment</b>	Displays the total lease payment amount.
<b>ROU Asset Cost</b>	Displays the discounted ROU Asset amount.
<b>Lease Currency</b>	<p>Enter the lease currency for this lease. Invoices and payments are processed using this base currency. The default currency comes from the business unit level.</p> <hr/> <p><b>Warning!</b> This field cannot be changed after the lease is activated.</p> <hr/>
<b>Prorata Share</b>	<p>Enter the prorata share, which is a percentage indication of how much space the tenant is occupying in the building. Prorata share can assist with calculation of operating expenses and what share each tenant should bear. This field is informational only.</p>
<b>Current Est Monthly Payment</b> (current estimated monthly payment)	<p>Displays the estimated monthly payment or invoice amount. The system calculates the estimated monthly payment by totalling the amounts defined in the <b>Schedule of Recurring Billing</b> and <b>Schedule of Recurring Rent</b> fields.</p>
<b>Max Op.Ex. Increase/Year</b> (maximum operating expenses increase/year)	<p>Select <b>Amount</b> or <b>Percent</b>, and enter the maximum amount or percent that operating expenses can increase per year.</p> <hr/> <p><b>Note:</b> The <b>Amount</b> and <b>Percent</b> fields are used as a guideline and for information only; there is no system processing behind them.</p> <hr/>
<b>Max Lease Rent Escalation</b>	<p>Select <b>Amount</b> or <b>Percent</b>, and enter the maximum amount or percent that the rent can escalate over the life span of the lease. These options are for information only, the system does not perform any processing based on these options.</p> <p>See <a href="#">Understanding the Transaction Generator</a>.</p>

<b>Field or Control</b>	<b>Description</b>
<b>Exclude Base Year</b>	Select to indicate if operating expenses for a base year should not be charged. You can specify the base year and the base year amount to exclude. This is informational only; these fields are used to record the base year exclusion terms from your lease, but the system does not include these terms in the operating expense reconciliation/audit processes.
<b>Proration Method</b>	Select from three available values: <i>No Proration</i> , <i>365 Days</i> , or <i>360 Days</i> . The system populates these values by default from the business unit level, but you can override them here. If you select <i>365 Days</i> , then the system prorates the base rent for the first and last transaction if the start and end dates do not match the frequency start and end dates. The 365-Day method supports weekly, monthly, quarterly and annual frequencies. The 360-Day method supports only monthly frequency. This field will be hidden for Capital/ Finance leases.
<b>Recognize Monthly Expense</b>	Select this option to prorate non-monthly financial terms (such as quarterly schedules) by period. Lease interest for finance leases and the amortization of the underlying assets for operating leases are recognized on a monthly basis.  You must enable this option using the <a href="#">Lease Administration Business Unit Definition - General Page</a> .
<b>Transaction Code</b>	Displays the transaction code. The transaction code is used to determine the accounting entry template.
<b>BPO (Bargain Purchase Option)</b>	Select if the lease includes a bargain purchase option, which represents a payment by the lessee to the lessor at the end of the lease term, allowing the lessee to obtain title to the leased property.
<b>BRO (Bargain Renewal Option)</b>	Select if the lease includes a bargain renewal option, which requires a payment if the lease agreement grants the lessee the right to renew or extend the lease.
<b>Combined Rentable Area</b>	Displays the total sum of the combined rentable size of the properties on this lease. The information is calculated from the property information on the <b>General Information</b> page. This field will be hidden for non- property leases.

<b>Field or Control</b>	<b>Description</b>
<b>Straightline Accounting Dates</b>	<p>Select an option to generate the straightline schedule. The available options are:</p> <ul style="list-style-type: none"> <li>• <i>Use Lease Commencement/Termination Dates</i>: Select this option to set the default Straightline dates to Lease Start and End Dates.</li> <li>• <i>Override</i>: Select this option to enter a Straightline Start Date and End Date.</li> </ul> <hr/> <p><b>Note:</b> These options are not available for new accounting. These options apply only to operating leases entered prior to transition to the new leasing guidance.</p> <hr/>
<b>Add Base Rent</b>	Click to add base rent for the lease. You must have at least one base rent defined before you can activate the lease.
<b>Add Initial Direct Cost</b>	Click to add an initial direct cost payment for the payables lease.
<b>Add Lease Incentives</b>	Click to record lease incentives received.
<b>Add Operating Expense</b>	<p>Click to add operating expense details for the lease.</p> <p>See <a href="#">Understanding Operating Expenses</a>.</p>
<b>Add Miscellaneous Rent</b>	Click to add miscellaneous rent details for the lease. You must enter the rent type, which appears on an invoice or payment.
<b>Add Prepaid Rent</b>	Click to add prepaid rent for the lease.
<b>Percent Rent Details</b>	<p>Click this link to enter percent rent details, such as sales categories and breakpoint amounts.</p> <p>See <a href="#">Understanding Percent Rent Terms</a>.</p>
<b>Security Deposit Details</b>	<p>Click this link to enter security deposit details.</p> <p>See <a href="#">Setting Up Security Deposits</a>.</p>

## Schedule of Payments

<b>Field or Control</b>	<b>Description</b>
<b>Copy Terms</b>	Select the financial terms you want to copy to a new term.
<b>MTM Extension</b>	<p>Select the MTM Extension check box to select the financial terms applicable for MTM Extension and click the MTM Extension button to create new term rows with the MTM icon displayed.</p> <hr/> <p><b>Note:</b> The check box and button is displayed when MTM Extension check box is selected on the General Information tab.</p> <hr/> <p>Financial term details on the MTM terms created have the following default values:</p> <ul style="list-style-type: none"> <li>• <i>Start Date:</i> Termination date of the Lease incremented by one day.</li> <li>• <i>End Date:</i> Calculated based on the number of months to extend value</li> <li>• <i>Ship To, Payee:</i> Values copied from the source financial term.</li> <li>• <i>Calendar, Schedule:</i> Values copied from the source financial term if the calendar frequency is monthly. Else the values are left blank.</li> <li>• <i>Amount for MTM Extension:</i> Base rent amount on the source financial term.</li> <li>• <i>Reference:</i> MTM Extension.</li> </ul>
<b>Financial Term</b>	Displays one of the following options: Base Rent, Operating Expense or Miscellaneous.
<b>Rent Type</b>	Displays the rent type.
<b>Related Asset</b>	Indicates if a purchase option is tied to a specific asset or to all assets.
<b>Amount</b>	Displays the current amount for the recurring payment or invoice.
<b>Frequency</b>	Displays the recurring frequency for payment or invoice.

<b>Field or Control</b>	<b>Description</b>
	Indicates that straightline accounting applies to the schedule or recurring rent for the financial term row on which the icon appears.
	Indicates that a rent escalation applies to the schedule of recurring rent for the financial term row on which the icon appears.
<b>Copy Selected Financial Terms</b>	Click the Copy Selected Financial Terms button to copy each selected financial term into a new term.  <hr/> <b>Note:</b> Date and amount information are not copied to the new term.  <hr/>

### Financial Terms Page for Receivables Leases

Navigation:

**Lease Administration > Receivables Leases > Create New Receivables Lease > Financial Terms**

The Financial Terms Page for receivables leases includes some fields that are unique to receivables leases. Other fields are common to payables and receivables leases, such as Prorata Share and Proration Method. The table below provides descriptions of some of the fields related to receivables leases.

<b>Field or Control</b>	<b>Description</b>
<b>Add Lease Payments</b>	<p>Select a lease payment type for the operating receivables lease:</p> <ul style="list-style-type: none"> <li>• <i>Add Base Rent:</i> Use to add base rent for the receivables lease. You must have at least one base rent defined before you can activate the lease.</li> <li>• <i>Add Initial Direct Cost:</i> Use to add initial direct cost payments for receivables leases.</li> </ul> <hr/> <p><b>Note:</b> This lease payment type does not integrate with PeopleSoft Billing.</p> <hr/> <ul style="list-style-type: none"> <li>• <i>Add Lease Incentives:</i> Use to add lease incentives paid to lessee for receivables leases.</li> <li>• <i>Add Miscellaneous Rent:</i> Use to add miscellaneous rent details for the receivables lease. You must enter the rent type, which appears on an invoice or payment.</li> <li>• <i>Add Operating Expense:</i> Use to add operating expense details for the receivables lease.</li> </ul> <p>See <a href="#">Understanding Operating Expenses</a>.</p> <ul style="list-style-type: none"> <li>• <i>Percent Rent Details:</i> Use to enter percent rent details, such as sales categories and breakpoint amounts, for the receivables lease.</li> </ul> <p>See <a href="#">Understanding Percent Rent Terms</a></p> <ul style="list-style-type: none"> <li>• <i>Security Deposit Details:</i> Use to enter the security deposit type, amount, and guarantor for the receivables lease.</li> </ul> <p>See the <a href="#">Financial Terms - Security Deposit Page</a>.</p>
<b>Collectibility is Not Probable</b>	<p>Select this option to indicate collectibility is unlikely for the receivables lease. You can use this information for reporting.</p>

## Financial Terms - Base Rent Details Page

Use the Financial Terms - Base Rent Details page (RE\_LS\_TRM\_SEC) to enter base rent details, rent escalation, and escalation schedules for the lease.

Navigation:

Click the **Add Base Rent** action on the **Financial Terms** page.

This example illustrates the fields and controls on the Financial Terms - Base Rent Details page. You can find definitions for the fields and controls later on this page.

Financial Terms
[NEXT -](#)

### Base Rent Details

\*Payment Type  ▼

Start Date

End Date

[Accounting Distribution](#)  
[Preview Payment Schedule](#)  
[Sales/Use Tax](#)

Integration With Accounts Payable

Payee

Location

Ship To

Amount  / Square Feet  
 or  
 Amount  USD

\*Schedule

Frequency  Terms Calendar

Description

Reference

**Rent Escalation**

\*Escalation Type

<b>Field or Control</b>	<b>Description</b>
<b>Payment Type</b>	Select the lease payment type. The available options are: Arrears and Advance.
<b>Start Date</b>	Enter the date on which the base rent becomes effective. You must enter a date that occurs after the lease commencement date and before the end date. The default date is the lease commencement date.
<b>End Date</b>	Enter the date on which the base rent expires. You must enter a date that occurs after the start date and before the lease termination date. The default date is the lease termination date.  <div style="border: 1px solid gray; padding: 5px; margin-top: 5px;"> <p><b>Note:</b> Financial terms are validated for gaps within the financial terms and with the lease dates. A warning message is displayed if gaps exist between the financial terms while saving the component.</p> </div>
<b>Integration with Accounts Payable</b>	Select to send the payment to Accounts Payable. The check box is selected as the default option.

<b>Field or Control</b>	<b>Description</b>
<b>Payee</b>	Enter the entity who receives the rent payments. The default value is the landlord from the lease. This field appears for only payables leases.
<b>Location</b>	Enter the location. You can override the default location from the lease header for a financial term.
<b>Ship To</b>	Enter the supplier ship to location. This location will be used for VAT and SUT calculations by PeopleSoft Payables Voucher Build application. Applicable only for payables leases. If this is left blank, Voucher Build will populate the default ship to location for the supplier.
<b>Payor</b>	Enter the entity who makes the rent payments. The default value is the tenant from the lease. This field appears for only receivables leases.
<b>Accounting Distributions</b>	Click this link to access the Accounting Distributions page and override the business unit accounting rules distributions.
<b>Preview Payment Schedule</b>	Click this link to display the Preview Payment Schedule page. This page displays the schedule date, amount, currency, proration rate and the transaction status of the payments to be done for the selected lease.
<b>Sales/Use Tax</b>	Click this link to access the Sales/Use Tax Information page.
<b>VAT</b>	Click this link to access the VAT Information page. This field appears only for VAT enabled business units.
<b>Straightline Accounting</b>	Select to specify straightline accounting for rent.
<b>Amount</b>	<p>Enter the base rent amount that is charged periodically.</p> <p>You can enter the rent amount either by area or a specific amount. The system calculates the specific amount if rent by area is specified or vice versa.</p> <p>You can enter a zero amount to indicate free rent. The system calculates interest expense for the free rent periods. You can view interest expense for the zero rent periods using the <b>Preview Payment Schedule</b> link.</p> <hr/> <p><b>Note:</b> Enter the actual rent amount excluding the VAT or Sales/Use Tax (SUT) amount. The final rent amount, after including the VAT or SUT amount, will appear on the VAT Information page and Sales/Use Tax Information page respectively.</p> <hr/>



<b>Field or Control</b>	<b>Description</b>
<b>Schedule</b>	<p>Select a value to specify how frequently rent transactions are generated. If the start and end date of the selected frequency differ from the start and end date of the base rent transaction, the system can optionally calculate a prorated transaction for the beginning and end of the term. The values that you have to select from, such as <i>Monthly</i> and <i>Weekly</i>, come from the Schedule component.</p> <p>See <a href="#">Understanding General Lease Information</a>.</p>
<b>Terms Calendar</b>	<p>Enter the terms calendar, which determines the start date and end date of billing periods for the base rent. The calendar ID from the business unit definition appears by default. You can override this value, but the frequency of the schedule and terms calendar must be the same. This is a required field.</p>

## Rent Escalation

PeopleSoft Lease Administration enables you to establish a lease with a base rent and rent escalations using two different calculation methods: stepped or index. The stepped method refers to the auto-generation of escalations based on a fixed escalation percentage/amount and a predefined calendar frequency. You can also manually enter the escalation. The index method is based on the CPI or any other indexes that you define. By selecting these fields, you can establish the maximum amount or percentage that the base rent can escalate. Usually on a monthly basis, you can update the actual index values when the index reporting authorities change the values, thus affecting the variable index escalation.

The system calculates the escalation starting with the base rent amount that is valid for the date the calculation is being run. Then searches for any escalations on this base rent row. Then the system takes the most recent non-future row based on the escalation date, which provides which index to use. The escalation amount is calculated as  $((\text{Current Index} - \text{Initial Index}) / \text{Initial Index}) \times \text{Base Rent}$ . If the escalation exceeds the minimum and maximum specified for that row, then substitute those values (use Minimum if it has not been reached, use Maximum if it has been exceeded).

<b>Field or Control</b>	<b>Description</b>
<b>Escalation Type</b>	<p>Specify the escalation type for rent increases. The options are:</p> <p><i>Index</i>: Specifies rent increases based on a particular index. These increases are variable and can change depending on the values established during product related setup.</p> <p>See <a href="#">Understanding Economic Index Values</a>.</p> <p>“Defining Market Rates” (PeopleSoft Global Options and Reports)</p> <p><i>Stepped</i>: Specifies a fixed rent increase. Escalations can be auto-generated throughout the lease period. Manual entry of escalation is also allowed.</p> <hr/> <p><b>Note:</b> The fields in the <b>Rent Escalation Schedule</b> grid vary based on your selection.</p> <hr/>
<b>Base Index</b>	Select the index to use as the first reference point for rent escalations when using the escalation type of <i>Index</i> . This index compares the subsequent index values entered in the escalation schedule.
<b>Index Basis Date</b>	Enter the date to be used to fetch index values in the base index.
<b>Add Escalation</b>	Click to insert a new escalation schedule.

### Rent Escalation Schedule – Escalation Type: Index

When you select *Index* in the **Escalation Type** field, define the following fields:

<b>Field or Control</b>	<b>Description</b>
<b>Index</b>	Specify an alternate index to use in lieu of the base index.

<b>Field or Control</b>	<b>Description</b>
<b>Calc Method</b> (calculation method)	<p>Select the calculation method for the rent escalation schedule. The available methods are:</p> <p><i>Base:</i> Specifies this escalation schedule to use the base index as the calculation method for the rent escalation. This method compares index values on the escalation date and the start date of the lease term and applies the escalation amount to the actual base rent amount.</p> <p><i>Last:</i> Specifies this escalation schedule to use the prior index defined on the previous row. If there is no previous escalation row then it applies it to the index on term start date. This method compares index values on the escalation date and the last (prior) escalation date and applies the escalation amount to the prior escalated rent.</p>
<b>Index Basis Date</b>	Enter the date to be used to fetch index values in the escalation index.
<b>Minimum Amount</b>	Enter the minimum escalation amount for base rent. The system allows users to enter negative values or zero values (no value) for a negative rent escalation when there is a decrease in the index values when compared to Base Index.
<b>Maximum Amount</b>	Enter the maximum escalation amount for base rent.
<b>Min Percent</b> (minimum percentage)	Enter the minimum percentage escalation for the base rent. The system allows users to enter negative values or zero values (no value) for a negative rent escalation when there is a decrease in the index values when compared to Base Index.
<b>Max Percent</b>	Enter the maximum percentage escalation for the base rent.

### Rent Escalation Schedule – Escalation Type: Stepped

In Stepped method you can opt for either manual entry or auto generation of escalations. For auto generation of escalations you have to specify the escalation frequency, the start date for the escalation and the amount or percentage to escalate by. The escalation amount is added to the base rent upon the new start date; the escalation amount is not cumulative.

For example, the base rent is \$5000.00, and the stepped rent escalations for 5 years is set at \$500.00 per year. To set up the rent escalation schedule, you insert 5 rows: the first row escalation amount is \$500.00; the second row beginning the second year is \$1000.00 (first year \$500.00 + second year \$500.00 = second year escalation amount \$1000.00); the third year, the amount is \$1500.00; and so on (see table below).

Here's an example of a stepped rent escalation (base rent = \$5000.00, rent increase \$500.00 per year for 5 years):

<b>Start Date</b>	<b>Escalation Amount</b>	<b>Base Rent</b>
01/01/2011	\$500.00	\$5500.00
01/01/2012	\$1000.00	\$6000.00
01/01/2013	\$1500.00	\$6500.00
01/01/2014	\$2000.00	\$7000.00
01/01/2015	\$2500.00	\$7500.00

**Warning!** The *Escalation Amount* is not cumulative. You must adjust the amount incrementally for every year.

When you select *Stepped* in the **Escalation Type** field, define the following fields:

This example illustrates the fields and controls on the Financial Terms - Base Rent Details - Rent Escalation: Stepped page. You can find definitions for the fields and controls later on this page.

<b>Field or Control</b>	<b>Description</b>
<b>Escalate Every</b>	Select suitable frequency for the escalation to be generated.

<b>Field or Control</b>	<b>Description</b>
<b>Escalate By</b>	<p>Enter the amount or percentage for escalation to be generated. You can enter the amount either by area or a specific amount. The system calculates the specific amount if rent by area is specified or vice versa.</p> <p>If amount is entered then corresponding percentage will be calculated and displayed in the Rent Escalation Schedule grid. This escalation amount is applicable all through the lease term. If percentage is entered then the equivalent amount is calculated.</p>
<b>Start Date</b>	Enter the start date to indicate from when the escalation will be effective.
<b>Escalation Amount</b>	Enter the fixed escalation amount for base rent.

After providing the escalation amount/percentage, click on Generate Schedule button to generate the Rent Escalation Schedule. Start Date in the Rent Escalation Schedule grid corresponds to the escalation frequency. All the dates between the escalation start date and lease end date are fetched from the Calendar table. These dates serve as the escalation start date in the Rent Escalation Schedule section. Schedules can be generated throughout the lease period.

If the schedule is re-generated for a lease, two scenarios can be considered for the escalation start date as follows:

- The escalation start date being lesser than the escalation schedule start dates: A warning message is displayed indicating whether you want to continue with the modification. If you choose to continue then all the escalation schedules that were generated after the new escalation start date will be deleted and a new schedule created.
- The escalation start date being greater than the last escalation schedule start date and the escalation start date being lesser than the term end date: No warning message is displayed. New schedule is generated for the period between the last start date of the existing schedule and the new term end date. This scenario is applicable where there is an extension in the term end date.

Escalation amount in the schedule is added to the base rent as and when the Schedule date is reached. Escalation Percentage is display only in the Rent Escalation Schedule grid. For manual entry of escalation you should provide the escalation amount in the schedule and based on this the corresponding escalation percentage is calculated.

## **Sales/Use Tax Information Page**

Use the Sales/Use Tax Information to enter the SUT information for the lease.

<b>Field or Control</b>	<b>Description</b>
<b>Sales/Use Tax Destination</b>	Location code on which the SUT calculation for the lease should be based.
<b>Sales/Use Tax Applicability</b>	Displays the sales and use tax applicability rule. This indicates whether sales and use tax is applicable for the specific supplier location and how sales tax is applied. Values are: <ul style="list-style-type: none"> <li>• Direct Pay</li> <li>• Item is Exempt</li> <li>• Purchaser is Exonerated</li> <li>• Sales Tax Applicable</li> <li>• Use Tax Applicable</li> </ul>
<b>Ultimate Use Code</b>	Enter an ultimate use code to override the default tax rate for a location.
<b>Include VAT</b>	If this check box is selected, indicates that VAT should be included in the amount total before the SUT amount is calculated.

### VAT Information Page

Use the VAT Information page to review and update VAT details for the lease.

<b>Field or Control</b>	<b>Description</b>
<b>Expand All Sections</b>	Click this button to scroll to and access every section on the page. You can also expand one or more sections by clicking the arrow next to the section's name.
<b>Collapse All Sections</b>	Click this button to collapse all sections displaying only the header information. If you expand one or more sections, you can click the arrow next to the section's name to collapse the section.

<b>Field or Control</b>	<b>Description</b>
<b>Physical Nature</b>	Indicates whether an object is a good or a service. Many countries are required to report the sale and purchase of goods separately from services. The default comes from the supplier location, voucher origin or AP business unit option for Payables leases. The default comes from the sales line identifier, customer location, bill source, bill type or billing business unit for Receivables leases.
<b>Change Physical Nature</b>	Click to override the default physical nature for this item. The system resets all the VAT defaults.
<b>Location Country</b>	For Payable Leases, displays the PeopleSoft Payables business unit country.  For Receivable Leases, displays the country of the business unit that is the source of the transaction. By default, shows Billing business unit location country.
<b>Location State</b>	For Payable Leases, displays the PeopleSoft Payables business unit state.  For Receivable Leases, displays the state of the business unit that is the source of the transaction. By default, shows the Billing business unit location state. The system populates a default value for this field only when the location country tracks VAT by province.
<b>Supplier Location Country</b>	Displays the supplier location country. Applicable only for Payable leases.
<b>Supplier Location State</b>	Displays the supplier location state. Applicable only for Payable leases.
<b>Customer Location Country</b>	Displays the customer's (buyer) bill-to location country. Applicable only for Receivable leases.
<b>Customer Location State</b>	Displays the customer's (buyer) bill-to location state. The system populates a default value for this field only when the customer location country tracks VAT by province. Applicable only for Receivable leases.

<b>Field or Control</b>	<b>Description</b>
<p><b>Service Performed Country</b></p>	<p>For Payable Leases, depending on the services performed flag setting in the payables hierarchy (Payables Business Unit option, Voucher Origin, Supplier Location), the system sets the value for this field as follows:</p> <ul style="list-style-type: none"> <li>• If the services performed flag is the ship-from location, the system populates the service performed country with the supplier location country.</li> <li>• If the services performed flag is the ship to location, the system populates the service performed country with the PeopleSoft Payables business unit country.</li> <li>• If the services performed flag is the buyer's location, the system populates the service performed country with the PeopleSoft Payables business unit country.</li> <li>• If the services performed flag is the supplier's location, the system populates the service performed country with the supplier location country.</li> </ul> <p>For Receivable Leases, depending on the services performed flag setting in the billing hierarchy (Billing Business Unit, Bill Type, Bill Source, Customer Location, Sales Line Identifier), the system sets the value for this field as follows:</p> <ul style="list-style-type: none"> <li>• If the services performed flag is the ship-from location, the system populates the service performed country with the ship-from business unit country. If there is no ship-from business unit, the system uses the billing business unit location country.</li> <li>• If the services performed flag is the ship-to location, the system populates the service performed country with the ship-to customer location country.</li> <li>• If the services performed flag is the location of the buyer, the system populates the service performed country with the customer's bill-to location country.</li> <li>• If the services performed flag is the location of the supplier, the system populates the service performed country with the billing business unit location country.</li> </ul>



<b>Field or Control</b>	<b>Description</b>
<b>Service Performed State</b>	<p>For a Payables Lease, depending on the services performed flag setting in the payables hierarchy (Payables Business Unit option, Voucher Origin, Supplier Location), the system sets the value for this field as follows:</p> <ul style="list-style-type: none"> <li>• If it is the ship from location, it sets it to the supplier location state.</li> <li>• If it is the ship to location, it sets it to the PeopleSoft Payables business unit state.</li> <li>• If it is the buyer's location, it sets it to the PeopleSoft Payables business unit state.</li> <li>• If it is the supplier's location, it sets it to the supplier location state.</li> </ul> <p>For a Receivable Lease, depending on the services performed flag setting in the billing hierarchy (Billing Business Unit, Bill Type, Bill Source, Customer Location, Sales Line Identifier), the system sets the value for this field as follows:</p> <ul style="list-style-type: none"> <li>• If the services performed flag is the ship-from location, the system populates the service performed state with the ship-from business unit state. If there is no ship-from business unit, the system uses the billing business unit location state.</li> <li>• If the services performed flag is the ship-to location, the system populates the service performed state with the ship-to customer location state.</li> <li>• If the services performed flag is the location of the buyer, the system populates the service performed state with the customer's bill-to location state.</li> <li>• If the services performed flag is the location of the supplier, the system populates the service performed state with the billing business unit location state.</li> </ul>
<b>Ship From Country</b>	<p>For a Payables Lease, displays the supplier's ship from location country. In the case of transactions involving goods or freight service transactions, this is used to determine the VAT treatment.</p> <p>For a Receivable Lease, displays a default value from the ship-to customer's address, or from the bill-to customer's ship-to address if the ship-to customer is not available. In the case of transactions involving goods or freight service transactions, this is used to determine the VAT treatment.</p>

<b>Field or Control</b>	<b>Description</b>
<b>Ship From State</b>	<p>If the ship to country is defined as tracking VAT by state or province, it displays the supplier's ship from location state.</p> <p>In the case of transactions involving goods or freight service transactions, this is used to determine the VAT treatment.</p>
<b>Ship To Country</b>	<p>For a Payables Lease, displays the ship to location country.</p> <p>In the case of transactions involving goods or freight service transactions, this determines the VAT treatment.</p> <p>For a Receivable Lease, displays the Billing business unit location. In the case of transactions involving goods or freight service transactions, this is used to determine the VAT treatment.</p>
<b>Ship To State</b>	<p>If the ship to country is defined as tracking VAT by state or province, it displays the ship to location state. In the case of transactions involving goods or freight service transactions, this is used to determine the VAT treatment.</p>
<b>Service Type</b>	<p>For Payables Lease, displays the VAT service type of <i>Freight</i> or <i>Other</i>. The value in this field determines whether or not the special rules for freight transport within the European Union apply. The value comes from the VAT default hierarchy.</p> <p>For Receivables Lease, the system retrieves the value from the service VAT treatment default, according to the VAT defaulting hierarchy. This value determines whether the VAT treatment is defaulted based on the ship-to and ship-from countries, or the buyer's and seller's countries.</p>
<b>Place of Supply Driver</b>	<p>Displays the usual place of supply (meaning, the place where VAT is usually liable) for the service. This value is used to help determine the place of supply country and the VAT treatment. Options are: <i>Buyer's Countries</i>, <i>Supplier's Countries</i>, or <i>Where Physically Performed</i>. The system derives the value from the VAT default hierarchy.</p>
<b>Reporting Country</b>	<p>Displays the country for which this VAT will be reported. This is the VAT entity VAT registration country and determines many of the VAT defaults.</p>
<b>Defaulting State</b>	<p>If the reporting country requires that VAT be tracked by state or province, this field displays the state within the reporting country that is used to retrieve values from the VAT Defaults table.</p>

<b>Field or Control</b>	<b>Description</b>
<b>Supplier Registration Country and Supplier Registration ID</b>	Displays the registration country and ID of the supplier taken from the supplier information. Applicable only for Payable leases.
<b>Customer Registration Country</b>	Displays the registration country of the bill-to customer. Applicable only for Receivable leases.
<b>Exception Type</b>	Displays the exception granted to the VAT entity. Values are: <i>None</i> , <i>Exonerated</i> , or <i>Suspended</i> . This value is specified on the VAT entity registration.
<b>Certificate ID</b>	If applicable, displays the ID of the VAT exception certificate that may have been issued to the VAT entity.
<b>VAT Registration Country and Registration ID</b>	Displays the registration country and ID of the supplier.
<b>Calculate at Gross or Net</b>	Indicates how VAT is calculated. Values are:  <i>Gross</i> : The system calculates VAT before it applies any early payment discounts.  <i>Net</i> : The system calculates VAT after it deducts early payment discounts. If there are two percentage discounts, the system uses the larger of the two when it calculates VAT. The system does not use discount amounts, only discount percentages.  The default value comes from the VAT entity driver.
<b>Recalculate at Payment</b>	Select this check box to enable the recalculation of VAT at payment time to allow for any early payment discounts, if you are calculating VAT at gross. This causes the system to adjust the VAT amount at the time of payment if the discount has been taken. This is set on the VAT entity driver in the VAT defaults table.

<b>Field or Control</b>	<b>Description</b>
<b>Declaration Point</b>	<p>Appears for a good or service when you want VAT transaction information to be recognized for reporting purposes. Values are:</p> <ul style="list-style-type: none"> <li>• <i>Invoice</i>: VAT is recognized at time of invoice.</li> <li>• <i>Payment</i>: VAT is recognized at time of payment.</li> <li>• <i>Delivery</i>: VAT is recognized on delivery.</li> </ul> <p>This value may be set at several levels in the VAT hierarchy, that is, VAT entity registration, business unit options, supplier, or supplier location.</p>
<b>Rounding Rule</b>	<p>Displays the VAT rounding rule. The value comes from the VAT country, VAT Entity, supplier, or supplier location drivers. Values are:</p> <p><i>Nat Rnd</i> (natural round): Amounts are rounded normally (up or down) to the precision specified for the currency code. For example, for a currency defined with two decimal places, 157.4659 would round up to 157.47 but 157.4649 would round down to 157.46.</p> <p><i>Down</i> (round down): Amounts are rounded down. For example, for a currency defined with two decimal places, 157.4699 would round down to 157.46.</p> <p><i>Up</i> (round up): Amounts are rounded up with a rounding precision to one additional decimal place. For example, for a currency defined with 2 decimal places, 157.4659 would round up to 157.47, but 157.4609 would round down to 157.46.</p>
<b>Use Type</b>	<p>Determines the split between recoverable (taxable) and non-recoverable (non-taxable) VAT.</p> <p>The value comes from the VAT defaulting hierarchy of Lease Administration, either from transaction routing code, supplier location, supplier or Lease Administration business unit. Applicable only for Payables leases.</p>
<b>Place of Supply Country</b>	<p>Displays the country in which the VAT is liable. This field appears only when the transaction is for services.</p>

<b>Field or Control</b>	<b>Description</b>
<b>Treatment</b>	<p>Displays the VAT treatment. VAT treatment is determined by a complex set of algorithms. Values are:</p> <ul style="list-style-type: none"> <li>• <i>Domestic Goods Purchase</i>: If the ship from and ship to countries are the same, and the supplier is registered for VAT, the transaction is treated as domestic.</li> <li>• <i>Domestic Service Purchase</i>: If the buyer and seller are both located in the country where the VAT is liable, the transaction is treated as domestic.</li> <li>• <i>EU Goods Purchase</i>: If the ship from and ship to countries are different, the system determines whether both countries are located within the European Union. If so, the system looks at the VAT registration for each trading partner to determine whether the transaction should be treated as an intra-EU purchase, domestic, or outside the scope of VAT.</li> <li>• <i>EU Service Purchase</i>: If each trading partner is located and registered in different EU countries, and the VAT on a service is liable in the buyer's country, the transaction is treated as a self-assessed EU Services Purchase.</li> <li>• <i>Self-Assess Goods Import</i>: If the ship from country is different from the ship to country and either or both of the countries are located outside of the European Union, and the supplier is not registered in the ship to country, the transaction would be treated as an import. If the flag on the entry in the VAT Country table for the VAT reporting country indicates that VAT on imports should be self-assessed, the transaction will be treated as a self-assess goods import, and both input and output VAT will be recorded.</li> <li>• <i>Self-Assess Service Import</i>: If each trading partner is located and registered in different countries, and the VAT on a service is liable in the buyer's country, the transaction is treated as a self-assessed services import.</li> <li>• <i>Zero-rated Goods Import</i>: If the ship from country is different from the ship to country and either or both of the countries are located outside of the European Union, and the supplier is not registered in the ship to country, the transaction would be treated as an import. If the flag on the entry in the VAT Country table for the VAT reporting country indicates that only input VAT should be recorded on imports, the transaction will be treated as a zero-rated goods import.</li> </ul>

<b>Field or Control</b>	<b>Description</b>
	<ul style="list-style-type: none"> <li>• <i>Outside of Scope</i>: If the supplier is not registered for VAT, or if the VAT is liable in a country other than the VAT reporting country, the transaction is treated as outside the scope of VAT.</li> <li>• <i>No VAT Processing</i>: For transactions where the physical nature is goods, if the ship to country has not been defined as a VAT country and the VAT reporting country on the transaction is blank, no VAT information will be recorded.</li> </ul> <p>Within PeopleSoft, detail VAT treatment values on the transaction lines are used for applying the precise defaults applicable to the transaction lines. The treatment is determined based the rules applicable to the transaction.</p>
<b>Applicability</b>	<p>Displays the VAT status. Applicability is determined by an algorithm that makes use of the <b>Applicable</b> field in the VAT defaults table, the value of which may be set at almost every level in the PeopleSoft Lease Administration VAT defaulting hierarchy. Values are:</p> <ul style="list-style-type: none"> <li>• <i>Exempt</i> (not subject to VAT).</li> <li>• <i>Exonerated</i>.</li> <li>• <i>N/A</i> (not applicable): Valid only when VAT treatment is No VAT Processing.</li> <li>• <i>Outside</i> (outside scope of VAT).</li> <li>• <i>Suspend</i>.</li> <li>• <i>Taxable</i>.</li> </ul>
<b>VAT Code</b>	<p>Displays the VAT code that defines the rate at which VAT is calculated for this schedule. The default value comes from the VAT country, purchase order options, supplier, supplier location, item category, and item levels in the PeopleSoft Lease Administration VAT defaulting hierarchy.</p>

<b>Field or Control</b>	<b>Description</b>
<b>Record Output VAT</b>	Select this check box to enter vouchers where VAT is not included on the invoice but is payable to the VAT authority rather than the supplier. In this case, you account for both input and output VAT for the purchase. This is the case for an Intra-EU Acquisition or when you must account for output VAT on a service supplied by a foreign supplier. This is also referred to as self-assessing for VAT. The value comes from an algorithm that uses the treatment and applicability to retrieve the applicable value from the PeopleSoft-delivered VAT system setup data.
<b>Transaction Type</b>	Displays the code that categorizes and classifies this transaction for VAT reporting and accounting. The default value comes from the VAT entity registration, purchase order options, supplier, supplier location, item category, and item levels in the PeopleSoft Lease Administration VAT defaulting hierarchy.

---

**Note:** The VAT parameters which derive the VAT amounts are controlled/overridden from PeopleSoft Lease Administration. Actual VAT calculations happen in PeopleSoft Accounts Payable and PeopleSoft Billing.

---



---

**Note:** If there is any change in the VAT setup, which leads to a different way of defaulting/ calculating the VAT amounts, then existing leases with their VAT details are not automatically updated. You will have to amend the lease and restore the defaults to make the VAT setup changes effective.

---

## Financial Terms - Miscellaneous Rent Details Page

Use the Financial Terms - Miscellaneous Rent Details page (RE\_LS\_TRM\_SEC) to enter miscellaneous rent details, rent escalations, and escalation schedules for the lease.

Navigation:

Click the **Add Miscellaneous Rent** action on the **Financial Terms** page.

This example illustrates the fields and controls on the Financial Terms - Miscellaneous Rent Details page. You can find definitions for the fields and controls later on this page.

Financial Terms
NEXT -

### Miscellaneous Rent Details

\*Payment Type Arrears

Start Date

End Date

[Accounting Distribution](#)  
[Preview Payment Schedule](#)  
[Sales/Use Tax](#)

Integration With Accounts Payable

Payee

Location

Ship To US001

Amount  / Square Feet  
or  
Amount  USD

\*Schedule

Frequency Terms Calendar Monthly

Rent Type

Description

Reference

**Rent Escalation**

\*Escalation Type None

Many of the fields on the Miscellaneous Rent Details page are the same as the fields on the Base Rent Details page This section contains the additional field.

<b>Field or Control</b>	<b>Description</b>
<b>Rent Type</b>	Enter the type of miscellaneous rent. You can select from only active miscellaneous rent types.  See <a href="#">Defining Miscellaneous Rent Types</a> .
<b>Sales/Use Tax</b>	Click this link to access the Sales/Use Tax Information page.
<b>VAT</b>	Click this link to access the VAT Information page. This field appears only for VAT enabled business units.

## Accounting Distribution Page

Use the Accounting Distribution page (RE\_LS\_TRM\_DST\_SEC) to override business unit accounting distribution values for the specific financial terms.

If the financial term follows the business unit default accounting rule, this page can be ignored.



Navigation:

- Click the **Accounting Distribution** link on the Base Rent Details page.
- Click the **Accounting Distribution** link on the Operating Expense Details page.
- Click the **Accounting Distribution** link on the Miscellaneous Rent Details page.
- Click the **Accounting Distribution** link on the Percent Rent Details page.
- Click the **Accounting Distribution** link on the Security Deposit Details page.

This example illustrates the fields and controls on the Base Rent Details – Accounting Distribution page. You can find definitions for the fields and controls later on this page.

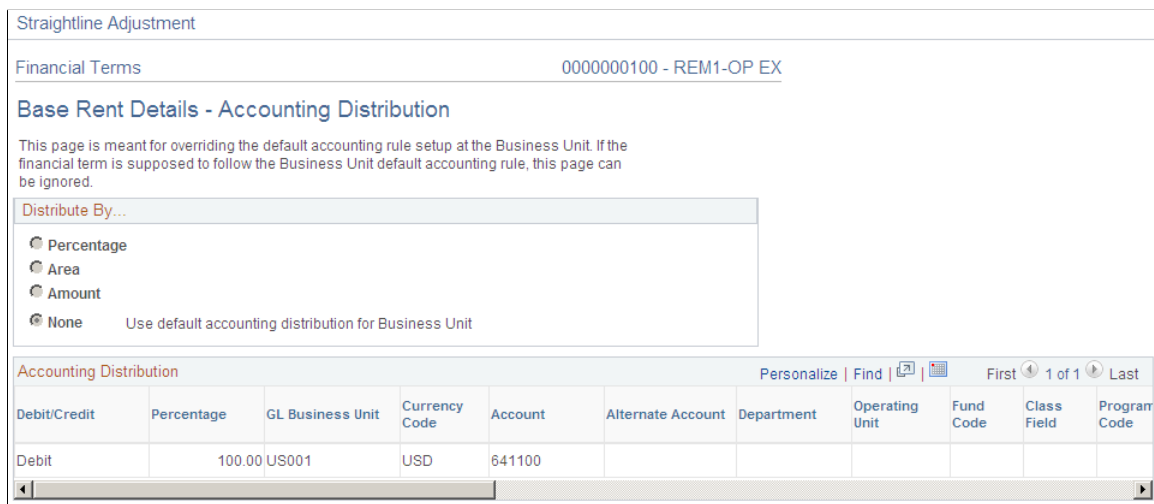

The Accounting Distribution pages for each of the financial terms are identical.

The fields on this page differ depending upon the distribution selected. When you select a value other than None, the ChartField values become available for edit.

<b>Field or Control</b>	<b>Description</b>
<b>Distribute By</b>	Select either: <ul style="list-style-type: none"> <li>• <b>Percentage:</b> Select this value to change the accounting distribution by percentage for each financial term.</li> <li>• <b>Area:</b> Select this value to change the accounting distribution by area for each financial term.</li> <li>• <b>Amount:</b> Select this value to change the accounting distribution by amount for each financial term.</li> <li>• <b>None:</b> Select this option to use the accounting distribution set up at the business unit level.</li> </ul>

<b>Field or Control</b>	<b>Description</b>
<b>Add Distribution</b>	<p>This button appears if you select <b>Percentage, Area</b> or <b>Amount</b> for the distribute by value.</p> <p>Click this button to insert a new distribution row.</p>
<b>Delete Distribution</b>	<p>This button appears if you select <b>Percentage, Area</b> or <b>Amount</b> for the distribute by value.</p> <p>Select a row and click this button to delete it from this page.</p>
<b>Select</b>	<p>This check box appears if you select <b>Percentage, Area</b> or <b>Amount</b> for the distribute by value.</p> <p>This check box is used to delete the distribution rows. Users can select all the distribution rows that they want to delete and click the <b>Delete Distribution</b> button to delete them.</p>
<b>Percentage</b>	<p>This field appears if you select <b>Percentage</b> for the distribute by value.</p> <p>Enter a percentage amount for this distribution line.</p>
<b>Area</b>	<p>This field appears if you select <b>Area</b> for the distribute by value.</p> <p>Enter the area for this distribution line.</p>
<b>Amount</b>	<p>This field appears if you select <b>Amount</b> for the distribute by value.</p> <p>Enter the amount for this distribution line.</p>
<b>Valid</b>	<p>Select this check box to validate this row.</p>

## Preview Payment Schedule Page

Use the Preview Payment Schedule page (RE\_PRVW\_PYMNT\_SEC) to view the schedule date, amount, currency, proration rate and the transaction status of the payments to be done for the selected lease.

This example illustrates the fields and controls on the Preview Payment Schedule page. You can find definitions for the fields and controls later on this page.

Help
000000146 - test end balancing

**Financial Terms**

**Base Rent Details**

Total PVLP 50355.41      PVLP for the Payment Group 50355.41

**Schedule Details**

1-12 of 12

	Schedule Date	Beginning Balance	Amount	Obligation Reduction	Interest Expense	Ending Balance	Currency	Proration Rate	Transaction Status	Schedule Type
1	01/01/2024	54,000.00	1,000.00	832.15	167.85	53,000.00	USD	1.0000000000	Pending	Normal Rent
2	02/01/2024	53,000.00	1,000.00	834.92	165.08	52,000.00	USD	1.0000000000	Pending	Normal Rent
3	03/01/2024	52,000.00	1,000.00	837.71	162.29	51,000.00	USD	1.0000000000	Pending	Normal Rent
4	04/01/2024	51,000.00	1,000.00	840.50	159.50	50,000.00	USD	1.0000000000	Pending	Normal Rent
5	05/01/2024	50,000.00	1,000.00	843.30	156.70	49,000.00	USD	1.0000000000	Pending	Normal Rent
6	06/01/2024	49,000.00	1,000.00	846.11	153.89	48,000.00	USD	1.0000000000	Pending	Normal Rent
7	07/01/2024	48,000.00	1,000.00	848.93	151.07	47,000.00	USD	1.0000000000	Pending	Normal Rent
8	08/01/2024	47,000.00	1,000.00	851.76	148.24	46,000.00	USD	1.0000000000	Pending	Normal Rent
9	09/01/2024	46,000.00	1,000.00	854.60	145.40	45,000.00	USD	1.0000000000	Pending	Normal Rent
10	10/01/2024	45,000.00	1,000.00	857.45	142.55	44,000.00	USD	1.0000000000	Pending	Normal Rent
11	11/01/2024	44,000.00	1,000.00	860.31	139.69	43,000.00	USD	1.0000000000	Pending	Normal Rent
12	12/01/2024	43,000.00	1,000.00	863.17	136.83	42,000.00	USD	1.0000000000	Pending	Normal Rent

<b>Field or Control</b>	<b>Description</b>
<b>Schedule date</b>	Displays the due dates to make payments for this distribution line.
<b>Beginning Balance</b>	Shows the total outstanding balance as per the respective schedule date.
<b>Amount</b>	Shows the amount paid as of the schedule date.
<b>Obligation Reduction</b>	Displays the obligation reduction amount for the schedule date.
<b>Interest Expense</b>	Shows the interest amount for the respective schedule date.
<b>Ending Balance</b>	Show the balance outstanding amount after the scheduled payment.
<b>Currency</b>	Displays the currency of transaction.
<b>Proration Rate</b>	Shows the rent rate calculated proportionately.
<b>Transaction Status</b>	Shows the status of the transaction.

<i>Field or Control</i>	<i>Description</i>
Schedule Type	Displays the type of schedule for the distribution line.

## Defining Lease Clauses

This topic provides an overview of lease clauses, lists a prerequisite, and discusses how to define lease clauses.

### Pages Used to Define Lease Clauses

<i>Page Name</i>	<i>Definition Name</i>	<i>Usage</i>
<a href="#">Create New Lease - Clauses Page</a>	RE_LS_CLAUSES	Define lease clauses.
<a href="#">Clauses - Clause Details Page</a>	RE_LS_CLAUSES_SEC	Add or maintain lease clauses.
<a href="#">Clause User Defined Fields Page</a>	RE_LS_CLSUDF_SEC	Enter clause-specific user-defined data you want to capture for reporting purposes.
<a href="#">Clause Supplemental Data Page</a>	RE_LS_CLAUSE_SUPPL	Enter clause-specific supplemental data you want to capture for reporting purposes.

## Understanding Lease Clauses

A lease agreement contains an enormous amount of data that is relevant to the lease administrator, such as financial terms, special clauses, options, and legal terms. Because of the numerous varieties of data, efficient capture of these important terms is difficult.

Lease clauses typically represent legal terms in the lease agreement that provide certain rights to either the tenant or the landlord. You must keep this information easily accessible because you are likely to use it frequently over the course of the lease. Although clauses are meant to capture all of your lease agreement information not otherwise stored in the Lease Administration feature, there is no processing on any of the data that you enter here. It is provided for reporting purposes. Changes to a clause or additional clauses on an active lease require an amendment.

With lease clauses, you can select the clause types and clause sub types to capture and track this information and enter additional related information in a free-form text field. Clause types and sub types enable you to reduce data entry redundancy and also logically categorize the information that you capture. For example, if you have a clause type of *Parking* and a clause sub type of *Allocated Spaces*, you can further define the clause with the actual number of parking spaces allocated to the lease. You can also incorporate specific sections of a lease in the **Reference** field for each clause that you enter, enabling quick reference to the actual terms within a lease.

In addition, you can capture clause-specific user-defined fields, notes, attachments, and supplemental data. For example, the Clause ID field on the Notes page enables you to associate a specific clause with the note.

**Note:** User defined fields appear on this page to capture additional information unique to your organization. You must first set up these field in the setup component.

See:

[Understanding User-Defined Fields](#)

[Defining User-Defined Fields for Clauses](#)

## Prerequisite

Before adding lease clauses, you must set up the clause types.

See [Defining Clause Types](#).

## Create New Lease - Clauses Page

Use the Create New Lease - Clauses page (RE\_LS\_CLAUSES) to define lease clauses.

Navigation:

- **Lease Administration > Receivables Leases > Create New Receivables Lease > Clauses**
- **Lease Administration > Payables Leases > Create New Payables Lease > Clauses**
- **Lease Administration > Receivables Leases > Maintain Lease > Clauses**
- **Lease Administration > Payables Leases > Maintain Lease > Clauses**

This example illustrates the fields and controls on the Create New Lease - Clauses page. You can find definitions for the fields and controls later on this page.

**Maintain Lease**

General Information | Financial Terms | **Clauses** | Options and Critical Dates | Notes and Attachments | Contacts | Supplemental Data

Action: ...Choose Action... [Go] Unit: US001 Status: Pending

Payables Lease: 0000000128 Lease Name: 7875 Montgomery Street Lease Type: Corporate Payables Lessor: Riger Services Location: Main Region: Southern Sales Reg

[Add Clause]

**Clauses**

Track Compliance	Description	Clause Type	Sub Type	Reference	User Defined Fields	Notes and Attachments
☺	The Tenant shall maintain, at its own expense, com	Insurance Clause	Tenant		User Defined Fields	Notes and Attachments
	The Tenant shall not sublease, assign, or transfer	Subletting			User Defined Fields	Notes and Attachments
☺	The Tenant shall have the option to renew this lea	Renewal			User Defined Fields	Notes and Attachments
☺	This lease may be terminated under the following c	Termination			User Defined Fields	Notes and Attachments

<b>Field or Control</b>	<b>Description</b>
<b>Clause Type</b>	Click the link under <b>Clause Type</b> to display the clause details previously defined in lease maintenance.
<b>User Defined Fields</b>	Select this link to access the <a href="#">Clause User Defined Fields Page</a> and enter clause-specific user-defined data you want captured for reporting purposes.  User defined fields are defined during implementation to enable you to capture additional information specific to your organization.  See <a href="#">Defining User-Defined Fields for Clauses</a> .
<b>Notes and Attachments</b>	Select this link to access the <a href="#">Create New Lease - Notes and Attachments page</a> and associate notes and attachments with a specific clause.
<b>Supplemental Data</b>	Select this link to access the <a href="#">Clause Supplemental Data Page</a> and add supplemental data for a specific clause.

## Clauses - Clause Details Page

Use the Clause Details page (RE\_LS\_CLAUSES\_SEC) to add or maintain lease clauses.

Navigation:

- Click the **Add Clause** button on the Clauses page.
- Click the link under **Clause Type** on the Clauses page.

This example illustrates the fields and controls on the Clauses - Clause Details page . You can find definitions for the fields and controls later on this page.

Clauses
[NEXT -](#)

### Clause Details

Clause ?

\*Clause Type

Clause Sub-type

\*Description

Reference

Compliance ?

Track Compliance

Status Incomplete    Deadline  31    Action Notify Only

Clause	
Created By	Last Updated By
Created On	Last Updated On

<b>Field or Control</b>	<b>Description</b>
<b>Clause Type and Clause Subtype</b>	Enter the clause type and subtype. You can select only the subtype associated with the clause type that you define.  <b>Note:</b> The clause type and clause subtype has a parent-child relationship. You cannot enter a clause subtype without first entering a clause type.
<b>Track Compliance</b>	Select this option to track the compliance of this clause.
<b>Status</b>	Specify the status of this clause: <ul style="list-style-type: none"> <li>• <i>Complete</i></li> <li>• <i>In Progress</i></li> <li>• <i>Incomplete</i></li> </ul>
<b>Deadline</b>	Enter the deadline for terms to be met.

<b>Field or Control</b>	<b>Description</b>
<b>Action</b>	Select what action should be taken if terms are not met: <ul style="list-style-type: none"> <li>• <i>Notify Only</i></li> <li>• <i>Notify and Dispute Lease</i></li> <li>• <i>Notify and Hold Transactions</i></li> </ul>

## Clause User Defined Fields Page

Use the Clause User Defined Fields page (RE\_LS\_CLSUDF\_SEC) to enter clause-specific user-defined data you want to capture for reporting purposes. User defined fields are defined during implementation to enable you to capture additional information specific to your organization.

Navigation:

Select the User Defined Fields link on the [Create New Lease - Clauses Page](#).

This example illustrates the fields and controls on the Clause User Defined Fields page.

The screenshot shows a web interface for editing a clause. At the top, it displays 'Clause User Defined Fields' and the clause identifier '0000000128 - 7875 Montgomery Street'. Below this is the clause text: 'The Tenant shall maintain, at its own expense, comprehensive general liability insurance covering its operations and activities within the leased premises. The insurance policy shall provide a minimum coverage of \$[insert amount] per occurrence and \$[ins'. A section titled 'Clause User Defined Fields' is expanded, showing three input fields: 'Article' with the value 'XI', 'Paragraph' with the value '3', and 'Section' with the value 'a'. At the bottom of the form are three buttons: 'OK', 'Cancel', and 'Refresh'.

Fields on this page are dynamically rendered based on your setup.

See [Defining User-Defined Fields for Clauses](#).

## Clause Supplemental Data Page

Use the Clause Supplemental Data page (RE\_LS\_CLAUSE\_SUPPL) to enter clause-specific supplemental data you want to capture for reporting purposes.

Navigation:



Select the Supplemental Data link on the [Create New Lease - Clauses Page](#).

This example illustrates the fields and controls on the Clause Supplemental Data page.

**Maintain Lease**

Clause Supplemental Data
0000000128 - 7875 Montgomery Street

**INSURANCE**

**General Liability Insurance**

Insurer	<input type="text" value="Allied Insurance"/>	Policy ID	<input type="text" value="AIGL9874566A"/>
Certificate Date	<input style="border: 1px solid #ccc; border-radius: 3px; padding: 2px 5px;" type="text" value="05/01/2017"/>	Policy Limit	<input type="text" value="2000000.00"/>

**Property Insurance**

Insurer	<input type="text" value="Vantage Insurance"/>	Policy ID	<input type="text" value="VIPRP25841C"/>
Certificate Date	<input style="border: 1px solid #ccc; border-radius: 3px; padding: 2px 5px;" type="text" value="05/01/2017"/>	Policy Limit	<input type="text" value="250000.00"/>

Fields on this page are dynamically rendered based on your setup.

See [Setting Up Supplemental Data](#).

## Adding Notes and Attachments

Over the life of a lease, there may be many conversations and correspondences that relate to the lease. The Notes tab within the lease provides a mechanism to record activity history on this lease, similar to a call log.

You can record notes at anytime against a lease, except when the lease is cancelled or closed. When adding notes, you can optionally attach files into the database. You can use this feature to attach a soft copy of the lease agreement itself, an amendment, and other related documentation. After you save a note, you cannot amend it.

In addition, you can capture detailed, clause-level notes and attachments. For example, the Clause ID field on the Note Detail page enables you to associate a specific clause with the note.

This topic discusses how to add notes and attachments to a lease.

### Pages Used to Add Notes and Attachments

<b>Page Name</b>	<b>Definition Name</b>	<b>Usage</b>
<a href="#">Create New Lease - Notes and Attachments page</a>	RE_LS_NOTES	Add notes and attach document files, such as letters, spreadsheets, or drawings, or view or delete already attached files.

<b>Page Name</b>	<b>Definition Name</b>	<b>Usage</b>
<u>Notes - Note Detail Page</u>	RE_LS_NOTES_SEC	Enter a new note for a lease or view an existing note.

## Create New Lease - Notes and Attachments page

Use the Create New Lease - Notes and Attachments page (RE\_LS\_NOTES) to add notes and attach document files, such as letters, spreadsheets, or drawings, or view or delete already attached files.

Navigation:

- **Lease Administration > Receivables Leases > Create New Receivables Lease > Notes**
- **Lease Administration > Payables Leases > Create New Payables Lease > Notes**
- **Lease Administration > Receivables Leases > Maintain Lease > Notes**
- **Lease Administration > Payables Leases > Maintain Lease > Notes**

Use the Notes and Attachments page ( RE\_SITE\_NOTE) to enter notes and attachments about the site.

Navigation:

**Lease Administration > Site Acquisition > Site Repository > Create Site > Notes**

This example illustrates the fields and controls on the Notes page. You can find definitions for the fields and controls later on this page.

This example illustrates the fields and controls on the Notes page. You can find definitions for the fields and controls later on this page.

Add Attachment
Quantity to Attach

**Attachments** 1-1 of 1

File Name	Note	Description	Clause ID	Clause	Created Date	Created By
		<input type="text"/>	<input type="text" value=""/>			

**Lease**

Created By Marilyn Drake	Last Updated By Marilyn Drake
Created On 04/30/2019 1:38:14PM	Last Updated On 04/30/2019 1:49:33PM

## Search for Notes

You can add new notes and attachments to a lease or use the **Search for Notes** group box to locate a specific note already recorded against this lease. This is because over the life of a lease there is a chance that there could be hundreds of notes recorded.

**Note:** You cannot use the search fields when creating a new lease.

<b>Field or Control</b>	<b>Description</b>
<b>Date Range From and To</b>	Enter a from date and a to date to search for a lease note within the time range defined.
<b>Title</b>	<p>Select from the list of values and enter a full or partial lease title in the adjacent field to limit the volume of values returned. The values are:</p> <p><i>Begins with:</i> Select to search by the beginning of a lease title.</p> <p><i>Contains:</i> Select to search for a lease title that contains the text that you enter.</p> <p><i>Is equal to:</i> Select to search for the exact lease title that you enter.</p>
<b>Created By</b>	Enter the name of the user whose note you want to view. You can sort the notes by user. For example, you can enter your name to search for notes that you created.
<b>Note Type</b>	<p>Select the note type that you want to view. The values are:</p> <p><i>All:</i> Select to view all notes entered in the lease.</p> <p><i>System Note:</i> Indicates that the note are recorded automatically by the system, such as when a lease is auto-expired.</p> <p><i>User Entered Note:</i> Select to view notes that are user defined.</p>

<b><i>Field or Control</i></b>	<b><i>Description</i></b>
<b>Search</b>	Click to search for notes matching the search criteria that you entered in the search fields.
<b>Add Note</b>	Click the Add Note button to display the Notes – Note Detail page.
<b>Add Attachment</b>	Click the Add Attachment button to upload a file attachment.
<b>Quantity to Attach</b>	Select the quantity to attach.

### Notes Group Box

Displays notes that you entered throughout the lease life cycle. You can only view the list of notes previously created.

<b><i>Field or Control</i></b>	<b><i>Description</i></b>
<b>Date</b>	Displays the date that the note was created.
<b>Created By</b>	Displays the user name that created the lease note.

### Attachments Group Box

Displays all the attachments in the lease including the ones added in the notes.

<b><i>Field or Control</i></b>	<b><i>Description</i></b>
<b>File Name</b>	Displays the file name of the attachment.
<b>Note</b>	Indicates if the attachment is added from the notes grid.
<b>Clause ID</b>	Select the lease clause to associate with the attachment.
<b>Clause</b>	Displays the name of the selected lease clause.
<b>Created Date</b>	Displays the date when the attachment was uploaded.
<b>Created By</b>	Displays the user name who uploaded the file.

## Notes - Note Detail Page

Use the Notes - Note Detail page (RE\_LS\_NOTES\_SEC) to enter a new note for a lease or view an existing note.

Navigation:

- Click the **Add Notes** button on the Notes page.
- Click the link under **Show Note Details** on the Notes page.

This example illustrates the fields and controls on the Notes - Note Detail page. You can find definitions for the fields and controls later on this page.

<b>Field or Control</b>	<b>Description</b>
<b>Clause ID</b>	Select the lease clause to associate with the note.
<b>Load Attachment</b>	Click this button to upload documents, letters, or drawings associated with this note. Once an attachment is loaded you can delete it or view it.  See <a href="#">Defining an FTP Server for Document Attachments</a> .

## Reviewing Basic Lease Information

This topic discusses how to review leases.

### Pages Used to Review Basic Lease Inquiries

<i>Page Name</i>	<i>Definition Name</i>	<i>Usage</i>
Basic Lease Information Page	RE_LEASE_INQ	Review basic lease information such as lease terms, lease administration, and financial summary.

### Basic Lease Information Page

Use the Basic Lease Information page (RE\_LEASE\_INQ) to review basic lease information such as lease terms, lease administration, and financial summary.

Navigation:

- **Lease Administration > Receivables Leases > Receivables Lease Inquiry**
- **Lease Administration > Payables Leases > Payables Lease Inquiry**

This example illustrates the fields and controls on the Basic Lease Information page.

Basic Lease Information					
Lease Status Holdover					
Lease Number	Lease Name	Lease Type	Lessor	Region	Business Unit
0000000008	440 Wadsworth Blvd	Retail Location	Western Life and Annuity	Midwest Sales Region	US001
Lease Timetable			Lease Administration		
Commencement		Termination	Lease Administrator		
10/15/2000		10/14/2010	Jean-Patrick Martin		
Lease Term	9 years 11 months 29 days		Portfolio Manager		
Remaining Term	0 years 0 months 0 days		Kenneth Schumacher		
Lease Signed	08/30/2000				
Financial Summary					
Combined Rentable Area		65,484 Square Feet			
Prorata Share		19,260,000			
Max Op. Ex. Increase/Year		Lease Currency USD			
Percent 15.00		Current Est Monthly Payment		0.00 USD	
Max Lease Rent Escalation		Current Est Annual Payment		0.00 USD	
Amount		Current Estimated Cost		0.00 USD	
		0.00USD			

This page provides a simple online inquiry of basic lease information for a reviewing a lease. This inquiry page provides you with a summary of the lease terms and financial summary of that lease.

## Managing My Lease Portfolio

This topic discusses how to manage my lease portfolio.

PeopleSoft Lease Administration provides a personalized page for viewing all leases assigned to you, as lease administrator or portfolio manager. You can add additional leases, not assigned to you, to your portfolio by clicking on the **Add to My Portfolio** link.

### Page Used to Manage My Lease Portfolio

<i>Page Name</i>	<i>Definition Name</i>	<i>Usage</i>
<u>My Lease Portfolio Page</u>	RE_MYPRFTL	Use to review or manage your leases.
<u>Add to My Portfolio Page</u>	RE_PRTFL_ADD	Add additional leases, not assigned to you, to your portfolio.

### My Lease Portfolio Page

Use the My Lease Portfolio page (RE\_MYPRFTL ) to use to review or manage your leases.

Navigation:

**Lease Administration > My Lease Portfolio**

This example illustrates the fields and controls on the My Lease Portfolio page. You can find definitions for the fields and controls later on this page.

### My Lease Portfolio

**Search Criteria**

*Business Unit <input type="text"/>	Lease Type <input type="text"/>
Region <input type="text"/>	Lease Number <input type="text"/>
Lease Administrator <input type="text"/>	Lease Name <input type="text"/>
Portfolio Manager <input type="text"/>	Lease Status <input type="text"/>

[Add to My Lease Portfolio](#)

Select All     Clear All

**My Lease Portfolio** Personalize | Find | View All | 1-10 of 96 | First | Last

General
Lease Details

	Business Unit	Lease Number	Lease Type	Lease Name	Region	Lease Status
<input type="checkbox"/>	FRA01	0000000021	Retail Location	417 Rue Madeleine	Western Sales Region	Active
<input type="checkbox"/>	FRA01	0000000022	Retail Location	12 Boulevard Gautier	Northeast Sales	Active
<input type="checkbox"/>	FRA01	0000000023	Retail Location	277 Rue Cler	Midwest Sales Region	Expired
<input type="checkbox"/>	FRA01	0000000024	Retail Location	67-5 Rue de la Chamonix	Southern Sales Region	Active
<input type="checkbox"/>	US001	0000000025	Sublease	5000 Yellowstone Parkway	Western Sales Region	Pending

<b>Field or Control</b>	<b>Description</b>
<b>Add to My Lease Portfolio</b>	Click to add additional leases to your portfolio. You can add additional leases that are not assigned to you to your portfolio to help in managing workload for the other lease administrators or portfolio managers.

<b>Field or Control</b>	<b>Description</b>
<b>Remove from My Lease Portfolio</b>	Click to remove a selected lease from your portfolio.  <b>Note:</b> You cannot remove a lease from your portfolio if you are named the Lease Administrator or Portfolio Manager on the lease.

## Add to My Portfolio Page

Use the Add to My Lease Portfolio page (RE\_PRTFL\_ADD ) to add additional leases, not assigned to you, to your portfolio.

Navigation:



Click the **Add to My Lease Portfolio** link on the My Lease Portfolio page

<b>Field or Control</b>	<b>Description</b>
<b>Go Back to My Lease Portfolio</b>	Click to go back to your lease portfolio page.

## Third Party Integration of Leases

You can create pending leases by entering the lease details and financial terms to the interface tables. Validations are done to the data in the interface tables and pending leases are created if there are no errors. You can also activate multiple leases at once.

The PeopleTools Excel to Component Interface utility enables you to enter the lease transactions into the interface tables.

See also *PeopleTools: Component Interfaces*

## Pages Used to Manage Lease Interfaces

<b>Page Name</b>	<b>Definition Name</b>	<b>Usage</b>
<u>Process Lease Interface Page</u>	RE_RUN_LS_IMPORT	Process the leases in the interface tables.
<u>Review Lease Interface - Lease Details Page</u>	RE_INTFC_LS	Review interface lease details and financial term details.
<u>Review Lease Interface - Lease Term Details Page</u>	RE_INTFC_TRM	Review and make corrections to lease term details.
<u>Review Lease Interface - Lease Other Details Page</u>	RE_INTFC_OTHR	Review and make corrections to lease details.
<u>Review Lease Interface - Error Details Page</u>	RE_INTFC_ERR	Review error details from the Excel to Component Interface import process.
<u>Lease Activation En Masse Page</u>	RE_LS_MASS_ACT	Activate multiple leases at once.
<u>Lease Activation En Masse Log Page</u>	RE_RUN_MAS_LOG_SEC	View processing and validation error information for the lease activation en mass process.

## Importing Lease Information with the Excel to Component Interface Utility

The PeopleSoft system provides a template to import and add lease details and financial data from the spreadsheet to Lease Administration tables with the Excel to Component Interface utility.

Here is an overview of the steps to add lease information using import data from an Excel spreadsheet:

1. Connect to the database by entering the database connect information on the template Connect Information tab.

You need the PeopleSoft web server name, port, PeopleSoft Pure Internet Architecture or portal name, and default local node.

2. Select the predefined component interface (RE\_LS\_IMPORT\_CI) to populate the template on the Template tab.

3. Select the fields that are used to enter data.

Select New Data Input to format the Data Input tab with the selected data fields for the component interface.

4. Input data for all identified and selected record levels on the Data Input tab.

5. Stage the input data to the Staging & Submission tab.

6. Review the data that is ready for staging on the Staging & Submission tab.

Submit data for error-checking and transmission to the database, if successful.

7. Errors are returned to the Staging & Submission tab; select the Post Results option to return processing errors to the Data Input tab for reworking.

8. Submit data to the PeopleSoft Lease Administration database as needed to successfully transmit all input data to Lease Administration.

9. Preview the lease and financial terms data, using the menu option for reviewing lease interface.

10. Run the Process Lease Interface process to add leases to the database.

This example illustrates the fields and controls on the Example of Input Data page – Staging & Submission sheet.

10	Status	Line No	Record Type	Interface ID	Business Unit	Lease Number	Lease Type	Lease Number	Lease Type	Lease Name	Lease Type	Landlord/Tenant	Supplier Location	Address Sequence Number	Region Code	Lease Start Date	Lease Termination Date	Lease Signed Date	Lease Administrator	Portfolio Manager	Lease Currency
11	10	5	100	US001	1	1	1	1	1	CREATE LEASE CORP AP	1	000000004	STANDARD		WEST	1/1/2014	12/31/2015	1/1/2014	02	02	USD
12		5	100																		
13		5	110																		
14		5	110																		
15		5	100																		
16		5	100																		
17		5	100																		
18		5	100																		
19		5	100																		
20		5	100																		
21		5	200																		
22		5	200																		
23	STOP																				

## Process Lease Interface Page

Use the Process Lease Interface page (RE\_RUN\_LS\_IMPORT) to process the leases in the interface tables.

Navigation:

**Lease Administration > Integrations > Import Leases > Process Lease Interface**

This example illustrates the fields and controls on the Process Lease Interface page. You can find definitions for the fields and controls later on this page.

<i>Field or Control</i>	<i>Description</i>
<b>From Interface ID and To Interface ID</b>	Enter the interface IDs to process the interface transactions from the interface tables.  <b>Note:</b> The process selects only the interface transactions with processing status as <i>New</i> .

## Review Lease Interface - Lease Details Page

Use the Review Lease Interface - Lease Details page (RE\_INTFC\_LS) to review and update the transactions in error status. You can also use this page to create Interface Leases.

Navigation:

**Lease Administration > Integrations > Import Leases > Review Lease Interface > Lease Details**

This example illustrates the fields and controls on the Review Lease Interface - Lease Details page.

<b>Lease Details</b>	Lease Term Details	Lease Other Details	Error Details
Interface ID		Interface Processing Status New	
Process Instance			
<b>Lease Information</b>			
Business Unit	US001	Lease Number	NEXT
*Lease Name	<input type="text"/>	Region Code	<input type="text"/>
Lease Obligation	Payables	*Classification	Finance
Lease Type	<input type="text"/>	Lease Currency	USD
Landlord	<input type="text"/>	Location	<input type="text"/>
<b>Lease Timetable</b>		<b>Lease Administration</b>	
Lease Start Date	<input type="text"/>	Lease Administrator	<input type="text"/>
Lease Termination Date	<input type="text"/>	Portfolio Manager	<input type="text"/>
Lease Signed Date	<input type="text"/>		

This example illustrates the fields and controls on the Review Lease Interface - Lease Details page.

<b>Financial Summary</b>			
Accounting Date	01/29/2019	Rate Type	CRRNT
Interest Rate Percent	<input type="text"/>	Borrowing Rate Percent	<input type="text"/>
Prorata Share	<input type="text"/>	Proration Method	365
<input type="checkbox"/> Exclude Base Year		Max Op.Ex.Increase/Yr in Amt	<input type="text"/>
Base Year	<input type="text"/>	Max Op. Ex. Increase/Year in %	<input type="text"/>
Base Year Amount	<input type="text"/>	Max Lease Rent Esc in Amt	<input type="text"/>
Override	Default from Lease	Max Lease Rent Escalation in %	<input type="text"/>
Straightline Start Date	<input type="text"/>	Reference Text	<input type="text"/>
Straightline End Date	<input type="text"/>	Allocation Basis	Manual
Recognize Monthly Expense:	<input type="checkbox"/>		

<b>Field or Control</b>	<b>Description</b>
<b>Lease Obligation</b>	Select Payables or Receivables from the drop down list.
<b>Recognize Monthly Expense</b>	Select this option to create monthly lease interest accounting entries for finance lease assets and monthly right-of-use (ROU) amortization for operating lease assets.  This option is available only when you select the <b>Apply ASC 842, IFRS 16 and GASB 87 Accounting</b> option on the Installation Options - Lease Administration page.

## Review Lease Interface - Lease Term Details Page

Use the Review Lease Interface - Lease Term Details page (RE\_INTFC\_TRM) to review and make corrections to lease term details.

Navigation:

**Lease Administration > Integrations > Import Leases > Review Lease Interface > Lease Term Details**

This example illustrates the fields and controls on the Review Lease Interface - Lease Term Details page.

The screenshot displays the 'Review Lease Interface - Lease Term Details' page. At the top, there are four tabs: 'Lease Details', 'Lease Term Details' (which is active), 'Lease Other Details', and 'Error Details'. Below the tabs, the page shows 'Interface ID' and 'Interface Processing Status' (New). A 'Process Instance' section is also visible. The main content area is titled 'Financial Terms' and includes a search bar and navigation controls. Below this, there are two main sections: 'Rent Details' and 'Description'. The 'Rent Details' section contains several input fields: 'Payment Group' (1), 'Lease Payment Type' (Arrears), 'Start Date', 'End Date', 'Landlord', 'Location', 'Ship To', 'Lease Calendar' (01), 'Schedule ID', 'Amount', and 'Escalation Type' (None). There are also three checked checkboxes: 'Straightline Accounting', 'Default Acctg Distribution', and 'Integration with Accounts Payable'. The 'Description' section has a 'Reference' field and a larger 'Description' text area. The 'Interface Transaction Type' is set to 'Base Rent' and the 'Interface Term ID' is '1'.

<b>Field or Control</b>	<b>Description</b>
<b>Interface Transaction Type</b>	Select the type of interface transaction. The available options are: <ul style="list-style-type: none"> <li>• <i>Base Rent</i></li> <li>• <i>Initial Direct Cost</i></li> <li>• <i>Lease Incentive</i></li> <li>• <i>Misc Rent</i></li> <li>• <i>Opex</i></li> <li>• <i>Opex Category</i></li> <li>• <i>Prepaid Rent</i></li> <li>• <i>Purchase Option</i></li> <li>• <i>Renewal Option</i></li> <li>• <i>Rent Escalations</i></li> <li>• <i>Termination Option</i></li> </ul>
<b>Interface Term ID</b>	Identifies each Lease Term and is unique for each financial term like Base Rent/ Opex/ Misc Rent.  All the transactions that relate to a particular financial term have the same Interface Term ID.

## Review Lease Interface - Lease Other Details Page

Use the Review Lease Interface - Lease Other Details page (RE\_INTFC\_OTHR) to review and make corrections to lease details.

Navigation:

**Lease Administration > Integrations > Import Leases > Review Lease Interface > Lease Other Details**

This example illustrates the fields and controls on the Review Lease Interface - Lease Other Details page.

This example illustrates the fields and controls on the Review Lease Interface - Lease Other Details page.

<b>Field or Control</b>	<b>Description</b>
<b>Interface Transaction Type</b>	Select the type of interface transaction. The available options are: <ul style="list-style-type: none"> <li>• <i>Asset Details</i></li> <li>• <i>Clauses</i></li> </ul>
<b>Default Accounting Distribution</b>	Select this option to use the default accounting distribution.  If you deselect this option, the Accounting Distribution grid appears, where you can modify distribution values.

## Review Lease Interface - Error Details Page

Use the Review Lease Interface - Error Details page (RE\_INTFC\_ERR) to review error details from the Excel to Component Interface import process.

Navigation:

**Lease Administration > Integrations > Import Leases > Review Lease Interface > Error Details**

This example illustrates the fields and controls on the Review Lease Interface - Error Details page.

Line Number	Field Name	Message Set Number	Message Number	Error Details
1				Message Not Found

<i>Field or Control</i>	<i>Description</i>
<b>Update Interface Status</b>	Click the <b>Update Interface Status</b> button to set the processing status to <i>New</i> after reviewing and correcting the errors to enable the lease interface process to process the lease again.

## Lease Activation En Masse Page

Use the Lease Activation en Masse page (RE\_LS\_MASS\_ACT) to activate multiple leases at once.

Navigation:

**Lease Administration > Integrations > Import Leases > Lease Mass Activation > Lease Activation en Masse**

This example illustrates the fields and controls on the Lease Activation en Masse page.



This page enables you to activate multiple leases at once by business unit or lease obligation type. You can also activate an individual lease by lease number.

## Lease Activation En Masse Log Page

Use the Lease Activation en Masse Log page (RE\_RUN\_MAS\_LOG\_SEC) to view processing and validation error information for the lease activation en mass process.

Navigation:

**Lease Administration > Integrations > Import Leases > Lease Mass Activation > Lease Activation en Masse > Click the View Log link.**

This example illustrates the fields and controls on the Lease Activation en Masse Log page.

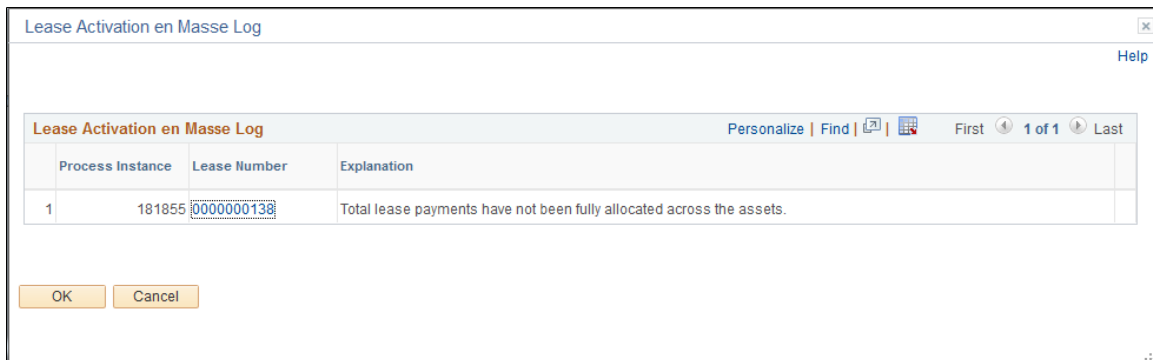

The log only displays leases that were not activated due to a validation error. If a lease is activated without an issue, it does not appear in the log.

The **Lease Number** link enables you to access the Maintain Lease - General page.



# Lease Migration and Transition

---

## Understanding the Data Migration and Transition Process

The migration of Asset Management (AM) leases to the Lease Administration (LA) data structure establishes the sharing of leasing functionality between AM and LA. Customers licensed only for AM will benefit from features and functions within LA that specifically address the core accounting requirements for payables leases (lessee agreements).

To process leases under the new accounting standards ASC 842, GASB 87, or IFRS 16, you must first migrate your Asset Management leases to Lease Administration. After migrating your AM leases to LA, you can process information under the current accounting standard and then later transition to the new accounting standard closer to your organization's adoption date. You do not have to transition to the new accounting standard immediately after migration. An activity guide is provided that includes all the tasks necessary to migrate AM lease information to the LA data structure followed by tasks to transition all leases to the new accounting standard. Certain tasks apply to leases originating in AM (AM leases) while other tasks apply to leases originating in LA (LA leases). Some tasks apply to both AM leases and LA leases. At a high level, customers will review existing AM leases, configure LA shared product configuration in preparation for data migration, migrate AM leased assets to the LA data structure and then capitalize their AM and LA operating leased assets under the new accounting standard. For information on Activity Guide see [Using the Activity Guide](#)

Oracle recommends customers apply these changes to a test environment before applying the changes to their production environment. Both environments should be on a supported PeopleTools release to include WorkCenters and Activity Guides. Customers can use tools to migrate configuration from test to their production environment.

---

**Note:** After data migration, organizations only licensed for Asset Management will benefit from shared functionality in Lease Administration. There is no need to license Lease Administration to run the data migration and transition processes. However, certain components and functionality in Lease Administration will be hidden or unavailable unless you license Lease Administration. For more details on the specific components and functionality included in Asset Management's shared product functionality with Lease Administration, see [Understanding Shared Product Functionality for Asset Management Leases](#).

---

Click to watch a short video about [PeopleSoft Lessee Accounting for GASB](#).

---

## Using the Activity Guide

An activity guide is the central point where customers execute the tasks necessary to complete the data migration from Asset Management (AM) to Lease Administration (LA). The guide also includes tasks to transition your leases to the new accounting standard ASC 842, GASB 87, and IFRS 16. See [Understanding the Data Migration and Transition Process](#).

There are five sections to the activity guide:

- Initial Assessment of Asset Management — review your existing Asset Management leases and update certain information on your property leases.
- Pre-Migration Configuration — configure Lease Administration to work with your leases being migrated from AM. You must complete shared product configuration in Lease Administration before leased assets from AM can be migrated into the LA data structure.
- Migration Process — an online process is executed to migrate leased asset information in AM to the LA data structure. This includes both finance and operating leased assets.
- Preparing to Transition to the New Standard— review and adjust configuration to prepare for the initial capitalization of operating leased assets.
- Transition to the New Standard — review existing accounting configuration and add new accounting configuration to support processing under the new accounting standard. You will then capitalize your operating leased assets and run the straight-line accounting process creating the monthly amortization of your leased asset and lease liability.

*Navigation from Lease Administration:*

Navigation:

**Lease Administration > Payables Leases > Migration and Transition.** Click the button Start Migration Tasks.

*Navigation from Asset Management:*

Navigation:

**Asset Management > Asset Transactions > Leased Assets > Migration and Transition.** Click the button Start Migration Tasks.

This example illustrates the fields and controls on the Migration Tasks page.

Print
Start Migration Tasks

**Initial Assessment of Asset Management**

- 01. Review report identifying AM leases to migrate ?
- 02. Update square footage and other property data for property leases ?

**Pre-Migration Configuration**

- 03. Create amendment types ?
- 04. Create payment schedules ?
- 05. Create routing codes ?
- 06. Create LA business units ?
- 07. Create role types ?
- 08. Assign lease administration roles ?
- 09. Complete processing for AM leased assets that are in process ?
- 10. Assign LA business units to your AM leases ?
- 11. Identify defaults for new lease attributes ?
- 12. Update new lease attributes en masse ?

**Migration Process**

- 13. Run the data migration process ?
- 14. Review post migration comparison reports ?
- 15. Review migrated leases and payment schedules online ?

**Preparing to Transition to the New Standard**

- 16. Identify your transition date ?
- 17. Identify Exempt Leases ?
- 18. Review existing miscellaneous rent configuration ?
- 19. Review existing operating expense configuration ?
- 20. Review leases with multiple operating expenses or invalid payment ?
- 21. Create non-depreciable asset categories for operating leases ?
- 22. Create capitalized asset profiles for operating leases ?
- 23. Update asset profiles and categories on operating leases ?
- 24. Define incremental borrowing rates ?
- 25. Update interest rates on operating leases en masse ?
- 26. Update advance/arrears payment selection on operating leases ?
- 27. Run transition analytics for operating leases ?
- 28. Review transition analytics for operating leases ?
- 29. Review report identifying leases to transition ?

**Transition to the new standard**

- 30. Select option to apply the new accounting standard ?
- 31. Create new AM cost types ?
- 32. Create new accounting entry templates en masse ?
- 33. Update cost distribution for operating leases ?
- 34. Capitalize operating leases in AM ?
- 35. Create straight-line schedules for operating leases. ?

The migration process can be started by clicking the *Start Migration Tasks* button.

## Initial Assessment of Asset Management

In this section you can review existing Asset Management leases and update certain information on your property leases. Only AM leases are impacted. Other tasks in the guide, particularly those in the transition section will apply to both AM leases and leases originating in LA (LA leases).

## Review Report Identifying AM Leases to Migrate

Use this page to review a summarized count and detailed asset-by-asset listing of AM leases to migrate to LA. This report is applicable only for AM leases. ‘Partially Migrated AM Leases’ are included in this report and represent a subset of AM leases. A ‘Partially Migrated’ lease is an AM lease that has some of its data already stored in the LA data structure. Customers that own LA that have AM leases have had the ability to start entering data into the LA data structure since Update Image 10. From a technical perspective, the migration of these leases is slightly different since some of their lease data is already in the LA data structure.

This example illustrates the fields and controls on the Review report identifying AM leases to migrate page.

The screenshot displays the 'Guided Migration Process' interface. On the left is a navigation pane with a task progress bar and a list of steps. The main area shows two reports:

**Count of AM Leases to Migrate**

Business Unit	Lease Count
1 ARO01	2
2 AUS01	1
3 LUX01	3
4 US001	17
5 US006	5

**AM Leases to Migrate**

Business Unit	Asset ID	Asset Description
1 ARO01	LARO1	LARO1
2 ARO01	LARO2	LARO2
3 AUS01	000000000002	Parking Facility Lease
4 LUX01	000000000002	Place Guillaume II
5 LUX01	000000000003	Mobile Workstation

## Update Square Footage and Other Property Data for Property Leases

Use this page to update AM property leases for square footage and other property related attributes required in LA.

The attributes include Total Area, Unit of Measure, Usable Area, Rentable Area and Occupancy Date. These fields were not available to AM customers, but are required in LA. This page should be used to update property related attributes before migrating the lease. Failure to do so will not prevent you from migrating the lease. However, if the information is not populated, users will receive errors after data migration when processing a lease amendment in LA.

This example illustrates the fields and controls on the Update Square Footage and Other Property Data for Property Leases page.

The screenshot displays the 'Missing Property Details' page within the 'Guided Migration Process'. The page title is 'Guided Migration and Transition'. On the left, there is a 'Task Progress' sidebar with a legend and a list of tasks. The main content area shows a table with 5 rows of property data. The columns are Business Unit, Asset ID, Description, Property Class, \*Total Area, \*UOM, Usable Area, Rentable Area, and Occupancy Date. A 'Save' button is located below the table.

	Business Unit	Asset ID	Description	Property Class	*Total Area	*UOM	Usable Area	Rentable Area	Occupancy Date
1	EGV05	000000000004	Zone 215	Area	3812.000	SQF Q			
2	FRAE1	000000000006	Zone 215	Area	3812.000	SM Q			
3	US001	000000000219	Terminus 200 Suite 800	Site		SQF Q			
4	US001	000000000220	Terminus 200 Suite 700	Site		SQF Q			
5	LUX01	000000000002	Place Guillaume II	Site		SF Q			

## Pre-Migration Configuration

This section includes tasks to implement Asset Management's shared product functionality with the Lease Administration product. Certain tasks also apply to LA customers who have AM leases. These organizations will review and potentially adjust existing LA configuration to accept AM leases during migration.

### Create Amendment Types

Use this page to create amendment types in LA. Lease Administration uses amendment processing to track changes to a lease after lease activation. This impacts AM customers configuring shared product functionality with LA for the first time. See [Working with Amendments](#).

### Create Payment Schedules

Use this page to create payment schedules in LA. New payment schedule configuration in LA will replace existing AM payment schedule configuration. This impacts AM customers configuring shared product functionality with LA for the first time.

Asset Management customers should configure the lease payment schedules that will be required after data migration.

### Create Routing Codes

Use this page to create transaction routing codes. This impacts AM customers configuring shared product functionality with LA for the first time. See [Defining Transaction Routing Codes](#).

## Create LA Business Units

Use this page to create your LA business units. AM business units are mapped to LA business units. This page can also be used by LA customers to review configuration for their existing LA BUs. This task impacts both AM and LA customers. See [Creating Lease Administration Business Units](#).

## Create Role Types

Use this page to create role types in LA. This impacts AM customers configuring shared product functionality with LA for the first time. Role types are identified to role categories. You should create at least one role type for each Internal role category. See [Defining Lease Administration Roles](#).

## Assign Lease Administration Roles

Use this page to assign roles to users. This impacts AM customers configuring shared product functionality with LA for the first time. End users working in LA should be assigned roles. These roles identify whether the user can:

- Approve (and adjust) lease payment transactions for payables processing.
- Create manual fee transactions.
- Create lease amendments.

See [Setting Up Roles and Permission Lists](#).

## Complete Processing for AM Leased Assets that are in Process

Use this page to review assets in the interface table. Links in the AM WorkCenter can be used to complete processing for AM leased assets that are in process. The AM WorkCenter can be used to review pending transactions and exceptions under My Work.

## Assign LA Business Units to Your AM Leases

Use this page to review (and adjust if necessary) the LA Business Unit (LA BU) being assigned to your AM leases during migration. This task is important for a successful data migration.

The page shows a listing of your AM leases including the LA BU to which the lease will be mapped. More specifically, when you create an LA BU, you identify its related AM BU. This relationship determines the LA BU used for migration. In this task of the activity guide, the LA BU is populated and display only if the AM BU is mapped to only one LA BU. If the AM BU is mapped to multiple LA BU's, you must select a LA BU for the lease. In this scenario, the migration process does not know which LA BU the asset belongs in until you identify it on the page.



This example illustrates the fields and controls on the Assign LA Business Units to Your AM Leases page.

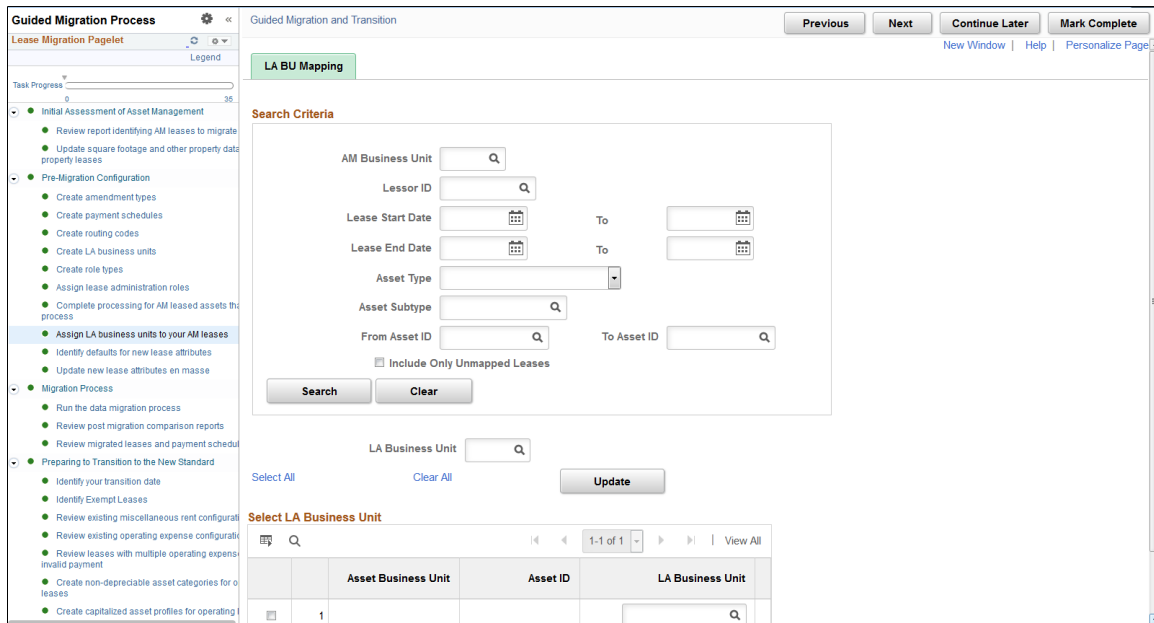

### Identify Defaults for New Lease Attributes

Use this page to identify the default values for required fields on the lease. This impacts AM leases.

Asset Management is not tracking certain fields that are required once leases are migrated. This includes Lease Type, Region Code, Lease Administrator and Portfolio Manager. You should use this task to create your organization-specific values for these attributes and to assign a default value for each of the attributes. You must enter a default value for all the attributes on this page, else your AM leases cannot be migrated.

This example illustrates the fields and controls on the Identify Defaults for New Lease Attributes page.

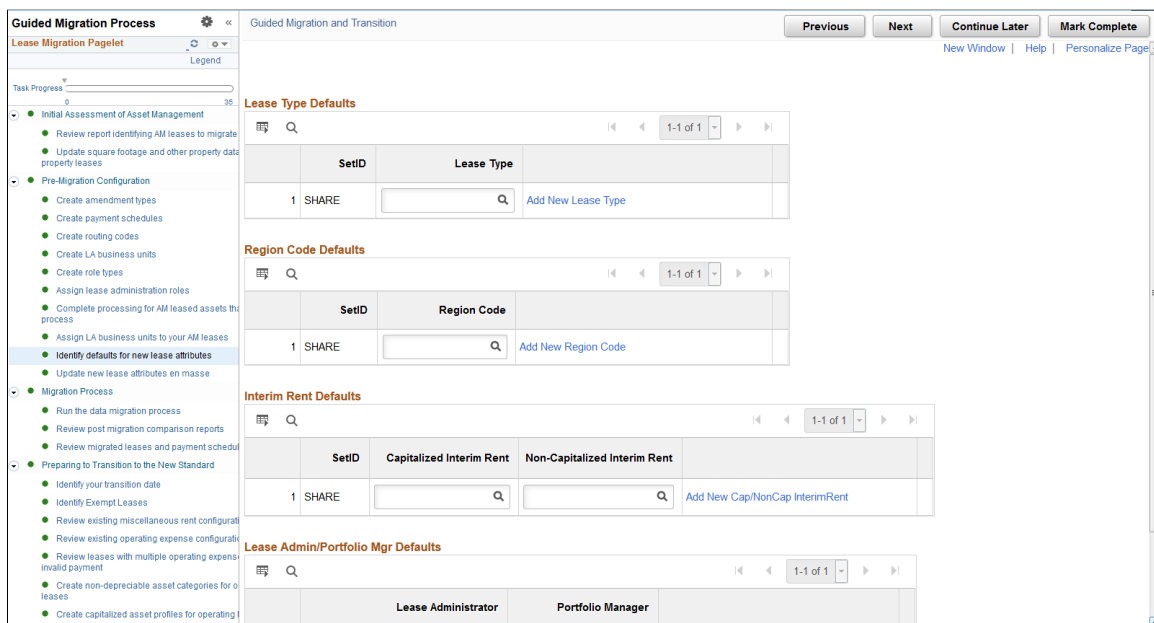

## Update New Lease Attributes en masse

Use this page to update new lease level identifiers en masse or individually. This impacts AM leases.

You can use this page to provide a more specific value for Lease Type, Region Code, Lease Administrator and Portfolio Manager for each of your leases. This is optional. If a lease is not updated here, on this task, then the defaults from the previous task will be used during data migration. Also, you must ensure that each lease has a lessor ID populated, else the lease cannot be migrated to LA. If you process lease payments through accounts payable, the supplier ID on the lease in AM will become the lessor on the lease in LA and this column is display only. You must identify a lessor before the lease can be migrated. To update information en masse, first select a LA Business Unit just below the search criteria. Next, select values for the fields being updated and select Update. Once complete, save the changes.

This example illustrates the fields and controls on the Update New Lease Attributes en masse page.

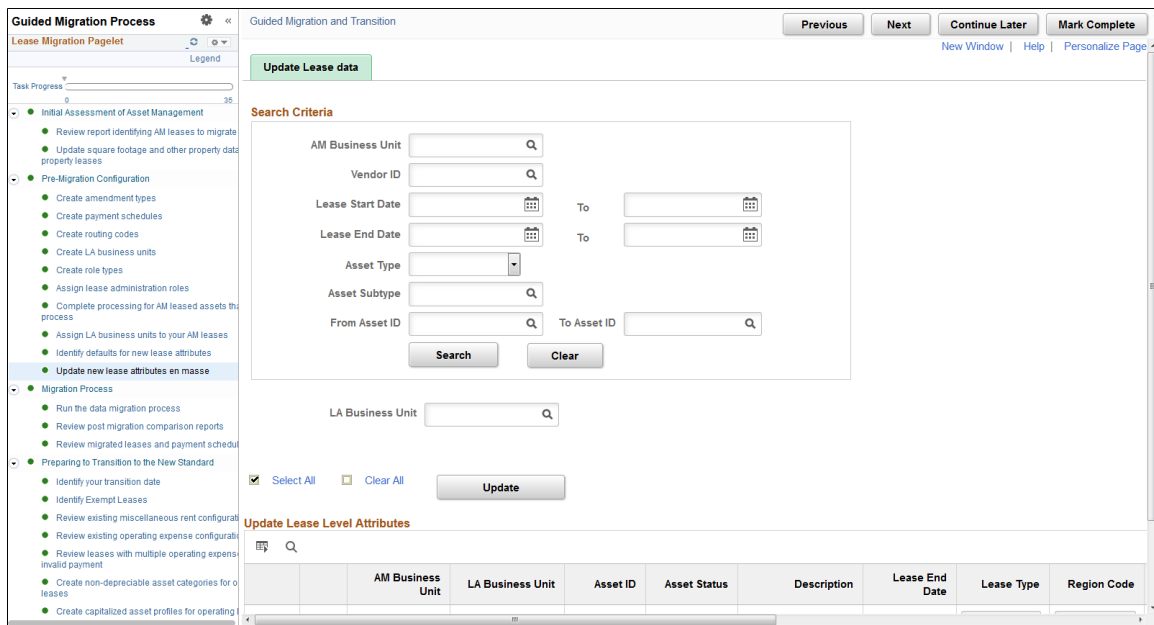

## Migration Process

This section includes tasks related to running the Migration Process followed by tasks to review the results of the data migration online.

### Run the Data Migration Process

Use this page to run the data migration process.

The data migration process is an application engine process run through the process scheduler. You can migrate one or many assets at once by selecting the check box next to the assets in the grid. The following validations will prevent a lease from being migrated:

- No lease type, region code, lease administrator or portfolio manager for the lease.
- No supplier/lessor for the lease.
- No default value for AM interim rent.

- No LA BU for the lease (note that leases without an assigned LA BU will be excluded from this page altogether).

After the lease is migrated to LA, you can access the lease through the pages shared with Lease Administration.

This example illustrates the fields and controls on the AM Leases Migration page.

The screenshot shows the 'AM Leases Migration' interface. At the top, there is a 'Run Control ID' of 001100, a 'Report Manager' link, a 'Process Monitor' link, and a 'Run' button. Below this is a message: 'You must have an LABU assigned to the lease for it to be eligible for migration. Leases without an assigned LABU will not appear on this page. Be sure to return to the earlier step (Assign LABUs to AM Leases) and verify you have assigned an LABU to all of your leases.'

The 'Search Criteria' section contains the following fields and controls:

- Business Unit: Search box with magnifying glass icon.
- Lessor ID: Search box with magnifying glass icon.
- Lease Start Date: Date picker.
- To: Date picker.
- Lease End Date: Date picker.
- To: Date picker.
- Asset Type: Dropdown menu.
- Asset Subtype: Search box with magnifying glass icon.
- From Asset ID: Search box with magnifying glass icon.
- To Asset ID: Search box with magnifying glass icon.

At the bottom of the search criteria section are 'Search' and 'Clear' buttons. Below the search criteria are 'Select All' and 'Clear All' links.

This example illustrates the fields and controls on the AM Leases Migration page.

The screenshot shows the 'Select Leases To Process' table. At the top, there is a search icon and a search box. To the right, there are navigation arrows, a '1-1 of 1' indicator, and a 'View All' link. Below the navigation is a tabbed interface with 'Asset Details 1' selected and 'Asset Details 2' visible. The table has the following columns: Select, AM Business Unit, Asset ID, LA Business Unit, Lease Classification, and Errors. The first row contains the number '1' in the 'Select' column and 'Errors' in the 'Errors' column.

Select	AM Business Unit	Asset ID	LA Business Unit	Lease Classification	Errors
1					Errors

## Review Post Migration Comparison Reports

Use this page to compare a count of leases in AM to a count of leases migrated to LA.

- Summary Level Report — compares the number of leases in AM by business unit to the number of leases in LA by business unit. The report displays asset status and lease status.
- Payment Schedule Detail Report — details the payment schedules created in LA by payment type. The payment schedule migration is an important part of the data migration. This report summarizes the types of payment schedules created in LA.

- Row Count in Lower Level Tables — provides a count of the rows populated in the LA tables. This includes only the leases migrated from AM. Even after data migration this report will only include leases migrated from AM.

This example illustrates the fields and controls on the Review Post Migration Comparison Reports.

Summary Level Report						
	AM Business Unit	LA Business Unit	Asset Status	Lease Status	#Leases	#Lease Payment Schedules
1					0	0

Payment Schedule Detail Report						
	AM Business Unit	LA Business Unit	Asset Status	Lease Status	Payment Type	#Payment Schedules
1						0

Row Count in Lower Level Tables									
	AM Business Unit	#LEASE	LA Business Unit	#RE_LS	#RE_LS_PPTY	#RE_LS_AST_DST	#RE_LS_TRM	#RE_LS_TRM_DST	#LEASE_SCHED
1	AR001	2		0	0	0	0	0	42
2	AUS01	1		0	0	0	0	0	24
3	US001	14		0	0	0	0	0	318
4	US006	5		0	0	0	0	0	144

### Review Migrated Leases and Payment Schedules Online

Use this page to perform an online review of the leases migrated from AM into LA. This page provides a detailed, asset-level view of the leases migrated from AM to LA.

- Detail 1 — provides high-level view of the lease including BU, lease name and other lease attributes defined for the migration. Select the Lease Number link to view the lease.
- Detail 2 — provides start and end date, lease administrator and other lease attributes defined for the migration.
- Detail 3 — provides visibility into the types of lease payments created in LA and a link to view those lease payments on the Financial Terms page on the lease.

You can click the links for Base Rent, Purchase Option, Penalty Option and Interim Rent to view the payment schedules migrated from AM into LA. The link first opens the Financial Terms page on the lease. From the Financial Terms page, select the rent payment. After selecting the rent payment, you can review the start and end dates for the payment along with the payee. All payment information on this page are migrated from AM.

The data migration process does not populate values for Schedule, Frequency and Terms Calendar. When you open the page, the terms calendar defaults from the Lease Administration BU. The data migration process sets the Integrate with Accounts Payable selection to checked on base rent payments if the AM BU was set to process lease interface payments with AP. Purchase options and penalties migrated from AM were set to not integrate with accounts payable (unchecked) since these payments were not integrated with AP previously. You can update this selection through amendment processing. The data migration process does not generate a detailed payment schedule for one-time payments such as purchase options migrated from AM since there is only one payment. These amounts are included in the PVLP calculation.

This example illustrates the fields and controls on the Review Migrated Leases and Payment Schedules Online page.

The screenshot displays the 'Guided Migration Process' interface. On the left is a task list with categories like 'Initial Assessment of Asset Management', 'Pre-Migration Configuration', 'Migration Process', and 'Preparing to Transition to the New Standard'. The main area is titled 'Guided Migration and Transition' and contains a 'Search Criteria' section with input fields for LA Business Unit, AM Business Unit, Lease Number, Asset ID, Lease Status, Asset Status, Lease Start Date, and Lease End Date. Below this is a 'Migrated Leases' table with columns for LA Business Unit, AM Business Unit, Asset ID, Lease Name, Region Code, Lease Status, Asset Status, and Lessor Name. The table shows one row with the number '1' in the LA Business Unit column.

## Preparing to Transition to the New Standard

This section details the steps required for successful transition to accounting standards ASC 842, IFRS 16, and GASB 87. This includes tasks to configure Asset Management to function under the new accounting standard such as the creation of new accounting entry templates. Other tasks prepare LA for the initial capitalization of operating leased assets such as the identification of interest rates used to calculate Present Value of Lease Payments (PVL) calculations. Tasks in this section impact both AM operating leases migrated to LA and operating leases originating in LA (LA Operating Leases).

**Note:** The 'Identify Exempt Leases' step will not appear until you delete the existing activity guide template *LA\_MIG\_TRA*. For information about how to delete an activity guide template, see the task 'Creating and Maintaining Activity Guide Templates' in the PeopleTools: Portal Technology documentation.

If you have entered functional data into the activity guide, that data is not deleted. However, the progress icon to the left of each step indicating that you have started or completed a task is reset.

### Identify Your Transition Date

Use this page to identify and update your organization's transition date. This should be the effective date your organization will adopt the new accounting standard. Payments made on or after this date will be included in the initial capitalization of your operating leases.

This example illustrates the fields and controls on the Identify Your Transition Date page.

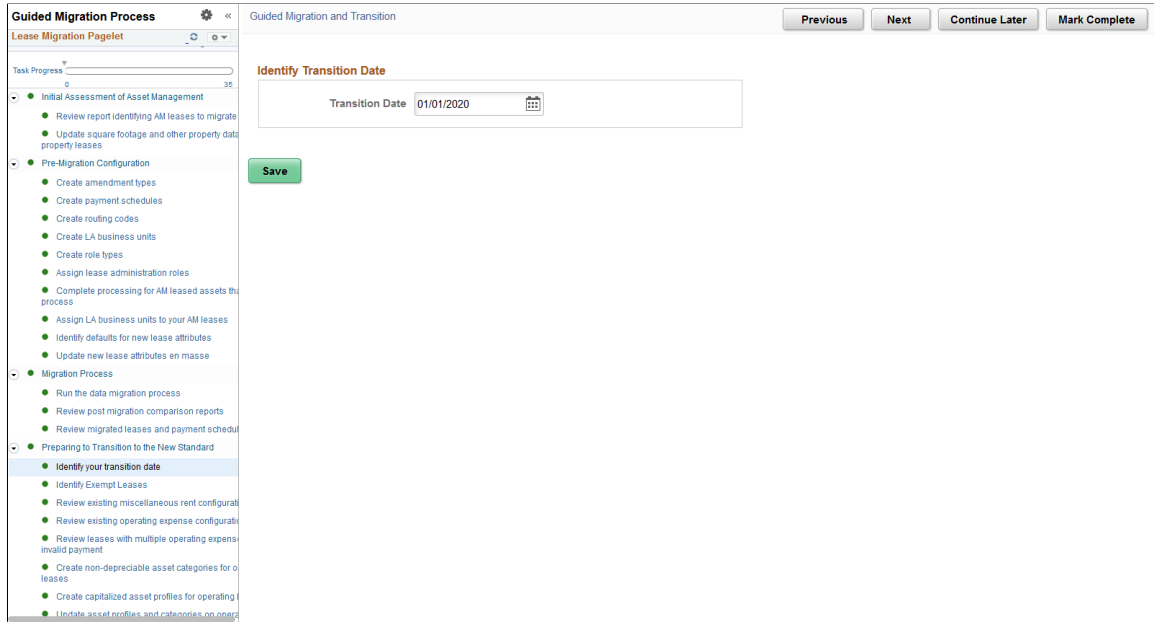

## Identify Exempt Leases

Use this page to identify leases that are exempt from recognition.

This example illustrates the fields and controls on the Identify Exempt Lease page.

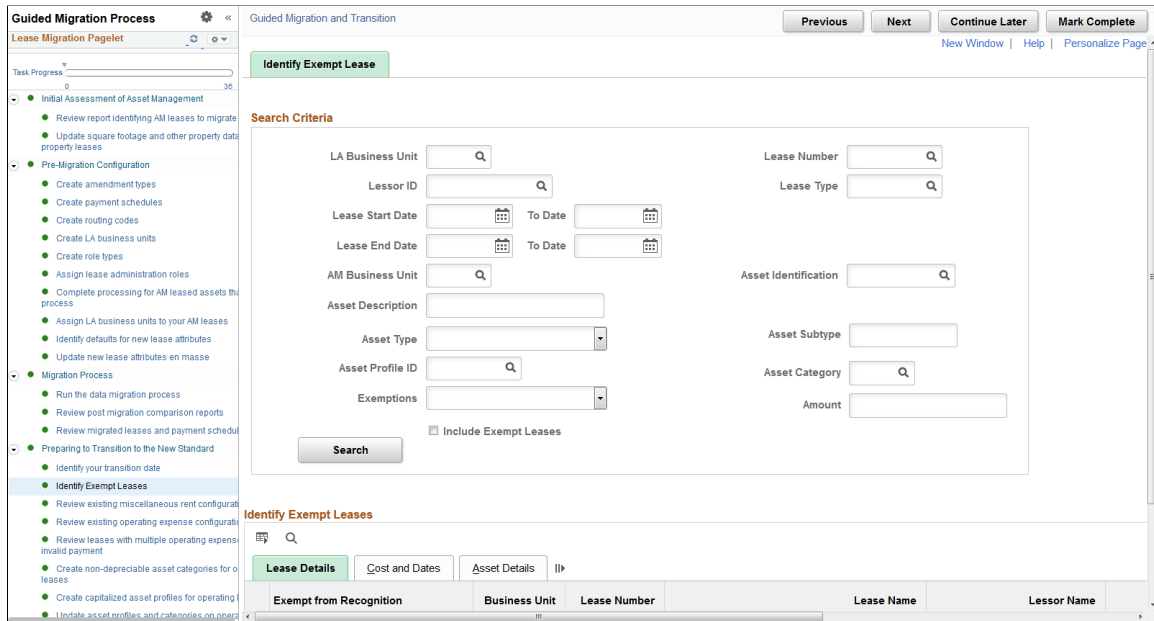

Select the *Exempt from Recognition* option to identify exempt leases.

Exempt leases are automatically excluded from the following activity guide tasks:

- *Update Interest Rates on Operating Leases en Masse*
- *Update Advance/Arrears Payment Selection on Operating Leases*

- *Run Transition Analytics for Operating Leases*
- *Review Transition Analytics for Operating Leases*
- *Review Report Identifying Leases to Transition*
- *Update Cost Distribution for Operating Leases*
- *Capitalize Operating Leases in AM*

## **Review Existing Miscellaneous Rent Configuration**

Use this page to review and adjust the Include in Lease Payments selection on your miscellaneous rent payments.

A miscellaneous rent with the Include in Lease Payments box selected will be included in the initial capitalization of an operating leased asset. If an operating lease includes a misidentified miscellaneous rent, the initial capitalization of the asset will be incorrect. See [Defining Miscellaneous Rent Types](#).

## **Review Existing Operating Expense Configuration**

Use this page to review and adjust the Include in Lease Payments selection on your operating expenses. An operating expense with the Include in Lease Payments box selected will be included in the initial capitalization of an operating leased asset. See [Establishing Operating Expenses for a Lease](#).

## **Review Leases with Multiple Operating Expenses and Invalid Payment**

Use this page to review and resolve three exceptions/issues for leases. This applies primarily to leases originating in LA (LA leases), but also to AM leases that were modified after being migrated to LA. This step is critical to ensuring an accurate calculation of PVLP on your operating leases, the amount used for capitalizing your operating leased assets. The three exceptions are:

- **Operating Expenses with Multiple Expense Categories** — for proper calculation of PVLP, an operating expense payment on a lease can be either included in lease payments or not included in lease payments, but not both. You must adjust the lease to break out the combined payment into two separate payments before capitalizing the lease.
- **Overlapping Payment Dates Within a Payment Group** — this exception includes leases that have overlapping payment dates within a payment group. This exception applies to existing LA operating leases with multiple payments within a payment type. The payment group number must be different if the dates overlap with another payment. Note that overlapping payment dates are permitted across payment types. You must adjust the lease to correct this exception before capitalizing the lease.
- **Gaps in Payment Dates Within a Payment Group** - this exception includes leases that have multiple payments within a payment group with gaps in payment start dates between the payments. Some of these gaps may be correct and should not be adjusted, however that determination must be made by the organization based on the following guidance:
  - The system calculates PVLP based on the start date for the individual payment which is not necessarily the start date on the lease. If the payment should be discounted back to the start date of the lease, then the start date for the individual payment should be the same as the start date on the lease.

- The system will not validate if the Gaps in Payment Date exception has been cleared when the lease is capitalized since some of these may be correct. However, this exception has to be reviewed to ensure that the payment dates are setup correctly.

This example illustrates the fields and controls on the Review Leases with Multiple Operating Expenses or Invalid Payment page.

**Search Criteria**

Transition Date: 01/01/2019	Business Unit: <input type="text"/>
Lease Number: <input type="text"/>	Lessor ID: <input type="text"/>
Lease Type: <input type="text"/>	Financial Term: <input type="text"/>
Lease Start Date: <input type="text"/>	To: <input type="text"/>
Lease End Date: <input type="text"/>	To: <input type="text"/>
<input type="button" value="Search"/>	<input type="button" value="Clear"/>

**Lease Exceptions**

#	Business Unit	Lease Number	Lease Name	Lease Type	Lessor Name	Lease Administrator	Lease Start Date	Lease End Date	Financial Term
1									

## Create Non-Depreciable Asset Categories For Operating Leases

Use this page to modify your existing asset categories or create new asset categories for your operating leased assets. Categories used for operating leases must be identified as non-depreciable.

Under the new accounting standards, you amortize operating lease assets. You do not depreciate them. You should review your existing asset categories to determine which asset categories you are using for operating leased assets currently and verify they are setup as non-depreciable. You may also create new asset categories for your operating leased assets with a status of non-depreciable. Your asset categories used on finance lease assets should already be configured as depreciable and you should only need to identify a Related Lease Category. After transitioning to the new lease accounting standard, a lease modification may require the lease to be reclassified from operating to finance or vice versa. The Related Lease Category is used in the reclassification. See “Categories Page” (Asset Lifecycle Management Fundamentals).

For all asset categories assigned to your operating leased assets, you must select a status of non-depreciable, else you cannot capitalize the asset in AM.

## Create Capitalized Asset Profiles for Operating Leases

Use this page to create new capitalized asset profiles for operating leases. New profiles should have an acquisition code of leased, set as capitalized asset, and have a non-depreciable status. In a subsequent task, you will update the asset profile and asset category for your operating leased assets individually or en masse using the profiles created on this task. See “Setting Up Asset Profiles” (Asset Lifecycle Management Fundamentals).

## Update Asset Profiles and Categories on Operating Leases

Use this page to update the asset profile and asset category on your operating leases. You can do this individually on an asset-by-asset basis or en masse. This applies to LA leases primarily, but also to some AM leases particularly those that do not have an asset profile.



Asset profiles and categories are required on all operating leases before you can capitalize them in AM. The New Asset Category will default based on the asset profile configuration, but you can update it to another value. If you change the asset profile for a specific asset in the grid using the prompt, the system will default a new asset category based on the new asset profile.

Asset profiles provide a template for depreciation and tax information when you capitalize the asset in AM. Asset categories classify assets by type for accounting purposes.

This example illustrates the fields and controls on the Update Asset Profiles and Categories on Operating Leases page.

The screenshot displays the 'Update Asset Profiles and Categories on Operating Leases' page. The interface includes a navigation pane on the left with a 'Lease Migration Pagelet' and a 'Migration Process' section. The main content area is titled 'Search Criteria' and contains several search fields: 'LA Business Unit', 'AM Business Unit', 'Lease Number', 'Asset ID', 'Lessor ID', 'Current Profile ID', 'Lease Start Date', 'Lease End Date', 'Current Category', and 'Lease Type'. Below these fields are 'Update To' fields for 'New Profile ID' and 'New Category', along with buttons for 'Update Profile', 'Update Category', and 'Update Both'. There are also checkboxes for 'Include Assets Not Yet Updated' and 'Include Exempt Leases'. At the bottom, there is a table titled 'Asset Profile and Category for the Leases' with columns for 'LA Business Unit', 'AM Business Unit', 'Lease Name', 'Asset Identification', 'Current Profile ID', 'New Profile ID', 'Current Category', and 'New Category'. The table shows one row with search prompts in the 'New Profile ID' and 'New Category' columns.

## Define Incremental Borrowing Rates

Use this page to define your organization's incremental borrowing rates. As part of your transition to the new accounting standard and capitalization of your operating leased assets, the system uses the incremental borrowing rate to calculate PVLP for your operating leases. In a subsequent task in the activity guide, you will update your leases to use the incremental borrowing rates entered here, on this task.

Organizations electing to restate their prior year reports should consider entering rates as follows:

- You should enter one incremental borrowing rate with an 'early' effective date, for example 1/1/1901, a date earlier than the earliest start date on your operating leases. The system will apply this rate to leases starting before the earliest restatement date. This applies to AM and LA operating leases.
- You should enter additional effective dated rows to identify rate changes DURING your restatement period. If your incremental borrowing rate changed during the restatement period, you should have an effective dated row with that rate. The system will apply these effective dated rates to leases starting during the restatement period.

To use a single rate for all of your leases as of your transition date, you would only need to enter one effective dated row. The row should have an 'early date' to include all of your leases. However, the rate entered for this effective dated row should be your organization's borrowing rate as of your transition date.

See [Defining Borrowing Interest Rate](#).

## Update Interest Rates on Operating Leases en masse

Use this page to review and confirm the interest rates used to calculate initial cost (PVLP) on your operating leases.

You can review leases for an entire LA BU or AM BU, filter results for a specific lease or lease type or review leases with specific ranges for lease start date. The first time you open the page, the system will populate the Suggested Rate based on the way you have configured your incremental borrowing rate (the previous step in the guide), the start date of the lease and whether you report the lease under FASB or IASB. When you save the page the suggested interest rate is saved in the system. This applies to all leases displayed not just the leases selected with the check box. The check box on the grid is used to update leases en masse.

You might need to refresh the suggested rate if you had to go back and update your incremental borrowing rates after already reviewing and saving rates for your leases. To refresh the Suggested Interest Rate with the latest system generated information, first select the lease (or leases) by checking the box next to the lease. Then enter a value of 0 in the Suggested Rate field underneath the search criteria. Select the Update All button and you should see the suggested rate updated by the system. Save the changes.

This example illustrates the fields and controls on the Update Interest Rates on Operating Leases en masse page.

The screenshot shows the 'Update Interest Rates on Operating Leases en masse' page. On the left is a navigation pane with a tree view of migration tasks. The main area contains search criteria fields: Transition Date (01/01/2019), LA Business Unit, AM Business Unit, Lease Number, Lease Origination, Lease Start Date, Lease End Date, and Lease Type. Below these are 'Search' and 'Clear' buttons. A 'Suggested Interest Rate' field is present with an 'Update All' button. There are also 'Select All' and 'Clear All' checkboxes. At the bottom is a table with the following data:

Select	LA Business Unit	AM Business Unit	Lease Number	Lease Name	Implicit Interest Rate	Borrow Rt	Suggested Interest Rate
<input type="checkbox"/>	FRA01	FRA01	0000000021	417 Rue Madeleine	0.0000	0.0000	4.0000
<input type="checkbox"/>	FRA01	FRA01	0000000022	12 Boulevard Gautier	0.0000	0.0000	4.0000

**Note:** Exempt leases do not appear on this page.

## Update Advance/Arrears Payment Selection on Operating Leases

Use this page to update the payment type selection on your operating leases. The Advance/Arrears functionality was added to Lease Administration in a prior image and all leases were set to Arrears. Use this task in the activity guide to update the payment type on your lease payments to *Advance* where required.

This example illustrates the fields and controls on the Update Advance/Arrears Payment Selection on Operating Leases page.

The screenshot shows the 'Update Advance/Arrears Payment Selection on Operating Leases' page. The left sidebar contains a 'Guided Migration Process' tree with various steps. The main area has search criteria and a table of lease data.

**Search Criteria:**

- LA Business Unit: [Text Input]
- Lease Number: [Text Input]
- Lease Start Date: [Date Picker] To: [Date Picker]
- Lease End Date: [Date Picker] To: [Date Picker]
- Financial Term: [Dropdown]

**Lease Payment Type:** [Dropdown] [Update All]

Select All  Clear All

**Lease Payment Type Update**

Select	Business Unit	Lease Number	Lease Name	Payment Group	Financial Term	*Payment Type	Lease Start Date	L
1 <input type="checkbox"/>	FRA01	0000000021	417 Rue Madeleine	1	Base Rent	Arrears	04/01/2004	03.
2 <input type="checkbox"/>	FRA01	0000000022	12 Boulevard Gautier	1	Base Rent	Arrears	08/01/2003	07.
3 <input type="checkbox"/>	FRA01	0000000024	67-5 Rue de la Chamonix	1	Base Rent	Arrears	07/16/2004	07.

**Note:** Exempt leases do not appear on this page.

## Run Transition Analytics for Operating Leases

Use this page to execute a process to summarize the lease payment data used to transition to the new accounting standard.

This task runs a process and populates a reporting table summarizing the remaining lease payments on your operating leases at points in time over the life of the lease. You can use the results of this process to review the initial cost amounts the system will capitalize as of your transition date. Only lease payments dated on or after the date on the run control are included in the process. If you would like to see payment information for earlier periods, enter an earlier date on the run control.

You must run the transition analytics process for your leases before you can transition them to the new accounting standard. In addition, this process is the only way to review the initial cost amounts the system will use to capitalize your assets in AM when you transition to the new accounting standard.

This example illustrates the fields and controls on the Run Transition Analytics for Operating Leases.

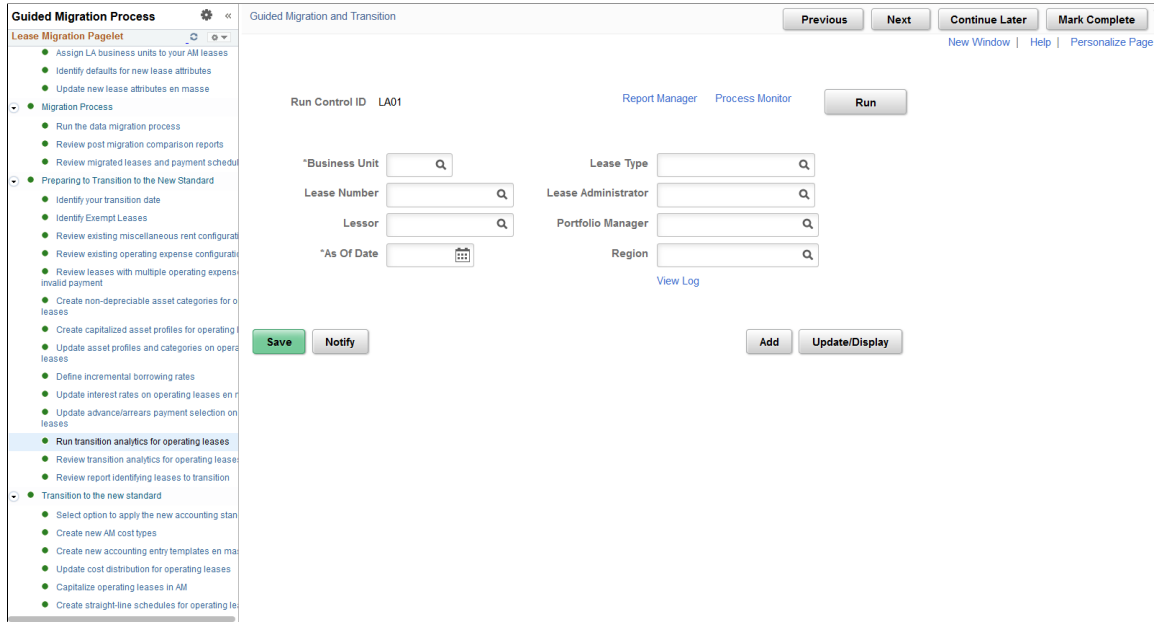

**Note:** Exempt leases do not appear on this page.

## Review Transition Analytics for Operating Leases

Use this page to review a summary of remaining lease payments as of a specific date. You must enter a date and business unit on the prompt. The pivot grid summarizes the remaining payments as of the date entered. ‘Amount’ represents the full amount (or undiscounted amount) of the remaining payments. ‘Obligation’ represents the discounted amount of your remaining payments and ‘Interest’ represents the interest portion of your remaining payments.

The pivot grid includes base rents as well as miscellaneous rents and operating expenses identified as ‘Included in Lease Payments’. It also includes guaranteed residual value amounts. You can export the results to Excel. To review a larger amount of data at one time you can run the query RE\_TRANSITION\_ANALYTICS, which is the basis for the numbers in the pivot grid.

Note that in the previous step of the guide, you ran the process to populate the pivot grid. This process summarized lease payments dated on or after the date on the run control. If you identify in the pivot grid that payments are missing, then you need to rerun the transition analytics process with an earlier date. To ensure accurate reporting, select an earlier date on the run control.

This example illustrates the fields and controls on the Review Transition Analytics for Operating Leases.

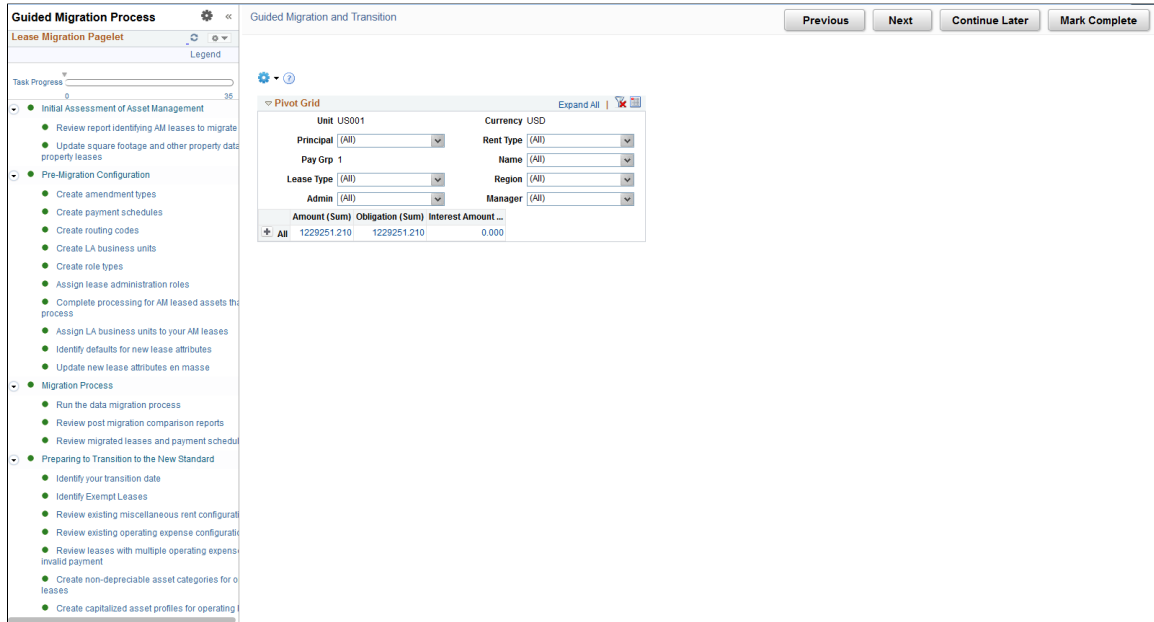

**Note:** Exempt leases do not appear on this page.

### Review Report Identifying Leases to Transition

Use this page to review your operating leases before they transition to the new accounting standard. You will transition all operating leases to the new accounting standard including those originating in AM and others originating in LA.

This is the last task in the activity guide before you transition to the new accounting standard and begin applying ASC 842 and IFRS 16.

This example illustrates the fields and controls on the Review Report Identifying Leases to Transition page.

The screenshot shows the 'Guided Migration Process' interface. On the left is a navigation pane with a tree view of tasks. The main area is titled 'Guided Migration and Transition' and contains a 'Search Criteria' section with input fields for Business Unit, Lease Number, Lease Status, Lease Start Date, and Lease End Date. Below this is a 'Lease Details' table with 6 rows of lease information.

	Business Unit	Lease Number	Lease Name	Lease Status	Lease Start Date	Lease End Date
1	FRA01	0000000023	277 Rue Cler	Expired	10/15/2000	10/14/2010
2	FRA01	0000000024	67-5 Rue de la Chamonix	Active	07/16/2004	07/15/2014
3	FRA01	0000000027	775 Boulevard Volterre	Active	12/26/1996	12/25/2016
4	JPN01	0000000062	Space 201211 - Tenjin Machi 604	Active	01/01/2005	12/31/2016
5	JPN01	0000000063	Space 102222 - Tenjin Machi 604	Active	01/01/2005	12/31/2008
6	US001	0000000029	Space 1013 - 56 Second Street	Active	01/01/2000	12/31/2015

**Note:** Exempt leases do not appear on this page.

## Transition to the New Standard

This section includes tasks to complete your transition to the new accounting standard. You will identify in the system that you are ready to apply the new accounting standard. After making this selection, you will review existing accounting configuration and add new accounting configuration to support processing under the new accounting standard. You will assign cost distributions and then run a process to capitalize your operating leases.

Tasks in this section apply to leases originating in AM and leases originating in LA.

### Select Option to Apply the New Accounting Standard

Use this page to identify that you are now applying the new accounting standard, ASC 842, IFRS 16 and GASB 87. The data migration should be completed before you select the Apply ASC 842, GASB 87, and IFRS 16 Accounting option. Once this option is selected and the change saved, the new Lease Administration functionality shared with Asset Management will become active.

**Note:** You cannot change this selection after saving the page. You should make this selection only after you have completed your final processing under the old accounting standards.

This example illustrates the fields and controls on the Select Option to Apply the New Accounting Standard.

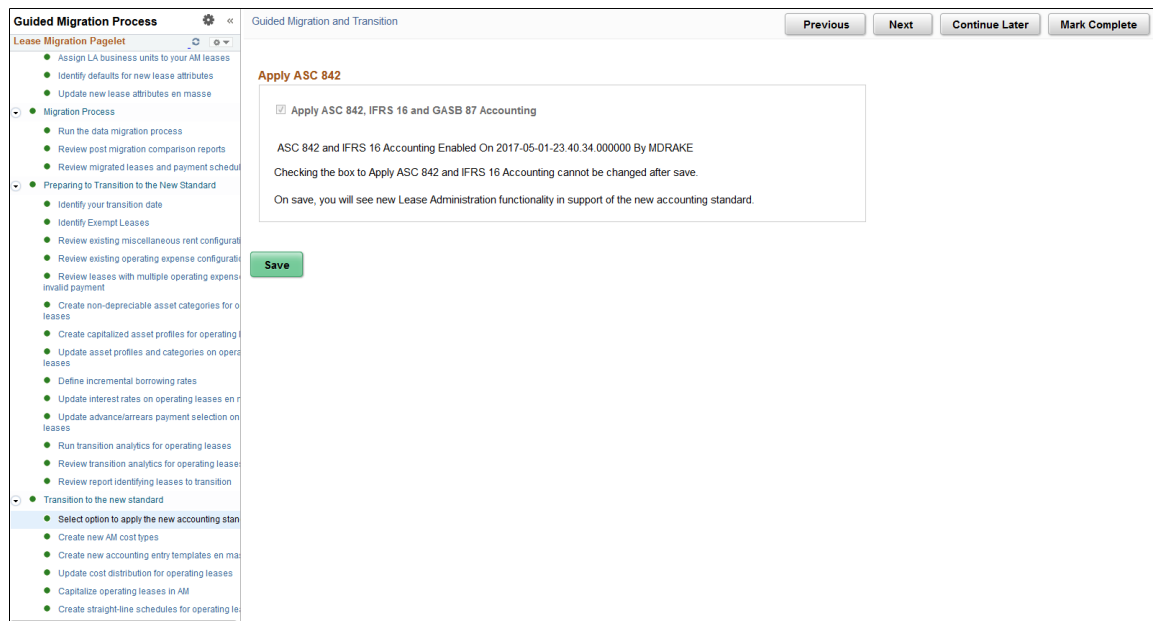

## Create new AM cost types

Use this page to create three new cost types in Asset Management. You must create new cost types for Rent Expense, Lease Incentives and Lease Remeasurement. See “Cost Types Page” (Asset Lifecycle Management Fundamentals).

## Create New Accounting Entry Templates en masse

Use this page to create new accounting entry templates (AETs) for use under the new accounting standard. You should create new accounting entry templates for Rent Expense, Rent Expense Contra, Accumulated Amortization, Lease Incentives and Lease Remeasurement. See “Defining Accounting Entries” (Asset Lifecycle Management Fundamentals).

## Update Cost Distribution for Operating Leases

Use this page to update the cost distribution for your operating leases. You can filter your search criteria to include only those leases not yet updated. You must update the asset's cost distribution before you can capitalize the asset in AM.

For AM leases, you will see the cost distribution from AM. However, you will need to open the cost distribution and confirm the accounts to use under the new accounting standard. These will default in from the AM Accounting Entry Templates, but you can override them. For LA leases, you will need to identify the detail general ledger ChartFields for the asset and the general ledger accounts. This task may take a significant amount of time particularly for your operating leases originating in LA, if you intend to update multiple ChartFields with information. This task cannot be started until after you select to apply ASC 842 and IFRS 16, and must be completed before you can capitalize your operating leases in AM. We recommend gathering the required information to complete this task earlier in the process, so you can complete the task quickly during your first closing cycle under the new accounting standard.

This example illustrates the fields and controls on the Update Cost Distribution for Operating Leases page.

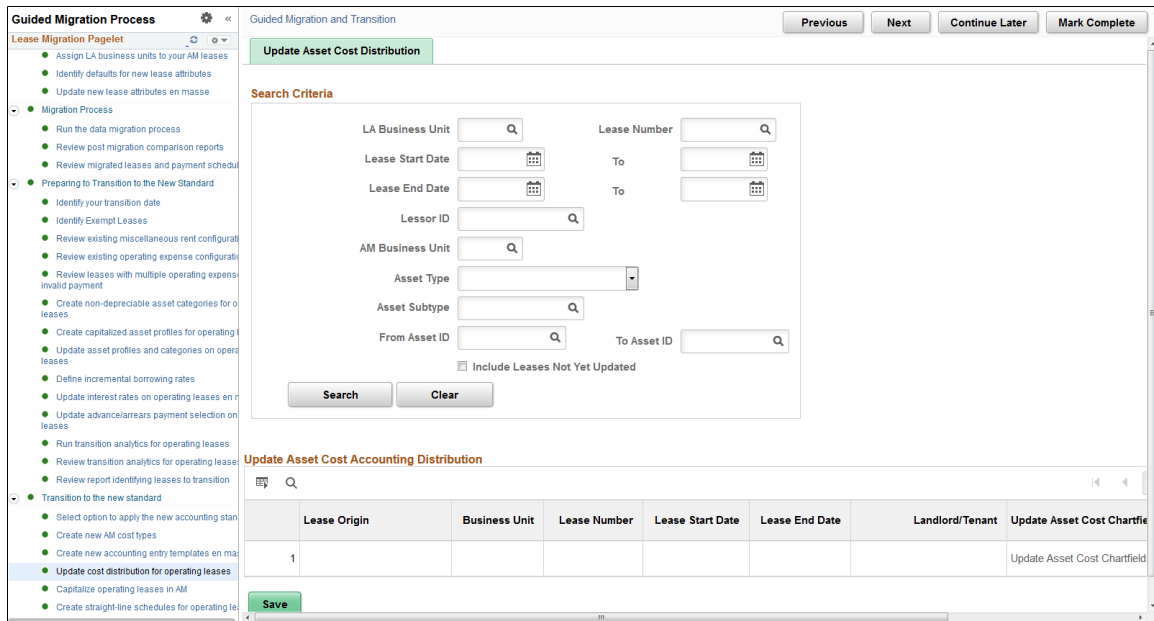

**Note:** Exempt leases do not appear on this page.

**Note:** If you plan to capitalize a lease and update the cost distribution information, but later decide the lease is exempt, the asset cost distribution previously entered is deleted. The underlying asset in an exempt lease is not capitalized.

### Capitalize Operating Leases in AM

Use this page to capitalize your operating leases in AM. The page will display all operating leases that you have not already capitalized regardless of end date. You should run the capitalization process for all leases including those that have ended even though the capitalization process may result in a zero cost value.

The capitalization process updates many data fields in AM and LA with the following being most notable:

- Creates a capitalized asset in AM.
- Sets the lease classification on the lease header as ‘Capital’ in LA. With new functionality, you classify individual assets on the lease as finance or operating and the lease header classification is hidden.

After running the process, you can return to this page to see if the process capitalized the asset successfully. If the asset appears on the page, then the process did not capitalize the asset and you should select the Error Details link to review the reasons.



This example illustrates the fields and controls on the Capitalize Operating Leases in AM page.

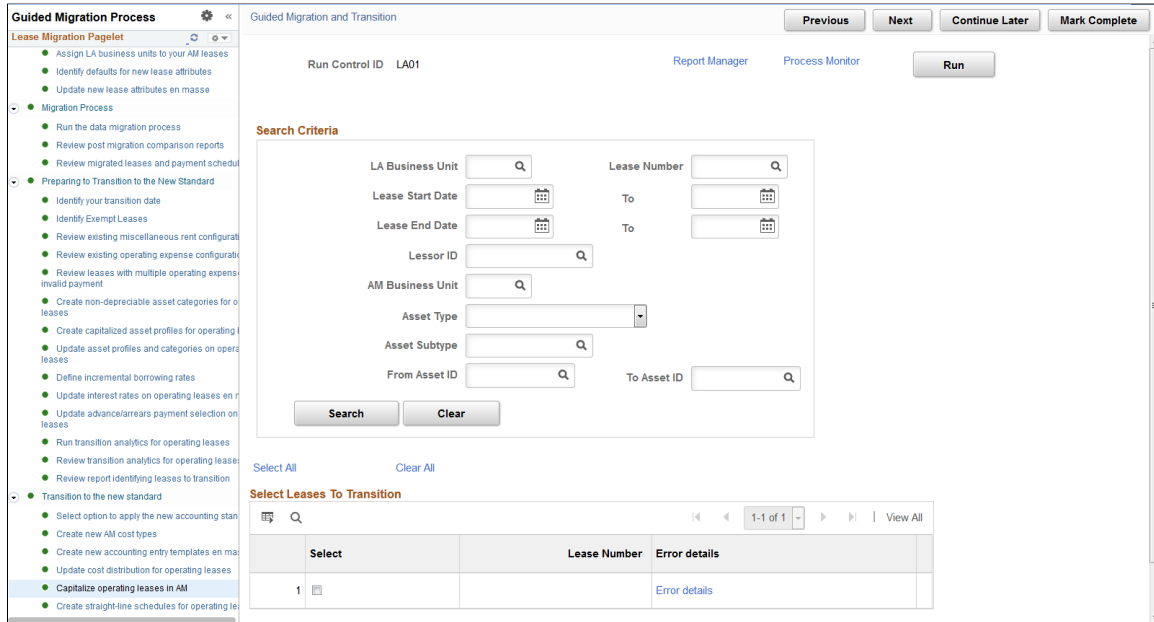

**Note:** Exempt leases do not appear on this page.

### Create Straight-Line Schedules for Operating Leases

Use this page to create straight-line amortization schedules for your operating leases. Under the new accounting standard, you amortize the cost of the operating leased asset on a straight-line basis over the shorter of the asset’s useful life or lease term.

You must run this process to create the monthly expense amounts for your operating leased assets. You can run the process for a specific lease or an entire business unit.

**Note:** Oracle recommends consulting your accounting department for clarity on whether straightline accounting applies to your exempt leases. The process will exclude certain costs on these leases such as prepaids, initial direct cost, and lease incentives since these costs should be expensed when paid.

This example illustrates the fields and controls on the Create Straight-Line Schedules for Operating Leases page.

The screenshot shows a web application interface for a guided migration process. On the left is a navigation pane titled "Guided Migration Process" with a tree view of tasks. The main content area is titled "Generate Straightline Schedule" and includes a warning: "Warning: This process will overwrite any Manual Straightline Adjustments made prior to the Lease Amendment." Below the warning are links for "Report Manager" and "Process Monitor", and a "Run" button. A "Request Parameters" section contains two input fields: "Business Unit" with the value "US001" and "Lease Number" with the value "000000137". At the bottom of this section are buttons for "Save", "Return to Search", "Notify", "Add", and "Update/Display". The top right of the page has navigation buttons: "Previous", "Next", "Continue Later", and "Mark Complete".

# Managing Straightline Accounting

---

## Understanding Straightline Accounting

The Financial Accounting Standards Board (FASB) controls the accounting standards in the United States for financial statements to be in accordance with Generally Accepted Accounting Principles (GAAP). FASB-13 states that the revenue (recurring rent) from operating leases must be recognized evenly (as a straightline) over the life of the lease.

GAAP states that accruals and deferrals must be recognized in the financial statements.

- An accrual is a positive difference when the system subtracts the actual rent from the straightline rent.  
The system generates an accrual entry to debit the account for accrued/deferred rental income and credit the account for rental revenue.
- A deferral is a negative difference when the system subtracts the actual rent from the straightline rent.  
The system generates a deferral entry to debit the account for rental revenue and credit the account for accrued/deferred rental income.
- The net sum of the accruals and deferrals over the life of the lease should be zero.

PeopleSoft Lease Administration enables you to straightline recurring rent and operating expenses during setup and also apply the straightline values and accrual or deferral into the general ledger. When an amendment is created to adjust the term of the lease, you can make straightline adjustments to the unpaid remaining periods of that lease. In the event of an early termination on a lease, the accrual or deferral must be written off during the termination period. A one-time adjustment is made to end the general ledger entry and balance out the lease amounts for all paid periods.

This diagram provides an example of the straightline process flow during lease maintenance

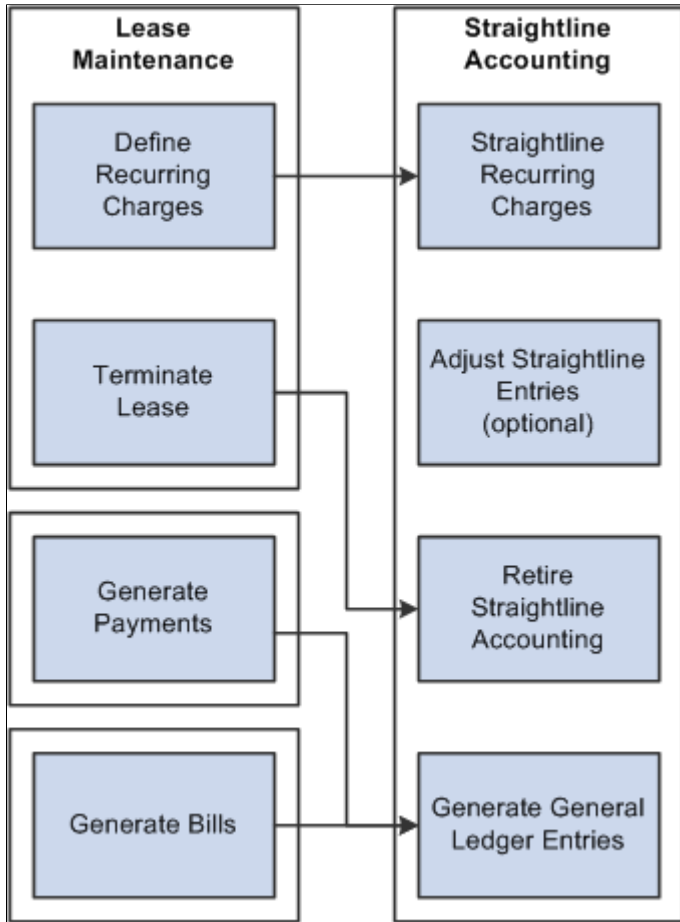

To initiate the straightline accounting process for a lease, you must:

- Create or amend an operating lease with straightline accounting terms.

If you amend a lease for early termination, the accrual or deferral must be written off during the termination period. A one-time adjustment is made to end the general ledger entry and balance out the lease amounts for all paid periods.

- Activate the lease.

The system automatically generates the transaction schedule, which is the source information for both the transaction generator and straightline accounting schedule generator.

- Run the Straightline Schedule Generator Application Engine process (RE\_FASB\_GEN).

When you run this process, the system builds out the straightline schedule for the lease. The proposed straightline amounts, actual billed amounts, and accrual or deferral amounts are listed for review.

The proposed straightline values are stored on a staging table and cannot take effect until the lease administrator applies the values to the General Ledger. The total straightline must balance out with the total actual billed. The net accrual or deferral is equal to zero, if not the system generates an error.

- (Optional) Edit or perform manual adjustments.

You can overwrite the straightline amount. The system provides an error message if the changed straightline amount causes an out of balance between total actual rent and total straightline value.

- Post straightline accounting entries to the General Ledger.

After reviewing the proposed straightline values, run Post Straightline Entries process to post straightline entries to the journal staging table. General Ledger must run the Journal Generator process to post the entries from the staging table.

- Review posted entries to General Ledger.

After the entries are posted to the general ledger, you can view the posting status online.

Typically the straightline accounting process is performed as a part of the month-end close process. You can post straightline accounting on a monthly basis because the process of straightline operates only monthly. The system can accept any frequency of recurring rent, such as monthly, quarterly, annually, however, the straightline generator always bring straightline entries back to monthly. The system sums up the total of the recurring rent term for that lease's entire life span, and dividing the total recurring rent term by the total number of months.

<i>Month</i>	<i>Period Ratio</i>	<i>Month</i>	<i>Actual Rent</i>
1	.4667	Apr-03 (14 days only)	\$1,633.00
2	1	May-03	\$3,000.00
3	1	Jun-03	\$3,500.00
4	1	Jul-03	\$3,500.00
5	1	Aug-03	\$3,500.00
6	1	Sep-03	\$3,500.00
7	1	Oct-03	\$3,500.00
8	1	Nov-03	\$6,000.00
9	1	Dec-03	\$8,500.00
10	1	Jan-04	\$4,000.00
11	1	Feb-04	\$3,500.00
12	1	Mar-04	\$3,500.00

<i>Month</i>	<i>Period Ratio</i>	<i>Month</i>	<i>Actual Rent</i>
13	1	Apr-04	\$3,500.00
		Total	\$51,133.00

From the above schedule, the Actual Rent payment changes within the lease term. At this point, the system must straightline the Actual Rent. The mathematical formulas are as follow:

- Total Contract Rent Amount = Sum (Actual Rent Amount)  
 Total Contract Rent Amount = \$51,133.00
- Lease Period = Total Leased Days/Total Days in a Month.  
 In the above example, notice that only 14 days were leased in April-03; therefore, the period is .4667 = 14/30 days
- Total Periods in the Lease = Sum (Lease Periods)  
 Total Periods in the Lease = 12.4667
- Straightline Amount = Total Rent Amount/Total Periods in the Lease  
 Straightline Amount = \$51,133.00 divided by 12.4667 = \$4,101.58
- Straightline Amount Per Period = Straightline Amount × Lease Period  
 Straightline Amount Per Period for Month 1 = \$4,101.58 × .4667 = \$1,914.07
- Accrual or (Deferral) Per Period = Straightline Amount Per Period – Actual Rent Amount Per Period  
 For the month of April: \$1,914.07 - \$1,633 = \$281.07 Accrual  
 For the month of November: \$4,101.58 - \$6,000.00 = (\$1,898.42) Deferral  
 For the month of December: \$4,101.58 - \$8,500.00 = (\$4,398.42) Deferral

<i>Months</i>	<i>Month</i>	<i>Actual Rent</i>	<i>Straight Line Per Period</i>	<i>Difference Accrual/ (Deferral)</i>
1	Apr-03 (14 days only)	\$1,633.00	\$1,914.07	\$281.07
2	May-03	\$3,000.00	\$4,101.58	\$1101.58
3	Jun-03	\$3,500.00	\$4,101.58	\$601.58
4	Jul-03	\$3,500.00	\$4,101.58	\$601.58
5	Aug-03	\$3,500.00	\$4,101.58	\$601.58

<i>Months</i>	<i>Month</i>	<i>Actual Rent</i>	<i>Straight Line Per Period</i>	<i>Difference Accrual/ (Deferral)</i>
6	Sep-03	\$3,500.00	\$4,101.58	\$601.58
7	Oct-03	\$3,500.00	\$4,101.58	\$601.58
8	Nov-03	\$6,000.00	\$4,101.58	(\$1898.42)
9	Dec-03	\$8,500.00	\$4,101.58	(\$4,398.42)
10	Jan-04	\$4,000.00	\$4,101.58	\$101.58
11	Feb-04	\$3,500.00	\$4,101.58	\$601.58
12	Mar-04	\$3,500.00	\$4,101.58	\$601.58
13	Apr-04	\$3,500.00	\$4,101.58	\$601.58
Total		\$51,133.00	\$51,133.00	\$0.00

**Note:** Free Rent – Where rent amount is zero (0) must be included in the straightline calculations. Zero rent amounts must be reported and spread evenly across periods.

## Prerequisites

Before you can use straightline accounting, you need to:

- Establish a lease administration business unit.
- Set up accounting rules for straightline accounting entries.
- Create an accounting entry template for posting to General Ledger.
- Create a lease with financial terms that require straightline accounting processing.

## Generating Straightline Accounting Schedules

This topic lists the page used to generate straightline accounting schedules.

After you create and activate a lease with transactions for straightline accounting, you must run the Generate Straightline Schedule Application Engine process (RE\_FASB\_GEN).

---

**Warning!** This process overwrites any manual adjustments made prior to the lease amendment.

---

## Page Used to Generate Straightline Accounting Schedule

<i>Page Name</i>	<i>Definition Name</i>	<i>Usage</i>
Generate Straightline Schedule	RE_FASB_RUNCNTL	<p>Enter the run control parameters to generate straightline accounting schedule for a business unit or a specific lease.</p> <hr/> <p><b>Note:</b> As part of the shared product functionality, the Generate Straightline Schedule page can also be accessed through the Asset Management navigation as follows: Asset Management &gt; Asset Transactions &gt; Leased Assets &gt; Generate Straightline Schedule.</p>

---

## Performing Manual Straightline Adjustments

This topic discusses how to perform manual straightline adjustments.

### Pages Used to Perform Manual Straightline Adjustments

<i>Page Name</i>	<i>Definition Name</i>	<i>Usage</i>
<u>Manual Straightline Adjustment Page</u>	RE_FASB_ADJUSTMENT	Review or adjust the generated straightline schedule. You can optionally adjust the straightline schedule prior to posting to the general ledger.
<u>Accounting Distributions Page</u>	RE_FASBADJ_DST_SEC	Override the business unit accounting rules by percentage or area.

### Manual Straightline Adjustment Page

Use the Manual Straightline Adjustments page (RE\_FASB\_ADJUSTMENT ) to review or adjust the generated straightline schedule.

You can optionally adjust the straightline schedule prior to posting to the general ledger.

Navigation:

**Lease Administration > Integrations > Manual SL Adjustment**

**Asset Management > Asset Transactions > Leased Assets > Manual Straightline Adjustment**



**Note:** As part of the shared product functionality, the Manual Straightline Adjustment page can also be accessed through the Asset Management navigation.

This example illustrates the fields and controls on the Manual Straightline Adjustment page (partial). You can find definitions for the fields and controls later on this page.

Manual Straightline Adjustment								
Lease Number 0000000014				Lease Name 5000 Yellowstone Parkway				
Rentable Area 64.333				Transaction Group Base Rent				
Straightline Schedule								
Year	Period	Period Ratio	Status	Currency	Actual Amount	Straightline Amount	Accr / Defer	Adjustment Amount
2004	4	1.0000	Pending	USD	10916.67	13863.80	2947.13	
2004	5	1.0000	Pending	USD	10916.67	13863.80	2947.13	
2004	6	1.0000	Pending	USD	10916.67	13863.80	2947.13	
2004	7	1.0000	Pending	USD	10916.67	13863.80	2947.13	
2004	8	1.0000	Pending	USD	10916.67	13863.80	2947.13	
2004	9	1.0000	Pending	USD	10916.67	13863.80	2947.13	
2004	10	1.0000	Pending	USD	10916.67	13863.80	2947.13	
2004	11	1.0000	Pending	USD	10916.67	13863.80	2947.13	
2004	12	1.0000	Pending	USD	10916.67	13863.80	2947.13	
2005	1	1.0000	Pending	USD	10916.67	13863.80	2947.13	
2005	2	1.0000	Pending	USD	10916.67	13863.80	2947.13	
2005	3	1.0000	Pending	USD	10916.67	13863.80	2947.13	
2005	4	1.0000	Pending	USD	10916.67	13863.80	2947.13	
2005	5	1.0000	Pending	USD	10916.67	13863.80	2947.13	
2005	6	1.0000	Pending	USD	10916.67	13863.80	2947.13	

Accounting Distribution

**Note:** Specific months posted to the general ledger are shown as display-only and cannot be adjusted.

<b>Field or Control</b>	<b>Description</b>
<b>Period</b>	Displays the accounting period that the straightline accrual or deferral is in.
<b>Period Ratio</b>	Displays the period ratio. This is the number of days in a lease period (to the total number of days for the accounting period).
<b>Status</b>	Displays the status of the of the transaction. Transactions posted to the general ledger are display-only and cannot be modified.
<b>Actual Amount</b>	Displays the actual monthly rent amount prior to the straightline process. This amount is the recurring amount scheduled from the lease financial terms.
<b>Straightline Amount</b>	Displays the calculated straightline amount. The calculation method is (Total Lease Amount – Total Paid Amount) divided by (Sum of Unpaid Period Ratio).

<b>Field or Control</b>	<b>Description</b>
<b>Accr/Defer</b> (Accrual/Deferral)	Displays the amount to be accrued or deferred in the general ledger. The amount is the Actual Amount – Straightline Amount = Accrual or Deferral (negative value).
<b>Adjustment Amount</b>	Enter the amount to adjust the straightline value. The calculation method used is (Total Paid Amount) divided by (Total Unpaid Period Ratio).
<b>Calculate</b>	Click the button to recalculate the amounts after entering the adjustment amount.
<b>Reset</b>	Click to return all values on the page back to the original values from the database. This page can be used as a worksheet for what-if processing that you might want to undo later. If you have not saved your changes to the database yet, clicking on this button resets the values.
<b>Accounting Distribution</b>	Click this link to access the Accounting Distributions page and override to override the business unit accounting rules.

## Accounting Distributions Page

Use the Accounting Distributions page (RE\_FASBADJ\_DST\_SEC) to override the business unit accounting rules by percentage or area.

Navigation:

Click the **Accounting Distributions** link on the Manual Straightline Adjustments page.

This example illustrates the fields and controls on the Manual Straightline Adjustment - Accounting Distribution page. You can find definitions for the fields and controls later on this page.

**Straightline Adjustment**

This page is meant for overriding the default accounting rule setup at the Business Unit. If the financial term is supposed to follow the Business Unit default accounting rule, this page can be ignored.

**Distribute By...**

Percentage

Area

**None**      Use default accounting distribution for Business Unit

Accounting Distribution - Accrual										
Debit/Credit	Percentage	GL Business Unit	Currency Code	Account	Alternate Account	Department	Operating Unit	Fund Code	Class Field	Program Code
Debit	100.00	US001	USD	641200						
Credit	100.00	US001	USD	215000						

Accounting Distribution - Deferral										
Debit/Credit	Percentage	GL Business Unit	Currency Code	Account	Alternate Account	Department	Operating Unit	Fund Code	Class Field	Program Code
Debit	100.00	US001	USD	215000						
Credit	100.00	US001	USD	641200						

Accounting Distribution - Adjustment										
Debit/Credit	Percentage	GL Business Unit	Currency Code	Account	Alternate Account	Department	Operating Unit	Fund Code	Class Field	Program Code
Debit	100.00	US001	USD	641200						
Credit	100.00	US001	USD	215000						

If you want to keep the accounting distributions defined on the business unit, you can ignore this page.

The fields on this page differ based on the distribute by method chosen.

When you select **Percentage** or **Area** as the distribution method, the ChartField values become available for edit.

<b>Field or Control</b>	<b>Description</b>
<b>Distribute By</b>	<p>Chose a distribution method:</p> <ul style="list-style-type: none"> <li><b>Percentage:</b> Select this value to update the accounting distributions by percentage.</li> <li><b>Area:</b> Select this value to update the accounting distributions by area.</li> <li><b>None:</b> Use the default accounting distribution for the business unit.</li> </ul>
<b>Add Distribution</b>	<p>Click this button to insert a new row in the distribution lines.</p> <p>This button appears only if you select <b>Percentage</b> or <b>Area</b> as the distribution method.</p>

<b>Field or Control</b>	<b>Description</b>
<b>Delete Distribution</b>	<p>Select the Select option and click this button to delete the distribution row.</p> <p>This button appears only if you select <b>Percentage</b> or <b>Area</b> as the distribution method.</p>
<b>Select</b>	<p>This option is used to delete the distribution rows. Users can select all the distribution rows that they want to delete and then click the <b>Delete Distribution(s)</b> button to delete them.</p> <p>This option appears only if you select <b>Percentage</b> or <b>Area</b> as the distribution method.</p>
<b>Percentage</b>	<p>Enter the percentage to apply to this distribution line. The total percentage for all debit entries must equal 100 and the total percentage for all credit entries must be 100.</p> <p>This field appears only if you select <b>Percentage</b> as the distribution method.</p>
<b>Area</b>	<p>Enter the area to apply to the distribution line.</p> <p>This field appears only if you select <b>Area</b> as the distribution method.</p>
<b>Valid</b>	<p>This option indicates whether the combination of ChartFields selected for the distribution row is valid or not. The Combo Edit check is performed when you exit the accounting distribution page. If the distribution line has a valid combination, then the option for that row will be checked. If there are accounting distributions with invalid combinations, then an error will be displayed when you exit the page, save the lease or activate the lease.</p> <p>This option appears only if you select <b>Percentage</b> or <b>Area</b> as the distribution method.</p>

---

## Posting Straightline Entries

This topic provides an overview of posting straightline accounting entries and discusses how to post straightline entries.

## Page Used to Post Straightline Entries

<i>Page Name</i>	<i>Definition Name</i>	<i>Usage</i>
Post Straightline Entries Page	RE_STGL_RUNCNTL	Enter the run control parameters and run the process to insert data into the journal interface tables for the selected period.  You must run the Journal Generator in PeopleSoft General Ledger to post the transactions to the ledger.

## Understanding Posting Straightline Entries

To post straightline entries to the journal staging table, you must run the Post Straightline Entries Application Engine process (RE\_STGL\_POST). The posting process uses the general ledger journal template defined at the Lease Administration business unit setup and loads a Journal Generator staging table in preparation for the Journal Generator process. You can post only one period at a time. Once the posting process is complete, the accounting entries are loaded into the Journal Generator staging table (RE\_STLINE\_GL). You need to run Journal Generator so the data can be posted into the general ledger.

See “Understanding Journal Generator” (Application Fundamentals).

## Post Straightline Entries Page

Use the Post Straightline Entries page (RE\_STGL\_RUNCNTL) to enter the run control parameters and run the process to insert data into the journal interface tables for the selected period.

Navigation:

**Lease Administration > Integrations > Post Straight Line Entries**

This example illustrates the fields and controls on the Post Straightline Entries page. You can find definitions for the fields and controls later on this page.

The screenshot shows the 'Post Straightline Entries' page. At the top, there is a 'Run Control ID R' field and a 'Report Manager Process Monitor' button with a 'Run' button next to it. Below this is the 'GL Posting Parameters' section, which includes several search fields: '\*LA Business Unit', '\*Accounting Date', '\*Accounting Period From', 'Lease Number', '\*Fiscal Year', and 'Accounting Period To'. There are also navigation controls like 'Find | View All', 'First', '1 of 1', and 'Last'.

<i>Field or Control</i>	<i>Description</i>
<b>LA Business Unit</b> (Lease Administration Business Unit)	Select the Lease Administration business unit to post your transactions. If you do not select a business unit, the system will process all business units.

<i>Field or Control</i>	<i>Description</i>
<b>Accounting Date</b>	Select the date of the accounting entry recognized in the general ledger (system date or the run date).
<b>Fiscal Year</b>	Select the fiscal year you want to post your transaction.
<b>Accounting Period</b>	Select the accounting period (period in which transactions can be posted) of the transactions you want to post to the journal staging table.

## Viewing Posted Straightline Accounting Entries

This topic provides an overview of posted straightline accounting entries and discusses how to view posted straightline accounting entries.

## Pages Used to View Posted Straightline Accounting Entries

<i>Page Name</i>	<i>Definition Name</i>	<i>Usage</i>
<u>Posted Straightline Accounting Page</u>	RE_STGL_VIEW	View transactions posted to the staging tables and also transactions posted to the general ledger through the Journal Generator.
<u>Review Journal Entries Page</u>	RE_GL_DRILL	Inquire about the details of each journal entry after you've run the Post Straightline Entries process and your accounting entries have gone through the Journal Generator process and have posted to the general ledger.
Journal Lines Page	JOURNAL_LN_FS	View the details of the journal.  <u>Review Journal Entries Page</u>

## Understanding Posted Straightline Accounting Entries

PeopleSoft Lease Administration enables you to view all transactions posted to the RE\_STLINE\_GL table, which is a staging table. When PeopleSoft General Ledger runs the Journal Generator process, the system picks up the transactions on the RE\_STLINE\_GL table and sends the transactions to PeopleSoft General Ledger.

Although transactions are posted to the staging table, not all transactions are generated to the general ledger until PeopleSoft General Ledger runs the Journal Generator process. You can view the transaction status as well as the general ledger distribution status. The transaction status displays whether the transaction has been picked up by the Journal Generator in PeopleSoft General Ledger and any

outstanding transactions that is still in pending status. You can also view the accounting distribution information related to the transaction.

## Posted Straightline Accounting Page

Use the Posted Straightline Accounting page (RE\_STGL\_VIEW) to view transactions posted to the staging tables and also transactions posted to the general ledger through the Journal Generator.

Navigation:

**Lease Administration > Integrations > Posted Straight Line Acctg > Posted Straightline Accounting**

This example illustrates the fields and controls on the Posted Straightline Accounting page. You can find definitions for the fields and controls later on this page.

The screenshot shows the 'Posted Straightline Accounting' page. At the top, there is a 'Search Criteria' section with several input fields: '\*Business Unit' (set to US001), 'Lease Number', 'Fiscal Year From' (set to 2013), 'Fiscal Year To' (set to 2013), 'Accounting Period From', 'Accounting Period To', 'GL Distribution Status' (a dropdown menu), and 'Journal ID'. A 'Search' button is located below these fields. Below the search criteria is a 'Search Results' section with a table. The table has columns for Lease Number, Debit / Credit Indicator, Accounting Date, Transaction Group, Amount, Currency, Fiscal Year, Accounting Period, Journal Template, Business Unit, and GL Busin. The table currently shows 1 of 1 results.

<b>Field or Control</b>	<b>Description</b>
<b>Fiscal Year From</b> and <b>Fiscal Year To</b>	Select the fiscal year range for transactions that you want to view. The Journal Generator process populates the fiscal year after it distributes the accounting entry to a general ledger journal based on the journal date.
<b>Accounting Period From</b> and <b>Accounting Period To</b>	Enter the range for the accounting period you want to view. The Journal Generator process populates the accounting period after it distributes the accounting entry to a general ledger journal based on the journal date.
<b>GL Distribution Status</b> (general ledger distribution status)	Select the status of transaction you want to view. Values are: <i>Creating Journals, Distributed, Generated, Hold, Ignored, Modified, None, and To Be Processed.</i>
<b>Journal ID</b>	Enter the journal ID for the entries that you want to view.
<b>Debit/Credit Indicator</b>	Displays whether the transaction is a debit or a credit.

<b>Field or Control</b>	<b>Description</b>
<b>Accounting Date</b>	Displays the date of the accounting entry recognized in general ledger (system date or the run date).
<b>Amount</b>	Displays the transaction currency amount (straightlined amount from the lease).
<b>Journal Template</b>	Displays the journal generator template ID. Identifies the journal defaults and summarization options for the accounting entry.
<b>GL Business Unit</b> (general ledger business unit)	Displays the general ledger business unit for the entry.
<b>Distribution Status</b>	Displays the status of the straightline entry.
<b>Journal ID</b>	Displays the journal ID which is populated by the Journal Generator process after it distributes the accounting entry to a general ledger journal.
<b>GL Journal Line Number</b> (general ledger journal line number)	Displays the general ledger journal line number which is populated by the Journal Generator process after it distributes the accounting entry to a general ledger journal.
<b>Journal Date</b>	Displays the journal date which is populated by the Journal Generator process after it distributes the accounting entry to a general ledger journal.
<b>Journal Line Reference</b>	Displays the journal line reference used to track the source of the transaction. This reference line is populated by the Journal Generator after distribution of the accounting entries to a general ledger.
<b>Journal Line Description</b>	Displays the description populated by the Journal Generator after distribution of the accounting entry to a general ledger journal.

See “Understanding PeopleSoft ChartFields” (Application Fundamentals).

## Review Journal Entries Page

Use the Review Journal Entries page (RE\_GL\_DRILL) to inquire about the details of each journal entry after you've run the Post Straightline Entries process and your accounting entries have gone through the Journal Generator process and have posted to the general ledger.

Navigation:

**Lease Administration > Integrations > Review Journal Entries > Review Journal Entries**



This example illustrates the fields and controls on the Review Journal Entries page. You can find definitions for the fields and controls later on this page.

The screenshot shows the 'Review Journal Entries' interface. At the top, it displays 'Journal ID' and 'Business Unit US001'. Below this, it shows 'Journal 0000000042', 'Date 03/31/2006', and 'GL Journal'. Further down, it lists 'Ledger LOCAL', 'Line 1', and 'Line Descr'. A 'Chartfields' section contains a table with columns: Account, Oper Unit, Fund, Dept, Program, Class, Bud Ref, Product, PC Bus Unit, Project, Activity, Analysis Type, Source Type, and Category. Below the chartfields, there are sections for 'Base Currency USD', 'Currency USD', and 'Statistics Code'. A 'Details' section at the bottom includes a 'Lease Information' tab and a table with columns: Lease Number, Lease Name, Transaction Group, Amount, and Currency. The table shows a lease number '0000000032' with a name 'Space 1031 - 56 Second Street' and a transaction group 'Base Rent' for an amount of '45.06 USD'.

<b>Field or Control</b>	<b>Description</b>
<b>Unit</b>	Displays the general ledger business unit.
<b>Journal</b>	Displays the general ledger journal ID.
<b>Line Descr</b> (line description)	Displays the journal line description, if you entered a line description when you created the line.
<b>GL Journal</b>	Click to access the Journal Lines page to view the details of the journal for this accounting line.
<b>Statistic Amount</b> and <b>Stat</b>	Displays the statistical amount and statistical code if you created statistical entries for the line.
<b>Base Amount DR</b> (base amount debit) or <b>Base Amount CR</b> (base amount credit)	Displays the debit or credit amount for the journal in the base currency of the ledger.
<b>Transaction Amount DR</b> (transaction debit amount) or <b>Transaction Amount CR</b> (transaction credit amount)	Displays the debit or credit amount in the transaction currency.
<b>Lease Number</b>	Click to access the Posted Straightline Accounting page on which you can view the transactions posted to the general ledger for this lease.



# Amending Leases

---

## Understanding Lease Amendments

A lease amendment is any change made to an active lease for which you alter the fundamental obligations and entitlements of the lease; that is, you change or add to the lease values that you specified in the Maintain Lease component. Use the Management Amendment feature to amend a lease. Before you create an amendment to a lease, you must first understand the difference between maintaining and amending a lease.

## Maintaining Leases

Maintaining a lease consists of changing certain fields on an active lease—such as lease name, lease administrator or portfolio manager, and options and critical dates notifications—without an amendment. Any changes that do not affect the fundamental obligations and entitlement of the lease can be made through the Maintain Lease component.

## Amending Leases

Fields that require an amendment can be edited only through the amendment pages. The edits that you can make through amendment processing include changing the landlord or tenant, lease timetable, property list, financial terms, clauses, and so on. You can amend the details of the lease as long as an amendment is in pending status. Before you can create an amendment, the lease must be in active or holdover status. You can create a new amendment or retrieve an existing pending amendment to edit, activate, or delete.

To amend a lease, select *Manage Amendments* in the **Action** field. The **Action** field appears on all pages within the Maintain Lease component. You must enter the amendment details that include the amendment type and reason. After you save the details, you can amend the lease. The system allows you to modify fields on these pages: General Information - Editing Pending Amendment, Financial Terms - Editing Pending Amendment, and Clauses - Editing Pending Amendment in the Amend Lease component. When you save the amendment, the system saves the new data in separate amendment tables and assigns an amendment number to the amendment. Just one amendment can be in pending status at a time.

Lease amendments do not affect the originating active lease until the amendment is processed, reviewed, and activated because the amendment processing and review can potentially take a significant amount of time. As a result, an amendment should not affect the normal processing of an existing active lease until you activate it. When you activate an amendment, the system sets the amendment status to active, and the values that you specified for that amendment become the current active lease values.

You can review current or previously replaced amendments on the Amendments - Amendment History page. For example, when you amend a lease with multiple amendments, you can view a change log to see what terms were changed on a particular amendment. This log summarizes the changes by the lease sections and displays the original values and the new revised values.

## Decrease in Lease Scope (Partial Lease Retirement)

The lease amendment component enables you to record a decrease in lease scope (a lease modification that terminates the right of use of one or more underlying assets, partially or in full, before the expiration of the lease term). A decrease in lease scope occurs when there is a:

- Decrease in property rentable area.
- Full retirement of one or more assets.
- Partial reduction by quantity for an asset.

Use the Decrease in Scope option to create a decrease in scope amendment. Unlike other amendments that allow you to perform multiple transactions in the same amendment, the Decrease in Scope amendment only allows you to perform that task.

Use the Decrease in ROU tab on the [Create New Lease - General Information Page](#) to select assets with a decrease in lease scope.

---

**Note:** Full lease termination and expiration are managed using Lease Actions.

For more information, see the 'Lease Actions' section of the [Understanding General Lease Information](#) topic.

---

---

## Understanding Amendment Status

The amendment status controls when you can enter data into the system for an amendment, when the system can process an amendment, and when an amendment becomes active. These are the status values for an amendment:

- *Pending*: Default status when you first create an amendment.

You can edit many fields on a lease for amendment processing. A lease can have only one pending amendment at any given time. You can edit and save pending amendments until you activate or delete the amendment.

- *Active*: The system processes only active amendments.

After you activate an amendment, the system incorporates the changes that you specified within that amendment to the lease. The system sets the status of any previous active amendment to *Replaced* because this new active lease is the latest record. When you activate the amendment, the system also validates the amendment to ensure that all required fields are populated.

- *Replaced*: After you activate an amendment, the system changes the existing active amendment status to *Replaced*.

---

**Note:** When the amendment status is *Replaced*, you can no longer edit that amendment.

---

## Amendment Status Flow

This diagram shows the flow between amendment status values and the functionality for each value.

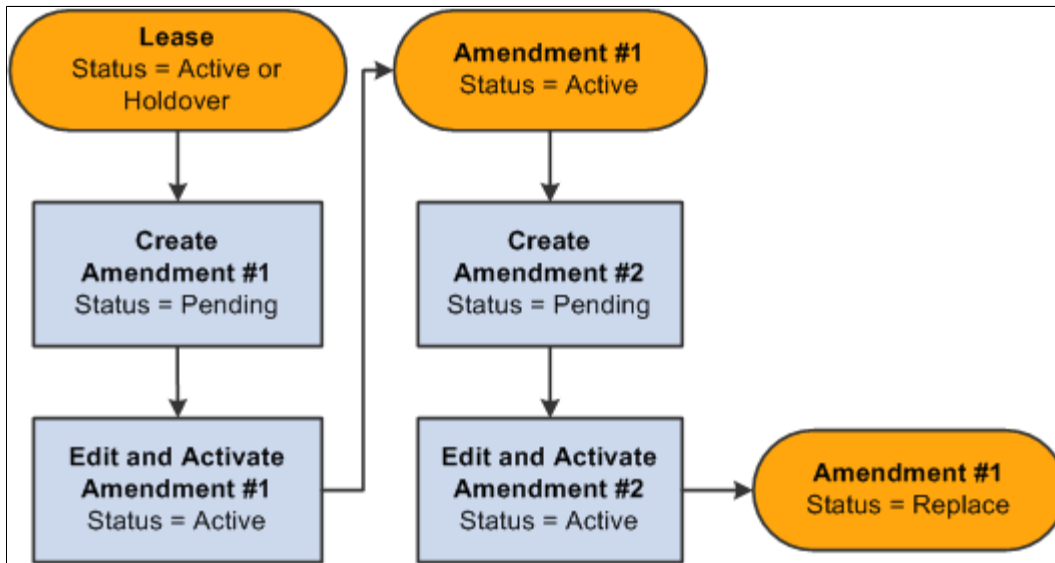

## Prerequisites

You must have a lease in *Active* or *Holdover* status in the system before you can create an amendment.

## Working with Amendments

This topic discusses how to work with amendments.

## Pages Used to Work with Amendments

<b>Page Name</b>	<b>Definition Name</b>	<b>Usage</b>
<a href="#">Create New Lease - General Information Page</a>	RE_LS_GENERAL	Create or edit an amendment by selecting <i>Manage Amendments</i> in the <b>Action</b> field on any page within the Maintain Lease component.
<a href="#">Amendments - Amendment History Page</a>	RE_LS_AMND_SUMM	Add, edit, or view amendment summary and history. View a list of all amendments made to a lease by clicking on the amendment number link to navigate to the details of those amendments.
<a href="#">Amendments - Edit Amendment Details Page</a>	RE_LS_AMND_DTL_SEC	Enter the amendment details.

<b>Page Name</b>	<b>Definition Name</b>	<b>Usage</b>
Amend Leases - General Information - Editing Pending Amendment Page	RE_LSA_GENERAL	Edit the values in the lease sections on all pages of the Amend Leases component.  <a href="#">Amendments - Edit Amendment Details Page</a>
<a href="#">Amendments - Review Amendment Details Page</a>	RE_LS_AMND_DTL_SEC	View detailed changes of an amendment. Displays the changes by lease section with current and previous values on the lease.

## Amendments - Amendment History Page

Use the Amendments - Amendment History page (RE\_LS\_AMND\_SUMM ) to add, edit, or view amendment summary and history.

View a list of all amendments made to a lease by clicking on the amendment number link to navigate to the details of those amendments.

Navigation:

- **Lease Administration > Payables Lease > Maintain Lease > General Information**

Select *Manage Amendments* from the **Action** field on any page within the Maintain Lease component and click the **Go** button.

- **Lease Administration > Receivables Lease > Maintain Lease > General Information**

Select *Manage Amendments* from the **Action** field on any page within the Maintain Lease component and click the **Go** button.

This example illustrates the fields and controls on the Amendments - Amendment History page. You can find definitions for the fields and controls later on this page.

Amendment History										
Amendment Summaries ?										
Amendment	*Amendment Type	*Reason	Status	Remeasurement	Reclassification	Activation Date	Edit	Activate	Delete	
1	Clause Modifications M	Modification to	Pending	Y	Y		Edit	Activate	Delete	
Lease										
Created By Kenneth Schumacher				Last Updated By Kenneth Schumacher						
Created On 08/22/2017 1:21:01AM				Last Updated On 08/22/2017 2:07:54AM						

<b>Field or Control</b>	<b>Description</b>
<b>Add</b>	Click to access the Amendments - Edit Amendment Details page on which you can enter details and save a new amendment. The <b>Add</b> button appears only if you do not have an existing pending amendment.

<b>Field or Control</b>	<b>Description</b>
<b>Amendment</b>	<p>Displays the amendment number for this lease.</p> <p>For active and replaced amendments, click the amendment number link to access the Amendments - Review Amendment Details page on which you can view a summary of the changes to the lease for that particular amendment.</p> <p>For pending amendments, click the amendment number link to access the Amendments - Edit Amendment Details page on which you can change the details of the amendment.</p>
<b>Remeasurement</b>	Displays the option selected for this field on the Amendment Summary page.
<b>Reclassification</b>	Displays the option selected for this field on the Amendment Summary page.
<b>Edit</b>	Click to access the Amend Lease component to amend the lease details. The <b>Edit</b> button appears only for pending amendments.
<b>Activate</b>	<p>Click to activate the amendment. The system validates the amendment for errors. You must correct all of the errors before you can activate the amendment. The <b>Activate</b> button appears only for pending amendments.</p> <p>The approval for Lease Amendments is enabled at the Lease Administration BU definition level. The Lease Amendment Approval is configurable by a variety of lease attributes and includes multi-level approval capabilities.</p> <p>If the Lease Amendment Approval is enabled, the lease amendment status remains <i>Pending</i> until the amendment is approved. Once approved, the lease amendment status changes to <i>Active</i>.</p>
<b>Delete</b>	<p>Click to delete the amendment. The <b>Delete</b> button appears only for pending amendments.</p> <hr/> <p><b>Note:</b> You cannot delete active or replaced amendments.</p> <hr/>

## Amendments - Edit Amendment Details Page

Use the Amendments - Edit Amendment Details page (RE\_LS\_AMND\_DTL\_SEC ) to enter the amendment details.

Navigation:

- Click the **Add** button on the Amendments - Amendment History page.

- Click an amendment number for a pending amendment on the Amendments - Amendment History page.

Amendments - Edit Amendment Details Page

<b>Field or Control</b>	<b>Description</b>
<b>Amendment</b>	Displays the amendment number. The system increments the number by one for each new amendment.
<b>Amendment Type</b>	Select the amendment type to categorize your amendments for reporting. This is a required field. You can select only amendment types that are active as of the effective date on the amendment type.  See <a href="#">Defining Amendment Types</a> .
<b>Reason</b>	Select the amendment reason to further categorize your amendments for reporting. This is a required field.  <b>Note:</b> The amendment type and reason have a parent-child relationship.



<b>Field or Control</b>	<b>Description</b>
<b>Remeasurement</b>	Select <i>Yes</i> or <i>No</i> option to recalculate the lease liability so that changes to the lease payments are reflected. Select <i>Yes</i> to add a new base rent or make changes to the existing base rent, when the scope of the lease remains unchanged. Select <i>No</i> to record a change in the scope of the lease.
<b>Reassess Classification</b>	Select ' <i>Yes</i> ' to reassess the lease classification after recalculation of the lease liability. This field is displayed only when <i>Yes</i> option is selected for the Remeasurement field.
<b>Decrease in Scope</b>	<p>Select '<i>Yes</i>' to indicate this amendment creates a decrease in scope. For example, when there is a decrease in property rentable area or a partial reduction by quantity for an asset.</p> <hr/> <p><b>Note:</b> You cannot set <b>Decrease in Scope</b> to '<i>Yes</i>' until the <b>Remeasurement</b> option is set to '<i>Yes</i>.'</p> <hr/> <p>Use the Decrease in ROU tab on the <a href="#">Create New Lease - General Information Page</a> to select assets with a decrease in lease scope.</p>
<b>Status</b>	Displays the status of this amendment.
<b>Activation Date</b>	Displays the date you activated the amendment.
<b>Continue</b>	Click to save the amendment. The system automatically transfers you to the Maintain Lease component where you can edit the values that need to be amended in each lease section.
<b>Cancel</b>	Click to exit the page without applying any of the changes that you may have made. The system displays the Amendment Summary page.
<b>Activate</b>	<p>Click to activate the amendment. The system validates the data in the amendment before it activates the amendment.</p> <p>If the Lease Amendment Approval is enabled, status remains <i>Pending</i> and approvers get notified. Amendment is activated after an approver validates and approves it.</p>

## Amending Lease Details

Use the Amend Leases - General Information - Editing Pending Amendment page (RE\_LSA\_GENERAL ) to edit the values in the lease sections on all pages of the Amend Leases component.

Navigation:

- Click the **Continue** button on the Amendment - Edit Amendment Details page.

- Click the **Edit** button on the Amendment - Amendment History page for a pending amendment.

## Amend Leases - General Information page - Editing Pending Amendment

You can change these fields when the amendment status is *Pending*:

- **Landlord or Tenant and Location.**

---

**Note:** If you change the landlord or tenant, the system provides you with the option to change the payor or payee information for all financial terms to the new landlord or tenant.

---

- **Termination**
- **Lease Signed Date**
- Asset List

You can add new properties, delete properties, change existing properties, or select a new primary property. For each property, you can change these fields:

- **Usable Area**
- **Rentable Area**
- **Occupancy Date**

---

**Note:** You can edit certain fields on an active lease without an amendment, such as **Lease Administrator** or **Portfolio Manager**. You must access the amendment pages to change any fields that require an amendment.

---

## Amend Leases - Financial Terms page - Editing Pending Amendment

You can change these fields only when the amendment status is *Pending*:

- **Prorata Share.**
- **Exclude Base Year.**
  - **Base Year**
  - **Base Year Amount**
- **Max Op. Ex. Increase/Year** (maximum operating expense increase per year).
  - **Amount**
  - **Percent**
- **Max Lease Rent Escalation.**
  - **Amount**
  - **Percent**

- **Add Base Rent** button.
- **Add Operating Expense** button.
- **Add Miscellaneous Rent** button.
- Financial Term links in the **Schedule of Recurring Rent** grid.

---

**Note:** You must click one of the financial term links to access the Financial Terms - Base Rent, Miscellaneous Rent, or Operating Expense Details pages to update the financial term details. If you change the payee or payor on one of these pages, then the system creates invoices or vouchers for the new payee or payor for all of the future transactions that have not be transferred to the transaction queue for approval. The transactions which are already generated in the transaction queue will not be affected by lease amendments.

---

- **Percent Rent Details** link.

---

**Note:** If you change the payee or payor for the percent rent terms, then the system uses the new payee or payor for all of the pending sales reports and all of the new pending sales reports.

---

See [Understanding Percent Rent Terms](#).

- **Security Deposit Details** link.

---

**Note:** If you change the payee or payor for the security deposit terms, then the system uses the new payee or payor to process refunds.

---

**Note:** You can change all of the fields on the financial terms pages that you access from this page while the amendment status is *Pending*. Any changes to the terms will be reflected in the transaction queue for future dated items.

Deletion of Financial Terms from a Lease is available only if there are no approved/processed transactions (payments/invoices) and no posted straightline entries for the financial terms of the lease.

---

## Amend Leases - Clauses page - Editing Pending Amendment

You can change these fields on this page when the amendment status is *Pending*:

- **Add Clause** button.
- **Delete Clause** icon.
- Clause details in the **Clauses** grid.

---

**Note:** You must click one of the clause type links to access the Clauses - Clause Details page to update the clause details.

---

## Amendments - Review Amendment Details Page

Use the Amendments - Review Amendment Details page (RE\_LS\_AMND\_DTL\_SEC ) to view detailed changes of an amendment.

Displays the changes by lease section with current and previous values on the lease.

Navigation:

Click an amendment number for active or replaced amendments on the Amendment - Amendment History page.

This example illustrates the fields and controls on the Amendments - Review Amendment Details page. You can find definitions for the fields and controls later on this page.

The screenshot displays the 'Amendments' page for a specific lease (0000000008 - 440 Wadsworth Blvd). The 'Amendment Summary' section shows Amendment 1, which is 'Replaced' and was activated on 06/07/2006 at 10:06PM. The reason for the amendment is 'New property added to lease'. Below the summary is a 'Change Log' table with the following data:

Lease Section	From Value	To Value
<b>General Information</b>		
Primary Property	3	67
Total Property Area	10,500.000	65.484
Rentable Area	10,500.000	65.484
Usable Area	10,500.000	65.484
<b>Lease Property-43</b>		
Occupancy Date	10/15/2000	
Property Rentable Area	10,500.000	0.000
Property Usable Area	10,500.000	0.000
<b>Lease Property-67</b>		

**Change Log**

<b>Field or Control</b>	<b>Description</b>
<b>Lease Section</b>	Displays the lease section where the terms were amended. You can expand and collapse the sections to view additional fields within that section.
<b>From Value</b>	Displays the original value of the lease before the amendment.
<b>To Value</b>	Displays the amended value that replaced the original value.
<b>Amendment History</b>	Click to return to the Amendments - Amendment History page.

# Setting Up Operating Expenses

---

## Understanding Operating Expenses

The cost of maintaining a property or a building, commonly referred to as Common Area Maintenance (CAM) or operating expenses, is typically considered a shared expense between a landlord and a tenant. These expenses can include utilities, taxes, insurance, maintenance, cleaning, advertising, and promotions. The actual expenses are normally based on the percentage of the space that is occupied (pro rata share) and is detailed in the actual lease. The PeopleSoft Lease Administration system enables you to set up recurring invoices or payments for estimated operating expense charges and also perform end-of-year audits and reconciliation for those shared expenses.

Typically, on an annual basis, the landlord breaks down all estimated operating expenses for the year and passes those charges through to the tenants on a monthly basis based on how much of the building that they are occupying. Since the monthly amount that is invoiced or paid is based on an estimate, the system tracks all invoices and payments that are made. At the end of the year, the landlord reconciles the estimated expenses with actual costs. A credit is issued to the tenant for overpayment or an invoice for underpayment. After the reconciliation is complete, the landlord uses that data to better estimate the upcoming year's expenses and provide a new budget and estimated bill amount. Tenants can hold CAM audits in situations where they believe that the costs are inaccurate or if they just want to verify the estimates against actuals.

## Understanding Catch Up Payments

Catch up payments are the adjustment payment for the first months of the new year. Catch up payments are the difference between the estimated payment amount paid to date in a new lease year (which has been paid at the prior year estimated payment amount) and the amount due per the new estimated payment amount. It may be possible for this to be a negative number, which would be treated as a credit. During the revision of the annual expenses through an amendment, the catch up amount should be recorded at the category level. This catch up payment will be added to the first transaction that will be sent to the transaction queue after the amendment is activated.

---

## Prerequisites

Before you can set up operating expenses, you must:

1. Set up the routing code.
2. Set up the operating expense categories.
3. Associate the routing code with the operating expense categories.
4. Add accounting rules for those operating expense categories/routing codes.

## 5. Define the Prorata Basis.

See [Understanding Operating Expense Categories](#).

---

# Establishing Operating Expenses for a Lease

This topic discusses how to establish operating expenses for a lease.

## Pages Used to Establish Operating Expenses for a Lease

<b>Page Name</b>	<b>Definition Name</b>	<b>Usage</b>
<a href="#">Financial Terms - Operating Expenses Details Page</a>	RE_LS_TRM_SEC	Define an operating expense for the lease. When you establish your operating expense details, you can set up categories and minimum and maximum amounts for that operating expense.
<a href="#">Accounting Distributions Page</a>	RE_LS_TRM_DST_SEC	Override the accounting distributions defined at the business unit level.
<a href="#">Prorata Share Details - Basis Page</a>	RE_LS_PRTA_SEC	Use this page to enter prorata basis information for this operating expense.  This link is available only if you select <i>Gross Leasable Area</i> , <i>Occupied area</i> , or <i>Occupied Area with Floor</i> as the Prorata Share Basis.
<a href="#">Cap/Minimum Details Page</a>	RE_LS_OPX_CAP_SEC	Use this page to enter caps detail information for this operating expense.  This link is available only if you select <i>Apply</i> as the CAP/MIN.
<a href="#">Operating Expense Approval Page</a>	RE_LS_OPX_APP	Approve operating expenses that exceed tolerances.

## Financial Terms - Operating Expenses Details Page

Use the Financial Terms - Operating Expenses Details page (RE\_LS\_TRM\_SEC) to define an operating expense for the lease.

When you establish your operating expense details, you can set up categories and minimum and maximum amounts for that operating expense.

Navigation:

**Lease Administration > Receivables Leases > Maintain Lease > Financial Terms**

Click the **Add Operating Expense** button.

This example illustrates the fields and controls on the Financial Terms - Operating Expense page. You can find definitions for the fields and controls later on this page.

<b>Field or Control</b>	<b>Description</b>
<b>Start Date</b>	Enter the begin date for the operating expense. The start date must occur on or after the lease start date. The system uses the lease start date as the default.
<b>End Date</b>	Enter the end date for the operating expense. The end date should occur on or before the lease termination date. The system uses the lease end date as the default.
<b>Payee</b>	Enter the entity who receives the operating expense payments. The default value is the landlord from the lease. This field appears only for operating expenses that are associated with payables leases.
<b>Location</b>	Enter the location. You can override the default location from the lease header for a financial term.

<b>Field or Control</b>	<b>Description</b>
<b>Ship To</b>	Enter the supplier ship to location. This location will be used for VAT and SUT calculations by PeopleSoft Payables Voucher Build application. Applicable only for payables leases. This is not a required field and if this is left blank, Voucher Build will populate the default ship to location for the supplier.
<b>Payor</b>	Enter the entity who is responsible to make the operating expense payments. The default value is the tenant from the lease. This field appears only for operating expenses that are associated with receivables leases.
<b>Accounting Distribution</b>	Click this link to access the Accounting Distribution page and to override the operating expense details accounting distribution rules defined at the business unit level.
<b>Add Expense Line</b>	Click to add a new row to the <b>Operating Expense Categories</b> grid.

## Operating Expense Details

<b>Field or Control</b>	<b>Description</b>
<b>Prorata Share Method</b>	<p>This is the basis on which the tenant's share of expenses is calculated. Generally, it represents the ratio of the area of the tenant's premises to that of the building or property as a whole, or an appropriate part thereof. Select either:</p> <ul style="list-style-type: none"> <li>• <i>Fixed Percentage</i>: Select this value if the tenant's prorata basis is stated in the lease as a percentage.</li> <li>• <i>Gross Leasable Area</i>: Select this value if the tenant's prorata basis is calculated as a ratio of the tenant area over the total area, whether the tenant occupied the entire area or not.</li> <li>• <i>None</i></li> <li>• <i>Occupied Area</i>: Select this value if the tenant's prorata basis is calculated as the ratio of the tenant area over the occupied area.</li> <li>• <i>Occupied Area with Floor</i>: Select this value if the tenant's prorata basis is calculated as the ratio of the tenant area over the greater of the occupied area or the floor area. The floor is usually expressed in the lease as an occupancy percentage, which is multiplied times the gross leasable area and then compared to the occupied area.</li> </ul>



<b>Field or Control</b>	<b>Description</b>
<b>Prorata Details</b>	<p>Click this link to access the Prorate Share Details - Basis page.</p> <p>This link is only available if you select <i>Gross Leasable Area</i>, <i>Occupied Area</i>, or <i>Occupied Area with Floor</i> as the Prorata Share Method.</p>
<b>Admin Fee Method</b> (administration fee method)	<p>Choose either:</p> <ul style="list-style-type: none"> <li>• <i>Accrual Method</i>: The administration fee will be charged as a percentage of landlord's overall expenses.</li> <li>• <i>Amount</i>: The administration fee will be charged as fixed amount for an expense category.</li> <li>• <i>Cash Method</i>: The administration fee will be charged as a percentage of expenses paid by tenant.</li> <li>• <i>None</i></li> </ul>
<b>Admin Fee Percentage</b> (administration fee percentage)	Enter the admin fee percentage
<b>Exclude Base Year</b>	Select this check box to exclude a base year. The base year fields are informational only.
<b>Base Year</b>	Enter the year to be used as the base year. If you select <b>Exclude Base Year</b> , then you must enter a base year.
<b>Base Year Amount</b>	Enter the amount to be used for the base year. If you select <b>Exclude Base Year</b> , then you must enter a base year amount.
<b>Base Year Gross Up Percent</b>	Enter the base year gross up percentage. If you select <b>Exclude Base Year</b> , then you must enter a base year gross up percent.
<b>Cap/Min</b>	<ul style="list-style-type: none"> <li>• <i>Alerts</i>: If this option is selected, then the Caps/Min calculation is not applied. The maximum amount defined at the category level will be used to validate the actual amount and an alert will be displayed in the worksheet against the category if the actual amount is greater than the maximum for the category.</li> <li>• <i>Apply</i>: Select this value to apply caps and minimums to this operating expense.</li> <li>• <i>None</i></li> </ul>

<b>Field or Control</b>	<b>Description</b>
<b>Caps Detail</b>	Click this link to access the Caps/Minimum Details page. This link appears only if <i>Apply</i> is selected as the Cap/Min value.
<b>Exp. Gross Up</b> (expense gross up)	Select this check box to enable expense gross up.
<b>Gross Up Percent</b>	Enter the gross up percentage to be applied to this operating expense.
<b>Gross Up Method</b>	Select either: <ul style="list-style-type: none"> <li>• <i>Method A</i>: If the actual occupancy is more than gross up percentage specified on the lease, then the expenses will be grossed up to 100 percent occupancy level.</li> <li>• <i>Method B</i>: If the actual occupancy is more than the gross up percentage specified on the lease, then the expenses will not be grossed up.</li> </ul>

**Expense Categories**

<b>Field or Control</b>	<b>Description</b>
<b>Operating Expense</b>	Enter or select the operating expense category for recoverable shared expenses. You can select from only active operating expense categories.  See <a href="#">Defining Operating Expense Categories</a> .
<b>Estimated Amount</b>	Enter the estimated amount for the operating expense. Use the estimated amount for monthly recurring invoices or payments.
<b>Sales/Use Tax</b>	Click this link to access the Sales/Use Tax Information page.  For additional information on Sales/Use Tax Information page, refer <a href="#">Defining Lease Financial Terms</a>
<b>VAT</b>	Click this link to access the VAT Information page. This field appears only for VAT enabled business units.  For additional information on VAT Information page, refer <a href="#">Defining Lease Financial Terms</a>

<b>Field or Control</b>	<b>Description</b>
<b>Min Amount</b> (minimum amount)	Enter the minimum amount for the operating expense. <hr/> <b>Note:</b> This field is for information use only.
<b>Max Amount</b> (maximum amount)	Enter the maximum amount to charge for the operating expense. Use this field to calculate audit alerts during the audit and reconciliation processes.
<b>Administration Fee</b>	Enter the administration fee. The system adds this amount to the operating expense charges after final calculations of all operating expenses for the lease.
<b>Straightline</b>	Select to apply straightline calculations to the operating expense. <hr/> <b>Note:</b> If the rent amount or recurring expense amount for the operating expense is not evenly billed across periods, then those amounts must be reported in the general ledger on a straightline basis (an even distribution). <hr/> See <a href="#">Understanding Straightline Accounting</a> .
<b>Calculate</b>	Click the button to calculate the recurring monthly operating expenses. <hr/> <b>Note:</b> This button is only available when the lease or amendment is in pending status.
<b>Total Estimated Payment</b>	Displays the total estimated payment amount for the operating expenses.
<b>Schedule</b>	Select a value from the prompt table to specify how often to invoice or pay the operating expenses. Use this field to determine the frequency of the invoice or payment. The values from which you select come from the Schedule component. <hr/> <b>Note:</b> If the value you need is not available, to the Schedule component to add additional values. <hr/> See “Defining Common Journal Definitions” (Application Fundamentals).

<b>Field or Control</b>	<b>Description</b>
<b>Frequency</b>	Displays the frequency that is associated with the schedule that you selected.
<b>Anticipated Process Date</b>	<p>Displays the current anticipated processing date or the next date on which a transaction is available to be approved and sent to PeopleSoft Payables or PeopleSoft Billing. This field appears only after lease activation.</p> <hr/> <p><b>Note:</b> You must run the Transaction Generator to get the scheduled transactions into the transaction queue.</p> <hr/>
<b>Terms Calendar</b>	<p>Enter the terms calendar, which determines the start date and end date of billing periods for the operating expense. The calendar ID from the business unit definition appears by default. You can override this value, but the frequency of the schedule and terms calendar must be the same. This is a required field.</p>

**Details**

<b>Field or Control</b>	<b>Description</b>
<b>Caps</b>	Select this check box if caps apply to this expense.
<b>Fee</b>	Select this check box if fees apply to this expense.
<b>Gross Up</b>	Select this check box if grossing up applies to this expense.
<b>Anchor Contribution</b>	Enter any anchor contribution made by the tenant.
<b>Basis</b>	Select a basis for this operating expense.
<b>Catch Up</b>	Catch up payments are the adjustment payment for the first months of the new year. The difference between the estimated payment amount paid to date in a new lease year (which has been paid at the prior year estimated payment amount) and the amount due per the new estimated payment amount This catch up payment will be added to the first transaction that will be sent to the transaction queue after the amendment is activated.

<b>Field or Control</b>	<b>Description</b>
<b>Accounting Distribution</b>	Click this link to access the Accounting Distribution page and override the operating expense category accounting rules defined at the business unit level.

## Accounting Distributions Page

Use the Accounting Distributions page (RE\_LS\_TRM\_DST\_SEC) to override the accounting distributions defined at the business unit level.

Navigation:

Click the **Accounting Distributions** link on the Financial Terms - Operating Expenses Details page.

This example illustrates the fields and controls on the Accounting Distributions page. You can find definitions for the fields and controls later on this page.

The fields on this page differ depending upon the distribution selected. When you select a value other than **None**, the ChartField values become available for edit.

<b>Field or Control</b>	<b>Description</b>
<b>Distribute By</b>	<p>Select either:</p> <ul style="list-style-type: none"> <li>• <b>Percentage:</b> Select this value to change the accounting distribution by percentage for each financial term.</li> <li>• <b>Area:</b> Select this value to change the accounting distribution by area for each financial term. The rent will be distributed based on the ratio of the areas.</li> <li>• <b>None:</b> Select this option to use the accounting distribution set up at the business unit level.</li> </ul>

<b>Field or Control</b>	<b>Description</b>
<b>Add Distribution</b>	<p>This button appears if you select <b>Percentage</b> or <b>Area</b> for the distribute by value.</p> <p>Click this button to insert a new distribution row.</p>
<b>Delete Distribution</b>	<p>This button appears if you select <b>Percentage</b> or <b>Area</b> for the distribute by value.</p> <p>Select a row and click this button to delete it from this page.</p>
<b>Select</b>	<p>This option appears if you select <b>Percentage</b> or <b>Area</b> for the distribute by value.</p> <p>This option is used to delete distribution rows. Select this option and click the <b>Delete Distribution</b> button to delete the rows.</p>
<b>Percentage</b>	<p>This field appears if you select <b>Percentage</b> for the distribute by value.</p> <p>Enter a percentage amount for this distribution line.</p> <p>Percentage amounts must equal 100% to be valid.</p>
<b>Area</b>	<p>This field appears if you select <b>Area</b> for the distribute by value.</p> <p>Enter the area for this distribution line.</p> <p>All lines must add up to the total rentable area for the lease to be valid.</p>
<b>Valid</b>	<p>Used to indicate a valid combination of chartfields. When activating the lease, edit checking will be provided and the option will be selected for each row representing a valid combination of chartfields. A lease cannot be activated until every accounting distribution is marked as valid.</p>

## Prorata Share Details - Basis Page

Use the Prorata Share Basis page (RE\_LS\_PRTA\_SEC) to use this page to enter prorata basis information for this operating expense.

Navigation:

- **Lease Administration > Payables Leases > Maintain Lease > Financial Terms**
- Click the **Add Operating Expense** button.

Click the **Prorata Details** link.

This example illustrates the fields and controls on the Prorata Share Details - Basis page. You can find definitions for the fields and controls later on this page.

Financial Terms
[NEXT - Test](#)

### Prorata Share Details - Basis

Agreement No 0000000001
Unit of Measure Square Feet

Prorata Share Method Occupied Area With Floor

Prorata Basis				Personalize   Find	First 1 of 1 Last
*Prorata Basis	Tenant Area	Total Area	Floor Percentage		
<input type="text"/>	<input type="text"/>	<input type="text"/>	<input type="text"/>		

Description

The fields on this page vary depend on which prorata share basis is selected on the Operating Expense page.

<b>Field or Control</b>	<b>Description</b>
<b>Prorata Share Method</b>	Displays the prorata share method selected on the Operating Expense Details page.
<b>Unit of Measure</b>	Displays the unit of measure.
<b>Agreement No</b> (agreement number)	Displays the agreement number for the prorata share details.
<b>Prorata Basis</b>	Enter a prorata basis.
<b>Tenant Area</b>	Enter the tenant's area.
<b>Total Area</b>	Enter the total area to be considered for this prorata basis. The total area of the property selected on the lease will be defaulted here. The user can override this value here.
<b>Floor Percentage</b>	Enter the percentage of floor to be considered for this prorata basis.  This field is only available if you select Occupied Area With Floor as the Prorata Basis option on the Operating Expense Details page.
<b>Description</b>	Enter a description for the prorata share details.

## Cap/Minimum Details Page

Use the Caps/Minimum Details page (RE\_LS\_OPX\_CAP\_SEC) to use this page to enter caps detail information for this operating expense.

Navigation:

- **Lease Administration > Payables Leases > Maintain Lease > Financial Terms**
- Click the **Add Operating Expense** button.

Click the **Caps Details** link.

This example illustrates the fields and controls on the Caps/Minimum Details page. You can find definitions for the fields and controls later on this page.

Financial Terms
[NEXT - Test](#)

### Caps/Minimum Details

CAP Applied To

CAP Applied

CAP Basis

**Subsequent Year Cap**

Method       Percentage

Compare To       Index Name

**Subsequent Year Minimum**

Method       Percentage

Compare To       Index Name

Notes

<b>Field or Control</b>	<b>Description</b>
<b>Caps Applied To</b>	Select whether the caps are applied to <i>Tenant Share</i> or <i>Landlord Expense</i> .
<b>Caps Basis</b>	Select either: <ul style="list-style-type: none"> <li>• <i>Prior Year Restricted</i>: The cap calculation is applied to the prior period landlord or tenant share after caps are applied.</li> <li>• <i>Prior Year Actual</i>: The cap calculation is applied to the prior period landlord or tenant share before caps are applied.</li> </ul>



<b>Field or Control</b>	<b>Description</b>
<b>Cap Applied</b>	Select either: <ul style="list-style-type: none"> <li>• <i>Before Fee</i>: Caps should be applied on the landlord or tenant share before administration fee is applied.</li> <li>• <i>After Fee</i>: Caps should be applied on the landlord or tenant share after administration fee is applied.</li> </ul>

### Subsequent Year Cap

<b>Field or Control</b>	<b>Description</b>
<b>Method</b>	<ul style="list-style-type: none"> <li>• <i>Percentage</i>: Caps will be calculated as a percentage increase over the prior year expense.</li> <li>• <i>Indexed</i>: Caps will be linked to an index.</li> <li>• <i>Least of Percent or Index</i>: For this method of calculating minimum and maximum, define a percentage and the system will calculate the indexed value and the least of the two will be considered for the final calculation. the indexed value at the end date of the current audit period will be compared with the last date of the baseline period.</li> </ul>
<b>Percentage</b>	Enter the percentage to be used in calculation.
<b>Compare To</b>	Select a comparison value: <ul style="list-style-type: none"> <li>• <i>Base</i></li> <li>• <i>Last</i></li> </ul>
<b>Index Name</b>	For <i>Indexed</i> or <i>Least of Percent or Index</i> , specify the index value to be used.

## Subsequent Year Minimum

<b>Field or Control</b>	<b>Description</b>
<b>Method</b>	<ul style="list-style-type: none"> <li>• <i>Percentage</i>: Caps will be calculated as a percentage increase over the prior year expense.</li> <li>• <i>Indexed</i>: Caps will be linked to an index.</li> <li>• <i>Least of Percent or Index</i>: For this method of calculating minimum and maximum, define a percentage and the system will calculate the indexed value and the least of the two will be considered for the final calculation. indexed value on the start date of the current audit period will be compared with the first date of the baseline period</li> </ul>
<b>Percentage</b>	Enter the percentage to be used in calculation.
<b>Compare To</b>	Select a comparison value: <ul style="list-style-type: none"> <li>• <i>Base</i></li> <li>• <i>Last</i></li> </ul>
<b>Index Name</b>	For <i>Indexed</i> or <i>Least of Percent or Index</i> , specify the index value to be used.

## Operating Expense Approval Page

Use the Operating Expense Approval page (RE\_LS\_OPX\_APP) to approve operating expenses that exceed tolerances.

Navigation:

Select a task item from your worklist.

This example illustrates the fields and controls on the Operating Expense Approval page.

**Operating Expense Approval**

**Operating Expense Details**

Business Unit US001	Lease Number 0000000123	Currency USD	Lease Name test lease
Agreement No 0000000001	Audit Number 7	Status Pending Approval	Landlord Corporate Business Technology
From Date 03/01/2012	To Date 03/31/2012	UOM Square Feet	

Revision 0

Operating Expense Variance			
Instance Name	Current Period	Previous Period	Variance %
Janitorial Supplies	2000.00	1000.00	100.00

**Approval Action**

Comments

**Approval Map**

**Audit Expense Monitoring**

Operating Expense Audit 7: Pending

[Request Information](#)  
[Start New Path](#)

**Audit Expense Monitoring**  

Pending  
Mary Lewis  
Lease Approver
+

If operating expenses are outside tolerance limit, the system will:

1. On Processing, set the operating expense worksheet to *Pending Approval*.
2. Create tasklist for the approver
3. Route the approver from the tasklist to the approval page
4. If the transaction is approved, send the transactions to the TQM and change the status of the Worksheet to *Processed*.
5. If the transaction is denied, change the status of the worksheet to *Pending* so that the worksheet can be edited and the whole process can be repeated.

The Approval map displays the path and status of approvals. Ad-Hoc approvers can be added by clicking on the **Add** button.

---

## Performing Operating Expense Audits for a Payables Lease

This topic provides an overview of operating expense audits and discusses how to perform operating expense audits for a payables lease.

## Pages Used to Audit Operating Expenses

<b>Page Name</b>	<b>Definition Name</b>	<b>Usage</b>
<a href="#">Audit Operating Expenses - Operating Expense Audit Page</a>	RE_OPEXAUDIT	Create an operating expense worksheet to compare estimated operating expense payments against actual expenses.
Accounting Distributions Page	RE_LS_OPEX_CTG	Enter accounting distributions for the audit.  <a href="#">Audit Operating Expenses - Operating Expense Audit Page</a>
<a href="#">Audit Operating Expenses - Compare Operating Expenses with Previous Audit Page</a>	RE_OPEXAUDIT_CMP	Displays the current audit data and prior audit data, if available. You can use this comparison data to ensure continuity in operating expense charges from year to year.

## Understanding Operating Expense Audits

The PeopleSoft Lease Administration system provides you with the ability to reconcile annual operating expenses or CAM against your estimated payments. When the landlord sends the annual CAM reconciliation statement with any invoice or credit against the estimated payments that you have made, you can compare the information against your records of estimated payments, as well as the CAM charges from the previous year. If the charges significantly increase or decrease or the data that is provided by the landlord is insufficient, you can initiate a formal CAM audit.

You can use the Audit Operating Expenses - Operating Expense Audit page to enter the values from the reconciliation statement for each expense category. The system automatically calculates the amounts that you paid to the payee, which includes all of the recurring amounts and the audit adjustment amounts. To calculate the paid amount, the system uses only processed transactions from the transaction queue. You can enter manual adjustments the final total for each expense category. The system compares the data that you entered against the data that is stored in the lease and flags any value that exceeds a certain tolerance threshold.

---

**Note:** You set up the tolerance threshold at implementation in the lease administration business unit.

---

After you have reviewed and compared the data in the worksheet and are satisfied with the final calculated numbers, you can issue a payment for any underpayments. If an overpayment occurs, you can create a negative payables line and apply it to any future payments, or, the landlord can issue a refund check or credit.

## Prerequisites

Before you can perform an operating expense audit, the lease that you are auditing must be in active, expired, or holdover state. You must also enter operating expenses terms against the lease.

## Audit Operating Expenses - Operating Expense Audit Page

Use the Audit Operating Expenses - Operating Expense Audit page (RE\_OPEXAUDIT) to create an operating expense worksheet to compare estimated operating expense payments against actual expenses.

Navigation:

**Lease Administration > Payables Lease > Audit Operating Expenses**

This example illustrates the fields and controls on the Audit Operating Expenses - Operating Expense Audit page. You can find definitions for the fields and controls later on this page.

**Audit Operating Expenses**

**Operating Expense Audit**

Business Unit US001	Lease Number 0000000103	Currency USD	Lease Name REM 4 - OP EX
Agreement No 0000000001	Audit Number 2	Status Processed	Landlord Robert Half
From Date 03/02/2012	Unit of Measure	Ship To	Location Headquarters
To Date 06/01/2012			

---

Received Date  Audit Window  Months  Deadline Date

---

Revision 0 Accounting Distribution Opex Audit Status

**Expense Details**

Admin Fee Percentage	Base Year
	Base Year Adjustment 0.000
	Base Year Gross Up 0.00

**Expense Categories**

Category	Grossed Up Expense	Anchor Contribution	Shareable Expense
Electricity	5000.00	0.00	5000.00 <input type="button" value="v"/>

		Notes <input type="text"/>
Total Paid To Payee	4200.000	
Total Tenant's Share	5000.000	
Total Manual Adjustment	0.000	
Total Administration Fee	0.000	
Final Manual Adjustment	0.000	
Total Amount Due	800.000 USD	

[Compare Previous Audit](#)

---

Created By Theresa Monroe	Last Updated By Theresa Monroe	Submitted By Theresa Monroe
Created On 11/19/2012 9:59:33PM	Last Updated On 11/19/2012 9:59:49PM	Submit Date 11/19/2012 9:59:49PM

<b>Field or Control</b>	<b>Description</b>
<b>Business Unit</b>	Displays the lease administration business unit selected on the search page.
<b>Lease Number</b>	Displays the lease number selected on the search page.
<b>Currency</b>	Displays the currency of the lease.
<b>Lease Name</b>	Displays the lease name.

<b>Field or Control</b>	<b>Description</b>
<b>Agreement No</b> (agreement number)	Displays the agreement number for the lease operating expense.
<b>Audit Number</b>	Displays the sequential number that is assigned to this audit.
<b>Status</b>	Displays the audit status.
<b>Landlord</b>	Displays the landlord for this lease.
<b>From Date</b>	Enter the date on which you want the audit period to begin. This date must occur after the lease start date and cannot be later than one day after the <b>To Date</b> from the previous audit. The system sets the <b>From Date</b> to one day later than the previous audit by default. For first audit period the system uses the lease commencement date by default.
<b>To Date</b>	Enter the date on which you want the audit period to end. This date must occur after the from date and cannot be later than the current date.
<b>UOM</b> (unit of measure)	Displays the unit of measure of this lease.
<b>Received Date</b>	Enter the expense audit creation date.
<b>Audit Window</b>	Enter the audit time required. You have the option to specify the time in Days, Weeks, Months or Years.
<b>Deadline Date</b>	Select a date for the audit deadline. The date will be automatically updated if you enter the time in the <b>Audit Window</b> field.
<b>Revision</b>	Displays the revision number for this audit.
<b>Accounting Distributions</b>	Select this link to access the Accounting Distributions page.
<b>Opex Audit Status</b>	Enter the user defined status. You can define the audit status in the Opex Audit Status page.  You can edit the status regardless of the overall audit status.
<b>Update Audit</b>	Click to update this audit. The system compares the actual charges in the current audit with the charges for the operating expense categories in the previous audit and creates and invoice for the balance amount. You can update an audit only after all of the audit transactions have been processed. This field appears only for processed audits.

## Prorata Basis

Prorata details group box will not be available for the user if:

- Fixed percentage method is used for sharing expenses.
- Prorata share is not used to calculate tenant's share.

<i>Field or Control</i>	<i>Description</i>
<b>Prorata Share Method</b>	Displays the prorata share method for this operating expense.
<b>Gross Up Percentage</b>	Displays the gross up percentage for this operating expense.
<b>Gross Up Method</b>	Displays the gross up percentage for this operating expense.
<b>Calculate Prorata Basis</b>	Click this button to calculate the prorata basis.
<b>Prorata Basis</b>	Displays the prorata basis selected for this operating expense.
<b>Tenant Area</b>	Enter the area this tenant occupies.
<b>Rentable Area</b>	Enter the total rental area available.
<b>Occupied Area</b>	Enter the total area occupied.
<b>Occupancy Percentage</b>	Displays the percentage of area this tenant occupies.
<b>Prorata Share</b>	Displays the percentage of the total area that you are occupying. The system displays the value from the lease. The field is informational only. The system does not use the field for any calculations.

## Expense Details

<i>Field or Control</i>	<i>Description</i>
<b>Admin Fee Percentage (Administration Fee Percentage)</b>	Displays the administration fee percentage.
<b>Base Year</b>	Displays the base year entered on the lease.
<b>Base Year Adjustment</b>	Displays the base year adjustment entered on the lease.

<b><i>Field or Control</i></b>	<b><i>Description</i></b>
<b>Add Category</b>	Click this button to create a new operating expense category for the lease. This button appears only for pending audits.
<b>Base Year Gross Up</b>	Displays the base year gross up entered on the lease.
<b>Category</b>	Select the expense category.  Operating expense categories that are in a processed state will be retrieved from the Transaction Queue for the given lease and payee.
<b>Actual Amount</b>	Enter the actual amount for this expense category.
<b>Previous Period</b>	Displays the amount for the previous period if available.
<b>Change</b>	Displays the change in amounts from the previous period.
<b>Caps</b>	Select this check box to indicate if caps are applied to this category.
<b>Fee</b>	Select this check box to indicate if administration fees apply to this category.
<b>Gross Up</b>	Select this check box to indicate if gross up applies to this category.

## Overall Expense

<b><i>Field or Control</i></b>	<b><i>Description</i></b>
<b>Grossed Up Expense</b>	Enter the grossed up expense for this expense category.
<b>Admin Fee (administration fee)</b>	Enter any administration fees applied to this category.
<b>Anchor Contribution</b>	The anchor contribution defaults from the lease, the user can override the value here.
<b>Adjusted Expense</b>	Enter the adjusted expense for this category.



<b>Field or Control</b>	<b>Description</b>
<b>Minimum</b>	Enter the minimum for this category.
<b>Maximum</b>	Enter the maximum for this category.
<b>Sharable Expense</b>	The system calculates this value. This is the expense which needs to be shared based on the prorata share of the tenant.

## Tenant Share

<b>Field or Control</b>	<b>Description</b>
<b>Prorata Share</b>	Displays the prorata share calculated using the values entered.
<b>Occupancy Percent</b> (occupancy percentage)	Enter the occupancy percentage for this category. The default is 100 percent.
<b>Tenant Share</b>	Displays the tenant share calculated based on the sharable expense, prorata share, and the occupancy percentage entered.
<b>Paid Amount</b>	Displays the amount paid to the landlord.
<b>Prorated Manual Adjustment</b>	Displays the final manual adjustment value prorated for each expense category lines.
<b>Amount Due</b>	Displays the amount due to the landlord.
<b>Sales/Use Tax</b>	Click this link to access the Sales/Use Tax Information page.  For additional information on Sales/Use Tax Information page, refer <a href="#">Defining Lease Financial Terms</a>
<b>VAT</b>	Click this link to access the VAT Information page. This field appears only for VAT enabled business units.  For additional information on VAT Information page, refer <a href="#">Defining Lease Financial Terms</a>

## Operating Expense Categories

The system automatically populates the Operating Expense Categories grid with the operating expense categories that are associated with the lease and payee on which you are performing the audit.

Operating Expense Categories in the processed state will be retrieved from the Transaction Queue for the given Lease and Payee.

<b>Field or Control</b>	<b>Description</b>
<b>Calculate</b>	Click the button to calculate the total lines that were entered. When you click the button, the system calculates the difference between the paid amount and the actual amounts and displays the totals and the adjustments.
<b>Total Paid To Landlord</b>	Displays the total operating expenses that were paid to the landlord. The system adds all of the amounts in the <b>Paid Amount</b> column.
<b>Total Adjusted Actual Amount</b>	Displays the total amount of the operating expenses that should have been paid to the landlord or payee. The system adds all of the amounts in the <b>Actual Amount</b> column.
<b>Total Manual Adjustment</b>	Displays the total amount of the manual adjustments. The system adds all of the amounts in the <b>Adjust Amount</b> column.
<b>Total Administration Fee</b>	Displays the total administration fee. The system adds all of the amounts in the <b>Admin Fee</b> column.
<b>Final Manual Adjustment</b>	Enter the amount for the final manual adjustments. You can edit the amount when the worksheet status is in pending status and negative values are accepted.
<b>Total Amount Due</b>	Displays the amount that you owe the landlord or payee. The system uses this formula to calculate the amount: Amount Owed = Total Adjusted Actual Amount + Total Manual Adjustment + Total Administration Fee – Total Paid To Landlord.
<b>Create Payment</b>	Click to create a payment for underpayment of the operating expenses for the year. When you click this button, the system sends the transaction to the transaction queue for payment processing.

<b>Field or Control</b>	<b>Description</b>
<b>Compare Previous Audit</b>	Click to select the previous audit for comparison, if it exists. The system bases the comparison on the audit end dates. The previous audit is the one with an audit end date less the current audit end dates. The system retrieves the two audits and displays them side-by-side. The system flags category differences from year-to-year and identifies massive increases or charges that are above the maximum that is allowed. If the system cannot find a category match, it separates those categories that are not available for comparison.

## Audit Operating Expenses - Compare Operating Expenses with Previous Audit Page

Use the Audit Operating Expenses - Compare Operating Expenses with Prior Audit page (RE\_OPEXAUDIT\_CMP) to displays the current audit data and prior audit data, if available.

You can use this comparison data to ensure continuity in operating expense charges from year to year.

Navigation:

- **Lease Administration > Payables Lease > Audit Operating Expenses**
- Click the **Compare Previous Audit** link.

This example illustrates the fields and controls on the Audit Operating Expenses - Compare Operating Expenses with Previous Audit page. You can find definitions for the fields and controls later on this page.

Operating Expenses Compare						
Operating Expense Audit						
<b>Compare with Prior Audit</b>						
- Current 02/01/2012 02/29/2012			Prior Period 01/01/2012- 01/31/2012			
Period						
Current Audit Number 6			Prior Audit Number 5			
Lease Name test lease			Payee Corporate Business Technology			
Status Processed			Currency USD			
Lease Number 000000123						
Agreement No 000000001						
UOM Square Feet						
<b>Common Operating Expense Audits for Current and Prior Audits</b>					Personalize   Find	
					First 1 of 1 Last	
Expense Category	Current Actual	Prior Actual	Difference %	Difference Amount	Current Cost/Sq Unit	Prior Cost/Sq Unit
Janitorial Supplies	1,000.000	500.000	100.00	500.000	12.747	6.373
<b>Overall Comparison</b>						
<a href="#">Return to Worksheet</a>						

This page enables to you compare and audit operating expenses against previous audit data, if it exists. The system retrieves the two audits and displays them side-by-side. The system flags category differences from year-to-year and identifies massive increases or charges that are above the maximum that is allowed. If the system cannot find a category match, it separates those categories that are not available for comparison.

<i>Field or Control</i>	<i>Description</i>
<b>Current Period</b>	Displays the date range for this audit period.
<b>Prior Period</b>	Displays the date range for the prior audit period that you are comparing.

### Common Operating Expense Audits for Current and Prior Audits

<i>Field or Control</i>	<i>Description</i>
<b>Current Actual</b>	Displays the current actual amount that you entered based on the reconciliation statement.
<b>Prior Actual</b>	Displays the previous audit actual amount.
<b>Difference %</b> (difference percentage)	Displays the percentage difference between the current actual amount and the prior actual amount. $((\text{Current Actual} - \text{Prior Actual}) \div \text{Prior Actual})$ .
<b>Diff Amt</b> (difference amount)	Displays the difference amount. $(\text{Current Actual} - \text{Prior Actual})$ .
<b>Current Cost/Sq Unit</b> (current cost per square unit)	Displays the current cost per square unit. $(\text{Current Cost} \div \text{Sq Unit} = \text{Adjusted Actual Amount} \div \text{Total Rentable Area})$ .
<b>Prior Cost/Sq Unit</b> (prior cost per square unit)	Displays the prior cost per square unit. $(\text{Prior Cost/Sq Unit} = \text{Prior Actual Amount} \div \text{Prior Total Rentable Area})$ .

### Unmatched Categories

When the system cannot match up one or more categories from a previous audit with the categories from the current audit, the system displays the discrepancies in the **Unmatched Categories** grid. This occurs when you create a new category or an existing category from a previous audit does not exist, or if you change the category in the middle of the year. As a result, the system is unable to provide any comparisons for these categories because there is no exact match.

## Calculated Total for Current and Prior Audits

<i>Field or Control</i>	<i>Description</i>
<b>Current Actual</b>	Displays the total amount that you paid to the payee. This amount might differ from the reconciliation statement that is provided by the landlord. The current actual amount paid is based on an estimate that is provided to you at the beginning of the lease.
<b>Prior Actual</b>	Displays the total amount that you paid to the payee in the prior period.
<b>Diff Amt (difference amount)</b>	Displays the difference between the prior actual amount and the current actual amount.
<b>Current Payor Actuals</b>	Displays the current total amount that is paid by the payor.
<b>Payors Actuals Difference</b>	Displays the total amount that the payor paid in the prior audit.
<b>Current Rentable Area</b>	Displays the current total rentable area in the lease.
<b>Prior Rentable Area</b>	Displays the total rentable area in the prior audit.
<b>Rentable Area Difference</b>	Displays the difference between the current and prior rentable area in the lease.
<b>Current Cost Per Sq Unit (current cost per square unit)</b>	Displays the total current cost per square unit.
<b>Prior Cost/SQ Unit (prior cost per square unit)</b>	Displays the total prior cost per square unit.
<b>Cost/SQ Unit Difference (cost per square unit difference)</b>	Displays the difference of the total cost per square unit between the current period and the prior periods.

---

## Reconciling Operating Expenses for Receivables Leases

This topic provides an overview of operating expense reconciliation and discusses how to reconcile operating expenses for receivables leases.

## Pages Used to Reconcile Operating Expenses

<i>Page Name</i>	<i>Definition Name</i>	<i>Usage</i>
<u>Reconcile Operating Expenses - Operating Expense Statement Page</u>	RE_OPEXAUDIT	Compare operating expenses to the operating expense statement to reconcile paid expenses against actuals.
<u>Reconcile Operating Expenses - Compare Operating Expenses with Prior Statement Page</u>	RE_OPEXAUDIT_CMP	Displays the current reconciliation data and prior reconciliation data. You can use this comparison data to ensure continuity in operating expense charges.

## Understanding Operating Expense Reconciliation

PeopleSoft Lease Administration enables you to reconcile the difference in the original estimated operating expense and the actual operating expenses for each tenant or payor for a time period. The system calculates the amount of estimated operating expenses for the transactions that the system processed during a time period that you specify. You can enter the actual expenses that you incurred based on these criteria:

- Operating expense category: Summarize your charges by operating expense category.
- Tenant: Specify the tenant or payor.
- Time period: Determine reconciliation from and to dates.

Use the Reconcile Operating Expenses - Operating Expense Statement page to enter these amounts and compare them with the amounts that the payor paid. You can manually adjust the amount for each operating expense category. Click the **Create Invoice** button on the Operating Expense Statement page to access the Billing Review page. In the case of an overpayment, you can issue a credit to the tenant that could be applied against future rent payments. In the case of an underpayment, you can issue an invoice for the remaining sum. Enter the billing amount as negative to generate a payment credit or positive to create an invoice.

You can compare this reconciliation with the previous reconciliation to identify any time gaps or large amount differences in the operating expenses.

## Reconcile Operating Expenses - Operating Expense Statement Page

Use the Reconcile Operating Expenses - Operating Expense Statement page (RE\_OPEXAUDIT) to compare operating expenses to the operating expense statement to reconcile paid expenses against actuals

Navigation:

**Lease Administration > Receivables Lease > Reconcile Operating Expenses**

This example illustrates the fields and controls on the Reconcile Operating Expenses - Operating Expense Statement page. You can find definitions for the fields and controls later on this page.

**Reconcile Operating Expenses**  
**Operating Expense Statement**

Business Unit US001      Lease Number 0000000112      Currency USD      Lease Name op ex - sample 1 - receivable  
 Agreement No 0000000001      Audit Number 3      Status Processed      Tenant Staffing Customer  
 From Date 01/01/2012      To Date 03/01/2012      UOM Square Feet      Ship To

---

Revision 0      Accounting Distribution      Update Statement

**Prorata Basis** ?

Prorata Share Method Gross Leasable Area      Gross Up Percentage

Gross Up Method

**Prorata Basis Details**

Prorata Basis	Tenant Area	Rentable Area	Occupied Area	Occupancy Percent	Prorata Share
Total Area	60.000	64.560	60.00	92.94	92.94

**Expense Details** ?

Admin Fee Percentage 5.00      Base Year

Base Year Adjustment 0.00

Base Year Gross Up 0.00

**Expense Categories**

Category	Actual Amount	Previous Period	Change Percent	Caps	Fee	Gross Up
Repairs and Maintenance	150000.00	0.00	0.00	<input type="checkbox"/>	<input checked="" type="checkbox"/>	<input type="checkbox"/>

Total Paid To Payee	225000.00	Notes
Total Tenant's Share	134763.00	
Total Manual Adjustment	0.00	
Total Amount Due	-90237.00 USD	

[Compare Previous Audit](#)

Created By Theresa Monroe	Last Updated By Theresa Monroe	Submitted By Theresa Monroe
Created On 11/19/2012 10:09:34PM	Last Updated On 11/19/2012 10:09:34PM	Submit Date 11/19/2012 10:09:34PM

**Note:** The fields on this page function the same as the fields on the Audit Operating Expenses - Operating Expense Audit page.

See [Audit Operating Expenses - Operating Expense Audit Page](#).

## Reconcile Operating Expenses - Compare Operating Expenses with Prior Statement Page

Use the Reconcile Operating Expenses - Compare Operating Expenses with Prior Statement page (RE\_OPEXAUDIT\_CMP) to displays the current reconciliation data and prior reconciliation data.

You can use this comparison data to ensure continuity in operating expense charges.

Navigation:

- **Lease Administration > Receivables Lease > Reconcile Operating Expenses**

- Click the **Compare Previous Audit** link.

This example illustrates the fields and controls on the Access the Reconcile Operating Expenses - Compare Operating Expenses with Prior Statement page. You can find definitions for the fields and controls later on this page.

**Operating Expense Statement**

---

**Compare with Prior Statement**

Current Period: 01/01/2002 - 12/31/2002      Prior Period: 01/01/2001 - 12/31/2001

Current Audit Number: 3      Prior Audit Number: 2

---

Lease Name: OPEX-R new calc methods      Status: Pending      Payor: Alliance Group

Lease Number: 0000000085      Agreement No: 0000000001      Currency: USD

UOM: Square Meters

---

**Common Operating Expense Audits for Current and Prior Audits** Customize | Find | First | 1-3 of 3 | Last

Expense Category	Current Actual	Prior Actual	Difference %	Difference Amount	Current Cost/Sq Unit	Prior Cost/Sq Unit
Administrative Fees	300,000.000	250,000.000	20.00	50,000.000	49309.665	41091.387
Common Area Maintenance	450,000.000	400,000.000	12.50	50,000.000	73964.497	65746.220
Electricity	750,000.000	700,000.000	7.14	50,000.000	123274.162	115055.884

---

**Overall Comparison**

Current Payee Actuals:	1,500,000.00	USD	Current Rentable Area:	6.084	USD
Prior Payee Actuals:	1,350,000.00	USD	Prior Rentable Area:	6.084	USD
Payees Actuals Difference:	150,000.00	USD	Rentable Area Difference:	0.000	USD
Current Payor Actuals:	384,000.00	USD	Current Cost Per Sq Unit:	246,548.32	USD
Prior Payor Actuals:	384,000.00	USD	Prior Cost/SQ Unit:	221,893.49	USD
Payors Actuals Difference:	0.00	USD	Cost / SQ Unit Difference:	24,654.83	USD

[Return to Worksheet](#)

The fields on this page function in the same way as the fields on the Audit Operating Expenses - Compare Operating Expense with Prior Audit page.

See [Audit Operating Expenses - Compare Operating Expenses with Previous Audit Page](#).



# Setting Up and Calculating Percent Rent

## Understanding Percent Rent Terms

Percent rent enables you to negotiate a lower monthly base rent in exchange for a portion of your sales once the threshold is met. This lease method is appealing because you receive a lower monthly liability in months of lower sales. As the sales amount reaches a specified threshold (breakpoint), the percentage changes, thus altering the amount of the final rent amount. For a breakpoint, the rent can be a fixed amount, a percentage of sales, or a combination of fixed amount and percentage.

When multiple breakpoints are established, the system determines which breakpoint has been reached and adds its incremental percentage over and above the other breakpoints. For example, let's say the breakpoints are as follows:

- 0 to 1,000 (5%)
- 1,000.01 to 4,999.99 (4%)
- 5,000 to 99,999,999,999.99 (3% + 1,000 USD)

If the sales amount is 1,500 USD, then the system takes the maximum of the prior breakpoint multiplied by that breakpoint percentage (or amount, or both depending on lease terms), adds the incremental amount over that breakpoint maximum, multiplied by the new breakpoint percentage.

In this example, the calculation is as follows:  $1,000 \times 5\% + (1,500 - 1,000) \times 4\% = 70$ .

Using the previous example, if a lease had three breakpoints in percent rent setup, and the sales amount reached the third level (10,000), then the calculation is as follows:  $1,000 \times 5\% + (4,999.99 - 1,000) \times 4\% + (10,000 - 4,999.99) \times 3\% + 1,000 = 1360$ .

These tables provide additional examples of the percent rent category based calculation methodology:

Percent Rent Setup Data:

<b>Financial Term</b>	<b>Amount</b>
Current Base Rent	1000.00 USD
Minimum Fee	25.00 USD
Maximum Fee	800.00 USD

Sales Breakpoints

<b>From</b>	<b>To</b>	<b>Type</b>	<b>Amount</b>	<b>Full Breakpoint</b>
0	999.99	Percent	5%	50.00 USD
1000	4999.99	Percent	4%	160.00 USD
5000	9999.99	Percent	3%	150.00 USD
10000	99,999,999,999.99	Percent	2%	Not applicable

## Sales Data

<b>Year</b>	<b>Month</b>	<b>Reported Sales (USD)</b>	<b>Breakpoint Amount</b>	<b>Variable Rent (USD)</b>	<b>Adjusted Variable Amount (USD)</b>	<b>Total Rent (USD)</b>	<b>Comment</b>
2004	January	250.00	5%	12.50		1,025.00	Minimum not met, use adjusted amount.
2004	February	2,000	VAR2	90.00		1,090.00	Second breakpoint reached, add full breakpoint calculation to incremental difference.
2004	March	1,800	VAR2	82.00		1,082.00	
2004	April	6,000	VAR3	240.00		1,240.00	Third breakpoint reached, add full breakpoint calculations to incremental difference.
2004	May	5,000	VAR4	210.00		1,210.00	
2004	June	50,000	VAR4	1,160.00	800.00	1,800.00	Maximum exceeded, use adjusted amount

<b>Year</b>	<b>Month</b>	<b>Reported Sales (USD)</b>	<b>Breakpoint Amount</b>	<b>Variable Rent (USD)</b>	<b>Adjusted Variable Amount (USD)</b>	<b>Total Rent (USD)</b>	<b>Comment</b>
2004	July	30,000	VAR4	760.00		1,760.00	
2004	August	15,000	VAR4	460.00		1,460.00	
2004	September	7,500	VAR3	285.00		1,285.00	
2004	October	4,200	VAR2	180.00		1,180.00	
2004	November	800	5%	40.00		1,040.00	
2004	December	20,000	VAR4	560.00		1,560.00	

You define the percentage breakpoints for the percent rent tier structure before activating the lease; after the lease is activated, you must create an amendment to perform any changes to the structure. You include percent rent terms on the lease and enter them into the system prior to lease activation. You set the various sales breakpoints (or tiers) for the lease under different sales categories. In the absence of actual reported data, you can enter or have the system attempt to estimate sales data. You enter the estimated information on the Sales Report Details page and set the type to *Estimated*. The Sales Report Details page is a worksheet to enter and calculate the total sales amounts. The system uses past data to help determine an appropriate estimate.

## Weekly Sales Method

The system will allow only one sales category on the percent rent setup. The system will use this category to create the sales report and import sales. This method will use only current period sales data.

If the bill amount is less than the minimum fee, the percent rent shall be zero and only the minimum rent will be charged. If the bill amount is more than the minimum fee, it calculates percent rent (sales overage) rent by deducting the minimum fee from the total bill amount. If the bill amount is more than the maximum fee then the maximum fee will be charged. Sales overage rent will be equal to the Maximum Fee - Minimum Fee.

The system shall apply breakpoints to calculate the percent as follows:

If the operator is Percent then:

- If sales amount is between first breakpoint range, then:

First breakpoint's billable amount = (Sales amount – First breakpoint's from amount) \* First breakpoint's percent.

- If sales amount is between second breakpoint range, then:

Second breakpoint billable amount = (Sales amount – Second breakpoint's from amount) \* Second breakpoint's percent.

- If sales amount is between Nth breakpoint range, then:

Nth breakpoint billable amount = (Sales amount – Nth breakpoint's from amount) \* Nth breakpoint's Percent.

If the operator is Amount, then:

- If sales amount is between first breakpoint range, then:

First breakpoint billable amount = First breakpoint's fixed amount.

- If sales amount is between second breakpoint range, then:

Second breakpoint Billable amount = Second breakpoint's fixed amount.

- If sales amount is between Nth breakpoint range, then:

Nth breakpoint billable amount = Nth breakpoint's fixed amount

If the operator is Both, then:

- If sales amount is between first breakpoint range, then:

First breakpoint billable amount = (Sales amount – First breakpoint's from amount) \* First breakpoint's percent + First breakpoint's fixed amount.

- If sales amount is between second breakpoint range, then:

Second breakpoint billable amount = (Sales amount – Second breakpoint's from amount) \* Second breakpoint's percent + Second breakpoint's fixed amount.

- If sales amount is between Nth breakpoint range, then:

Nth breakpoint billable amount = (Sales amount – Nth breakpoint's from amount) \* Nth breakpoint's percent + Nth breakpoint's fixed amount.

- Total bill amount = first breakpoint's billable amount + second breakpoint's billable amount +.... + Nth breakpoint billable amount.

- If the total bill Amount is less than minimum fee, then the sales overage rent will be zero.

- If the total bill Amount is more than minimum fee, then deduct minimum fee from total bill amount to get the sales overage rent.

### Weekly Sales Method Calculation Example

Assume the minimum is 2,500 USD and the maximum is 5,000 USD.

Breakpoints:

<i>From Breakpoint</i>	<i>To Breakpoint</i>	<i>Operator</i>	<i>Percent</i>
50,000.00	150,000.00	Percent	9

<b>From Breakpoint</b>	<b>To Breakpoint</b>	<b>Operator</b>	<b>Percent</b>
150,000.01	500,000.00	Percent	8
500,000.01	1,000,000.00	Percent	7
1,000,000.01	99,999,999,999,900,000,000.00	Percent	4

Sales reported by tenant:

<b>Period</b>	<b>Sales Amount</b>	<b>1st Breakpoint</b>	<b>2nd Breakpoint</b>	<b>3rd Breakpoint</b>	<b>4th Breakpoint</b>	<b>Percent Rent</b>	<b>Final Bill</b>
1	100,000.00	4,500.00	NA	NA	NA	4,500.00	4,500.00
2	200,000.00	9,000.00	4,000.00	NA	NA	13,000.00	13,000.00
3	60,000.00	900.00	NA	NA	NA	900.00	2,500.00
4	350,000.00	9,000.00	16,000.00	NA	NA	25,000.00	25,000.00
5	1,100,000.00	9,000.00	28,000.00	35,000.00	4,000.00	76,000.00	50,000.00
6	40,000.00	NA	NA	NA	NA	0	2,500.00

### Each Period Method

This method will use only current period sales data. This calculation method will always have one sales category, which will be used for reporting/importing sales.

The system will annualize sales amount by multiplying the no. of periods in the calendar year. The system will apply breakpoints to annualized sales for calculating percent rent.

The annualized amount = current period's sales amount \* Total Periods in a fiscal year.

The system shall apply breakpoints to calculate the percent as follows:

If the operator is Percent then:

- If the sales amount is between first breakpoint range, then:

First breakpoint's billable amount = (Annualized Sales amount – First breakpoint's from amount) \* First breakpoint's percent.

- If sales amount is between second breakpoint range, then:

Second breakpoint's billable amount = (Annualized Sales amount – Second breakpoint's from amount) \* Second breakpoint's percent).

- If sales amount is between Nth breakpoint range, then:

Nth breakpoint's billable amount = (Annualized Sales amount – Nth breakpoint's from amount) \* Nth breakpoint's percent).

If the operator is Amount, then:

- If sales amount is between first breakpoint range, then:

First breakpoint's billable Amount = First breakpoint's fixed amount.

- If sales amount is between second breakpoint range, then:

Second breakpoint's billable amount = Second breakpoint's fixed amount).

- If sales amount is between Nth breakpoint range, then:

Nth breakpoint billable amount = Nth breakpoint's fixed amount).

If the operator is Both, then:

- If sales amount is between first breakpoint range, then:

First breakpoint's billable amount = (Annualized Sales amount – First breakpoint's from amount) \* First breakpoint's percent + First breakpoint's fixed amount.

- If sales amount is between second breakpoint range, then:

Second breakpoint's billable amount = (Annualized Sales amount – Second breakpoint's from amount) \* Second breakpoint's percent + Second breakpoint's fixed amount.

- If sales amount is between Nth breakpoint range, then:

Nth breakpoint billable amount = (Annualized Sales amount – Nth breakpoint's from amount) \* Nth breakpoint's percent + Nth breakpoint's fixed amount.

Total billable amount = First breakpoint's billable amount + Second breakpoint's billable amount + .... + Nth breakpoint billable amount

If the total bill amount is less than minimum fee, then the percent rent will be Zero and only minimum fee will be charged.

If the total bill Amount is more than minimum fee, then deduct minimum fee from total bill amount to get percent rent.

### Each Period Calculation Example

Assume that the minimum is 2,500 USD and the maximum is 50,000 USD.

Breakpoints:

<b>From Breakpoint</b>	<b>To Breakpoint</b>	<b>Operator</b>	<b>Percent</b>
200,000.00	600,000.00	Percent	9
600,000.01	1,000,000.00	Percent	8
1,000,000.01	1,500,000.00	Percent	7
1,500,000.01	99,999,999,999,999,900,000,000.00	Percent	4

Sales Reported by tenant:

<b>Period (Monthly)</b>	<b>Sales Amount</b>	<b>Annualized Sales</b>	<b>1st Breakpoint</b>	<b>2nd Breakpoint</b>	<b>3rd Breakpoint</b>	<b>4th Breakpoint</b>	<b>Percent Rent</b>	<b>De-Annualized Bill Amount</b>	<b>Rent Amount</b>
1	100,000.00	1,200,000.00	36,000.00	32,000.00	14,000.00	NA	82,000.00	6833.33	6833.33
2	200,000.00	2,400,000.00	36,000.00	32,000.00	35,000.00	36,000.00	139,000.00	11583.33	11583.33
3	60,000.00	720,000.00	36,000.00	9,600.00	NA	NA	45,600.00	3,800.00	3,800.00
4	350,000.00	4,200,000.00	36,000.00	32,000.00	35,000.00	108,000.00	211,000.00	17,583.33	17,583.33
5	1,200,000.00	14,400,000.00	36,000.00	32,000.00	35,000.00	516,000.00	619,000.00	51583.33	50,000.00
6	40,000.00	480,000.00	25,200.00	NA	NA	NA	25,200.00	2,100.00	2500.00

### Cumulative Method

System will calculate YTD sales amount by summing sales from the first period of the current fiscal year to current period. This calculation method will always have one sales category, which will be used for reporting/importing sales. Breakpoints will be applied to cumulative sales for calculating percent rent.

The previous YTD bill amount excluding current period will be deducted from the total bill amount to get current period's bill amount.

The YTD sales amount will equal to sum of sales amount from first period to current period. Note: The = YTD sales amount will include current period's sale amount.

The previous YTD bill amount is the sum of the bill amount from first period to previous period. Note: Previous period will be one period before the current period.

If the Operator is Percent then:

- If YTD Sales Amount is between First breakpoint range, then  

$$\text{First breakpoint's YTD Billable Amount} = (\text{YTD Sales amount} - \text{First breakpoint's from amount}) * \text{First breakpoint's Percent}$$
- If sales amount is between second breakpoint range, then:  

$$\text{Second breakpoint's YTD Bill Amount} = (\text{YTD Sales Amount} - \text{Second Breakpoint's From Amount}) * \text{Second breakpoint's Percent.}$$
- If sales amount is between Nth breakpoint range, then:  

$$\text{Nth breakpoint's YTD Bill Amount} = (\text{YTD Sales amount} - \text{Nth breakpoint's from amount}) * \text{Nth breakpoint's Percent}.$$

If the Operator is Amount, then:

- If YTD Sales Amount is between First breakpoint range, then:  

$$\text{First breakpoint's YTD billable Amount} = \text{First Breakpoint's Fixed Amount.}$$
- If YTD sales amount is between second breakpoint range, then:  

$$\text{Second breakpoint's YTD Billable Amount} = \text{Second Breakpoint's Fixed Amount)}$$
- If YTD sales amount is between Nth breakpoint range, then:  

$$\text{Nth breakpoint YTD Billable Amount} = \text{Nth breakpoint's fixed amount)}$$

If the Operator is Both, then:

- If YTD Sales Amount is between First breakpoint range, then:  

$$\text{First Breakpoint's YTD Billable Amount} = (\text{YTD Sales amount} - \text{First breakpoint's from amount}) * \text{First breakpoint's Percent} + \text{First Breakpoint's Fixed Amount.}$$
- If YTD sales amount is between second breakpoint range, then:  

$$\text{Second breakpoint's YTD Billable Amount} = (\text{YTD Sales Amount} - \text{Second Breakpoint's From Amount}) * \text{Second breakpoint's Percent} + \text{Second Breakpoint's Fixed Amount.}$$
- If YTD sales amount is between Nth breakpoint range, then:  

$$\text{Nth breakpoint YTD Billable Amount} = (\text{YTD Sales amount} - \text{Nth breakpoint's from amount}) * \text{Nth breakpoint's Percent} + \text{Nth breakpoint's fixed amount.}$$

Total YTD Billable amount = First breakpoint's YTD bill amount + Second breakpoint's YTD bill amount + ... + Nth Breakpoint YTD Bill Amount

Current period's billable amount = total YTD billable amount – previous YTD bill amount



If the total bill Amount is less than minimum fee, then the sales overage rent will be zero.

If the total bill Amount is more than minimum fee, then deduct minimum fee from total bill amount to get the percent rent (sales overage).

If the total bill amount for the current period is greater than maximum fee then the maximum fee should be charged to the tenant. In this case, percentage rent will be maximum fee less minimum fee.

When sales amount exceeds a breakpoint, then the breakpoint will have maximum billable amount and it will equal to:

(Breakpoint's To amount - Breakpoint's From amount) \* Breakpoint's percent when operator is *percentage*

Breakpoint's fixed amount when operator is 'fixed':

(Breakpoint's To amount - Breakpoint's From amount) \* Breakpoint's percent + Breakpoint's fixed amount when operator is *Both*

### Cumulative Calculation Example

Assume the minimum is 2,500 USD and the maximum is 50,000 USD.

Breakpoints:

<b>From Breakpoint</b>	<b>To Breakpoint</b>	<b>Operator</b>	<b>Percent</b>
200,000.00	600,000.00	Percent	9
600,000.01	1,000,000.00	Percent	8
1,000,000.01	1,500,000.00	Percent	7
1,500,000.01	99,999,999,999,900,000,000.00	Percent	4

Sales reported by tenant:

<b>Period Monthly</b>	<b>Sales Amount</b>	<b>Cumulative Sales</b>	<b>1st Breakpoint</b>	<b>2nd Breakpoint</b>	<b>3rd Breakpoint</b>	<b>4th Breakpoint</b>	<b>Percent Rent</b>	<b>Rent for Current Period</b>	<b>Rent Amount</b>
1	100,000.00	100,000.00	NA	NA	NA	NA	0	0	2,500.00
2	200,000.00	300,000.00	9,000.00	NA	NA	NA	9,000.00	6,500.00	6,500.00

<i>Period Monthly</i>	<i>Sales Amount</i>	<i>Cumulative Sales</i>	<i>1st Break-point</i>	<i>2nd Break-point</i>	<i>3rd Break-point</i>	<i>4th Break-point</i>	<i>Percent Rent</i>	<i>Rent for Current Period</i>	<i>Rent Amount</i>
3	60,000.00	360,000.00	14,400.00	NA	NA	NA	14,400.00	5,400.00	5,400.00
4	350,000.00	710,000.00	36,000.00	8,800.00	NA	NA	44,800.00	30,400.00	30,400.00
5	1,100,000.00	1,810,000.00	36,000.00	32,000.00	35,000.00	12,400.00	115,400.00	70,600.00	50,000.00
6	40,000.00	1,850,000.00	36,000.00	32,000.00	35,000.00	14,000.00	117,000.00	22,200.00	22,200.00

### Cumulative Pro Rata Method

YTD sales amount including current period sales will be used to calculate percent rent. This calculation method will always have one sales category.

The sales amount will be annualized by multiplying the YTD sales with the no. of periods in a calendar year divided by no. of sales periods included in YTD sales. Breakpoints will be applied to annualized cumulative sales when calculating percent rent.

To calculate current period bill amount, percent rent amount will be de-annualized and from that amount the previous YTD bill amount will be reduced.

Add YTD sales to get the Cumulative amount. The YTD sales amount will be the sum of sales amount from first period to current period. Note: Include current period sales into YTD sales. Annualize the YTD sales. Annual sales amount = YTD sales \* (total periods in fiscal year/ no. periods in YTD sales). Calculate YTD bill amount by applying lease level breakpoints to annualized cumulative sales.

If the Operator is Percent then:

- If Sales Amount is between First breakpoint range, then:  

$$\text{First breakpoint Billable Amount} = (\text{Annualized YTD Sales amount} - \text{First breakpoint's from amount}) * \text{First breakpoint's Percent}$$
- If sales amount is between second breakpoint range, then:  

$$\text{Second breakpoint's Billable Amount} = (\text{Annualized YTD Sales Amount} - \text{Second Breakpoint's From Amount}) * \text{Second breakpoint's Percent}$$
- If sales amount is between Nth breakpoint range, then:  

$$\text{Nth breakpoint's Billable Amount} = (\text{Annualized YTD Sales amount} - \text{Nth breakpoint's from amount}) * \text{Nth breakpoint's Percent}$$

If the Operator is Amount, then:

- If sales Amount is between First breakpoint range, then:

Bill Amount = First Breakpoint's Fixed Amount

- If sales amount is between second breakpoint range, then:

Bill Amount = (First Breakpoint maximum Bill Amount + Second Breakpoint's Fixed Amount)

- If sales amount is between Nth breakpoint range, then:

Bill Amount = (First breakpoint's maximum bill amount + Second breakpoint's maximum bill amount + ...+(n-1) breakpoint's maximum bill amount + Nth breakpoint's fixed amount)

If the Operator is Both, then:

- If Sales Amount is between First breakpoint range, then:

First breakpoint's Billable Amount = (Annualized YTD Sales amount – First breakpoint's from amount) \* First breakpoint's Percent) + First Breakpoint's Fixed Amount

- If sales amount is between second breakpoint range, then:

Second breakpoint's Billable Amount = (Annualized YTD Sales Amount – Second Breakpoint's From Amount) \* Second breakpoint's percent + Second Breakpoint's fixed amount)

- If sales amount is between Nth breakpoint range, then:

Nth breakpoint billable amount = (Annualized YTD sales amount – Nth breakpoint's from amount) \* Nth breakpoint's Percent + Nth breakpoint's fixed amount

Total annualized YTD Billable amount = First breakpoint's billable amount + Second breakpoint's billable amount + ... + Nth Breakpoint Billable Amount

De-annualize the above value to get YTD billable amount. YTD billable amount = Total annualized YTD billable amount \* (No. periods in YTD sales / Total periods in fiscal year)

System will calculate Total bill amount by deducting previous YTD bill amount from rent calculated in step above (de-annualized rent).

If the total bill Amount is less than minimum fee, then the sales overage rent will be zero. If the total bill amount is more than minimum fee, then deduct minimum fee from total bill amount to get sales overage rent. If the total bill amount for the current period is greater than maximum fee then the maximum fee should be charged to the tenant. In this case, percentage rent will be maximum fee less minimum fee.

When sales amount exceeds a breakpoint, then the breakpoint will have maximum billable amount and it shall equal to: (Breakpoint's To amount - Breakpoint's From amount) \* Breakpoint's percent when operator is *percentage*

Breakpoint's fixed amount when operator is *fixed*: (Breakpoint's "To amount" - Breakpoint's From amount) \* Breakpoint's percent + Breakpoint's fixed amount when operator is *Both*

### Cumulative Pro Rata Calculation Example

Assume the minimum is 2,500 USD and the maximum is 50,000 USD.

Breakpoints:

<b>From Breakpoint</b>	<b>To Breakpoint</b>	<b>Operator</b>	<b>Percent</b>
500,000.00	1,000,000.00	Percent	9
1,000,000.01	1,500,000.00	Percent	8
1,500,000.01	1,500,000.00	Percent	7
3,000,000.01	99,999,999,999,999,900,000,000.00	Percent	4

Sales reported by tenant:

<b>Period Monthly</b>	<b>Sales Amount</b>	<b>Cumul-ative Sales</b>	<b>Annual-ized Cumul-ative Sales</b>	<b>1st Break-point</b>	<b>2nd Break-point</b>	<b>3rd Break-point</b>	<b>4th Break-point</b>	<b>Percent Rent</b>	<b>De-Annual-ized Percent Rent</b>	<b>Rent for Current Period</b>	<b>Rent Amount</b>
1	100,000.00	100,000.00	1,200,000.00	45,000.00	16,000.00	NA	NA	61,000.00	5,083.33	5,083.33	5,083.33
2	200,000.00	300,000.00	1,800,000.00	45,000.00	40,000.00	21,000.00	NA	106,000.00	17,666.67	12,583.33	12,583.33
3	60,000.00	360,000.00	1,440,000.00	45,000.00	35,200.00	NA	NA	80,200.00	20,050.00	2,383.33	2,500.00
4	350,000.00	710,000.00	2,130,000.00	45,000.00	40,000.00	44,100.00	NA	129,100.00	43,033.33	22,866.67	22,866.67
5	1,100,000.00	1,810,000.00	4,344,000.00	45,000.00	40,000.00	105,000.00	53,760.00	243,760.00	101,566.67	58,533.33	50,000.00
6	40,000.00	1,850,000.00	3,700,000.00	45,000.00	40,000.00	105,000.00	28,000.00	218,000.00	109,000.00	15,966.67	15,966.67

### Modified Cumulative Method

YTD sales amount including current period sales will be used to calculate percent rent. This calculation method will always have one sales category. The following calculation shall be used when calculating percent rent:

Get the highest breakpoint that the total sales amount is reached. Apply the highest breakpoint to the entire sales amount that exceeds the first breakpoint. The YTD bill amount excluding current period will be deducted from the total bill amount to get current period's bill amount.

The YTD sales amount is equal to sum of sales amount from first period to current period. Note: The = YTD sales amount includes current period's sale amount.

If the Operator is Percent then:

- If YTD Sales Amount is between First breakpoint range, then:

First breakpoint's YTD Billable Amount = (YTD Sales amount – First breakpoint's from amount) \* First breakpoint's Percent

- If sales amount is between Nth breakpoint range, then:

Nth breakpoint's YTD Bill Amount = (YTD Sales amount – First breakpoint's From amount) \* Nth breakpoint's Percent

If the Operator is Amount, then:

- If YTD Sales Amount is between First breakpoint range, then:

First breakpoint's YTD billable Amount = First Breakpoint's Fixed Amount

- If YTD sales amount is between Nth breakpoint range, then:

Nth breakpoint YTD Billable Amount = Nth breakpoint's fixed amount

If the Operator is Both, then:

- If YTD Sales Amount is between First breakpoint range, then:

First Breakpoint's YTD Billable Amount = (YTD Sales amount – First breakpoint's from amount) \* First breakpoint's Percent + First Breakpoint's Fixed Amount

- If YTD sales amount is between Nth breakpoint range, then:

Nth breakpoint YTD Billable Amount = (YTD Sales amount – First breakpoint's From amount) \* Nth breakpoint's Percent + Nth breakpoint's fixed amount

Total YTD Billable amount = First breakpoint's YTD bill amount + .... +Nth Breakpoint YTD Bill Amount

Current period's billable amount = total YTD billable amount – previous YTD bill amount

If the total bill Amount is less than minimum fee, then the sales overage rent shall be Zero. If the total bill Amount is more than minimum fee, then deduct minimum fee from total bill amount to get sales overage rent. If the total bill amount for the current period is greater than maximum fee then the maximum fee should be charged to the tenant. In this case, percentage rent will be maximum fee less minimum fee.

When sales amount exceeds a breakpoint, then the breakpoint will have maximum billable amount and it is equal to: (Breakpoint's To amount - Breakpoint's From amount) \* Breakpoint's percent when operator is *percentage*

Breakpoint's fixed amount when operator is *fixed*: (Breakpoint's To amount - Breakpoint's From amount) \* Breakpoint's percent + Breakpoint's fixed amount when operator is *Both*

## Modified Cumulative Calculation Example

Assume the minimum is 2,500 USD and the maximum is 50,000 USD.

Breakpoints:

<b>From Breakpoint</b>	<b>To Breakpoint</b>	<b>Operator</b>	<b>Percent</b>
200,000.00	600,000.00	Percent	9
600,000.01	1,000,000.00	Percent	8
1,000,000.01	1,500,000.00	Percent	7
1,500,000.01	99,999,999,999,900,000,000.00	Percent	4

Sales reported by tenant:

<b>Period (Monthly)</b>	<b>Sales Amount</b>	<b>Cumulative Sales</b>	<b>1st Breakpoint</b>	<b>2nd Breakpoint</b>	<b>3rd Breakpoint</b>	<b>4th Breakpoint</b>	<b>Percent Rent</b>	<b>Rent for Current Period</b>	<b>Rent Amount</b>
1	100,000.00	100,000.00	NA	NA	NA	NA	0	0	2,500.00
2	200,000.00	300,000.00	9,000.00	NA	NA	NA	9,000.00	6,500.00	6,500.00
3	60,000.00	360,000.00	14,400.00	NA	NA	NA	14,400.00	5,400.00	5,400.00
4	350,000.00	710,000.00	NA	40800.00	NA	NA	40,800.00	26,400.00	26,400.00
5	1,100,000.00	1,810,000.00	NA	NA	NA	64,400.00	64,400.00	23,600.00	23,600.00
6	40,000.00	1,850,000.00	NA	NA	NA	66,000.00	66,000.00	1,600.00	2,500.00

## Partial Year Pro Rata Method

In a specialized billing reconciliation, property owners use the lease period as a cutoff date. Therefore, any tenant who moves in or out within the lease period can be charged a prorated share of the sales for the partial period. For calculating the prorated rent amount, the sales data for the period of one year beginning from lease commencement date will be considered. In the case of last period, the sales data for the period of one year ending on lease termination date will be used for calculating rent. System will use the following formula for calculating the rent amount:

- First period = Rent calculated as per breakpoints \* (Next period begin date – Lease Commencement date) / (Number of days in the year)
- Last period = Rent calculated as per breakpoints \* (Lease Termination date - previous period End Date) / (Number of days in the year)

If the prorate first and last period Partial Year Proration flag is checked on the Percent Rent Terms page, then first and last period percentage rent will be calculated by this method. Rent calculated as per breakpoint will be as per the calculation method selected on the lease. The partial year prorata feature can be used only with annual calendars. In the formula mentioned above, by default, if the partial year proration option is checked then the number of days in the denominator would be same as actual number of days in the year (365/366). If on financial terms page the user has selected the 360 days proration method, then in that case the denominator value in formula mentioned above will be 360.

## Partial Year Pro Rata Calculation Example

Assume the minimum is 2,500 USD and the maximum is 50,000 USD.

Breakpoints:

<b><i>From Breakpoint</i></b>	<b><i>To Breakpoint</i></b>	<b><i>Operator</i></b>	<b><i>Percent</i></b>
200,000.00	600,000.00	Percent	9
600,000.01	1,000,000.00	Percent	8
1,000,000.01	1,500,000.00	Percent	7
1,500,000.01	99,999,999,999,900,000,000.00	Percent	4

Sales reported by tenant:

<b>Period (Yearly)</b>	<b>Sales Amount</b>	<b>Annualized Sales</b>	<b>1st Break-point</b>	<b>2nd Break-point</b>	<b>3rd Break-point</b>	<b>4th Break-point</b>	<b>Percent Rent</b>	<b>De-Annualized Bill Amount</b>	<b>Rent Amount</b>	<b>Proration Ratio</b>	<b>Final Rent</b>
2006	1,200,000.00	1,200,000.00	36,000.00	32,000.00	14,000.00	NA	82,000.00	82,000.00	6,833.33	0.59	4,006.39
2007	2,400,000.00	2,400,000.00	36,000.00	32,000.00	35,000.00	36,000.00	139,000.00	139,000.00	11,583.33	1	11,583.33
2008	720,000.00	720,000.00	36,000.00	9,600.00	NA	NA	45,600.00	45,600.00	3,800.00	1	3,800.00
2009	4,200,000.00	4,200,000.00	36,000.00	32,000.00	35,000.00	108,000.00	211,000.00	211,000.00	17,583.33	1	17,583.33
2010	14,400,000.00	14,400,000.00	36,000.00	32,000.00	35,000.00	516,000.00	619,000.00	619,000.00	50,000.00	1	50,000.00
2011	480,000.00	480,000.00	25,200.00	NA	NA	NA	25,500.00	25,500.00	2,100.00	0.58	1,219.72

### Lease Pro Rata Method

This method uses two levels of breakpoints: Lease level and Sales reporting categories level. Lease level breakpoints will be used to calculate total bill amount on total sales of all categories. Category level breakpoints will be used to distribute bill amount by category.

YTD sales amount that includes current period sales will be used to calculate percent rent. Sales amount will be sum of all sales categories' sales amount. The sales amount shall be annualized by multiplying the no. of periods in a calendar year divided by no. of sales periods included in YTD sales.

Lease level breakpoints will be applied to annualized cumulative sales to calculate percent rent amount. The rent amount will be de-annualized by dividing calculated rent by the no. of periods in a calendar year and then multiplying the same by number of sales periods included in YTD sales. To calculate current period bill amount, the previous periods YTD bill amount will be reduced from the amount calculated in the step above.

If rent amount for the current period is less than the minimum fee then minimum fee will be charged to tenant as percentage rent. If rent amount for the current period is greater than maximum fee then maximum fee will be charged as percentage rent.

This method does not categorize the rent as minimum and percentage rent. For this method, the total rent amount will be distributed by categories.

To prorate the total bill amount among the categories:



- YTD sales amount for the category will be used for calculation.
- The category's sales amount will be annualized by multiplying the no. of periods in a calendar year divided by no. of sales periods included in YTD sales.
- Category level breakpoints will be applied to annualized cumulative sales to get the category's bill amount. This calculation will be performed for all categories.
- The total rent amount will be distributed among sales categories using ratio of amount calculated in step above. If none of the category has reached its breakpoint then the rent amount will be distributed in ratio of cumulative sales for all categories.

Get the total sales amount by summing up all sales categories sales.

Calculate the YTD (Year-To-Date) sales by summing up all sales from first period to current period.

Annualize the YTD sales. Annualized YTD sales = YTD sales \* (Total periods in fiscal year / No. periods in YTD sales).

If the Operator is Percent then:

- If annualized YTD Sales Amount is between First breakpoint range, then:  

$$\text{First breakpoint Billable Amount} = (\text{Annualized YTD Sales amount} - \text{First breakpoint's from amount}) * \text{First breakpoint's Percent}$$
- If annualized YTD sales amount is between second breakpoint range, then:  

$$\text{Second breakpoint's Billable Amount} = (\text{Annualized YTD Sales Amount} - \text{Second Breakpoint's From Amount}) * \text{Second breakpoint's Percent}$$
- If annualized YTD sales amount is between Nth breakpoint range, then:  

$$\text{Nth breakpoint's Billable Amount} = (\text{Annualized YTD Sales amount} - \text{Nth breakpoint's from amount}) * \text{Nth breakpoint's Percent}$$

If the Operator is Amount, then:

- If annualized YTD Sales Amount is between First breakpoint range, then:  

$$\text{Bill Amount} = \text{First Breakpoint's Fixed Amount}$$
- If annualized YTD sales amount is between second breakpoint range, then:  

$$\text{Bill Amount} = (\text{First Breakpoint maximum Bill Amount} + \text{Second Breakpoint's Fixed Amount})$$
- If annualized YTD sales amount is between Nth breakpoint range, then:  

$$\text{Bill Amount} = (\text{First breakpoint's maximum bill amount} + \text{Second breakpoint's maximum bill amount} + \dots + (\text{n}-1) \text{ breakpoint's maximum bill amount} + \text{Nth breakpoint's fixed amount})$$

If the Operator is Both, then:

- If Sales Amount is between First breakpoint range, then:  

$$\text{First breakpoint's Billable Amount} = (\text{Annualized YTD Sales amount} - \text{First breakpoint's from amount}) * \text{First breakpoint's Percent} + \text{First Breakpoint's Fixed Amount}$$

- If sales amount is between second breakpoint range, then:

Second breakpoint's Billable Amount = (Annualized YTD Sales Amount – Second Breakpoint's From Amount) \* Second breakpoint's Percent + Second Breakpoint's Fixed Amount)

- If sales amount is between Nth breakpoint range, then:

Nth breakpoint Billable Amount = (Annualized YTD Sales amount – Nth breakpoint's from amount) \* Nth breakpoint's Percent + Nth breakpoint's fixed amount

Total annualized YTD Billable amount = First breakpoint's billable amount + Second breakpoint's billable amount + ... + Nth Breakpoint Billable Amount

De-annualize the above value to get YTD billable amount. YTD billable amount = Total annualized YTD billable amount \* (No. periods in YTD sales / Total periods in fiscal year)

Subtract the Previous period YTD bill amount to get the current Total Bill amount.

Prorate the Total bill amount among all the sales categories using the following method:

- Calculate the YTD (Year-To-Date) sales by summing up a category's sales from first period to current period.
- Annualize the category YTD sales. Annualized YTD category sales = category YTD sales \* (Total periods / No. periods in YTD sales).

Apply the category level breakpoints:

If the Operator is Percent then:

- If annualized YTD category Sales Amount is between First breakpoint range, then:

First breakpoint Billable Amount = (Annualized YTD category Sales amount – First breakpoint's from amount) \* First breakpoint's Percent

- If annualized YTD category sales amount is between second breakpoint range, then:

Second breakpoint's Billable Amount = (Annualized YTD category Sales Amount – Second Breakpoint's From Amount) \* Second breakpoint's Percent

- If annualized YTD category sales amount is between Nth breakpoint range, then:

Nth breakpoint's Billable Amount = (Annualized YTD category Sales amount – Nth breakpoint's from amount) \* Nth breakpoint's Percent)

If the Operator is Amount, then:

- If annualized YTD category Sales Amount is between First breakpoint range, then:

First Breakpoint's category Billable Amount = First Breakpoint's Fixed Amount

- If annualized YTD category sales amount is between second breakpoint range, then:

Second Breakpoint's category Billable Amount = Second Breakpoint's Fixed Amount

- If annualized YTD sales amount is between Nth breakpoint range, then:

Nth breakpoint's category Bill Amount = Nth breakpoint's fixed amount

If the Operator is Both, then:

- If annualized YTD category Sales Amount is between First breakpoint range, then:

First breakpoint's category Billable Amount = (Annualized YTD category Sales amount – First breakpoint's from amount) \* First breakpoint's Percent) + First Breakpoint's Fixed Amount

- If sales amount is between second breakpoint range, then:

Second breakpoint's category Billable Amount = (Annualized YTD category Sales Amount – Second Breakpoint's From Amount) \* Second breakpoint's Percent + Second Breakpoint's Fixed Amount)

- If sales amount is between Nth breakpoint range, then:

Nth breakpoint Billable Amount = (Annualized YTD Sales amount – Nth breakpoint's from amount) \* Nth breakpoint's Percent + Nth breakpoint's fixed amount

Annualized YTD category Billable amount = First breakpoint's category billable amount + Second breakpoint's category billable amount + ... + Nth Breakpoint category Billable Amount

Category's bill amount = Total billable amount \* Annualized YTD category Billable amount / sum of all sales categories annualized YTD category billable amount.

If the total bill Amount is less than minimum fee, then the minimum rent will be charged as percentage rent. If the total bill Amount is greater than maximum then maximum fee will be charged as percentage rent.

When sales amount exceeds a breakpoint, then the breakpoint will have maximum billable amount and it shall equal to: (Breakpoint's To amount - Breakpoint's From amount) \* Breakpoint's percent when operator is *percentage*

Breakpoint's fixed amount when operator is *fixed*: (Breakpoint's To amount - Breakpoint's From amount) \* Breakpoint's percent + Breakpoint's fixed amount when operator is *Both*

## Lease Pro Rata Calculation Examples

Assume the minimum is 2,500 USD and the maximum is 50,000 USD.

Breakpoints:

<b><i>From Breakpoint</i></b>	<b><i>To Breakpoint</i></b>	<b><i>Operator</i></b>	<b><i>Percent</i></b>
500,000.00	1,000,000.00	Percent	9
1,000,000.01	1,500,000.00	Percent	8
1,500,000.01	1,500,000.00	Percent	7

<b>From Breakpoint</b>	<b>To Breakpoint</b>	<b>Operator</b>	<b>Percent</b>
3,000,000.01	99,999,999,999,900,000,000.00	Percent	4

Method details:

- Tenant will report sales at agreed frequency.
- Billing for percent rent will be as per calendar defined on the percent rent term page.
- Even though sales are reported category wise the breakpoints will be applied to annualized cumulative total sales figure.
- For calculating cumulative and annualized sales, all reported/estimated sales report in current year will be considered.
- Breakpoints will be applied to annualized sales.
- Percent rent amount charged for previous period will be reduced from the calculated amount.

Sales reported by tenant:

<b>Period Monthly</b>	<b>Sales Amount</b>	<b>Cumulative Sales</b>	<b>Annualized Cumulative Sales</b>	<b>1st Breakpoint</b>	<b>2nd Breakpoint</b>	<b>3rd Breakpoint</b>	<b>4th Breakpoint</b>	<b>Percent Rent</b>	<b>De-annualized Percent Rent</b>	<b>Rent for Current Period</b>	<b>Rent Amount</b>
1	100,000.00	100,000.00	1,200,000.00	45,000.00	16,000.00	NA	NA	61,000.00	5,083.33	5,083.33	5,083.33
2	200,000.00	300,000.00	1,800,000.00	45,000.00	40,000.00	21,000.00	NA	106,000.00	17,666.67	12,583.33	12,583.33
3	60,000.00	360,000.00	1,440,000.00	45,000.00	35,200.00	NA	NA	80,200.00	20,050.00	2,383.33	2,500.00
4	350,000.00	710,000.00	2,130,000.00	45,000.00	40,000.00	44,100.00	NA	129,100.00	43,033.33	22,866.67	22,866.67
5	1,100,000.00	1,810,000.00	4,344,000.00	45,000.00	40,000.00	105,000.00	53760.00	243,760.00	101,566.67	58,533.33	50,000.00
6	40,000.00	1,850,000.00	3,700,000.00	45,000.00	40,000.00	105,000.00	28,000.00	218,000.00	109,000.00	15,966.67	15,966.67

For the following sales categories assume that the percent rent amount for the period will be distributed in ratio of amount calculated category wise on sales category breakpoint and if in any period none of the categories exceed first breakpoint then percent rent for the period will be distributed in ratio of sales.

Food breakpoints:

<b>From Breakpoint</b>	<b>To Breakpoint</b>	<b>Operator</b>	<b>Percent</b>
400,000.00	500,000.00	Percent	6
500,000.01	99,999,999,999,900,000,000.00	Percent	3

Beverages Breakpoints:

<b>From Breakpoint</b>	<b>To Breakpoint</b>	<b>Operator</b>	<b>Percent</b>
300,000.00	600,000.00	Percent	5
600,000.01	99,999,999,999,900,000,000.00	Percent	3

Liquor Breakpoints:

<b>From Breakpoint</b>	<b>To Breakpoint</b>	<b>Operator</b>	<b>Percent</b>
700,000.00	1,000,000.00	Percent	9
1,000,000.01	99,999,999,999,900,000,000.00	Percent	5

Period 1 percent rent = 5,083.33

Period rent details:

<b>Category</b>	<b>Cumulative Sales and Sales Amount</b>	<b>Annualized Sales</b>	<b>Percent Rent</b>	<b>Distributed Rent</b>
Food	30,000	360,000	0	1,525
Beverages	20,000	240,000	0	1016.67
Liquor	50,000	600,000	0	2,541.67

<b>Category</b>	<b>Cumulative Sales and Sales Amount</b>	<b>Annualized Sales</b>	<b>Percent Rent</b>	<b>Distributed Rent</b>
Totals	100,000	1,200,000	0	

Period 2 percent rent = 12,583.33

Period rent details:

<b>Category</b>	<b>Cumulative Sales</b>	<b>Sales Amount</b>	<b>Annualized Sales</b>	<b>Percent Rent</b>	<b>Distributed Rent</b>
Food	60,000	30,000	360,000	0	0
Beverages	50,000	30,000	300,000	0	0
Liquor	190,000	140,000	1,140,000	39,600	12,583.33
Totals	300,000		1,800,000	39,600	

Period 3 percent rent = 2,500

Period rent details:

<b>Category</b>	<b>Cumulative Sales</b>	<b>Sales Amount</b>	<b>Annualized Sales</b>	<b>Percent Rent</b>	<b>Distributed Rent</b>
Food	75,000	15,000	300,000	0	0
Beverages	75,000	25,000	300,000	0	0
Liquor	210,000	20,000	840,000	12,600	0
Totals	360,000		1,440,000	12,600	2,500

Period 4 percent rent = 22,866.67

Period rent details:

<b>Category</b>	<b>Cumulative Sales</b>	<b>Sales Amount</b>	<b>Annualized Sales</b>	<b>Percent Rent</b>	<b>Distributed Rent</b>
Food	180,000	105,000	540,000	7,200	3,380.70
Beverages	130,000	55,000	390,000	4,500	2,112.94
Liquor	400,000	190,000	1,200,000	37,000	17,373.03
Totals	710,000		2,130,000	48,700	

Period 5 percent rent = 50,000

Period rent details:

<b>Category</b>	<b>Cumulative Sales</b>	<b>Sales Amount</b>	<b>Annualized Sales</b>	<b>Percent Rent</b>	<b>Distributed Rent</b>
Food	600,000	420,000	1,440,000	34,200	12,787.92
Beverages	410,000	280,000	984,000	26,520	9,916.24
Liquor	800,000	400,000	1,920,000	73,000	27,295.84
Totals	1,810,000		4,344,000	133,720	

Period 6 percent rent = 15,966.67

Period rent details:

<b>Category</b>	<b>Cumulative Sales</b>	<b>Sales Amount</b>	<b>Annualized Sales</b>	<b>Percent Rent</b>	<b>Distributed Rent</b>
Food	610,000	10,000	1,220,000	27,600	4,065.31
Beverages	430,000	20,000	860,000	22,800	3,358.30
Liquor	810,000	10,000	1,620,000	58,000	8,543.05
Totals	1,850,000		3,700,000	108,400	

## Sales Estimation Methods

The PeopleSoft Lease Administration system provides you with three sales estimation methods to assist you in deciding the estimated sales data. Using this data helps you determine the monthly rent amount.

The three sales estimation methods are:

- *Past 6 Period Average:* The system takes an average of sales of all prior periods up to six months, assuming there is sales data for the last six months in the database.

If data is not available for all six months, it takes only the average of whatever data is available up to the last six months. The system cannot provide an estimate if there is no data for the last six months.

- *Same Period Last Year:* The system takes the sales from the same period last year assuming there is sales data for the same period last year.

For example, if the current sales report being estimated is period 2 of 2005, then the system looks for period 2 of 2004 to formulate an estimate. The system cannot provide an estimate if there is no data for the same period last year.

- *Prior Period:* The system takes the sales for the preceding period, assuming there is sales data for the preceding period. The system cannot provide an estimate if there is no data for the preceding period.

---

**Note:** In addition to the sales estimation methods, the system also provides an adjustment factor that is a percentage field, at the lease level, to assist with altering the numbers to account for slower business, recession periods, inflation, and so on.

---

## Adjustments to Estimated Rents

When you bill based on estimated sales, you will likely need to make adjustments, effectively changing the actual billable rent amount. The system provides the ability to adjust the previously calculated and processed data, as well as the ability to adjust the prior entries posted to the various subsystems. This is called the sales report revision.

A change to previously processed calculated data is called an adjustment. You can change sales report data any number of times before the transactions are processed. While making an adjustment, you select the sales type to indicate the changes that you are making. The sales type has no bearing on generating billing lines; it is informational only. The same billing lines are generated regardless of type and are updated at any time throughout this process.

When you enter the new data, the system calculates the rent amount on the worksheet. However, the system also takes into account the last processed worksheet and compares the two to determine the amount of the adjustment. Although the data from worksheet to worksheet is compared to determine the net difference, doing so accurately over multiple iterations can be complicated. As a result, the system uses the last of the prior worksheets to determine the amount billed. The system creates a complete reversal of the bill, sending a negative bill entry to the same transaction code by sales category, and updates the bill with the new amounts. For example, the original worksheet has three sales categories and three bill lines generated for billing, each with a unique transaction code. During an adjustment process, three negative bill line entries are created for the full amount billed, along with three new bill lines for the new full amount to bill.

On the Sales Report Details page for processed reports, the latest worksheet appears as display-only until you click the **Update Report** button. The worksheet is then available for changes, and a new version



is saved to the table with a new revision number. You can view all past adjustments, but adjust only the latest one.

---

## Prerequisites

Before setting up percent rent terms, you must set up the following:

- Detail calendars for percent rent schedules.
- Calendar ID selection for the business unit.
- Sales categories.
- Transaction routing codes.
- Accounting rules.

---

## Setting Up Percent Rent Terms

This topic discusses how to enter percent rent terms.

### Pages Used to Set Up Percent Rent Terms

<b>Page Name</b>	<b>Definition Name</b>	<b>Usage</b>
<u>Create New Lease - Financial Terms Page</u>	RE_LS_TERMS	Enter financial terms for a lease.
<u>Financial Terms - Percent Rent Page</u>	RE_LS_PCTRENT_SEC	Enter the sales estimation method, sales category, and breakpoints.
Accounting Distributions Page	RE_LS_PCT_DST_SEC	Override the accounting distributions defined at the business unit level.  <u>Financial Terms - Percent Rent Page</u>
Accounting Distributions Page	RE_LS_SLS_DST_SEC	Override the accounting distributions defined on the percent term.  <u>Financial Terms - Percent Rent Page</u>

### Financial Terms - Percent Rent Page

Use the Financial Terms - Percent Rent page (RE\_LS\_PCTRENT\_SEC) to enter the sales estimation method, sales categories, and breakpoints.

Navigation:



<b>Field or Control</b>	<b>Description</b>
<b>Payor</b>	Enter the entity that is responsible for making payments. The system uses the tenant as the default. This field appears only for receivables leases.
<b>Reporting Calendar</b>	Enter the calendar ID, which determines the frequency with which you report or receive sales reports. Percent rent sales reporting uses a specific calendar with distinct periods and start and end dates. In addition, this calendar structure enables the system to search for and determine when sales reports are missing, as well as to prevent duplicate sales reports for the same period. The system uses the percent rent calendar ID value from the from the business unit level, but you can override this value at the least level.
<b>Billing Calendar</b>	The billing calendar defaults from the business unit definition. This determines the frequency with which bills are generated.
<b>Partial Year Proration</b>	<p>Select this option if a tenant has moved in or out within a fiscal year that is specified in the system. If the prorate first and last period <b>Partial Year Proration</b> field is checked on the Percent Rent Terms page, then first and last period percentage rent will be calculated by this method. Rent calculated per breakpoint will be the calculation method selected on the lease.</p> <hr/> <p><b>Note:</b> System will allow only the <i>Annual</i> calendar if the <b>Partial Year Proration</b> field is selected.</p> <hr/>
<b>Minimum Fee</b>	<p>Enter the minimum amount to be charged for the entire percent rent. If the minimum is not met, the amount is increased to the minimum level.</p> <hr/> <p><b>Note:</b> If the amount calculated based on sales reported by payor and breakpoints is less than the minimum fee, then the minimum fee amount is spread across the sales categories in the ratio of the calculated bill amount.</p> <hr/>
<b>Maximum Fee</b>	<p>Enter the maximum amount to be charged to the entire percent rent. If the maximum is exceeded, the amount is reduced to the maximum level.</p> <hr/> <p><b>Note:</b> If the amount calculated based on sales reported by payor and breakpoints is greater than the maximum fee, then the maximum fee amount is spread across the sales categories in the ratio of the calculated bill amount.</p> <hr/>
<b>Ship To</b>	Enter the supplier ship to location. This location will be used for VAT and SUT calculations by PeopleSoft Payables Voucher Build application.

<b>Field or Control</b>	<b>Description</b>
<b>Calculation Method</b>	<p>This is a required field. Select from the following:</p> <ul style="list-style-type: none"> <li>• <i>Category Based:</i> The rent amount for the category is calculated by using breakpoints defined for sales reporting categories and the rent amount for all categories will be summed up to calculated overall percent rent. This method will not use lease level breakpoint.</li> <li>• <i>Cumulative:</i> The system will apply breakpoints on Year-to-date (YTD) sales amount and deduct prior YTD percent rent charges to calculate the current period percent rent.</li> <li>• <i>Cumulative Pro Rata:</i> The system will annualize the YTD sales amount. The system applies breakpoints, de-annualizes, and subtracts previous YTD rent to get the current period percent rent.</li> <li>• <i>Cumulative Break Point Pro Rata:</i> The system will calculate the prorated breakpoint for the current reporting/billing period and apply the prorated break point on the YTD Sales amount. The system subtracts the YTD rent to get the current period percent rent. In this method, only one breakpoint is used in the Percent Rent Calculation.</li> <li>• <i>Each Period:</i> The system will annualize the sales amount. It applies the lease breakpoints and de-annualizes to calculate the percent rent.</li> <li>• <i>Lease Pro Rata:</i> The system will use lease breakpoints to determine a billable amount and then distribute the percent rent among sales categories to prorate the billable amount. The calculation methodology is same as Cumulative Pro Rata. For this method both lease level and category level breakpoints are required. Lease level breakpoints will be used to calculate the total percent rent charge.</li> <li>• <i>Modified Cumulative:</i> The system will apply the highest breakpoint on YTD sales that exceeds first breakpoint. The system deducts the prior YTD percent rent to get the current percent rent.</li> <li>• <i>Weekly Sales:</i> The system will use the sales amount of a week to calculate the percent rent.</li> </ul>
<b>Billing Schedule</b>	<p>While activating the Lease, the system generates billing schedules based on the billing calendar periods. The schedule date on the billing schedules will be calculated if the billing schedule is entered. When the billing schedule is not entered, the schedule date will be null on the billing schedules.</p>
<b>Accounting Distribution</b>	<p>Click this link to access the Accounting Distribution page and to override the default rules defined at the business unit level.</p>
<b>Add Sales Category</b>	<p>Click to add an additional sales category in the group box.</p>

<b>Field or Control</b>	<b>Description</b>
<b>Calculate Breakpoints</b>	Click to calculate breakpoints. If you have multiple breakpoints, the system calculates the <b>To Breakpoint</b> from the data entered into the <b>From Breakpoint</b> .
<b>Sales Category</b>	Select a sales category to classify sales reports. You can select only from active sales categories.  See <a href="#">Defining Sales Categories</a> .
<b>Add Effective Date</b>	Click to add a new effective dated row.
<b>Accounting Distribution</b>	Click this link to access the Accounting Distribution page and to override the default rules defined on the percent rent term. The accounting distribution can be defined at the header level as well as for each category. First, the category level accounting distribution is considered. If no accounting rules are defined for the category, then the accounting distributions for the header are used.
<b>Add Breakpoint</b>	Click to add an additional breakpoint.

## Breakpoints

Breakpoints are available for edit only when the lease is in a pending or amendment status.

<b>Field or Control</b>	<b>Description</b>
<b>From Breakpoint</b>	Enter the starting amount for the break. For the first break, this value appears as 0. You use breakpoints within each of the sales categories to facilitate the assigning of rent based on the sales.
<b>To Breakpoint</b>	Displays the maximum sales amount allowed within the break. The system determines this value based on the next breakpoint entered when you click the <b>OK</b> or the <b>Calculate Breakpoints</b> button.

<b>Field or Control</b>	<b>Description</b>
<b>Operator</b>	<p>Enter the operator to use for the calculation of rent based on the sales amount. These are the options:</p> <p><i>Amount:</i> Specifies that a fixed amount be applied as rent within a breakpoint for a sales category.</p> <hr/> <p><b>Note:</b> If you select this option, you must enter a value in the <b>Amount</b> field.</p> <hr/> <p><i>Percent:</i> Specifies that a percentage of the amount be applied as rent within a breakpoint for a sales category.</p> <hr/> <p><b>Note:</b> If you select this option, you must enter a value in the <b>Percent</b> field.</p> <hr/> <p><i>Both:</i> Specifies that both a fixed amount and a percentage of the amount be applied as rent within a breakpoint for a sales category.</p> <hr/> <p><b>Note:</b> If you select this option, you must enter values in the <b>Amount</b> and <b>Percent</b> fields.</p> <hr/>
<b>Amount</b>	<p>Enter a flat rent amount to be charged.</p> <hr/> <p><b>Note:</b> This is a required field if the <b>Operator</b> field is set to <i>Amount</i> or <i>Both</i>. You must enter a base amount for billing or payment.</p> <hr/>
<b>Percent</b>	<p>Enter the percentage to be applied to the sales amount to calculate the rent.</p> <hr/> <p><b>Note:</b> This is a required field if the <b>Operator</b> field is set to <i>Percent</i> or <i>Both</i>.</p> <hr/>

## Reporting Sales and Calculating Percent Rent

This topic provides an overview of sales reporting and percent rent calculation.

## Pages Used to Report Sales and Calculate Percent Rent

<b>Page Name</b>	<b>Definition Name</b>	<b>Usage</b>
<a href="#">Report Sales - Sales Reports Page</a>	RE_SLSRPT_SRCH	Search for all available sales reports. Create a new sales report and import sales data.
<a href="#">Report Sales - Find Missing Sales Reports Page</a>	RE_MISSING_SLS	Find missing sales reports.
<a href="#">Report Sales - Create New Sales Reports Page</a>	RE_SLSRPT_INV	Create new sales reports.
Report Sales - Sales Report Details Page	RE_SLSRPT_INV	View processed sales reports or modify pending sales reports.  <a href="#">Report Sales - Create New Sales Reports Page</a>
Sales Calculation Log Page	RE_SLS_CALC_LOG	View calculation information for the bill.  <a href="#">Report Sales - Sales Reports Page</a>
<a href="#">Report Sales - Sales Report (import) Page</a>	RE_IMPORT_SLS	Create sales reports by importing data from a CSV file.
<a href="#">Process Sales Reports Page</a>	RUN_RE_PCT_TRANS	Create percent rent transactions based on billing calendar.
Sales Reports to be Processed Page	RE_SLSRPT_LIST_SEC	View a list of the sales reports that will be processed.  <a href="#">Process Sales Reports Page</a>

## Understanding Sales Reporting and Percent Rent Calculation

When setting the percent rent terms in a lease, the sales reports form the basis that the system uses to calculate rent. After you set the percent rent terms and activate the lease, you begin working with the tenant sales reports to periodically generate the rent invoices.

You collate, enter, and revise all reported sales figures for the past period in the Report Sales - Sales Report Details page. This page enables you to enter estimated or actual figures, and the system calculates the appropriate rent amount, taking into consideration the percentage breakpoints and base rent setup. The system uses the percent and fixed amount selection and enters a fixed amount for every breakpoint row.

---

**Note:** You can select a billing calendar for a lease that suits your billing frequency. If the tenant reports sales in a different frequency than billing, you can select a billing calendar for a lease that suits your billing frequency.

---

The system populates the categories that are set up in the lease by default. You cannot add any additional rows for categories because they have to be set up on the lease to exist on the worksheet to provide validations.

You can isolate missing sales reports. For the missing reports, you can enter estimated information. Based on the sales estimation method and the adjustment factor that you selected while setting up the percent rent terms, you can estimate the sales.

After bringing the data from the estimation tools into the worksheet, the system enables you to adjust the calculated data. If the system is unable to generate an estimate, it displays a warning indicating the reason. Once you are satisfied with the estimate, you can click **Create Pending Invoice** in the worksheet and initiate the transfer to Billing or PeopleSoft Payables for further processing. The **Create Pending Invoice** button is visible only when the billing calendar and reporting calendars are same on the lease. If they are different, users need run the Process Sales Reports process to generate the bill. As in normal sales reporting, the system saves the estimates along with the date, time, and user ID to the database for historical purposes.

### Importing Sales Reports

You can populate the into the Report Sales - Sales Report Details page by importing the sales reports from a file. Before you can import sales reports, you must set up the URL path for attachments and configure the sales report file format.

Access the URL Maintenance page for the RE\_ATTACHMENTS identifier and enter the URL in the format *ftp://<username>:<password>@<machinename>/directory name*. The user name and password are critical, as the system uses these to connect all users to the FTP server. The <machinename> is the physical name by which the FTP server is identified on the network. You can include the directory name on the server where the sales report attachments are stored, or you can store the sales report attachments in the root directory of the FTP server. If you store the resume attachments anywhere but the root of the FTP server, you must append the directory name to the URL.

To populate the Report Sales - Sales Report Details page, the system uses data from the file along with lease data that already exists.

<b>Record Field</b>	<b>Field Description</b>	<b>Type</b>	<b>Length</b>	<b>Required</b>
BUSINESS_UNIT	Business Unit	Char	5	Y
LSE_NBR	Lease Number	Char	10	Y
FISCAL_YEAR	Sales Year	Nbr	4	Y
ACCOUNTING_PERIOD	Sales Period	Nbr	3	Y
CHG_GRP_CD	Category Code	Char	10	Y
SLS_AMT_TYPE	Sales Amount Type	Char	1	Y



<b>Record Field</b>	<b>Field Description</b>	<b>Type</b>	<b>Length</b>	<b>Required</b>
SLS_CURR_CD	Sales Currency Code	Char	3	Y
SLS_AMT	Sales Amount	Signed Nbr	23.3	Y

The system accepts only the translate values for the Sales Amount Type field. These are the valid values with their descriptions:

- 1: Reported
- 2: Estimated
- 3: Actual
- 4: Audited

The file layout uses the comma separated value (CSV) format and is mapped to the sales report file received. The file contains eight fields to map the sales report data received and rest of the information to create a sales report is retrieved from the corresponding lease.

This table contains sample data that the sales report file should contain. You cannot change the order of fields and the values must be separated by commas.

<b>Business Unit</b>	<b>Lease Number</b>	<b>Sales Year</b>	<b>Sales Period</b>	<b>Category Code</b>	<b>Sales Amount Type</b>	<b>Sales Currency</b>	<b>Sales Amount</b>
US001	US-NVV-03	2006	05	FOODSALE	3	USD	10000
US001	US-NVV-03	2006	05	SPORTS	3	USD	5023.75
US001	US-NVV-03	2006	05	ELECTRONIC	3	USD	15000
US001	US-NVV-03	2006	05	PHARMACY	3	USD	10000

## Effects of Lease Amendments on Sales Reporting

When you change a percent rent term setup because of a lease amendment, these changes are reflected during the update of a pending sales report. The changes result in an adjustment to the sales report. The recalculation is done automatically. The following occurs when you create a lease amendment:

- If you want to add a category, do so when updating a pending or adjusting sales report.
- If you delete a category, the category becomes display-only to prevent changes.

If the amendment is done for a sales revision, the amendment creates only a negative amount for the deleted category.

- The amendment to the minimum fee or maximum fee and sales adjustment factor impacts the total rent.

## Report Sales - Sales Reports Page

Use the Report Sales - Sales Reports page (RE\_SLSRPT\_SRCH) to search for all available sales reports.

Create a new sales report and import sales data.

Navigation:

**Lease Administration > Receivables Leases > Enter Receivables Lease Sales**

This example illustrates the fields and controls on the Report Sales - Sales Reports page. You can find definitions for the fields and controls later on this page.

**Report Sales**

**Sales Reports**

Enter any information you have and click Search. Leave fields blank for a list of all values.

**Search Criteria** ?

Search By:

\*Business Unit  US001 NEW YORK OPERATIONS

Lease Number

Calendar ID

\*  Payor

Date Range:

From Year  To Year

From Period  To Period

\* Required Field

**Report Sales**

**Search Results** Personalize | Find | View All | First 1-2 of 2 Last

From Date	To Date	Payor/Payee	Lease Number	Lease Name	Status
04/01/2004	04/30/2004	Easy Solutions	0000000050	Space 1018 - 56 Second Street	Processed
04/01/2006	04/30/2006	Florence Garden	0000000052	Space 1045 - 56 Second Street	Pending

Filter search results by entering specific values in the fields in the **Search Criteria** group box. You must enter the business unit. If you enter only a business unit, the search returns all sales reports for all leases within that business unit.

<b>Field or Control</b>	<b>Description</b>
<b>Calendar ID</b>	Displays the percent rent calendar ID from the lease that you enter in the <b>Lease Number</b> field. The calendar provides a set structure to the periods and facilitates the system's ability to search for missing sales reports. The calendar provides the start and end dates of each period so that the system can keep track of sales reports and assist with locating missing sales.

<b><i>Field or Control</i></b>	<b><i>Description</i></b>
<b>From Year</b>	Select the year to define the start of the date range for the search criteria.
<b>To Year</b>	Select the year to define the end of the date range for the search criteria.
<b>From Period</b>	Enter the starting period to be included in the search criteria. The periods match the dates created for this detail calendar.
<b>To Period</b>	Select the last period to be included the search criteria. The periods match the dates created for this detail calendar.
<b>Find Missing Sales Reports</b>	Click to access the Report Sales - Find Missing Sales Reports page on which you can enter criteria to search for missing sales reports.
<b>Create New Report</b>	Click to create a new sales report.
<b>Import Sales Report</b>	Click to import reported sales data reported from a CSV file.

## Report Sales - Find Missing Sales Reports Page

Use the Report Sales - Find Missing Sales Reports page (RE\_MISSING\_SLS) to find missing sales reports.

Navigation:

Click the **Find Missing Sales Reports** link on the Sales Reports page.

This example illustrates the fields and controls on the Report Sales - Find Missing Sales Reports page. You can find definitions for the fields and controls later on this page.

**Report Sales**

---

**Find Missing Sales Report**

Enter any information you have and click Search. Leave fields blank for a list of all values.

**Search Criteria**

Search By:

\*Business Unit  US001 NEW YORK OPERATIONS

Lease Number

Calendar ID

Payor

Date Range:

From Year  To Year

From Period  To Period

Include Estimated Sales

[Find Existing Sales Reports](#)

\* Required Field

**Missing Sales**

**Search Results** Personalize | Find | View 100 | First 1-100 of 1453 Last

**General** | **Sales Report** |

	Lease Number	Fiscal Year	Period	From Date	To Date	Last Report Date	Report Type
<input type="radio"/>	0000000095	2000	1	01/01/2000	01/31/2000		Missing
<input type="radio"/>	0000000093	2000	1	01/01/2000	01/31/2000		Missing
<input type="radio"/>	0000000031	2000	1	01/01/2000	01/31/2000		Missing

The system displays all of the missing sales reports based on the search criteria that you enter, regardless of lease status.

<b>Field or Control</b>	<b>Description</b>
<b>Include Estimated Sales</b>	Select to include estimated sales reports in the search results for missing sales reports. Normally, searching for missing sales reports only searches for periods that have no data; selecting this box handles any estimated sales reports as missing sales because the tenant did not provide the data.
<b>Find Existing Sales Reports</b>	Select to return to the Report Sales - Sales Reports page to search for existing sales reports.
<b>Generate Estimated Sales</b>	Click to generate a new estimated sales report for the selected lease. Estimates are based on the calculation method defined at the business unit level, such as <i>Past 6 Period Average</i> .
<b>Last Report Date</b>	Displays the last date entered for a sales report for this lease.

<b>Field or Control</b>	<b>Description</b>
<b>Report Type</b>	Displays the report type, either <i>Missing</i> or <i>Estimated</i> .

## Report Sales - Create New Sales Reports Page

Use the Report Sales - Create New Sales Reports page (RE\_SLSRPT\_INV ) to create new sales reports.

Navigation:

Click the **Create New Sales Reports** button on the Report Sales - Sales Reports page.

This example illustrates the fields and controls on the Report Sales – Create New Sales Report page. You can find definitions for the fields and controls later on this page.

Report Sales

**Create New Sales Report**

Sales Period: 10/01/2000 - 10/31/2000	Business Unit: US001	Report Status: Pending
Fiscal Year: 2000	Lease Number: 000000008	Currency Code: USD
Accounting Period: 10	Payee: Western Life and Annuity	Payee Location: HRMS
Ship To: US001	Billing Calendar: Monthly	Calculation Method: Cumulative Pro Rata
<input type="checkbox"/> Partial Year Proration		

---

Revision: 0

**Terms from Lease**

Minimum Fee: 1.00	Maximum Fee: 500,000.00	Estimate Method: Prior Period
-------------------	-------------------------	-------------------------------

Sales Categories	Type	Sales Amount	Sales Currency	Rate Detail	Converted Sales Amount	Currency	Bill Amount	Sales/Use Tax	Prorated Manual Adjustment
Toys	Reported	0.00	USD			USD		Sales/Use Tax	0.00

Current Total Sales: 0.00 USD

Current Total Bill: 0.00 USD

Final Manual Adjustment: 0.000 USD

Total Amount Due: 0.00 USD

---

**&Sales Report**

Created By	Last Updated By	Submitted By
Created On	Last Updated On	Submitted On

<b>Field or Control</b>	<b>Description</b>
<b>Sales Period</b>	Displays the date range for this sales report.
<b>Fiscal Year</b>	Displays the year to which this accounting period refers.
<b>Accounting Period</b>	Displays the accounting period for this sales report.
<b>Billing Calendar</b>	Displays the billing calendar for this sales report.
<b>Lease Number</b>	Click to access the Financial Terms - Percent Rent Details page on which you can view the breakpoints for this lease.
<b>Payee</b>	Displays the entity to whom you make payments. This field appears only for payables leases.

<b>Field or Control</b>	<b>Description</b>
<b>Payor</b>	Displays the entity that is responsible for making payments. This field appears only for receivables leases.
<b>Calculation Method</b>	Displays the calculation method selected on the Financial Terms – Percent Rent page.
<b>Partial Year Proration</b>	This option is selected if you selected partial year proration on the Financial Terms – Percent Rent page.
<b>Revision</b>	Displays the latest revision number. Shows the number of adjustments for this period.
<b>Type</b>	<p>Select the type of sales reporting figures being entered. You can change the type with an amendment if more accurate numbers are determined. The type enables you to classify the sales report by the values defined. The system delivers four values that you can use interchangeably. You can use any combination of these values:</p> <p><i>Estimated:</i> The estimated figure is either generated by the system or entered on behalf of tenant estimates. When the system generates a sales estimate, this value is automatically defaulted on the estimated row.</p> <p><i>Reported:</i> The figure is reported by tenant, but with possibly no documentation.</p> <p><i>Actual:</i> The tenant provides documentation of the actual figures.</p> <p><i>Audited:</i> The tenant provided an audited report or the landlord sent an auditor in to audit the figures.</p> <hr/> <p><b>Note:</b> If you change the type from <i>Estimated</i> to any of the other values, you cannot change it back to <i>Estimated</i>.</p>
<b>Sales Amount</b>	Enter the sales amount based on the type that you select for the <b>Type</b> field.
	Click the Exchange Rate Detail icon to access the View Exchange Rate Detail page on which you can view the details of the exchange rate that the system used to calculate the converted sales amount.
<b>Converted Sales Amount</b>	Displays the sales amount converted back to the base currency of the lease.
<b>Sales/Use Tax</b>	<p>Click this link to access the Sales/Use Tax Information page.</p> <p>For additional information on Sales/Use Tax Information page, refer <a href="#">Defining Lease Financial Terms</a></p>

<b>Field or Control</b>	<b>Description</b>
<b>VAT</b>	Click this link to access the VAT Information page. This field appears only for VAT enabled business units.  For additional information on VAT Information page, refer <a href="#">Defining Lease Financial Terms</a>
<b>Prorated Manual Adjustment</b>	Displays the final manual adjustment value prorated for each sales category lines.
<b>Calculate</b>	Click to calculate the bill amount based on the converted sales amount and the breakpoint using percent, amount, or both. You can enter different sales amounts to calculate and recalculate the billing amount until the calculated bill amounts are acceptable to you.
<b>Current Total Sales</b>	Displays the amount to be billed or the amount to be paid depending on the type of lease that you are using. The system calculates the amount from the percent rent terms.
<b>Current Total Bill</b>	Click this link to access the Sales Calculation Log page. <hr/> <b>Note:</b> This value appears as display only for the category based method and the lease prorata method. <hr/>
<b>Final Manual Adjustment</b>	Enter the amount for the final manual adjustments. You can edit the amount when the report status is in pending state and negative values are accepted.
<b>Create Pending Invoice</b> or <b>Create Pending Payment</b>	Click to calculate the rent and submit the bill amount to the transaction queue for approval. The system changes the status from <i>Pending</i> to <i>Processed</i> . If the transaction is rejected in the billing transaction queue, the status of the sales report changes from <i>Processed</i> back to <i>Pending</i> . This is available only when the reporting and billing calendars are same. When they are different, the invoice or payment is created using the Process Sales Reports process.

## Report Sales - Sales Report (import) Page

Use the Sales Reports - Sales Report (import) page (RE\_IMPORT\_SLS) to create sales reports by importing data from a CSV file.

Navigation:

Click the **Import Sales Report** button on the Report Sales - Sales Reports page.

This example illustrates the fields and controls on the Report Sales - Sales Report (import) page. You can find definitions for the fields and controls later on this page.

<b>Field or Control</b>	<b>Description</b>
<b>Attached File</b>	Displays the name of the file that you uploaded.
<b>Lookup File</b>	Browse through your files to locate the percent sales report and upload it to the FTP server.  See <a href="#">Defining an FTP Server for Document Attachments</a> .
<b>Auto Process Sales Reports</b>	Select this check box to enable the system to automatically calculate percent rent amounts and create transactions for the imported rows.
<b>Import Sales Report</b>	Click to import the values of the uploaded file into a sales report.

## Process Sales Reports Page

Use the Report Sales - Sales Report Details page (RE\_SLSRPT\_INV) to view processed sales reports or modify pending sales reports.

Navigation:

Click a date link on the Report Sales - Sales Report page.



This diagram displays the Process Sales Reports page.

<b>Field or Control</b>	<b>Description</b>
	Click to access the Sales Reports to be Processed page and view a list of reports that will be processed.
<b>Process Option</b>	<p><i>Billing Calendar:</i> Allows users to search and select billing schedules based on Billing calendar, Fiscal Year and Accounting period.</p> <p><i>Date Ranged:</i> Allows users to search and select billing schedules based on Billing Schedules Start Date and End Date.</p> <p><i>Lease Based:</i> Allows users to search and select billing schedules based on Business Unit or both Business Unit and Lease Number.</p>
<b>From Date</b>	This field appears if you select the <i>Date Ranged</i> process option.
<b>To Date</b>	This field appears if you select the <i>Date Ranged</i> process option.
<b>Lease Number</b>	This field appears if you select the <i>Lease Based</i> process option.
<b>Billing Calendar</b>	This field appears if you select the <i>Billing Calendar</i> process option.

<b>Field or Control</b>	<b>Description</b>
<b>Fiscal Year</b>	This field appears if you select the <i>Billing Calendar</i> process option.
<b>Accounting Period</b>	This field appears if you select the <i>Billing Calendar</i> process option.
<b>Load Billing Schedules</b>	Click to load the billing schedules into the grid, based on the processing option selected and entered values. All the Billing Schedules that are loaded into the Grid and which don't have any errors will be processed by the Application Engine.

The system completes the following actions for each billing schedule selected:

- Retrieves all sales reports for the lease, whose sales period end date falls between the billing schedule start date and billing schedule end date
- Updates the sales reports for any lease amendments.
- Calculate the bill amount based on the billing calendar. The consolidated bill amount will reflect on all the sales reports processed.
- Marks the sales report as *Processed* and the billing schedule as *Generated*.
- Updates the sales report submission details, submission date time and submission user ID.

Billing schedules in error will be ignored (not processed) by the application engine.

# Setting Up Security Deposits

## Understanding Security Deposits

During the life cycle of a lease, property damage that exceeds normal use may occur. Landlords collect a deposit from tenants to cover such damages. Such deposits are considered security deposits.

Security deposits form part of the general information of a lease. You can enter the security deposit information during the general lease entry process. Enter each deposit as a separate row in the grid.

You can define types of security deposits during the implementation of PeopleSoft Lease Administration. Security deposit types enable the system to track whether the security deposit is a charge (cash), guarantee, or prepaid. If the deposit type is a cash deposit, then the deposit amount can generate a bill or payment depending on whether the lease is of payables or receivables type. If the deposit type is a bank guarantee or letter of credit, no processing is done as no cash is collected. **Guarantor** is a required field for a bank guarantee type of deposit. If the deposit type is prepaid, no processing is done when it is established, as the security deposit transaction has already been taken care of ahead of time. During the refund process, however, the system treats a prepaid deposit as a cash deposit, and includes it in refund processing.

If you want to increase or decrease the security deposit or change the payee or payor while the lease is active, you must create an amendment. You should handle security deposit values adjustments in a transactional sense. To increase the security deposit, add another row with the incremental additional amount. To reduce the security deposit, add another row with the amount to be reduced as a negative value. If you change the payee or payor for the security deposit on an amendment, the system uses the new payee or payor to process the refund.

As the landlord, you can refund the security deposit to the tenant if the damages to be collected do not exceed the amount of the deposit and a cash deposit from the tenant is outstanding when a lease is terminated. During the refund process, you can also add interest to the deposit amount or deduct for additional damages.

<i>Date</i>	<i>Deposit Type</i>	<i>Guarantor</i>	<i>Amount (USD)</i>	<i>Status</i>
January 1, 2000	Cash		1000.00	Processed
March 1, 2000	Cash		(500.00)	Processed
May 1, 2000	Guarantee	Bank of America	5000.00	
May 15, 2000	Cash		250.00	Processed
May 29, 2000	Guarantee	Bank of America	(1000.00)	

<i>Date</i>	<i>Deposit Type</i>	<i>Guarantor</i>	<i>Amount (USD)</i>	<i>Status</i>
Total Cash Deposits	750.00			
Total Guarantee Deposits	4000.00			

---

## Setting Up Security Deposits

This topic discusses how to add security deposits to a lease and override accounting distributions.

### Pages Used to Set Up Security Deposits

<i>Page Name</i>	<i>Definition Name</i>	<i>Usage</i>
<u>Financial Terms - Security Deposit Page</u>	RE_DEPOSIT_SEC	Enter security deposit information.
<u>Accounting Distributions Page</u>	RE_LS_SEC_DST_SEC	Override the business unit accounting rules for the security deposit.

### Financial Terms - Security Deposit Page

Use the Financial Terms - Security Deposit page (RE\_DEPOSIT\_SEC) to enter the security deposit type, amount, and guarantor for the lease.

Navigation:

Click the **Security Deposit Details** link on the **Financial Terms** page.



<b>Field or Control</b>	<b>Description</b>
<b>Deposit Date</b>	Enter the date that the security deposit is added. The system provides the current date by default.
<b>Deposit Type Name</b>	<p>Enter the deposit type. The system processes the security deposit by the type selected. Values are:</p> <p><i>Cash Deposit:</i> Use to capture cash deposits. The deposit status is set to pending for cash deposits. Upon activation of the lease, the <b>Process Deposits</b> button becomes available for you to send the cash deposit to PeopleSoft Payables or Billing for processing.</p> <p>At lease expiration or termination, you can process any refunds for cash deposits that were received through the Refund Deposits page.</p> <p><i>Guarantee Deposit:</i> Use to capture information from a bank guarantee or a financial institution. Because no funds were actually transferred, bank guarantees are not included in security deposit refund processing. The deposit status is blank for guarantees because no funds are received.</p> <hr/> <p><b>Note:</b> If selected, you need to enter the name of the bank or financial institution providing the guarantee in the <b>Guarantor</b> field.</p> <hr/> <p><i>Manual Deposit:</i> Use to record any prepaid security deposits where processing is not required. In some cases, a security deposit is required prior to the ability to activate the lease in the system and generate a security deposit transaction. In those cases, it is possible that an accounts payable or accounts receivable department has already issued the security deposit outside of the PeopleSoft Lease Administration system; therefore, the deposit is prepaid.</p> <p>The system records the prepaid security deposits that are received against the lease but no financial processing takes place when the prepaid deposit is established or when security deposit refunds are processed (such as when the lease is expired or terminated). Prepaid deposits are treated as cash and are included in refund processing to be returned through the Refund Deposits page.</p>
<b>Guarantor</b>	Enter the name of the guarantor. This field is required if you select a deposit type of <i>Guarantee</i> . All external contacts that are set up on any lease are listed in the prompt for the <b>Guarantor</b> field.

<b>Field or Control</b>	<b>Description</b>
<b>Reference</b>	Use this field to enter check numbers and any additional information that relates to the security deposit.
<b>Status</b>	<p>Displays the processing status of the security deposit. Values are:</p> <p><i>Pending:</i> The deposit status is set to pending for cash deposits.</p> <p><i>Pending Process:</i> This temporary status is assigned after the deposit rows are processed and before the lease is saved. Once the lease is saved, all the pending rows are changed to processed.</p> <p><i>Processed:</i> This system displays this status after the security deposit is processed and the lease is saved.</p> <p><i>Refunded:</i> The system displays this status after a deposit row is refunded. The lease is expired through the Refund page.</p>
<b>Total Cash Deposits</b>	Displays the total cash deposits (including manual deposits and cash deposits). Any adjustments made through an amendment are reflected in this field. The security deposit refund process includes only cash or prepaid deposits that have been processed as eligible transactions for refund. The total cash deposits cannot be negative.
<b>Total Processed Deposits</b>	Displays the total deposits that have processed through the system. The security deposit refund process includes only cash or prepaid deposits that have been processed as eligible transactions for refund.
<b>Total Guarantee Deposits</b>	Displays the total guarantee from the bank or financial institution. The security deposit refund process ignores any guarantees.
<b>Process Security Deposit</b>	Click to send the deposit rows to the transaction queue. This button is visible only when the lease is in active or holdover status. For processing deposit rows for payables leases, all the rows in pending status are sent to PeopleSoft Payables and the deposit rows for receivables leases are sent to Billing. When a refund transaction is in pending status in the transaction queue, the system cannot process another security deposit.

## Accounting Distributions Page

Use the Accounting Distributions page (RE\_LS\_SEC\_DST\_SEC) to override the business unit accounting rules for the security deposit.

Navigation:

Click the **Accounting Distributions** link on the Security Deposit Details page.

This example illustrates the fields and controls on the Security Deposit - Accounting Distributions page. You can find definitions for the fields and controls later on this page.

Straightline Adjustment

Financial Terms 000000025 - 5000 Yellowstone Parkway

### Security Deposit - Accounting Distribution

This page is meant for overriding the default accounting rule setup at the Business Unit. If the financial term is supposed to follow the Business Unit default accounting rule, this page can be ignored.

Distribute By...

Percentage  
 Area  
 Amount  
 None Use default accounting distribution for Business Unit

Accounting Distribution

Debit/Credit	Percentage	GL Business Unit	Currency Code	Account	Alternate Account	Department	Operating Unit	Fund Code	Class Field	Program Code
Credit	100.00	US001	USD	214000						

The fields on this page differ depending upon the distribution selected. When you select a value other than None, the ChartField values become available for edit. All ChartFields are optional. If the ChartField values are not overridden, the values defaulted from the business unit setup will be retained.

<b>Field or Control</b>	<b>Description</b>
<b>Distribute By</b>	Select either: <ul style="list-style-type: none"> <li>• <b>Percentage:</b> Select this value to change the accounting distribution by percentage for each financial term.</li> <li>• <b>Area:</b> Select this value to change the accounting distribution by area for each financial term. The rent will be distributed based on the ratio of the areas.</li> <li>• <b>Amount:</b> Select this value to change the accounting distribution by amount for each financial term.</li> <li>• <b>None:</b> Select this option to use the accounting distribution set up at the business unit level.</li> </ul>
<b>Add Distribution</b>	This button appears if you select <b>Percentage</b> , <b>Area</b> or <b>Amount</b> for the distribute by value.  Click this button to insert a new distribution row.



<b>Field or Control</b>	<b>Description</b>
<b>Delete Distribution</b>	<p>This button appears if you select <b>Percentage, Area</b> or <b>Amount</b> for the distribute by value.</p> <p>Select a row and click this button to delete it from this page.</p>
<b>Select</b>	<p>This option appears if you select <b>Percentage, Area</b> or <b>Amount</b> for the distribute by value.</p> <p>This option is used to delete the distribution rows. Users can select all the distribution rows that they want to delete and click the <b>Delete Distribution</b> button to delete them.</p>
<b>Percentage</b>	<p>This field appears if you select <b>Percentage</b> for the distribute by value.</p> <p>Enter a percentage amount for this distribution line.</p> <p>Percentage amounts must equal 100% to be valid.</p>
<b>Area</b>	<p>This field appears if you select <b>Area</b> for the distribute by value.</p> <p>Enter the area for this distribution line.</p> <p>All lines must add up to the total rentable area for the lease to be valid.</p>
<b>Amount</b>	<p>This field appears if you select <b>Amount</b> for the distribute by value.</p> <p>Enter the amount for this distribution line.</p> <p>All lines must add up to the rent specified for the financial term.</p>
<b>Valid</b>	<p>Used to indicate a valid combination of chartfields. When activating the lease, edit checking will be provided and the option will be selected for each row representing a valid combination of chartfields. A lease cannot be activated until every accounting distribution is marked as valid.</p>

---

## Refunding Security Deposits

This topic provides an overview of security deposit refunds and discusses how to refund security deposits.

## Page Used to Refund Security Deposits

<i>Page Name</i>	<i>Definition Name</i>	<i>Usage</i>
<u>Refund Security Deposit - Final Security Deposit Refund Worksheet Page</u>	RE_REFUND	Process a security deposit refund.
<u>Accounting Distributions Page</u>	RE_LS_OPEX_CTG	Override the accounting distributions defined at the business unit level.

## Understanding Security Deposit Refunds

When a lease is expired or terminated and all outstanding payments are complete, any outstanding security deposits must be refunded or used to cover any damages that were incurred. The refund page collects all cash or prepaid processed deposits from the lease and includes them in the refund worksheet. You can add interest for the outstanding deposits or deduct for any damages. Once the final refund is calculated on the worksheet, you can process the refund back to the tenant. The refund can be negative or positive, meaning the tenant may owe the landlord additional funds or the landlord needs to refund the deposit back to the tenant. If the refund amount is positive, then the transaction is sent to PeopleSoft Payables. If the refund amount is negative, the system creates a billing transaction for additional funds to be billed to the tenant.

You can create refunds only for receivables leases. When a new refund worksheet is created, the prompt for the lease number displays only leases that are expired and deposits in a processed state. You cannot create a new refund worksheet when there is an existing pending worksheet for the lease; however, you can append an existing pending refund.

---

**Note:** You can create an amendment for partial or full refunds before the lease is expired by adding new deposit lines with negative amounts.

---



---

**Warning!** The receivables lease must be expired before you can process a security deposit refund.

---

## Refund Security Deposit - Final Security Deposit Refund Worksheet Page

Use the Refund Security Deposit - Final Security Deposit Refund Worksheet page (RE\_REFUND) to process a security deposit refund.

Navigation:

**Lease Administration > Receivables Leases > Refund Security Deposit**

This example illustrates the fields and controls on the Refund Security Deposit - Final Security Deposit Refund Worksheet page. You can find definitions for the fields and controls later on this page.

Refund Security Deposit

---

**Final Security Deposit Refund Worksheet**

Worksheet Number 1      \*Refund Date 03/06/2013      Refund Status Pending

Lease Number 0000000068      Payee Tekno-Sporto, Japan Ltd.

Lease Name Space 202121 - Tenjin Machi 604      Region Northeast Sales

Rentable Area 92.903

       [Accounting Distribution](#)

---

Refund Worksheet      Personalize | Find |      First 1 of 1 Last

Worksheet Item	Amount	Curr.	Description
Interest	0	JPY	

Total Deposits Processed	800,000	JPY	<a href="#">Security Deposit Details</a>
Total Deductions	0	JPY	<input type="button" value="Calculate"/>
Total Interest	0	JPY	
Amount to Refund	800,000	JPY	<input type="button" value="Process Refund"/>

---

Refund Worksheet

Created By	Last Updated By	Processed By:
Created On	Last Updated On	Submitted On

<b>Field or Control</b>	<b>Description</b>
<b>Refund Date</b>	Enter the date on which you want the system to process the refund. The system uses the current date by default, but you can change this value to any future date.
<b>Payee</b>	Displays the payee. If the amount to refund is positive, the payee is the entity to whom the system refunds the security deposit. If the amount to refund is negative, the payee is the entity who is responsible to pay the amount.
<b>Add Interest</b>	Click to insert an additional worksheet item for adding interest that was accrued for the security deposit. The system does not calculate interest for security deposits for a lease; therefore, you must track the interest manually. You can code interest to a different transaction routing code, which enables flexibility for a distinct general ledger account.
<b>Add Deduction</b>	Click to add deductions for damages to the property or any final charges to be paid by the tenant. You can code deductions to a different transaction routing code, which enables flexibility for a distinct general ledger account.

### Refund Worksheet

When you click the **Add Interest** or **Add Deduction** button, the system inserts a new row in the refund worksheet.

<b>Field or Control</b>	<b>Description</b>
<b>Worksheet Item</b>	Displays <i>Interest</i> or <i>Deductions</i> , depending on whether you select the <b>Add Interest</b> or <b>Add Deduction</b> option.
<b>Total Deposits Processed</b>	Displays the total deposits that were processed from the Security Deposits page. The system totals all of the processed deposit amounts to calculate this value. When the refund worksheet is in a processed state, the system retains the value in the worksheet and does not recalculate it.
<b>Total Deductions</b>	Displays the total deductions that were added to the refund worksheet.
<b>Total Interest</b>	Displays the total interest that was added to the refund worksheet.
<b>Amount to Refund</b>	Displays the amount to refund or collect. The system calculates the final refund on a worksheet that is processed back to the payee. The refund can be negative or positive, which means that the tenant might owe the landlord additional funds or the landlord might refund the deposit back to the tenant. If the refund amount is positive, then the system sends the transaction to PeopleSoft Payables. If the refund amount is negative, the system creates a billing transaction to bill additional funds to the tenant.
<b>Security Deposit Details</b>	Click the link to view the security deposit log on the Security Deposits page.
<b>Calculate</b>	<p>Click to calculate the amount of security deposit refund. Because the security deposit refund page uses a worksheet model for processing, you can click the <b>Calculate</b> button as many times as needed to create what-if scenarios. The system calculates the amount to be refunded as (Total Deposits Processed + Total Interest – Total Deductions).</p> <hr/> <p><b>Note:</b> Calculation is automatically performed when the worksheet is saved.</p> <hr/>

<b>Field or Control</b>	<b>Description</b>
<b>Process Refund</b>	<p>Click to send the refund request to the transaction queue for PeopleSoft Payables processing. If the deductions are greater than the security deposit amount, the system sends a request to the transaction queue for PeopleSoft Billing to send an invoice to the tenant for additional fees. The details are sent to PeopleSoft Billing even if the refund amount is zero.</p> <p>After a refund worksheet is processed, the refund status is changed to <i>Processed</i> and the worksheet becomes read-only. When there is a pending refund transaction in the transaction queue, another refund cannot be processed.</p>

## Accounting Distributions Page

Use the Accounting Distributions page (RE\_LS\_OPEX\_CTG ) to override the accounting distributions defined at the business unit level.

Navigation:

Click the **Accounting Distributions** link on the Refund Security Deposit - Final Security Deposit Refund Worksheet page.

The fields on this page differ depending upon the distribution selected. When you select a value other than **None**, the ChartField values become available for edit.

<b>Field or Control</b>	<b>Description</b>
<b>Distribute By</b>	<p>Select either:</p> <ul style="list-style-type: none"> <li>• <b>Percentage:</b> Select this value to change the accounting distribution by percentage for each financial term.</li> <li>• <b>Area:</b> Select this value to change the accounting distribution by area for each financial term. The rent will be distributed based on the ratio of the areas.</li> <li>• <b>Amount:</b> Select this value to change the accounting distribution by amount for each financial term.</li> <li>• <b>None:</b> Select this option to use the accounting distribution set up at the business unit level.</li> </ul>
<b>Add Distribution</b>	<p>This button appears if you select <b>Percentage</b>, <b>Area</b> or <b>Amount</b> for the distribute by value.</p> <p>Click this button to insert a new distribution row.</p>

<b>Field or Control</b>	<b>Description</b>
<b>Delete Distribution</b>	<p>This button appears if you select <b>Percentage, Area</b> or <b>Amount</b> for the distribute by value.</p> <p>Select a row and click this button to delete it from this page.</p>
<b>Select</b>	<p>This option appears if you select <b>Percentage, Area</b> or <b>Amount</b> for the distribute by value.</p> <p>This option is used to delete the distribution rows. Users can select all the distribution rows that they want to delete and click the <b>Delete Distribution</b> button to delete them.</p>
<b>Percentage</b>	<p>This field appears if you select <b>Percentage</b> for the distribute by value.</p> <p>Enter a percentage amount for this distribution line.</p> <p>Percentage amounts must equal 100% to be valid.</p>
<b>Area</b>	<p>This field appears if you select <b>Area</b> for the distribute by value.</p> <p>Enter the area for this distribution line.</p> <p>All lines must add up to the total rentable area for the lease to be valid.</p>
<b>Amount</b>	<p>This field appears if you select <b>Amount</b> for the distribute by value.</p> <p>Enter the amount for this distribution line.</p> <p>All lines must add up to the rent specified for the financial term.</p>
<b>Valid</b>	<p>Used to indicate a valid combination of ChartFields. When activating the lease, edit checking will be provided and the option will be selected for each row representing a valid combination of ChartFields. A lease cannot be activated until every accounting distribution is marked as valid.</p>

# Setting Up Options and Critical Dates

---

## Understanding Options and Critical Dates

There are a variety of milestones and events that can occur throughout the life cycle of a lease. Usually, these events are in response to a clause or option that is written into the lease. Lease related events often require one or more persons to carry out a task that is related to the execution of the lease, usually on or before a critical date. The PeopleSoft Lease Administration system provides a number of features that enable you to manage these events and inform interested parties of the due dates of these events. The key concepts that the system uses to track lease related events include:

- Options

An option represents a real estate related event, option or milestone. You can define a common set of options as part of your setup data. When a site acquisition request (SAR) or lease is created or updated you can assign one or more of the predefined options to the SAR or lease. You can then define the notification recipients and the frequency of the notifications prior to the option date.

- Critical date

When you associate an option to a SAR or lease you also need to define the date the option expires. This date is typically referred to as the critical date. Once this date has passed, the option is no longer exercisable. To avoid missing the critical date, you can use the option date to define a start date, an end date and optionally, any number of intermediate dates for notifications to the users. As each date occurs, a notification is sent to the various contacts informing them of the pending option.

For example, if you have a lease with an early termination option that expires on December 31, 2010 and you want to be notified prior to the expiration of that option, you can define a critical date that begins on September 1, 2010 and ends on December 31, 2010. You can also define intermediate notifications such as every two weeks between the dates defined. A notification is sent to the contact every two weeks between these dates advising the contacts that the Early Termination option expires on December 31st.

- Critical date template

Critical date templates enable you to apply similar sets of options and the associated critical dates. PeopleSoft Lease Administration provides a facility that enables you to generate one or more options and critical dates and organize them into a template. You can apply the template to a new or existing SAR or lease, and each option and critical date within the template is copied into the SAR or lease. Critical date templates are reusable; that is, when a template is applied to a SAR or lease, you can modify the options and critical dates on the SAR or lease without affecting the original template.

- My Critical Dates

The potential number of critical dates generated by a portfolio can be extremely high. The PeopleSoft Lease Administration application provides a task list, enabling each system user to track their own critical dates. When a critical date notification is sent to users, the system records the assignment

in the **My Critical Dates** page. Notification recipients who are external to the system, such as: landlords, tenants and supplemental contacts, receive outbound email notification only.

<b>Activity</b>	<b>Description</b>
Option Setup & Maintenance	Creates, updates, and deletes options. The options define the set of possible milestones that can be tracked on a SAR or lease within each business unit. Each option defines a notification template to construct the notification messages that are sent to recipients
Critical Date Template Management	Creates, updates and deletes critical date templates. The template provides a default set of options that can be applied to any SAR or lease. Templates can also be preconcerted with a default notification schedule and list of the roles that need to be notified. You can define any number of templates.
Option Assignment	<p>Assigns options to a SAR or lease using either a template or a specific option to define or edit the critical date for each option that you add. When you assign a single option to a SAR or lease, you must also configure the critical date (including the notification schedule and recipient list) manually.</p> <p>When a template is applied to a SAR or lease, the critical dates are automatically set up according to the values that are preconcerted in the template. Templates can be cumulatively assigned to a particular SAR or lease.</p>
Critical Date Notification	Generates notifications to recipients in response to the schedule defined for each critical date.
Critical Date Task List Management	For those recipients who are internal to the system, describes the actions that are available to manage the list of critical dates to which they are assigned.

**Note:** A previously completed critical date can be re-activated if the critical date is updated and the action date is extended. To inactivate a critical date, deselect the **Enable Notifications** check box.

## Prerequisites

Before setting up critical dates for a lease, you must first set up the following:

- Role types and lease administration roles.
- Option definitions.
- Critical date templates

See [Defining Lease Administration Options](#), [Defining Critical Date Templates](#), [Defining Role Types](#), [Defining Lease Administration Roles](#).



## Setting Up Options and Critical Dates

This topic discusses how to define options and critical dates.

### Pages Used to Set Up Options and Critical Dates

<b>Page Name</b>	<b>Definition Name</b>	<b>Usage</b>
<u>Options and Critical Dates Page</u>	RE_LS_OPTIONS	Displays the list of options and critical dates associated with a lease.
<u>Critical Date Detail Page</u>	RE_CRDT_DTL	View or edit the details of the critical date associated with the lease option. Use this page to both edit and view a critical date in a number of different modes. When viewing an option from a template, different fields are visible when viewing or editing the detail that is attached to a lease.
Options and Critical Dates - E-mail Message Page	RE_LS_OPT_EMAIL	Displays the text that should accompany the email notification.  <u>Critical Date Detail Page</u>
Options and Critical Dates - Apply Critical Date Template Page	RE_TMPLT_SEL	View the list of available Templates. Enables users to select one or more Templates for inclusion on a Lease.  <u>Options and Critical Dates Page</u>
Define Critical Date Template Page	RE_TMPLT_DTL	Displays list of options contained in the critical date template.  <u>Options and Critical Dates Page</u>
<u>Generate Critical Date Notifications Page</u>	RE_CDNT_GEN	Run the process to generate critical date notifications to recipients. You can specify an as of date parameter for generating the notifications.
<u>Critical Date Inquiry Page</u>	RE_CRTICDT_INQ	Inquire on critical dates associated with a lease administrator or all lease administrators. You can view critical dates by business unit, lease number, lease option, date range or by lease administrators. If you do not specify the criteria, the system displays all critical dates within that business unit.

## Options and Critical Dates Page

Use the Options and Critical Dates page (RE\_LS\_OPTIONS) to displays the list of options and critical dates associated with a lease.

Navigation:

**Lease Administration > Payables Leases > Create New Payables Lease > Options and Critical Dates**

This example illustrates the fields and controls on the Options and Critical Dates Page. You can find definitions for the fields and controls later on this page.

<b>Field or Control</b>	<b>Description</b>
<b>Add Option</b>	Click to add new lease options and define critical date details.  <b>Note:</b> Add Option is available only in Pending Lease and in Amendment.
<b>Apply Template</b>	Click to select one or more templates to apply to the lease. When you select and apply a critical date template, the critical dates that are contained in the selected template are assigned to the lease. The existing assigned critical dates are not overwritten.

### Lease Options

The lease options grid displays existing options and critical dates that you have established at the business unit level or added to this lease.

<b>Field or Control</b>	<b>Description</b>
<b>Option Date</b>	Displays the date that this option expires. This date is critical when a decision needs to be made or an action needs to be taken for that option. For example, you can set up a lease option for availability of additional space and you have the first right to that space. Setting up the option with the critical date reminds you that an action needs to take place on or before the specified date.
<b>Option Type</b>	Displays the type based on the option selected on the Options and SAR configuration page.
 <b>Critical Date</b>	Click the <b>Critical Date</b> icon to access the Options and Critical Dates - Critical Date Detail page on which you can view or edit the details of the critical date and specify the notification schedule and recipient list.
<b>Option Status</b>	Displays the status of the option. The values are:  <i>Inactive:</i> The critical date schedule for the option is inactive; no notification will be sent.  <i>Active:</i> Critical date notifications are processed when you run the critical date notification process. The lease options becomes active after you enable notifications on the Options and Critical Dates - Critical Date Detail page.  <i>Expired:</i> The option date is passed, notifications will not be sent.
<b>Enabled</b>	Indicates whether the schedule that is defined by the critical date has been enabled. The system enables the option after it validates the schedule and recipient details. The system sends notifications only for active critical dates that are enabled and have one or more recipients with valid email addresses.

**Note:** If the lease status is *Cancelled* or *Closed*, this page is display-only. For any other lease status value, the system displays the page in update or edit mode.

## Critical Date Detail Page

Use the Critical Date Detail page (RE\_SAR\_CRDT\_DTL) to enter schedule details and recipient information for critical date notifications.

Navigation:

**Lease Administration > Site Acquisition > Site Acquisition Request(s) > Options and Critical Dates**

Click the **Critical Date** icon on the Options and Critical Dates page.

This example illustrates the fields and controls on the Options and Critical Dates - Critical Date Detail page. You can find definitions for the fields and controls later on this page.

Critical Date Detail

---

Options and Critical Dates 0000000044 - Space 1016 - 56 Second Street

---

**Critical Date Detail**

Option Name

Option Date

Message Text  Email text

---

**Schedule Details**

Enable Notifications

Send initial notification...

prior to Option Date

On the Lease Start Date

On a Specific Date

Recurring

---

**Recipients**

Personalize | Find | First 1 of 1 Last

Role	Email notify	Tasklist	Name Display
<input type="text"/>	<input type="checkbox"/>	<input type="checkbox"/>	

---

Critical Date

Created By Last Updated By

Created On Last Updated On

Click the **Add Options** button.

<b>Field or Control</b>	<b>Description</b>
<b>Option Name</b>	Select the option for which you want to establish for a critical date. This is a required field.
<b>Option Date</b>	Enter the date that this option occurs or expires. The date that you enter must occur on or after the current date and cannot occur before the lease commencement date. This is a required field.

<i>Field or Control</i>	<i>Description</i>
<b>Message Text</b>	<p>Enter the text to insert into the email notification that is defined in the Lease Option Setup page.</p> <hr/> <p><b>Note:</b> You must include the %MSG% tag in the mail template of the option in order to have this text appear in the generated email.</p> <hr/>
<b>Email Text</b>	<p>Click to display a sample of the email content that is generated and sent to recipients. You cannot edit the email text from this view. The email text is specified when you define the lease option during setup. You may, however, tailor the <b>Message Text</b> field to customize the message for this specific lease.</p>

## Schedule Details

<i>Field or Control</i>	<i>Description</i>
<b>Enable Notifications</b>	Select to enable email notifications.
<b>Send initial notification</b>	<p>Select the option for sending initial notifications. Critical date notifications operate within a date range. The options in this group determine the timing of the start date. Options include:</p> <p><b>Prior to Option Date:</b> Use this option to begin notifications on a specific number of days, months or years before the option date.</p> <p><b>On the Lease Start Date:</b> Use this option to begin sending notifications from the lease <b>Commencement Date</b> field that is specified in the General Information page for lease maintenance.</p> <p><b>On a Specific Date:</b> Use this option to begin sending notifications on a specific date. The date that you select must be prior to the option date.</p>

## Recurring – Send Recurring Notifications

<i>Field or Control</i>	<i>Description</i>
<b>Never</b>	Use this option if the notification is not recurring. For example, only one notification is sent on the date that is specified by selecting <b>Send Initial Notification</b> .

<b>Field or Control</b>	<b>Description</b>
<b>Daily</b>	Select this option to generate notifications on a daily interval. For example, setting the number value to one generates a notification every day from the initial notification until the option date occurs.
<b>Weekly</b>	Select this option to generate notifications on weekly basis or on regular intervals on specific days of the week interval. For example, specify a value of two and select <i>Mon</i> and <i>Wed</i> . The system generates notifications on Mondays and Wednesdays, every other week, between the start date and the option date.
<b>Monthly</b>	Select this option to generate notifications every month on a specific day of the month. For example, you can generate a notification every three months on the 31st day of the month between the start date and the option date. If you select the 29th, 30th or 31st and the notification date occurs within a month that has less days, the notification is sent on the last day of the month.
<b>Yearly</b>	Select this option to generate notifications annually on a specific day within a specific month. For example, you can generate notifications every two years on June 30.

## Recipients

This section enables you to specify the interested parties to whom critical date notifications are sent. The recipient list is role based. Notifications are only sent when a specific person is assigned to that role within the context of the lease.

You use the **Contacts** section of the lease to specify the roles and specific users who are assigned to those roles. You can select a role to which no one is currently assigned; however, no notification is actually sent. Conversely, if someone is assigned to that role and they are removed from the contact list, the system displays the role as the recipient, however, the person who is assigned to the role no longer exists and no notification is generated. If the role category is defined as an *Internal Manager* and assigned to any critical date, then notifications are always sent to the Portfolio Manager. If the role category is defined as an *Internal Admin* and assigned to any critical dates, then notifications are always sent to the lease administrator.

See [Understanding Lease Administration Contacts](#).

<b>Field or Control</b>	<b>Description</b>
<b>Role Name</b>	Select the role for whom you want to receive notifications. You can select from any of the predefined Lease Administration roles. If no one is assigned to this role, then the <b>Name</b> field is blank.
<b>Email Notify</b>	Indicates that email notifications are sent to the role(s) that are defined.  <b>Note:</b> This field does not show whether the recipient's email address has been correctly configured. The system assumes that all email recipients are able to receive mail.

## Generate Critical Date Notifications Page

Use the Generate Critical Date Notifications page (RE\_CDNT\_GEN) to run the process to generate critical date notifications to recipients.

You can specify an as of date parameter for generating the notifications.

Navigation:

**Lease Administration > Integrations > Run Critical Date Notification > Generate Critical Date Notifications**

The Notification process will send notifications based on the critical date set up and will create an entry in the My Critical Dates component. If you plan to use critical dates, you should set this process to run on a recurring basis.

If you enter a date in the As Of Date field, all notifications that have not been sent as of that date will be sent. If you do not enter a date in this field, the current date will be used.

Once the option date has passed, the status will be changed to *Expired* and notifications will not be sent again.

---

**Note:** The notification feature does not use PeopleTools Workflow.

---

## Critical Date Inquiry Page

Use the Critical Date Inquiry page (RE\_CRITICDT\_INQ) to inquire on critical dates associated with a lease administrator or all lease administrators.

You can view critical dates by business unit, lease number, lease option, date range or by lease administrators. If you do not specify the criteria, the system displays all critical dates within that business unit.

Navigation:

**Lease Administration > Reports > Critical Date Inquiry**

The Critical Dates Inquiry page provides a view of critical dates that are about to occur for a lease administrator or all lease administrators. You can search the critical dates by defining the appropriate search criteria in the page.

---

## Managing Your Critical Dates

This topic provides an overview of the My Critical Dates page and discusses how to manage your critical dates.

### Pages Used to Manage Your Critical Dates

<i>Page Name</i>	<i>Definition Name</i>	<i>Usage</i>
<u>My Critical Dates Page</u>	RE_OPT_RECIP	Use to manage lease options with critical dates.

### Understanding the My Critical Dates Page

The My Critical Dates page enables you to view the critical dates that apply specifically to you. You can search for the critical dates by providing the appropriate search criteria in the page. For example, as Portfolio Manager, you might want to see the critical dates for lease termination within the next six months. By entering the date parameter and the lease option, the system generates the list. You can click the lease link to view the lease for further action. When you complete your task you can mark your critical dates as complete.

The system does not send further notifications on critical date when:

- All recipients are internal and every recipient has marked the critical date as task completed.
- There are both internal and external recipients and the action date of the critical date passes.
- The critical date task is explicitly set to *Complete* and the parent lease is closed.

### My Critical Dates Page

Use the My Critical Dates page (RE\_OPT\_RECIP) to use to manage lease options with critical dates.

Navigation:

**Lease Administration > My Critical Dates**



This example illustrates the fields and controls on the My Critical Dates page . You can find definitions for the fields and controls later on this page.

**My Critical Dates**

Name Kenneth Schumacher

**Search Criteria**

Date From  To

Lease Number

Lease Option

Critical Date Status   Show Completed Tasks

**Search Results** Personalize | Find |  First 1-52 of 52 Last

Task Complete	Option Date	Option Name	Lease Name	Critical Date Status	Date Completed	Role	Message Text
<input type="checkbox"/>	10/13/2010	1st Renewal Option	440 Wadsworth Blvd	Active		SVP Real Estate	1st Renewal Option
<input type="checkbox"/>	10/14/2020	2nd Renewal Option	440 Wadsworth Blvd	Active		SVP Real Estate	2nd Renewal Option
<input type="checkbox"/>	10/14/2030	3rd Renewal Option	440 Wadsworth Blvd	Active		SVP Real Estate	3rd Renewal Option
<input type="checkbox"/>	10/15/2000	Right of First Refusal	440 Wadsworth Blvd	Inactive		SVP Real Estate	Tenant has right of first refusal of purchase for \$3,050,000
<input type="checkbox"/>	06/15/2016	1st Renewal Option	7800 East Smith Road	Active		Portfolio Manager	1st Renewal Option
<input type="checkbox"/>	06/28/2026	2nd Renewal Option	7800 East Smith Road	Active		SVP Real Estate	2nd Renewal Option
<input type="checkbox"/>	06/28/2036	3rd Renewal Option	7800 East Smith Road	Active		SVP Real Estate	3rd Renewal Option

<b>Field or Control</b>	<b>Description</b>
<b>Show Completed Tasks</b>	Select to view completed tasks only.
<b>Task Completed</b>	Select when you have completed the task.
<b>Date Completed</b>	Displays the date on which you completed the task.



# Defining Contacts for Lease Administration

---

## Understanding Lease Administration Contacts

In PeopleSoft Lease Administration you can define multiple contacts for a lease or site. Contacts can be defined for various entities such as tenants, landlords, portfolio managers, lease administrators, guarantors, and service providers. Contacts provide you a quick way to look up phone numbers, email addresses, and physical addresses of the people with whom you normally interact for this lease or site. Additionally, you can assign roles to the contacts for critical date processing such as email reminders of when a lease is up for renewal or a site is created. When setting up your contacts, you need to understand how contacts are used and how PeopleSoft Lease Administration shares the contacts with other applications in the PeopleSoft system.

There are three types of contacts in the PeopleSoft Lease Administration system: principal, property site and supplemental. The key differentiation is that you need to enter the data for supplemental contacts, whereas the principal contact information is obtained from the supplier or customer table and site contacts can be added from the address book.

### Principal (Supplier or Customer) Contacts

A tenant on a lease is defined as a customer and the landlord is defined as a supplier in the PeopleSoft system. Customers or suppliers can have associated contact information that needs to be setup in the customer and supplier tables, respectively. These contacts are known as *principal contacts* within the PeopleSoft Lease Administration system. When you create a lease, you must define a tenant (customer) for a receivables lease to perform billing transactions, and a landlord (supplier) for payables leases to process payment transactions. You can also specify an alternate payor or payee for a lease. These tenants, landlords, payees, and payors must be established in the system before you can select them for use on a lease. You cannot activate a lease without this information.

When setting up a supplier, you can create supplier profiles to store all the information such as name, address, payment terms, as well as voucher processing defaults. Supplier information is principally shared by PeopleSoft Payables and Purchasing, so that one or both departments can enter supplier information. You may want to set up your system so that a lease administrator or portfolio manager can enter supplier information, but only PeopleSoft Payables users can approve suppliers for payment, or vice versa.

To create or update supplier profiles for all types of suppliers in either product, you use the pages in the Supplier Information component. The applications are organized to help you easily enter, update, and inquire about the supplier.

All supplier information for regular suppliers, one-time suppliers, and permanent suppliers is stored in the same set of supplier tables. So if you decide that the contractor that you used last week on a trial basis is the ideal company to use for a long term remodeling project, you can update the **Persistence** field on the Identifying Information page, without reentering information or storing redundant data.

---

**Warning!** A supplier must be set up and approved before you can assign them to a lease.

---

Before you set up a customer, you must first understand the customer roles to determine the functional use of the customer ID. Customer information is associated with specific customer roles. You can use the customer General Information component to maintain information that applies to multiple customer roles and to select those roles. You can use the pages with role designations to enter processing attributes and additional information that are unique to the customer's function.

Bill to customers receive invoices, therefore a tenant is considered a bill to customer. When you associate a customer with the bill to customer role, you establish default values and processing options that the system uses to generate invoices. For example, you can define attributes to generate consolidated invoices, require purchase order numbers, or bill freight charges at order entry or at shipment for each of bill to customer.

---

**Warning!** To send invoices to tenants, you must confirm the tenant is set up as a customer and that the **Bill-To** check box is selected.

---

Both the supplier and customer entry pages have facilities to enable entry of contacts, such as individuals who are associated to those suppliers or customers by some role that they serve in those organizations. For example, supplier contacts can include account executives, billing clerks, and collections agents. Customers contacts can include AP clerks and sales contacts. Since PeopleSoft Lease Administration shares the supplier and customer tables with other PeopleSoft applications, several contacts may already be set up for these suppliers and customers, which is inherited for display on the lease if that supplier or customer is chosen.

---

**Note:** Contacts from the supplier or customer tables cannot be updated in the lease, they must be updated on the supplier or customer common component pages. Supplemental contacts are changed on the lease directly, which is why those fields are open and not display-only.

---

See “Understanding Supplier Maintenance” (PeopleSoft Source to Settle Common Information)

## Supplemental Agreement Contacts

Supplemental agreement contacts enable you to add additional contacts specific to the lease. Although the supplier and customer tables have multiple contacts, these contacts may not be necessarily related to PeopleSoft Lease Administration. By adding the contacts directly to the supplier and customer tables, every application that shares the supplier or customer tables automatically displays those contacts. For example, the PeopleSoft Inventory application uses the supplier table for purposes related to inventory processing.

Your organization can decide to add the PeopleSoft Lease Administration-specific contacts directly to the lease by using supplemental agreement contacts. The supplemental agreement contacts can be used as a quick reference to important contacts that are not already set up. You do not set up supplemental agreement contacts prior to creating a lease or setting up a site. Supplemental contacts are used only for the lease or site for which they are created. If you want to use the same contact on another lease or site, you need to add the supplemental contacts manually onto the other lease or add them as a contact in the address book for sites. The only exception is when you define a guarantor for a security deposit payment. In this case, the supplemental contact that you define on any lease can be used as a guarantor.

You can add, modify or delete supplemental contacts. At a minimum, you must enter the name of the contact. All other fields are optional. You can only delete one of these contacts, if the contact is not referenced either as a guarantor on a security deposit (for any lease) or on a critical date for this lease.

## Site and SAR Contacts

A primary contact can be designated for a site. Information entered in the address book will automatically be displayed on the site when selected. Also, supplemental contacts can be entered manually on the site.

With the contacts address book, users can maintain a list of users and simply select from the list. Once the data for each contact is entered, they can be accessed by the user via a search box on the Site Contacts page. When selecting contacts from the address book, the user will have the option to select from their address book, or from a pre-existing supplier or customer. If a supplier or customer is chosen, the contacts attached to that supplier or customer will automatically be displayed in the Site Contacts list

---

## Prerequisites

Before you select a tenant, landlord, payor or payee for a lease, you must first set up the tenant and payor as customers and the landlord and payee as suppliers in the system.

See “Understanding Supplier Maintenance” (PeopleSoft Source to Settle Common Information)

---

## Establishing Contacts for Sites and SARs

This topic discusses how to establish contacts for sites and SARs.

### Pages Used to Set Up Contacts Repository

<i>Page Name</i>	<i>Definition Name</i>	<i>Usage</i>
<u>General Information Page</u>	RE_CONTACT	Enter general information about contacts for use when defining sites.
Contact Phone	RE_CONTACT_PHONE	Enter phone information for the contact.
Address	RE_CONTACT_ADDR	Enter address information for the contact.

### General Information Page

Use the General Information page (RE\_CONTACT) to enter general information about contacts for use when defining sites.

Navigation:

**Set Up Financials/Supply Chain > Product Related > Lease Administration > Site Acquisition > LA Contacts > General Information**

This example illustrates the fields and controls on the General Information page. You can find definitions for the fields and controls later on this page.

The screenshot shows a web form titled 'General Information' for a contact. At the top, there are tabs for 'General Information', 'Contact Phone', and 'Address'. Below the tabs, the 'SetID' is 'SHARE' and the 'Contact ID' is '000000000000001'. The 'Contact Information' section contains the following fields:
 

- \*Name: Wilson, Kevin
- Company: ABC PROPERTY MANAGEMENT
- Title: Property Manager
- Email ID: kw@abcpm.com
- Salutation Code: (empty)
- \*Preferred Communication: Email only
- Language Code: English
- \*Contact Flag: External Contact (dropdown menu)

 Below this is a 'Contact Comments' section with a 'Comment' text area.

Enter general information for the contact. You must select a contact flag value and a preferred communication method. Information entered in this component will be copied onto the site when the contact is selected.

## Establishing Contacts for a Lease

This topic discusses how to establish contacts for a lease.

### Pages Used to Set Up Supplemental Contacts

<b>Page Name</b>	<b>Definition Name</b>	<b>Usage</b>
<a href="#">Contacts Page</a>	RE_LS_CONTACTS	Assign role names to the principal contacts and track supplemental agreement contacts for the lease.
Lease Contact Address Page	RE_LS_CNT_ADDR_SEC	Displays the principal contact address. <a href="#">Contacts Page</a>
External Contact Address Page	RE_LS_EXT_ADD_SEC	Add supplemental agreement contact's address. <a href="#">Contacts Page</a>

### Contacts Page

Use the Contacts page (RE\_LS\_CONTACTS) to assign role names to the principal contacts and track supplemental agreement contacts for the lease.

You can add supplemental contacts on this page.

Navigation:

- **Lease Administration > Payables Leases > Create New Payables Lease > Contacts**
- **Lease Administration > Payables Leases > Maintain Lease > Contacts**
- **Lease Administration > Receivables Leases > Create New Receivables Lease > Contacts**
- **Lease Administration > Receivables Leases > Maintain Lease > Contacts**

This example illustrates the fields and controls on the Contacts page. You can find definitions for the fields and controls later on this page.

## Customer or Supplier Contact

The contact information varies depending on the type of lease you are creating. The system populates the **Customer Contacts** information from the Contacts page on the supplier and customer setup table.

<b>Field or Control</b>	<b>Description</b>
<b>Role Name</b>	Select the role name for your contact. The roles are related to critical dates. By defining roles ahead of time and assigning them to the contacts on the lease, you can later define in critical dates which roles receive notifications. If the roles exist as a lease contacts then a notification is sent to that role.
<b>Address</b>	Click the link to display the contact address. This address is stored on the supplier or customer table.

## Supplemental Agreement Contacts

<b>Field or Control</b>	<b>Description</b>
<b>Name</b>	Enter the contact name. The format for this field is: last name, first name with no space between the names.
<b>Preferred Communication</b>	Select the preferred method of communication. Values are: <i>Call, Email Only, Email, Prt, Fax, Mail, XML Only, and XML, Prt.</i>
<b>Address</b>	Click the link to add the address for the supplemental contact.



# Processing Invoices for Receivables Leases

---

## Understanding Invoices for Receivables Leases

PeopleSoft Lease Administration provides corporate real estate managers a facility to manage the leasing and subleasing life cycles. During the lease life cycle, the system generates various billable items. You must submit these items to the tenant or payor on an invoice. These billable items can include base rent, operating expenses, miscellaneous rent, security deposits, percent rent, and specific maintenance fees.

The high-level business process flow for processing invoices for receivables leases consists of these steps:

1. Create receivables leases (including all general and financial terms and conditions).
2. Activate receivables leases.
3. Run the Transaction Generator Application Engine process (RE\_GENTRANS).
4. Review transactions for processing in the transaction queue.

Add manual transactions if necessary.

See [Creating Manual Invoice Transactions](#).

5. Approve transactions for processing.

This step is optional. You can set up the Auto Approve option at the business unit level.

6. Run the Interface to AP/Billing Application Engine process (RE\_TXN\_INTFC).
7. View pending receivables.

Before you generate an invoice, you must first create a lease, define the amount and frequency for each recurring billable item, and activate the receivables lease. After you activate the lease, run the Transaction Generator process to load the billable items into the transaction queue. You can review the transactions in the transaction queue to ensure that the recurring rent schedules are correct. If the status is *Pending*, you must approve each transaction. If **Auto Approve** is selected in the business unit setup, the system automatically sets the transactions to *Approved*. The system processes all transactions that are in *Approved* status when you run the Interface to AP/Billing process.

---

**Note:** If you need to review any of the transactions prior to processing, you should not enable the Auto Approve feature for Billing Options at the business unit level.

---

To process invoices, PeopleSoft Lease Administration relies on the PeopleSoft Transaction Billing Processor to send billable transactions to Billing to generate the invoices. The Interface to AP/Billing process selects all of the eligible transactions from the transaction queue and passes the data to a PeopleSoft Contracts process (CABIDIR1) through the Transaction Billing Processor. This process is responsible for loading the transactions into designated staging tables and scheduling the direct invoicing

job, which contains the PeopleSoft Billing interface, the finalization, and print, PeopleSoft General Ledger posting, and the interface to PeopleSoft Receivables processes.

See “Understanding the PeopleSoft Transaction Billing Processor” (PeopleSoft Contracts).

## Payment Processing

Occasionally, you might need to process payments for reimbursement of repair costs or security deposit refunds. You can create manual payments for reimbursements or refunds using the Process Payments page.

See [Understanding Processing Payments for Payables Leases](#).

## Prerequisites

You must have active receivables leases before you can generate billable items to PeopleSoft Billing.

---

## Working with the Transaction Generator

This topic provides an overview of the transaction generator and discusses how to run the Transaction Generator process.

### Page Used to Manage the Transaction Generator

<i>Page Name</i>	<i>Definition Name</i>	<i>Usage</i>
<a href="#">Manage Transaction Generator Page</a>	RUN_RE_GENTRANS	Create a run control ID for the Manage Transactions Generator process and run the process.

## Understanding the Transaction Generator

The Transaction Generator process generates transactions into the transaction queue by monitoring the transaction schedule and processing transactions into the queue when the schedule date is reached, less the processing lead time defined at the business unit level. The transaction queue manages the financial transactions that are created by the transaction generator, as well as manual transaction entries that are entered directly in the transaction queue.

When you run the Transaction Generator process, the process picks up all recurring items that are due within the lead time that is defined for the Lease Administration business unit. Note that two different lead times are defined—one for receivables leases and one for payables leases. You also use the transaction generator to manage automatic lease expiration for leases that are due to expire. When the transaction generator identifies a row that is ready for processing, the system verifies the accuracy of the transaction amounts and modifies the transaction as needed. For example, if a base rent has an indexed escalation and the new index value goes into effect, the transaction schedule bill amount might be out of date. When the transaction generator picks up this row, the system recalculates the amount, revises the schedule, and inserts the modified transaction into the transaction queue for further processing.

The Transaction Generator processes records in these transaction tables:

- Lease Transaction (RE\_LS\_TXN)  
Contains the recurring and non recurring lease transactions.
- Lease Transaction Detail (RE\_LS\_TXN\_DTL)  
Contains the details such as amount per sales categories.
- Lease Transaction Note (RE\_LS\_TXN\_NOTE)  
Contains the transaction history.
- Lease Transaction Errors (RE\_LS\_TXN\_ERROR)  
Contains the interface error description.
- Lease Term Schedule (RE\_LS\_TRM\_SCHED)  
Contains the Financial Terms Schedules.

Typically, you run the Transaction Generator process as a scheduled process. You can run the process automatically on a recurring basis or as needed. For efficient and timely processing of any outstanding transactions, you should set up this process to run on a nightly recurring basis. Depending on the volume of transactions that are processed within your organization, you can set up this process to run more frequently, but you should run it at least once every day. You can also initiate this process at any time in addition to the normal recurring schedule.

## Prerequisites

Before you can run the Transaction Generator process, you must create and activate leases with recurring rent schedules.

## Manage Transaction Generator Page

Use the Manage Transaction Generator page (RUN\_RE\_GENTRANS) to create a run control ID for the Manage Transactions Generator process and run the process.

Navigation:

**Lease Administration > Integrations > Manage Transaction Generator**

<i>Field or Control</i>	<i>Description</i>
<b>Calculate Escalation Catchup</b>	Select the check box and run the transaction generator process to determine the escalation amounts, not calculated due to the unavailability of index values in the system, for the previously generated transactions. The schedule amount is recalculated and the difference in amount, if any, is added to the transaction that is generated.

Although the system does not require any parameters, you can limit the processing by business unit. If you do not enter a business unit, the system will process all business units. Click **Run** to run the Transaction Generator process.

## Managing Transactions for Invoice Processing

This topic provides an overview on invoice processing and discusses how to manage transactions for invoice processing.

### Pages Used to Manage Transactions for Invoice Processing

<i>Page Name</i>	<i>Definition Name</i>	<i>Usage</i>
<u>Billing Transactions Page</u>	RE_TXN_MANAGER	Manage and review transaction items that are generated by the transaction generator and any transaction items that are added through ad-hoc entry.
<u>Billing Transactions - Create Receivable Manual Fees Page</u>	RE_MFT_MAIN	Add manual fees, distribute them amongst leases, and create multiple transactions from a single invoice.
Billing Transactions - Maintain Receivable Manual Transaction Page	RE_MFT_MAIN	Update manual fees, distribute them amongst leases, and create multiple transaction from a single invoice.  <u>Billing Transactions - Create Receivable Manual Fees Page</u>
Payment Transactions - Create Receivable Manual Fees Page	RE_TXN_ADHOC_SEC	Add manual fees and create single payment transactions.  The <b>Create Receivable Manual Fees</b> button is only available when the lease is in an <i>Active</i> or <i>Holdover</i> status.  <u>Billing Transactions Page</u>
Billing Transaction Details Page	RE_TXN_DTL_SEC	Review transaction details such as categories, amount, and invoice number.  The invoice number is only available when the transaction status is <i>Processed</i> .  <u>Billing Transactions Page</u>

<b>Page Name</b>	<b>Definition Name</b>	<b>Usage</b>
Billing Interface Error Details Page	RE_TXN_ERROR_SEC	View the error description for specific transactions that are set to <i>Error</i> status during interface processing.  The Error button is only available when the transaction status is <i>Error</i> .  <a href="#">Billing Transactions Page</a>
Billing Transactions - Historic Details Page	RE_TXN_NOTES_SEC	Review historic details for the transaction.  <a href="#">Billing Transactions Page</a>

## Understanding Invoice Processing

You use the transaction queue to manage the recurring transactions that are created by the transaction generator or by using manual entries. The transaction queue enables you to approve, hold, un-hold, and cancel transactions in the queue. If the *Auto Approve* option is turned on at the business unit level, all transactions are automatically set to *Approved* status when the transaction generator places them into the queue. You can retain an approved transaction from further processing by selecting the transaction and clicking the **Hold** button; thus putting the transaction on hold. When you are ready to process the transaction, you can select it again and click the **UnHold** button. If a lease is in dispute and the lease status is set to *Dispute*, the system sets the associated transactions on hold. After the dispute is resolved, the transactions return to the original state that they were in prior to the lease dispute.

You can also cancel a transaction. After you cancel a transaction, no further processing occurs and you cannot reinitiate processing for that transaction in the future. Cancelling the transaction does not cause the transaction generator to recreate a new recurring row. If you cancel a row that came from one of the processing worksheets, such as a manual transaction, sales report, or operating expense reconciliation or audit, the system reopens that worksheet so you can modify it further.

You can create manual transactions for non-recurring charges such as: rekeying locks in a building, carpet cleaning, broken window repairs, and other charges that are not included in the lease.

The transaction queue is the final point in PeopleSoft Lease Administration that any billable transaction can be processed, modified, or cancelled. This component serves as a workspace for any pending transactions, enables you to add transactions as necessary, and provides capabilities for holding or cancelling transactions. It also serves as a historical log of past transactions, with links to various subsystems for further research and status verification.

## Prerequisites

Before you can select recurring transactions for invoice processing, you must create and activate the receivables leases and run the Transaction Generator process.

## Billing Transactions Page

Use the Billing Transactions page (RE\_TXN\_MANAGER) to manage and review transaction items that are generated by the transaction generator and any transaction items that are added through ad-hoc entry.

Navigation:

**Lease Administration > Receivable Leases > Processing Invoices > Billing Transactions**

This example illustrates the fields and controls on the Billing Transactions page. You can find definitions for the fields and controls later on this page.

The screenshot shows the 'Billing Transactions' page with the following sections:

- Search Criteria:** Fields for Business Unit (US001 NEW YORK OPERATIONS), Payor, Schedule Date (To), Transaction Origin, Region, Currency, Lease Number (is equal to), Lease Name (begins with), Lease Administrator, and Portfolio Manager.
- Transaction Status:** Checkboxes for Draft, Pending, Approved, Processed, Hold, Errors, and Cancelled.
- Transaction Group:** Checkboxes for Base Rent, Security Deposit, Operating Expenses, Percentage Rent, Miscellaneous Rent, and Manual Fees.
- Case Sensitive:** A checkbox.
- Buttons:** Search, Clear, Create Receivable Manual Fees, Update Selected Manual Fees, Select All, Clear All, Approve for Billing, Hold, UnHold, and Cancel.
- Table:** A table with columns: Select, Schedule Date, Transaction Origin, Transaction Group, Payor Name, Amount, Currency, Description, Status, Prior Period Variance, and Invoice Number. It contains three rows of transaction data.

Select	Schedule Date	Transaction Origin	Transaction Group	Payor Name	Amount	Currency	Description	Status	Prior Period Variance	Invoice Number
<input type="checkbox"/>	01/20/2000		Base Rent	Apex Systems	3,580.00	USD	Space 1031	Processed		
<input type="checkbox"/>	01/20/2000		Operating Expense	Apex Systems	710.40	USD	Space 1031	Processed		
<input type="checkbox"/>	01/31/2000		Base Rent	Alliance Group	12,000.00	USD	Space 1013	Processed		

Specify the business unit for which to view transactions. To view all transactions for a business unit, leave the remaining search fields empty and click the **Search** button.

To view a filtered list of transactions, enter or select criteria in one or more of the fields in the **Search for Billing Transactions** group box, then click **Search**. The page displays the transactions that match the search criteria in the **Billing Transactions** grid. Click **Clear** to clear all of the search criteria and results.

You can select multiple transaction statuses and multiple transaction groups. For example, if you select **Processed** and **Approved** transaction statuses and **Base Rent** and **Security Deposit** transaction groups, the system returns all base rent and security deposit transactions that are either processed or approved.

<b>Field or Control</b>	<b>Description</b>
<b>Create Receivable Manual Fees</b>	<p>Click to access the Billing Transactions - Create Receivable Manual Fees page to create manual transactions for billing. Manual billing transactions can be miscellaneous expense charge-backs to the tenant or payor, such as minor repair costs, rekeying of locks, and transactions that are not included as part of the recurring rents.</p> <hr/> <p><b>Note:</b> A manual fee can be cancelled. The status of the transaction changes to cancelled when a manual fee is cancelled. No changes are allowed on cancelled transactions.</p> <hr/>
<b>Update Selected Manual Fees</b>	<p>Click to access the Billing Transactions - Maintain Receivable Manual Transaction page to update an existing manual fee transaction. You must first select which manual fee transaction in the <b>Billing Transactions</b> grid that you want to update. You can access this page only for transactions that are in the <i>Manual Fee</i> transaction group.</p>
<b>Approve for Billing</b>	<p>Click to approve the selected transactions for billing. If you select the <b>Auto Approve</b> option when you establish your business unit, the system automatically approves all transactions in the transaction queue.</p>
<b>Hold</b>	<p>Click the button to hold selected transactions from further processing.</p> <hr/> <p><b>Note:</b> A lease that is put on hold due to a dispute automatically puts the pending transactions for that lease on hold status until the dispute is resolved.</p> <hr/> <p>See <a href="#">Understanding Leases</a>.</p>
<b>UnHold</b>	<p>Click the button to un-hold transactions that were previously on hold from further processing. The system automatically changes the status back to the initial status of the transaction prior to the hold.</p>
<b>Cancel</b>	<p>Click to cancel the selected transaction.</p> <hr/> <p><b>Note:</b> After a recurring transaction is cancelled, a new manual transaction must be created if one is required. The system does not regenerate a new recurring transaction.</p> <hr/>

### Billing Transactions – Transactions tab

<i>Field or Control</i>	<i>Description</i>
<b>Schedule Date</b>	Displays the date which the transaction is scheduled for invoicing. For example, if the transaction is due on the first of the month, the system generates the transaction prior to the first of the month (using the lead time that is defined for the business unit) for the user to approve for invoicing before the schedule date. Therefore, when the transaction originates from a recurring term, the schedule date can be either a regular recurring term (such as the 15th of the month) or a scheduled date that you add when you create the lease for proration purposes.
	Click to review the error description for specific transactions that are set to error during interface processing.  <b>Note:</b> The <b>Error</b> button is only available when the transaction status is <i>Error</i> .
<b>Transaction Group</b>	Displays the categories of each transaction. Click the category link to view details such as expense type, description, amount, and invoice ID.  <b>Note:</b> Invoice ID is only available when the transaction status is pending. You can click the Invoice ID link to view the voucher status in the PeopleSoft Billing system.

<i>Field or Control</i>	<i>Description</i>
<b>Prior Period Variance</b>	Displays the difference (in a percentage) between that recurring rent payment and the same recurring rent payment for the prior month. You can use this information to help with large variances from month-to-month, which are sometimes for escalations. For example, a rent payment of 1000 USD for the month of December is processed, but in January, an escalation takes effect and the new rent payment is 1200 USD. The prior period variance is 20 percent.

### Billing Transactions – Lease Information tab

The Lease Information tab displays the lease number, lease name, and region information that is associated with that transaction.



### Billing Transactions – Status Details tab

<i>Field or Control</i>	<i>Description</i>
<b>Modified By</b>	Displays the user that made modifications to the transaction.
<b>View Historical Details</b>	Click to access the Billing Transactions - Historic Details page where you can view a history of all of the status changes to the transaction. The system displays the type of change, the reason for the change, the originator of the change, and the time at which the change occurred.

### Billing Transactions - Create Receivable Manual Fees Page

Use the Billing Transactions - Create Receivable Manual Fees page (RE\_MFT\_MAIN) to add manual fees, distribute them amongst leases, and create multiple transactions from a single invoice.

Navigation:

Click the **Create Receivable Manual Fees** button on the Billing Transactions page.

This example illustrates the fields and controls on the Billing Transactions - Create Receivable Manual Fees page. You can find definitions for the fields and controls later on this page.

**Billing Transactions**

**Create Receivable Manual Fees**

Business Unit US001      Transaction Currency USD      Unit of Measure Square Feet

Personalize | Find | First 1 of 1 Last

*Manual Fee Type	Manual Fee Name	Amount	Description	Accounting Distribution
<input type="text"/>	<input type="text"/>	0.00	<input type="text"/>	Accounting Distribution
<b>Total Charges</b>		0.00	<input type="button" value="Calculate Total"/>	

Amount
  Percent

Personalize | Find | First 1 of 1 Last

Lease Number	Lease Name	Payor	Location	Transaction Status	Details	Amount	Percentage
<input type="text"/>	<input type="text"/>	<input type="text"/>	<input type="text"/>	<input type="text"/>	<input type="text"/>	0.00	0.00

**Manual Fee Group Transaction Summary**

Schedule Date

Total Charges	0.00	<input type="text"/>
Total Rentable Area	0.000	<input type="text"/>
Total Transaction Amount	0.00	<input type="text"/>
Allocated Percentage	0.00	<input type="text"/>
Transaction Count	0	<input type="text"/>

254 characters remaining

<b>Field or Control</b>	<b>Description</b>
<b>Schedule Date</b>	Enter the date on which you want to schedule the transactions for payment.
<b>Manual Fee Type</b>	Enter the manual fee type.
<b>Amount</b>	Enter the invoice amount.

## Creating Manual Invoice Transactions

This topic provides an overview of manual invoice transactions and discusses how to create manual invoice transactions and override accounting distributions.

### Pages Used to Create Manual Invoice Transactions

<b>Page Name</b>	<b>Definition Name</b>	<b>Usage</b>
<a href="#">Billing Transactions - Create Receivable Manual Fees Page</a>	RE_MFT_MAIN	Add manual fees, distribute them amongst leases, and create multiple transactions from a single invoice.
Billing Transactions - Maintain Receivable Manual Transaction Page	RE_MFT_MAIN	Update manual fees, distribute them amongst the desired leases and create manual invoice transactions.  <a href="#">Billing Transactions - Create Receivable Manual Fees Page</a>
Maintain Receivable Manual Transaction - Lease Search by Payor Page	RE_MFT_PAYEE_SEC	Search for leases by payor and select the leases to add to the <b>Transaction Details</b> grid on the Billing Transactions - Create Receivable Manual Fees page.  <a href="#">Billing Transactions - Create Receivable Manual Fees Page</a>
Manual Fees - Leased Property Search Page	RE_LEASE_PROP	Search for leases by property and select the leases to add to the <b>Transaction Details</b> grid on the Billing Transactions - Create Receivable Manual Fees page.  <a href="#">Billing Transactions - Create Receivable Manual Fees Page</a>

<b>Page Name</b>	<b>Definition Name</b>	<b>Usage</b>
Receivable Manual Fee - Transaction Details Page	RE_MFT_TXN_CHG_SEC	Review the manual invoice transaction details for a specific lease.  <a href="#">Billing Transactions - Create Receivable Manual Fees Page</a>
Receivable Manual Fee Transaction - Action History - Historic Details Page	RE_MFT_NOTES_SEC	Review historic details for the transaction.  <a href="#">Billing Transactions - Create Receivable Manual Fees Page</a>
<a href="#">Accounting Distributions Page</a>	RE_MFTCHG_DST_SEC	Override the accounting distributions defined at the business unit level.

## Understanding Manual Invoice Transactions

As a landlord, you may need to pass on costs to tenants or payors that you incur against a property or multiple properties. You may also need to assess a charge against one tenant or payor who holds multiple leases. PeopleSoft Lease Administration enables you manually capture these non-recurring transactions that may occur during the life of a lease, such as charges for unscheduled maintenance, non-recurring administration fees, or penalties for late payments. You can enter a single invoice that you can assign to multiple leases and distribute those amount to multiple tenants or payors. You can allocate the charges by amount or percentage and distribute the charges using these methods:

- **Evenly:** The system divides the total amount by the number of selected leases and allocates an equal share of the charges to each lease.
- **By Area:** The system adds the total leased area for all of the selected leases and distributes the charges proportionally between the leases based on the area for each lease.
- **Manually:** You can assign the charges manually to each lease.

The total of the distributed amounts must equal the total of the invoice.

After you allocate the individual amounts to each lease, you can send all of the resulting transactions to the transaction queue at one time. The system creates each of the transactions in pending status. You can edit or approve the transactions using the transaction queue. After you approve the transactions, you can run the Interface to AP/Billing process to post the transactions to PeopleSoft Billing.

## Transaction Status for Manual Invoices

This diagram illustrates the transaction status process flow for manual transactions.

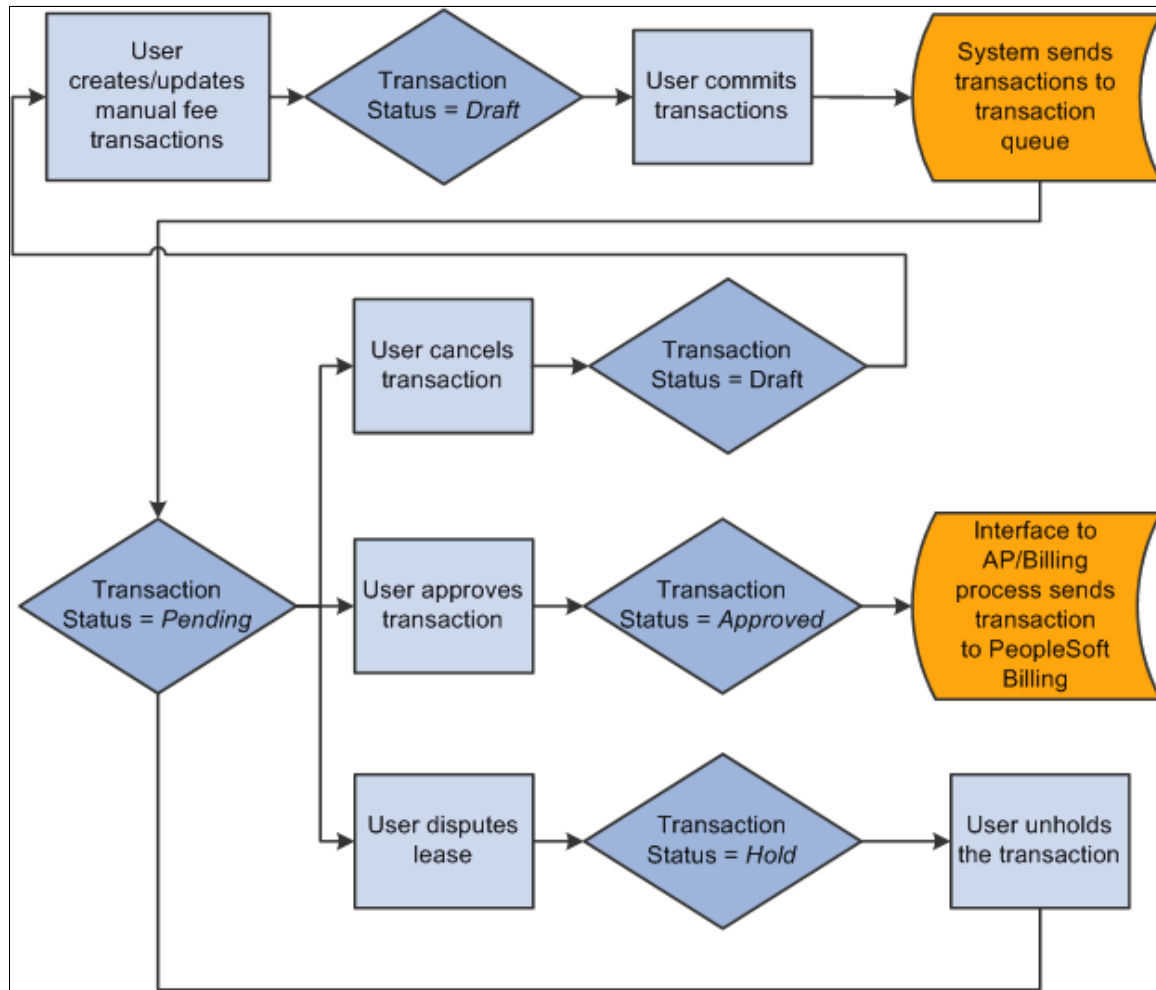

When you create manual transactions, the system sets each transaction to a status of *Draft*. You can modify, remove, or replace transactions while they are in draft status. After you commit the transactions, the system sets the status to *Pending*, and sends the transactions to the transaction queue. Use the Billing Transactions page to edit, hold, or approve the transactions.

If you dispute a lease, the system places all of its pending transactions in *Hold* status. If you cancel a manual fee transaction, the system returns the status of that transaction to *Draft*.

If you create the manual transactions as a group of transactions. After you commit the group of transactions, each set of lease transactions are processed individually. If the status of a transaction is updated, by either you or the system, only the transaction whose status changed is updated; the other transactions in the group are not affected.

## Billing Transactions - Create Receivable Manual Fees Page

Use the Billing Transactions - Create Receivable Manual Fees page (RE\_MFT\_MAIN) to add manual fees, distribute them amongst leases, and create multiple transactions from a single invoice.

Navigation:

- Lease Administration, Receivables Leases, Create Manual Receivables, Billing Transactions - Create Receivable Manual Fees
- Lease Administration, Receivables Leases, Processing Invoices, Billing Transactions

Click the **Create Receivable Manual Fees** button.

This example illustrates the fields and controls on the Billing Transactions - Create Receivable Manual Transaction page. You can find definitions for the fields and controls later on this page.

Billing Transactions

### Create Receivable Manual Fees

Business Unit US001      Transaction Currency USD      Unit of Measure Square Feet

[Add Charge](#)    [Accounting Distribution](#)    [Copy Manual Fee](#)

**Charge Details**    Personalize | Find | [?] | [?]    First 1 of 1 Last

*Manual Fee Type	Manual Fee Name	Amount	Description	Accounting Distribution
<input type="text"/>	<input type="text"/>	0.00	<input type="text"/>	Accounting Distribution
<b>Total Charges</b>		0.00	<a href="#">Calculate Total</a>	

**Add Lease By...**    **Distribute...**    **Allocate By**

Number    Payor    Property    Asset    Evenly    By Area     Amount     Percent

**Transaction Details**    Personalize | Find | [?] | [?]    First 1 of 1 Last

Transaction Details    Lease Details    Status Details

Lease Number	Lease Name	Payor	Location	Transaction Status	Details	Amount	Percentage
<input type="text"/>	<input type="text"/>	<input type="text"/>	<input type="text"/>	<input type="text"/>	<input type="text"/>	0.00	0.00

[Calculate Transaction Amounts](#)

**Manual Fee Group Transaction Summary**

Schedule Date

	Amount	Description
Total Charges	0.00	<input type="text"/>
Total Rentable Area	0.000	
Total Transaction Amount	0.00	
Allocated Percentage	0.00	
Transaction Count	0	254 characters remaining

[Commit Transactions](#)

When you first create manual fee transactions, the page name is Create Receivable Manual Fees page. After you save an exit the page, to access the information again, you access the Maintain Receivable Manual Transaction page. The pages function similarly. The status of the transactions control what you can edit on the page:

- If all of the transactions on this page are in *Draft* status, you can edit the entire page.
- If one or more of the transactions on this page are in *Draft* status, you can edit or delete the individual transactions or add new transactions.
- If all of the transactions on this page are in *Pending*, *Processed*, or *Error*, the page is display-only.

<b><i>Field or Control</i></b>	<b><i>Description</i></b>
<b>Add Charge</b>	Click to add a new manual fee. The system adds a row to the <b>Charge Details</b> grid.
<b>Accounting Distribution</b>	Click this link to access the Accounting Distribution page and to override business unit defaults for the accounting distributions.
<b>Manual Fee Name</b>	Enter the manual fee name. The available manual fees are based on the active manual fee types.  See <a href="#">Defining Manual Fee Types</a> .
<b>Amount</b>	Enter the amount of the manual fee that you want to distribute between leases. You can enter positive or negative amounts, but the amounts that you enter must either be all positive or all negative. If you want to issue a charge and a credit for the same group of transactions, you must enter them on two different worksheets.
<b>Description</b>	Enter the description of the manual fee. This field is only for informational purposes.
<b>Calculate Total</b>	Click to calculate the total amount of manual fees. The system adds the values in the <b>Amount</b> field and populates the <b>Total Charges</b> field with the total amount.

## Add Lease By

<b><i>Field or Control</i></b>	<b><i>Description</i></b>
<b>Number</b>	Click to insert a new empty row into the <b>Transaction Details</b> grid. You can click the <b>Look up Lease Key</b> icon in the <b>Lease Number</b> column to search for a lease.
<b>Payor</b>	Click to transfer to the Maintain Receivable Manual Transaction - Lease Search by Payor page on which you can search for leases by payors and select the leases to add to the <b>Transaction Details</b> grid.
<b>Property</b>	Click to transfer to the Manual Fees - Leased Property Search page on which you can search for leases by properties and select the leases to add to the <b>Transaction Details</b> grid.

<b>Field or Control</b>	<b>Description</b>
<b>Asset</b>	Click to transfer to the Manual Fees - Leased Asset Search page on which you can search for assets and select the assets to add to the <b>Transaction Details</b> grid.

## Distribute

<b>Field or Control</b>	<b>Description</b>
<b>Evenly</b>	Click to distribute the total charges evenly between the leases in the <b>Transaction Details</b> grid.
<b>By Area</b>	Click to distribute the total charges based on the proportional amount of rentable area by each lease in relation to the total area of all leases in the <b>Transaction Details</b> grid.

## Allocate By

<b>Field or Control</b>	<b>Description</b>
<b>Amount</b>	Select to use the <b>Amount</b> field to calculate the charges allocated to the lease transactions.
<b>Percent</b>	Select to use the <b>Percent</b> field to calculate the charges allocated to lease transactions.

## Transaction Details

<b>Field or Control</b>	<b>Description</b>
<b>Lease Number</b>	Enter the lease to which the transaction will be allocated. You can select from leases that are in <i>Active</i> , <i>Holdover</i> , or <i>Expired</i> status.
 <b>Details</b>	Click the <b>Details</b> icon for a lease to access the Receivable Manual Fee - Transaction Details on which you can view a summary of the transaction details for that lease.
<b>Payor</b>	Enter the entity whom is responsible to pay the charges. The system uses the tenant as the default. You can override this value.

<b>Field or Control</b>	<b>Description</b>
<b>Transaction Status</b>	Displays the transaction status. The system initially creates each transaction with a status of <i>Draft</i> . After you commit the transactions, the system sets the status to <i>Pending</i> .
<b>Amount</b>	Enter the total amount of charges to allocate to this transaction. The sum of all the amounts that you enter must equal the total charges from the <b>Charge Details</b> amounts. You can enter positive or negative amounts, but the amounts that you enter must either be all positive or all negative. If you want to issue a charge and a credit for the same group of transactions, you must enter them on two different worksheets.
<b>Percentage</b>	Enter the percentage of the charges to allocate to this transaction. The sum of all of the percentages that you enter must equal <i>100</i> .
<b>Rentable Area</b>	Displays the total rentable area of the lease associated with the transaction.
<b>Revision History</b>	Click to access the Receivable Manual Fee Transaction - Action History - Historic Details page to review the transaction history for a specific lease.
<b>Calculate Transaction Amounts</b>	Click to update the values in the <b>Manual Fee Group Transaction Summary</b> group box.

### Manual Fee Group Transaction Summary

<b>Field or Control</b>	<b>Description</b>
<b>Schedule Date</b>	Enter the date on which you want to schedule the transactions for invoicing.
<b>Total Charges</b>	Displays the total amount to be allocated. This field is the same as the <b>Total Charges</b> field near the top of the page.
<b>Total Rentable Area</b>	Displays the total rentable area for the leases associated with these transactions. The systems sums all of the values from the <b>Rentable Area</b> column in the <b>Transaction Details</b> grid.



<b>Field or Control</b>	<b>Description</b>
<b>Total Transaction Amount</b>	Displays the total amount of charges that you have allocated. The systems sums all of the values from the <b>Amount</b> column in the <b>Transaction Details</b> grid. This value must equal the value in the <b>Total Charges</b> field before you can commit the transactions.
<b>Allocated Percentage</b>	Displays the total percentage of charges that you have allocated. The systems sums all of the values from the <b>Percentage</b> column in the <b>Transaction Details</b> grid. This value must equal <i>100.00</i> before you can commit the transactions.
<b>Transaction Count</b>	Displays the number of transactions from the <b>Transaction Details</b> grid.
<b>Commit Transactions</b>	Click to process the transactions. The system validates the transactions, sets the transactions statuses to <i>Pending</i> and sends them to the transaction queue. The page becomes display-only.

## Accounting Distributions Page

Use the Accounting Distributions page (RE\_MFTCHG\_DST\_SEC) to override the accounting distributions defined at the business unit level.

Navigation:

Click the **Accounting Distributions** link on the Refund Security Deposit - Create Receivable Manual Transaction page.

This example illustrates the fields and controls on the Create Receivable Manual Fees - Accounting Distributions page. You can find definitions for the fields and controls later on this page.

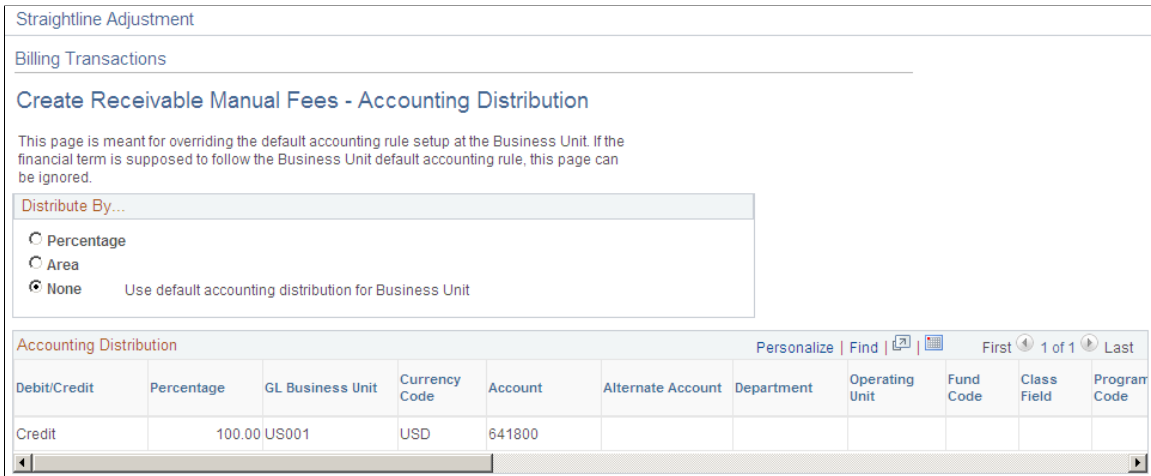

The fields on this page differ depending upon the distribution selected. When you select a value other than **None**, the ChartField values become available for edit.

<b>Field or Control</b>	<b>Description</b>
<b>Distribute By</b>	<p>Select either:</p> <ul style="list-style-type: none"> <li>• <b>Percentage:</b> Select this value to change the accounting distribution by percentage for each financial term.</li> <li>• <b>Area:</b> Select this value to change the accounting distribution by area for each financial term. The rent will be distributed based on the ratio of the areas.</li> <li>• <b>None:</b> Select this option to use the accounting distribution set up at the business unit level.</li> </ul>
<b>Add Distribution</b>	<p>This button appears if you select <b>Percentage</b> or <b>Area</b> for the distribute by value.</p> <p>Click this button to insert a new distribution row.</p>
<b>Delete Distribution</b>	<p>This button appears if you select <b>Percentage</b> or <b>Area</b> for the distribute by value.</p> <p>Select a row and click this button to delete it from this page.</p>
<b>Select</b>	<p>This option appears if you select <b>Percentage</b> or <b>Area</b> for the distribute by value.</p> <p>This option is used to delete the distribution rows. Users can select all the distribution rows that they want to delete and click the <b>Delete Distribution</b> button to delete them.</p>

<i>Field or Control</i>	<i>Description</i>
<b>Percentage</b>	This field appears if you select <b>Percentage</b> for the distribute by value.  Enter a percentage amount for this distribution line.  Percentage amounts must equal 100% to be valid.
<b>Area</b>	This field appears if you select <b>Area</b> for the distribute by value.  Enter the area for this distribution line.  All lines must add up to the total rentable area for the lease to be valid.
<b>Valid</b>	Used to indicate a valid combination of chartfields. When activating the lease, edit checking will be provided and the option will be selected for each row representing a valid combination of chartfields. A lease cannot be activated until every accounting distribution is marked as valid.

## Running the Interface to AP/Billing Process

This topic provides an overview of managing interface to AP/Billing and discusses how to run manage interface to AP/Billing.

### Page Used to Run Manage Interface to AP/Billing

<i>Page Name</i>	<i>Definition Name</i>	<i>Usage</i>
<u>Manage Interface to AP/Billing Page</u>	RUN_TXN_INTFC	Run to generate transactions to PeopleSoft Billing to create sales invoices to the tenants.

## Understanding the Interface to AP/Billing Process

To generate invoices to PeopleSoft Billing, you must run the Interface to AP/Billing process. This process transfers approved transactions to the PeopleSoft Billing system using the PeopleSoft Transaction Billing Processor. This process is also used to generate payments to payees or landlords for payables leases.

See [Understanding Leases](#).

The Transaction Billing Processor is a set of processes that are supplied by the PeopleSoft Contracts application that enable external applications to create sales invoices in the PeopleSoft Billing system. A contract must exist to utilize this interface. For the Lease Administration feature, the system creates a contract header, a contract line, and a bill plan every time a receivables lease is activated and associates

the contract with the lease. Billable items such as lease transactions are submitted to the PeopleSoft Contracts system as transactions in the interface tables.

The following is the high level business process flow:

1. PeopleSoft Lease Administration integrates with PeopleSoft Billing and PeopleSoft Contracts so that you can generate invoices for all of their transactions.

Billing information from PeopleSoft Lease Administration is sent to PeopleSoft Contracts as transactions.

2. The Transaction Billing Processor process selects Billing Plans (for rate-based billing methods) that have been marked in the PeopleSoft Contracts system as ready to bill and creates bill lines in the PeopleSoft Billing Interface tables for the transactions that are sent by the PeopleSoft Lease Administration system.

For PeopleSoft Lease Administration transactions, PeopleSoft Contracts sends revenue to the PeopleSoft Billing system, and the PeopleSoft Billing system creates the receivables side of the debit entry.

3. After the Transaction Billing Processor process stages the billing data in these tables, the Billing Interface processes the data to create bills.
4. When a transaction is selected for billing, the data from the transaction and the data from the billing plan (including bill-to customer, bill by, and bill type) combine to create the basis for a bill line.
5. The PeopleSoft Billing system then groups bill lines based on the **Billing Options** that are defined in the billing plan and generates invoices for the transactions and upon finalization, sends information regarding the invoices back to the PeopleSoft Contracts system.

The following example shows how a journal entry is created by the billing plan (as incurred method) in PeopleSoft Billing for a PeopleSoft Lease Administration transaction that was for 100 USD:

	<i><b>Credit</b></i>	<i><b>Debit</b></i>
Receivables		\$100
Revenue	\$100	

To post the entries that are shown in the example, you must set up an appropriate accounting rule so that the system can send the revenue to PeopleSoft Billing system and the PeopleSoft Billing system can create the receivable debit side of the entry.

---

**Note:** The billing business unit that is used for the receivables for this entry must share the same general ledger business unit as the PeopleSoft Contracts system business unit.

---

See “Understanding Integration Messages for Transaction Billing” (PeopleSoft Contracts).

## Processing Errors

To resolve errors or issues for lease transactions that are sent through the Transaction Billing Processor, you must first determine where the error occurred. Resolution for the errors that occur after the

transaction is sent from PeopleSoft Lease Administration to PeopleSoft Billing through the Transaction Billing Processor must be resolved in the PeopleSoft Billing system .

When the error occurs in the Interface to AP/Billing process or Transaction Billing Processor, the error is typically caused by incomplete setup of the accounting rules. The transaction detail is set to *Error* in the transaction queue and the resulting error stops the processing for that transaction. Although the error occurred for this transaction, other valid transactions continue to be processed. For example, if only one category of an operating expense transaction is in error, the other categories of that same operating transaction with valid accounting entries are transferred to PeopleSoft Billing to be invoiced. You need to resolve the error in the setup and run the process again to process the transaction through the PeopleSoft Billing system.

To resolve the error, you can search the transaction queue and review the transaction detail error message. You cannot change the transaction, but you can correct the setup. After the setup error is resolved, all the transaction details in error are automatically recycled when Manage Interface to AP/Billing process is generated.

See [Understanding PeopleSoft Lease Administration Accounting Rules](#).

## Accessing Billing Information

When a transaction is successfully processed through the Billing interface, the status in the transaction queue is set to *Processed*. You can view the transaction details in the grid. To review the transaction details, select the transaction from the queue. The system displays the invoice number on which the transaction detail resides. Clicking the invoice number link takes you to the Billing Inquiry page.

See “Bill Summary Info Page” (PeopleSoft Billing).

---

**Note:** If a transaction with the status of *Processed* does not have an invoice number, it might be due to a delay in the execution of the PeopleSoft Billing interface.

---

## Prerequisites

Before you run the Interface to AP/Billing process, verify that transactions in the transaction queue are in *Approved* status.

## Manage Interface to AP/Billing Page

Use the Manage Interfaces to AP/Billing page (RUN\_TXN\_INTFC ) to run to generate transactions to PeopleSoft Billing to create sales invoices to the tenants.

Navigation:

**Lease Administration > Integrations > Manage Interface to AP/BI**

This example illustrates the fields and controls on the Manage Interfaces to AP/Billing page. You can find definitions for the fields and controls later on this page.

### Manage Interfaces to AP/Billing

Run Control ID RE
Report Manager Process Monitor
Run

#### Request Parameters

Business Unit

Lease Number

Invoice Date  Current Date

Schedule Date

Custom Date

#### Interface Selection

Payables

Billing

<b>Field or Control</b>	<b>Description</b>
<b>Business Unit</b>	Enter a business unit to generate transactions that are specific to that business unit.
<b>Lease Number</b>	Enter a lease number to generate transactions for that lease. You must enter a business unit before you can enter a lease number.
<b>Invoice Date</b>	<p>Select an option from the following:</p> <ul style="list-style-type: none"> <li>Current Date: Current date is taken as the invoice date.</li> <li>Schedule Date: Transaction schedule date is taken as the invoice date.</li> <li>Custom Date: Invoice date that is saved on the Processing Payments page is taken.</li> </ul> <hr/> <p><b>Note:</b> The invoice date selected here overrides the invoice date specified on the Processing Payments page if the date varies on both the pages.</p> <hr/>

## Interface Selection

<i>Field or Control</i>	<i>Description</i>
<b>Payables</b>	Select to send all payables transactions for the business unit and lease number parameters to the staging table. If you leave both fields blank, the system sends all approved transactions for payables to the PeopleSoft Payables staging table.
<b>Billing</b>	Select to send all billing transactions for the business unit and lease number parameters to the staging table. If you leave both fields blank, the system sends all approved transactions for receivables to the Billing staging table.  See <a href="#">Understanding the Interface to AP/Billing Process</a> .

---

## Viewing Pending Lease Receivables

This topic discusses how to view pending lease receivables.

### Pages Used to View Pending Lease Receivables

<i>Page Name</i>	<i>Definition Name</i>	<i>Usage</i>
<a href="#">Pending Lease Receivables Page</a>	RE_RECEIVABLE_INQ	Inquire on the pending invoices for a lease. You can view the invoice types and the schedule date the transaction is to be processed for all invoices associated to the lease.

### Pending Lease Receivables Page

Use the Pending Lease Receivables page (RE\_RECEIVABLE\_INQ) to inquire on the pending invoices for a lease.

You can view the invoice types and the schedule date the transaction is to be processed for all invoices associated to the lease.

Navigation:

**Lease Administration > Reports > Pending Lease Receivables**

This example illustrates the fields and controls on the Pending Lease Receivables page. You can find definitions for the fields and controls later on this page.

### Pending Lease Receivables

**Search Criteria**

\*Business Unit  US001 NEW YORK OPERATIONS

Due Date From  [x] To  [x]

Lease Number

Lease Administrator

Portfolio Manager

Region

Only the first 300 results of a possible 1665 can be displayed. Enter more search key information and search again to reduce the number of search results.

Pending Lease Receivables										Personalize   Find   View 100
Lease Number	Schedule Number	Term	Schedule Date	Generated Date	Amount	Currency	Payor	Schedule Status		First 1-2 of 300 Last
0000000031	1	Base Rent	01/31/2000	05/03/2006	12000.00	USD	Alliance Group	Generated		
0000000031	2	Base Rent	02/29/2000	05/03/2006	12000.00	USD	Alliance Group	Generated		

Enter the business unit and click **Search** to view all of the leases with pending payments and their schedules within that business unit. To view a filtered list, enter search criteria in the fields and click **Search**. Click **Clear** to clear all of the search criteria and results.

<b>Field or Control</b>	<b>Description</b>
<b>Due Date From:</b> and <b>To:</b>	Select the date range for pending transactions that are scheduled within that range.
<b>Lease Administrator</b>	Select to view pending transactions schedules associated to that lease administrator.
<b>Portfolio Manager</b>	Select to view pending transaction schedules associated to that portfolio manager.
<b>Term</b>	Displays the type of transaction scheduled. The term can be for base rent, operating expense, miscellaneous rent, and so on.
<b>Schedule Date</b>	Displays the date the transaction is scheduled to be processed.
<b>Generated Date</b>	Displays the date the transaction is processed by the Transaction Generator process and placed in the Transaction Queue.
<b>Payor</b>	Displays the entity whom is responsible for the payment.



<b><i>Field or Control</i></b>	<b><i>Description</i></b>
<b>Schedule Status</b>	Displays transaction schedule status, whether the transaction is pending or generated to the transaction queue.



# Processing Payments for Payables Leases

---

## Understanding Processing Payments for Payables Leases

PeopleSoft Lease Administration provides a facility to manage the life cycle of a lease. During the lease life cycle, various payable items are generated. These items are submitted to the landlord for payment. To generate payments for these expenses, PeopleSoft Lease Administration utilizes the transaction generator, the transaction queue, and the interface to AP/Billing to automatically generate rent and other related expense payments from a lease directly into the PeopleSoft Payables system with the appropriate tax and accounting information.

The high-level business process flow for processing payments for payables leases consists of these steps:

1. Create payables leases (including all general and financial terms and conditions).
2. Activate payables leases.
3. View pending lease payables.
4. Run the Transaction Generator Application Engine process (RE\_GENTRANS).
5. Review transactions for processing in the transaction queue.
6. Add manual transactions, as required (optional).
7. Approve transactions for processing.

This step is optional. You can set up the Auto Approve option at the business unit level.

8. Run the Interface to AP/Billing Application Engine process (RS\_TXN\_INTFC).

Before you can generate a payment, you must first create a payables lease, define the amount and frequency for each recurring payable term, and activate the lease. Upon activation, you run the Transaction Generator process to load the payables items into the transaction queue. You can review the transactions in the transaction queue to ensure that the recurring payment schedules are correct. If the status is *Pending*, you must approve each transaction. If the **Auto Approve** option is selected in the business unit setup, the system automatically sets the transactions to *Approved*. The system processes all transactions that are in *Approved* status when you run the Interface to AP/Billing process.

---

**Note:** If you need to review any of the transactions prior to processing, You should not enable the Payables Auto Approve option at the business unit level.

---

The PeopleSoft Lease Administration system transfers the payable items to the PeopleSoft Payables application to generate the vouchers and payments. The Interface to AP/Billing process selects all of the eligible transactions from the transaction queue and passes them to the PeopleSoft Payables voucher staging tables. The PeopleSoft Payables application processes creates vouchers from the transactions that

are loaded in the staging table, schedules the vouchers for payment, issues the payments, and posts the accounting entries to the general ledger.

## Prerequisites

You must establish at least one active payables lease before generating payable items for payment.

See [Understanding Leases](#).

---

## Working with the Transaction Generator

This topic provides an overview of the transaction generator and discusses how to run the Transaction Generator.

### Page Used to Manage the Transaction Generator

<i>Page Name</i>	<i>Definition Name</i>	<i>Usage</i>
<a href="#">Manage Transaction Generator Page</a>	RUN_RE_GENTRANS	Create a run control ID for the Manage Transactions Generator process and run the process.

## Understanding the Transaction Generator

The Transaction Generator process generates transactions into the transaction queue by monitoring the transaction schedule and processing transactions into the queue when the schedule date is reached, less the processing lead time that is defined at the business unit level. Use the transaction queue to manage the financial transactions that are created by the transaction generator, as well as the manual ad hoc transaction entries that are entered directly in the transaction queue.

When you run the Transaction Generator process, the process picks up all recurring items that are due within the lead time that is defined for the Lease Administration business unit. Note that two different lead times are defined—one for receivables leases and one for payables leases. You also use the transaction generator to manage automatic lease expiration for leases that are due to expire. When the transaction generator identifies a row that is ready for processing, the system verifies the accuracy of the transaction amounts and modifies the transaction as needed. For example, if a base rent has an indexed escalation and the new index value goes into effect, the transaction schedule amount might be out of date. When the transaction generator picks up this row, the system recalculates the amount, revises the schedule, and inserts the modified transaction into the transaction queue for further processing.

The Transaction Generator processes records in these transaction tables:

- Lease Transaction (RE\_LS\_TXN)  
Contains the recurring and nonrecurring lease transactions.
- Lease Transaction Detail (RE\_LS\_TXN\_DTL)  
Contains the details such as amount per sales categories.

- Lease Transaction Note (RE\_LS\_TXN\_NOTE)  
Contains the transaction history.
- Lease Transaction Error (RE\_LS\_TXN\_ERROR)  
Contains the interface error description.
- Lease Term Schedule (RE\_LS\_TRM\_SCHED)  
Contains the financial terms schedules.

Typically, you run the Manage Transaction Generator process as a scheduled process. You can run the process automatically on a recurring basis or as needed. For efficient and timely processing of any outstanding transactions, you should set up this process to run on a nightly recurring basis. Depending on the volume of transactions that are processed within your organization, you can set up this process to run more frequently, but you should run it at least once every day. You can also initiate this process at any time in addition to the normal recurring schedule.

## Manage Transaction Generator Page

Use the Manage Transaction Generator page (RUN\_RE\_GENTRANS) to create a run control ID for the Manage Transactions Generator process and run the process.

Navigation:

**Lease Administration > Integrations > Manage Transaction Generator**

**Note:** As part of the shared product functionality, the Manage Transaction Generator page can also be accessed through the Asset Management navigation as follows: Asset Management > Asset Transactions > Leased Assets > Manage Transaction Generator.

<i>Field or Control</i>	<i>Description</i>
<b>Calculate Escalation Catchup</b>	Select the check box and run the transaction generator process to determine the escalation amounts, not calculated due to the unavailability of index values in the system, for the previously generated transactions. The schedule amount is recalculated and the difference in amount, if any, is added to the transaction that is generated.

Although the system does not require any parameters, you can limit the processing by business unit. If you do not enter a business unit, the system will process all business units. Click **Run** to run the Transaction Generator process.

## Managing Transactions for Payment Processing

This topic provides an overview of payment processing and discusses how to manage transactions for payment processing.

## Pages Used to Manage Transactions for Payment Processing

<b>Page Name</b>	<b>Definition Name</b>	<b>Usage</b>
<u>Payment Transactions Page</u>	RE_TXN_MANAGER	Manage and review transaction items that are generated by the transaction generator and any transaction items that are added through manual entry.
Payment Transactions - Create Payable Manual Fees Page	RE_MFT_MAIN	Enter manual fees, distribute them amongst leases and payees, and create multiple transactions from one group of manual fees.  <u>Payment Transactions Page</u>
Payment Transaction - Maintain Payable Manual Transaction Page	RE_MFT_MAIN	Update manual fees, distribute them amongst leases and payees, and create multiple transactions from one group of manual fees.  <u>Payment Transactions Page</u>
Payment Transaction Details	RE_TXN_DTL_SEC	View transaction details such as categories, amounts, and voucher IDs.  Voucher IDs are only available when the transaction status is <i>Processed</i> .  <u>Payment Transactions Page</u>
Billing Interface Error Details Page	RE_TXN_ERROR_SEC	View the error description for specific transactions that are set to <i>Error</i> status during interface processing.  The <b>Error</b> button is only available when the transaction status is <i>Error</i> .  <u>Payment Transactions Page</u>
Payment Transactions - Historical Details Page	RE_TXN_NOTES_SEC	Review historic details for the transaction.  <u>Payment Transactions Page</u>

## Understanding Payment Processing

You use the transaction queue to manage the recurring transactions that are created by the transaction generator or by using manual entries. The transaction queue enables you to approve, hold, un-hold, and cancel transactions in the queue. If the **Auto Approve** option is turned on at the business unit, all transactions are automatically set to *Approved* status when the transaction generator places them into the queue. You can retain an approved transaction from further processing by selecting the transaction and clicking the **Hold** button; thus putting transaction on hold. When you are ready to process the transaction,

you can select it again and click the **UnHold** button. If a lease is in dispute and the status is set to *Dispute*, the system sets the associated transactions on hold. After the dispute is resolved, you should manually unhold the transaction to restore the transaction to its original state.

You can also cancel a transaction. After you cancel the transaction, no further processing occurs and you cannot reinitiate processing for that transaction in the future. Cancelling a recurring transaction does not cause the transaction generator to recreate a new recurring row. But if you cancel a row that came to the transaction queue from the security deposit processing or on one of the processing worksheets, such as a manual transaction, sales report or operating expense reconciliation or audit, the system reopens that worksheet so you can modify it further.

You can create manual transactions for nonrecurring charges, such as rekeying locks in a building, carpet cleaning, broken window repairs, and other charges that are not included in the lease.

The transaction queue is the final point in PeopleSoft Lease Administration that any payables transaction can be processed, modified, or cancelled. This component serves as a workspace for any pending transactions and enables you to add transactions as necessary, such as holding or cancelling transactions. It also serves as a historical log of past transactions, with links to various subsystems for further research and status verification.

## Prerequisites

Before you can select recurring transactions for payment processing, you must create and activate payables leases and run the Transaction Generator process.

## Payment Transactions Page

Use the Payment Transactions page (RE\_TXN\_MANAGER) to manage and review transaction items that are generated by the transaction generator and any transaction items that are added through manual entry.

Navigation:

**Lease Administration > Payables Leases > Process Payable Lease Pymts > Payment Transactions**

---

**Note:** As part of the shared product functionality, the Processing Payments page can also be accessed through the Asset Management navigation as follows: Asset Management > Asset Transactions > Leased Assets > Processing Payments.

---

This example illustrates the fields and controls on the Payment Transactions page. You can find definitions for the fields and controls later on this page.

The screenshot shows the 'Payment Transactions' interface. At the top, there is a search criteria section with fields for Business Unit (US001 NEW YORK OPERATIONS), Schedule Date (01/01/2000 to 01/20/2000), Transaction Origin, Region, Currency, Payee, Lease Number, Lease Name, Lease Administrator, and Portfolio Manager. Below this are sections for Transaction Status (Draft, Pending, Approved, Processed, Hold, Errors, Cancelled) and Transaction Group (Base Rent, Security Deposit, Operating Expenses, Percentage Rent, Miscellaneous Rent, Manual Fees). There are buttons for 'Search', 'Clear', 'Create Payable Manual Fees', and 'Update Selected Manual Fees'. A 'Selected Items' section includes 'Approve for Payables', 'Hold', 'UnHold', and 'Cancel'. The main part of the page is a table with columns: Select, Schedule Date, Transaction Origin, Transaction Group, Payee Name, Amount, Currency, Description, Status, Prior Period Variance, Invoice Number, Invoice Date, and Expense Comments. The table contains three rows of transaction data.

Select	Schedule Date	Transaction Origin	Transaction Group	Payee Name	Amount	Currency	Description	Status	Prior Period Variance	Invoice Number	Invoice Date	Expense Comments
<input checked="" type="checkbox"/>	01/01/2000		Security Deposit	East Bay Travel	20,000.00	USD	Space 1013	Pending			01/01/2000	
<input type="checkbox"/>	01/20/2000		Base Rent	Star Rental Group	4,451.61	USD	Space 1021	Processed			01/20/2000	
<input type="checkbox"/>	01/20/2000		Operating Expense	East Bay Travel	1,038.19	USD	Space 1021	Processed			01/20/2000	

Specify the business unit for which to view transactions. To view all transactions for a business unit, leave the remaining search fields empty and click the **Search** button.

To view a filtered list of transactions, enter or select criteria in one or more of the fields in the **Search for Payment Transactions** group box, then click **Search**. The page displays the transactions that match the search criteria in the **Payment Transactions** grid. Click **Clear** to clear all of the search criteria and results.

You can select multiple transaction statuses and multiple transaction groups. For example, if you select **Processed** and **Approved** transaction statuses and **Base Rent** and **Security Deposit** transaction groups, the system returns all base rent and security deposit transactions that are either processed or approved.

Field or Control	Description
<b>Create Payable Manual Fees</b>	Click to access the Payment Transactions - Create Payable Manual Fees page to create manual transactions for payment. Manual payment transactions can be one-time miscellaneous expense payments to the landlord or payee, such as minor repair costs, rekeying of locks, or transactions that are not included as part of the recurring terms.  <b>Note:</b> A manual fee can be cancelled. The status of the transaction changes to cancelled when a manual fee is cancelled. No changes are allowed on cancelled transactions.
<b>Update Selected Manual Fees</b>	Click to access the Payment Transactions - Maintain Payable Manual Transaction page to update an existing manual fee transaction. You must first select which manual fee transaction in the <b>Payment Transactions</b> grid that you want to update. You can access this page only for transactions that are in the <i>Manual Fee</i> transaction group.



<i>Field or Control</i>	<i>Description</i>
<b>Approve for Payables</b>	Click to approve the selected transactions for payment. If you selected the <b>Auto-Approve</b> option when you established your business unit, the system automatically approves all transactions in the transaction queue.
<b>Hold</b>	<p>Click the button to hold selected transactions from further processing.</p> <hr/> <p><b>Note:</b> A lease that is put on hold due to a dispute automatically puts the pending and approved transactions for that lease on hold status until the dispute is resolved. After the dispute is resolved, you should manually unhold the transaction to restore transaction to previous status.</p> <hr/> <p>See <a href="#">Understanding Leases</a>.</p>
<b>UnHold</b>	Click the button to un-hold transactions that were previously on hold from further processing. The system automatically changes the status back to the initial status of the transaction prior to the hold.
<b>Cancel</b>	<p>Click to cancel the selected transaction.</p> <hr/> <p><b>Note:</b> After a recurring transaction is cancelled, you must create a new manual transaction if one is required. The system does not regenerate a new recurring transaction.</p> <hr/>

### Payment Transactions - Transactions tab

<i>Field or Control</i>	<i>Description</i>
<b>Schedule Date</b>	Displays the date on which the transaction is scheduled for payment. For example, if the transaction is due on the first day of the month, the system generates the transaction prior to the first day of the month using the lead time that is defined for the business unit for the user to approve for payment before the scheduled date. Therefore, when the transaction originates from a recurring term, the schedule date can be either a regular recurring term (such as every 15th day of the month), or a schedule date that is added when you create the lease for proration purposes.
<b>Transaction Origin</b>	Identifies the origin of the transaction in the Transaction Queue Manager.

<b>Field or Control</b>	<b>Description</b>
	<p>Click to review the error description for specific transactions that are set to error during interface processing.</p> <hr/> <p><b>Note:</b> The <b>Error</b> button is only available when the transaction status is <i>Error</i>.</p>
<b>Transaction Group</b>	<p>Displays the categories of each transaction. Click the category link to view details such as expense type, description, amount, and voucher ID.</p> <hr/> <p><b>Note:</b> Voucher ID is only available when the transaction status is pending. You can click the <b>Voucher ID</b> link to view the voucher status in the PeopleSoft Payables system.</p>
<b>Prior Period Variance</b>	<p>Displays the percentage difference between the recurring rent payment and the same recurring rent payment for the prior month. This information can be helpful in identifying large variances from month-to-month, which are sometimes for escalations. For example, a rent payment of 1000 USD for the month of December is processed, but in January, an escalation takes effect and the new rent payment is 1200 USD. The prior period variance is 20 percent.</p>
<b>Invoice Date</b>	<p>Initial value is defaulted to the transaction schedule date. However you can edit the date and save it. The edited invoice date will appear on the voucher.</p> <hr/> <p><b>Note:</b> Invoice date can only be modified for pending transactions. Also the option to edit invoice date is available only for payable leases.</p>

### Payment Transactions - Lease Information tab

The Lease Information tab displays the lease number, lease name, and region information associated with that transaction. Click the **Accounting Distributions** link to view the accounting distributions for each transaction.

### Payment Transactions - Status Details tab

<b>Field or Control</b>	<b>Description</b>
<b>Modified By</b>	Displays the user who made modifications to the transaction.

<b>Field or Control</b>	<b>Description</b>
<b>View Historical Details</b>	<p>Click to access the Payment Transactions - Historic Details page where you can view a history of all of the status changes to the transaction. The system displays the type of change, the reason for the change, the originator of the change, and the time at which the change occurred.</p> <hr/> <p><b>Note:</b> The system does not display the posted status for payables transactions. If the status is <i>Processed</i>, then the payment has successfully posted.</p> <hr/>

## Creating Manual Payment Transactions

This topic provides an overview of manual payment transactions and discusses how to create manual payment transactions.

### Pages Used to Create Manual Payment Transactions

<b>Page Name</b>	<b>Definition Name</b>	<b>Usage</b>
<a href="#">Payment Transactions - Create Payable Manual Fees Page</a>	RE_MFT_MAIN	Add manual fees, distribute them amongst leases, and create multiple payment transactions.
<a href="#">Payment Transactions - Create Payable Manual Fees Page</a>	RE_TXN_ADHOC_SEC	Add manual fees and create single payment transactions.  The <b>Create Payable Manual Fees</b> button is only available when the lease is in an <i>Active</i> or <i>Holdover</i> status.
Payment Transactions - Maintain Payable Manual Transaction Page	RE_MFT_MAIN	Update manual fees, distribute them amongst the desired leases and create manual payment transactions.  <a href="#">Payment Transactions - Create Payable Manual Fees Page</a>
Maintain Payable Manual Transaction - Lease Search by Payee Page	RE_MFT_PAYEE_SEC	Search for leases by payor and select the leases to add to the <b>Transaction Details</b> grid on the Payment Transactions - Create Payable Manual Fees page.  <a href="#">Payment Transactions - Create Payable Manual Fees Page</a>

<b>Page Name</b>	<b>Definition Name</b>	<b>Usage</b>
Manual Fees - Leased Property Search Page	RE_LEASE_PROP	Search for leases by property and select the leases to add to the <b>Transaction Details</b> grid on the Payment Transactions - Create Payable Manual Fees page.  <a href="#">Payment Transactions - Create Payable Manual Fees Page</a>
Payable Manual Fee - Transaction Details Page	RE_MFT_TXN_CHG_SEC	Review the manual statement transaction details for a specific lease.  <a href="#">Payment Transactions - Create Payable Manual Fees Page</a>
Payable Manual Fee Transaction - Action History - Historic Details Page	RE_MFT_NOTES_SEC	Review historic details for the transaction.  <a href="#">Payment Transactions - Create Payable Manual Fees Page</a>
<a href="#">Overriding Accounting Distributions</a>	RE_MFTGRP_DST_SEC	Override the accounting distributions defined at the business unit level.

## Understanding Manual Payment Transactions

As a tenant, you may receive a statement from a landlord for one or more nonrecurring charges for multiple leases. For example, if you are a retail tenant who operates more than one store in a large shopping complex. A separate lease would cover each store, but the landlord may combine the charges onto one statement. PeopleSoft Lease Administration enables you to manually enter these nonrecurring transactions into one payment that spans multiple leases. You can enter a single statement that you can assign to multiple leases and distribute those amount to multiple payees. You can allocate the charges by amount or percentage and distribute the charges using these methods:

- **Evenly:** The system divides the total amount by the number of selected leases and allocates an equal share of the charges to each lease.
- **By Area:** The system adds the total leased area for all of the selected leases and distributes the charges proportionally between the leases based on the area for each lease.
- **Manually:** You can assign the charges manually to each lease.

The total of the distributed amounts must equal the total of the statement.

After you allocate the individual amounts to each lease, you can send all of the resulting transactions to the transaction queue at one time. The system creates each of the transactions in pending status. You can edit or approve the transactions using the transaction queue. After you approve the transactions, you can run the Interface to AP/Billing process to post the transactions to PeopleSoft Payables.

## Transaction Status for Manual Payments

This diagram illustrates the transaction status process flow for manual payments.

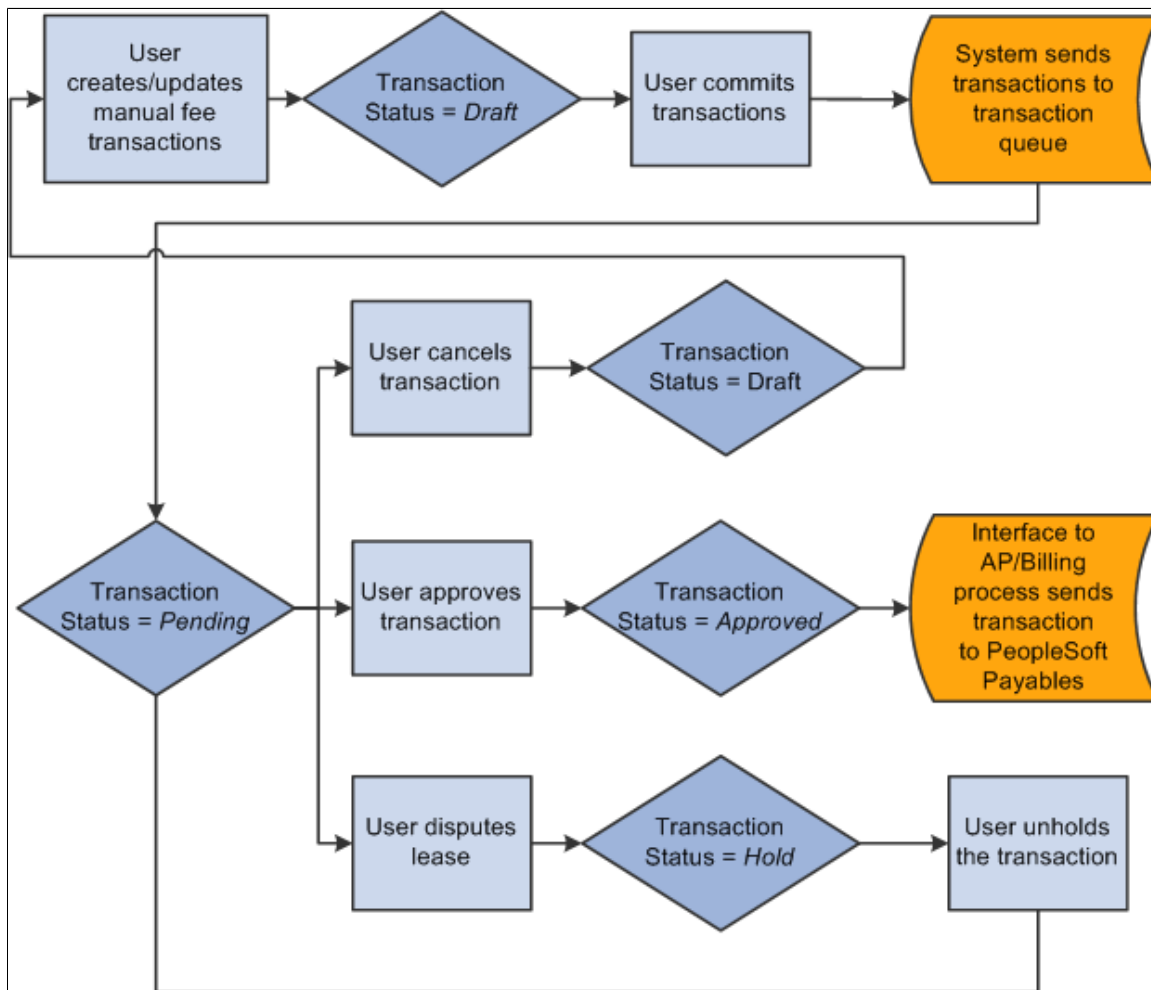

When you create manual transactions, the system sets each transaction to a status of *Draft*. You can modify, remove, or replace transactions while they are in draft status. After you commit the transactions, the system sets the status to *Pending*, and sends the transactions to the transaction queue. Use the Payment Transactions page to edit, hold, or approve the transactions.

If you dispute a lease, the system places all of its pending transactions in *Hold* status. If you cancel a manual fee transaction, the system returns the status of that transaction to *Draft*.

If you create the manual transactions as a group of transactions. After you commit the group of transactions, each transaction is processed individually. If the status of a transaction is updated, by either you or the system, only the transaction whose status changed is updated; the other transactions in the group are not affected.

## Payment Transactions - Create Payable Manual Fees Page

Use the Payment Transactions - Create Payable Manual Fees page (RE\_MFT\_MAIN) to add manual fees, distribute them amongst leases, and create multiple payment transactions.

Navigation:

**Lease Administration > Payables Leases > Create Manual Payables > Payment Transactions - Create Payable Manual Fees**

This example illustrates the fields and controls on the Payment Transactions - Create Payable Manual Fees page. You can find definitions for the fields and controls later on this page.

When you first create manual fee transactions, the page name is Create Payable Manual Fees page. After you save an exit the page, to access the information again, you access the Maintain Payable Manual Transaction page. The pages function similarly. Only the Create Payable Manual Fees page is shown. The status of the transactions control what you can edit on the page:

- If all of the transactions on this page are in *Draft* status, you can edit the entire page.
- If one or more of the transactions on this page are in *Draft* status, you can edit or delete the individual transactions or add new transactions.
- If all of the transactions on this page are in *Pending*, *Processed*, or *Error*, the page is display-only.

<b>Field or Control</b>	<b>Description</b>
<b>Add Charge</b>	Click to add a new manual fee. The system adds a row to the <b>Charge Details</b> grid.
<b>Accounting Distribution</b>	Click this link to access the accounting distributions page and override the accounting rules defined at the business unit.

<b>Field or Control</b>	<b>Description</b>
<b>Copy Manual Fee</b>	Click the Copy Manual Fee button to create a copy of the existing manual fee. The new manual fee will have a <i>Draft</i> transaction status irrespective of the status of the manual fee from which data was copied.
<b>Manual Fee Name</b>	Enter the manual fee name. The available manual fees are based on the active manual fee types.  See <a href="#">Defining Manual Fee Types</a> .
<b>Amount</b>	Enter the amount of the manual fee that you want to distribute between leases. You can enter positive or negative amounts, but the amounts that you enter must either be all positive or all negative. If you want to issue a charge and a credit for the same group of transactions, you must enter them on two different worksheets.
<b>Description</b>	Enter the description of the manual fee. This field is only for informational purposes.
<b>Accounting Distribution</b>	Click this link to access the accounting distributions page and override the accounting rules defined at the business unit.
<b>Calculate Total</b>	Click to calculate the total amount of manual fees. The system adds the values in the <b>Amount</b> field and populates the <b>Total Charges</b> field with the total amount.

### Add Lease By

<b>Field or Control</b>	<b>Description</b>
<b>Number</b>	Click to insert a new empty row into the <b>Transaction Details</b> grid. You can click the <b>Look up Lease Key</b> icon in the <b>Lease Number</b> column to search for a lease.
<b>Payee</b>	Click to transfer to the Maintain Payable Manual Transaction - Lease Search by Payee page on which you can search for leases by payees and select the leases to add to the <b>Transaction Details</b> grid.
<b>Property</b>	Click to transfer to the Manual Fees - Leased Property Search page on which you can search for leases by properties and select the leases to add to the <b>Transaction Details</b> grid.

<b>Field or Control</b>	<b>Description</b>
<b>Asset</b>	Click to transfer to the Manual Fees - Leased Asset Search page on which you can search for assets and select the assets to add to the <b>Transaction Details</b> grid.

### Distribute

<b>Field or Control</b>	<b>Description</b>
<b>Evenly</b>	Click to distribute the total charges evenly between the leases in the <b>Transaction Details</b> grid.
<b>By Area</b>	Click to distribute the total charges based on the proportional amount of rentable area by each lease in relation to the total area of all leases in the <b>Transaction Details</b> grid.

### Allocate By

<b>Field or Control</b>	<b>Description</b>
<b>Amount</b>	Select to use the <b>Amount</b> field to calculate the charges allocated to the lease transactions.
<b>Percent</b>	Select to use the <b>Percent</b> field to calculate the charges allocated to lease transactions.

### Transaction Details

<b>Field or Control</b>	<b>Description</b>
<b>Lease Number</b>	Enter the lease to which the transaction will be allocated. You can select from leases that are in <i>Active</i> , <i>Holdover</i> , or <i>Expired</i> status.
 <b>Details</b>	Click the <b>Details</b> icon for a lease to access the Payable Manual Fee - Transaction Details on which you can view a summary of the transaction details for that lease.
<b>Payee</b>	Enter the entity who to receive the payments. The system uses the landlord as the default. You can override this value.



<b>Field or Control</b>	<b>Description</b>
<b>Location</b>	Enter the location. You can override the default location of the lease.
<b>Transaction Status</b>	Displays the transaction status. The system initially creates each transaction with a status of <i>Draft</i> . After you commit the transactions, the system sets the status to <i>Pending</i> .
<b>Amount</b>	Enter the total amount of charges to allocate to this transaction. The sum of all the amounts that you enter must equal the total charges from the <b>Charge Details</b> amounts. You can enter positive or negative amounts, but the amounts that you enter must either be all positive or all negative. If you want to issue a charge and a credit for the same group of transactions, you must enter them on two different worksheets.
<b>Percentage</b>	Enter the percentage of the charges to allocate to this transaction. The sum of all of the percentages that you enter must equal <i>100</i> .
<b>Rentable Area</b>	Displays the total rentable area of the lease associated with the transaction.
<b>Revision History</b>	Click to access the Payable Manual Fee Transaction - Action History - Historic Details page to review the transaction history for a specific lease.
<b>Calculate Transaction Amounts</b>	Click to update the values in the <b>Manual Fee Group Transaction Summary</b> group box.

### Manual Fee Group Transaction Summary

<b>Field or Control</b>	<b>Description</b>
<b>Schedule Date</b>	Enter the date on which you want to schedule the transactions for payment.
<b>Invoice Number</b>	Enter the invoice number to be used when creating the voucher in payables.
<b>Total Charges</b>	Displays the total amount to be allocated. This field is the same as the <b>Total Charges</b> field near the top of the page.

<b>Field or Control</b>	<b>Description</b>
<b>Total Rentable Area</b>	Displays the total rentable area for the leases associated with these transactions. The systems sums all of the values from the <b>Rentable Area</b> column in the <b>Transaction Details</b> grid.
<b>Total Transaction Amount</b>	Displays the total amount of charges that you have allocated. The systems sums all of the values from the <b>Amount</b> column in the <b>Transaction Details</b> grid. This value must equal the value in the <b>Total Charges</b> field before you can commit the transactions.
<b>Allocated Percentage</b>	Displays the total percentage of charges that you have allocated. The systems sums all of the values from the <b>Percentage</b> column in the <b>Transaction Details</b> grid. This value must equal <i>100.00</i> before you can commit the transactions.
<b>Transaction Count</b>	Displays the number of transactions from the <b>Transaction Details</b> grid.
<b>Commit Transactions</b>	Click to process the transactions. The system validates the transactions, sets the transactions statuses to <i>Pending</i> and sends them to the transaction queue. The page becomes display-only.

## Overriding Accounting Distributions

Use the Accounting Distributions page (RE\_MFTGRP\_DST\_SEC) to override the accounting distributions defined at the business unit level.

Navigation:

Click the **Accounting Distributions** link on the Payment Transactions - Create Payable Manual Fees page.

This example illustrates the fields and controls on the Create Payable Manual Fees - Accounting Distributions page. You can find definitions for the fields and controls later on this page.

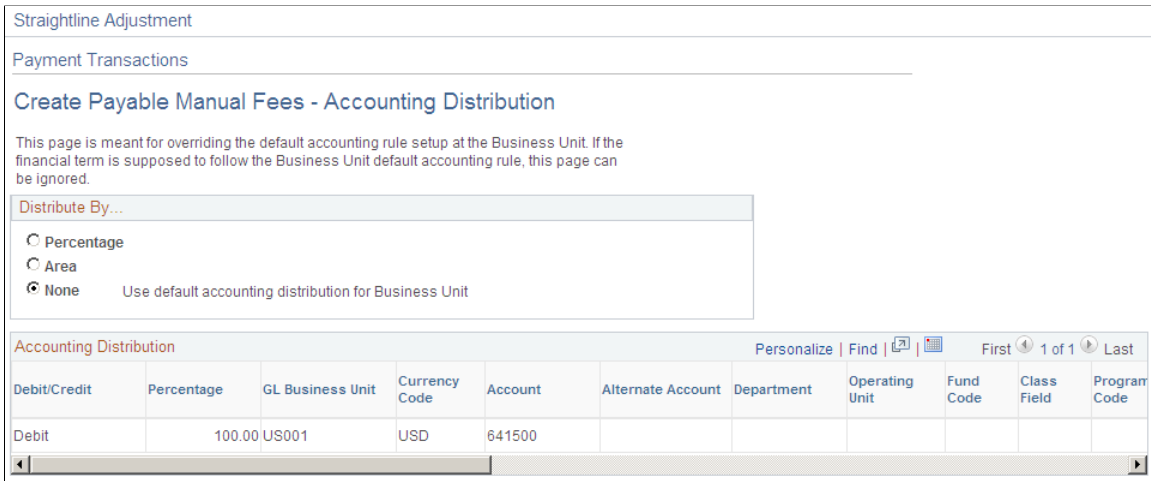

The fields on this page differ depending upon the distribution selected. When you select a value other than **None**, the ChartField values become available for edit.

<b>Field or Control</b>	<b>Description</b>
<b>Distribute By</b>	Select either: <ul style="list-style-type: none"> <li>• <b>Percentage:</b> Select this value to change the accounting distribution by percentage for each financial term.</li> <li>• <b>Area:</b> Select this value to change the accounting distribution by area for each financial term. The rent will be distributed based on the ratio of the areas.</li> <li>• <b>None:</b> Select this option to use the accounting distribution set up at the business unit level.</li> </ul>
<b>Add Distribution</b>	This button appears if you select <b>Percentage</b> or <b>Area</b> for the distribute by value.  Click this button to insert a new distribution row.
<b>Delete Distribution</b>	This button appears if you select <b>Percentage</b> or <b>Area</b> for the distribute by value.  Select a row and click this button to delete it from this page.
<b>Select</b>	This option appears if you select <b>Percentage</b> or <b>Area</b> for the distribute by value.  Select a row and click the <b>Delete Distribution</b> button to delete the distribution row.

<b>Field or Control</b>	<b>Description</b>
<b>Percentage</b>	<p>This field appears if you select <b>Percentage</b> for the distribute by value.</p> <p>Enter a percentage amount for this distribution line.</p> <p>Percentage amounts must equal 100% to be valid.</p>
<b>Area</b>	<p>This field appears if you select <b>Area</b> for the distribute by value.</p> <p>Enter the area for this distribution line.</p> <p>All lines must add up to the total rentable area for the lease to be valid.</p>
<b>Valid</b>	<p>Used to indicate a valid combination of ChartFields. When activating the lease, edit checking will be provided and the option will be selected for each row representing a valid combination of ChartFields. A lease cannot be activated until every accounting distribution is marked as valid.</p>

## Payment Transactions - Create Payable Manual Fees Page

Use the Payment Transactions - Create Payable Manual Fees page (RE\_TXN\_ADHOC\_SEC) to add manual fees and create single payment transactions.

Navigation:

**Lease Administration > Payables Leases > Maintain Lease > Financial Terms**

Click the **Create Payable Manual Fees** button.

This example illustrates the fields and controls on the Payment Transactions - Create Payable Manual Fees. You can find definitions for the fields and controls later on this page.

Manual Fee Transactions

---

Payment Transactions

---

### Create Payable Manual Fees

Business Unit US001      Transaction Currency USD      Unit of Measure Square Feet

---

Add Charge    Accounting Distribution

**Charge Details** Personalize | Find | |    First 1 of 1 Last

Manual Fee Name	Amount	Description	Accounting Distribution
<input style="width: 95%;" type="text"/>	0.00	<input style="width: 95%;" type="text"/>	Accounting Distribution <span style="float: right;"></span>

**Total Charges**      0.00      Calculate Total

---

**Transaction Details** Personalize | Find | |    First 1 of 1 Last

Transaction Details    Lease Details    Status Details

Lease Number	Lease Name	Payee	Ship To	Transaction Status
0000000101	REM2-OP EX	Mel's Diner	<input style="width: 95%;" type="text"/>	

**Manual Fee Group Transaction Summary**

Schedule Date

Invoice Number

Total Charges      0.00

Commit Transactions

---

Created By      Last Updated By  
Created On      Last Updated On

<b>Field or Control</b>	<b>Description</b>
<b>Schedule Date</b>	Enter the date on which you want to schedule the transactions for payment.
<b>Invoice Number</b>	Enter the invoice number, if you do not want the system to create one for you, to be used when creating the payment.
<b>Manual Fee Type</b>	Enter the manual fee type.
<b>Amount</b>	Enter the payment amount.

## Running the Interface to AP/Billing Process

This topic provides an overview of the Interface to AP/Billing process and discusses how to run the Interface to AP/Billing process.

## Page Used to Manage Interfaces to AP/Billing

<b>Page Name</b>	<b>Definition Name</b>	<b>Usage</b>
<u>Manage Interfaces to AP/Billing Page</u>	RUN_TXN_INTFC	Enter the run control parameters to generate transactions into PeopleSoft Payables to create vouchers and payments.

## Understanding the Interface to AP/Billing Process

PeopleSoft Lease Administration uses existing PeopleSoft Payables functionality to generate vouchers and payments to the landlords or payees. When you run the Interface to AP/Billing process, the system sends approved PeopleSoft Lease Administration payment information to the PeopleSoft Payables Voucher Build and Voucher Edit staging tables. After the information is sent, the PeopleSoft Payables application continues with the process flow by generating the vouchers and payments to the landlord and also generating the appropriate accounting information for posting to the general ledger.

The Interface to AP/Billing process populates four tables:

- Voucher Headers (VCHR\_HDR\_STG)
- Voucher Lines (VCHR\_LINE\_STG)
- Voucher Line Distributions (VCHR\_DIST\_STG)
- Voucher Payments (VCHR\_PYMT\_STG)

To populate these tables, this process groups the transaction details by each lease and inserts a voucher header for each lease and payee combination. A voucher line is created for every transaction detail for that lease and payee combination and the system inserts the distribution lines that correspond to those details. The distribution detail defaults from the Contract Accounting Rules process that uses the Lease Administration Accounting Rules setup and the transaction detail information, such as the transaction routing code.

The transaction routing code that is associated with a transaction detail also provides processing information that relates to withholding tax and sales and use taxes. Since the AP Voucher Build/Edit populates most of the information that is not provided by the interface, it is recommended that you set up the transaction routing codes using the *Default* option.

For example, if a payables business unit and supplier are set up to use withholding, the transaction routing code *Withholding* is set to let the PeopleSoft Payables system provide the applicable withholding code. The default can be set to *No* to avoid withholding on a specific transaction detail that is not subject to withholding. Setting a transaction routing code *Withholding* to *Yes* for sending transactions to a payables business unit that is not set to collect withholding tax, or for a supplier not subjected to withholding tax, places the generated voucher in Error/Recycle state as the necessary additional withholding information is not defaulted.

To create the vouchers in PeopleSoft Payables for the PeopleSoft Lease Administration transactions, PeopleSoft Payables runs the AP Voucher Build/Edit process, which takes the data from the staging tables after they are populated. This process uses the information provided in the tables, populates values for fields that were not populated, and verifies the integrity of the generated voucher. If any issues are found,

the voucher is set in error and can be reviewed online or recycled in batch. The voucher is not available for further processing until all errors are corrected.

---

**Note:** You can also use the Interface to AP/Billing process to generate invoices to tenants for receivables leases. When generating the process, consider setting up separate run control IDs for generating billing and payables transactions. If you use only one run control ID, the system generates all transactions for both invoices and payments.

---

## Prerequisites

Before you run the Interface to AP/Billing process, verify that transactions in the transaction queue are in *Approved* status.

## Manage Interfaces to AP/Billing Page

Use the Manage Interfaces to AP/Billing page (RUN\_TXN\_INTFC ) to enter the run control parameters to generate transactions into PeopleSoft Payables to create vouchers and payments.

Navigation:

**Lease Administration > Integrations > Manage Interface to AP/BI**

---

**Note:** As part of the shared product functionality, the Manage Interface to AP/Billing page can also be accessed through the Asset Management navigation as follows: Asset Management > Asset Transactions > Leased Assets > Manage Interface to AP/Billing.

---

This example illustrates the fields and controls on the Manage Interfaces to AP/Billing page. You can find definitions for the fields and controls later on this page.

The screenshot displays the 'Manage Interfaces to AP/Billing' page. At the top, there are navigation links for 'Run Control ID 1', 'Report Manager', and 'Process Monitor', along with a 'Run' button. Below this is a 'Request Parameters' section containing two input fields: 'Business Unit' and 'Lease Number', each with a magnifying glass icon. To the right of these fields are three radio button options for 'Invoice Date': 'Current Date' (selected), 'Schedule Date', and 'Custom Date'. Below the 'Request Parameters' section is an 'Interface Selection' section with two checkboxes: 'Payables' and 'Billing', both of which are currently unchecked.

<i>Field or Control</i>	<i>Description</i>
<b>Business Unit</b>	Enter a business unit to generate transactions that are specific to that business unit.
<b>Lease Number</b>	Enter a lease number to generate transactions for that lease. You must enter a business unit before you can enter a lease number.

### Interface Selection

<i>Field or Control</i>	<i>Description</i>
<b>Payables</b>	Select to send all payables transactions for the business unit and lease number parameters to the staging table. If you leave both fields blank, the system sends all approved transactions for payables leases to the payables staging table.
<b>Billing</b>	Select to send all billing transactions for the business unit and lease number parameters to the staging table. If you leave both fields blank, the system sends all approved transactions for receivables to the Billing staging table.  See <a href="#">Understanding the Interface to AP/Billing Process</a> .

---

## Viewing Pending Lease Payables

This topic discusses how to inquire about pending lease payables (also commonly referred to as the rent roll report).

PeopleSoft Lease Administration enables you to view the list of pending lease payables. This interactive inquiry enables you to filter the criteria and view all the active leases with pending payments and their schedules.

### Page Used to View Pending Lease Payables

<i>Page Name</i>	<i>Definition Name</i>	<i>Usage</i>
<a href="#">Pending Lease Payables Page</a>	RE_RENTROLL_INQ	Inquire on the pending payments for a lease. You can view the payment types and the scheduled date that the transaction is to be processed for all payments that are associated with the lease.



## Pending Lease Payables Page

Use the Pending Lease Payables page (RE\_RENTROLL\_INQ ) to inquire on the pending payments for a lease.

You can view the payment types and the scheduled date that the transaction is to be processed for all payments that are associated with the lease.

Navigation:

### Lease Administration > Reports > Pending Lease Payables

This example illustrates the fields and controls on the Pending Lease Payables page. You can find definitions for the fields and controls later on this page.

#### Pending Lease Payables

**Search Criteria**

\*Business Unit  US001 NEW YORK OPERATIONS

Due Date From  To

Lease Number

Lease Administrator

Portfolio Manager

Region

Pending Lease Payables									
Personalize   Find   View All   First 1-3 of 78 Last									
Lease Number	Schedule Number	Term	Schedule Date	Generated Date	Amount	Currency	Payee	Ship To	Schedule Status
0000000008	1	Base Rent	10/31/2000	07/07/2006	15500.00	USD	Western Life and Annuity		Generated
0000000008	2	Base Rent	11/30/2000	07/07/2006	15500.00	USD	Western Life and Annuity		Generated
0000000008	3	Base Rent	12/31/2000	07/07/2006	15500.00	USD	Western Life and Annuity		Generated

Enter the business unit and click **Search** to view all of the leases with pending payments and their schedules within that business unit. To view a filtered list, enter search criteria in the fields and click **Search**. Click **Clear** to clear all of the search criteria and results.

<b>Field or Control</b>	<b>Description</b>
<b>Due Date From and To</b>	Select the date range for pending transactions that are scheduled within that range.
<b>Lease Administrator</b>	Select to view pending transaction schedules that are associated with that lease administrator.
<b>Portfolio Manager</b>	Select to view pending transaction schedules that are associated with that portfolio manager.

## Pending Lease Payables

<b><i>Field or Control</i></b>	<b><i>Description</i></b>
<b>Term</b>	Displays the type of transaction that is scheduled. The term can be for base rent, operating expense, miscellaneous rent, and so on.
<b>Schedule Date</b>	Displays the date that the transaction is expected for payment.
<b>Generated Date</b>	Displays the date that the transaction generator processed the transaction and placed it into the transaction queue.
<b>Payee</b>	Displays the entity to whom the payment is made.
<b>Schedule Status</b>	Displays transaction schedule status, whether the transaction is pending, or was generated to the transaction queue.

# Analyzing Lease Administration Using PeopleSoft Insights

---

## Understanding PeopleSoft Insights for Lease Administration

PeopleSoft Insights is an analytical engine that provides visual reports (visualizations) in the form of charts, tables, graphs and so on. The visualizations are based on queries that retrieve data from the PeopleSoft Search Framework.

Dashboard administrators use PeopleSoft Insights and the underlying analytics engine to create both dashboards and visualizations, which are then attached to dashboards. The dashboard can contain multiple visualizations. The visualization and dashboard are objects in PeopleSoft Insights, which must be imported into the PeopleSoft application.

Typically, a PeopleSoft user who has the Search Administrator role performs these tasks:

- Imports dashboards.
- Configures dashboards as tiles or related information.
- Specifies user privileges for the dashboard.

End users access dashboards based on user privileges.

- Deploys dashboards.

---

**Note:** Oracle recommends that you do not modify or edit a delivered dashboard or visualization. You may copy a delivered visualization and then modify it as per your business requirements.

---

For more information, see *PeopleTools Search Technology*, “Working with Insights Dashboards for PeopleSoft Application Data”, Understanding Application Data and Insights Dashboards.

For more information about PeopleSoft Search Framework, see [Understanding PeopleSoft Insights Using PeopleSoft Search Framework](#).

---

## Setting up Insights Dashboards for Lease Administration

PeopleSoft Lease Administration delivers Insights dashboards to analyze Lease Administration data using different visualizations.

To set up Insights dashboards for Lease Administration:

1. Use the Deploy Search Definition page to deploy the search definition (PeopleTools, Search Framework, Administration, Deploy Search Objects).

The PeopleSoft Lease Administration search definitions are:

- EP\_RE\_PAYMENT\_INS (Lease Payment Insights dashboard)
- EP\_RE\_PAYMENT\_INS (Lease Payment Forecast dashboard)

See also “Search Definitions and Privileges” (Application Fundamentals) for a list of Lease Administration search definitions for PeopleSoft Insights dashboards.

2. Use the Schedule Search Index page to run the Build Index process (PeopleTools, Search Framework, Administration, Schedule Search Index).

The first time you run this process for a search index, you should always select *Full Index* as the **Indexing type**. You can run incremental indexes after that.

3. Use the Deploy Insights dashboards page to deploy the dashboard and the tile (PeopleTools, Search Framework, Administration, Deploy Insights Dashboards).

When you deploy a dashboard, you are copying the dashboard from the PeopleSoft database to your instance of PeopleSoft Insights. The deployed dashboard is then available on the Saved Objects page in the Management section on the Insights home page. Use the Deploy Insights Dashboards page to deploy or update a dashboard. For more information on Deploying a Dashboard, see PeopleTools:Search Technology, Working with Insights Dashboards for PeopleSoft Application Data, Deploying a Dashboard.

4. Use the “Personalize Homepage Page” (Application Fundamentals) to add the tile to a homepage.
5. Use the User Roles page to add the privileges to users (PeopleTools, Security, User Profiles, User Profiles).

The PeopleSoft Lease Administration privileges are:

- Insights LA Edit Privilege
- Insights LA View Privilege

See also “Search Definitions and Privileges” (Application Fundamentals) for a list of all product privileges for PeopleSoft Insights dashboards.

## Adding Lease Administration Tiles for Insights Dashboards

PeopleSoft Lease Administration has these tiles associated with Insights dashboards:

- Lease Payment Insights
- Lease Payment Forecast

For additional information about how to add a tile to a PeopleSoft Fluid Home page, see “Adding Homepages and Tiles” (Application Fundamentals) and *PeopleTools: Application User’s Guide*, “Working With PeopleSoft Fluid User Interface”, Working with Fluid Homepages and Dashboards, Managing Tiles on Fluid Homepages and Dashboards.

This example illustrates the Lease Payment Insights tile

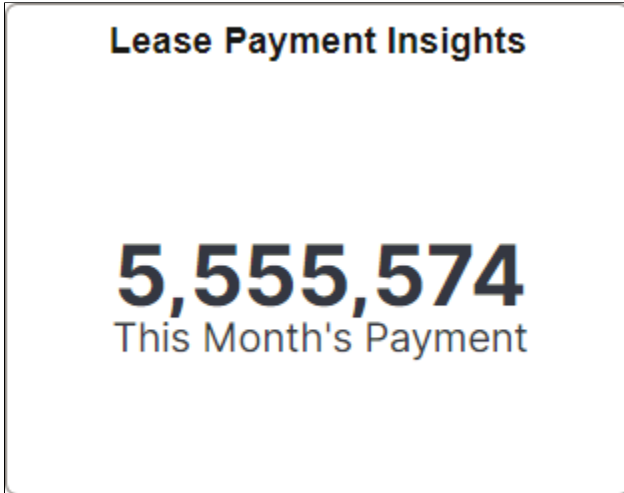

This example illustrates the Lease Payment Forecast tile

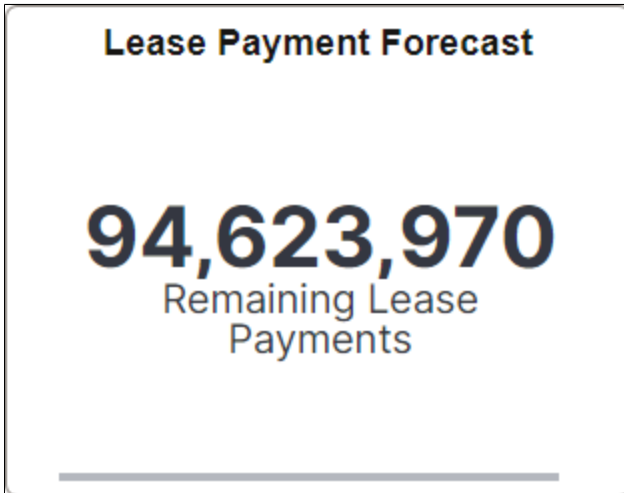

---

## Analyzing Lease Administration Using PeopleSoft Insights

This topic displays and explains how to analyze Lease Administration data using PeopleSoft Insights dashboards.

### Pages Used to Analyze Lease Administration Using PeopleSoft Insights

<i>Page Name</i>	<i>Definition Name</i>	<i>Usage</i>
<a href="#">Lease Payment Insights Dashboard</a>	EP_RE_PAYMENT_INS	Analyze lease payments, including obligation reduction and interest expense, and lease expirations.

<b>Page Name</b>	<b>Definition Name</b>	<b>Usage</b>
<u>Lease Payment Forecast Dashboard</u>	EP_RE_PAYMENT_INS	Analyze forecasted lease payments and obligation reduction between two dates, including totals by fiscal year for disclosure reporting.

## Lease Payment Insights Dashboard

Use the Lease Payment Insights dashboard to analyze an overview of the payable lease portfolio by providing valuable insights into payable lease payments and lease expirations.

The filters for this dashboard are included in the below table. Amounts will be displayed in the Business Unit’s base currency.

Navigation:

### Select the Lease Payment Insights tile

This example illustrates the fields and controls on the Lease Payment Insights Dashboard (1 of 2)

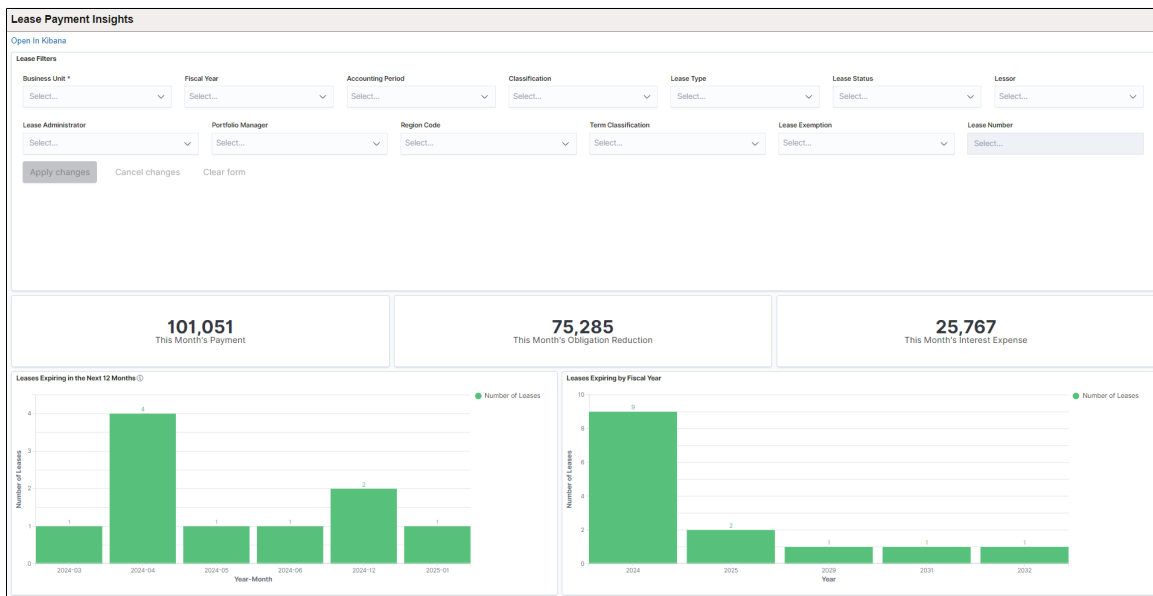

This example illustrates the fields and controls on the Lease Payment Insights Dashboard (2 of 2)

Lease Expirations in the Next 90 Days										
Business Unit	Lease Number	Name	Type	Status	Administrator	Lessor	Start Date	End Date	Lease Term	Remaining Term
US001	ATEST3	ATEST33	Office Lease	Active	Kenneth Schumacher	Ernie's Diner	01 Jan 2024	17 May 2024	4	2
US001	ATEST4	ATEST4	Office Lease	Active	Kenneth Schumacher	Ernie's Diner	01 Feb 2024	30 Apr 2024	3	2
US001	DEMO	Lease Demo	Office Lease	Active	Kenneth Schumacher	Ernie's Diner	01 Jan 2024	31 Mar 2024	3	1
US001	DEMO1	Lease Demo1	Office Lease	Active	Kenneth Schumacher	Ernie's Diner	01 Feb 2024	30 Apr 2024	3	2
US001	DEMO2	Demo Lease2	Office Lease	Active	Kenneth Schumacher	ELECTRONIC FUNDS TRANSFER - CONFIRMED	01 Feb 2024	30 Apr 2024	3	2
US001	OPTIONS	Lease Options	Office Lease	Active	Kenneth Schumacher	ELECTRONIC FUNDS TRANSFER - CONFIRMED	01 Jan 2024	30 Apr 2024	4	2

Export: Raw | Formatted

Lease Data											
Business Unit	Lease Number	Name	Classification	Type	Status	Administrator	Lessor	Start Date	End Date	Lease Term	Exempt
US001	000000146	Westbury Building Lease	Finance	Corporate Payables	Active	Kenneth Schumacher	Riger Services	01 Jan 2020	31 Dec 2029	120	No
US001	000000147	Brianward Building Lease	Finance	Corporate Payables	Active	Kenneth Schumacher	Riger Services	01 Jan 2021	31 Dec 2025	60	No
US001	000000148	Cranberry Building Lease	Finance	Corporate Payables	Active	Kenneth Schumacher	Riger Services	01 Jan 2023	31 Dec 2032	120	No
US001	000000149	Delasario Building Lease	Finance	Corporate Payables	Active	Kenneth Schumacher	Riger Services	01 Jul 2019	30 Jun 2024	60	No
US001	ATEST	ATESTTT NEW NEW OLD	Finance	Office Lease	Active	Kenneth Schumacher	ELECTRONIC FUNDS TRANSFER - CONFIRMED	01 Jan 2024	31 Dec 2024	12	No
US001	ATEST1	ATEST TEST AA	Finance	Office Lease	Active	Kenneth Schumacher	Ernie's Diner	01 Jan 2024	31 Dec 2024	12	No
US001	ATEST3	ATEST33	Finance	Office Lease	Active	Kenneth Schumacher	Ernie's Diner	01 Jan 2024	17 May 2024	4	No
US001	ATEST4	ATEST4	Finance	Office Lease	Active	Kenneth Schumacher	Ernie's Diner	01 Feb 2024	30 Apr 2024	3	No
US001	DEMO	Lease Demo	Finance	Office Lease	Active	Kenneth Schumacher	Ernie's Diner	01 Jan 2024	31 Mar 2024	3	No
US001	DEMO1	Lease Demo1	Finance	Office Lease	Active	Kenneth Schumacher	Ernie's Diner	01 Feb 2024	30 Apr 2024	3	No

Export: Raw | Formatted

The visualizations and data displayed on the Lease Payment Insights dashboard are based on values selected for the **Business Unit, Fiscal Year, and Accounting Period** filters, which are required.

You can further filter visualizations and data based on additional delivered filters, such as **Lessor, Lease Type, Lease Status**, and more.

Data can also be filtered by selecting any categorical data within a visualization (for example, an individual bar in a bar graph).

The following visualizations are part of this dashboard:

- *This Month's Payment*: Provides total payment amount for current month of all filtered leases.
- *This Month's Obligation Reduction*: Provides the total obligation reduction amount for the current month of all filtered leases.
- *This Month's Interest Expense*: Provides the interest expenses amount for the current month of all filtered leases.
- *Lease Expiring in the Next 12 Months*: Provides the number of leases expiring in the next 12 months period for all filtered leases.
- *Lease Expiring by Fiscal Year*: Provides the number of leases expiring in each fiscal year for all filtered leases.
- *Lease Expirations in the Next 90 Days*: Displays a detailed list of leases expiring in the next 90 days for all filtered leases. The list includes the start and end dates, total lease term, and the remaining term to expiry.
- *Lease Data*: Displays a detailed list of filtered leases making up the data shown in the visualizations.

Each visualization can be viewed separately in full screen. You can also drill down for more information using the **Inspect** option. That data can be downloaded as a comma separated value (CSV) file.

## Lease Payment Forecast Dashboard

Use the Lease Payment Forecast dashboard to forecast lease payments and lease obligation reductions annually.

Navigation:

**Select the Lease Payment Forecast tile**

This example illustrates the fields and controls on the Lease Payment Forecast Dashboard.

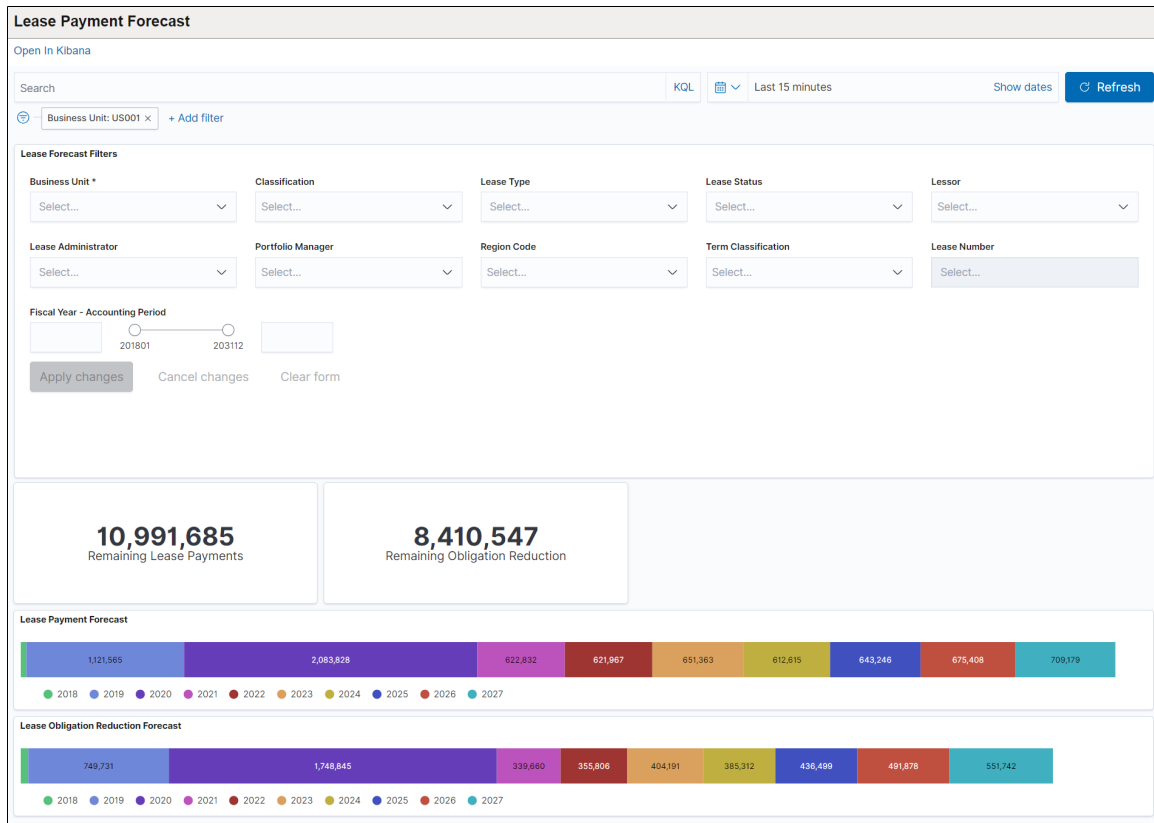

The visualizations and data displayed on the Lease Payment Forecast dashboard are based on the required filters selected for the **Business Unit** and between two Fiscal Years/Accounting Periods.

You can further filter visualizations and data based on additional delivered filters, such as **Lease Type**, **Lease Status**, **Lessor**, and more.

Data can also be filtered by selecting any categorical data within a visualization (for example, an individual bar in a bar graph).

The following visualizations are part of this dashboard:

- *Remaining Lease Payments*: Provides the total amount of remaining lease payments for the filtered leases.
- *Remaining Obligation Reduction*: Provides the total amount of remaining obligation reduction for the filtered leases.
- *Lease Payment Forecast*: Provides the year-by-year lease payment amounts between the selected periods for the filtered leases.
- *Lease Obligation Reduction Forecast*: Provides the year-by-year obligation reduction amounts between the selected periods for the filtered leases.



Each visualization can be viewed separately in full screen. You can also drill down for more information using the **Inspect** option. That data can be downloaded as a CSV file.



# Configuring Batch Processes

---

## Configuring Temporary Tables for Batch Processing

When you run batch processes in parallel, you risk data contention and deadlocks on temporary tables. To avoid this, PeopleTools enables you to dedicate specific instances of temporary tables for each process. When PeopleSoft Application Engine manages a dedicated temporary table instance, it controls the locking of the table before use and the unlocking of the table after use.

When you decide how many temporary table instances to dedicate for a process, consider the number of temporary tables that the process uses. More instances result in more copies of the temporary tables on the system. For example, if a process uses 25 temporary tables and you have 10 instances for a process, you will have 250 temporary tables on the system.

If you run processes in parallel and all of the dedicated temporary table instances are in use, the performance of the process decreases. You need to find a balance that works for your organization.

---

**Note:** When you specify the number of instances, PeopleSoft Application Designer displays a list of the temporary tables for the process. Use the list to determine how many temporary tables each process uses.

---

Specify how many temporary table instances to dedicate for each of the following batch processes that can run in parallel in PeopleSoft Lease Administration:

- Critical Date Notification Generator (RE\_CRDT\_GEN)

The Critical Date Notification Generator process uses these temporary tables:

- RE\_CDNT\_TAO
- RECDNTID\_TAO

- FAS-13 Schedule Generator (RE\_FASB\_GEN).

The FAS-13 schedule Generator process uses this temporary table (RE\_FASB\_TAO).

- Recurring Transactions Schedule Generator (RE\_GENTRANS).

The Recurring Transactions Schedule Generator process uses these temporary tables:

- RE\_GENDTL\_TAO
- RE\_GENTXN\_TAO
- RE\_PROVAR\_TAO
- RE\_TRMAMT\_TAO
- RE\_LS\_EXP\_TAO

- RE\_LSXB�\_TAO
- Send Billing Transactions to TBP (RE\_INTFC\_TBP).  
The Send Billing Transactions to TBP process uses these temporary tables:
  - RE\_INTFC\_TAO
  - RE\_TXN\_TAO
- Lease Admin Pagelet data (Summary Tables) Collector (RE\_PGLT\_DATA).  
The Lease Admin Pagelet Data (Summary Tables) Collector process uses this temporary table RE\_SPCUTL\_TAO.
- Request for Employee Location Assignments from CAFM (RE\_REQ\_ELOC).  
The Request for Employee Location Assignments from CAFM process uses this temporary table RE\_EMPLOC\_TAO.
- Request for Property Size and Occupancy from CAFM (RE\_REQ\_PROP).  
The Request for Property Size and Occupancy from CAFM uses this temporary table RE\_PROP\_TAO.
- Post FASB Schedules to GL (RE\_STGL\_POST).  
The Post FASB Schedules to GL process uses these temporary tables:
  - RE\_STGLS\_TAO
  - RE\_STGLT\_TAO
- Rent Variance Extract (RE\_RENT\_VAR)  
The Rent Variance Extract process uses these temporary tables:
  - RE\_PRIRNT\_TAO
  - RE\_PRIVAL\_TAO
  - RE\_RNTSCH\_TAO
  - RE\_RNTTRM\_TAO
  - RE\_RNTTXN\_TAO
  - RE\_RNTVAR\_TAO

The PeopleTools documentation discusses the usage of temporary tables in detail and describes how to specify the number of instances.

If you run any of the PeopleSoft General Ledger COBOL processes, you should also configure the temporary tables for those processes. The PeopleSoft General Ledger documentation discusses how to do this in detail.

*PeopleTools: Application Engine*



# Scenarios for PeopleSoft Lease Administration

---

## Understanding Troubleshooting

The scenarios explained here are examples of how to use some of the features within PeopleSoft Lease Administration. These real-life examples describe some of the intended uses of these features, enabling you to understand how these features might be applied to your own organization.

---

**Note:** The real-life scenarios described within this documentation may not conform to the business rules and procedures within your organization. Do not construe these examples as consulting or implementation advice for your specific industry or your individual organization. You should adapt or disregard the information here based on the needs of your organization. Oracle does not guarantee that the information included here will work as intended within your environment.

---

## Scenario: Set up for Creating a Contract from a Lease

Lease Administration is integrated with PeopleSoft Billing through the Transaction Billing Processor which is owned by PeopleSoft Contracts. In a background process, the system will create a contract for every receivables when the lease is activated. It is through this contract that the lease establishes the integration to PeopleSoft Billing. The following sections describe the one-time setup required for the contract to be created when a receivables lease is activated.

### Bill Cycle Page

The ON-DEMAND bill cycle needs to be setup prior to use. If this is not setup an error, will occur during lease activation.

Access the Bill Cycle page (Set Up Financials/Supply Chain, Product Related, Billing, Setup, Bill Cycle)

This example illustrates the fields and controls on the Bill Cycle page. You can find definitions for the fields and controls later on this page.

**Bill Cycle**

Cycle ID ON-DEMAND

\*Status

Short Description

Description

---

**Recurring Bill Parameters**

Schedule

Bill Generation Date Basis

Invoice Date Default

Bill Generation Lead Days

---

**Installment Bill Parameters**

Schedule

Bill Generation Date Basis

Invoice Date Default

Bill Generation Lead Days

## Lease Administration Business Unit Setup

There are three fields to be setup in RE Business Unit under billing defaults:

- **Billing Type:** This value is prompted from PeopleSoft Billing setup. If this value is left blank, this value will be populated from the PeopleSoft Contracts business unit setup. If you do not enter this value in the PeopleSoft Contracts business unit setup, the system will raise an error when the user activates the lease.
- **Bill Source:** This value is prompted from PeopleSoft Billing setup. If this value is left blank, this value will be populated from the PeopleSoft Contracts business unit setup. If you do not enter this value in the PeopleSoft Contracts business unit setup, the system will raise an error when the user activates the lease.
- **Bill By:** This value is prompted from PeopleSoft Billing setup. This value can be blank on the PeopleSoft Contracts business unit setup also.

Access the Lease Administration Business Unit – Transaction Settings page (Set up Financials/Supply Chain, Business Unit Related, Lease Administration, LA Business Unit Definition, Transaction Settings)



This example illustrates the fields and controls on the Lease Administration Business Unit – Transaction Settings page. You can find definitions for the fields and controls later on this page.

General	Transaction Settings	Options and Critical Dates
Business Unit Definition - Lease Administration Lease Administration Business Unit Definition - US001		
Business Unit US001		
<b>Billing Options</b> Lead Time (Days) <input type="text" value="10"/> <input checked="" type="checkbox"/> Auto Approve Straightline Accounting Routing Codes: *Accrual <input type="text" value="FASB_R_ACCRUAL"/> *Deferral <input type="text" value="FASB_R_DEFERRAL"/> *Adjustment <input type="text" value="FASB_R_ADJUST"/>		<b>Accounts Payable Options</b> Lead Time (Days) <input type="text" value="10"/> <input type="checkbox"/> Auto Approve Straightline Accounting Routing Codes: *Accrual <input type="text" value="FASB_P_ACCRUAL"/> *Deferral <input type="text" value="FASB_P_DEFERRAL"/> *Adjustment <input type="text" value="FASB_P_ADJUST"/>
<b>Item Routing Codes</b> *Base Rent <input type="text" value="RENT"/> Security Deposits: *Issue <input type="text" value="SECDEP_ISSUE"/> *Deduction <input type="text" value="SECDEP_DED"/> *Interest <input type="text" value="SECDEP_INTEREST"/> *Refund <input type="text" value="SECDEP_REFUND"/>		
<b>Group Routing Codes</b> *Operating Expenses <input type="text" value="OPEX_DEFAULT"/> *Percent Rent <input type="text" value="PRENT_DEFAULT"/> *Miscellaneous Rent <input type="text" value="MISC_DEFAULT"/> *Manual Fees <input type="text" value="MAN_DEFAULT"/>		
<b>Billing Defaults</b> Billing Type <input type="text" value="RE"/> Bill Source <input type="text" value="SERVICE"/> Bill By <input type="text" value="CONTRACT"/>		

## Contracts Business Unit Setup

On the Contracts Business Unit – BU Definition page, you must enter a valid BI Unit.

Access the Contracts Business Unit – BU Definition page (Set Up Financials/Supply Chain, Business Unit Related, Contracts, Contracts Definition)

This example illustrates the fields and controls on the Contracts Business Unit – BU Definition page. You can find definitions for the fields and controls later on this page.

<b>BU Definition</b>		Defaults	Processing Options	Fee Definition
Business Unit		US001		
Description		US001 NEW YORK OPERATIONS		
Short Desc		US001		
<b>Integration</b>				
GL Unit	US001	US001 NEW YORK OPERATIONS		
OM Unit	US001	US001 NEW YORK OPERATIONS		
BI Unit	US001	US001 NEW YORK OPERATIONS		
<b>Currency</b>		<b>Security</b>		
Currency Code	USD	<input type="checkbox"/> Enforce Contract Status Security <input checked="" type="checkbox"/> Delete Internal Notes <input checked="" type="checkbox"/> Update Internal Notes		
Rate Type	CRRNT			

On the Contracts Business Unit – Defaults page, select *REALESTATE* for the **Bill Source** value.

The bill source is used to create the bill plan for the contract that is created when a receivables lease is activated. This bill plan is used by the transaction billing processor to perform bill processing for Lease Administration transactions for the lease. It does not need to be a specific value, but a value must be selected for this field, either in the Contracts business unit setup or in the Lease Administration business unit setup. If no values for the Bill Type and Bill Source are found in the Lease Administration business unit setup then the values setup in the Contracts business unit setup will be used. If the Bill Type is not setup, an error will occur when the lease is activated.

Access the Contracts Business Unit – Defaults page (Set Up Financials/Supply Chain, Business Unit Related, Contracts, Contracts Definition, Defaults)

This example illustrates the fields and controls on the Contracts Business Unit – Defaults page. You can find definitions for the fields and controls later on this page.

<a href="#">BU Definition</a>	<b>Defaults</b>	<a href="#">Processing Options</a>	<a href="#">Fee Definition</a>
Business Unit US001		US001 NEW YORK OPERATIONS	
<b>Contract</b>			
Contract Admin	<input type="text" value="Angelini, Gina"/>		
Contract Type	<input type="text" value="COMMERCIAL"/>	Commercial Construction	
Dist Rule Code	<input type="text" value="CONTRACTS"/>	Contracts Distribution Rule	
Unbilled AR	<input type="text" value="AR-UNBILL"/>	Unbilled Accounts Receivable	
Legal Entity	<input type="text" value="USLE1"/>	US Legal Entity	
<b>Billing Plan</b>			
Bill Type	<input type="text" value="CA"/>	CONTRACTS	
Bill Source	<input type="text" value="CONTRACTS"/>	Contracts	
<b>Taxes</b>			
Ship From	<input type="text" value="US001"/>	USA - New York	
<b>Prepays</b>			
Prepaid Tax Timing	<input type="text"/>		
Billing Plan Template	<input type="text"/>		
Bill Plan Detail Template ID	<input type="text"/>		
Deferred Revenue	<input type="text"/>		
<input type="checkbox"/> Utilize Against all Lines			
<b>Progress Payment Rates</b>			
Progress Payment Rate	<input type="text"/>	%	
Liquidation rate	<input type="text"/>	%	
<b>Contracts Workbench Template</b>			
Workbench Template ID	<input type="text" value="CONTRACTS"/>	CONTRACTS	

## Customer Validation

You must verify that the customers are available for selection from the Bill to Customer ID field Prompt for the Bill Plan in PeopleSoft Contracts. This field (BILL\_TO\_CUST\_ID) is driven by the PeopleSoft Billing Business unit. The billing business unit is defined on the Contracts Business Unit Definition page.

To verify the information is defined correctly:

1. Navigate to the Customer Contracts – General Information page (Customer Contracts, Create and Amend, General Information).
2. Add a new contract and enter at least one line.

3. Save the contract.
4. Click the **Billing Plans** link.
5. Select a contract line and assign a billing plan *B101*.
6. Click the Bill To Customer prompt and verify your customers are available for selection. If a customer is not visible in this prompt, verify that the PeopleSoft Billing business unit is mapped to the same SetID as the customer.

## Contract Status Setup

Because PeopleSoft Contracts does not allow the creation of an active processing status as a default value, you will need to follow the steps in the following workaround:

1. Access the Contract Status page (Set Up Financials/Supply Chain, Contracts, General Options, Contract Status).
2. Add a new value. Use *ACTIVE* as the contract status.
3. Add a description and select the **Pending** processing status.
4. The Default option will now appear on the page. Select this option.
5. Select the **Active** processing status.

---

**Note:** Do not deselect the **Default** option.

---

6. Click **Save** and ignore any warning messages received.

## Unit of Measure Setup

If the UOM is not setup, the system will display an error during lease activation. Navigate to Set Up Financials/SupplyChain, Common Definitions, Units of Measure, Units of Measure to define these values.

## Chapter 25

# PeopleSoft Lease Administration Reports

## PeopleSoft Lease Administration Reports: A-Z

<i>Report ID and Report Name</i>	<i>Description</i>	<i>Navigation</i>	<i>Run Control Page</i>
RE_CRITICDT_INQ Critical Dates Inquiry	View the online inquiry of critical dates and associated options. The critical dates inquiry page is a summary reminder of important tasks requiring action by a specific date. This interactive report supports the business process for options and critical dates.  See <a href="#">Options and Critical Dates Page</a> .	<b>Lease Administration &gt; Reports &gt; Critical Dates Inquiry</b>	Not Applicable
RE_LS_ABSTRACT Lease Abstract	Displays a summary of the lease terms and conditions entered into the system. This report supports the business process of creating lease abstracts.  This report is the same as the Lease Abstract Worksheet below, but is populated with the lease information, as opposed to a blank worksheet.  See <a href="#">Understanding Lease Abstracts</a> .	<b>Lease Administration &gt; Reports &gt; Lease Abstract</b>	Not Applicable
RE_ABS_WRKSHEET Lease Abstract Worksheet	Displays a blank copy of the lease abstract worksheet. This report is used to manually capture terms and conditions of a lease to enter into the system. This interactive report supports the business process of creating lease abstracts.  See <a href="#">Understanding Lease Abstracts</a> .	<b>Lease Administration &gt; Reports &gt; Lease Abstract Worksheet</b>	Not Applicable

<b>Report ID and Report Name</b>	<b>Description</b>	<b>Navigation</b>	<b>Run Control Page</b>
RE_LEASE_INQ Lease Inquiry - Payables Lease	View the online inquiry of general terms and the financial summary for payables leases. This report supports the business process for creating and maintaining leases.  See <a href="#">Reviewing Basic Lease Information</a> .	<b>Lease Administration &gt; Payables Leases &gt; Payables Lease Inquiry</b>	Not Applicable
RE_LEASE_INQ Lease Inquiry - Receivables Lease	View the online inquiry of general terms and the financial summary for receivables leases. This interactive report supports the business process for creating and maintaining leases.  See <a href="#">Reviewing Basic Lease Information</a> .	<b>Lease Administration &gt; Receivables Lease &gt; Receivables Lease Inquiry</b>	Not Applicable
RE_LEASE_PROP Leased Property Report	Select properties on this interactive report to view all payables and receivables leases associated with those properties.	Lease Administration, Reports, Leased Property Report	Not Applicable
RE_MIN_LS_INQ Minimum Future Lease Obligation	Displays the lease-related financial obligations of the tenant. Minimum Future Lease Obligations is used to review and report all future rent obligations that, as of the date of preparing the report (usually at the end of the fiscal year), your organization is committed to pay. This report appears in the notes to the financial statements.  Minimum Lease Obligation report can also be viewed as a pivot grid on a pagelet on the user's home page.  See <i>PeopleTools: Pivot Grid</i> .	<b>Lease Administration &gt; Reports &gt; Minimum Lease Obligation</b>	RE_MIN_LS_INQ

<b>Report ID and Report Name</b>	<b>Description</b>	<b>Navigation</b>	<b>Run Control Page</b>
RE_RENTROLL_INQ Pending Lease Payables	View the online inquiry of pending payables lease payments and their schedules. This interactive report supports the business process for processing payments for payables leases.  <b>Note:</b> Commonly referred to as a rent roll report.  See <a href="#">Viewing Pending Lease Payables</a> .	<b>Lease Administration &gt; Reports &gt; Pending Lease Payables</b>	Not Applicable
RE_RECEIVABLE_INQ Pending Lease Receivables	View the online inquiry of pending lease receivables invoices and schedules. This interactive report supports the business process for processing invoices for receivables leases.  See <a href="#">Viewing Pending Lease Receivables</a> .	<b>Lease Administration &gt; Reports &gt; Pending Lease Receivables</b>	Not Applicable
RE_PROP_INQ Property Information	View the online inquiry of basic property information such as the business unit, site, location, building, country, floor, state/province, area, city, space, and property class.	<b>Lease Administration &gt; Reports &gt; Property Information</b>	RE_PROP_INQ
RE_OCCUPANT_RPT Property Occupants Report	View a list of all occupants for a property and basic information such as move in and move out date.	<b>Lease Administration &gt; Reports &gt; Property Occupants Report</b>	RE_OCCUPANT_RPT
RE_RENT_VAR Rent Variance Extract	Extract and compute recurring rent variance data for the Rent Variance report.	<b>Lease Administration &gt; Integrations &gt; Rent Variance Extract</b>	RE_RENTVAR_EXTRACT

<b>Report ID and Report Name</b>	<b>Description</b>	<b>Navigation</b>	<b>Run Control Page</b>
RE1001-.RPT Rent Variance Report	Compare the rent amounts between the current period and the prior period, view the variances in the payments, and also view indicators for justifying variance.  <hr/> <b>Note:</b> You must run the Rent Variance Extract Application Engine process to process the new recurring transactions before you run the Rent Variance report.	<b>Lease Administration &gt; Reports &gt; Variance Report</b>	RE_RENTVAR_REPORT <b>Report</b>
RE1000-.RPT Reported Sales Report	Displays the complete contents of the Percent Rent sales reporting worksheet transactional tables. This interactive report supports the business process for percent rent sales reporting.  See <a href="#">Understanding Percent Rent Terms</a> .	<b>Lease Administration &gt; Reports &gt; Reported Sales Report</b>	RE_RPTDSALESINQ