PeopleSoft FSCM 9.2: PeopleSoft Manufacturing

July 2024

This software and related documentation are provided under a license agreement containing restrictions on use and disclosure and are protected by intellectual property laws. Except as expressly permitted in your license agreement or allowed by law, you may not use, copy, reproduce, translate, broadcast, modify, license, transmit, distribute, exhibit, perform, publish, or display any part, in any form, or by any means. Reverse engineering, disassembly, or decompilation of this software, unless required by law for interoperability, is prohibited.

The information contained herein is subject to change without notice and is not warranted to be error-free. If you find any errors, please report them to us in writing.

If this is software, software documentation, data (as defined in the Federal Acquisition Regulation), or related documentation that is delivered to the U.S. Government or anyone licensing it on behalf of the U.S. Government, then the following notice is applicable:

U.S. GOVERNMENT END USERS: Oracle programs (including any operating system, integrated software, any programs embedded, installed, or activated on delivered hardware, and modifications of such programs) and Oracle computer documentation or other Oracle data delivered to or accessed by U.S. Government end users are "commercial computer software," "commercial computer software documentation," or "limited rights data" pursuant to the applicable Federal Acquisition Regulation and agency-specific supplemental regulations. As such, the use, reproduction, duplication, release, display, disclosure, modification, preparation of derivative works, and/or adaptation of i) Oracle programs (including any operating system, integrated software, any programs embedded, installed, or activated on delivered hardware, and modifications of such programs), ii) Oracle computer documentation and/or iii) other Oracle data, is subject to the rights and limitations specified in the license contained in the applicable contract. The terms governing the U.S. Government's use of Oracle cloud services are defined by the applicable contract for such services. No other rights are granted to the U.S. Government.

This software or hardware is developed for general use in a variety of information management applications. It is not developed or intended for use in any inherently dangerous applications, including applications that may create a risk of personal injury. If you use this software or hardware in dangerous applications, then you shall be responsible to take all appropriate fail-safe, backup, redundancy, and other measures to ensure its safe use. Oracle Corporation and its affiliates disclaim any liability for any damages caused by use of this software or hardware in dangerous applications.

Oracle®, Java, MySQL, and NetSuite are registered trademarks of Oracle and/or its affiliates. Other names may be trademarks of their respective owners.

Intel and Intel Inside are trademarks or registered trademarks of Intel Corporation. All SPARC trademarks are used under license and are trademarks or registered trademarks of SPARC International, Inc. AMD, Epyc, and the AMD logo are trademarks or registered trademarks of Advanced Micro Devices. UNIX is a registered trademark of The Open Group.

This software or hardware and documentation may provide access to or information about content, products, and services from third parties. Oracle Corporation and its affiliates are not responsible for and expressly disclaim all warranties of any kind with respect to third-party content, products, and services unless otherwise set forth in an applicable agreement between you and Oracle. Oracle Corporation and its affiliates will not be responsible for any loss, costs, or damages incurred due to your access to or use of third-party content, products, or services, except as set forth in an applicable agreement between you and Oracle.

Documentation Accessibility

For information about Oracle's commitment to accessibility, visit the Oracle Accessibility Program website at <https://docs.oracle.com/pls/topic/lookup?ctx=acc&id=docacc>.

Access to Oracle Support

Oracle customers that have purchased support have access to electronic support through My Oracle Support. For information, visit <https://docs.oracle.com/pls/topic/lookup?ctx=acc&id=info> or visit <https://docs.oracle.com/pls/topic/lookup?ctx=acc&id=trs> if you are hearing impaired.

Contents

- Preface: Preface.....xix**
 - Understanding the PeopleSoft Online Help and PeopleBooks..... xix
 - Hosted PeopleSoft Online Help..... xix
 - Locally Installed PeopleSoft Online Help..... xix
 - Downloadable PeopleBook PDF Files.....xix
 - Common Help Documentation.....xix
 - Field and Control Definitions..... xx
 - Typographical Conventions..... xx
 - ISO Country and Currency Codes.....xxi
 - Region and Industry Identifiers..... xxi
 - Translations and Embedded Help.....xxii
 - Using and Managing the PeopleSoft Online Help.....xxii
 - PeopleSoft FSCM Related Links..... xxii
 - Contact Us.....xxii
 - Follow Us.....xxiii
- Chapter 1: Getting Started with PeopleSoft Manufacturing..... 25**
 - Your Enterprise Data Flow..... 25
 - Recognizing Your Business Structure..... 25
 - PeopleSoft Manufacturing Integrations..... 28
 - PeopleSoft Manufacturing Implementation..... 32
 - Oracle's PeopleSoft Products..... 37
 - PeopleSoft Application Fundamentals..... 38
 - Pages With Deferred Processing..... 38
 - Common Elements Used in This Documentation..... 38
- Chapter 2: Understanding PeopleSoft Manufacturing..... 41**
 - PeopleSoft Manufacturing..... 41
 - Solutions for Production Management Challenges..... 41
 - PeopleSoft Manufacturing Production Management Business Solution Applications..... 41
 - Solutions for Product Development Challenges..... 44
 - Robust Functionality..... 45
 - Integrated Process-Oriented Solution..... 45
 - Suite of PeopleSoft Product Development Business Solution Applications..... 45
 - Support for the Consumer Product Industry..... 47
 - Flow Production..... 47
 - Discrete Manufacturing..... 48
 - Repetitive Manufacturing..... 48
 - Configure to Order..... 49
 - Third-Party Integration..... 49
 - Integration with Item Content Providers..... 49
 - Integration with Other Product Data Management Systems..... 50
 - Integration with Product Life Cycle Applications..... 50
 - Integration with Manufacturing Execution Systems..... 50
 - Integration with Electronic Data Collection Systems..... 51
 - Additional Manufacturing Functionality..... 52
 - Item Substitution..... 52
 - Component Use Up..... 54

Rounding Rules in Manufacturing.....	55
Quantity Rounding Exceptions in PeopleSoft Manufacturing.....	56
Rework.....	56
Teardown.....	57
Yield by Operation.....	58
Serial Genealogy.....	58
Chapter 3: Defining Your Business Unit Structure.....	59
Understanding Business Unit Structures.....	59
Prerequisite.....	59
Establishing Manufacturing Business Units.....	59
Pages Used to Establish Manufacturing Business Units.....	59
Business Unit Definition Page.....	60
MFG Business Unit Options Page.....	61
MFG BU Prdn Options Page.....	65
Auto Revision Scheme Page.....	69
BOM Message Defaults Page.....	70
Chapter 4: Establishing Production Calendars.....	73
Understanding Production Calendars.....	73
Using Production Calendar Codes.....	73
Process to Define Production Calendar Codes.....	74
Scheduling Hierarchy to Determine Available Production Time.....	74
Assigning Calendar Codes to Business Units, Work Centers, and Resources.....	75
Defining Shift Codes.....	75
Page Used to Define Shift Codes.....	76
Shift Code Definition Page.....	76
Establishing Business Unit Calendars.....	77
Pages Used to Establish Business Unit Calendars.....	78
Work Week Definition Page.....	78
Default Prdn Calendar Week Page.....	79
Understanding Production Calendar Codes.....	80
Calendar Code Definition Page.....	81
Creating Run Time Calendars.....	83
Page Used to Create Run Time Calendars.....	83
Create Calendars Page.....	83
Chapter 5: Integrating with Third-Party Systems.....	85
Integrating with an Electronic Data Collection System.....	85
Integrating with an Item Content Provider.....	86
Understanding Item Content Provider Transactions.....	87
Integrating with a Product Data Management System.....	88
Understanding Product Data Management.....	88
Integrating with a Manufacturing Execution System.....	89
Overview of Manufacturing Execution System Transactions.....	89
Using Manufacturing Execution System Transactions.....	90
Integrating with Product Life Cycle Management Applications.....	91
Chapter 6: Integrating Oracle's PeopleSoft Manufacturing with Product Life Cycle Management Applications Using PDX 1.0 XML.....	93
Understanding the PDX Integration.....	93
Understanding the Required Setup and Considerations for Integration.....	94
Prerequisites.....	95
Setting Up PeopleSoft Manufacturing for Use with a Product Life Cycle Management Application.....	96

Pages Used to Set Up PeopleSoft Manufacturing to Integrate with a Product Life Cycle Management Application..... 96

Installation Options - Manufacturing Page..... 98

Service Operations - General Page..... 101

Routing Definitions Page..... 102

Setting Up and Running the Daemon Group and Related Job to Process Inbound PDX Files... 104

Reviewing and Correcting PDX Change Order Exceptions..... 107

Pages Used to Review and Correct PDX Change Order Exceptions..... 108

Understanding Change Order Exceptions..... 108

PDX Change Order Exceptions Page..... 109

PDX Change Order Exceptions - Error Detail Page..... 110

Completed by Change Order Page..... 111

Correcting Change Order Errors..... 111

Reviewing Important Implementation and End-User Guidelines..... 113

Chapter 7: Understanding PeopleSoft Bills of Material and Routings..... 115

Bills of Material..... 115

Manufacturing Bills of Material..... 116

Engineering Bills of Material..... 117

Planning Bills of Material..... 117

Importing Bills of Material from External Sources..... 118

Routings, Tasks, Work Centers, and Resources..... 118

Routings..... 118

Tasks..... 119

Work Centers..... 119

Resources..... 120

How It All Fits Together..... 121

Chapter 8: Maintaining Bills of Material..... 123

Understanding BOM Maintenance..... 123

Common Elements Used in Bills of Material..... 123

Prerequisites..... 123

Defining BOM Items..... 124

Maintaining BOMs by Revisions or Effectivity Dates..... 125

Page Used to Maintain BOMs by Revision or Effectivity Date..... 125

MFG Business Unit Options Page..... 125

Creating Rework BOMs..... 131

Using Multiple-Output BOMs..... 131

Assigning Associated Primary BOMs..... 132

Specifying the Calculated BOM QPA Precision..... 132

Defining and Maintaining Revisions..... 133

Pages Used to Define and Maintain Revisions..... 133

REV Maintenance - Detail Page..... 134

REV Maintenance - Attachments Page..... 136

Maintaining BOMs..... 137

Pages Used to Maintain BOMs..... 138

Common Elements Used in This Section..... 139

Manufacturing BOMs - Summary Page..... 140

Header: Assembly Attachments Page..... 147

Header: Outputs Page..... 148

Header: Supplier Access List Page..... 154

Header: Send Email to Suppliers - New Message Page..... 155

Components: Component Details Page..... 157

Components: Reference Designators Page.....	162
Components: Dimensions Page.....	163
Components: Substitutes Page.....	163
Components: Copy Business Unit Substitute Items Page.....	165
Copying and Deleting BOMs.....	165
Pages Used to Copy and Delete BOMs.....	165
Copy BOM Page.....	166
Copy BOM Detail Page.....	168
Copy Outputs Page.....	171
Delete BOMs Page.....	171
Verifying BOMs.....	172
Pages Used to Verify BOMs.....	172
BOM Verification Page.....	172
Delete BOM Verification Rows Page.....	173
Defining BOM, ECR, and ECO Access by Supplier.....	174
Page Used to Define BOM, ECR, and ECO Access Privileges for Suppliers.....	175
BOM Access by Supplier Page.....	175
Chapter 9: Making Mass BOM Changes.....	177
Understanding Mass BOM Changes.....	177
Defining BOM Mass Maintenance Codes.....	177
Pages Used to Define BOM Mass Maintenance Codes.....	178
Understanding BOM Mass Maintenance Codes.....	179
Prerequisites.....	179
Search Page.....	180
Manufacturing Assembly/Component Matches Page.....	182
Search - Reference Designator Page.....	183
Component Substitutes - Search Page.....	183
Change Page.....	184
Change - Dimensions Page.....	188
Change - Reference Designators Page.....	188
Change - Substitutes Page.....	188
Add Page.....	190
Add - Substitutes Page.....	192
Making BOM Mass Changes and Creating Automatic Revisions.....	193
Pages Used to Make Mass Changes Using Mass Maintenance Codes.....	193
Mass Maint Code Options Page.....	194
Assembly Item Options Page.....	196
Selecting Assemblies by Items Where Used Page.....	196
Mass Maint Except Page.....	198
Viewing and Correcting Mass Maintenance Staged BOMs.....	199
Pages Used to View and Correct Mass Maintenance Staged BOMs.....	199
Update Staged BOM Details - BOM Status Page.....	200
Update Staged BOM Details - Summary Page.....	202
Update Staged BOM Details - Header: Outputs Page.....	202
Processing Staged BOMs.....	203
Page Used to Process Staged BOMs.....	203
Process Staged BOMs Page.....	203
Chapter 10: Displaying Bills of Material.....	207
Understanding Display of BOMs.....	207
Common Elements Used in Display of Bills of Material.....	207
Displaying BOM Structures.....	208

Pages Used to Display BOM Structures.....	208
Manufacturing BOMs - Summary Page.....	209
Component Substitutes Page.....	210
Header - Outputs Page.....	211
Components - Component Details Page.....	212
Displaying Summarized BOMs.....	212
Pages Used to Display Summarized BOMs.....	213
BOM Summarized Page.....	213
BOM Summarized Outputs Page.....	215
Displaying BOM Costs.....	216
Pages Used to Display BOM Costs.....	216
Understanding BOM Costs.....	217
Costed BOM Page.....	218
Output Costs Page.....	222
Component Detail Costs Page.....	224
Comparing Manufacturing BOMs.....	225
Pages Used to Compare Manufacturing BOMs.....	225
Common Elements Used in This Section.....	227
Compare BOMs - BOM Selections Page.....	228
Compare BOMs - Component Detail: Component Details Page.....	229
Compare BOMs - Component Detail: Substitutes Page.....	231
Compare BOMs - Assy Header: Outputs Page.....	231
Checking the BOM Verification Status.....	231
Pages Used to Check the BOM Verification Status.....	232
BOM Verification Page.....	232
Delete BOM Verification Rows Page.....	233
BOM Verification Status - BOM Verification Detail Page.....	233
Viewing Item Where-Used Information.....	233
Pages Used to View Item Where-Used Information.....	234
Item Where Used Page.....	234
Item Where Used Express Page.....	236
Chapter 11: Defining Resources.....	239
Understanding Resources.....	239
Common Elements Used to Define Resources.....	239
Resource Setup.....	239
Defining Resources.....	240
Pages Used to Define Resources.....	240
Crews - Define Crew Page.....	241
Machines - Define Machine Page.....	241
Machines - Manufacturer Page.....	242
Tools - Define Tool Page.....	243
Tools - Location Page.....	243
Tools - Manufacturer Page.....	244
Viewing Where-Used Resource Data.....	244
Pages Used to View Where-Used Resource Data.....	245
Understanding Resource Searching.....	245
Chapter 12: Defining Work Centers.....	247
Understanding Work Centers.....	247
Common Element Used in Work Centers.....	247
Prerequisites.....	247
Defining Work Centers.....	248

Pages Used to Define Work Centers.....	248
Define Work Center - Definition Page.....	250
Define Work Center Resources Page.....	253
Define Work Center - Planning Opts (planning options) Page.....	255
Define Work Center - Conv Code (conversion code) Page.....	258
Define Work Center - Conv Ovhd Codes (conversion overhead codes) Page.....	259
Creating Work Center Groups.....	260
Page Used to Create Work Center Groups.....	260
Work Center Groups Page.....	260
Viewing Work Center Where-Used Data.....	261
Pages Used to View Work Center Where-Used Data.....	261
Used on Tasks inquiry Page.....	262
Used on Routings inquiry Page.....	262
Work Center Where Used - Used in Production Page.....	262
Copying Work Centers.....	263
Pages Used to Copy Work Centers.....	263
Copy Work Centers - Work Centers Page.....	263
Copy Work Centers - Work Center WIP Locations Page.....	265
Chapter 13: Maintaining Tasks.....	267
Understanding Tasks.....	267
Common Elements Used in Tasks.....	267
Defining and Maintaining Tasks.....	268
Pages Used to Define and Maintain Tasks.....	268
Define Task - Definition Page.....	269
Define Task - Resources Page.....	272
Define Task - Times Page.....	273
Define Task - Conversion Code Page.....	278
Tasks Where Used Page.....	279
Copying Tasks.....	279
Page Used to Copy Tasks.....	279
Copy Tasks Page.....	280
Chapter 14: Structuring Routings.....	283
Understanding Routings.....	283
Understanding Yield by Operation in PeopleSoft Manufacturing.....	283
Common Elements Used in Routings.....	284
Prerequisites.....	285
Maintaining Routings.....	285
Pages Used to Maintain Routings.....	286
Define Routings - Summary Page.....	287
Define Routings - Header: Description Page.....	289
Define Routings - Header: Attachments Page.....	291
Define Routings - Operations: Resources Page.....	292
Define Routings - Operations: Scheduling Page.....	294
Define Routings - Operations: Times Page.....	297
Define Routings - Operations: Conv Cost Codes Page.....	301
Define Routings - Operations: Attachments Page.....	303
Defining and Viewing Master Routings.....	303
Pages Used to Define and View Master Routings.....	304
Understanding Master Routings.....	304
Manufacturing: General Page.....	305
Master Routing Where Used Page.....	306

Copying Routings.....	307
Pages Used to Copy Routings.....	307
Copy Routing Page.....	307
Copy Routing: Detail Page.....	309
Deleting Routings.....	312
Page Used to Delete Routings.....	312
Delete Routings Page.....	312
Viewing Manufacturing Routing Comparisons.....	313
Pages Used to View Manufacturing Routing Comparisons.....	313
Common Elements Used in This Section.....	315
Routing Comparison - RTG Selections Page.....	315
Routing Comparisons - Header: Details Page.....	316
Routing Comparison - Operations: Details Page.....	317
Routing Comparison - Operations: Resources Page.....	318
Routing Comparison - Operations: Times Page.....	319
Chapter 15: Defining Production Options.....	321
Understanding Production Options.....	321
Prerequisites.....	323
Defining Items that Are to Use Production Options.....	324
Page Used to Define Items that Are to Use Production Options.....	324
Define Business Unit Item - Manufacturing: General Page.....	324
Creating Production Options.....	327
Pages Used to Create Production Options.....	327
Common Elements in This Section.....	328
Production Option Maintenance - Definition Page.....	328
Production Option Maintenance - Production Area Page.....	330
Production Option Maintenance - Attachments Page.....	330
Using the Autocreate Production Options Process.....	331
Page Used to Create Production Options Automatically.....	331
Autocreate Production Options Page.....	331
Copying Production Options.....	332
Page Used to Copy Production Options.....	332
Common Elements Used in This Section.....	332
Copy Production Options Page.....	333
Viewing Component and Output Mix and Production Options.....	335
Pages Used to View Component and Output Mix and Production Options.....	335
Component/Output Mix - Operation (inquiry) Page.....	336
Component/Output Mix - Component/Output (inquiry) Page.....	337
Production Option - Definition (inquiry) Page.....	338
Production Option - Production Area (inquiry) Page.....	338
Production Option Selection Page.....	338
Using Production Options with Other PeopleSoft Applications.....	339
Using Production Options with PeopleSoft Supply Planning.....	339
Using Production Options with Production.....	340
Chapter 16: Using Serial Genealogy in PeopleSoft Manufacturing.....	343
Understanding Serial Genealogy.....	343
Setting Up Items to be Traced by Serial Genealogy.....	346
Page Used to Set Up Items to be Traced by Serial Genealogy.....	346
Define Item: Inventory - Tracking Description Page.....	347
Associating Assembly Items and Components.....	348
Pages Used to Associate Assembly Items and Components.....	349

Assembly Serial Page.....	349
Component Serial Page.....	350
Disassociating Assemblies and Components.....	352
Pages Used to Disassociate Assemblies and Components.....	353
Assembly Serial Page.....	353
Component Serial Page.....	354
Maintaining Production Being Traced by Serial Genealogy.....	354
Page Used to Maintain Production Being Traced by Serial Genealogy.....	355
Reviewing Serial Genealogy Information.....	356
Pages Used to Review Serial Genealogy Information.....	356
Genealogy Search (review) Page.....	356
Genealogy (review) Page.....	358
Genealogy with Traceability Page.....	359
Making Serial Associations Using Third-Party Systems.....	360
Making Serial Associations Using the Batch Process.....	360
Page Used to Make Serial Associations Using the Batch Process.....	361
Generating Serial ID Labels.....	361
Page Used to Generate Serial ID Labels.....	361
Generating Serial Genealogy Exception Reports.....	361
Page Used to Generate Serial Genealogy Exception Reports.....	361
Reviewing Genealogy Exception Report Messages.....	362
Chapter 17: Setting Up Production Areas.....	363
Understanding Production Areas.....	363
Tracking Production.....	363
Selecting the Component Issue Method for Each Item.....	364
Setting Up WIP Accounts for Location Accounting.....	366
PeopleSoft Supply Planning Considerations.....	367
Common Elements Used in Setting Up Production Areas.....	367
Prerequisites.....	368
Defining Production Areas.....	369
Pages Used to Define Production Areas.....	369
Production Area: Summary Page.....	370
Select Primary Production Area for this Item Page.....	376
Production Area: Accounts Page.....	378
Production Area: Item Detail Page.....	379
Deleting Production Area and Item Combinations.....	382
Chapter 18: Maintaining Production Orders and Production Schedules.....	383
Understanding Production IDs and Production Schedules.....	383
Production Types.....	384
Production Statuses.....	386
Production Status Changes.....	390
Creation of New Production IDs or Production Schedules.....	391
Actual Dates and Production Due Dates.....	391
Regular Production Scheduling.....	393
Production IDs and Production Schedules Using PeopleSoft Supply Planning.....	393
Production IDs and Production Schedules Using PeopleSoft Manufacturing.....	394
Production IDs Using PeopleSoft Product Configurator.....	396
Rework and Teardown Production.....	396
Production ID Splits.....	397
Frozen Production.....	398
Manufacturing Execution System Integration.....	399

Common Elements Used in Production Orders and Production Schedules.....	400
Prerequisites.....	402
Creating Production IDs.....	402
Pages Used to Define and Maintain Production IDs.....	403
Common Elements Used in This Section.....	406
Production ID Maintenance Page.....	407
Production Start Date/Shift or Production Due Date/Shift Page.....	416
Teardown Original Production ID Search Page.....	417
Update Production Page.....	418
Production ID Detail Page.....	418
Production ID Outputs Page.....	420
Generating Production ID Splits.....	424
Pages Used to Generate Production ID Splits.....	424
Common Elements Used in This Section.....	425
Production ID Split - Header Page.....	426
Production ID Split - Operation List Page.....	429
PID Split Component List Page.....	431
Production ID Comp Transfer Page.....	434
Creating Production Schedules.....	436
Pages Used to Create Production Schedules.....	437
Common Elements Used in This Section.....	440
Production by Area Summary Page.....	440
Production by Area Details Page.....	443
Production Output List Page.....	446
Viewing Production Transaction History.....	448
Pages Used to View Production Transaction History.....	448
Common Element Used in This Section.....	448
Production History Page.....	448
Rescheduling Production.....	450
Pages Used to Reschedule Production.....	450
Reschedule Production Page.....	450
Production Selection Page.....	451
Chapter 19: Maintaining Component Lists.....	453
Understanding Component Lists.....	453
Creating Component Lists for Regular Production.....	455
Creating Component Lists for Rework Production.....	455
Creating Component Lists for Teardown Production.....	456
Modifying the Component List.....	456
Common Elements Used in Component Lists.....	457
Maintaining Component List Information.....	457
Pages Used to Maintain Component List Information.....	458
Update Component List - Production Selection Page.....	461
Component List Selection Page.....	463
Update Component List - Summary: Summary Page.....	465
Item Substitution Page.....	469
Update Component List - Detail: Detail Page.....	469
Component Detail Page.....	471
Update Component List - Detail: Documents Page.....	472
Update Component List - Detail: Attachments Page.....	474
Deleting Components from the Component List.....	474
Chapter 20: Maintaining Operation Lists.....	477

Understanding Operation Lists.....	477
Creating Operation Lists.....	477
Considering Subcontracted Operations.....	479
Common Elements Used in Operation Lists.....	479
Maintaining Operation List Information.....	481
Pages Used to Maintain Operation List Information.....	481
Production Selection Page.....	483
Summary - Summary Page.....	484
Details - Times Page.....	491
Details - Resources Page.....	494
Details - Conv Cost Codes Page.....	496
Details - Scheduling Page.....	497
Summary - Summary inquiry Page.....	501
Chapter 21: Releasing Production and Changing Production Statuses.....	503
Understanding Releasing Production and Changing Production Statuses.....	503
Review of the Material Readiness Report.....	503
Release of Production.....	503
Reversal of Production Statuses.....	505
Common Elements Used in Production.....	505
Running the Material Readiness Report.....	506
Pages Used to Run the Material Readiness Report.....	516
Material Readiness Report Page.....	517
Material Readiness Report- Supply/Demand Page.....	523
Changing Production ID Statuses.....	529
Pages Used to Change Production ID Statuses.....	529
Production ID Status Change Page.....	530
Changing Production Schedule Statuses.....	531
Pages Used to Change Production Schedule Statuses.....	531
Production Schedule Status Page.....	532
Changing Production Statuses and Releasing Multiple Production IDs and Schedules Simultaneously.....	533
Pages Used to Change Production Statuses and Releasing Multiple Production IDs and Schedules Simultaneously.....	533
Release Production Selection Page.....	533
Production Selection Page.....	534
Chapter 22: Issuing Material to Production.....	537
Understanding Component Issue Methods.....	537
Common Elements Used in Issuing Material to Production.....	538
Using the Issue Method.....	539
Using the Kit Method.....	540
Using the Replenishment Method.....	540
Pages Used to Use the Replenishment Method.....	541
Prdn Replenish Locations Page.....	541
Prdn Replenish Detail Page.....	543
Creating and Processing Picking Plans.....	546
Pages Used to Create and Process Picking Plans.....	547
Picking Options Page.....	548
Pick Plan Extract Page.....	554
Picking Options - Production Selection Page.....	555
Runtime Settings Page.....	556
Reviewing and Confirming Picking Plans.....	557

Review Plan - Production Selection Page.....	557
Review Plan Page.....	557
Updating Pick Batches.....	562
Setting Pick Batch Options.....	562
Selecting Production Pick Batches.....	563
Issuing Material to the Shop Floor.....	563
Replenishing WIP Locations.....	564
Pages Used to Replenish WIP Locations.....	564
Worklist Page.....	564
Kanban Transfers Page.....	565
Processing Kit Issues and Returns.....	566
Pages Used to Process Kit Issues and Returns.....	566
Common Elements Used in This Section.....	567
Kit Issue/Return Summary Page.....	567
Kit Issue/Return Location Page.....	570
Issue/Return Kit Components Page.....	572
Lot/Serial Number Selection Page.....	573
Kit Issue/Return Detail Page.....	573
Processing Component De-Kits.....	574
Page Used to Process Component De-Kits.....	574
Component De-Kit Selection Page.....	574
Issuing Material Using Electronic Data Collection.....	576
Page Used to Issue Material Using Electronic Data Collection.....	576
Processing Picking Plans Using Electronic Data Collection.....	576
Pages Used to Process Picking Plans Using Electronic Data Collection.....	577
Production Picking Page.....	578
Production Picking Page.....	580
Processing Kit Issues and Returns Using Electronic Data Collection.....	581
Pages Used to Process Kit Issues and Returns Using Electronic Data Collection.....	581
Kit Issue/Return Page.....	581
Kit Issue/Return background process Page.....	582
Chapter 23: Completing Operations and Recording Scrap.....	585
Understanding Recording Completions and Scrap.....	585
Manage Production Using Discrete Orders.....	587
Manage Production by Day and Shift (Production Schedules).....	589
Automatically Consuming Lot-Controlled Stock During a Backflush.....	591
Integrating PeopleSoft Manufacturing with a Third-Party System.....	595
Common Elements Used in Operations and Recording.....	596
Prerequisites.....	597
Recording Completed Operations and Scrap for In-House Production IDs.....	598
Pages Used to Record Completions and Scrap for In-House Production IDs.....	599
Understanding the Process of Recording Completions and Scrap for In-House Production IDs.....	600
Production Selection Page.....	601
Record Completions/Scrap Page.....	601
Production Scrap Details Page.....	607
Rapid Serial Numbers Page.....	612
Recording End Item Completions Using Count Points.....	613
Recording End Item Completions at the Last Operation.....	615
Record Completions/Scrap Page.....	615
Moving Completed End Items and Assigning Serial and Lot Numbers.....	616

Pages Used to Move Completed End Items and Assign Serial and Lot Numbers.....	618
Prerequisites.....	618
Record Completions/Scrap Page.....	618
Shortages Page.....	619
Selecting Default Putaway Storage Locations.....	620
Record Completions/Scrap Page.....	621
Selecting a Lot ID.....	621
Staging End Items for Putaway.....	621
Recording Completions and Scrap for Production IDs with Multiple Outputs.....	622
Pages Used to Record Completions and Scrap for Production IDs with Multiple Outputs.....	622
Record Completions/Scrap - Output Details scroll area Page.....	623
Moving Completed End Items for Production IDs with Multiple Outputs.....	625
Edit/Issue Components Page.....	625
Recording Completed and Scrapped End Items for Production Schedules.....	626
Pages Used to Record Completions and Scrap for Production Schedules.....	627
Common Elements Used in This Section.....	628
Production Selection Page.....	628
Schedule Selection Page.....	630
Adding a New Production Schedule During Completions.....	631
Record Completions/Scrap Page.....	632
Record Completions/Scrap Page.....	632
Moving End Items for Production Schedules.....	633
Editing Component Lists.....	633
Pages Used to Edit or Issue Components.....	637
Production Selection Page.....	638
Edit/Issue Components Summary Page.....	639
Edit/Issue Express Page.....	642
Lot/Serial Number Selection Page.....	643
Edit/Issue Express Page.....	643
Edit/Issue Components Detail Page.....	644
Identifying Material Shortages.....	646
Running the Completions Update COBOL/SQR Process (SFPDCDRV).....	646
Page Used to Run the Completions Update COBOL/SQR Process (SFPDCDRV).....	646
Prdn Cmpl/Scrap Page.....	646
Creating Reversing Entries to Correct Data Entry Errors.....	647
Pages Used to Create Reversing Entries to Correct Data Entry Errors.....	647
Identifying Production for Data Entry Error Corrections.....	648
Record Completions/Scrap Page.....	648
Completing Production.....	652
Pages Used to Complete Production.....	653
Complete Production Page.....	653
Moving Excess Inventory Back to a Stores Location.....	654
Viewing and Reporting Material Shortages.....	654
Pages Used to View and Report Material Shortages.....	654
Viewing Scrap and Earned Conversion Cost Information.....	654
Pages Used to View Scrap and Earned Conversion Cost Information.....	655
Recording and Viewing Actual Machine and Labor Hours.....	655
Pages Used to Record and View Actual Machine and Labor Hours.....	655
Record Actual Hours Page.....	656
Chapter 24: Recording Completions and Scrap Using Electronic Data Collection.....	659

Understanding the Process of Recording Completions and Scrap Using Electronic Data Collection..... 659

Common Elements Used in Recording Completions and Scrap Using Electronic Data Collection..... 660

Recording Completions Using Electronic Data Collection..... 660

 Pages Used to Record Completions Using Electronic Data Collection..... 660

 Production Completion/Scrap Page..... 661

 Multiple Out Completion/Scrap Page..... 662

Processing Electronic Data Collection Completions Transactions..... 664

Processing Other Electronic Data Collection Transactions..... 664

 Pages Used to Process Other Electronic Data Collection Transactions..... 664

 Production Selection Page..... 665

 Completion Labels Page..... 665

Editing or Issuing Components..... 665

 Page Used to Edit Components Using Electronic Data Collection..... 666

 Understanding the Process of Editing or Issuing Components Using Electronic Data Collection..... 666

 Understanding the Production Order Issue EIP..... 666

 Consuming Lot-Controlled Components..... 667

 Component Issues>Returns Page..... 667

Recording Actual Machine and Labor Hours..... 668

 Pages Used to Record Actual Machine and Labor Hours..... 669

 Actual Hours Page..... 669

 Actual Hours process Page..... 670

Chapter 25: Subcontracting..... 673

 Understanding Subcontracting Using PeopleSoft Manufacturing..... 673

 Manage Production with Subcontracted Operations..... 673

 Common Elements Used in Subcontracting..... 674

 Prerequisites..... 675

 Selecting Subcontracted Operations for Purchase Order Creation..... 676

 Pages Used to Generate Subcontracted Purchase Orders..... 676

 Select Subcontract Production Page..... 676

 Generating, Approving, and Dispatching Purchase Orders for Subcontracted Operations..... 677

 Managing Purchase Order Changes..... 678

 Canceling or Deleting a Subcontracted Purchase Order..... 679

 Receiving End Items from Suppliers..... 679

 Recording Completed Operations and Scrap for Subcontracted Operations..... 680

 Pages Used to Record Completions and Scrap for Subcontracted Operations..... 681

 Subcontracted Receipt Page..... 682

 Receipt Information Page..... 683

 Moving Completed End Items..... 684

 Pages Used to Move Completed End Items..... 684

 Completing Production for Subcontracted Operations..... 685

 Pages Used to Complete Production for Subcontracted Operations..... 685

 Editing or Issuing Components for Subcontracted Operations..... 685

 Pages Used to Edit or Issue Components for Subcontracted Operations..... 685

 Creating Reversing Entries..... 687

 Pages Used to Create Reversing Entries for Subcontracted Operations..... 688

 Recording and Viewing Actual Labor and Machine Hours..... 688

 Pages Used to Record and View Actual Labor and Machine Hours..... 688

Chapter 26: Closing Production..... 691

Understanding the Production Close Process.....	691
Analyzing Potential Variances.....	691
Pages Used to Generate a Potential Variance Report.....	692
Initiating the Close Production Process.....	692
Pages Used to Initiate the Production Close Process.....	694
Production Selection Page.....	694
Close Status Selection Page.....	695
Using the Close Production Request Report.....	697
Reopening Production.....	698
Pages Used to Reopen Production.....	699
Reopen Status Selection Page.....	699
Reviewing Production Variance Details.....	700
Pages Used to Review Production Variance Details.....	701
Searching for Production Variance Drilldown Information.....	701
Reviewing Production Variance Drilldown Information.....	703
Chapter 27: Archiving and Purging Production Data.....	707
Understanding the Production Archive and Purge Process.....	707
Pages Used to Archive and Purge Production Data.....	707
Archiving and Purging Production Data.....	708
Archive Production Data Page.....	708
Archive Parameters Page.....	709
Understanding the Ramifications of Archiving and Purging Production Data.....	709
Chapter 28: Understanding Scheduling Operations.....	711
Production Scheduling in PeopleSoft Manufacturing.....	711
Factors Affecting Scheduling with PeopleSoft Manufacturing.....	711
Maintaining Production Dates and Actual Dates.....	712
Defining Production Scheduling Methods.....	712
Factors Affecting Scheduling with PeopleSoft Supply Planning.....	713
Examples of Production Scheduling.....	713
Example 1.....	714
Example 2.....	717
Example 3.....	721
Example 4.....	724
Example 5.....	727
Chapter 29: Delivered Workflows for PeopleSoft Manufacturing.....	733
Delivered Workflows for PeopleSoft Manufacturing.....	733
Assembly Prdn Schedule Scrap Notification.....	733
Assembly PID Scrap Notification.....	733
BOM Change.....	734
Identify Production with Pending Quantities.....	735
Potential Prdn Variance Report.....	735
Production Calendar Change.....	736
Production ID Change.....	737
Production Ready to Close.....	737
Replenishment Notification.....	738
Routing Change.....	739
Task Change.....	739
Work Center Calendar Code Change.....	740
Workcenter Change.....	741
Chapter 30: PeopleSoft Manufacturing Report Descriptions.....	743
PeopleSoft Manufacturing Reports: General Description.....	743

PeopleSoft Manufacturing Reports: A to Z..... 749

 ENS1000 - BOM Report..... 750

 ENS1001 - Routing Report..... 751

 ENS1002 - Compare Routings Report..... 751

 ENS1003 - Master Routing Where Used Report..... 752

 ENS1004 - Resources Where Used Report..... 753

 ENS1005 - BOM Compare Report..... 754

 ENS1006 - Work Centers Where Used Report..... 755

 ENS1007 - Tasks Where Used Report..... 756

 ENS1010 - BOM Cost Report..... 756

 ENS2000 - Item Where Used Report..... 757

 SF_MATRDY- Material Readiness Report..... 757

 SFS1100 - Production Close Report..... 757

 SFS1200 - Production Reopen Process Report..... 760

 SFS1500 - Production Variance Report..... 760

 SFS1600 - Potential Production Variance Report..... 760

 SFS2001 - Shortage Report..... 761

 SFS2002 - Dispatch List..... 762

 SFS2003 - Production Documents..... 765

 SFS2004 - Production Report..... 766

 SFS2006 - Component Where Used in Production Report..... 768

 SFS2007 - Production Schedule by Area Report..... 769

 SFS2008 - Subcontracted Purchase Order Report..... 769

 SFS5001 - Subcontract Components Report..... 770

 SFS6000 - Material Picking Plan..... 771

 SFS8000 - Genealogy Exception Report..... 772

 Viewing Standard Financial Reports..... 773

Preface

Understanding the PeopleSoft Online Help and PeopleBooks

The PeopleSoft Online Help is a website that enables you to view all help content for PeopleSoft applications and PeopleTools. The help provides standard navigation and full-text searching, as well as context-sensitive online help for PeopleSoft users.

Hosted PeopleSoft Online Help

You can access the hosted PeopleSoft Online Help on the [Oracle Help Center](#). The hosted PeopleSoft Online Help is updated on a regular schedule, ensuring that you have access to the most current documentation. This reduces the need to view separate documentation posts for application maintenance on My Oracle Support. The hosted PeopleSoft Online Help is available in English only.

To configure the context-sensitive help for your PeopleSoft applications to use the Oracle Help Center, see [Configuring Context-Sensitive Help Using the Hosted Online Help Website](#).

Locally Installed PeopleSoft Online Help

If you're setting up an on-premises PeopleSoft environment, and your organization has firewall restrictions that prevent you from using the hosted PeopleSoft Online Help, you can install the online help locally. Installable PeopleSoft Online Help is made available with selected PeopleSoft Update Images and with PeopleTools releases for on-premises installations, through the [Oracle Software Delivery Cloud](#).

Your installation documentation includes a chapter with instructions for how to install the online help for your business environment, and the documentation zip file may contain a README.txt file with additional installation instructions. See *PeopleSoft 9.2 Application Installation* for your database platform, "Installing PeopleSoft Online Help."

To configure the context-sensitive help for your PeopleSoft applications to use a locally installed online help website, see [Configuring Context-Sensitive Help Using a Locally Installed Online Help Website](#).

Downloadable PeopleBook PDF Files

You can access downloadable PDF versions of the help content in the traditional PeopleBook format on the [Oracle Help Center](#). The content in the PeopleBook PDFs is the same as the content in the PeopleSoft Online Help, but it has a different structure and it does not include the interactive navigation features that are available in the online help.

Common Help Documentation

Common help documentation contains information that applies to multiple applications. The two main types of common help are:

- Application Fundamentals

- Using PeopleSoft Applications

Most product families provide a set of application fundamentals help topics that discuss essential information about the setup and design of your system. This information applies to many or all applications in the PeopleSoft product family. Whether you are implementing a single application, some combination of applications within the product family, or the entire product family, you should be familiar with the contents of the appropriate application fundamentals help. They provide the starting points for fundamental implementation tasks.

In addition, the *PeopleTools: Applications User's Guide* introduces you to the various elements of the PeopleSoft Pure Internet Architecture. It also explains how to use the navigational hierarchy, components, and pages to perform basic functions as you navigate through the system. While your application or implementation may differ, the topics in this user's guide provide general information about using PeopleSoft applications.

Field and Control Definitions

PeopleSoft documentation includes definitions for most fields and controls that appear on application pages. These definitions describe how to use a field or control, where populated values come from, the effects of selecting certain values, and so on. If a field or control is not defined, then it either requires no additional explanation or is documented in a common elements section earlier in the documentation. For example, the Date field rarely requires additional explanation and may not be defined in the documentation for some pages.

Typographical Conventions

The following table describes the typographical conventions that are used in the online help.

<i>Typographical Convention</i>	<i>Description</i>
Key+Key	Indicates a key combination action. For example, a plus sign (+) between keys means that you must hold down the first key while you press the second key. For Alt+W , hold down the Alt key while you press the W key.
... (ellipses)	Indicate that the preceding item or series can be repeated any number of times in PeopleCode syntax.
{ } (curly braces)	Indicate a choice between two options in PeopleCode syntax. Options are separated by a pipe ().
[] (square brackets)	Indicate optional items in PeopleCode syntax.
& (ampersand)	When placed before a parameter in PeopleCode syntax, an ampersand indicates that the parameter is an already instantiated object. Ampersands also precede all PeopleCode variables.

Typographical Convention	Description
⇒	This continuation character has been inserted at the end of a line of code that has been wrapped at the page margin. The code should be viewed or entered as a single, continuous line of code without the continuation character.

ISO Country and Currency Codes

PeopleSoft Online Help topics use International Organization for Standardization (ISO) country and currency codes to identify country-specific information and monetary amounts.

ISO country codes may appear as country identifiers, and ISO currency codes may appear as currency identifiers in your PeopleSoft documentation. Reference to an ISO country code in your documentation does not imply that your application includes every ISO country code. The following example is a country-specific heading: "(FRA) Hiring an Employee."

The PeopleSoft Currency Code table (CURRENCY_CD_TBL) contains sample currency code data. The Currency Code table is based on ISO Standard 4217, "Codes for the representation of currencies," and also relies on ISO country codes in the Country table (COUNTRY_TBL). The navigation to the pages where you maintain currency code and country information depends on which PeopleSoft applications you are using. To access the pages for maintaining the Currency Code and Country tables, consult the online help for your applications for more information.

Region and Industry Identifiers

Information that applies only to a specific region or industry is preceded by a standard identifier in parentheses. This identifier typically appears at the beginning of a section heading, but it may also appear at the beginning of a note or other text.

Example of a region-specific heading: "(Latin America) Setting Up Depreciation"

Region Identifiers

Regions are identified by the region name. The following region identifiers may appear in the PeopleSoft Online Help:

- Asia Pacific
- Europe
- Latin America
- North America

Industry Identifiers

Industries are identified by the industry name or by an abbreviation for that industry. The following industry identifiers may appear in the PeopleSoft Online Help:

- USF (U.S. Federal)

- E&G (Education and Government)

Translations and Embedded Help

PeopleSoft 9.2 software applications include translated embedded help. With the 9.2 release, PeopleSoft aligns with the other Oracle applications by focusing our translation efforts on embedded help. We are not planning to translate our traditional online help and PeopleBooks documentation. Instead we offer very direct translated help at crucial spots within our application through our embedded help widgets. Additionally, we have a one-to-one mapping of application and help translations, meaning that the software and embedded help translation footprint is identical—something we were never able to accomplish in the past.

Using and Managing the PeopleSoft Online Help

Select About This Help in the left navigation panel on any page in the PeopleSoft Online Help to see information on the following topics:

- Using the PeopleSoft Online Help.
- Managing hosted Online Help.
- Managing locally installed PeopleSoft Online Help.

PeopleSoft FSCM Related Links

[Oracle Help Center](#)

[Hosted Online Help](#)

[PeopleSoft Information Portal](#)

[My Oracle Support](#)

Financial and Supply Chain Management information for Search Framework search engine can be found in PeopleSoft Application Fundamentals documentation. For application specific information, see the “Understanding Keyword Search within Components” (Application Fundamentals) topic.

[PeopleSoft Training from Oracle University](#)

[PeopleSoft Video Feature Overviews on YouTube](#)

[PeopleSoft Business Process Maps \(Microsoft Visio format\)](#)

[PeopleSoft Spotlight Series](#)

Contact Us

Send your suggestions to psoft-infodev_us@oracle.com.

Please include the applications update image or PeopleTools release that you're using.

Follow Us

<i>Icon</i>	<i>Link</i>
	Watch PeopleSoft on YouTube
	Follow @PeopleSoft_Info on X.
	Read PeopleSoft Blogs
	Connect with PeopleSoft on LinkedIn

Chapter 1

Getting Started with PeopleSoft Manufacturing

Your Enterprise Data Flow

PeopleSoft Manufacturing consists of a tightly knit, functionally rich suite of applications that streamline, automate, and augment your business processes to provide a comprehensive, global supply chain management solution.

Note: PeopleSoft Manufacturing combines products that were previously released as PeopleSoft Bills and Routings and PeopleSoft Production Management.

PeopleSoft Manufacturing includes these applications:

- PeopleSoft Cost Management
- PeopleSoft Engineering
- PeopleSoft Quality
- PeopleSoft Inventory
- PeopleSoft Flow Production

All PeopleSoft Manufacturing applications are seamlessly linked. In other words, data is shared among all applications. PeopleSoft Manufacturing also uses data that is defined in other PeopleSoft applications, such as PeopleSoft Product Configurator, PeopleSoft Purchasing, PeopleSoft Asset Management, PeopleSoft Accounts Payable, and PeopleSoft General Ledger.

Recognizing Your Business Structure

The first goal with the newly installed PeopleSoft Manufacturing application is to design the system. You'll define the shop floor and inventory structure, and the costing and accounting rules, as if you were developing your own new in-house system—without writing all the code. We've already anticipated the features and functionality that you'll need through our application tables, so all you do is complete the tables, as you add business units.

Before you set up the tables, you'll need to make some key decisions regarding how you want to define the system. As you begin making implementation decisions, consider:

- Whether items will be tracked using lots or serial numbers.
- Whether you want to use location accounting to financially account for inventory movement. If so, you'll assign different general ledger inventory accounts to each storage area and production area.

- Whether you have government-mandated requirements for reporting financial results that differ from the corporate chart of accounts.
- How you want to set up the storage level configuration for the business unit.
- Which storage areas will be WIP locations to maintain component supply for production.
- Which storage locations will contain non-owned stock.
- Whether you'll use consigned inventory from suppliers.
- Whether you'll track production using discrete orders (production IDs) or track production quantities as they're completed.
- Whether any of the production processes will be outsourced to a subcontractor.
You must use production IDs to implement those subcontractor processes.
- Whether you want to specify automatic revision control for an item.

Note: If your organization requires engineering change orders (ECOs), change control, and document management for prototyping new items or modifying existing bills of material (BOMs), consider installing PeopleSoft Engineering. Please contact your account manager for further information regarding this application.

See “Setting Up Location Accounting” (PeopleSoft Inventory).

See “Defining Serial Control and Shipping Serial Control” (PeopleSoft Inventory)

Additional Considerations for Consumer Products

If you're using consumer products, consider:

- Whether you define effective-dated BOM and routing combinations (also known as production options).
- Whether you generate co-products and by-products as part of the production process.

See [Understanding Production Options](#).

Additional Considerations for Landed Costs

If you're using landed costs, consider which non-material components of an item's cost (freight, insurance) you want to track separately.

Additional Considerations for PeopleSoft Quality

If you're using PeopleSoft Quality, consider:

- The processes for which you are going to collect quality information.
- The type of characteristics (variables, defects) that you want to measure for the process.
- Whether you are going to integrate with PeopleSoft Quality through PeopleSoft Manufacturing, PeopleSoft Inventory, or PeopleSoft Purchasing.

- Whether you want to pass quality control information from the current data collection devices to PeopleSoft Quality.

See “Understanding PeopleSoft Quality Integration With Other PeopleSoft Applications” (PeopleSoft Quality)

Additional Considerations for PeopleSoft Engineering

If you're using PeopleSoft Engineering, consider these questions:

- What are the procedures for introducing new products and enhancing existing products?
- Do you intend to use engineering change requests (ECRs) and ECOs?
- Do you collaborate with suppliers on outsourced products? Will you use PeopleSoft Engineering self-service applications for this?
- How will you manage the BOMs and routings within PeopleSoft Engineering?
- Will the master version for BOMs and routings be kept in PeopleSoft Engineering or only "in-process" development?
- Are you using a third-party supplier for product development that needs to feed BOMs into PeopleSoft Engineering?

If so, you'll need to use the Product Data Management EIP.

- Will you use mass maintenance to modify BOMs?
- Do you require revision control?

This affects how items are set up, as well as revisions and decisions regarding the use of auto-revision control during mass maintenance.

- Will you have Documentum installed or will you use attachments to track design documents within the PeopleSoft system?

Additional Considerations for Integrating to Third-Party Systems

PeopleSoft Manufacturing integrates to third-party data collection, product data management, item content provider, and manufacturing execution systems. If you integrate to a third-party application, consider:

- Whether you use electronic data collection and which type of device you'll use: radio frequency, wedge, or batch.
- Whether you integrate to a third-party system and which of the integration points you'll implement.
- Whether you use a manufacturing execution system (MES) or any other third-party systems to publish messages, and whether you'll use chunking to distribute messages.

For example, you can distribute production order data to different business units.

- Additionally, you must activate the messages and set up message nodes.

You also can optionally set up chunking for "publish" messages.

See [Understanding the PDX Integration](#)

PeopleSoft Manufacturing Integrations

This diagram illustrates PeopleSoft Manufacturing integrations with other PeopleSoft Financial and Supply Chain Management (FSCM) applications. The integration points are explained below the diagram:

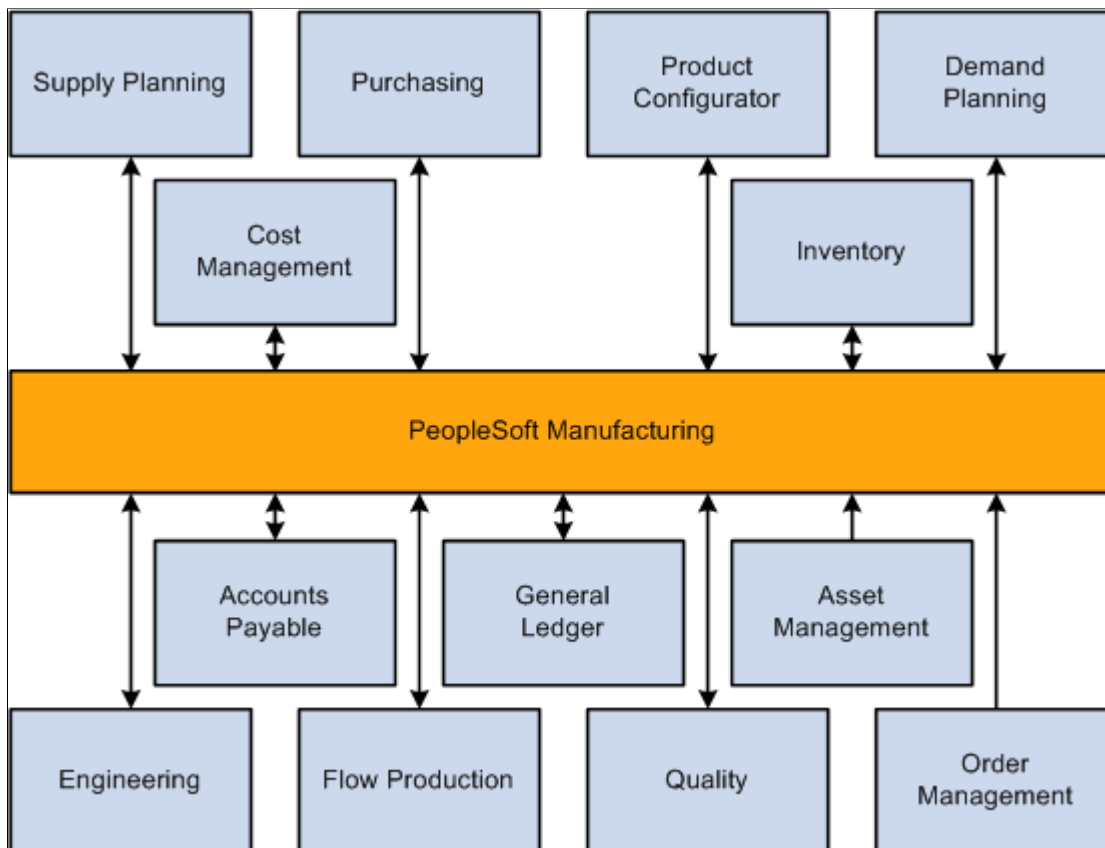

We discuss integration considerations in the appropriate topics in several PeopleSoft Documentation.

PeopleSoft Asset Management

PeopleSoft Manufacturing enables you to track assets and maintain service schedules by optionally linking asset information from PeopleSoft Asset Management to machine and tool resources in PeopleSoft Manufacturing.

PeopleSoft Cost Management

PeopleSoft Cost Management defines the costing and accounting structure for all PeopleSoft Manufacturing operations. You can define various costing methods for an item, such as standard, actual, perpetual, retroactive, and periodic cost. Robust cost analytics are provided to help you analyze the costs.

PeopleSoft Engineering

As part of our design-to-deploy solution, if you have PeopleSoft Engineering installed, you can take advantage of the integration between PeopleSoft Manufacturing and PeopleSoft Engineering to:

- Maintain both engineering BOMs and manufacturing BOMs.
- Maintain both engineering and manufacturing routings.
- Transfer BOMs and routings between PeopleSoft Manufacturing and PeopleSoft Engineering.
- Maintain document versions.
- Make mass changes to manufacturing BOMs using ECOs.
- View ECOs.

PeopleSoft Flow Production

If you are using PeopleSoft Flow Production, you can use streamlined replenish techniques to replenish production materials. Material can be replenished from an inventory location, feeder line, or supplier.

PeopleSoft Inventory

PeopleSoft Manufacturing uses PeopleSoft Inventory to define item attributes, issue raw materials and subassemblies, and store finished goods. The system automatically notifies PeopleSoft Inventory to replenish the WIP location when material is consumed and falls below user-defined levels during the backflush process.

PeopleSoft Manufacturing accesses these items in PeopleSoft Inventory:

- Approved items in creating a BOM.
- Approved items, item groups, and item families in the creation of master routings.
- Material storage locations that are used to assign WIP locations to work centers.

PeopleSoft Product Configurator

PeopleSoft Product Configurator accesses routing information from PeopleSoft Manufacturing. The production configuration process takes the detailed configuration information that is captured during order management and sends requirements to PeopleSoft Manufacturing.

PeopleSoft Order Management

PeopleSoft Manufacturing can receive configured production orders that are created in PeopleSoft Order Management using PeopleSoft Product Configurator. PeopleSoft Manufacturing produces finished goods to fulfill orders that are taken by PeopleSoft Order Management.

PeopleSoft Purchasing

PeopleSoft Manufacturing accesses supplier information from PeopleSoft Purchasing for subcontracted tasks and operations on a routing, as well as for PeopleSoft Engineering. PeopleSoft Purchasing works closely with PeopleSoft Manufacturing to manage subcontracting operations. After production has been released, you can select the production IDs with subcontracted operations and send the information to PeopleSoft Purchasing, where purchase orders will be created. PeopleSoft Purchasing is used to provide raw materials for manufacturing.

PeopleSoft Quality

PeopleSoft Quality is used to record quality metrics during the manufacturing phase. PeopleSoft Quality accesses, from PeopleSoft Manufacturing, machine information to define machine stations where samplings occur and work center information to define work centers where samplings occur. If the installation includes PeopleSoft Quality, and you have defined quality configuration information and quality plans in PeopleSoft Quality for the manufactured item and its process, PeopleSoft Manufacturing enables you to transfer completions data to immediately initiate a quality data entry session in PeopleSoft Quality. Alarms will be triggered when PeopleSoft Quality identifies out-of-tolerance situations.

PeopleSoft Supply Planning

As part of our plan-to-produce solution, PeopleSoft Supply Planning accesses both planning BOMs manufacturing BOMs and routing and master routing information (work center, task, and operation) from PeopleSoft Manufacturing for supply planning and scheduling purposes.

PeopleSoft Manufacturing and Third-Party Systems

This diagram illustrates PeopleSoft Manufacturing integrations with third-party systems using PeopleSoft enterprise integration points (EIPs). The third-party systems include product data management systems, electronic data collection (EDC) systems, product lifecycle management systems, manufacturing execution systems, and item content providers:

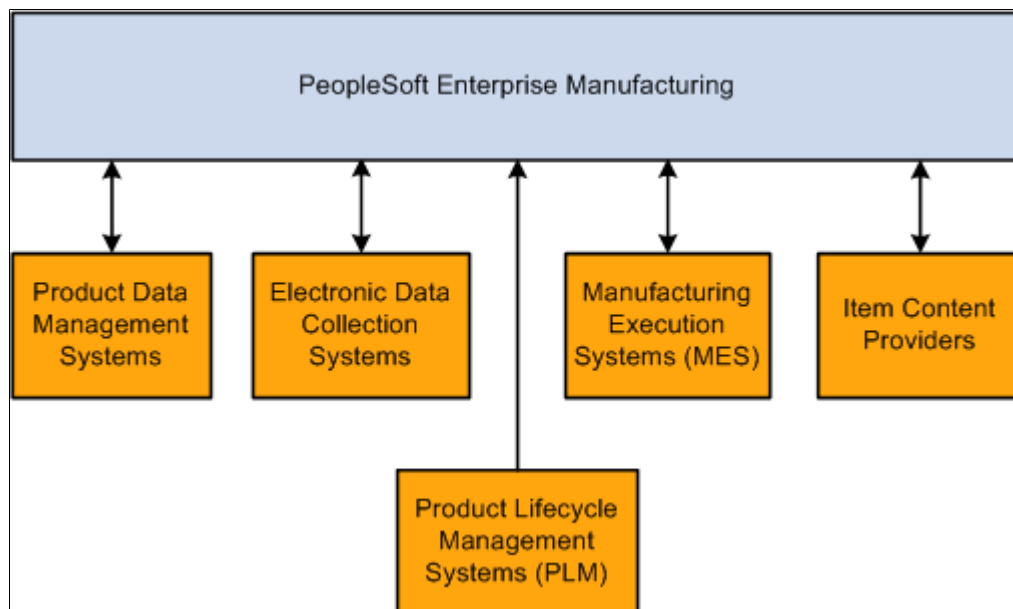

See [Understanding the PDX Integration](#)

Supplemental information about other third-party application integrations is located on the My Oracle Support website.

PeopleSoft Manufacturing EIPs

This section discusses the EIPs that are used by PeopleSoft Manufacturing to send and receive information.

<i>EIP Name</i>	<i>Description</i>
Actual Hours (PRODUCTION_ACTUAL_HOURS)	<p>You may also want to record actual hours information that is associated with specific production, and this information may have been captured by a third-party system. Use the Actual Hours EIP to import actual hours information from third-party systems. This is an inbound, asynchronous message.</p> <p>See Understanding Recording Completions and Scrap</p>
Bill of Material (BOM_SYNC)	<p>If you use a third-party item content provider or product data management system to manage BOMs, use this EIP to import updates to engineering and manufacturing BOMs from an external system. This is an inbound, asynchronous message.</p> <p>See “Examining the PeopleSoft Engineering Product Strategy” (PeopleSoft Engineering)</p> <p>See Understanding the PDX Integration</p>
Item Master (ITEM_SYNC)	<p>Import item information. This is an inbound, asynchronous message.</p> <p>See Understanding BOM Maintenance</p> <p>See “Examining the PeopleSoft Engineering Product Strategy” (PeopleSoft Engineering)</p> <p>See Understanding the PDX Integration</p>
Production Completions (PRODUCTION_ORDER_COMPLETION)	<p>If you use a third-party system to record completions for production, use this EIP to import information into PeopleSoft Manufacturing. This is an inbound, asynchronous message.</p> <p>See Understanding the Process of Recording Completions and Scrap Using Electronic Data Collection</p>
Production Order Issue (PRODUCTION_ORDER_ISSUE)	<p>Use this EIP to import edit or issue component information from a third-party system. This is an inbound, asynchronous message.</p> <p>Understanding Recording Completions and Scrap</p>
Production Order Update (PRODUCTION_ORDER_UPDATE)	<p>Use this EIP to export production order or production schedule changes to an external system. This is an outbound, asynchronous message.</p> <p>See Understanding Production IDs and Production Schedules</p>

<i>EIP Name</i>	<i>Description</i>
Production Picking (PRODUCTION_PICKING)	Import picking information from third-party systems. This is an inbound, asynchronous message. See Issuing Material Using Electronic Data Collection .
Production Serial Association (PRODUCTION_SERIAL_ASSOCIATION)	Use this EIP to import production genealogy information from an external system. This is an inbound message. See Understanding Serial Genealogy See “Processing Inbound EIPs” (PeopleSoft Supply Chain Management Integration)

PeopleSoft Manufacturing Implementation

PeopleSoft Setup Manager enables you to generate a list of setup tasks for the organization based on the features that you are implementing. The setup tasks include the components that you must set up, listed in the order in which you must enter data into the component tables, and links to the corresponding documentation.

PeopleSoft Manufacturing also provides component interfaces to help you load data from the existing system into PeopleSoft Manufacturing tables. Use the Excel to Component Interface utility with the component interfaces to populate the tables.

This table lists all of the components that have component interfaces:

<i>Component</i>	<i>Component Interface</i>	<i>Reference</i>
Item Groups	INV_ITEM_GROUPS_CI	See “Setting Definitions for Item Control Values” (PeopleSoft Managing Items).
Ultimate Use Code	SUT_USE_CI	See “Defining Additional Common Information” (Application Fundamentals).
Item Load from Excel	IN_MST_ITM_XLS	See “Using the Excel-to-Component-Interface Utility” (PeopleSoft Managing Items).
Sales and Use Tax Authorities	TAX_AUTHORITY_CI	See “Defining Sales and Use Tax Authorities and Codes” (Application Fundamentals).

Component	Component Interface	Reference
Sales and Use Tax Codes	TAX_CODE_CI	See “Defining Sales and Use Tax Authorities and Codes” (Application Fundamentals).
Distribution Type	CM_DISTR_TYPE_CI	See “Distribution Type Page” (PeopleSoft Cost Management).
Automatic Serial Numbers	AUTO_SERIAL_NUM_CI	See “Defining Items at the SetID Level” (PeopleSoft Managing Items)
Transfer Attributes	UNIT_TRANSFER_DEF_CI	See “Understanding Stock Transfers Between Business Units” (PeopleSoft Inventory)
Transfer Attributes Defaults	TRANS_UNIT_INV_CI	See “Understanding Stock Transfers Between Business Units” (PeopleSoft Inventory)
Production Conversion Codes	CE_CONCODE_CI	See “Understanding the Manufacturing Standard Cost Foundation” (PeopleSoft Cost Management)
Costing Conversion Overhead Rates	CE_CONV_OH_RATE_CI	See “Understanding the Manufacturing Standard Cost Foundation” (PeopleSoft Cost Management)
Conversion Rates	CE_CONV_RATE_CI	See “Understanding the Manufacturing Standard Cost Foundation” (PeopleSoft Cost Management)
Forecasted Purchase Costs	CE_FCST_CI	See “Understanding the Manufacturing Standard Cost Foundation” (PeopleSoft Cost Management)
Additional Item Costs	CE_ITEMEXP_CI	See “Understanding the Manufacturing Standard Cost Foundation” (PeopleSoft Cost Management)
Conversion Overhead Codes	CE_OHCODE_CODE_CI	See “Understanding the Manufacturing Standard Cost Foundation” (PeopleSoft Cost Management)
Bill of Material Privileges	EN_IC_BOM_PRIV_CI	See Understanding BOM Maintenance
Item Price Markup	MARKUP_PCT_INV_CI	See “Understanding Interunit Transfers” (PeopleSoft Cost Management)

Component	Component Interface	Reference
Production Replenish Locations	REPL_LOCATIONS_CI	See Understanding Component Issue Methods
Item Transfer Price	STD_PRICE_INV_CI	See “Understanding Interunit Transfers” (PeopleSoft Cost Management)
Floor and Ceiling Costs	CM_VALUE_REF_PGRP_CI	See “Generating Reports of Financial Transactions” (PeopleSoft Cost Management).
Fixed Picking Locations	FIXED_PICK_BINS_CI	See “Assigning Fixed Picking Locations” (PeopleSoft Inventory).
Crew Actual Costs	CE_CREW_ACTCOST_CI	See “Crew Actual Cost Page” (PeopleSoft Cost Management).

PeopleSoft Events and Notifications Framework

As your organization processes the continuous stream of transactions within your PeopleSoft system, the events and notifications framework enables you to monitor the transaction flow and alert your organization to any errors, changes, and stalled transactions. The messages generated by the events and notifications framework can notify you of the problem, give you a detailed description of the issue, and provide a link to the PeopleSoft page where you can resolve it. One of the ways to use the events and notifications framework is to create PeopleSoft Queries on one or more PeopleSoft tables, add the alert using the Alert Setup component, and then complete the alert setup steps. This method enables you to monitor data within a PeopleSoft table; for example, searching for stalled transactions, instead of looking at the results of a PeopleSoft process. When the Alerts process (EOEN_ALERT) is run, the PeopleSoft table is queried and the alert messages can be generated. These messages can be routed to the appropriate person (PeopleSoft user or non-PeopleSoft user) using an email, a PeopleSoft worklist entry, an XML message, or the PeopleSoft Notification Dashboard.

For the PeopleSoft Manufacturing application, sample data includes the following PeopleSoft queries that have been setup to work with the events and notifications framework. These queries may require minor modifications to work in your environment. You can also copy and alter these queries to create new alert messages.

<i>Query</i>	<i>Process Name</i>	<i>Process Category</i>	<i>Description</i>
MG_BCT_ERRORS	MG_ALERTS	MG_BCT_ERRORS	<p>Query the BCT staging tables and generate alert messages for the following manufacturing transactions that are in error:</p> <ul style="list-style-type: none"> • 210 Production Pick Plan • 220 Completion/Scrap • 225 Edit Issue Components • 230 Production Kit Issue/Return • 240 Actual Hours • 250 MFG Replenishment Request • 400 Serial Genealogy
MG_BCT_UNPROCESS	MG_ALERTS	MG_BCT_UNPROCESS	<p>Query the BCT staging tables and generate alert messages for the following manufacturing transactions that have not been processed for more than 120 minutes:</p> <ul style="list-style-type: none"> • 210 Production Pick Plan • 220 Completion/Scrap • 225 Edit Issue Components • 230 Production Kit Issue/Return • 240 Actual Hours • 250 MFG Replenishment Request • 400 Serial Genealogy <hr/> <p>Note: The number of minutes can be changed by modifying the query.</p> <hr/>

Query	Process Name	Process Category	Description
MG_COMP_OVERISSUE	MG_ALERTS	ISS_REPL_COMP_OVERISSUE	<p>Generates alert messages for production IDs and production schedules:</p> <ul style="list-style-type: none"> • With a status of In Process. • With component issue method of Issue or Replenish. • Any component has an issue quantity greater than 110 percent of the scheduled quantity. <hr/> <p>Note: The percentage can be changed by modifying the query.</p> <hr/>
MG_KIT_COMP_OVERISSUE	MG_ALERTS	KIT_COMP_OVERISSUE	<p>Generates alert messages for production IDs and production schedules:</p> <ul style="list-style-type: none"> • With a status of In Process. • With component issue method of Kit. • Any component has an issue quantity greater than 110 percent of the scheduled quantity. <hr/> <p>Note: The percentage can be changed by modifying the query.</p> <hr/>

Query	Process Name	Process Category	Description
MG_LATE_PRODUCTION	MG_ALERTS	LATE_PRODUCTION	<p>Generates alert messages for production IDs and production schedules:</p> <ul style="list-style-type: none"> • With a status of Released or In Process. • Completed quantity is less than 95 percent of the scheduled quantity and are past due. <hr/> <p>Note: The percentage can be changed by modifying the query.</p> <hr/>

See *PeopleSoft Documentation: Approval Framework*

Other Sources of Information

In the planning phase of your implementation, take advantage of all PeopleSoft sources of information, including the installation guides, table-loading sequences, data models, and business process maps. A complete list of these resources appears in the preface in the *PeopleSoft Application Fundamentals Documentation*, with information about where to find the most current version of each.

See the product documentation for *PeopleTools: Setup Manager* and *PeopleTools: Component Interfaces*

Related Links

“PeopleSoft Application Fundamentals Overview” (Application Fundamentals)

Oracle's PeopleSoft Products

This PeopleBook refers to these products:

- PeopleSoft Asset Management
- PeopleSoft Cost Management
- PeopleSoft Engineering
- PeopleSoft Flow Production
- PeopleSoft Inventory
- PeopleSoft Order Management
- PeopleSoft Purchasing

- PeopleSoft Supply Planning

PeopleSoft Application Fundamentals

The *PeopleSoft Manufacturing PeopleBook* provides you with implementation and processing information for your PeopleSoft Manufacturing system. However, additional, essential information describing the setup and design of your system resides in companion documentation. The companion documentation consists of important topics that apply to many or all PeopleSoft applications across the Financials, Enterprise Service Automation, and Supply Chain Management product lines. You should be familiar with the contents of these PeopleBooks.

These companion PeopleBooks contain information that applies specifically to PeopleSoft Manufacturing.

- *PeopleSoft Application Fundamentals PeopleBook*
- *PeopleSoft Supply Planning PeopleBook*
- *PeopleSoft Source-to-Settle Common Information PeopleBook*
- *PeopleSoft Managing Items PeopleBook*
- *PeopleSoft Supply Chain Management Integration PeopleBook*

Pages With Deferred Processing

Several pages in PeopleSoft Manufacturing operate in deferred processing mode. Most fields on these pages are not updated or validated until you save the page or refresh it by clicking a button, link, or tab. This delayed processing has various implications for the field values on the page—for example, if a field contains a default value, any value you enter before the system updates the page overrides the default. Another implication is that the system updates quantity balances or totals only when you save or otherwise refresh the page.

Common Elements Used in This Documentation

Field or Control	Description
As of Date	The last date for which a report or process includes data.
Description	Freeflow text up to 30 characters.
Effective Date	Date on which a table row becomes effective; the date that an action begins. For example, if you want to close out a ledger on June 30, the effective date for the ledger closing would be July 1. This date also determines when you can view and change the information. Pages or panels and batch processes that use the information use the current row.

Field or Control	Description
EmplID (employee ID)	Unique identification code for an individual associated with your organization.
Language or Language Code	The language in which you want the field labels and report headings of the reports to print. The field values appear as you enter them. Language also refers to the language spoken by an employee, applicant, or non-employee.
Process Frequency group box	Designates the appropriate frequency in the Process Frequency group box: Once executes the request the next time the batch process runs. After the batch process runs, the process frequency is automatically set to Don't Run. Always executes the request every time the batch process runs. Don't Run ignores the request when the batch process runs.
Report ID	The report identifier.
Report Manager	This button takes you to the Report List page, where you can view report content, check the status of a report, and see content detail messages (which show you a description of the report and the distribution list).
Process Monitor	This button takes you to the Process List page, where you can view the status of submitted process requests.
Run	This button takes you to the Process Scheduler request page, where you can specify the location where a process or job runs and the process output format.
Run Control ID	A request identification that represents a set of selection criteria for a report or process.
User ID	The system identifier for the individual who generates a transaction.
SetID	An identification code that represents a set of control table information or TableSets. A TableSet is a group of tables (records) necessary to define the company's structure and processing options.
Short Description	Freeflow text up to 15 characters.

Field or Control	Description
Standard Unit of Measure (UOM)	A type of unit used for quantifying in PeopleSoft systems, and usually associated with items. Depending on the application, units of measure might describe dimensions, weights, volumes, or amounts of locations, containers, or business activities. Examples include inches, pounds, work hours, and standard cost dollars.
Unit (business unit)	An identification code that represents a high-level organization of business information. You can use a business unit to define regional or departmental units within a larger organization.

See the product documentation for *PeopleTools: Applications User's Guide*

PeopleTools: Process Scheduler

Chapter 2

Understanding PeopleSoft Manufacturing

PeopleSoft Manufacturing

PeopleSoft Manufacturing consists of a suite of applications that streamline, automate, and augment business processes to provide a comprehensive, global supply chain management solution.

PeopleSoft Manufacturing incorporates into the standard system design such functionality as:

- Synchronized planning and execution throughout the supply chain.
- Process-based, event-driven design.
- Realtime, multiple-constraint-based planning.
- Flexible, hybrid manufacturing model.

PeopleSoft Manufacturing incorporates key technology and functionality, including embedded workflow, realtime planning, mixed-mode production, multimedia attachments, and document attachments.

Solutions for Production Management Challenges

The core mission of a production management system is to provide consistent, well-defined execution and control of manufacturing processes. It must provide accurate, up-to-date information and be flexible to accommodate and manage rapid change. It requires the integration of every task—from product planning and purchasing, to maintaining bills of material (BOMs), to inventory planning and quality control.

The PeopleSoft Manufacturing business solution synchronizes planning and execution throughout an enterprise, enabling you to respond quickly to customer requests and order changes. One of the features the PeopleSoft Manufacturing production management business solution provides is on-demand planning capability. You can perform what-if scenarios without affecting actual data and without running optimization. With up-to-the-minute precision, you can schedule and dispatch production by production area or work area and accurately track production completions and work-in-process. You also have visibility of incoming purchase orders and allocation of inventory. The comprehensive plan-to-produce solution that the PeopleSoft Manufacturing system provides includes powerful core functionality such as backflushing, shift reporting, subcontracting, multiple cost sets, cost roll-ups, Just-In-Time (JIT) support, and serial and lot tracking.

PeopleSoft Manufacturing Production Management Business Solution Applications

The PeopleSoft Manufacturing production management business solution provides an integrated suite of applications that enables you to improve the efficiency of the supply planning and management processes. Whether the production is discrete, repetitive, make-to-order, assemble-to-order, make-to-stock, or

mixed-mode, this PeopleSoft business solution enables you to plan and manage the processes flawlessly. Enterprise-ready applications provide swift, efficient access to the information you need at every level of the enterprise.

The PeopleSoft Manufacturing production management business solution includes:

- PeopleSoft Manufacturing
- PeopleSoft Supply Planning
- PeopleSoft Inventory
- PeopleSoft Quality
- PeopleSoft Cost Management
- PeopleSoft Engineering
- PeopleSoft Flow Production

PeopleSoft Manufacturing

Within PeopleSoft Manufacturing, you can dynamically maintain complex product structures or BOMs, resources, work centers, tasks, and routings. In addition to the basics, such as revision control, component yield, and master routings, PeopleSoft Manufacturing streamlines and enhances key administrative engineering processes. For example, you can automate approvals and controls between engineering and manufacturing, and attach multimedia representations and instructions to complex operation steps.

To complete important tasks such as forecasting, material planning, allocating materials to production, or doing cost roll-ups, you need accurate and reliable BOMs. PeopleSoft Manufacturing enables you to manage all complex product and process structures and multiple subcontracting and nonsubcontracting scenarios.

You can:

- Set up, maintain, and run inquiries and reports on BOMs.
- Copy and delete BOMs and routings.
- Detect looping BOMs.
- Define master routings.
- Obtain crucial BOM costing data.
- Control BOMs by revisions or by effectivity dates.
- Generate automatic revisions.
- Manage revision, BOM, and routing documents with secure versioning using seamless enterprise document management integration.
- View engineering pending engineering change order (ECO) data on PeopleSoft Manufacturing revisions, BOMs, and routings pages, if you have PeopleSoft Engineering installed.

- Specify alternate BOMs for an item, define production options (effective-dated BOM and routing combinations), and define and track multiple outputs (co-products and by-products) throughout the system.
- Define specific component revisions to be associated with an assembly, define substitute items, plan for the end of life of components and the beginning of life for their replacements (use up effectivity), create rework BOMs, and indicate that a component could be a potential output from a teardown order.

After you decide what product you are going to produce, use the detailed routings (including scheduling options, cost codes, tasks, and routing times) and work centers with their associated resources (crews, machines, tools) in PeopleSoft Manufacturing to specify how you will build the product. You can maintain crew, machine, and tool data by incorporating multimedia attachments and text.

PeopleSoft Manufacturing works with PeopleSoft Engineering, PeopleSoft Cost Management, PeopleSoft Supply Planning, PeopleSoft Inventory, PeopleSoft Purchasing, and PeopleSoft Asset Management. Use with PeopleSoft Engineering to transfer BOMs and routings from manufacturing to engineering or engineering to manufacturing by approved engineering change order or by assembly item. You can also make mass BOM changes.

The PeopleSoft Manufacturing system synchronizes planning and execution throughout the enterprise, enabling you to respond quickly to customer requests and order changes. You can manage production for discrete, repetitive, make-to-order, and hybrid environments. Core functionality such as backflushing, shift reporting, subcontracting, JIT support, and serial and lot tracking enables you to shape the production functions to match the way you organize your business.

Use PeopleSoft Manufacturing to establish the foundation of the system based on multiple transaction processing entities (business units). You have the ability to centralize or decentralize certain key business functions. To minimize data redundancy and promote standardization, you can set up data, such as items, to be shared among multiple business units.

PeopleSoft Supply Planning

PeopleSoft Supply Planning is one of the keys to advanced planning and scheduling (APS) capabilities for optimizing the supply chain and providing true asset optimization at the plant level. PeopleSoft Supply Planning provides an APS system that enables realtime optimization of plant-level procurement and production.

PeopleSoft Supply Planning enables you to weigh constraints (such as cost, lead time, capacity, material, and inventory) that may affect your ability to respond to your customer. It can simultaneously optimize material, aggregate capacity, and safety stock, as well as customer requested and scheduled ship dates, producing down-to-the-second production schedules.

PeopleSoft Inventory

PeopleSoft Inventory provides integration capabilities; tracking, analysis, and reporting tools; and item maintenance and storage location features.

PeopleSoft Inventory uses PeopleSoft Workflow to route item approvals to appropriate role users. PeopleSoft Workflow works in conjunction with item approval processing. A scheduled background process scans the database for unapproved items and sends an electronic message to the appropriate role user. PeopleSoft Workflow also supports hierarchical approval processing, sequentially routing an approval item to multiple users.

PeopleSoft Quality

PeopleSoft Quality enables you to control the processes, automate labor intensive tasks, improve communication within the enterprise, and accelerate ISO 9000 certification.

PeopleSoft Quality combines online statistical process control (SPC) data collection with the power of a relational database. You can use PeopleSoft Quality to configure the process environment, but you can also use industry standard quality controls or create your own, monitor process performance, and perform online quality data analysis using the interactive tools in PeopleSoft Quality.

PeopleSoft Cost Management

To operate a business successfully, you must have a complete costing solution. PeopleSoft Cost Management enables you to define the cost foundation, manage product costs, cost and create accounting lines for financial-related inventory transactions, and analyze financial transactions and manufacturing variances.

PeopleSoft Engineering

PeopleSoft Engineering helps you manage the product introduction and change process throughout an enterprise in a dynamic design-to-deploy business solution. Features such as ECOs, engineering change requests (ECRs), engineering bills of materials (EBOMs), engineering routings (ERTGs), item revisions, substitute items, and automated workflow perform together to optimize the engineering and manufacturing process.

See [Suite of PeopleSoft Product Development Business Solution Applications](#).

PeopleSoft Flow Production

PeopleSoft Flow Production focuses on streamlined shop floor execution. Define replenishment attributes to provide a powerful automated tool for signaling replenishment and moving material within the supply chain. The goal is to effectively communicate production and material replenishment signals using a variety of methods, most notably by creating and scanning Kanban cards and labels; routing replenishment requests using Kanban cards, workflow, Pull Lists, and Pull Tickets; or triggering replenishment through completions.

See *PeopleSoft Flow Production Documentation*.

Solutions for Product Development Challenges

The core mission of a solution designed to manage product development is to effectively manage the communication of information between product and manufacturing engineering and the shop floor.

The PeopleSoft Product Development business solution places you in control of the current engineering environment by providing each individual in the engineering process access to the information that they need, as well as the ability to accurately pass that information through each phase of the product development life-cycle. This workflow driven solution enables engineers to proactively process new product introductions from concept through detailed design through prototyping and into full-scale production. Post-release engineering change requests resulting from product defects, enhancements, material and component and substitutions are also effectively managed. The business solution for

managing product development is flexible enough to be tailored to meet the unique requirements of your business; yet, it clearly provides the necessary structure to manage this complex process.

Robust Functionality

The PeopleSoft Product Development business solution enables you to define and maintain ECRs, ECOs, EBOMs, ERTGs, and item revisions.

You can manage documents with secure versioning and a supported computer-aided design (CAD) viewer. Clicking one field sets up the integration to Documentum™. You accurately control product revision history, always associating or accessing the correct documents for the appropriate revision.

You can also roll up and calculate the cost of new or changed products, make mass BOM changes, and incorporate PeopleSoft Workflow.

The work resides in an independent engineering workbench that isolates changes from production data. You can transfer BOMs and routings to manufacturing either by assembly item or by approved ECO.

Integrated Process-Oriented Solution

Engineering, planning, costing, quality, shop floor, marketing, customer service, as well as suppliers and customers can all use one tool set and user interface to access crucial product development data.

The process-oriented approach enables you to view data in terms of business processes rather than as raw transactions, making it easy for managers and directors to access the information that they need to meet operational objectives.

Suite of PeopleSoft Product Development Business Solution Applications

The PeopleSoft Product Development (or design-to-deploy) business solution includes these applications:

- PeopleSoft Manufacturing
- PeopleSoft Cost Management
- PeopleSoft Inventory
- PeopleSoft Engineering

PeopleSoft Engineering

PeopleSoft Engineering provides both specific product development functionality and openness to other systems. It provides an independent engineering workbench environment consisting of EBOMs, ERTGs, ECRs, ECOs, cost roll-up capability, online EBOM comparisons, and seamless integration to a leading document management vault product. This workbench enables you to create and maintain engineering data without affecting production.

This functionality, combined with the workflow-enabled PeopleSoft architecture, enables you to manage the routing, approval, and notification of ECRs, ECOs, and associated BOM and routing additions or changes.

Integrated Engineering Functionality

You can tailor the implementation and complexity of PeopleSoft Engineering to meet your business needs. You can use it to maintain new and pending product structures or to manage the engineering change order approval process throughout the organization. PeopleSoft Engineering delivers:

- An independent engineering workbench that isolates changes from production data.
- ECRs that enable you to receive, review, and maintain and then optionally convert to ECOs.
- Robust ECO functionality and complete change process support.

You can use ECOs to manage the various activities required to implement multiple types of engineering changes.

- EBOMs and item revisions that incorporate all manufacturing BOM features, including a full range of inquiries, as well as online and background looping verification.

You can specify both pending and approved items as components on an EBOM. In addition, you can specify component placeholders in cases where the item number isn't yet known. When managing engineering BOMs using ECOs, you can view pending ECO information within EBOM and revision pages.

- Engineering routings that incorporate all production routing features including the use of work centers, tasks, resources, and copy functions.
- PeopleSoft Navigator and PeopleSoft Workflow capability.

You can maintain and route ECOs within PeopleSoft Workflow so that multiple users can be involved in creating, reviewing, and implementing changes.

- Engineering BOM comparison.

At any point during the development process, you can compare engineering BOMs online with manufacturing BOMs or other engineering BOMs. This is available for engineering routing comparisons.

- Enterprise document management integration with secure versioning.
- Integration with PeopleSoft Manufacturing, including copying BOMs and routings or transferring them by either approved ECO or by assembly item.

You can also make mass manufacturing bills of material (MBOM) or EBOM changes from within PeopleSoft Engineering. Also, there is integration with PeopleSoft Cost Management, including the definition of engineering cost versions for cost simulations.

- A diverse set of inquiries and reports.
- The capability to specify alternate BOMs for an item and define and track multiple outputs (co-products and by-products) throughout the system.
- EBOM, ECO, and ECR data sharing with the suppliers over the internet (if you have also purchased PeopleSoft Engineering.)

Suppliers can view EBOMs and ECOs, as well as view and create ECRs, and use PeopleSoft Workflow to facilitate successful outsourcing.

- The capability to define specific component revisions to be associated with an assembly; automatically generate revisions; define substitute items; plan for the end of life of components and the beginning of life for their replacements (use up effectivity); create rework BOMs; define master routings; and indicate that a component could be a potential output from a teardown order.
- Detailed variance analysis after production is complete.
- The capacity to analyze potential production variances: utilizing workflow to notify appropriate roles when variances exceed a predefined tolerance.
- The capability to define engineering-specific cost versions and related data.

You can roll up and calculate new or changed product costs, as well as estimate the cost of newly designed manufactured items.

Support for the Consumer Product Industry

PeopleSoft Manufacturing addresses the needs of the process-oriented consumer products industry by providing the capability to:

- Define multiple outputs, co-products and by-products (including waste and recycle by-products) that can be tracked throughout the system.
- Create up to 98 alternate BOMs and alternate routings for an item.
- Create effective-dated production options by linking specific BOM and routing combinations.

This provides multiple ways of making the same end item and controls them by effectivity dates, which is particularly useful for seasonal mix variations.

- Satisfy demand created for either the primary or co-product.

PeopleSoft Supply Planning recommends which production option to use to satisfy the demand.

- Create production IDs or schedules with an associated output list and track the completed quantities of the primary, co-products, and by-products.
- Review and report on the detailed history of specific transactions for lot-controlled items using lot trace and lot composition inquiries.

Related Links

[Understanding BOM Maintenance](#)

[Understanding Production IDs and Production Schedules](#)

Flow Production

Flow production is a JIT-based pull system that manufactures to customer order rather than to forecasts. You design the production lines and processes to produce a constantly changing mix of products at a steady rate (known as TAKT time). Use schedules for mixed model production instead of work orders to drive production. The schedules for the mixed models are sequenced based on customer orders, and

material is replenished using Kanban Cards or replenishment requests. The role of material resource planning (MRP) in flow manufacturing is primarily only for long-term planning of material and capacity requirements.

With PeopleSoft Flow Production, you can source a WIP location directly from a supplier, a feeder line, or an inventory storage location. Replenishment requirements can be communicated using workflow, email, fax, and electronic data interchange (EDI). You can use Kanban cards or replenishment requests to request that more material be sent to the WIP location. You can also import Kanban cards and replenishment requests into the system using the replenishment request EIP. Use backflushing, Kanban cards, or a manual system to trigger replenishment.

Kanban replenishment requests can be printed in two formats: pull list or pull ticket. The pull list is a list of Kanban IDs with associated details, similar to a pick list. Pull tickets are similar to Kanban cards in that you print one pull ticket per Kanban ID. Once you complete a pull ticket, the system changes its Kanban ID status to *complete*, which is similar to the way in which a one-time Kanban card works.

If you have PeopleSoft eSupplier Collaboration, after the replenishment request is dispatched, the suppliers can view the request on the internet.

Related Links

“Understanding Supplier Account Activity” (PeopleSoft eSupplier Connection)

Discrete Manufacturing

Typically, you use discrete manufacturing to track production by batches. PeopleSoft Manufacturing defines production batches using production IDs, production type (production, rework, or teardown), quantity, status, backward or forward scheduling, start date, and due date. PeopleSoft Supply Planning uses production IDs to plan for material and capacity usage. You can identify and track costs and variances by discrete order or batch. Production IDs also enable you to report intermediate completions at various operations in an item's manufacturing process. In addition, production IDs let you set up any operation on the item's routing as a subcontracted operation. You move production IDs through the manufacturing process by releasing production, recording completions, closing production, and analyzing and reporting costs and variances by production ID. You track material and conversion costs by production ID rather than day and shift.

Related Links

[Understanding Production IDs and Production Schedules](#)

Repetitive Manufacturing

With PeopleSoft Manufacturing, you can use repetitive methodology for the repeated production of the same products or families of products. You enter quantities for a day of the week, and the system determines the due date when the schedule is added, allowing you to sequence production throughout the day. You can create multiple schedule quantities per shift. You also have the option of adding a production schedule after you have completed manufacturing an item. This feature enables you to record completions for an assembly item. When you record completions, the system automatically creates the production schedule. Following backflushing, components are consumed and costs are posted for the

completed quantity. The system collects costs and variances by day and shift for the production area and item combination.

Related Links

[Understanding Production IDs and Production Schedules](#)

Configure to Order

If you use PeopleSoft Manufacturing with PeopleSoft Product Configurator, you can create make-to-order or assemble-to-order assemblies. PeopleSoft Product Configurator is a rules-based system that enables you to capture customer requirements and dynamically generate corresponding production requirements. You can define order entry pages for entering and validating configuration information. The configuration information that you enter determines the specific components and operations used in the production process.

The production configuration process takes the detailed configuration information captured during order management and sends requirements to PeopleSoft Manufacturing. The production configuration rules enable you to specify component and operation list elements dynamically without having to create standard BOMs or routings for each specific configuration. The production configuration process generates configured production IDs, component lists, operation lists, and configured costs that you can then track using a configuration code through PeopleSoft Manufacturing.

Related Links

[Understanding Production IDs and Production Schedules](#)

Third-Party Integration

This section discusses:

- Integration with item content providers.
- Integration with other product data management systems.
- Integration with product life cycle management applications.
- Integration with manufacturing execution systems (MES).
- Integration with electronic data collection systems.

Related Links

[Integrating with an Electronic Data Collection System](#)

Integration with Item Content Providers

The proliferation of web-based catalogs has provided manufacturers with an easy and effective tool to locate items with the desired specifications at the lowest cost. The traditional catalog function now comes in a variety of forms to improve business to business communication between systems. Examples include

component supplier management systems, market site aggregators, independent trading exchanges, and traditional catalog providers with new web interfaces. These systems benefit the design and purchasing of new products by accelerating item location, maximizing design reuse, and reducing acquisition costs.

The PeopleSoft Manufacturing system provides an EIP to these systems, which maximizes the ease of importing item data into the PeopleSoft database. Using PeopleSoft Application Messaging technology, you can keep item and supplier/item information synchronized within the PeopleSoft system. In particular, you can launch, search, and import supplier/item information from the item content provider into the PeopleSoft database.

Integration with Other Product Data Management Systems

Product data management (PDM) systems effectively and quickly track and implement new product introductions and product changes. These systems provide engineering-centric software that often pulls together CAD and product documentation, BOM and item information, ECOs, and workflow.

PeopleSoft Manufacturing enables ongoing, one-way transfer of items, item revisions, and BOMs from a third-party PDM system to a PeopleSoft system. Using PeopleSoft Application Messaging technology, a third-party system can publish PDM messages to the PeopleSoft system.

Related Links

[Integrating with an Electronic Data Collection System](#)

Integration with Product Life Cycle Applications

You can now send item, revision, and manufacturing BOM information using product life cycle management (PLM) applications to manage new product introductions and change orders externally from PeopleSoft using the product data exchange (PDX) version 1.0 XML format.

See [Understanding the PDX Integration](#).

Integration with Manufacturing Execution Systems

You can use an MES to enable the optimization of production activities from production order launch to completion of finished goods. MES functions include:

- Resource Allocation and Status
- Operations/Detail Scheduling
- Dispatching Production Units
- Document Control
- Data Collection/Acquisition
- Labor Management
- Quality Management
- Process Management

- Maintenance Management
- Product Tracking and Genealogy
- Performance Analysis

To facilitate the flow of information between PeopleSoft and the MES, a group of EIPs provides a flexible link between the two systems. With PeopleSoft Manufacturing, you can:

- Communicate production orders and production schedules from the PeopleSoft system to the MES.
- Communicate item revision information from the PeopleSoft system to the MES.
- Send operation and order completion and scrap information from the MES to the PeopleSoft system.
- Send component item usage from the MES to the PeopleSoft system.
- Analyze production performance in either the PeopleSoft system or the MES.

If you are looking for more detailed operational information, use the MES to gather this information.

You continue to use PeopleSoft Manufacturing for planning, material movement into WIP, validation of completion data, and production costing functions. The PeopleSoft system is the system of record for setup information, including item masters, BOMs, and routings.

Integration with Electronic Data Collection Systems

PeopleSoft Manufacturing and PeopleSoft Flow Production enable you to use a bar code scanner, wedge connected to a PC, or radio frequency device to scan data. The PeopleSoft system provides EIPs that feed data from PeopleSoft Manufacturing and PeopleSoft Flow Production. You can use electronic data collection with these transactions:

- Actual Hours
- Completions
- Component Issue>Returns
- Multiple Output Completions
- Kit Issues>Returns
- Production Picking
- Manual Replenishment Requests
- Kanban Transfers
- Kanban Completions
- Kanban Receiving

You can also print bar coded labels for completed items and bar code-enabled reports.

Note: PeopleSoft SCM applications do not support the printing of bar codes from processes running on OS390 servers. You should run your SQRs that print barcodes on a process scheduler server that is running on a non-OS390 operation system.

Related Links

[Integrating with an Electronic Data Collection System](#)

Additional Manufacturing Functionality

Among the various features that PeopleSoft Manufacturing delivers, you can also find the item substitution, component use up, rounding rules, rework, and teardown functionality to optimize the manufacturing processes.

Item Substitution

With substitute items, you can predefine valid alternates for an item to use when that item is unavailable. Using PeopleSoft Inventory, when an ordered item is unavailable (either temporarily or permanently), the proper replacement item is automatically substituted to fill the order. When using substitute items with PeopleSoft Manufacturing, PeopleSoft Supply Planning automatically suggests the substitute item when the original is in short supply. You can define substitute items at three levels:

<i>Field or Control</i>	<i>Description</i>
Item Definition (Item SetID level)	This level is primarily used for PeopleSoft Purchasing, and is the default for the business unit level substitutions.
Item Attributes by Unit (BU/Item level)	This level is used by PeopleSoft Manufacturing and Inventory, and as a default for setting up BOM/EBOM level substitutions. Substitute information appears by default (optionally) at this level from the SetID level.
Maintain BOMs/EBOMs (BOM/EBOM level)	This level is used by PeopleSoft Manufacturing for all item substitutions. Information at this level appears from the business unit (BU) level.

You can define substitutes for an item in the Item Definition and Item Attributes by Unit pages and use them as defaults when maintaining components on a BOM. When defining substitutes, you can specify start and end dates, as well as a conversion factor. The conversion factor defines how many of the substitutes are required to replace the original item. You can set a priority by which the substitute item with the highest priority or lowest number is substituted first in the PeopleSoft Supply Planning solvers.

Using the Item Definition pages, you can define substitutes for an item. You can define user security and limit access to those individuals permitted to define the substitutes.

You have the option to push the item level substitutes to the Item/BU level. If you create an effective date for a substitute, the item can only be substituted within the effective to obsolete date range.

Use the BOM Maintenance Substitute page to define substitutes for BOM components. The system calculates the quantity based on the conversion factor specified (if defined at the item level) and the original item's quantity per.

You can copy the substitute list from the item attributes at the business unit level to the BOM/EBOM level. This functionality isn't available if substitutes don't exist at the BU level.

BOM inquiries include the list of substitutes for each component. Additionally, you can search for components defined as substitutes using the Component Where Used Inquiry.

When copying and transferring BOMs and EBOMs, you can also copy and transfer the substitute list for the BOM/EBOM components. Additionally, mass maintenance on the substitute list is supported.

PeopleSoft Supply Planning enables you to set the level of substitution that occurs during solving. Define these settings at the BU level:

Field or Control	Description
Allow Substitution	Denotes whether the solvers can fulfill the production component demand of an item with a defined substitutes available supply.
Create Substitute Supply	Determines whether the solvers can create new supply for substitute components to resolve constraints. If this option is not checked, the substitute algorithm may only use on-hand quantities. This option is only possible if substitutes are allowed in the BU.
Check Substitute First	Determines whether the solvers will attempt to use substitute components before using alternate sourcing options. If the flag is not checked, the solver checks alternate sourcing options first before trying to use substitutes to resolve a constraint failure. This option is only possible if substitutes are available for the BU.

PeopleSoft Supply Planning passes the list of valid substitutes to the planning engine. When the projected on-hand quantity of the primary item cannot meet the demand, the feasible and enterprise feasible solvers can use substitutions when creating new planned production, if these criteria are met:

- You selected the **Allow Item Substitution** option on the BU group definition.
- You selected options for allowing substitutions during the running of the corresponding solver.
- No partially completed operations exist for the item.
- Items have not been issued for the operation.
- Item substitution is not frozen for the order.

When a production ID or production schedule is identified as frozen for substitutes, no substitution is performed. Solvers use substitutions for dependent demand only. They do not use substitutions for end items, such as sales orders, transfers, or forecasts. Solvers consider substitute items (all of the items effective for the period considered) according to the order of their priority.

Note: PeopleSoft Supply Planning assigns higher low-level codes to substitute items rather than to primary items. This ensures that primary items are planned before substitute items.

The substitute item projected quantity on hand must meet the total demand of the substitute item quantity needed for each primary item multiplied by the conversion factor. The solvers do not use partial substitutions. If the solvers cannot meet this demand with substitutions, they plan supply for the primary item.

Note: The material solver performs substitutions only when a component is beyond its phase-out date and there is a dependent demand for the component.

Once a substitution occurs, the original item required and the substitute item are received and applied. When the system creates the component list, substitute items are distinguished from the original required component.

Using PeopleSoft Manufacturing, you can make manual substitutions during the picking process and when recording component consumption. You can also indicate a substitute on the component list in advance, viewing the list of valid substitutes for that component. Alternatively, you can request a list of valid substitutes if insufficient supply exists for the original item when generating a production pick plan. During the review plan process, you can indicate that a substitute item was picked, rather than the original.

When recording completions and scrap, you can indicate a substitute item was consumed. You can also freeze the component list to prevent further substitutes from occurring when the next planning optimization occurs.

Related Links

[Understanding BOM Maintenance](#)

“Understanding PeopleSoft Engineering Bills of Material” (PeopleSoft Engineering)

[Understanding Operation Lists](#)

[Understanding Component Issue Methods](#)

[Understanding Recording Completions and Scrap](#)

[Understanding Subcontracting Using PeopleSoft Manufacturing](#)

“PeopleSoft Supply Planning Overview” (PeopleSoft Supply Planning)

Component Use Up

Frequently, you may need the ability to plan for end of life of components and beginning of life for their replacements. This occurs when one component is replaced by another component for reasons such as an engineering change, a more technically advanced component, or lower cost.

Here are some examples when you might want to use this functionality:

- You want to replace a component with another component at a certain point in time, and you want the system to help plan for this occurrence.
- The system should use up the remaining stock of an old component before introducing the new component into production.

- From the key date to begin use of the new component, PeopleSoft Supply Planning needs to plan for the new component while continuing to use the old stock until such time as the old component is used up.

You can define items that are going to be used up or phased out, drive the inventory level of the use up item to zero, and then manually replace the discontinued item on the BOM with a new item. You can store the use-up date for the item at the BU level because each BU can discontinue items with different use-up dates. Use up works in conjunction with item substitution. After the use-up item is consumed, one of the substitutes for the use-up item on the BOM substitution list can replace it on that particular production order or schedule. If no substitution items are defined for the use-up item and the obsolete date for the item has not been changed, the use-up item will be short.

At the Item Attributes by Unit level, you indicate a discontinue date for the item. After this date, PeopleSoft Supply Planning does not create any planned production, purchase, or transfer orders for that item. Define two new statuses, one representing the current item status and the other representing the future status of the item. To use up the item, set the future status to *Discontinued*. When you select a future status, you also define the date that the future status becomes effective, which is the date that planning begins to use up existing supply of the item.

PeopleSoft Supply Planning verifies the current and future status for the item. If the status is set to *Discontinued*, PeopleSoft Supply Planning begins to use up the item on the date indicated.

After the item is used up, PeopleSoft Supply Planning uses substitution logic to determine replacement items. PeopleSoft Supply Planning calculates a projected use-up date and passes it back to production. This is the date when the on-hand balance is projected to reach zero or remain constant for the duration of the planning horizon. You can use this date to initiate ECOs or BOM effective and obsolete changes for the used up item.

Related Links

[Understanding BOM Maintenance](#)

“Understanding PeopleSoft Engineering Bills of Material” (PeopleSoft Engineering)

“PeopleSoft Supply Planning Overview” (PeopleSoft Supply Planning)

Rounding Rules in Manufacturing

Numerous transactions in PeopleSoft Inventory, PeopleSoft Purchasing, and PeopleSoft Manufacturing involve converting item quantities from one unit of measure (UOM) to another. You can ensure consistency when stocking and manufacturing item quantities by establishing whole number validation rules. Whole number validation consists of two components:

Field or Control	Description
Quantity precision	Specifies whether item quantities for a given UOM are expressed as whole numbers or as decimals.
Rounding	Determines how fractional values are rounded so that calculations result in whole numbers.

Related Links

“Accessing Item ID Navigational Features” (PeopleSoft Managing Items)

Quantity Rounding Exceptions in PeopleSoft Manufacturing

Rounding rules do not apply within these three areas of PeopleSoft Manufacturing:

- QPA (quantity per assembly).

Used in BOM maintenance, planning BOM maintenance, component list maintenance, and production option maintenance. The QPA is a precision number and, therefore, should not be rounded. If rounding rules were applied, it would either understate or inflate the number of components required for production. For example, to make 2 assembly A0001s may require 1 component B0004. Thus, when defining the BOM, the QPA for B0004 would be 0.5. If we applied the rounding rules to the QPA, then it would round the QPA for B0004 to 1, thereby incorrectly inflating the QPA and the production costs.

- Cost Roll-Up Process.

Applying the rounding rules to the Cost Roll-Up process causes production costs to be either understated or inflated. For example, A0007 is a component on assembly NB-5000. The QPA = 1 and the yield = 2/3. When you make one NB-5000, you need 1.5 of A0007. If A0007 costs 1.00 USD, then the cost of using A0007 is 1.50 USD. If we rounded the scheduled quantity during the Cost Roll-Up process, you would need 2 A0007s, which would incorrectly inflate the cost to 2.00 USD. Also, if A0007 is a subassembly, then we would need to explode A0007 into its component parts. The deeper the explosion, the greater the affect of the rounding. Thus, to achieve the most accurate cost, we do not round the component scheduled quantity.

- PeopleSoft Supply Planning - Dependent Demand.

You have the option to round or not round dependent demand calculations. You may decide to not round the dependent demand calculation because rounding inflates the actual dependent demand. Rounding problems become more visible as the dependent demand explodes down more levels.

Rework

PeopleSoft Manufacturing enables you to repair or rework previously completed assemblies to replace defective components, fulfill an ECO or product recall, or refurbish scrapped subassemblies.

Using PeopleSoft Engineering and PeopleSoft Manufacturing, you can define rework BOMs if you typically have a standard rework process that requires additional components. Rework routings enable you to define common rework processes for a large volume of rework production. As with production BOMs and routings, you can define a primary rework BOM and routing and up to 98 alternates each.

When you add a rework production ID, you select from the predefined rework BOMs and routings. When you release the rework production ID, the system automatically creates the component list with the assembly item to be reworked in addition to the components defined on the rework BOM. If you select a rework routing, the system also creates an operation list. If you don't choose a rework BOM and a rework routing, you can manually maintain the component list and operation list.

You must create rework production in the *Released* status unless the production is in the future, in which case you create *Firmed* rework production IDs. Once the rework production ID is created, you can either

modify the appropriate start and due dates manually, or if capacity and material availability are concerns and you've created a component list and operation list for the rework, you can optimize the production ID using PeopleSoft Supply Planning. PeopleSoft Supply Planning considers rework requirements on a resource the same as regular production, but it won't create rework production recommendations.

In PeopleSoft Manufacturing, rework production is managed with production IDs, not production schedules. The assemblies to be reworked must be picked from non-nettable, non-WIP locations in PeopleSoft Inventory using the Kit Issue method. Additional components must use the Kit Issue method as well. PeopleSoft Supply Planning does not recommend rework production; it reschedules rework production to repair capacity constraints.

You can record completions and scrap at intermediate operations, consume the additional components, and earn labor costs associated with the rework. When you close production, any additional component and labor costs incurred are charged to the rework expense account. You can view all rework costs in PeopleSoft Cost Management.

Teardown

Often, you need to break an assembly down into its component parts and return the components to inventory. With PeopleSoft Manufacturing, you can:

- Tear down an assembly as built and as planned.
- Base a teardown production ID on an existing production ID so that the original configuration can be retrieved and torn down.
- Specify teardown components on a production BOM and a teardown routing so that you can set up a default configuration and teardown steps in advance, if no existing production ID is available.

Effects of Teardown on BOMs and Routings

When maintaining a production or engineering BOM, you can indicate whether the component could be a potential output from a teardown order. By selecting a check box on the Component Summary page, you designate the component as a teardown output. If you select this check box, the system automatically copies the component details to a new Teardown Outputs page when you create a new teardown order. If you do not select the check box, it indicates that the component is not an output of a torn-down assembly.

You can include teardown outputs when you copy a BOM. Additionally, you can delete the teardown outputs. All BOM inquiries include a new page used to display teardown outputs.

You can create a teardown routing. The teardown routing can differ from the production routing, but it can use any of the existing tasks or work centers defined for production. As with production routings, you have the option of having a primary teardown routing and up to 98 alternates. When copying a routing, you can copy a teardown routing to another item ID or business unit.

Effects of Teardown on Production

When you select the production type of Teardown during production ID maintenance, you indicate whether the list of teardown components is based on a previous component list or the production BOM code. Use the Transaction History search to find the original production ID used to create the item to be torn down. If multiple production IDs were used to create this item, the system generates a list of production IDs. Once you select the production ID from the list, the system copies the components designated as teardown components to the teardown production ID output list, and the assembly item

is copied to the component list. You have the option of using the original operation list or you can use a predefined operation list from a teardown routing.

If there is no original production ID for the item, you use a teardown BOM and routing. When you indicate that a component is a teardown output during production BOM maintenance, the system automatically copies the component details to a teardown page. The outputs appear when the item is torn down and enables you to override the output quantity or operation sequence.

When recording completions on teardown orders, you can report the number of assemblies torn down. The system calculates the quantity of each component removed from the assembly item. In addition, because teardown components are reported at any operation, you are provided the functionality necessary to report teardown completions. You can route the teardown components to another production ID, back to stock, or to a container in the same manner as any completed item. You can reassign lot and serial numbers for the components.

The system uses a teardown variance type to collect any additional expenditure from tearing down the assembly, as well as to account for lost conversion costs.

Yield by Operation

Operation yield allows you to specify the quantity of goods expected to make it through the process. The expected loss can then be incorporated into the cost of the usable end items. Additionally, PeopleSoft Supply Planning can take into account process yield and increment the demand by the expected loss to ensure that demand will still be met once the manufacturing process is complete. This function enables you to specify a yield percentage on the routing operation step and calculates the additional resources necessary to meet the scheduled quantity with the anticipated yield loss.

Serial Genealogy

PeopleSoft Manufacturing enables you to trace the location and constituent components of finished goods items and to trace source and usage of component parts during the production process. Serial genealogy tracks the source and destination of any serialized item. A serialized item may be used in a serialized assembly, scrapped, or used in a higher level serialized assembly that is then shipped to a customer.

Chapter 3

Defining Your Business Unit Structure

Understanding Business Unit Structures

In the PeopleSoft system, business units are operational subsets of an organization that enable you to plan operations based on the way that the organization really functions.

Before you implement PeopleSoft Manufacturing for an organization, take a close look at how the business functions operationally. You must decide how to map the operational business structures—including storage locations, bills of material (BOMs), routings, costs, and procedures—into PeopleSoft Manufacturing.

Prerequisite

You must define the PeopleSoft Inventory business unit before creating manufacturing business units.

See “Establishing a PeopleSoft Inventory Business Unit Structure” (PeopleSoft Inventory).

Establishing Manufacturing Business Units

To define business unit options for a manufacturing business unit, use the Manufacturing Business Unit (MG_BUSIN_UNIT) component. To define manufacturing business unit options, use the Manufacturing Business Unit Options (MG_BUS_UNIT_OPT) component.

Prior to using PeopleSoft Manufacturing, define the manufacturing business units and set parameters such as default rate maintenance and BOM online verification. If you are using PeopleSoft Engineering, you also define how you want to manage engineering BOMs.

There are several ways that you can set up PeopleSoft Manufacturing to run an enterprise. Your selections affect which pages you can access, how you maintain or present data, and how transactions work.

Pages Used to Establish Manufacturing Business Units

<i>Page Name</i>	<i>Definition Name</i>	<i>Usage</i>
Business Unit Definition Page	BUS_UNIT_MFG1	Define manufacturing business units.
MFG Business Unit Options Page	BUS_UNIT_OPT_MG	Set up manufacturing business unit options.

Page Name	Definition Name	Usage
<u>MFG BU Prdn Options Page</u>	BUS_UNIT_OPT_MG_2	Set up manufacturing business unit production options.
<u>Auto Revision Scheme Page</u>	EN_REVISION_SCHEME	Define automatic revision schemes at the manufacturing business unit level.
<u>BOM Message Defaults Page</u>	EN_BOM_MSG_DFLT	Set manufacturing business unit defaults for BOM messages received from a third-party product data management system.

Business Unit Definition Page

Use the Business Unit Definition page (BUS_UNIT_MFG1) to define manufacturing business units.

Navigation:

Set Up Financials/Supply Chain > Business Unit Related > Manufacturing > Manufacturing Definition

This example illustrates the fields and controls on the Manufacturing Definition page. You can find definitions for the fields and controls later on this page.

Manufacturing Definition

Business Unit US008

Description

Short Desc

Inv Business Unit US008

***Status**

Important! Manufacturing business units must be identical to PeopleSoft Inventory business units to link the manufacturing and inventory processes.

To define a manufacturing business unit:

1. Enter values in the **Description** field and the **Short Desc** (short description) field for the manufacturing business unit.

The **Inv Business Unit** (inventory business unit) field is display-only.

- Indicate whether the facility status is *Open* or *Closed*.

Note: You must set the facility status to *Open* to manage production or add BOMs or routings.

MFG Business Unit Options Page

Use the MFG Business Unit Options page (BUS_UNIT_OPT_MG) to set up manufacturing business unit options.

Navigation:

Set Up Financials/Supply Chain > Business Unit Related > Manufacturing > Manufacturing Options

This example illustrates the fields and controls on the Manufacturing Options - MFG Business Unit Options page. You can find definitions for the fields and controls later on this page.

MFG Business Unit Options	MFG BU Prdn Options	Auto Revision Scheme	BOM Message Default
Business Unit US008			
Rate Maintenance / Defaulting <input checked="" type="radio"/> By Work Center <input type="radio"/> By Task		Online BOM Verification <input type="radio"/> Always Verify Online <input checked="" type="radio"/> Never Verify Online	
Default Calendar Codes Production Calendar Code <input type="text" value="DEFAULT"/> Run-time Calendar Code <input type="text" value="DEFAULT"/>		BOM Usage Defaulting <input checked="" type="checkbox"/> Revision Control <input checked="" type="checkbox"/> Auto Revision <input type="radio"/> By Effectivity Date <input checked="" type="radio"/> By Revision	
BOM Maintenance Settings <input checked="" type="checkbox"/> Allow Blank Component Revision <input checked="" type="checkbox"/> Default Component Revision <input checked="" type="checkbox"/> Default Teardown BOM Component <input checked="" type="checkbox"/> Components Align with Revision		Compl and Close Peg Qty Change <input type="radio"/> Notify at Compl and Close <input type="radio"/> Notify at Close <input checked="" type="radio"/> No notify at Compl or Close	

Rate Maintenance/Defaulting

Use the **Rate Maintenance/Defaulting** group box to enter conversion rates for work centers or tasks.

If you determine that labor, machine, and overhead rates and costs are to be tracked by department or cost center, select **By Work Center**; all tasks assigned to the work center will use the same conversion rates and overhead rates. If you determine rates and costs are to be tracked by crew or resource, select **By Task**. With this option, each task can have a unique conversion and conversion overhead rate.

For example, if you select **By Work Center**, then you can access the conversion code fields on the work center pages but not on the task pages.

Online BOM Verification

Specify how to handle online verification for production BOMs. If you use PeopleSoft Engineering, you can also specify how to handle online verification for engineering BOMs:

Field or Control	Description
Always Verify Online	Runs the process online during BOM maintenance.
Never Verify Online	Runs the verification as a deferred process.

Note: When BOMs are complex and deep, select **Never Verify Online** to improve BOM maintenance performance, and run the BOM verification process from the BOM Verification page.

Default Calendar Codes

To indicate a default production calendar for the manufacturing business unit, select **Production Calendar Code**. You create calendar codes and their associated calendars using the Calendar Code Definition page. The first calendar code and associated calendar that you create for the business unit is the default for this field. It is treated as the primary production calendar for the business unit. If a calendar code is not associated with a work center—or if the calendar code associated with the work center is not effective yet or is obsolete—the system uses the calendar defined here to schedule production.

The **Run-time Calendar Code** field is display-only. It indicates which calendar code is used as the default production calendar for the business unit.

When you associate a different calendar code than the current runtime calendar code, the system optionally sends a workflow notification to selected roles that you define. This workflow notification indicates to the user (such as a production control manager) that the calendar originally used for scheduling is not in sync with the calendar code specified for the business unit.

If you do not define a calendar code and an associated calendar for the business unit—or if the production calendar associated with the business unit runs out—PeopleSoft Manufacturing uses the default five-day work week. A five-day work week is defined as Monday through Friday, with one shift. You set it up using the Work Week Definition page.

BOM Usage Defaulting

The **BOM Usage Defaulting** group box enables you, at the business unit level, to indicate whether you maintain BOMs:

- In PeopleSoft Manufacturing and PeopleSoft Engineering.
- By revisions.
- By effectivity dates (and whether revisions can be automatically generated for revision controlled items).

Field or Control	Description
Revision Control	Select to generate BOMs by revisions.
Auto Revision	Select to automatically generate revisions.

Field or Control	Description
By Effectivity Date	Select to maintain BOMs by effectivity date.
By Revision	If you are maintaining BOMs by effectivity date, you can specify an effective revision that equates to an effectivity date.

While the value that you define here (at the business unit level) is the default at the item setup level, you can overwrite this at the item level.

To automatically create revisions to items, use the mass maintenance functionality in PeopleSoft Manufacturing or PeopleSoft Engineering. You can use either of these features:

- BOM Mass Maintenance by Mass Maintenance Code (MMC)
- BOM Mass Maintenance by Engineering Change Order (ECO)

The mass maintenance process creates revisions for those items that have both revision control and automatic revision selected. In other cases, the process functions as a regular mass maintenance process without creating automatic revisions.

Use the Auto Revision Scheme page in this component to define the scheme that the system uses to generate automatic revisions.

BOM Maintenance Settings

Field or Control	Description
Allow Blank Component Revision and Default Component Revision	Select these two check boxes to define component revision default settings that affect the BOM Maintenance pages. The check boxes only apply to revision-controlled items. In addition, they operate independently of each other. Therefore, there are four possible combinations of settings.
Default Teardown BOM Component	Select to indicate business unit settings for teardown components. You can only select this check box for teardown production orders. If you select this check box, the system indicates that the components are teardown outputs on the BOM Maintenance Component Details page when you add or change components on a BOM. Note: This check box only affects teardown components with a source code of Make or Buy. If teardown components are selected on a BOM, the system copies the components to the output list when you create a teardown production order, based on the BOM code.

Field or Control	Description
<p>Components Align with Revision</p>	<p>Select to indicate that any component existing on a BOM for a revision-controlled assembly must be associated with one of the assembly revisions. This is the default setting, and it is the most common setting for revision-controlled environments.</p> <p>However, if the environment requires a change to the BOM structure without rolling the revision of the parent assembly, then deselect this option to enable you to do so. This can be required in outsourcing scenarios where you are the contract manufacturer and are required to adhere to customer-specified revision in manufacturing.</p> <p>When this option is deselected, you can introduce a new component against the current revision of the assembly as of the current date versus the start date of the current revision for the assembly. In this scenario, the components required to build the assembly for the revision-controlled item are based on the revision specified, including any additional component changes up to the date specified when creating the component list.</p> <hr/> <p>Note: In addition to deselecting this option, you must also set the assembly item's business unit item-attributes manufacturing setting for BOM usage to By Effective Date so that new components for that assembly can be created for dates not associated with the assembly revision.</p> <hr/>

Compl and Close Peg Qty Change

This group box controls how often pegging notifications are sent to a user or group of users when changes are made on a production ID. PeopleSoft Manufacturing has a number of common circumstances that could cause excessive pegging notifications to be generated. For example, normal scrap activity during the completions process could result in quantity reduction notifications. Completing serial controlled items would generate a receipt notification for every serialized item. The close process generates close notifications for every order closed.

PeopleSoft Manufacturing offers three options for controlling the number of pegging notifications generated during the completions and close processes:

- **Notify at Compl and Close:** Enables all normal pegging notifications including order quantity changes and closing of production.
- **Notify at Close:** Enables normal notifications in the production close process and suppresses order quantity change notifications during compl
- **No Notify at Compl or Close:** Suppresses close notifications during the close process and suppresses quantity change notifications during completions.

Related Links

[Understanding BOM Maintenance](#)

“Understanding PeopleSoft Engineering Bills of Material” (PeopleSoft Engineering)

[Work Week Definition Page](#)

[Default Prdn Calendar Week Page](#)

[Additional Manufacturing Functionality](#)

“Define Business Unit Item - Manufacturing: General Page” (PeopleSoft Managing Items)

“Understanding Pegging” (PeopleSoft Supply Chain Management Common Information)

MFG BU Prdn Options Page

Access MFG BU Prdn Options page (Set Up Financials/Supply Chain, Business Unit Related, Manufacturing, Manufacturing Options, MFG BU Prdn Options).

This example illustrates the fields and controls on the Manufacturing Business Unit Production Options page. You can find definitions for the fields and controls later on this page.

MFG Business Unit Options	MFG BU Prdn Options	Auto Revision Scheme	BOM Message Default
Business Unit US008			
Calc Per Order for Prdn Sched <input checked="" type="radio"/> Calc Per Order for Prdn Sched <input type="radio"/> Don't Calc Per Ord on Prdn Sch		Auto Release Options for PID <input checked="" type="radio"/> Prompt for Auto Release <input type="radio"/> Auto Release <input type="radio"/> No Auto Release	
Freeze Planning Defaults <input type="checkbox"/> Rework <input type="checkbox"/> Teardown		PID Completion Option <input checked="" type="radio"/> On-line <input type="radio"/> Deferred	
Auto Freeze Planning Option <input checked="" type="radio"/> Auto Freeze Planning <input type="radio"/> No Auto Freeze Planning		Completion Warnings <input checked="" type="checkbox"/> Pending Component Issue Qty <input type="checkbox"/> Outstanding Comp. Issue Qty	
BOM Explosion By Date <input type="radio"/> By Start Date <input checked="" type="radio"/> By End Date		Backflush Lot Option <input checked="" type="radio"/> Manual <input type="radio"/> Earliest Expiration Date <input type="radio"/> Earliest Available Date	
EIP Subscription Trans Option <input type="checkbox"/> Auto-Submit Prcs Sched Rqst		Variance Drilldown Option <input checked="" type="checkbox"/> Enable Variance Drilldown	

Calc Per Order for Prdn Sched

Use the **Calc Per Order for Prdn Sched** (calculate per order for production schedule) group box to indicate if you want the system to update the pending issue quantity for any component on a production schedule's component list whose quantity is per order.

Select **Calc Per Order for Prdn Sched** if you want the pending issue quantity for a component set to the per order amount each time that you record a completion on a production schedule. This means that the per order quantity will be consumed from the work-in-progress (WIP) location with each backflush, unless you use the Edit/Issue Components page to zero-out the pending issue quantity.

Select **Don't Calc Per Ord on Prdn Sched** (don't calculate per order on production schedule) if you do not want the pending issue quantity automatically filled. Selecting this option means that you must use the

Edit/issue Components page whenever the components order quantity should be consumed from the WIP location following a backflush.

Auto Release Options for PID

Use the **Auto Release Option for PID** to indicate how you want to handle the releasing of production IDs on the shop floor for the manufacturing business unit. You can select from any of these options:

<i>Field or Control</i>	<i>Description</i>
Prompt for Auto Release	<p>The system prompts you to release the selected production ID (with a status of Entered or Firm) when recording completions, scrap, or editing components.</p> <p>Click <i>Yes</i> to automatically release the production ID and streamline the production process. Click <i>No</i> to select an alternate production ID if one was selected in error.</p>
Auto Release	<p>The system automatically releases selected production IDs with a status of <i>Entered</i> or <i>Firmed</i> from the Record Completions/Scrap and Edit Issue Components pages. You are not prompted to release the production ID.</p>
No Auto Release	<p>The system does not allow you to automatically release production. You must use the Production ID Status Change page or the Production Status Change page to release production for the manufacturing business unit.</p>

Freeze Planning Default

Use the **Freeze Planning Default** group box to indicate if new rework or teardown orders for this business unit should be frozen. The Planning engine does not reschedule frozen orders to repair capacity violations.

Select **Rework** to freeze all new rework orders.

Select **Teardown** to freeze all new teardown orders.

Note: The system creates new production orders in the unfrozen status.

Use Planning Attributes to override this default check box. You can also manually unfreeze an order in the Planning engine and rerun a solver to reschedule the order.

See [Frozen Production](#).

PID Completion Option

Use the **PID Completion Option** group box to indicate when you want to run the completions process for the business unit. You can select one of these options:

Field or Control	Description
On-Line	This option indicates that you process completions online. The update process runs immediately and calculates associated production costs—earned labor and machine hours, conversion codes, and overhead conversion costs. It also consumes components and routes completed material to storage locations or other production.
Deferred	This option indicates that you are running the completions process at a later time. All associated production costs are calculated when you run the Completions Update process.

Auto Freeze Planning Option

You can set up the autofreeze planning option so that the system automatically freezes operations for production based on specified events in the manufacturing process. This enables PeopleSoft Supply Planning to reschedule production based on particular operations. You can also freeze or unfreeze operations manually while maintaining the operation list.

Select **Auto Freeze Planning** to have the system to freeze production operations when you've recorded any of these transactions for that operation:

- Actual hours
- Operation completions
- Operation scrap
- Setup complete
- By-product or co-product completions

The system does not automatically freeze an operation if you've recorded material consumption for that order (issue, kit, or edit components) *unless* you've also recorded completions for that operation. Select **No Auto Freeze Planning** if you do not want the system to automatically freeze production operations.

Completion Warnings

Use these check boxes to indicate the situations in which warnings should be sent during the completions process:

Field or Control	Description
Pending Component Issue Qty	Select this check box to send warnings if there are pending component issue quantities during a backflush. Pending quantities can be caused to incomplete lot IDs, negative quantities when the business unit does not allow negative quantities, or other causes.

Field or Control	Description
Outstanding Comp. Issue Qty	Select this check box to send warnings if there are outstanding component issue quantities. This warning occurs if you are completing quantity at the last operation sequence and at least one component's total issue quantity is less than the scheduled quantity.

These same fields are defined at the item-level of a production area using the Item Detail - Detail page (Production Control, Define Production, Production IDs/Schedules, Production Area, Item Detail, Detail).

BOM Explosion By Date

Field or Control	Description
By Start Date or By End Date	Select to indicate whether the BOM explosion for creating a new production component list should be based on the production start date or end date.

Backflush Lot Option

Use this group box to define the backflush lot selection rule at the business unit level. The backflush lot selection rule enables you to determine which lot IDs are selected for consumption when a backflush is performed for a production ID or production schedule. The option selected on this page can be overridden for an individual item within the business unit using the Define Business Unit Item - Manufacturing: General page.

The options for the backflush lot selection rule are:

Field or Control	Description
Manual	(default) Select this option to require the user to enter the specific lot IDs consumed during backflushing. The system does not automatically select any lot IDs
Earliest Expiration Date	Select this option to have the system select the lot IDs for consumption based on the lot expiration date. The system first selects the lots with the earliest expiration date.
Earliest Available Date	Select this option to have the system select the lot IDs for consumption based on the lot available date. The system first selects the lots with the earliest available date.

Note: Before changing the backflush lot selection rule, it is recommended that you process all pending transactions in the staging tables (BCT tables) that impact production completion. Changing the backflush lot selection rule can impact how these BCT transactions are processed.

See [Automatically Consuming Lot-Controlled Stock During a Backflush](#).

EIP Subscription Trans Option

Select the Auto-Submit Pres Sched Rqst check box to automatically launch the Completions Update (SFPDCDRV) process after the completion of the Inbound File Publish (EOP_PUBLISHF) process (with the file identifier MFG_PRODUCTION). However, running the Completions Update process after every completions inbound message can slow performance.

Deselect this check box if you want to run the Completions Update process at a later time. Use the Process Scheduler's scheduling functionality to determine when you want to run the Completions Update process.

Variance Drilldown Option

Select the Enable Variance Drilldown check box to capture detailed production variance data in the Production Variance Detail record (SF_VARS_DETAIL) and the Configuration Variance Detail record (SF_CFGVAR_DET) during the Close Production process (SFS1100). Information about how production variances are calculated can then be viewed in the Production Variance Drilldown- Review Variances page (Production Control, Close and Analyze Production, Production Variance Drilldown). When applicable, the Reopen Production process (SFS1200) can reverse postings in the Production Variance Detail record and the Configuration Variance Detail record. In addition, after the Cost Accounting Creation process has been run, the Posted Variance Drilldown page (Cost Accounting, Inventory and Mfg Accounting, Analyze Production Costs, Posted Variance Drilldown) can be used to view the accounting lines related to the production variances. Links on both the Production Variance Drilldown – Review Variances page and the Posted Variance Drilldown page enable you to drill down into more detailed information or drill up into summary information.

Note: The Production Variance Detail record and the Configuration Variance Detail record can become large and require regular purging.

Related Links

[Understanding Component Lists](#)

[Understanding Releasing Production and Changing Production Statuses](#)

[Understanding Operation Lists](#)

[Understanding Recording Completions and Scrap](#)

Auto Revision Scheme Page

Use the Auto Revision Scheme page (EN_REVISION_SCHEME) to define automatic revision schemes at the manufacturing business unit level.

Navigation:

Set Up Financials/Supply Chain > Business Unit Related > Manufacturing > Manufacturing Options > Revision Scheme

This example illustrates the fields and controls on the Manufacturing Options - Auto Revision Scheme page. You can find definitions for the fields and controls later on this page.

Note: This page is primarily intended for use during implementation of the system.

Revision Scheme

You generate automatic revisions by using the mass maintenance functionality. Before creating an automatic revision, however, the system must determine which scheme or sequence of revisions to use to create the next revision. On the Revision Scheme page, you create such a revision scheme by entering sequence numbers as well as an alphanumeric order for the revisions. The system uses this scheme to automatically increment sequenced assembly revisions. Each time new revisions are automatically generated, they follow the order defined in this list of sequenced revision names. For example, if the current revision for an item is C, then the next automatic revision will be D. If the current revision doesn't exist in the scheme, then the system creates the revision with the lowest non-existing sequence number. For example, if an item currently has revisions A, B, and X, then the next revision created for the item will be C.

You can insert interim revisions into the sequence scheme if needed. For example, if the sequence is 100, 110, 120, you can add a 115 between the 110 and 120 revisions. Changing the revision scheme does not update the sequence of revisions already in use on an item.

Note: You cannot enter duplicate sequence numbers or revisions numbers or letters. If you try to change or delete revision names that are already in use on a BOM, you receive a warning message.

BOM Message Defaults Page

Use the BOM Message Defaults page (EN_BOM_MSG_DFLT) to set manufacturing business unit defaults for BOM messages received from a third-party product data management system.

Navigation:

Set Up Financials/Supply Chain > Business Unit Related > Manufacturing > Manufacturing Options > BOM Message Default

This example illustrates the fields and controls on the Manufacturing Options - BOM Message Default page. You can find definitions for the fields and controls later on this page.

If you are using effectivity dates, enter the obsolete date for the components of the incoming BOM message.

Indicate the component quantity to assign to incoming BOM message components.

In the quantity **Per** field, enter whether you want the component quantity for incoming BOM messages to apply per assembly or per order. If you set the quantity per assembly—and when the system determines component requirements in PeopleSoft Supply Planning—the system divides the quantity-per by the BOM quantity and then multiplies that result by the demand or order quantity. If you set quantity **Per** field to *Order*, the system uses the quantity regardless of the demand quantity or order size.

Component yield is the expected percentage of usable components within a batch of components issued to production. If you know that components may be damaged during the issuing or assembly process, you can account for that loss here. Indicate the yield to be assigned to incoming BOM messages.

Select **Subcontract Supply** if you are subcontracting all or part of the manufacturing process and you want to assign this status to incoming BOM messages.

Select **Non-Owned Item** for incoming BOM messages if you do not own the component, and you want to indicate that the component is consigned to you or is supplied by a customer.

You can indicate if incoming BOM message components should be a potential output from a teardown order. When you select **Teardown**, the system designates the component as a teardown output.

Related Links

[Understanding BOM Maintenance](#)

[Integrating with an Electronic Data Collection System](#)

Chapter 4

Establishing Production Calendars

Understanding Production Calendars

Before starting production, you must define, at a minimum, the hours of operation for a five-day work week that can be used when production runs for one shift, Monday through Friday. If your enterprise works multiple shifts, or if you want the planning and scheduling functions to consider holidays, weekends, or planned downtime, you must create a production calendar. If all work centers and resources are available during the same working hours, you must define only one calendar.

However, if different work centers have different hours of operation, you can optionally define alternate calendars to accommodate these exceptions. Create production and alternate calendars by first defining a calendar code and then defining the hours of operation for that calendar code. Tie these calendar codes to a business unit, work centers, and resources to define when your enterprise is available for production. You can assign one calendar code to multiple resources and work centers, for example, when two work centers share the same hours of operation.

Note: Before establishing production calendars, define the PeopleSoft Inventory and Manufacturing business units.

Related Links

[Understanding Business Unit Structures](#)

Using Production Calendar Codes

With PeopleSoft Manufacturing, you can create standard and alternate production calendars for your enterprise to cover an entire year or a partial year. You create one or more calendar codes and enter calendar information for each code. You can assign alternate calendar codes to work centers whose hours of operation differ from that of the business unit. In addition, if you are using PeopleSoft Supply Planning, you can assign these calendar codes to resources.

You can assign a single calendar code and its associated calendar to multiple work centers if they have similar working and nonworking days.

This section discusses:

- The process to define production calendar codes.
- The scheduling hierarchy to determine available production time.
- How to assign calendar codes to business units, work centers, and resources.

Process to Define Production Calendar Codes

This diagram illustrates how the system finds the production calendar code used by the scheduling and planning functions. The system first looks to the work center, if no calendar code is defined, then the system looks to the business unit and then the resource (if PeopleSoft Supply Planning is used). If no calendar code is defined then the system uses the defined work week.

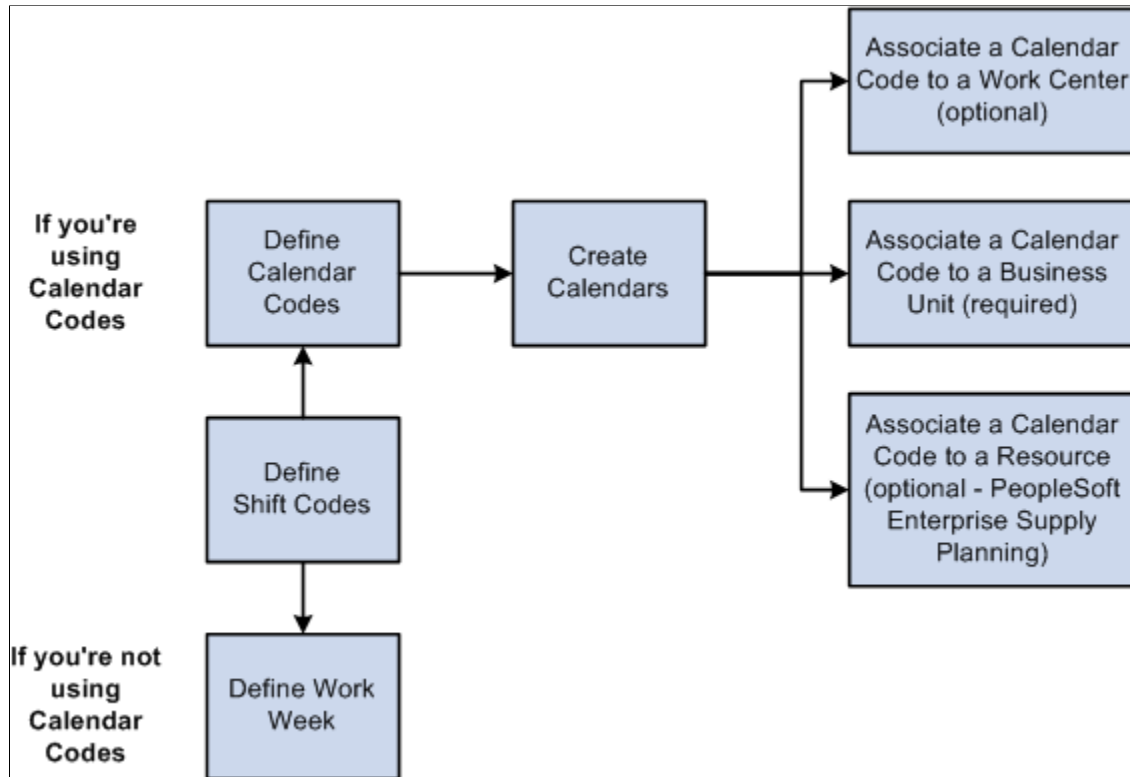

Scheduling Hierarchy to Determine Available Production Time

The scheduling and planning functions in PeopleSoft Manufacturing use a hierarchy to determine available production times and days:

1. If a calendar code has been defined for the routing operation's work center, the system uses the calendar code assigned to the work center.
2. If a calendar code hasn't been associated to the work center, the system uses the production calendar code defined for the business unit.
3. If a production calendar isn't available, the planning and scheduling functions base start and due dates and times on a five-day work week.

The system defines a five-day work week as Monday through Friday with one shift. The specific hours of operation for the shift are user defined. The defined shift must start and end on the same day.

If you are using PeopleSoft Supply Planning, the system creates a plan based on the calendars assigned to the particular resource or work center. If a calendar isn't associated with a resource or work center, the system uses the business unit's default production calendar to create a plan.

Assigning Calendar Codes to Business Units, Work Centers, and Resources

Once you create calendar codes and the associated run time calendar, you can associate them to the business unit, work centers, and resources. Once you attach the calendar code, its associated run time calendar code appears, indicating that the calendar is created and recognized in the planning and scheduling process.

Business Units

Assign the calendar code to the business unit using the Manufacturing Options page. If a calendar code is not associated with a work center, PeopleSoft Manufacturing uses the calendar code defined on the Manufacturing Options page to schedule production for all work centers that do not have a work center calendar defined within the business unit.

Important! Designate only one calendar code as the business unit's production calendar. When you add the first calendar code for a business unit, PeopleSoft Manufacturing automatically defines it as the *default* production calendar.

Work Centers

Associate the appropriate alternate calendar code to the work center using the Work Center Attributes 1 page. If you associate a calendar code to a work center, PeopleSoft Manufacturing uses the calendar associated with the code to schedule production for this particular work center. PeopleSoft Supply Planning uses these calendars when you are doing aggregate capacity planning. If a calendar code isn't associated with a work center, PeopleSoft Manufacturing schedules production for the work center based on the default calendar associated with the business unit.

Production Resources

If you are using PeopleSoft Supply Planning, associate the appropriate calendar code to a resource—tool, machine, or crew—using the appropriate Planning Options page. If you associate an alternate calendar code to a resource, PeopleSoft Supply Planning uses this calendar to schedule production while optimizing the plan. If a calendar code isn't associated with the resource, PeopleSoft Supply Planning schedules production for the resource based on the default calendar associated with the business unit.

Related Links

[Understanding Operation Lists](#)

[Understanding Work Centers](#)

[Understanding Resources](#)

Defining Shift Codes

To define shift codes, use the Shift Code Definition (MG_SHIFTS) component.

This section discusses how to define shift codes associated with production calendars. When setting up production and alternate calendars or the default production calendar week, you can specify which shifts are in operation for a given day. To set up the five-day work week or any calendar, first define shift codes.

Page Used to Define Shift Codes

<i>Page Name</i>	<i>Definition Name</i>	<i>Usage</i>
<u>Shift Code Definition Page</u>	MG_SHIFTS	Define shift codes.

Shift Code Definition Page

Use the Shift Code Definition page (MG_SHIFTS) to define shift codes.

Navigation:

Set Up Financials/Supply Chain > Business Unit Related > Manufacturing > Define Production Calendars > Shift Code Definition

This example illustrates the fields and controls on the Shift Code Definition page. You can find definitions for the fields and controls later on this page.

Shift Code	Description	Start Time	End Time	*Shift Premium	Prdn Date Time
1	First Shift	7:00AM	3:00PM	1.000000000000	Start Time
2	Second Shift	3:00PM	11:00PM	1.000000000000	Start Time
3	Third Shift	11:00PM	7:00AM	1.000000000000	Start Time

Shift Code

While you can specify only three shifts per calendar day or one for the work week definition, you can maintain an unlimited number of shift codes. Designate a start time and end time, depending on the calendar day.

For example, you can define three shift codes, spanning all 24 hours in a day, and associate them with Monday through Friday. You can then define a fourth shift code with a start and end time of 8 a.m. and 12 p.m. respectively and associate that shift code only with Saturday. When associating a shift code to the five-day work week, the hours of operation defined for the shift code are applied to Monday through Friday.

Production date and shift information is defined as the working day and shift where component and production scheduling can be accomplished. Although you define the shift codes here, use these codes, along with the production dates, to define the default production calendar week and production and alternate calendars. For example, on the production calendar for the month of March, specify that you are working three shifts on 3/27/03. You've just defined a production date of 3/27/03 with three production shifts: 1, 2, and 3. If you are using the system production work week, then the system automatically defines the production dates as the calendar dates associated with Mondays through Fridays. Because you can associate only one shift for all five days, the production shift is always defined as 1. For example, the

last Friday for the month of March is 3/26/03. The production date is 3/26/03 and the production shift is 1.

Actual date and time is defined as the actual physical date and time that the production is scheduled to begin or end based on the standard calendar. In most cases, the production dates and actual dates are the same. If you have a production shift that spans two days, the actual date for production may be different than the production date. The system determines the actual date by the actual time that the production is scheduled to start or end within the production shift.

If you are defining a shift that spans multiple dates, select a production date time. Values are:

- *Start Time*: The manufacturing production date to be the date associated with the start of the shift.
- *End Time*: The date associated with the end of the shift.

If the shift doesn't span multiple dates, the production date time is automatically set to *Start Time*, because both the start and end time of the shift is associated with the manufacturing production date. In this case, this field is unavailable.

The system determines the production date and shift information based on the actual start time or end time of the shift. These examples illustrate how the system determines the manufacturing production date based on whether you want the start time or end time of the shift to define the manufacturing production date.

Example 1: Production Date Time Set to Start Time

A company runs three shifts where the third shift starts at 8 p.m. and ends at 2 a.m. This shift is defined with the start time associated with the production date. A production schedule can now be defined for a production due date and due shift. In our example, production is due to complete on 3/26/03 at 1:30 a.m. Because the shift in which production takes place actually begins on 3/25/03 at 8:00 p.m., the production date and shift is recorded as 3/25/03, shift 3. The actual date and time still appears as 3/26/03 at 1:30 a.m.

Example 2: Production Date Time Set to End Time

A company runs three shifts where the first shift starts at 10 p.m. and ends at 6 a.m. This shift is defined with the end time associated with the production date. A production schedule can now be defined for a production due date and due shift. In our example, production is due to complete on 3/27/03 at 5:30 a.m. Because the shift ends at 6:00 a.m. and the **Prdn Due Date** (production due date) field is set to the shift's end time, the production due date and shift is 3/27/03, shift 1. The actual date and time still appears as 3/27/03 at 5:30 a.m.

Note: Visibility of the production date and shift, as well as the actual date and time for production IDs and production schedules is available throughout PeopleSoft Manufacturing. This applies for both actual start and due production information.

Establishing Business Unit Calendars

To define a work week, default production week, or a manufacturing calendar, use the Work Week Definition (MG_WORK_WK_DEFN), Default Production Week (MG_CAL_DEF_WEEK), and Calendar Code Definition (MG_CALENDAR) components.

After you define the shifts in operation for a given day, define the business unit calendars. The five-day work week is also used if the production calendar code isn't yet effective or is obsolete. These calendars define which days the manufacturing business unit is available and the hours of operation for each day. The start and due dates for production and for each operation are determined based on the business unit calendar that you define.

This section discuss how to establish business unit calenders:

Pages Used to Establish Business Unit Calendars

<i>Page Name</i>	<i>Definition Name</i>	<i>Usage</i>
<u>Work Week Definition Page</u>	MG_WORK_WK_DEFN	Define a five-day, one-shift work week.
<u>Default Prdn Calendar Week Page</u>	MG_CAL_DEF_WEEK	Use to facilitate data entry if you are defining a calendar for a calendar code.
<u>Calendar Code Definition Page</u>	MG_CALENDAR	Define production calendar codes.

Work Week Definition Page

Use the Work Week Definition page (MG_WORK_WK_DEFN) to define a five-day, one-shift work week.

Navigation:

Set Up Financials/Supply Chain > Business Unit Related > Manufacturing > Define Production Calendars > Work Week Definition

This example illustrates the fields and controls on the Work Week Definition page. You can find definitions for the fields and controls later on this page.

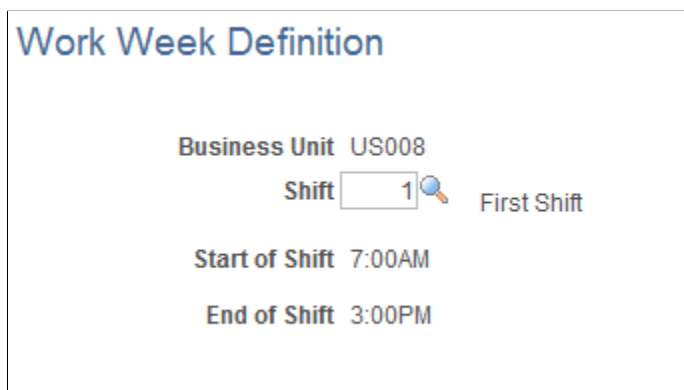

Note: If you don't define at least one calendar code with its associated calendar, or if the production calendar associated with the business unit becomes obsolete, the planning and scheduling functions assume that you are working a five-day work week. The system defines a five-day work week as Monday through Friday, with one shift. Define the specific hours of operation for the shift; the shift must start and end on the same day.

Field or Control	Description
Shift Code	Select only a single shift code. However, if you work more than one shift, the shift code should include all hours of operation for all shifts, as long as the start and end times don't span multiple days. Alternatively, if more than one shift is applicable, or you have a shift that spans multiple days, you may want to define a production calendar. When using a five-day work week for scheduling, define the hours of operation for the five days. Do this by selecting a shift code to associate with the work week.
Start of Shift and End of Shift	These fields appear by default from the Shift Codes page.

Related Links

[Defining Shift Codes](#)

Default Prdn Calendar Week Page

Use the Default Prdn Calendar Week page (MG_CAL_DEF_WEEK) to use to facilitate data entry if you are defining a calendar for a calendar code.

Navigation:

Set Up Financials/Supply Chain > Business Unit Related > Manufacturing > Define Production Calendars > Define Production Week

This example illustrates the fields and controls on the Default Prdn Calendar Week page. You can find definitions for the fields and controls later on this page.

Default Prdn Calendar Week

Business Unit US008

	Sun	Mon	Tue	Wed	Thu	Fri	Sat
Shift A	<input type="text" value="1"/>	<input type="text" value="1"/>	<input type="text" value="1"/>	<input type="text" value="1"/>	<input type="text" value="1"/>	<input type="text" value="1"/>	
Shift B		<input type="text" value="2"/>	<input type="text" value="2"/>	<input type="text" value="2"/>	<input type="text" value="2"/>	<input type="text" value="2"/>	
Shift C		<input type="text"/>	<input type="text"/>	<input type="text"/>	<input type="text"/>	<input type="text"/>	
Day Off	<input checked="" type="checkbox"/>	<input type="checkbox"/>	<input type="checkbox"/>	<input type="checkbox"/>	<input type="checkbox"/>	<input type="checkbox"/>	<input checked="" type="checkbox"/>

When defining a calendar, use this default week to fill each week of a month. This default week should represent a typical production week, including or excluding weekends. Because the system automatically creates the production month using this default week, this page is the preparatory step to defining

production months within calendar codes. You can then make changes for individual days within the month on each month's calendar.

For each day in the week, you can assign up to three shifts (Shifts A, B, and C) from among the shifts defined using the Shift Code Definition page. You cannot enter duplicate shifts for the same day, and the shifts that you select for any given day cannot overlap. The shift times must be chronological beginning with the earliest shift listed first and the latest shift listed last. The system does allow shift schedule gaps as long as the shift times remain chronological. The shift times must also be chronological across all days of the week.

If you select the **Day Off** check box, you are defining the day as a day off; therefore, you cannot define any shift for that day on this page.

However, you can still change each shift or days off for any day of the week when actually defining a monthly calendar.

Understanding Production Calendar Codes

Once you define the shift codes and default production calendar week for the business units, you can define one or more calendar codes with their associated calendar for each business unit. You can then use these calendar codes within each business unit to set up the calendars for business units, work centers, production resources, and enterprise resources.

You can create calendar codes for an entire year, a partial year, or a few months within the year. You can define a primary production calendar code for a business unit, then create alternate calendar codes to use as exception calendars for work centers and resources.

Keep these in mind when you create calendar codes:

- The first calendar code and associated calendar is automatically set to the business unit's default calendar.

To use a different calendar as the production calendar, define that calendar code and use the Manufacturing Options page to change the default production calendar.

- You can define only months within alternate calendar codes that are found within the range of the production calendar code.

For example, for 2003, the primary production calendar code M2 has the months of January and July defined. The alternate calendar code may not have August defined, but February or March may be defined, because they fall within the range of the production calendar code (January through July).

- Alternate calendar codes function as exception calendar codes to the default production calendar code.

For example, suppose that the production calendar code is defined for the months of January through December and the alternate calendar code is defined for the months of May and July, the system uses the alternate calendar code defined for May and July. The system uses the default dates defined for the production calendar code for all other months.

- You cannot delete a month from the production calendar code if it uses the alternate calendar code.
- If only one month is left on the production calendar code and you delete it, the system deletes the production calendar code from the Manufacturing Options page.

PeopleSoft Manufacturing then uses the work week definition to schedule production.

- If an alternate calendar code is defined for a work center or resource, you cannot delete every month defined for the calendar code.

Once you have added at least one calendar code, you must assign the calendar code to the appropriate business unit. If alternate calendar codes are defined, you can optionally assign those codes to work centers.

If you're using PeopleSoft Supply Planning, you can optionally assign alternate calendar codes to resources.

Important! Before you can assign calendar codes, run the Create Calendars process (MGS3000) to create a version of the calendar—the run time calendar—which is used in the planning and scheduling functions.

Run the Create Calendars process to create a new version of the calendar based on the latest calendar definition if you changed anything relating to the calendar such as:

- Changing a shift code's start or end times.
- Adding another month or year.
- Deleting a month or year.
- Changing a non-manufacturing day to a manufacturing day.

If you have enabled PeopleSoft Workflow, any time that you make a change to the calendar code, the system optionally sends a workflow notification to selected roles that you defined. This Production Calendar Change workflow notifies the role, such as a production control manager, that the calendars originally used for scheduling are not in synch with the changes, additions, or deletions that you made to the calendar code, and that you must create a new run-time version of the calendar.

Related Links

[Creating Run Time Calendars](#)

[Delivered Workflows for PeopleSoft Manufacturing](#)

Calendar Code Definition Page

Use the Calendar Code Definition page (MG_CALENDAR) to define production calendar codes.

Navigation:

Set Up Financials/Supply Chain > Business Unit Related > Manufacturing > Define Production Calendars > Calendar Code Definition

This example illustrates the fields and controls on the Calendar Code Definition page. You can find definitions for the fields and controls later on this page.

Calendar Code Definition

Calendar Code
Find | View All First 1 of 12 Last

Business Unit US008

*Month 01 - January

Calendar Code DEFAULT

2000

Production Calendar + -

Sun	Mon	Tue	Wed	Thu	Fri	Sat
30 <input checked="" type="checkbox"/>	31 <input type="checkbox"/> 2	1 <input type="checkbox"/> 1				1 <input checked="" type="checkbox"/>
2 <input checked="" type="checkbox"/>	3 <input type="checkbox"/> 2	4 <input type="checkbox"/> 2	5 <input type="checkbox"/> 2	6 <input type="checkbox"/> 2	7 <input type="checkbox"/> 2	8 <input checked="" type="checkbox"/>
9 <input checked="" type="checkbox"/>	10 <input type="checkbox"/> 2	11 <input type="checkbox"/> 2	12 <input type="checkbox"/> 2	13 <input type="checkbox"/> 2	14 <input type="checkbox"/> 2	15 <input checked="" type="checkbox"/>
16 <input checked="" type="checkbox"/>	17 <input type="checkbox"/> 2	18 <input type="checkbox"/> 2	19 <input type="checkbox"/> 2	20 <input type="checkbox"/> 2	21 <input type="checkbox"/> 2	22 <input checked="" type="checkbox"/>
23 <input checked="" type="checkbox"/>	24 <input type="checkbox"/> 2	25 <input type="checkbox"/> 2	26 <input type="checkbox"/> 2	27 <input type="checkbox"/> 2	28 <input type="checkbox"/> 2	29 <input checked="" type="checkbox"/>

Field or Control	Description
Production Calendar	If the calendar code is the default calendar code for the business unit, as defined on the Manufacturing Options page, this check box is selected.
Mo: (month)	<p>Create a calendar code with one month, a partial set of months, or 12 months of the year. If you want to create a new monthly calendar, insert a new row, select the month that you want to maintain, and press TAB to move to the next field. The system automatically fills the month with the values previously entered for the default production week. You can then change individual days for the month without affecting the default weekly production calendar.</p> <p>If you have already created the month and you want to change the calendar for an existing month, the Mo. field is unavailable for selection. Use the scroll bar to view the calendar for all existing months for the year.</p> <p>For each day in the week, you can assign up to three shifts from among the shifts defined on the Shift Code Definition page. You cannot enter duplicate shifts for the same day, and the shifts that you select for any given day cannot overlap. The shift times must also be chronological, beginning with the earliest shift listed first and the latest shift listed last. The system does allow shift schedule gaps as long as the shift times remain chronological across all days of the production calendar. Additionally, a shift can begin on one day and end on the next.</p>

<i>Field or Control</i>	<i>Description</i>
<input type="checkbox"/>	Select the Day Off check box in the day's lower left corner, if you want the day to be a non-manufacturing day.

Creating Run Time Calendars

To create run time calendars, use the Create Calendars (RUN_MGS3000) component.

Once you have defined the codes for each calendar, run the process to create a version of the calendars to be used for the planning and scheduling functions.

Run the process any time that you add or change a calendar code. If you have changed anything about a calendar, for example, changed a shift code's start or end times, added or deleted a month or year, changed a non-manufacturing day to a manufacturing day, or vice versa, run the Create Calendar process to create a new version of the calendar, based on the latest calendar definitions.

This section discusses how to create and maintain calendars and calendar codes.

Page Used to Create Run Time Calendars

<i>Page Name</i>	<i>Definition Name</i>	<i>Usage</i>
<u>Create Calendars Page</u>	RUN_MGS3000	Update the system with new calendar codes or calendar information.

Related Links

[Assigning Calendar Codes to Business Units, Work Centers, and Resources](#)

Create Calendars Page

Use the Create Calendars page (RUN_MGS3000) to update the system with new calendar codes or calendar information.

Navigation:

Set Up Financials/Supply Chain > Business Unit Related > Manufacturing > Define Production Calendars > Create Calendars

This example illustrates the fields and controls on the Create Calendars page. You can find definitions for the fields and controls later on this page.

Report Request Parameters

<i>Field or Control</i>	<i>Description</i>
Create Manufacturing Calendar	Select to create a new version of the default production calendar.
Create Alternate Calendar	Select to create a new version of one or more alternate calendars. If you are creating the manufacturing calendar, the Create Alternate Calendar check box is automatically selected.
All and Range	Specify the alternate calendars that you want to create.
Run	Click to run this request. PeopleSoft Process Scheduler runs the Create Calendars process at user-defined intervals.

See the product documentation for *PeopleTools: Process Scheduler*

Chapter 5

Integrating with Third-Party Systems

Integrating with an Electronic Data Collection System

Today, many manufacturers are minimizing manual data entry on the shop floor. Enhancing the capability to employ data collection devices provides improvements in three very important areas:

<i>Field or Control</i>	<i>Description</i>
Error reduction	You can scan the control data (production, operation, and work center) rather than manually enter it, reducing the probability of errors.
Accuracy	Data collected during the course of the production activity reflects greater accuracy.
Simplicity	Depending upon the data collection front-end solution, you can combine several transactions together.

PeopleSoft Manufacturing and PeopleSoft Flow Production enable you to use a bar code scanner, wedge connected to a PC, or radio frequency device to scan data. You can use electronic data collection with these transactions:

- Actual Hours
- Completions
- Component Issue/Return
- Kanban Completions
- Kanban Receiving
- Kanban Transfers
- Kit Issues/Returns
- Manual Replenishment Request
- Multiple Output Completions
- Production Picking

Bar coded labels are available for completed items, Kanban Cards, and Pull Tickets. You can also print bar code-enabled reports.

All bar coded transactions are inserted into a central Transaction Log using PeopleSoft Application Messaging, where a process executes to pick up specific transaction rows for validation. If no errors are found, the system applies the transactions through PeopleSoft Manufacturing and PeopleSoft Flow Production. If errors are found, you can review the transactions and fix the errors on the Transaction Maintenance page.

Related Links

[Your Enterprise Data Flow](#)

[PeopleSoft Manufacturing Integrations](#)

[Processing Picking Plans Using Electronic Data Collection](#)

[Processing Kit Issues and Returns Using Electronic Data Collection](#)

[Issuing Material Using Electronic Data Collection](#)

Integrating with an Item Content Provider

The proliferation of Web-based catalogs has provided manufacturers with an easy and effective tool to locate components with the desired specifications at the lowest cost. The traditional catalog function now comes in a variety of forms to improve business to business communication between systems. Examples of the types of systems PeopleSoft defines as 'Item Content Providers' include Component Supplier Management (CSM) systems, market site aggregators, independent trading exchanges, and traditional catalog providers with new web interfaces. These systems benefit the design and purchasing of new products by accelerating item location, maximizing design reuse, and reducing acquisition costs.

Item Content Providers provide tools to classify and query item lists. This benefits engineering designs by enabling parametric search capability, maximizing design reuse, preferred parts selection, and efficient parts retrieval. You can use Item Content Providers to help reduce the number of redundant items in an organization.

On the procurement side of your organization, you can use an Item Content Provider to classify parts and suppliers, and set up business rules for supplier consolidation, and supplier performance management. It also helps with cost reduction by getting the correct and lowest cost components up front.

PeopleSoft provides several enterprise integration points (EIP) to these systems to maximize ease of importing item data into the PeopleSoft database. Using Application Messaging technology, you can keep this information up to date within the PeopleSoft system by subscribing to XML messages from an Item Content Provider system to the PeopleSoft EIPs:

- Item Definition (SetID)
- Item Business Unit attributes
- Item Revisions
- Supplier/Item attributes

Note: For Item Content Providers, PeopleSoft supports inbound messages only.

Understanding Item Content Provider Transactions

Depending on the Item Content Provider involved, it may include publishing items, revisions, and item pricelist messages. These messages must be formatted into the PeopleSoft XML structure prior to being posted to PeopleSoft.

Note: This translation is third-party specific and isn't performed using the PeopleSoft system.

This diagram illustrates the flow of data (using the service operations within PeopleSoft Integration Broker) from an item content provider to PeopleSoft for item definitions, item attributes, and item price lists:

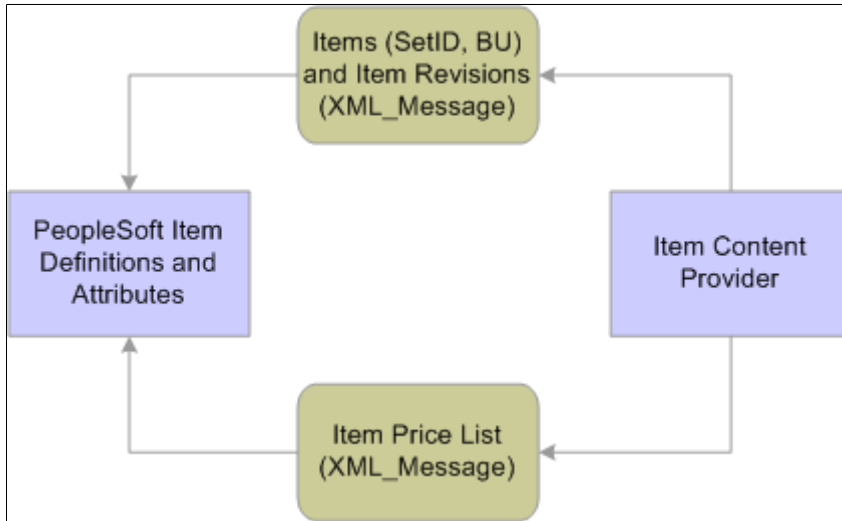

Once XML messages are posted to PeopleSoft, the PeopleSoft subscription process reformats the XML message data and writes the data into PeopleSoft staging tables. The system then initiates an Application Engine process to validate the data. If no errors are found, the process then updates the PeopleSoft item definition tables. If errors are found, you can review the message log and correct errors using the standard Data Definition Maintenance pages.

Note: You can't use Item Content Provider transactions to update transaction related data such as item quantity balances in the PeopleSoft Inventory tables.

Using the Item Master Transaction

The Item Content Provider uses the Item Master EIP to accept detailed updates and new items master information as well as Item business unit specific attributes including Revision data. The Item data includes Master Item, Item Business Unit Attributes, Purchasing Attributes, Item Unit of Measure and Item Revision information.

See “Examining the PeopleSoft Engineering Product Strategy” (PeopleSoft Engineering).

Using the Item Pricelist Transaction

Item Pricelist messages update the system with supplier's item catalogs. This includes detailed item information such as item dimensions, lot and serial control numbers, item groups and families, categories, and statuses. For each item, the system can also receive purchasing data including inspection information, pricing, packing dimensions, and supplier information like supplier catalog number and standard pricing.

Integrating with a Product Data Management System

Product Data Management (PDM) systems effectively—and quickly—track and implement new product introductions and product changes. These systems provide engineering-centric software that often pulls together CAD and product documentation, BOM and item information, ECOs, and workflow.

There is a framework in place to enable ongoing, one-way transfer of items, item revisions, and BOMs from the third-party PDM system to PeopleSoft. Using PeopleSoft Application Messaging technology, the third-party system is able to publish messages to the PeopleSoft system.

Related Links

[PeopleSoft Manufacturing Integrations](#)

Understanding Product Data Management

Product Data Management transactions work very much like Item Content Provider transactions. The Product Data Management system publishes item, item revision and bill of material messages. The PeopleSoft subscription process reformats the message data and writes the data into a staging table. The system then initiates an Application Engine process to validate the data. If no errors are found, the process then updates the PeopleSoft Inventory item and BOM tables. If errors are found, you can review the message log and correct errors using the standard Data Definition Maintenance pages.

This diagram illustrates the process flow of BOM and item data from the PDM Provider to PeopleSoft Inventory and PeopleSoft Engineering. The PDM Provider publishes new BOMs, updates to existing BOMs, new items, and item revisions:

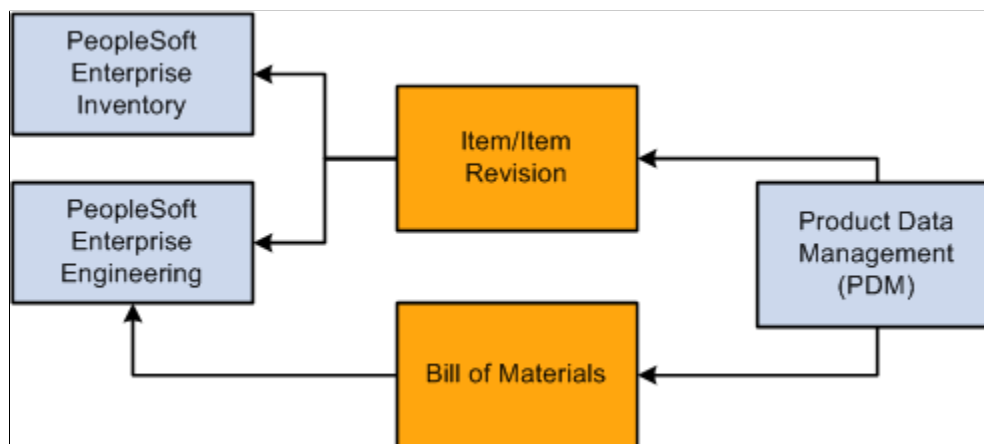

Using the Bill of Material Transaction

If you are integrating to a third-party Product Data Management (PDM) system, you can subscribe to BOM messages from that system. You typically use PDM systems to manage design aspects of BOMs and BOM changes. You can use them to create new BOMs and then update PeopleSoft Engineering or PeopleSoft Manufacturing. For existing BOMs, you can change components, reference designators, output lists, and substitute items in the PDM and send messages back to the PeopleSoft system. You maintain quantity information in the PeopleSoft applications rather than in the PDM.

See “Examining the PeopleSoft Engineering Product Strategy” (PeopleSoft Engineering).

Using the Item Master Transaction

The Item Content Provider uses the Item Master EIP to accept detailed updates and new items. The Item data includes Master Item, Item Business Unit Attributes, Purchasing Attributes, Item Unit of Measure and Item Revision information. This is an inbound, asynchronous message.

Note: When publishing new items or item revisions in combination with MBOM or EBOM additions or changes, you must publish Item additions prior to publishing BOMs that reference those additions. If not, the BOM transactions may error out due to missing items or revisions which are referenced on the BOMs.

See [Understanding BOM Maintenance](#).

Related Links

“Processing Inbound EIPs” (PeopleSoft Supply Chain Management Integration)

Integrating with a Manufacturing Execution System

You can integrate to a Manufacturing Execution System (MES) to enable the optimization of production activities from production order launch to completion of finished goods. MES functions include:

- Resource Allocation and Status
- Operations/Detail Scheduling
- Dispatching Production Units
- Document Control
- Data Collection/Acquisition
- Labor Management
- Quality Management
- Process Management
- Maintenance Management
- Product Tracking and Genealogy
- Performance Analysis

Overview of Manufacturing Execution System Transactions

Using PeopleSoft Manufacturing's integration, you can:

- Communicate production orders and production schedules from PeopleSoft to the MES using the Production Order Update EIP.
- Communicate item revision information from PeopleSoft to the MES using the Item Master EIP.

- Send operation and order completion and scrap information from the MES to PeopleSoft using the Completions EIP.
- Send component item usage from the MES to PeopleSoft using the Edit/Issue EIP.
- Analyze production performance in either PeopleSoft or the MES. If you are looking for more detailed operational information, you'll want to use the MES to gather this information.

This diagram illustrates the transfer of data between PeopleSoft Manufacturing and any MES, including the transfer of production IDs, production schedules, production completions, production component edits and issues, and item data:

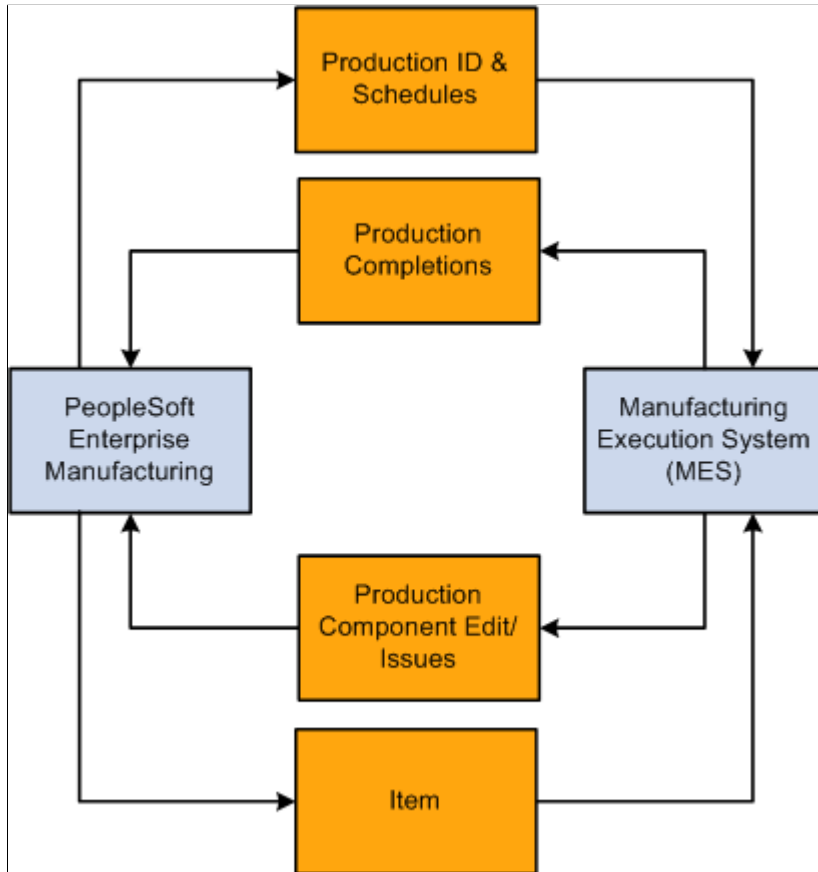

You'll continue to use PeopleSoft Manufacturing for planning, material movement into WIP, validation of completion data, and production costing functions. PeopleSoft is the system of record for setup information, including item masters, bills of material, routings, and creating production orders.

Related Links

[PeopleSoft Manufacturing Integrations](#)

Using Manufacturing Execution System Transactions

When you add or modify production with a status of Firm or greater, component lists, operation lists, and output lists, the system creates a publish message for the MES to pick up. The system also creates a publish message when changes are made using background programs.

You manage errors for the Completions and Edit/Issues transactions using Transaction Maintenance.

You use the Publish Outbound Transactions page to initiate the outbound publish process for the Production Order Update EIP and the Item Master outbound EIP.

Using the Item Master Transaction

You can publish item revision information to the Manufacturing Execution System using the Item Master outbound EIP. This is an outbound, asynchronous message. When you create or modify a revision, approve a revision-controlled item, or add business unit attributes to a revision-controlled item, the system publishes an item revision message to the Manufacturing Execution System.

See [Understanding BOM Maintenance](#).

Using the Production ID/Production Schedule Manufacturing Execution System Transaction

Use the Production Order Update EIP to export production ID or production schedule changes to an external system. This is an outbound, asynchronous message.

See [Understanding Production IDs and Production Schedules](#).

Using the Completions Manufacturing Execution System Transaction

Use the Production Completions EIP to import information into PeopleSoft Manufacturing. This is an inbound, asynchronous message.

See [Understanding the Process of Recording Completions and Scrap Using Electronic Data Collection](#).

Using the Edit/Issues Manufacturing Execution System Transaction

Use the Production Order Issue EIP to import edit or issue component information from a third-party system. This is an inbound, asynchronous message.

See [Understanding Recording Completions and Scrap](#).

Related Links

“Processing Inbound EIPs” (PeopleSoft Supply Chain Management Integration)

Integrating with Product Life Cycle Management Applications

By using PeopleSoft Manufacturing, you can send item, revision, and manufacturing bill of material (BOM) information using product life cycle management applications.

See [PeopleSoft Manufacturing Integrations](#).

See [Understanding the PDX Integration](#).

Integrating Oracle's PeopleSoft Manufacturing with Product Life Cycle Management Applications Using PDX 1.0 XML

Understanding the PDX Integration

You can use PeopleSoft Manufacturing to receive item, revision, and manufacturing bill of material (BOM) information from external applications. This integration uses the product data exchange (PDX) version 1.0 XML format.

Note: The term *PDX* refers to the XML files containing change order information that is sent from the product life cycle management application to PeopleSoft.

PeopleSoft Manufacturing integrates with PLM applications enabling you to send item, revision, and manufacturing BOM information using change orders.

Specifically, the PeopleSoft system integrates with engineering change order (ECO) and manufacturer change order (MCO) subclasses of PDX to support inbound item (part) and BOM information into PeopleSoft Manufacturing. This integration is one-way only (inbound to PeopleSoft), and supports one PLM system to one PeopleSoft system (single business unit).

In general, implementing a PLM integration implies that the PLM system is the master data source for items, revisions, and BOMs instead of PeopleSoft. Therefore, when this integration is implemented, use PeopleTools security to severely restrict access (disallow changes) to item, revision, and BOM maintenance functions within PeopleSoft. Generally, these maintenance functions should only be done in PeopleSoft for the data elements that are *not* maintained through the PLM system, for example, costing, purchasing or planning attributes on the Item Master. This maintenance depends on the specific implementation of the PLM application, as well as any modifications that you have made.

This diagram illustrates the flow of data between PeopleSoft Manufacturing and a PDX message using the PeopleSoft Integration Broker to transform the HTTP data to PeopleSoft-formatted XML data and apply the item changes, revisions, and BOM changes to PeopleSoft Manufacturing:

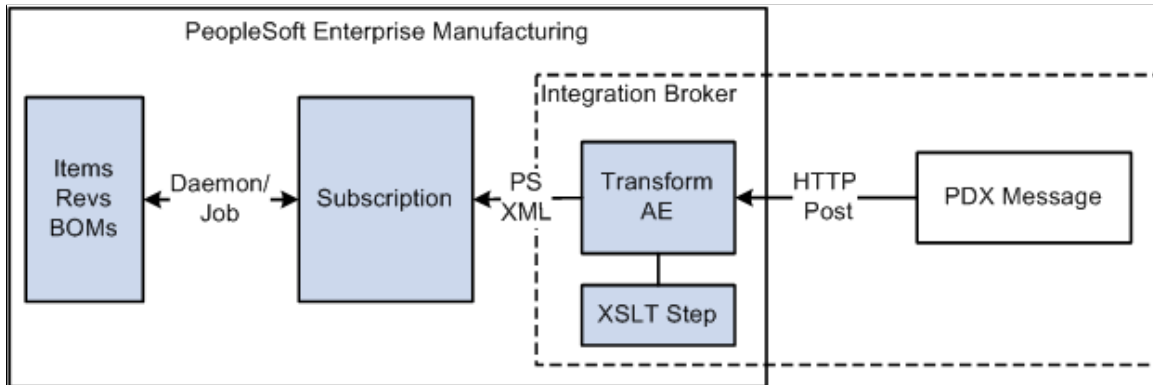

Related Links

[Reviewing and Correcting PDX Change Order Exceptions](#)

[Reviewing Important Implementation and End-User Guidelines](#)

Understanding the Required Setup and Considerations for Integration

This section discusses:

- PeopleSoft Manufacturing.
- The integration checklist.

PeopleSoft Manufacturing

Once you have defined usage of a valid life cycle status within the product life cycle management application, you can then set up PeopleSoft Manufacturing by defining default and mapping information within the Installations Options - Manufacturing page. These mappings look for custom fields in the XML as a system such as Agile™ would write them within the PDX 1.0 standard.

In addition, certain PeopleSoft Integration Broker and messaging information is also required, which enables PeopleSoft to receive the service operation in the PDX 1.0 format.

Within PeopleSoft, you also set up a Daemon program and related job designed to process inbound change orders (within the PDX 1.0 service operations) for items and BOMs sent in PDX format into PeopleSoft master tables.

Integration Checklist

Use this checklist to configure the PDX integration:

PeopleSoft Manufacturing Setup Tasks	Description
1. Set up PeopleSoft Installation Options.	Create basic life cycle mappings, defaults, and other basic mappings for data not delivered in standard PDX 1.0 XML.
2. Set up the PeopleSoft messaging gateway.	<p>Activate service operations — for services BOM_SYNC and ITEM_SYNC</p> <p>The service operation version itself has a status and there is an individual status for each handler and routing.</p>
3. Turn off Flag 1 within Data Maint Setup pages for ITEM and BOM transaction types.	<p>Flag 1 in this setup page indicates that you do not want to auto-process inbound service operations as they are received.</p> <p>This is important for the integration to control the flow and updating of change orders.</p>
4. Set up the PDX Alert and PDX_DMON Daemon group for processing inbound service operations.	<p>a. Set up the run control for the PDX Alert.</p> <p>The PDX Alert enables you to notify a specific user by using email when exceptions occur within PeopleSoft due to the processing of inbound changes.</p> <p>b. Set up the Daemon to process inbound changes.</p> <p>The PDX_DMON Daemon group must be set up and running for a process scheduler to monitor inbound — PDX service operations and start the PDX_JOB when needed.</p>

Prerequisites

Prior to integrating PDX with PeopleSoft Manufacturing, you must first install:

- PeopleSoft Manufacturing software.
- PeopleSoft Integration Broker gateway supporting inbound service operations for the manufacturing installation.

Important! You must also ensure that the current existing released items, revisions, and BOMs in the product life cycle management application are already present and in sync with the PeopleSoft system prior to synchronizing data. *In sync* implies that the revision start dates in PeopleSoft match the effective dates of those that were released previously from the product life cycle management application—if releases do exist—and that component effectivity for components on the BOMs also align with the date, revision, and markup information.

Setting Up PeopleSoft Manufacturing for Use with a Product Life Cycle Management Application

These are the high-level steps that you must follow to set up the PeopleSoft system:

1. On the PeopleSoft Installation Options - Manufacturing page, define the general mappings for PDX data to be sent to PeopleSoft.
2. Set up the PeopleSoft messaging gateway to receive PDX service operations.

The PeopleSoft connectivity is accomplished by using inbound XML (PDX 1.0 standard) messaging which requires the set up of a gateway.

While areas that pertain to the service operations are contained in this document, basic understanding of setting up and using PeopleSoft gateway and service configuration is assumed.

3. Define a Daemon group for the PeopleSoft Process Scheduler to manage the processing of inbound items, revisions, and BOMs received by using PDX service operations.

The table in the next section contains a general list of the pages used to set up PeopleSoft Manufacturing to integrate with a life cycle management application. Many of these pages are delivered with the correct default information, and you are not be required to change them. These are included for informational purposes only. However, any additional setup related to these pages is included in this document, and is also noted within the Usage column.

Pages Used to Set Up PeopleSoft Manufacturing to Integrate with a Product Life Cycle Management Application

<i>Page Name</i>	<i>Definition Name</i>	<i>Usage</i>
<u>Installation Options - Manufacturing Page</u>	INSTALLATION_MG	Setup required Set up PDX defaults by defining the Business Unit , Unit of Measure , and the Item Status Mapping fields. Also map the PeopleSoft Field to the third-party application user-defined field name.
<u>Service Operations - General Page</u>	IB_SERVICE	Review and edit service operations for the PDX integration.
Service Operation References Page	IB_MESSAGE_SO_SEC	View associated service operations. <u>Service Operations - General Page</u>

Page Name	Definition Name	Usage
<p><u>Routing Definitions Page</u></p> <p>Service Operations - Routings Page</p>	<p>IB_ROUTINGDEFN</p> <p>IB_SERVICERTNGS</p>	<p>Activate the routing.</p> <p>You must activate the BOM_SYNC_PDX and ITEM_SYNC_PDX routings.</p> <p><u>Service Operations - General Page</u></p>
Gateway Page	IB_GATEWAY	<p>Setup required.</p> <p>Set up the PeopleSoft messaging gateway.</p>
Daemon Group Page	AE_DAEMON	<p>Setup required.</p> <p>Create a Daemon group with the program name PDX_DMON, which is a delivered application engine program. This page controls the sequential processing of imported items and BOMs.</p>
Servers Page	SERVERDEFN	<p>Setup required.</p> <p>Dedicate a PeopleSoft Process Scheduler server to PDX processing and add the Daemon group created in Daemon Group Definition page within the server definition.</p> <p>Do this for one server only.</p>
Job Definition Page	PRCSJOBDEFN	<p>Default setup is delivered.</p> <p>A job definition called PDXJOB is delivered and it contains the programs needed to process new service operations for items, revisions, and BOMs in the Data Maintenance component.</p>
Item Loader Page	RUN_IN_ITMLOAD	<p>The required PDX run control is set up automatically at runtime.</p> <p>Use this page to define a run control to process for staged items.</p> <p>The PDX_CONTROL program (the first program in the PDXJOB) requires the use of a run control ID to be named <i>PDX</i>.</p>

Page Name	Definition Name	Usage
BOM Loader Page	EN_RUN_BOMSTAGE	<p>The required PDX run control is set up automatically for you at runtime.</p> <p>Use this page to define a run control for BOM Loader (EN_BOM_MSG) process to load BOM information.</p> <p>The PDX_CONTROL program requires the use of a run control ID to be named <i>PDX</i>.</p>
Data Maint Setup1 Page	EO_EIP_CTL_SETUP1	<p>Default setup is delivered, but minor changes are required.</p> <p>Deselect the Flag 1 check box to ensure that items and BOMs are not automatically processed. Run the PDX job, so that it can be processed independently from the item and BOM loading processes.</p>

Installation Options - Manufacturing Page

Use the Installation Options - Manufacturing page (INSTALLATION_MG) to set up PDX defaults by defining the Business Unit, Unit of Measure, and the Item Status Mapping fields.

Also map the PeopleSoft Field to the third-party application user-defined field name.

Navigation:

Set Up Financials/Supply Chain > Install > Installation Options > Manufacturing

This example illustrates the fields and controls on the Installation Options - Manufacturing page. You can find definitions for the fields and controls later on this page.

PDX Setup

<i>Field or Control</i>	<i>Description</i>
Business Unit	Select the value for the Manufacturing business unit that is to be assigned for changes received.
Standard Unit of Measure	Define a value for all inbound items being added. This is useful if all inbound items are to share the same UOM (such as EA).

Field or Control	Description
Item Status Mapping	<p>Define the item life cycle status mapping for items with a status of:</p> <ul style="list-style-type: none"> • <i>Active</i> • <i>Discontinue</i> • <i>Hold</i> <p>This value is used when change orders are released to PeopleSoft. The PeopleSoft item status (setID and business unit) is based on the Affected Item Life Cycle value for each item on a change order. Therefore, any valid life cycle status that can be included on a change order sent to PeopleSoft must be mapped in this group box.</p> <p>The LifeCycle Phase field on this page can contain commas to define a one-to-many mapping between PeopleSoft and the PLM. For example, the previous screenshot shows how the life cycle status of Production and Preliminary are to be considered an active item status for the PeopleSoft item status.</p> <hr/> <p>Note: When a new item with an active status is added from Agile™ with an effective date greater than today's date, the effective date of the affected item is ignored in PeopleSoft and the current date (today) is used at the item level (setID and business unit). This allows revisions and manufacturing BOMs to be created for the item in PeopleSoft.</p> <p>However, future effective dates are used for the start date of the item or revision, and also for future effective dates associated with a future item status. For example, if an item is currently active in PeopleSoft, you can send a change order to specify future obsolescence of the item by having an affected item with a future date and a future status intended to obsolete the item. In this case, the current PeopleSoft status remains active and a future status is to be specified as Discontinue.</p> <hr/>

User Defined Fields Mappings

PDX 1.0 supports user-defined fields within it. In version 1.0 of PDX, the **Item Source Code** and **Unit of Measure** are not standard fields. Some life cycle management systems (such as Agile™) will automatically populate custom attributes of the XML when you define these fields within the PLM system. If this is the case, you can use this group box to define additional mappings for the integration to reduce configuration. **Item Source Code** and **Unit of Measure** are required fields for PeopleSoft.

Field or Control	Description
PeopleSoft Field and Agile™ Field Name	<p>PeopleSoft standard values include:</p> <ul style="list-style-type: none"> • <i>Item Source Code</i> (item) • <i>Item Unit of Measure</i> (item) • <i>Operation Sequence</i> (BOM component) • <i>Cost Element</i> (item) • <i>Cost Group Profile</i> (item) <p>For example if you are using Agile™ to enable these mappings, create a Page Two user-defined field using Agile Administrator™ for the appropriate Agile™ class. All classes are associated with the item in Agile™, except for the operation sequence, which is defined for the BOM component.</p> <hr/> <p>Important! The Page Two user-defined field names that you enter here must be defined on the Installation Options - Manufacturing page <i>exactly</i> (including the case) as you have defined them in Agile Administrator™. This is required because specific PeopleSoft Adapter translation code expects XML tags to be defined correctly or no mapping occurs for the value.</p> <hr/>

Note: These several pages describe the node and service operations required to enable inbound messaging for PDX 1.0.

Related Links

“Managing Inventory by Item Status” (PeopleSoft Managing Items)

Service Operations - General Page

Use the Service Operations - General page (IB_SERVICE) to review and edit service operations for the PDX integration.

Navigation:

PeopleTools > Integration Broker > Integration Setup > Service Operations

This example illustrates the fields and controls on the Service Operations - General page. You can find definitions for the fields and controls later on this page.

The screenshot displays the Oracle Service Operations - General page. The breadcrumb trail is: Favorites > Main Menu > PeopleTools > Integration Broker > Integration Setup > Service Operations. The page title is "Service Operations". The "General" tab is selected. The configuration is for Service Operation "BOM_SYNC" with Operation Type "Asynchronous - One Way". The *Operation Description is "Bill Of Materials". There is a text area for Operation Comments. The Object Owner ID is set to "Manufacturing". The Operation Alias is empty. The *Req Verification is set to "None". There is a checkbox for "User/Password Required" and a "Service Operation Security" link. The "Default Service Operation Version" section shows Version "VERSION_1" with Description "Bill Of Materials". It has checkboxes for "Default" (checked) and "Active". The "Routing Status" table shows:

Routing Status	Exists
Any-to-Local	Exists
Local-to-Local	Does not exist
Local-to-Atom	Does not exist

The "Routing Actions Upon Save" section has checkboxes for "Regenerate Any-to-Local" and "Generate Local-to-Local". A warning states: "Warning: Regenerating sets all routing field values to their initial state." The "Message Information" section shows Type "Request", Message.Version "BOM_SYNC.VERSION_1", and *Queue Name "ITEM_MAINTENANCE". There are buttons for "View Message", "View Queue", and "Add New Queue". At the bottom, there are buttons for "Save", "Return to Service", and "Add Version".

Review or edit general information such as service and operation type, handlers, and routings associated with the BOM_SYNC and ITEM_SYNC service operations.

Routing Definitions Page

Use the Routing Definitions page (IB_ROUTINGDEFN) to activate the routing.

Navigation:

- **PeopleTools > Integration Broker > Integration Setup > Routings**
Select the *BOM_SYNC_PDX* value for the routing name.
- **PeopleTools > Integration Broker > Integration Setup > Service Operations**
Select the *BOM_SYNC* value for the service operation, and click the Routings tab.
Click the **Selected** check box for the BOM_SYNC_PDX routing.

This example illustrates the fields and controls on the Routing Definitions page. You can find definitions for the fields and controls later on this page.

IB Routing Definitions

Routing Definitions
Parameters
Routing Properties

Routing Name BOM_SYNC_IN

*Service Operation

Version

*Description

Comments

*Sender Node

*Receiver Node

Delay Processing

Operation Type

Object Owner ID

Active

System Generated

[Graphical View](#)

Unordered Segments

Schema Validation Details

Save
Return

Field or Control	Description
Active	Select this check box.
Save	Click this button to save your changes and activate the routing.

Important! You must activate the BOM_SYNC_PDX and ITEM_SYNC_PDX routings.

If you are activating the routings by using the Service Operations - Routings page:

1. Select the check box for the BOM_SYNC_PDX routing definition.
2. Click the **Activate Selected Routings** button.
The routing Status changes to *Active*.
3. Click the **Save** button.

Perform these same steps for the ITEM_SYNC service operation and ITEM_SYNC_PDX routing.

Setting Up and Running the Daemon Group and Related Job to Process Inbound PDX Files

This section discusses how to set up and run a Daemon group to process the transformed BOM_SYNC and ITEM_SYNC service operations into PeopleSoft master tables (after the change has been sent).

The Daemon application engine program checks the stage table to determine whether there is any inbound set of change orders, which would result in items or BOMs being processed. It processes the changes for items, revisions, and BOMs received from the PLM by initiating the PDXJOB when necessary. The PDXJOB then drives the processes to ensure that one inbound transaction (from a PDX service operation) is treated collectively and processed sequentially through the Item Loader (IN_ITMLOAD) and BOM Loader (EN_BOM_MSG) processes as part of the PDXJOB.

In addition, the PDXJOB includes an Alert process (PDXALERT) which notifies you of any processing errors.

Use the Job Definition page (PRCSJOBDEFN) to a job definition called PDXJOB is delivered and it contains the programs needed to process new service operations for items, revisions, and BOMs in the Data Maintenance component.

Navigation:

PeopleTools > Process Scheduler > Jobs > Job Definition

This job should already exist and should be defined exactly as indicated in this screenshot:

This example illustrates the fields and controls on the Job Definition page. You can find definitions for the fields and controls later on this page.

The screenshot displays the 'Job Definition' page in PeopleSoft. At the top, there are tabs for 'Job Definition', 'Job Definition Options', 'Job Distribution', and 'Job Notification'. The main content area includes the following fields and controls:

- Process Type:** PSJob
- Job Name:** PDXJOB
- *Description:** Process inbound Items and BOMs
- Run Mode:** Serial (dropdown menu)
- *Priority:** High (dropdown menu)
- *Process Category:** Default (with a search icon and 'Default Category' text)
- Max Concurrent:** (empty input field)
- Override Process Retry Count:** (checkbox) **Retry Count:** (input field)
- Override Process Retention Day:** (checkbox) **Retention Days:** (input field with value 0)

Below these fields is a table titled 'Process List' with the following data:

	*Process Type	*Process Name	Description	Run Always On Warning	Run Always On Error		
1	Application Engine	PDX_CONTROL	PDX_CONTROL	<input checked="" type="checkbox"/>	<input checked="" type="checkbox"/>	+	-
2	Application Engine	IN_ITMLOAD	Item Loader	<input type="checkbox"/>	<input type="checkbox"/>	+	-
3	Application Engine	EN_BOM_MSG	EN_BOM_MSG	<input type="checkbox"/>	<input type="checkbox"/>	+	-
4	Application Engine	PDX_ALERT	PDX_ALERT	<input type="checkbox"/>	<input type="checkbox"/>	+	-

See Step 2.

The processing sequence is very important when items, revisions, and BOM changes are sent to PeopleSoft. For example, item and revision information must be processed for a given change order prior to any BOM updates.

To set up item and BOM processing so that they do not automatically attempt to load when the service operation is processed:

1. Use the Data Maint Setup1 page (EO_EIP_CTL_SETUP1) to deselect the Flag 1 check box to ensure that items and BOMs are not automatically processed. Run the PDX job, so that it can be processed independently from the item and BOM loading processes

Navigation — **Enterprise Components Integration Definitions Data Management Utility Data Maintenance Setup**

- a. Deselect the **Flag 1** check box to prevent items and BOMs from being processed automatically.

Deselect this check box for both the item and BOM transaction type. This prevents item and BOM data from being processed immediately and allows the PDX information to be properly staged for processing in PeopleSoft

Deselecting this check box provides greater reliability of the integration, because PeopleSoft items must exist or the BOM processing fails.

- b. Save the page after you have deselected the **Flag 1** check box for both the Item and BOM transaction types.

Important! This setup is done because it is *highly recommended* that you schedule the Item Load process and BOM Load process independent of the send process to ensure the reliability of back end processing. This is because the Item and BOM Loader programs are designed to process large sets of changes at once, but not multiple sets of the same items or BOMs.

Note: If you have other ongoing uses of the ITEM_SYNC service operation outside of the integration, the setting of this flag may have an impact on those non-PLM areas. When the Daemon is enabled, it creates instances of the Item Loader process that process any inbound set of items staged for processing. Therefore, take this into consideration during the implementation.

2. Access the PeopleTools Job Definition page (**PeopleTools > Process Scheduler > Jobs > Job Definition**) and review the job named PDXJOB.

This PDXJOB job controls the processing of individual change order packages sent to PeopleSoft by incoming transaction. The PDX_CONTROL controls the flow of these change orders by picking up item and BOM changes (IN_ITMLOAD and EN_BOM_MSG) from data maintenance in a FIFO (first in, first out) manner based on PDX transactions that are ready to be processed. This ensures that all items for the same transaction are ready to be processed with the BOMs being sent.

The PDXJOB job includes the PDX_ALERT program designed to search for any processing errors and send an alert to the appropriate users. To facilitate exception processing, this email notification job is provided, which is included as the last process in the PDXJOB initiated by the PeopleSoft Daemon. Each time a package is processed, this job searches for any recent processing errors found in the PDX Change Order Exceptions page. If any errors are found, an email notification can be sent to users associated with the specified role. This email also includes a URL link back to the PDX Change Order Exceptions component where users can view the details of the errors. The email also

includes a list of change orders that are in error, as well as the date and time that they were staged within PeopleSoft.

Important! The run control ID for this process must be manually created with the name of PDX to run as part of the PDXJOB process.

Note: The PDX_CONTROL job automatically creates a run control and sets the appropriate values for processing for both the Item and BOM Loader processes with the run control ID of PDX. The PDX alert run control must be created manually and is used to establish parameters for the alert. Do not enter a value in the **Recurrence Name** field on the Job Definition Options page.

3. Access the Role Definition page (**PeopleTools > Security > Permissions and Roles > Roles**)..
 - a. Create a new role that can be associated with all users who want to receive this email alert.

This role does not need to contain any permission lists.
 - b. Associate this role with appropriate user profiles that should be included in the email notification.

Important! Make sure that each user has a valid default email address in the user profile. The mail is sent to the email entry that is marked as *primary* in the user profile.

See *PeopleTools: Security Administration Documentation*

4. Access the PDX Alerts page (**SCM Integrations > Transaction Error Handling > PDX Alerts**)..
 - a. Create a run control ID that is to be used for each run of this utility.
 - b. Enter the role name created in step 3a.

All users associated with this role are included on the email distribution.
 - c. The *Show errors occurring within the last 'n' Minutes* value is used to determine how far back to look for change order errors on the PDX Change Order Exceptions page.

This setting can help determine how many times you are notified if there are errors. Because this program (by default) is set up to run any time a service operation is processed, you may want to set this value to a minimum number of minutes to include only the latest change order errors and to send an email only once.

If you want to be reminded of all errors in the PDX Change Order Exceptions page from the last day and receive notification each time the adapter is run, set this value to 480 minutes, assuming that the adapter is running 8 hours a day.
 - d. The URL field automatically changes to the current machine (web server) being accessed at this time, combined with the PDX Change Order Exceptions page; this URL is included in the exception emails to be sent.

To direct the user to log into a different machine or web server, change the beginning part of the string, but leave the latter portion untouched as this directs the user to the correct component.

5. Use the Daemon Group page (AE_DAEMON) to create a Daemon group with the program name PDX_DMEN, which is a delivered application engine program. This page controls the sequential processing of imported items and BOMs.

Navigation — **PeopleToolsProcess SchedulerDaemon Group**

- a. Create a Daemon group named *PDXDMON*.
- b. Add the program name *PDX_DMEN* to the Daemon group.

PDX_DMEN is a PeopleSoft Application Engine program that determines whether there is anything to be processed by the Item Loader and BOM Loader processes respectively. This Daemon is linked to PeopleSoft Process Scheduler and allows the inbound service operations to be monitored without the overhead of starting a job to check each time.

6. Use the Servers page (SERVERDEFN) to dedicate a PeopleSoft Process Scheduler server to PDX processing and add the Daemon group created in Daemon Group Definition page within the server definition.

Navigation — **PeopleToolsProcess SchedulerServers**

Define the Daemon servers page as indicated for an appropriate server and use the Daemon group created in the previous step.

<i>Field or Control</i>	<i>Description</i>
Daemon Enabled	Select this check box.
Daemon Group	Select the <i>PDXDMON</i> value.
Daemon Sleep Time	Enter a value of 2.
Recycle Count	Enter a value of 10.

Note: After the Daemon group is assigned to a server, the Process Scheduler for that server must be restarted or rebooted.

Important! You should set up only one server with this Daemon. It requires a single instance per PeopleSoft database.

See the product documentation for *PeopleTools: Application Engine*

Reviewing and Correcting PDX Change Order Exceptions

This section provides an overview of change order exceptions.

Pages Used to Review and Correct PDX Change Order Exceptions

Page Name	Definition Name	Usage
<u>PDX Change Order Exceptions Page</u>	EN_PDXECO_EXCP	Review any incoming change orders that are the result in an error status due to edit checks made on items, revisions, or BOMs.
<u>PDX Change Order Exceptions - Error Detail Page</u>	EN_PDX_ERRORS	View the specific errors associated with the change order.
<u>Completed by Change Order Page</u>	EN_PDX_COMPTRNS	View the completed change orders.
Role Definition Page	ROLEDEFN	Define roles.
PDX Alerts Page	EN_PDX_ALERT_RUN	Define PDX alert emails, which notify you of load time processing exceptions related to change orders for items and BOMs.

Understanding Change Order Exceptions

While the intent is obviously to not have any exceptions, the PDX Change Order Exceptions component is provided to identify and correct any errors that may occur.

This outlines the flow of change order information once it is received into the PeopleSoft Manufacturing system:

1. Service operations are posted to the PeopleSoft service operation gateway (PDX_MSG), which contains the PDX change order data.

The PDX service operation is processed. It is translated and subscribed to as ITEM_SYNC and BOM_SYNC service operations.

2. Item sync and BOM sync service handlers write results to new entries by transaction (which relate to the PDX change data) within Data Maintenance as *item* for items and revisions, and BOM for bill of material changes.
3. The Daemon defined for the PeopleSoft Process Scheduler determines when to run the PDXJOB defined in "Steps to define and PDX Daemon."

The PDXJOB selects and processes the change order package (by transaction). This job processes the earliest transactions in the system by running the Item Loader and BOM Loader processes in PeopleSoft together sequentially.

4. Any exceptions processing the PDXJOB are visible within the PDX Change Order Exceptions component defined in this section.

Note: This component provides a special view of the item and BOM data maintenance information in the context of ECO numbers containing Revision information. If the PDX sent contains manufacturing change orders (such as MCOs that have no revision information), these changes are consolidated into a single line within the exception page with the value '***MCO***' if in error. The generic value '***MCO***' is configurable in the Message Catalog utility under message set number 7026 and message number 204.

Related Links

[PDX Change Order Exceptions Page](#)

PDX Change Order Exceptions Page

Use the PDX Change Order Exceptions page (EN_PDXECO_EXCP) to review any incoming change orders that are the result in an error status due to edit checks made on items, revisions, or BOMs.

Navigation:

SCM Integrations > Transaction Error Handling > PDX Change Order Exceptions

This example illustrates the fields and controls on the PDX Change Order Exceptions page. You can find definitions for the fields and controls later on this page.

PDX Change Order Exceptions

Date Transferred BT thru BT

Change Order

Status ▼

The Completed link shows any revision successfully processed into PeopleSoft.

Staged Change Orders	Personalize Find View All	First 1 of 1 Last
Change Order	Date Transferred	Status

[Process Monitor](#)
[Maintain Data Definitions](#)
[View Completed Revisions](#)

This page provides you visibility of incoming staged items and BOMs within the context of change orders only. This page is a view of the information by item or BOM in the Data Maintenance component.

Field or Control	Description
Status	<p>Values include:</p> <ul style="list-style-type: none"> • <i>Cancelled</i> • <i>Error found on the transaction</i> • <i>In Process</i> • <i>New Transaction</i> <p>When new change orders are being processed, the initial status of each change order appears as New.</p> <hr/> <p>Note: The details of a change order can include several item and BOM changes that are present in the Maintain Data Definitions component for an initial status of New.</p> <hr/> <p>If any of the items, revisions, or BOMs related to a change order are processed in error, then the change order will be identified as an <i>Error</i> on this page.</p>
Error Detail	<p>Click this link to view the specific errors associated with the change order.</p> <p>Because a change order typically contains multiple items and BOMs, it is possible that some changes were processed successfully while others may have resulted in an error.</p> <p>For example, a new assembly, BOM A123, is sent with four new component items (C1, C2, C3, C4), but one of the new components (C4) was not sent. In this case, three of the components could be successfully processed (C1, C2, C3) as items, but the BOM A123 would fail, because component C4 must exist within PeopleSoft before the manufacturing BOM can be created.</p> <p>If this occurs, the Completed status link appears for that specific change order.</p>
Completed	<p>Click this link to view any completed items or BOMs for an error change order. These items have been processed and incorporated into the PeopleSoft Manufacturing system.</p>

PDX Change Order Exceptions - Error Detail Page

Use the PDX Change Order Exceptions - Error Detail page (EN_PDX_ERRORS) to view the specific errors associated with the change order.

Navigation:

Click the **Error Detail** link on the PDX Change Order Exceptions page.

This example illustrates the fields and controls on the PDX Change Order Exception - Error Detail page (1 of 2). You can find definitions for the fields and controls later on this page.

Error Detail

Change Order:
 Date Transferred:
 Publication Identifier:

Item Errors			
Item ID	Field Name	Message Text	EIP Control ID
1 SR2100	COST_ELEMENT	Default cost element has not been specified for item.	200000000000948000000153
2 SR2001	REVISION	Revision A for item SR2001 exists on an ECR or ECO. Deletion not allowed.	200000000000948000000152
3 SR2100	REVISION	Revision A for item SR2100 currently exists in production.	200000000000948000000153
4 MT3000	COST_ELEMENT	Default cost element has not been specified for item.	200000000000948000000139
5 FR7002	REVISION	Component Revision exists on BOM. May create inconsistencies.	200000000000948000000198
6 SR2001	COST_ELEMENT	Default cost element has not been specified for item.	200000000000948000000152

This example illustrates the fields and controls on the PDX Change Order Exception - Error Detail page (2 of 2). You can find definitions for the fields and controls later on this page.

15 MT3000	REVISION	Revision A for item MT3000 currently exists in production.	200000000000948000000139
-----------	----------	--	--------------------------

BOM Errors			
Item ID	Component ID	Message Text	EIP Control ID
1	No Errors Found.		

[Return to PDX Exceptions](#)

[Maintain Data Definitions](#) [Define Items](#) [Business Unit Item](#) [Revision](#) [Review Manufacturing BOMs](#)

Completed by Change Order Page

Use the Completed by Change Order page (EN_PDX_COMPTRNS) to view the completed change orders.

Navigation:

Click the **Completed** link on the PDX Change Order Exceptions page.

This page identifies completed items based solely on the presence of new entries in the item, revision, and BOM production tables within PeopleSoft. This is identified in the system by storing the change order number within the Revision and BOM additional text fields.

Correcting Change Order Errors

It is highly recommended that when there is a BOM processing (data entry) error the error should be corrected within the product life cycle management system and the change order resent to PeopleSoft.

In this case, click the **Cancel** button on the PDX Change Order Exceptions page to cancel all remaining unprocessed and errored entries in the ITEM and BOM staged tables and then resend the entire change order.

Note: Cancel the change order first in PeopleSoft so that subsequent sends of the same change order are not confused with the earlier send, which had an error.

For example, you send two new component items (C1 and C2) and one assembly item (A123), along with one BOM markup for the assembly item A123. It is possible that the two component items process correctly yet the BOM markup fails (for example, a third component (C3) is referenced on BOM A123, but is missing). In this case, canceling the errored change order rows, repairing the change order by adding the third component, and resending the change order to PeopleSoft is a preferred method of correction.

Data Entry Errors

<i>Field or Control</i>	<i>Description</i>
BOM error	Missing required component item in the affected items of the change order caused the BOM to fail because the component item was not present in PeopleSoft.
Item Error	<ul style="list-style-type: none"> Missing required PeopleSoft data on items (such as the item description left blank). Life cycle status left blank in affected items on the change order.

Engineering Errors to Released and Sent Change Orders

There is no "undo" capability for change orders applied to PeopleSoft. Therefore, you should not make any engineering-type changes to a change order (such as BOM markups) after it has already been sent and processed successfully within PeopleSoft. For example, successfully sending a markup to PeopleSoft and then subsequently unreleasing the change order, changing the markup, and resending the same change order to PeopleSoft is not allowed. Doing so causes both systems to be out of sync.

Note: If additional engineering changes are required to repair a change order, a subsequent change order and release to PeopleSoft is the proper method of correction.

Change Order Errors - Examples

These are some common change order errors that you may encounter:

- A component listed on the BOM was mistakenly left off the change order that was corrected within Agile™, and then the change order was resent to PeopleSoft.

In this case, click the **Cancel** button on the PDX Change Order Exceptions page to cancel all remaining unprocessed and error entries in the item and BOM staged tables and resend the change order.

- You sent two new component items (C1 and C2) and one assembly item (A1), along with one BOM markup for the assembly item A1.

It is possible that the two component items processed correctly, but the BOM markup failed (perhaps a third component, C3, is referenced on BOM A1 but is missing).

In this case, canceling the change order rows with an Error status, repairing the change order by adding the third component, and resending the change order to PeopleSoft is a preferred method of correction.

Reviewing Important Implementation and End-User Guidelines

When integrating two software systems, it is important to understand and work with the differences of the two systems to maximize the integration success. This is most notably due to subtle functional differences between the two systems.

Here are some important guidelines to help with the integration:

- Determine transaction size, volume, and frequency.

The typical size and volume of the change orders determines how often and how much to process through the PeopleSoft within a single PDX file. Care should be taken to reduce the chance of extremely large files (files over 8 megabytes not recommended). PeopleSoft recommends sending more PDX files with smaller numbers of change orders more frequently rather than very large files containing volumes of changes with less frequency.

Schedule the PDX Daemon (PDXDMON) within PeopleSoft to compliment the typical flow of change orders being sent.

For example, if you typically have 6 to 10 change orders released each hour (interval), you should schedule the PDXDMON to look for new change orders more frequently (such as wake up perhaps every 5 minutes so a maximum of 20 change orders per hour could be processed). Again, if you want to process changes more quickly, you can schedule the Daemon to look more frequently for new packages.

- Avoid the *redo and resend markup* pitfall.

Once a change order has been processed and sent to PeopleSoft, it is highly recommended that you **never** back out and unrelease a change order in the PLM, change the BOM markup data, and then resend it to PeopleSoft. This will frequently cause unpredictable integration errors and BOM synchronization problems, because PeopleSoft has already successfully processed each of the original released markups for the initial change order.

- Define field lengths and required fields in the PLM.

This is critical to the reliability of the integration to ensure that all PeopleSoft required fields have valid values, and that these values have the correct lengths for PeopleSoft. If they do not, transaction errors occur on the back end (PeopleSoft side) of the integration.

- Use caution regarding processing multiple revisions for an item in one day.

The PeopleSoft Manufacturing revision scheme supports only one revision per day. Some environments may require that multiple revisions be released for the same item in one day. If this

occurs in the environment, note that by default only the latest revision number can be tracked within PeopleSoft for that day. Furthermore, all the revision changes for a BOM are combined with the latest revision for the day. For example:

- Revision A on 6/1/2003, 9 am: Adds component XYZ-1 to BOM 123
- Revision B on 6/1/2003, 10 am: Adds component XYZ-2 to BOM 123
- Revision C on 6/1/2003, 1 pm: Adds component XYZ-3 to BOM 123

Within PeopleSoft Manufacturing, the net effect is revision C showing XYZ-1, XYZ-2, and XYZ-3 added for BOM 123 under revision C.

If a prior revision (such as revision A or B in the previous example) has already been used within production (on a production ID or production schedule) and a new revision for the same item and effective date is sent, the change order will error out within PeopleSoft (PDX Change Order Exceptions page) as seen in this screenshot. This occurs because when you send multiple revisions during one day, you are overwriting an original revision, for example, the production ID would be left tagged with a revision that no longer exists in the system.

Send multiple revisions each day in an environment where you can anticipate that this is not a problem, because you normally want to pick up the latest revision for existing production IDs created on that day.

In this case, use these PDX exceptions as an alert that the production IDs must be unreleased (blank revision) and allow the newest revision to be assigned to the production ID once the revision is sent to the PeopleSoft system.

Understanding PeopleSoft Bills of Material and Routings

Bills of Material

PeopleSoft Manufacturing provides features such as revision control, component yield, alternate BOMs, multiple outputs, and operation overlap to maintain complex BOMs, resources, work centers, tasks, and routings dynamically. You can use PeopleSoft Workflow to automate approvals and controls between PeopleSoft Engineering and PeopleSoft Manufacturing. In addition, multimedia attachments, such as detailed work documents, drawings, and videos clarify and expand instructions for complex operations.

If you have PeopleSoft Engineering installed, you can integrate between PeopleSoft Manufacturing and PeopleSoft Engineering to maintain engineering change orders (ECOs), BOMs, and routings—both manufacturing and engineering versions—and document management. You can even make mass BOM changes.

You can make changes to BOMs and routings within PeopleSoft Engineering, and then release those changes to PeopleSoft Manufacturing under ECO control. You can also take advantage of a complete document management solution that enables you to manage and approve document changes within PeopleSoft Engineering and then deploy them within PeopleSoft Manufacturing.

You also have the option to define planning BOMs.

Example: BOM Structure

BOMs are design structures that you can use to define how to assemble or produce your end items or products. In a tree-like structure, BOMs list all the assemblies, intermediate items, and raw materials that go into a parent assembly, displaying the quantity of each that is required to make an assembly or end item.

This diagram illustrates a BOM for a road bike, showing the components of bike frame, front fork, gear assembly, seat, and standard wheel. The standard wheel is a subassembly consisting of wheel spokes, tire, and rim:

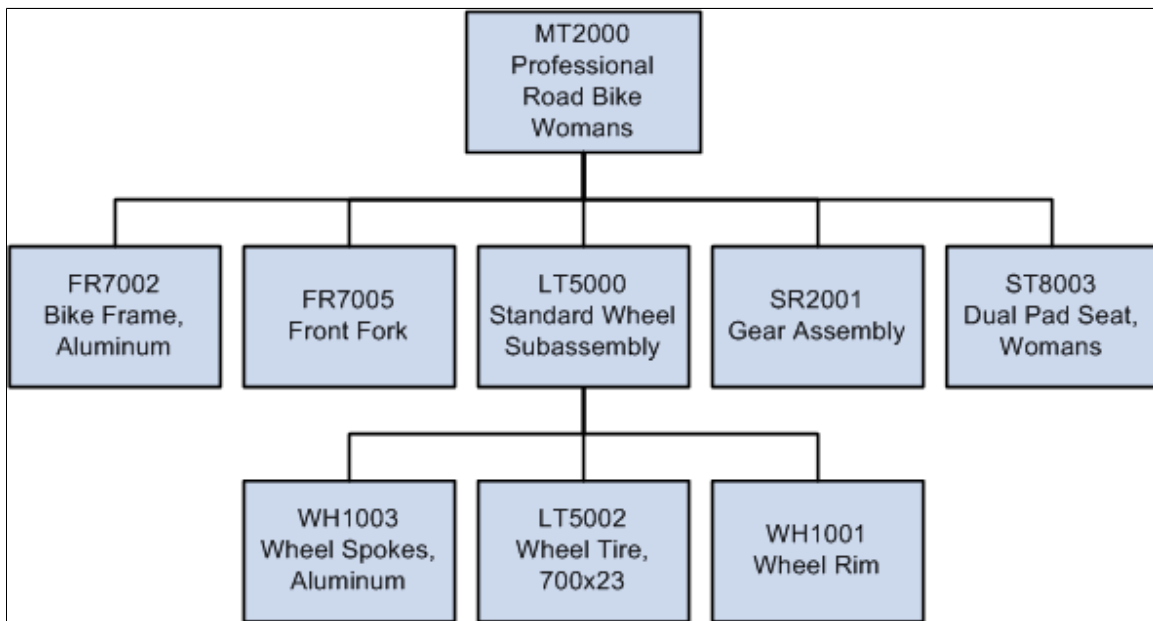

PeopleSoft Manufacturing enables you to maintain all your complex product structures. You can also alter BOMs, create alternate BOMs, gather where-used data, display indented inquiries, designate multiple outputs, make mass BOM changes, and phase out one item while adding another.

By creating alternate BOMs, PeopleSoft Manufacturing enables you to prototype and assign components to different operations using different BOMs. In addition, this gives you the ability to run multiple configurations without using PeopleSoft Product Configurator.

The multiple outputs functionality enables you to define co-products, recycle and waste by-products on the BOM. An example of this could be the orange juice process, which can have orange juice and orange concentrate as primary and co-products, respectively, and orange pulp and orange pits as recycle and waste by-products.

In addition to using basic, required BOM functionality, you can associate engineering drawings, text, documents, or multimedia representations to a BOM at the assembly or component level.

Within PeopleSoft Manufacturing, there are three types of BOMs:

- Manufacturing BOMs (MBOMs)
- Engineering BOMs (EBOMs)
- Planning BOMs

Manufacturing Bills of Material

Manufacturing bills of material (MBOMs) are the bills actually used within PeopleSoft Manufacturing to manufacture assemblies and in PeopleSoft Cost Management to determine product costs. While they reside in PeopleSoft Manufacturing, they can originate in either PeopleSoft Manufacturing or in PeopleSoft Engineering.

Using the PeopleSoft Bill of Material EIP, you can also import new and changed BOMs into PeopleSoft Engineering or PeopleSoft Manufacturing.

Manufacturing BOMs can have either a production or rework BOM type. Rework BOMs are used when you need to do additional or repair work on a completed assembly. This is useful if you have a standard rework process that requires additional components.

Related Links

[Understanding BOM Maintenance](#)

Engineering Bills of Material

As stated previously, manufacturing engineers typically create engineering bills of material (EBOMs) as part of the design process. As existing products are modified and new products are introduced, you need the ability to isolate BOM changes from the production environment. With PeopleSoft Engineering, you can manage and develop EBOMs without impacting the MBOMs. When EBOMs are approved, you can copy or transfer them to production for use in manufacturing. You can also apply mass changes to EBOMs (or MBOMs) using the mass maintenance functionality.

Here is how EBOMs differ from MBOMs:

- EBOMs are isolated from manufacturing and aren't visible within PeopleSoft Supply Planning or PeopleSoft Manufacturing.
- EBOMs have relaxed edit checks.

For example, you can use pending items as components or define component placeholders on EBOMs when you don't yet know the actual item number.

- You can add EBOMs for assemblies and components that were added in PeopleSoft Inventory in a pending state.

Related Links

[“Understanding PeopleSoft Engineering Bills of Material” \(PeopleSoft Engineering\)](#)

Planning Bills of Material

A planning BOM is an artificial grouping of items in a bill of material format. PeopleSoft Supply Planning uses planning BOMs for aggregate forecasting or aggregate reporting purposes. With planning BOMs, you can explode forecasting and facilitate both your master scheduling and material planning. You can create and maintain, on a summary level, all components that comprise a planning BOM for a group of assembly items or product families in a specific business unit.

For planning bills, the item ID (the parent item in the bill) is always a nonstockable item that represents a group or family of items. It must be defined in the business unit item attributes with *Planning* as the source code. It also represents an item that, while forecasted, cannot be ordered. Because planning items can be components of other planning items, you can create multiple levels of planning bills.

Planning BOMs are defined and maintained with the Planning BOMs page in PeopleSoft Supply Planning.

Related Links

“PeopleSoft Supply Planning Overview” (PeopleSoft Supply Planning)

Importing Bills of Material from External Sources

With the PeopleSoft Bill of Material EIP (BOM_SYNC) and Item Master EIP (ITEM_FULLSYNC), you can:

- Import new and changed items and item revisions into PeopleSoft.
- Import new and changed BOMs into PeopleSoft Manufacturing.
- Validate and correct errors on imported BOMs in separate BOM staging pages.

Routings, Tasks, Work Centers, and Resources

Routings, tasks, work centers, and resources are a fundamental part of PeopleSoft Manufacturing.

Routings

While a BOM specifies the components of an assembled item, the routing, typically created by engineering, defines the sequence of steps needed on the shop floor to create the assembled item. Therefore, a routing is a set of information detailing the method for manufacturing a particular item. It consists of sequentially numbered operations that reference the task to be performed, the work center in which the task is to be performed, the resources (crews, machines, and tools) to be used, and the time required to complete the task. In combination with labor and machine setup times and run rates, this operation data defines planning and standard cost information.

You can use routings in both discrete work order production and repetitive manufacturing. Routings determine the lead times for manufactured items that, in turn, determine the start and end dates for production. Routing hours and run rates also determine the conversion costs associated with a manufactured item.

Instead of defining an individual routing and alternatives for each manufactured item, you can define a routing for an item and then reference that item's routing for other items with a similar manufacturing process. This referenced routing is sometimes referred to as a master routing.

You can define master routings by item, item family, or item group. Master routings eliminate the need to maintain redundant routing information for those items that can share a single routing definition.

Once the BOMs and routings are defined, you can link them together as specific combinations (production options) that can be accessed by PeopleSoft Supply Planning.

Yield by Operation

Operation yield allows you to specify the quantity of goods expected to make it through the process. The expected loss can then be incorporated into the cost of the usable end items.

Routing Times

You can define routing times for both human labor and machines. In addition, you can maintain times for costing and planning. PeopleSoft Manufacturing breaks the time down into these amounts:

<i>Field or Control</i>	<i>Description</i>
Setup Time	The amount of time required to prepare an item, machine, or work center for production.
Run Time	The amount of time necessary to process one unit (rate expressed in minutes, hours, or days) or the number of units that can be processed in one time period (rate expressed in units per minute, units per hour, or units per day).
Fixed Run Time	The amount of time necessary to complete the task, regardless of the number of units processed.
Post Production Time	The amount of time required to clean up, flush, or break down a machine, a work center, or an area, once production has been completed.
Queue Time	The amount of time that units must wait at an operation before setup (if there is setup) or processing can begin.
Intransit Time	The amount of time required to transport units from one operation to the next.

Related Links

[Understanding Production Options](#)

[Understanding Routings](#)

Tasks

Tasks are the jobs that can be performed within your manufacturing facility. When defining a task, you can set up default data, such as times and rates, that the system copies to an item's routing when you select the task for a given operation. Multiple items can reference the same task or you can set up unique tasks for each item. Maintaining task data is optional.

Work Centers

A work center can consist of one or more people or machines and can represent a logical grouping of machines, a department, or a cost center. You can assign each operation or task on a routing to a work center in which the operation or task takes place. Additionally, you can assign one or more resources (crew, machine, tool) to each work center.

Resources

Resources are the crews, machines, and tools that can be used at work centers to complete tasks. When analyzing capacity for planning and scheduling, PeopleSoft Supply Planning looks at the individual resources that you assigned to the work center and schedules them accordingly.

How It All Fits Together

This diagram illustrates the different elements of PeopleSoft Manufacturing BOMs and routings and how they feed into the manufacturing process. The diagram also reflects the order of setup:

1. Define bills of material.
2. (Optional) Define resources, unless you are using PeopleSoft Supply Planning.
3. Define work centers; optionally, assign related resources.
4. (Optional) Define tasks and assign related work centers.
5. Define routings; optionally, assign related tasks.

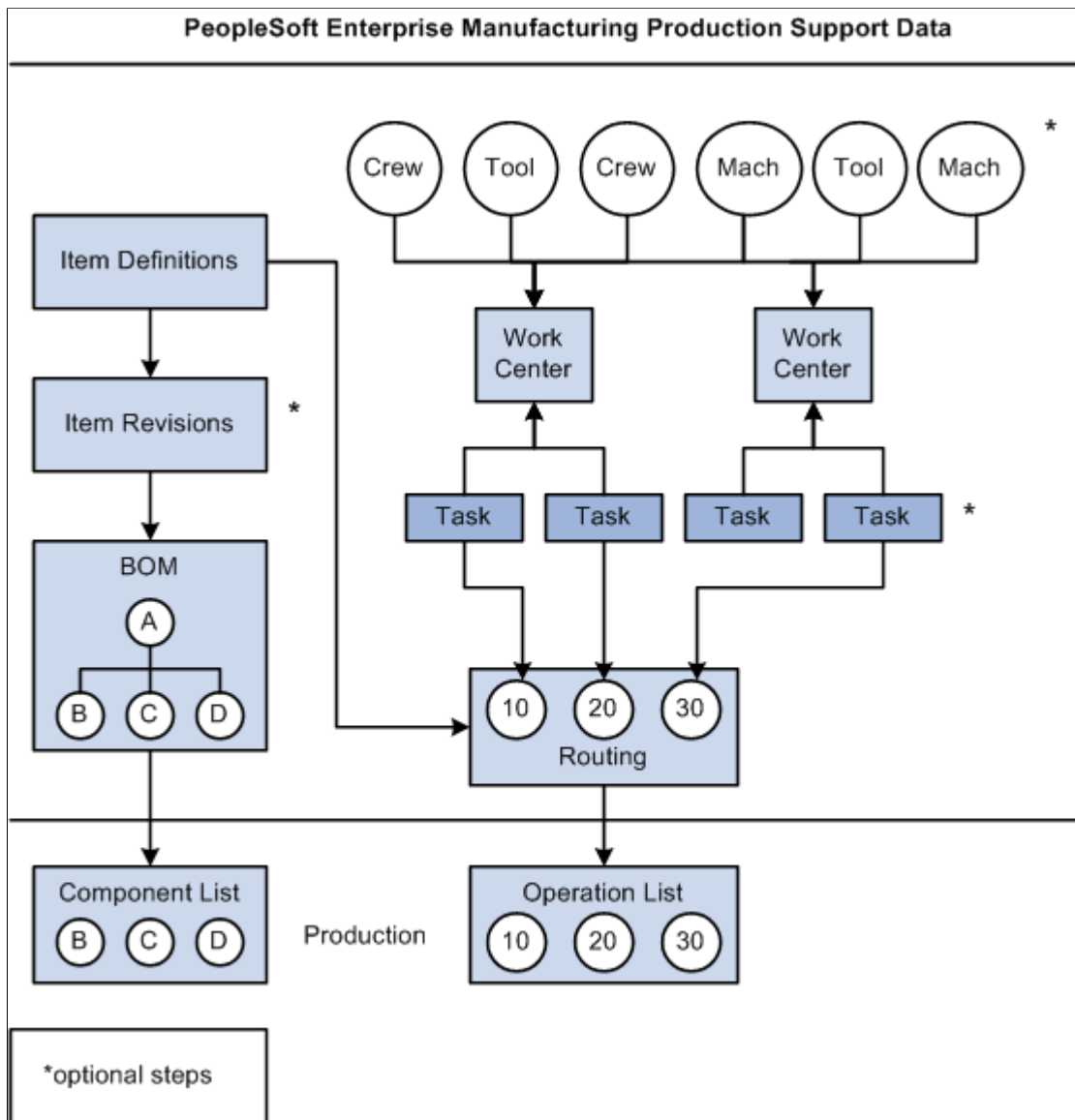

Chapter 8

Maintaining Bills of Material

Understanding BOM Maintenance

PeopleSoft Manufacturing enables you to define and maintain BOMs using the Maintain BOMs and Revisions component. However, before you begin, there are some prerequisites that you must address.

Common Elements Used in Bills of Material

<i>Field or Control</i>	<i>Description</i>
BOM Type	<p>Select the type of BOM that you are creating. Values are:</p> <ul style="list-style-type: none">• <i>Production</i>: BOM is used as the basis for manufacturing assemblies or end items.• <i>Rework</i>: BOM is a rework BOM, which you can create if you have a standard rework process that involves including additional components. <p>For example, if you have a repair kit of components that you always issue when an item is reworked, you can define that repair kit here. As with manufacturing BOMs (MBOMs), you can define a primary rework BOM and up to 98 alternates by creating BOM codes.</p> <p>Rework BOMs are not required to create rework production IDs.</p>

Prerequisites

Before you begin defining and maintaining BOMs, you must:

1. Add items.
2. Decide how to maintain BOMs for assembly items (by effectivity date or by revision).
3. Decide whether to verify BOMs online, and define manufacturing BOM default settings, including component revision default settings.
4. (Optional) Maintain revisions.
5. If you have a standard rework process that involves adding components, determine whether you need to create rework BOMs.

6. Consider the differences between single-output BOMs and multiple-output BOMs.
7. (Optional) Assign associated primary BOMs when you define multiple outputs.
8. Specify the calculated BOM quantity per assembly (QPA) precision.

In addition, to access the Revision Documents page, the Assembly Documents page, and the Component Documents page, you need to have PeopleSoft Engineering installed along with its Documentum functionality. Select **Set Up Financials/Supply Chain > Common Definitions > Documentum** to access the Documentum Component Options page, where you can specify the function buttons that are available on the document-enabled pages.

If you have enabled PeopleSoft Workflow, when a change is made to a BOM, the system uses the BOM Change workflow to notify the manufacturing engineer (or other defined role) that a change has been made to the BOM.

Related Links

[“Setting Up Document Management Options” \(Application Fundamentals\)](#)

[Understanding the PDX Integration](#)

[Delivered Workflows for PeopleSoft Manufacturing](#)

Defining BOM Items

Before you can add a BOM for an assembly or end item, the end item and its component items (including substitutes) must be defined within PeopleSoft Inventory.

Once you've added the general attributes for the item, you must add the business unit-specific attributes within PeopleSoft Inventory. In addition, specify whether an item is a purchased or manufactured item. Although you can add BOMs for both manufactured and purchased items, the system uses only a manufactured item's BOM for planning and cost management purposes. Therefore, to correctly plan for items that you both make and buy, you should set the source code of these items accordingly.

You can maintain BOMs only for owned or consigned inventory items whose books use the Standard Cost option as the costing method in PeopleSoft Inventory. The components can be either owned or non-owned, and they can be either inventory or expensed items. In addition, you cannot control or manage the items using staged dates. Except for planning BOMs, you can add production and rework BOMs only for an item that is approved and defined as an inventory item with the source code *Make*, *Buy*, *Floor Stock*, or *Expense*.

Related Links

[Item Substitution](#)

[Components: Substitutes Page](#)

[“Understanding Cost Structure” \(PeopleSoft Cost Management\)](#)

Maintaining BOMs by Revisions or Effectivity Dates

When you define the assembly items by using the **BOM Usage Defaulting** group box on the MFG Business Unit Options page (manufacturing business unit options page), you determine if you will manage the BOMs using revisions. If you use revision control, you can specify the BOM maintenance method as **By Effectivity Date** or **By Revision**, and you can specify whether revisions can be automatically generated during mass changes. Maintaining effectivity information by revisions, instead of by date, validates and simplifies data entry during BOM maintenance because you specify the revisions and you do not need to determine effectivity dates for the component. However, if you're using revisions, and it's easier to maintain BOMs using dates, you can still enter effectivity dates, and the system checks to see which revision is in effect on the date specified.

Note: All general attributes that you set with this page apply to both engineering and manufacturing BOMs.

This section discusses how to maintain BOMs by Revision or Effectivity Date:

Page Used to Maintain BOMs by Revision or Effectivity Date

<i>Page Name</i>	<i>Definition Name</i>	<i>Usage</i>
MFG Business Unit Options	BUS_UNIT_OPT_MG	Set up manufacturing business unit options.

MFG Business Unit Options Page

Use the MFG Business Unit Options page (BUS_UNIT_OPT_MG) to set up manufacturing business unit options.

Navigation:

Set Up Financials/Supply Chain > Business Unit Related > Manufacturing > Manufacturing Options > MFG Business Unit Options

This example illustrates the fields and controls on the MFG Business Unit Options page. You can find definitions for the fields and controls later on this page.

<p>MFG Business Unit Options MFG BU Prdn Options Auto Revision Scheme BOM Message Default</p>	
<p>Business Unit US008</p>	
<p>Rate Maintenance / Defaulting</p> <p><input checked="" type="radio"/> By Work Center</p> <p><input type="radio"/> By Task</p>	<p>Online BOM Verification</p> <p><input type="radio"/> Always Verify Online</p> <p><input checked="" type="radio"/> Never Verify Online</p>
<p>Default Calendar Codes</p> <p>Production Calendar Code <input type="text" value="DEFAULT"/></p> <p>Run-time Calendar Code <input type="text" value="DEFAULT"/></p>	<p>BOM Usage Defaulting</p> <p><input checked="" type="checkbox"/> Revision Control <input checked="" type="checkbox"/> Auto Revision</p> <p><input type="radio"/> By Effectivity Date <input checked="" type="radio"/> By Revision</p>
<p>BOM Maintenance Settings</p> <p><input checked="" type="checkbox"/> Allow Blank Component Revision</p> <p><input checked="" type="checkbox"/> Default Component Revision</p> <p><input checked="" type="checkbox"/> Default Teardown BOM Component</p> <p><input checked="" type="checkbox"/> Components Align with Revision</p>	<p>Compl and Close Peg Qty Change</p> <p><input type="radio"/> Notify at Compl and Close</p> <p><input type="radio"/> Notify at Close</p> <p><input checked="" type="radio"/> No notify at Compl or Close</p>

<i>Field or Control</i>	<i>Description</i>
Always Verify Online	Select to run the loop-checking process online during BOM maintenance.
Never Verify Online	<p>Select to bypass the loop-checking process online during BOM maintenance; you can run the verification as a deferred process.</p> <p>If you change the online BOM verification from Always Verify Online to Never Verify Online, you must run the batch BOM verification to ensure that no looping BOMs exist.</p> <hr/> <p>Note: When BOMs are complex and deep, select Never Verify Online to improve BOM maintenance performance. Then run the BOM verification process from the BOM Verification page.</p> <hr/>

BOM Usage Defaulting

<i>Field or Control</i>	<i>Description</i>
Revision Control	<p>Select to control items by revisions. If you select this option and BOMs exist for the assembly item, the dates for the components specified in the BOMs typically must be aligned with the dates within the revisions. If you want to control the assembly item by revision but still allow for some off-cycle components (such as components that do not align with the exact start date of a revision), select this check box and also select the By Effectivity Date option. This enables you to maintain components on dates that do not align with the exact start date of a revision.</p> <p>If you do not select this check box, then you are maintaining BOMs by date, and the By Effectivity Date and By Revision options for BOM maintenance are unavailable. In this case, By Effectivity Date is the default setting.</p> <hr/> <p>Note: You cannot maintain planning and expense items by revision.</p> <hr/>

Field or Control	Description
Auto Revision	<p>If you select Revision Control, you can also select this check box. This indicates that revisions for the item can be automatically generated using a scheme defined at the business unit level. If revisions have already been created manually with the Revision Maintenance component, the system uses the revision scheme to select the next available revision.</p> <p>If you designate that the item has revisions created automatically, you can use mass maintenance in PeopleSoft Manufacturing or PeopleSoft Engineering to create the revisions. You can do this in two ways: either by using BOM mass maintenance by engineering change order (ECO) or BOM mass maintenance by mass maintenance code (MMC).</p> <p>The mass maintenance process creates revisions only for items that have both revision control and automatic revision selected. When automatic revisions are not used in the mass maintenance process, the process functions as a regular mass maintenance process.</p> <hr/> <p>Note: If you do not select Revision Control and then you later decide to maintain BOMs by revisions after you have already created BOMs for the item, you must make sure that the effectivity dates on the BOMs align with the effectivity dates on the revisions if you require that all component changes are tied to the start date of a specific revision. You can deselect the Revision Control option without deleting any revisions for the item.</p> <hr/>
By Effectivity Date	<p>Select to have the system maintain BOMs for revision-controlled items by dates related to revisions. Enter dates on which assembly product structure components are in effect when maintaining BOMs using the Manufacturing BOMs Summary page, the Component page, and the Substitute Item page. The system validates these dates so that they align with item revision dates if you have select the Components Align with Revision setting on the MFG Business Unit Options page.</p>

Field or Control	Description
By Revision	<p>Select to have the system maintain BOMs for revision-controlled items by revision rather than date. You can associate effective and obsolete revisions with components using the Manufacturing BOMs page and the Component page.</p> <hr/> <p>Note: Even if you deselect the Components Align with Revision option on the MFG Business Unit Options page, you can select the By Revision option for a particular assembly item to require that the assembly has all components align with one of its revisions because maintaining by date is not allowed.</p>

Warning! For component items that you want to use up (or phase out), you must manually maintain obsolete date information. The obsolete date can be based on the projected phase-out date determined by the planning server's online BOM verification.

See [MFG Business Unit Options Page](#).

BOM Maintenance Defaulting

When you set up BOM maintenance, you can specify a revision for a component on a BOM. Using the MFG Business Unit Options page, you define how you want to handle component revision information.

You can use the **Allow Blank Component Revision** check box and the **Default Component Revision** check box to define component revision default settings that affect the Manufacturing BOMs component. These two fields apply only to revision-controlled items. Furthermore, they operate independently of each other; consequently, there are four possible combinations of settings. This table describes the four combinations:

Allow Blank Component Revision Setting	Default Component Revision Setting	What It Means
Cleared	Cleared	When you maintain BOMs, you must enter a revision for any component that's revision-controlled. The system does not insert any default component revisions. The inquiries display what you enter on the maintenance pages.

Allow Blank Component Revision Setting	Default Component Revision Setting	What It Means
Selected	Cleared	<p>When you maintain BOMs, you can leave component revisions blank or select a revision for the component. The system does not provide a default value.</p> <p>The inquiries check the appropriate assembly effectivity dates and display component revisions based on the date for which the inquiry is performed.</p> <p>The BOM inquiries check the selected assembly, end item effectivity date, and revision, and the system displays the component's corresponding revision based on the date selected. This is the default setting combination for any business unit.</p>
deselected	Selected	<p>The system will not allow blanks and defines a default component revision based on today's date (current revision).</p> <p>If the Comp Rev (component revision) field doesn't have a revision defined, before you save the BOM, you need to go to each line and define a revision or press TAB to move out of the Comp Rev field to establish a default value.</p> <p>Inquiries display the revisions you've entered on the maintenance pages.</p>
Selected	Selected	<p>The system allows blank component revision fields and defines a default revision for all revision-controlled components that you add or change on the BOM. If a revision-controlled component with no component revision specified already exists on the BOM and you make no attempt to change it, the system leaves the Comp Rev field is blank.</p>

Related Links

[Defining and Maintaining Revisions](#)

[Verifying BOMs](#)

Creating Rework BOMs

If you use a standard rework process that involves adding components, decide whether you want to create rework BOMs. You can define a primary rework BOM and up to 98 alternates by using BOM codes.

Using Multiple-Output BOMs

There are some conceptual differences between single-output BOMs (with one primary item) and multiple-output BOMs (with at least one co-product).

Single-Output BOMs

BOM quantity is a scaling device field that enables you to enter a product structure when the assembly specifications are in a base greater than one unit. You determine the assembly quantity to which the system applies the component's quantity per assembly or per order. If the BOM quantity is greater than one, enter the component quantity in terms of the BOM quantity. If set to 1, the component quantity is the amount of the component required to make one unit. You can use BOM quantity for batched bills or if you plan to make only a certain quantity of an item at a time.

Multiple-Output BOMs

When multiple outputs are defined for a BOM, you indicate that:

- At least two end items are generated during production, and one of the items is the primary item.
- The item ID specified for the BOM represents a batch item, as well as the primary item.

This diagram illustrates an example of a BOM where there is a primary output, co-products, and by-products. The BOM is defined for item ID 6000, which is a batch item. The outputs for batch item 6000 include primary item 6000, co-product 6001, recycle by-product 6007, and waste product 6009.

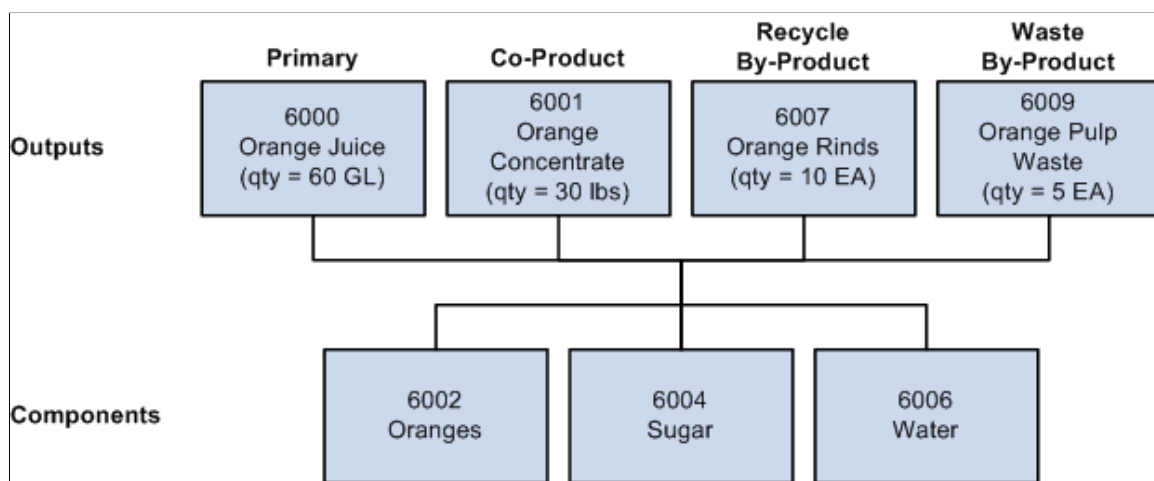

When used on a multiple-output BOM, the BOM quantity represents the in-process quantity for the BOM item as a batch item (as opposed to the item ID as a primary item). For example, if the example BOM structure has a BOM quantity defined as 150, then the in-process units of the batch are 150.

Note: In this example, routing times (planning and costing) and rates are for a single batch unit.

In addition, when creating production IDs or production schedules, you must define the production quantity in terms of batch units.

Assigning Associated Primary BOMs

With multiple outputs, it's possible that a particular co-product can be created in several ways; that is, an item can be a co-product on more than one item's primary BOM. By assigning an associated primary BOM to a co-product, you can indicate which BOM the system use in when exploding the co-product to the next level.

This diagram illustrates an example of how one item can be a co-product on two different BOMs. In this example, item B is a co-product in two different processes where the primary output is item A on the first BOM and item D on the second BOM:

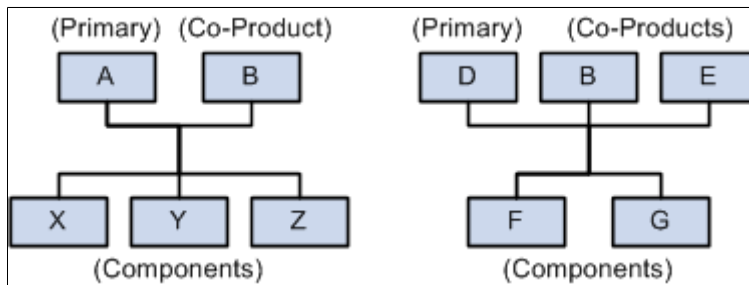

In the first structure, A is the primary item; B is the co-product; and X, Y, and Z are the components. In the second structure, D is the primary item; B and E are co-products; and F and G are the components. Because there are two ways of making the same product (B), you need to decide which structure to use when exploding to lower levels. Therefore, indicate a primary structure associated with each item that can exist as a co-product but not as a primary item. You can assign B's associated primary BOM as either A or D. If B has its own BOM structure, and you want to use that structure when exploding to lower levels, then you can leave B's associated primary BOM as B.

When exploding to lower levels, the system checks if there is an associated primary item defined for the item. If there is an associated primary item, the system uses its BOM code *I* to explode to lower levels.

Note: Although the default is the item itself, you can select a different associated primary BOM. To do this, either no associated primary BOM code *I* exists or, if it exists, the item ID must exist as a co-product on that BOM.

Specifying the Calculated BOM QPA Precision

By using the Manufacturing Installation Options page in Set Up Financials/Supply Chain, you can set the calculated QPA precision. This is especially important when you use a large BOM quantity and a relatively small quantity per assembly. When you maintain a BOM and define the quantity per assembly or per order, you are limited to a precision of four places to the right of the decimal point.

However, the system calculates the quantity per by dividing the entered quantity per by the BOM quantity, and it uses the precision that is defined on the Manufacturing page. For example, if a calculated QPA results in 6.54321 and the QPA setting is set to four places, the system uses the value 6.5432.

Related Links

“Installation Options - Manufacturing Page” (Application Fundamentals)

Defining and Maintaining Revisions

To create and maintain BOMs by revisions, use the REV Maintenance component (EN_REVISION).

You can maintain revisions; for example, you can define codes and the dates that the revisions become effective. You can also attach text, documents, and other files to revisions.

By defining revision codes, you determine the specific dates that revisions become effective. Therefore, before you maintain BOMs by revisions, you must define the revision codes. Additionally, to reference revisions for a component on a BOM, you must first define the component's revisions.

Note: Instead of predefining revision codes, you can generate revisions automatically. This feature, however, is available only through the BOM Mass Maintenance process.

Pages Used to Define and Maintain Revisions

<i>Page Name</i>	<i>Definition Name</i>	<i>Usage</i>
REV Maintenance - Detail Page	EN_REVISION	Define revision codes and determine the date that those revisions become effective.
REV Maintenance - Text	EN_REV_TEXT	Enter text that you want to associate with a revision. REV Maintenance - Detail Page
REV Maintenance - Documents	EN_REV_DC	Associate, view, and manage pertinent revision documents in the document management system that is embedded in the PeopleSoft system. You must have PeopleSoft Engineering installed to access this page. REV Maintenance - Detail Page
REV Maintenance - Attachments Page	EN_REV_ATT	Associate attachments with an item revision.

Related Links

[Understanding Mass BOM Changes](#)

REV Maintenance - Detail Page

Use the REV Maintenance - Detail page (EN_REVISION) to define revision codes and determine the date that those revisions become effective.

Navigation:

Manufacturing Definitions > BOMs and Revisions > Maintain BOMs and Revisions > Maintain Item Revisions

This example illustrates the fields and controls on the REV Maintenance - Detail page. You can find definitions for the fields and controls later on this page.

The screenshot shows the 'REV Maintenance' page for item 'Professional Road Bike, Womans'. It includes a 'Revisions' table with the following data:

*Rev	*Eff Date	Description
A	01/01/1985	Initial introduction

Field or Control	Description
Rev (revision) and Eff Date (effective date)	Enter values for each revision code that you're defining. Although you can enter as many user-defined revisions as you want, there can be no overlapping dates and no gaps between revision dates for a specific item.

Note: You cannot use the same revision multiple times for an item. Also, you cannot delete a revision if it's tied to an item or one of its BOM components or if it appears on a production order or an ECO. If a component is used on a BOM or an ECO and you attempt to change revision dates for the component, the system displays a warning.

In the following example, you can see how existing revisions and BOM effectivity dates are affected when you manually insert a revision (or when the system automatically inserts a new revision). The obsolete date of the preceding revision must be the day before the effective date of the newly inserted revision. Also, if an obsolete date for a revision changes because a new revision is inserted, the obsolete date is also changed on any BOM where it appears.

In this example, a revision-controlled item called LT5000 has these revisions:

Revision	Effective Date	Obsolete Date
AA	01/01/1900	12/31/1996

Revision	Effective Date	Obsolete Date
BB	01/01/1997	12/31/1997
CC	01/01/1998	12/31/1998
DD	01/01/1999	12/30/2099

In addition, LT5000 has this BOM:

Component	Effective Revision/Date	Obsolete Revision/Date
A001	AA (01/01/1900)	CC (12/30/1998)
A002	AA (01/01/1900)	DD (12/30/2099)
A003	AA (01/01/1900)	-- -- (12/31/2099)

If you add a new revision named CCC on 05/01/1998, then revisions and their underlying effectivity dates change. In addition, component BOMs also reflect this change. This table shows these changes:

Revision	Effective Date	Obsolete Date	Note
AA	01/01/1900	12/31/1996	N/A
BB	01/01/1997	12/31/1997	N/A
CC	01/01/1998	04/30/1998	The obsolete date is changed to the day before the effectivity date of CCC (the new revision).
CCC	05/01/1998	12/31/1998	The new revision is added on 05/01/1998.
DD	01/01/1999	12/31/2099	N/A

The BOM is now as follows:

Component	Effective Revision and Date	Obsolete Revision and Date
A001	AA (01/01/1900)	CC (04/30/1998): The BOM is modified to reflect changes to revision effectivity dates.

Component	Effective Revision and Date	Obsolete Revision and Date
A002	AA (01/01/1900)	DD (12/30/2099)
A003	AA (01/01/1900)	-- -- (12/31/2099)

Although the obsolete revision (CC) remains the same, the BOM obsolete date is changed to the new obsolete date of CC.

When a revision-controlled item is specified in production, the system selects components by determining which revision is in effect at the start date or due date of production and which components are in effect for that revision. The system uses the production start or due date to determine which components for the revision are in effect. This is also true when a revision-controlled item has phantoms. You can build to an older or a future revision by selecting a particular revision for the item. When an alternate revision is specified, the system uses the product structure associated with that revision.

You can also maintain revisions for component items. When adding a revision-controlled component to a BOM, the component revision field becomes accessible to allow entry of the component's revision.

Note: If you have deselected the **Components Align with Revision** option on the MFG Business Unit Options page, you receive a warning regarding components that are not aligned when you change dates of existing revisions. This warning occurs when the change in a revision date causes any existing nonaligned components on BOMs to move to a different revision number based on the date changes that you make. Any affected components are displayed in the REV Maintenance component so that you can address them manually if needed.

REV Maintenance - Attachments Page

Use the REV Maintenance - Attachments page (EN_REV_ATT) to associate attachments with an item revision.

Navigation:

Manufacturing Definitions > BOMs and Revisions > Maintain BOMs and Revisions > Item Revisions > REV Maintenance > Attachments

Field or Control	Description
File Ext (file extension)	Select the type of media to attach.
Document ID	Enter the file name.
	Click the Attachments button to launch the multimedia object attached to the revision.

Note: Attachments have no integration or relation to the embedded document management functionality. They are most useful if you are not using the document management functionality.

Maintaining BOMs

To create and maintain BOMs, use the BOM Maintenance (BOM_MAINTENANCE) component.

You can create and maintain the product structure for a manufactured item at a detailed level. You can define multiple outputs and add text, documents, or attachments for an assembly or for the components associated with an assembly. You can also create reference designators and component item substitutes.

You can create BOMs only for existing assembly items that are either owned or consigned and approved and whose source code is set to either *Make* or *Buy*. Additionally, you can maintain BOMs only for assemblies or end items if the **Used in MFG** check box is selected for them on the Define Business Unit Items - General: Costing page.

All assembly, output, and component items must use a standard cost profile for all of their books. Components can be owned or non-owned or non-owned and consigned with a source code of *Make*, *Buy*, *Floor Stock*, or *Expense*.

In addition to creating a primary BOM (with a BOM code equal to *1*), you can specify up to 98 alternate BOMs by entering additional BOM codes (greater than *1*) in the dialog box that appears when you access the Manufacturing BOMs component.

When you need to do additional or repair work on a completed assembly, you can create rework BOMs. This is especially useful if you have a standard rework process that requires additional components. As with manufacturing BOMs, you can define a primary rework BOM and up to 98 alternates using BOM codes. You create rework BOMs by selecting **Rework** as the production type when adding a BOM on the Manufacturing BOMs component. Rework BOMs are always single-level BOMs. Also, PeopleSoft Cost Management does not include rework BOMs in cost maintenance. The rework BOM does not include the assembly being reworked as a component. In PeopleSoft Manufacturing, when you firm up or release the rework production ID, the system copies the rework BOM to create a component list and automatically adds the assembly being reworked. Rework BOMs cannot include multiple outputs; the system automatically includes the assembly being reworked as an output when production is created.

When you add a BOM for an item or change any attribute of an existing BOM, you can have the system send a workflow notification to the selected roles that you've defined—such as engineering manager or cost accountant.

Pages Used to Maintain BOMs

Page Name	Definition Name	Usage
<u>Manufacturing BOMs - Summary Page</u>	EN_BOM_MAINT	<p>Maintain all components that make up a particular manufacturing BOM for an assembly in a specified business unit.</p> <p>You can create and maintain a rework BOM to define a standard kit of components for use in repair. You can also indicate which components can be recovered if the assembly can be torn down into component parts.</p> <p>You'll maintain BOMs one level at a time.</p>
Header: Assembly Text Page	EN_BOM_TEXT	<p>Associate text with an assembly.</p> <p><u>Manufacturing BOMs - Summary Page</u></p>
Header: Assembly Attachments Page	EN_BOM_ATT	<p>Associate attachments with BOMs.</p> <p><u>Manufacturing BOMs - Summary Page</u></p>
Header: Assembly Documents Page	EN_BOM_DC	<p>Associate, access, and manage pertinent assembly BOM documents in the document management system that is embedded in the PeopleSoft system.</p> <p>You must have PeopleSoft Engineering installed to access this page.</p> <p><u>Manufacturing BOMs - Summary Page</u></p>
<u>Header: Outputs Page</u>	EN_BOM_OUTPUTS	Enter output information.
<u>Header: Supplier Access List Page</u>	EN_SS_BOMVND_LST	<p>Access a current list of Suppliers who have access to a specific item.</p> <p>You must have PeopleSoft Engineering installed to access this page.</p>
Header: Send Email to Suppliers - New Message Page	EG_IC_EMAIL	<p>Send email to Suppliers.</p> <p>You must have PeopleSoft Engineering installed to access this page.</p>
<u>Components: Component Details Page</u>	EN_COMP_MAINT	Add details for each assembly BOM component.

Page Name	Definition Name	Usage
Components: Text Page	EN_COMP_TEXT	Attach and maintain component text. Components: Component Details Page
Components: Attachments page	EN_COMP_ATT	Associate attachments with components. Components: Component Details Page
Components - Documents Page	EN_COMP_DC	Associate, access, and manage pertinent component documents in the embedded document management system. You must have PeopleSoft Engineering installed to access this page. Components: Component Details Page
Components: Reference Designators Page	EN_COMP_DESIG	Associate designators to a component of an assembly item.
Components: Dimensions Page	EN_COMP_DIM	Specify and maintain BOM component dimensions.
Components: Substitutes Page	EN_COMP_SUB	Add substitute components. Substitutes must be defined and approved in PeopleSoft Inventory.
Components: Copy Business Unit Substitute Items Page	EN_BOM_SUB_ITEM_SP	View valid substitutes for the component, and copy the substitutes to the BOM.

Related Links

[Understanding Display of BOMs](#)

[Delivered Workflows for PeopleSoft Manufacturing](#)

Common Elements Used in This Section

Field or Control	Description
BOM State	Select a BOM state. Values are: <ul style="list-style-type: none"> <i>Engineering</i>: Select to view EBOMs. <i>Manufacturing</i>: Select to view MBOMs.

Field or Control	Description
Verify BOM	<p>Indicates whether the system performs online loop checking. Set this option at the manufacturing business unit level on the MFG Business Unit Options page.</p> <p>On the MFG Business Unit Options page, you can elect to always verify online or never verify online. The check box on the Engineering BOM Summary page reflects the manufacturing option that you select.</p> <p>If you select to always verify online, the system checks for looping BOMs as you maintain the assembly's or end item's bill. This prevents you from adding the end item as one of its own components at this level or any lower levels. If you select Never Verify Online, loop-checking runs as a deferred process.</p>

Manufacturing BOMs - Summary Page

Use the Manufacturing BOMs - Summary page (EN_BOM_MAINT) to maintain all components that make up a particular manufacturing BOM for an assembly in a specified business unit.

You can create and maintain a rework BOM to define a standard kit of components for use in repair. You can also indicate which components can be recovered if the assembly can be torn down into component parts.

Navigation:

Manufacturing Definitions > BOMs and Revisions > Maintain BOMs and Revisions > Maintain Manufacturing BOMs

This example illustrates the fields and controls on the Manufacturing BOMs - Summary page: Components tab. You can find definitions for the fields and controls later on this page.

*Component ID	Description	Op Seq	*Eff Date	*Obs Date	Quantity	Std UOM	*Per		
00000000000020013	Creamy Tomato Sauce - Processed - Spice - Tomatoes - Cream	20	01/01/1900	12/31/2099	1000.0000	GAL	Orde	+	-
00000000000020025	Bottle, 28 oz.	10	01/01/1900	12/31/2099	4500.0000	EA	Orde	+	-
00000000000020028	Screwtop	20	01/01/1900	12/31/2099	4500.0000	EA	Orde	+	-
00000000000020029	Label - 28oz Creamy Tomato	30	01/01/1900	12/31/2099	4500.0000	EA	Orde	+	-
00000000000020030	Packing Box	40	01/01/1900	12/31/2099	375.0000	EA	Orde	+	-

This example illustrates the fields and controls on the Manufacturing BOMs - Summary page: Details tab. You can find definitions for the fields and controls later on this page.

Summary
Header
Components

Unit: US012

Item ID: 000000000000020036 Creamy Tomato Sauce Bottled, 28 oz

BOM Type: Production BOM Code: 1 Serial Control: N

BOM Qty: Std UOM: CS Source Code: Make

Verify BOM:

Components
Customize | Find | View All | First 1-5 of 5 Last

Component
Details

*Component ID	Description	Op Seq	*Eff Date	*Obs Date	Pos	*Yield	Source Cd		
<input type="text" value="000000000000020013"/>	Creamy Tomato Sauce - Processed - Spice - Tomatoes - Cream	<input type="text" value="20"/>	<input type="text" value="01/01/1900"/>	<input type="text" value="12/31/2099"/>	<input type="text"/>	100.0000	Make	<input type="button" value="+"/>	<input type="button" value="-"/>
<input type="text" value="000000000000020025"/>	Bottle, 28 oz.	<input type="text" value="10"/>	<input type="text" value="01/01/1900"/>	<input type="text" value="12/31/2099"/>	<input type="text"/>	100.0000	Buy	<input type="button" value="+"/>	<input type="button" value="-"/>
<input type="text" value="000000000000020028"/>	Screwtop	<input type="text" value="20"/>	<input type="text" value="01/01/1900"/>	<input type="text" value="12/31/2099"/>	<input type="text"/>	100.0000	Buy	<input type="button" value="+"/>	<input type="button" value="-"/>
<input type="text" value="000000000000020029"/>	Label - 28oz Creamy Tomato	<input type="text" value="30"/>	<input type="text" value="01/01/1900"/>	<input type="text" value="12/31/2099"/>	<input type="text"/>	100.0000	Buy	<input type="button" value="+"/>	<input type="button" value="-"/>
<input type="text" value="000000000000020030"/>	Packing Box	<input type="text" value="40"/>	<input type="text" value="01/01/1900"/>	<input type="text" value="12/31/2099"/>	<input type="text"/>	100.0000	Buy	<input type="button" value="+"/>	<input type="button" value="-"/>

Note: When BOMs are complex and deep, run the BOM Verification process and set BOM verification to **Never Verify Online** to improve BOM maintenance performance. Use the batch BOM Verification Request page.

Header Information

<i>Field or Control</i>	<i>Description</i>
BOM Type	<p>Select the type of BOM you're creating. Values are:</p> <ul style="list-style-type: none"> <i>Production:</i> Use manufacturing BOMs as the basis for manufacturing assemblies or end items. <i>Rework:</i> Create rework BOMs when you have a standard rework process that involves adding components. <p>For example, if you have a repair kit of components that you always issue when an item is reworked, you can define that repair kit here. As with manufacturing BOMs, you can define a primary rework BOM and up to 98 alternates by creating BOM codes. Rework BOMs are not required to create rework production IDs.</p> <hr/> <p>Note: You cannot add the end item to the rework BOM as a component. The system assigns the reworked item as a component when you release a rework production ID in PeopleSoft Manufacturing.</p>

Field or Control	Description
<p>BOM Qty (BOM quantity)</p>	<p>When BOMs contain a single-item output, you can use the BOM quantity in a particular way. The BOM quantity acts a scaling device that enables you to enter a product structure when the end item's specifications are in a base greater than 1 unit. The BOM quantity is the expected output quantity after all operation yield loss occurs. You determine the assembly quantity to which the system applies the components' quantity per assembly or per order. If the BOM quantity is greater than 1, enter the component quantity for the BOM quantity. If you set the BOM quantity to 1, the component quantity is the amount of the component required to make one unit.</p> <p>When BOMs contain multiple outputs, you use the field differently. If a primary item and its co-products are specified as output items on the BOM, the BOM quantity must match the primary item's average order quantity (AOQ) as defined in the Define Business Unit Item - Manufacturing: General page. If you change the BOM quantity, the system prompts you to update the AOQ with the newly entered BOM quantity. Keeping the two quantities in sync ensures correct costing of the output items.</p> <p>For serial-controlled items, the BOM quantity must be a whole number. The PeopleSoft system supports a calculated QPA precision of four to ten places to the right of the decimal point, depending on the installation setting on the Manufacturing Installation Options page in Set Up Financials/Supply Chain.</p>
<p>Sort Option</p>	<p>Select one of these values:</p> <ul style="list-style-type: none"> • <i>Component</i> • <i>Effectivity</i> • <i>Op Sequence</i> (operation sequence) • <i>Pos Number</i> (position number)
<p>Component ID</p>	<p>Select the component that you want to add to the BOM.</p>

Field or Control	Description
	<p>Click the View Related Links button to access the Item Search Criteria page to locate a different item.</p> <hr/> <p>Note: A component cannot be the same as its parent, and you cannot have overlapping effectivity dates for the same component.</p> <hr/> <p>Furthermore, you cannot add staged date-controlled items and configured items as components on BOMs.</p> <p>When you add a component with item status of <i>Hold</i> or <i>Discontinue</i>, the system displays a warning message. Similarly, when updating components with item status of <i>Hold</i> or <i>Discontinue</i>, you will receive a warning message when saving the page. In both cases, the warning message does not prevent you from performing the action.</p> <hr/> <p>Note: You cannot add an item with the status <i>Inactive</i>.</p>
<p>Comp Rev (component revision)</p>	<p>Indicates whether any component on the bill is under revision control. For items under revision control, you can associate a specific component revision with the assembly item.</p> <p>Depending on how you set business unit-level manufacturing options on the MFG Business Unit Options page, the system allows you to leave the Comp Rev blank, select a default value, or select a different component revision for each revision-controlled component.</p> <p>If the system is set up to default component revision, the Comp Rev column initially displays the current revision. When you enter effective dates, the revision is updated with the component revision effective on the date specified.</p>

Field or Control	Description
<p>Op Seq (operation sequence)</p>	<p>Indicate where in the manufacturing or rework process you need the component. The operation sequence refers to an operation on the assembly item's routing.</p> <p>For manufacturing BOMs, this is the item's production routing, and for rework BOMs, it's the item's rework routing.</p> <p>The default operation sequence is 0 which is the first operation of the manufacturing or rework process. If you set the operation sequence for all items to 0, the system treats all items as required at the beginning of production. Therefore, the items need to be issued at the start of the first operation.</p> <p>You define operation sequence on the item's routing by using the Routing Definition Summary page.</p> <p>When maintaining the BOM, you can select any operation on the assembly item's routing. Once the routing has been established, the system lists the valid operation sequences for all corresponding routing codes and routing types in the operation sequence Detail column.</p> <p>For production BOMs, the system displays operation sequences only for production routings.</p> <p>For rework BOMs, the system displays operation sequences only for rework routings.</p> <hr/> <p>Note: If a master routing is in use, then valid operation sequences include all manufacturing sequences associated with the item's master routing.</p> <hr/> <p>Because a work center is associated with the routing's operation, PeopleSoft Manufacturing uses the operation information to determine the work center to which the component must be delivered.</p> <p>When the component's issue method is <i>Issue</i> or <i>Replenish</i>, the component is issued to the work center, and it is stocked in and consumed from the work center's WIP location storage area.</p> <p>When the component's issue method is <i>Kit</i>, the work center is still used as the indicator for material delivery. The production ID, however, is charged directly for the component and is not consumed from the WIP location.</p> <p>If the operation sequence specified for the component is 0 or does not exist on the routing, the system treats the material as required for the start of production. It issues the material to the work center associated with the production area where the item is being built.</p>

Field or Control	Description
	<p>When the operation sequence is set to 0, it is assumed that the component item is used at the first operation.</p> <p>If you enter the BOM before the routing, you can return to the BOM Summary page and add the relevant operation sequence after entering the routing.</p>
<p>Eff Date (effective date) and Obs Date (obsolete date)</p>	<p>Enter dates for the components of the assembly item.</p> <p>When replacing a discontinued (use-up) item on the BOM, the obsolete date of the discontinued item and the effective date of the replacement item must be manually set to the same date.</p> <p>Use the projected use-up date generated in PeopleSoft Supply Planning as the suggested obsolete date.</p> <p>If you are using revisions, enter valid revisions in the Eff Rev (effective revision) and Obs Rev (obsolete revision) fields.</p> <hr/> <p>Note: These fields refer to the effective and obsolete revisions of the assembly, not the component in the assembly. The obsolete date or revision must be later than the effective date. The component is effective from the start date (or beginning time) of the effective revision through the end date (or end time) of the obsolete revision.</p> <hr/>
<p>Quantity</p>	<p>Displays the quantity of the component required for the BOM. You can override this value if necessary.</p>
<p>Std UOM (standard unit of measure)</p>	<p>The system displays the standard UOM for this BOM component.</p>

Field or Control	Description
Per	<p>Values are:</p> <ul style="list-style-type: none"> • <i>Asy</i> (assembly) • <i>Ord</i> (order) <p>This field determines the number of each component that is needed in the parent assembly to manufacture or rework the specified batch quantity. If the quantity is per assembly, the quantity represents the number of that component required to manufacture one end item.</p> <p>If the quantity is per order, it indicates that the component quantity is a fixed amount, regardless of the production quantity.</p> <p>Additionally, if the component is serial-controlled, the Quantity Per field must be a whole number.</p> <p>To provide greater flexibility when defining MBOMs, the system doesn't require the Quantity field to follow the quantity precision rules defined for the item. The system displays a warning if you define a decimal quantity value for an item whose quantity precision value is a whole number.</p> <p>For example, if one B0004 component is required to make two assemblies called A0001, when you define the BOM, the QPA for B0004 would be 0.5. When the system applies the rounding rules to the QPA, it rounds the QPA for B0004 to 1, thereby inflating production costs.</p> <p>While the Quantity Per field can be maintained with a precision of four places to the right of the decimal, a calculated QPA can be defined with a precision from four to ten decimal places. Calculated QPA is determined as (Component QPA) ÷ (BOM Qty).</p> <p>This calculated QPA is used to determine the assembly items' cost and to plan and schedule components.</p>

Details tab

Field or Control	Description
Pos (position)	(Optional) Enter a position number. This can be a number associated with a component on a BOM drawing or on a list of all components that appear on a BOM.

<i>Field or Control</i>	<i>Description</i>
Yield	Displays the expected yield for the BOM component. If you are adding a new component, you can enter the expected yield.
Source Cd (source code)	Displays the source code associated with the component.

Engineering Considerations

If you are using PeopleSoft Engineering and outstanding ECOs are pending for the item, the system displays the **ECO** button next to the assembly item ID if you've checked the **ECO Pending Alert** check box on the ECO Item Status page. Click the **ECO** button to view information about the pending ECOs associated with the item.

Related Links

[Defining and Maintaining Revisions](#)

[Understanding Work Centers](#)

[Maintaining BOMs by Revisions or Effectivity Dates](#)

[Understanding Component Issue Methods](#)

[Understanding Routings](#)

Header: Assembly Attachments Page

Use the Header: Assembly Attachments page (EN_BOM_ATT) to associate attachments with BOMs.

Navigation:

Manufacturing Definitions > BOMs and Revisions > Maintain BOMs and Revisions > Manufacturing BOMs > Header > Assembly Attachments

<i>Field or Control</i>	<i>Description</i>
Document ID	Enter the file name for the attachment.
File Ext (file extension)	Select the type of media that you want to attach.
	Click the Attachments button to launch the multimedia object attached to the revision.

Note: You must set up file extensions on the File Locations page in Set Up Financials/Supply Chain, Common Definitions.

Related Links

“File Locations Page” (PeopleSoft Source to Settle Common Information)

Header: Outputs Page

Use the Header: Outputs page (EN_BOM_OUTPUTS) to enter output information.

Navigation:

Manufacturing Definitions > BOMs and Revisions > Maintain BOMs and Revisions > Manufacturing BOMs > Header > Outputs

This example illustrates the fields and controls on the Header - Outputs page: Output Summary tab. You can find definitions for the fields and controls later on this page.

Summary		Header		Components						
Assembly Text		Assembly Attachments		Assembly Documents						
Unit US012				<input type="checkbox"/> Verify BOM						
Item ID 000000000000020036		Creamy Tomato Sauce Bottled, 28 oz.								
BOM Type Production		BOM Code 1		Serial Control N						
BOM Qty 375		Std UOM CS		Source Code Make						
Outputs Personalize Find View All First 1 of 1 Last										
Output Summary		Attributes								
*Output Type	*Output Item	Description	Op Seq	*Eff Date	*Obs Date	*Output Qty	Std UOM	*Per		
Primary	000000000000020036	Creamy Tomato Sauce Bottled, 2		01/01/1900	12/31/2099	375.0000	CS	Assembly		

Output Summary Tab

Field or Control	Description
<p>BOM Qty (BOM quantity)</p>	<p>Displays the default information from the Manufacturing BOMs- Summary page, but you can change the quantity here.</p> <p>The detail portion of the page contains the end item as the item with the <i>Primary</i> output type, and this cannot be deleted. If you are not maintaining multiple outputs, you can simply bypass this page and the primary item is defined as the only output.</p> <p>When there is only one output for a BOM (the primary output), all fields in the row are unavailable, with default settings of the beginning time to the end time for the effectivity dates, 100 percent for the percentage fields, and output quantity set to <i>1</i>.</p> <p>However, if another co-product is inserted, the primary item's allocation percentage and cost percentage fields are accessible.</p> <p>Conversely, if all the co-products are deleted from the BOM, all the fields on the primary item, except the output quantity, are unavailable for input and set back to the defaults.</p> <p>If you are maintaining a rework BOM, this page lists only the reworked item as the end item.</p> <hr/> <p>Note: You cannot define co-products or by-products with rework.</p> <hr/>

Adding Outputs

Field or Control	Description
Output Type	<p>Select the type of output that you are adding. Values are:</p> <ul style="list-style-type: none"> • <i>Co-Product</i> • <i>Primary</i> • <i>Recycle</i> • <i>Teardown</i> • <i>Waste</i> <hr/> <p>Note: You cannot add more than one primary product.</p> <hr/> <p>If you have only one output on this BOM, then it is automatically the primary output.</p> <p>A <i>co-product</i> is an item that is produced as part of the manufacturing process along with the primary output. It shares the cost of the process, and there may be independent demand in Planning for this item. Examples of co-products are orange juice and orange concentrate in drink-processing.</p> <p>If the item is a co-product, the system checks to see whether the item's associated primary item is the item itself. (This is the default.) The system then prompts you to update the co-product's associated primary to this primary assembly item.</p> <p>A by-product can be a waste product that needs to be disposed of, or it can be a recycle by-product that can be used as an input to other processes (for example, orange pulp). The by-product is incidental to the process and has either a relief (negative) cost for recycle by-products or a disposal (positive) cost for waste by-products.</p> <p>Waste by-products might also have no cost associated with them. There would probably not be independent demand for by-products. Examples of recycle by-products are orange pulp.</p>
Output Item	<p>The item must be an existing, inventory, and standard costed item.</p> <p>Output items cannot be floor stock or expense items.</p>
	<p>Click the Item Search button to access the Item Search Criteria page to locate a different item.</p>

A number of restrictions apply to the **Output Type** and **Output Item** fields:

- An item cannot be a co-product and by-product on the same BOM.
- A primary item cannot be added to or deleted from a BOM.

The system always automatically adds the assembly or end item for which the BOM is created as the primary output item.

- By-product items must have the source code *Buy*.
- Co-product items must have the source code *Make*.
- Co-product items cannot be phantom or configured items.
- A co-product item cannot be the same as the primary item.
- An item cannot be both a co-product and a component on the same BOM.
- An item can be both a by-product and a component on the same BOM.
- As long as the effectivity dates do not overlap, the item can exist as a by-product more than once on the BOM—at different operations or at the same operation.
- An item cannot be both a waste and a recycle by-product on the same BOM.
- Additional outputs cannot be added to rework BOMs, phantom BOMs, or configured-item BOMs.

Operation Sequence

The operation sequence is inaccessible for any co-products because the co-product can be generated only at the last operation. You can specify operation sequences for by-products. If the operation sequence specified on the output doesn't exist on the routing chosen for production, then it's assumed that the by-product is generated at the last operation on the routing.

The operation sequence functions in a similar fashion for outputs as it does for the components. However, for components, an operation sequence of *0* means that it is needed at the first operation. For outputs, an operation sequence of *0* means it is generated at the last operation.

The effectivity dates and revisions behave similarly to component dates. If the assembly item is revision-controlled by revision, then the effective revision and obsolete revision are displayed. On the other hand, if the assembly item is revision-controlled by date, then the effective date and obsolete date are displayed. For the primary item and any co-products, these fields show the beginning time (*01/01/1900* or *---*) and the end time (*12/31/2099* or *---*), and they are display-only. Only by-products have editable effectivity dates.

Field or Control	Description
<p>Output Qty (output quantity)</p>	<p>Enter the quantity. The default quantity for the primary item appears, but you can change it if there are additional co-products.</p> <p>You must enter a quantity for each output.</p> <p>Primary and co-product quantities are expressed in relation to the BOM quantity. By-product output quantities are expressed in terms of the expected operation start quantity.</p> <p>For single-output BOMs (no co-products), the BOM quantity on the primary item needs to be the same as the output quantity. Therefore, if you change the BOM quantity, the system checks to see if the primary item is the only co-product on the BOM. If so, the system updates the primary item's output quantity to the BOM quantity.</p> <p>If the BOM already contains additional co-product outputs, and you delete all the additional outputs from the BOM, the system displays a warning that the primary output quantity will be reset to the BOM quantity.</p> <p>In addition, if the output quantity is used, it should be identical to the item's average order quantity defined in the Define Business Unit Item - Manufacturing: General page.</p> <hr/> <p>Note: For multiple output items, the BOM quantity for the batch BOM item must match the average order quantity that is defined for the item.</p> <hr/>
<p>Std UOM (standard unit of measure)</p>	<p>The system uses the output item's standard UOM.</p> <hr/> <p>Note: Because co-products can have different UOM values, the quantities for all the co-products do not need to add up to the BOM Quantity.</p> <hr/>

Field or Control	Description
Output Qty Per (output quantity per)	<p>This display-only field is available for co-products only. Values are:</p> <ul style="list-style-type: none"> <i>Asy</i> (assembly): This indicates that the output quantity has a relationship to the BOM quantity. <p>If the output quantity for a BOM quantity of 200 is 3, and you produce a batch with a quantity of 400, it's expected that the output quantity would be 6.</p> <ul style="list-style-type: none"> <i>Ord</i> (order): This indicates that the output quantity is a fixed amount, regardless of the BOM or batch size. <p>The quantity code for the co-products is based on assembly and cannot be changed.</p>

Attributes Tab

Field or Control	Description
Res % (resource allocation percentage)	Use this field to determine how much of the BOM quantity each co-product represents. It is used during completions to determine the percentage of the components that is consumed for each co-product and primary item.
Cost % (cost allocation percentage)	<p>Use this to distribute the cost across the co-products. The cost percentage indicates the percentage of the total batch costs to be applied to the primary item or co-products.</p> <p>By having two percentages, the resource allocation and cost can be distributed differently for each co-product.</p> <hr/> <p>Note: You cannot set the Res% or Cost% field to 0.</p> <hr/>

Resource Allocation Percentage Example

In this BOM structure, the quantity of the primary output item 6000) equals 60 gallons and quantity of the co-product (item 6001) equals 30 pounds. The resource allocation percentage for the primary and co-product does not need to be proportional to the output quantity, and it can be set to any percentage, as long as it totals 100 percent.

The following diagram illustrates the resource allocation percentage between the primary and co-products. For this structure, the percentages are set to 60 percent for item 6000 and 40 percent for item 6001.

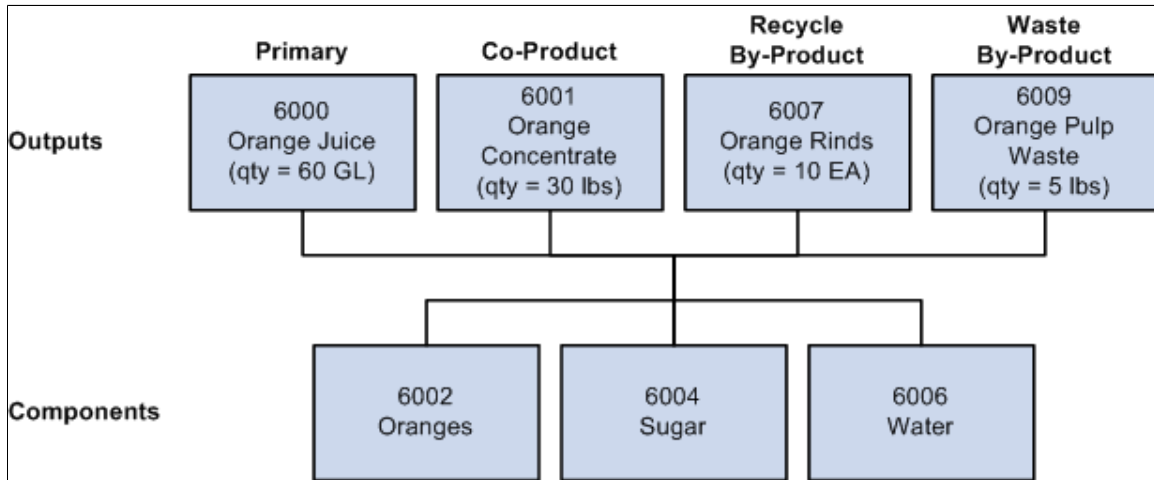

Effect of Resource Allocation Percentages During Completions

When recording completions for co-products, the system uses the resource allocation percentage to determine what proportion of the batch quantity is consumed. For example, if you did a partial completion of 15 pounds of item 6001, the proportion of the batch quantity completed would be:

$$(15/30) \times 40\% = 20\% \text{ of batch}$$

This would translate into a consumption of 20 percent of components, earned labor hours, and other related production costs. The system also uses the resource percentage on BOM inquiries to illustrate how much material each output uses when exploding down the levels.

The resource allocation percentage enables the outputs to be in different UOMs because the percentage specifies the relationship between the co-products, the primary item, and the batch quantity.

Note: For each type of percentage, the total of all primary and co-product percentages must add up to 100 percent. For a single primary item (no co-products), both of these percentages are set to 100.

Header: Supplier Access List Page

Use the Header: Supplier Access List page (EN_SS_BOMVND_LST) to access a current list of Suppliers who have access to a specific item.

Navigation:

Manufacturing Definitions > BOMs and Revisions > Maintain BOMs and Revisions > Manufacturing BOMs > Header > Supplier Access List

<i>Field or Control</i>	<i>Description</i>
Suppliers Associated with BOM	Displays all suppliers that have been granted access to the specific item and its associated BOM.

<i>Field or Control</i>	<i>Description</i>
BOM Access by Supplier	Click to access the BOM Access by Supplier page.
Send Email to Suppliers	Click to send email. The email message contains two URLs. One URL sends the recipient to the Manufacturing BOMs - Summary page in PeopleSoft Manufacturing, and the other URL sends the recipient to the Bill of Material inquiry page in PeopleSoft Engineering.

Header: Send Email to Suppliers - New Message Page

Use the Header: Send Email to Suppliers - New Message page (EG_IC_EMAIL) to send email to Suppliers.

Navigation:

- **Manufacturing Definitions > BOMs and Revisions > Maintain BOMs and Revisions > Manufacturing BOMs > Header > Supplier Access List**

Click the **Send Email to Suppliers** link on the Manufacturing BOMs - Header: Supplier Access List page.

- **Engineering > BOMs and Revisions > Maintain EBOMs and Revisions > Engineering BOM Maintenance > Header > Supplier Access List**

Click the **Send Email to Suppliers** link on the Manufacturing BOMs - Header: Supplier Access List page.

This example illustrates the fields and controls on the Email Message page. You can find definitions for the fields and controls later on this page.

Email Message

To:

cc:

bcc:

Email Subject:

Message: http://adas0183.peoplesoft.com/psp/om910dvlnt/SUPPLIER/ERP/c/ROLE_VENDOR.EN_IC_BOM_INQ.GBL?Action=U&BUSINESS_UNIT=US012&INV_ITEM_ID=00000000000020036&BOM_STATE=PR&BOM_TYPE=PR&BOM_CODE=1
 or click on the link below if you are an internal PeopleSoft user:
http://adas0183.peoplesoft.com/psp/om910dvlnt/EMPLOYEE/ERP/c/MAINTAIN_BOMS_AN

If you have PeopleSoft Engineering installed, the default supplier email address appears in the **To** field. In the case of ECRs and ECOs, the email message is sent to all suppliers who have access to the affected item. In the case of MBOMs and EBOMs, the message is sent to the item itself. You can delete email addresses from the address field if you want.

Next, enter standard recipient email information in the **cc**, **bcc**, and **Email Subject** fields.

If you have PeopleSoft Manufacturing and PeopleSoft Engineering installed, all email fields provide the recipient with two URLs. In many cases, one is a URL to the page from which the email was sent, and the other is to a parallel page.

If you do not have PeopleSoft Engineering installed, the system provides only one URL for the PeopleSoft Manufacturing pages.

This table displays each page from which you can send email notifications. It also describes the URL destinations provided to the recipient. If PeopleSoft Engineering is not installed, you cannot send email from a PeopleSoft Engineering page or receive a PeopleSoft Engineering URL destination.

<i>Email Notification's Originating Page</i>	<i>URL Destination Page</i>
Bill of Material inquiry page in PeopleSoft Engineering	Bill of Material inquiry in PeopleSoft Engineering Manufacturing BOMs- Summary in PeopleSoft Manufacturing (if the BOM is a manufacturing BOM) or Engineering Manufacturing BOMs- Summary in PeopleSoft Engineering (if the BOM is an EBOM)

<i>Email Notification's Originating Page</i>	<i>URL Destination Page</i>
Change Request Detail page in PeopleSoft Engineering	Change Request Detail page in PeopleSoft Engineering ECR Maintenance - Header page in PeopleSoft Engineering
Change Order Detail page in PeopleSoft Engineering	Change Order Detail page in PeopleSoft Engineering ECO Maintenance - Header page in PeopleSoft Engineering
ECO Maintenance - Header page in PeopleSoft Engineering	ECO Maintenance - Header page in PeopleSoft Engineering Change Order Detail page in PeopleSoft Engineering
ECR Maintenance - Header page in PeopleSoft Engineering	ECR Maintenance - Header page in PeopleSoft Engineering Change Request Detail in PeopleSoft Engineering
Approve ECO page in PeopleSoft Engineering	Change Order Detail in page PeopleSoft Engineering ECO Maintenance - Header page in PeopleSoft Engineering
Manufacturing BOMs- Header: Supplier Access List page in PeopleSoft Manufacturing	Engineering Manufacturing BOMs- Summary page in PeopleSoft Engineering Bill of Material inquiry in PeopleSoft Engineering
Engineering Manufacturing BOMs- Header: Supplier Access List page in PeopleSoft Engineering	Manufacturing BOMs- Summary page in PeopleSoft Manufacturing Bill of Material inquiry page in PeopleSoft Engineering

Note: The sender of any email notification can always edit the distribution list and the URLs in the message. Also, even though recipients may receive URLs, they must have the necessary privileges to access the system.

Components: Component Details Page

Use the Components: Component Details page (EN_COMP_MAINT) to add details for each assembly BOM component.

Navigation:

Manufacturing Definitions > BOMs and Revisions > Maintain BOMs and Revisions > Manufacturing BOMs > Components > Component Details

This example illustrates the fields and controls on the Components - Component Details page. You can find definitions for the fields and controls later on this page.

The screenshot displays the 'Components' tab of a software interface. At the top, there are navigation tabs: 'Summary', 'Header', and 'Components'. Below these are sub-tabs: 'Component Details', 'Text', 'Attachments', 'Documents', 'Reference Designators', 'Dimensions', and 'Substitutes'. The main area contains several fields: 'Unit: US012', 'Verify BOM: ', 'Item ID: 00000000000020036', 'Creamy Tomato Sauce Bottled, 28 oz.', 'BOM Type: Production', 'BOM Code: 1', 'Serial Control: N', 'Sort Options: Component', 'BOM Qty: 375', 'Std UOM: CS', and 'Source Code: Make'. A search bar for 'C&component' is visible with 'Find | View All | First | 1 of 5 | Last' options. Below the search bar, the details for a component with ID '00000000000020013' are shown, including 'Op Seq: 20', 'Quantity: 1000.0000', 'Std UOM: GAL', 'Eff Date: 01/01/1900', 'Calc Quantity: 1000.0000000000', 'Source Cd: Make', 'Obs Date: 12/31/2099', '*Per: Order', and 'Pos: 0'. There are also checkboxes for 'Subcontract Supply', 'Non-Owned Item', 'Teardown', 'Phantom Item', and 'Serial Control'. An 'ECO Number' field is also present.

Note: When you add a component with the item status *Hold* or *Discontinue*, the system displays a warning message. Similarly, when you update components with the item status *Hold* or *Discontinue*, the system displays a warning when you save the page. In both cases, the warning message does not prevent you from performing the action.

Field or Control	Description
Sort Options	Select how you want to view components. Values are: <ul style="list-style-type: none"> • <i>Component</i> • <i>Effectivity</i> • <i>Op Sequence</i> (operation sequence) • <i>Position Number</i>
Comp Rev (component revision), BOM Qty (BOM quantity), Op Seq (operation sequence), Eff Date (effective date) or Eff Rev (effective revision), Obs Date (obsolete date) or Obs Rev (obsolete revision), and Quantity	These defaults come from the BOM Summary page, but you can change the values here at the component level. <p>Note: If a component itself is a revision-controlled assembly, you cannot enter a revision for the item. The column is not accessible, and the current revision is always used. This ensures consistency with PeopleSoft Cost Management and PeopleSoft Supply Planning, which use the current assembly revision when exploding assemblies.</p>
Pos (position)	(Optional) Indicates a position number. This can be a number associated with a component on a BOM drawing or on a list of all components that appear on a BOM.

Field or Control	Description
Per	<p>Select either <i>Asy</i> (assembly) or <i>Ord</i> (order).</p> <p>For the quantity, if you set the Per field to <i>Asy</i>, then when the system determines component requirements in PeopleSoft Supply Planning, it divides the quantity per by the BOM quantity and multiplies that result by the demand or order quantity.</p> <p>If you set the <i>Per</i> field to <i>Ord</i>, the system uses the quantity per order regardless of the demand quantity or order size. A quantity per order (QPO) is a fixed amount, regardless of the order size. If the QPO is 100, then the quantity issued to production is 100 regardless of whether an order is for 1 item or 500 items.</p> <hr/> <p>Note: The quantity per assembly may be different for original items and their substitutes.</p>
QPA (quantity per assembly)	<p>PeopleSoft Manufacturing supports a calculated QPA precision rounded from four to ten decimal places. The calculated QPA is displayed next to the Quantity field. Calculated QPA is determined as (Component QPA) ÷ (BOM Qty). So, for example, if a calculated QPA results in 6.54321, and the installation rounding precision is set to four places, the system recognizes this as 6.5432.</p>
Phantom Item and Serial Control	<p>These display-only fields are the defaults from the PeopleSoft Inventory item definition.</p>

Field or Control	Description
Yield	<p>Enter a value; the default is <i>100</i>.</p> <p>Component yield is the expected percentage of usable components within a batch of components issued to production. If you know that components can be damaged during the issuing or assembly process, you can account for that loss here. A 100 percent yield means that the entire quantity of the component is usable and none will be scrapped. A yield of 90 percent yield means that 10 percent of the component issued will be unusable or scrapped.</p> <p>The system uses the component yield setting in PeopleSoft Supply Planning and PeopleSoft Cost Management processes. In PeopleSoft Supply Planning, it inflates component requirements to account for the expected loss during the assembly process. When scheduling the number of components to be used in production, the system divides the required quantity by the component yield value to derive the scheduled quantity.</p> <p>For example, if an assembly has a demand of 100 units, and the quantity per assembly is 1 with a component yield of 90 percent, then planning requires 111 components ($100 \div .90$). If the expected 10 percent yield loss occurs, 11 components ($111 \times .10$) are unusable, leaving you with the original required 100 components. When calculating the cost of the assembly, the system includes the component yield loss, thereby increasing the cost contribution of the component.</p> <hr/> <p>Note: The system doesn't support component yield for components expressed in quantity per order.</p> <hr/>
ECO Number	<p>This display-only field indicates that the BOM was updated using the PeopleSoft Engineering BOM Mass Maintenance by ECO process (ENPMMAIN).</p> <p>The number displayed is the last ECO number that updated the component on the BOM. If no ECO has been run against this component on this BOM, this field is blank.</p>

Subcontracting

PeopleSoft Manufacturing can handle all subcontracting and nonsubcontracting scenarios, including those in which:

- You handle manufacturing in house, and you supply all components.
- A subcontractor supplies some of the components, and outside processing is performed.
- The customer supplies some of the components, and you are the subcontractor.

Occasionally, you may want to maintain the full product structure of the assembly item, even though you do not provide all the components necessary to manufacture the item.

Field or Control	Description
Subcontract Supply	Select if an outside supplier supplies part of the manufacturing process and the component is supplied by the outside supplier.
Non-Owned Item	Select if you do not own the component, and you want to indicate that the customer supplies the component.

In a typical scenario, you send a partially completed assembly to a subcontractor who then adds a component and returns the altered assembly. This has planning, production, and costing implications. When exploding demand for components stemming from an assembly requirement, the system doesn't include subcontracted supplied components. Scheduling components for production also excludes subcontracted supplied components. These subcontracted components are not included in the production picking plan or issued to a WIP location storage area. For the purposes of costing, subcontracted supplied components are not included in the assembly cost.

This table describes the **Subcontractor Supply** and **Non-Owned Item** field combinations:

Field Selection	Description
Subcontract Supply and Non-Owned Item are both selected.	A subcontractor supplies the component.
Subcontract Supply is deselected, and Non-Owned Item is selected.	You are the subcontractor, and the customer supplies the component.
Subcontract Supply and Non-Owned Item are deselected.	You supply the component.
Subcontract Supply is selected and Non-Owned Item is deselected.	This is not a valid combination.

Field or Control	Description
Teardown	<p>Select to indicate whether the component is an output from a teardown order.</p> <p>When you select the check box, the system designates the component as a teardown output. If you do not select the check box, this indicates the component will not be an output of a torn-down assembly.</p> <p>The Teardown check box applies only to teardown orders.</p> <p>When you create a teardown order based on a BOM for this item, the system copies the teardown components on the BOM to the teardown output list when released to production. This enables the system to keep teardown outputs in sync with component changes in the manufacturing BOM.</p> <p>However, the Teardown check box on the BOM is also copied down to the component list for regular production IDs (as the original production ID). That way, if you tear down based on an original production ID, the system can determine which components are used as outputs. The Teardown check box on the component list on the original production ID determines the structure of the teardown output list for the teardown production ID.</p> <p>If you selected the Default Teardown BOM Component option on the Manufacturing Business Unit Options page, the system designates all components as teardown outputs on all BOMs for all items in the business unit. For all items where this default is in place, the system selects the Teardown check box when you add a component to a BOM.</p> <p>Teardown components cannot be subcontractor-supplied because those components are not tracked within PeopleSoft Manufacturing.</p> <hr/> <p>Note: Only items with a source code of <i>Make</i> or <i>Buy</i> can be teardown components.</p> <hr/>

Related Links

- [Manufacturing BOMs - Summary Page](#)
- [MFG Business Unit Options Page](#)

Components: Reference Designators Page

Use the Components: Reference Designators page (EN_COMP_DESIG) to associate designators to a component of an assembly item.

Navigation:

Manufacturing Definitions > BOMs and Revisions > Maintain BOMs and Revisions > Manufacturing BOMs > Components > Reference Designators

<i>Field or Control</i>	<i>Description</i>
Reference Designators	<p>You can associate an unlimited number of reference designators with a component of an assembly item. The designator is any alphanumeric code that you can use to determine where a component is placed in an assembly. The electronics industry often uses reference designators for positioning components on circuit boards.</p> <p>Enter a reference designator up to 20 characters long. You can use it in relation to quantity per assembly. For example, if five pegs need to be placed in a board, you can give each its own reference designation to aid in positioning.</p>

Components: Dimensions Page

Use the Components: Dimensions page (EN_COMP_DIM) to specify and maintain BOM component dimensions.

Navigation:

Manufacturing Definitions > BOMs and Revisions > Maintain BOMs and Revisions > Manufacturing BOMs > Components > Dimensions

<i>Field or Control</i>	<i>Description</i>
Production Specifications	<p>These default values come from the item definition in PeopleSoft Inventory, but you can change them for the component.</p>

Components: Substitutes Page

Use the Components: Substitutes page (EN_COMP_SUB) to add substitute components.

Navigation:

Manufacturing Definitions > BOMs and Revisions > Maintain BOMs and Revisions > Manufacturing BOMs > Components > Substitutes

This example illustrates the fields and controls on the Components - Substitutes page. You can find definitions for the fields and controls later on this page.

Field or Control	Description
Substitute Item ID	Select the component that you want to add. Substitute items must be unique for the item. You cannot enter the same item twice as a substitute with different dates. For example, substitute A with effective dates from 01/01/99 to 02/01/99 and Substitute A with effective dates from 02/01/00 to 08/30/00 could not be substitutes for the same item. In this example, you would need to define a different substitute for the second set of effective dates.
Priority, Rate, From Date, and To Date	Enter values for the new component. Enter the conversion rate in the Rate field.
Std UOM (standard unit of measure)	Enter the UOM, which can be different for the substitute and the original component.

Note: A substitute item cannot be a phantom or a component of a phantom. Also, if substitutes exist, the item cannot be changed to a phantom.

Note: If no substitute items are defined for an item that has been designated as *Discontinued*, there may be a shortage of that item if demand exceeds the existing quantity on hand. If a substitute has been defined for that item, the PeopleSoft system automatically selects the substitute when the quantity on hand for the discontinued item runs out.

Components: Copy Business Unit Substitute Items Page

Use the Components: Copy Business Unit Substitute Items page (EN_BOM_SUB_ITEM_SP) to view valid substitutes for the component, and copy the substitutes to the BOM.

Navigation:

Manufacturing Definitions > BOMs and Revisions > Maintain BOMs and Revisions > Manufacturing BOMs > Components > Substitutes

Click the **Copy BU Substitute Items** button.

<i>Field or Control</i>	<i>Description</i>
OK and Yes	Click to copy business unit-level substitutes to the BOM level.

Note: Changes to the BOM maintenance substitute list in PeopleSoft Supply Planning are not transferred back to the transaction system.

Copying and Deleting BOMs

You can copy and delete BOMs. If different items have similar structures, you can copy the structure of one item to another within the same business unit. During the copying process, you can include or exclude certain components and substitutes. Using the Manufacturing BOMs component, you can then change the new structure as needed.

This section discusses how to Copy and Delete BOMs.

Pages Used to Copy and Delete BOMs

<i>Page Name</i>	<i>Definition Name</i>	<i>Usage</i>
<u>Copy BOM Page</u>	EN_BOM_COPY	Copy BOMs from one business unit and item ID combination to another.
<u>Copy BOM Detail Page</u>	EN_BOM_COPY_DET	View details of the BOM that you are copying.
<u>Copy Outputs Page</u>	EN_BOM_COPY_OUT	Copy output rows from the source BOM to the target BOM.
<u>Delete BOMs Page</u>	EN_BOM_DELETE	Delete BOMs for assembly or end items.

Copy BOM Page

Use the Copy BOM page (EN_BOM_COPY) to copy BOMs from one business unit and item ID combination to another.

Navigation:

Manufacturing Definitions > BOMs and Revisions > Maintain BOMs and Revisions > Copy Manufacturing BOMs > Copy BOM

This example illustrates the fields and controls on the Copy BOM page. You can find definitions for the fields and controls later on this page.

The screenshot shows the 'Copy BOM' page with the following sections:

- Source BOM:** Includes fields for *Unit (US008), *Item ID (MT2000), BOM Type (Production), BOM Code (1), Eff Rev (---), Eff Date (01/01/1900), and Std UOM (EA). A 'Search' button is present.
- Target BOM (BOM2):** Includes fields for *Unit (US008), *Item ID (MT3000), and BOM Code (1). An 'Edit BOM' button is present.
- Component Details:** A table with columns: Copy, Copy Sub, Component ID, Description, Comp Rev, Op Seq, Pos Nbr, Effective, and Obsolete. The 'Copy' checkbox is checked, and 'Op Seq' is 0.

Source BOM

<i>Field or Control</i>	<i>Description</i>
Unit, Item ID, BOM Code, , and Eff Date (effective date) or Eff Rev (effective revision)	Enter values for the BOM that you want to copy.
BOM Type	Note: The BOM type of the target BOM and the source BOM must be the same. Consequently, it is not entered in the Target BOM group box.
All Dates/Revs	Select to copy all dates and revisions for the BOM.
Search	Click to retrieve the source BOM.

Target BOM (BOM2)

<i>Field or Control</i>	<i>Description</i>
<p>Unit, Item ID, and BOM Code</p>	<p>Enter values for the target BOM. The item must be a valid <i>Make</i> or <i>Buy</i> item in the target business unit.</p> <p>You cannot copy a BOM to a floor stock or expensed item.</p> <p>You can also copy assembly and component text, documents, and attachments. Use the Copy Engineering BOM Detail page to copy attachments.</p> <p>If you are copying a source assembly or end item that's revision-controlled to a target that is not a revision-controlled item, then the system uses the source component's revision effectivity dates to determine the effective and obsolete dates of the target item's components.</p> <p>The target BOM is also updated with any component revisions specified on the source BOM.</p>
<p>Edit BOM</p>	<p>After you click Save, the system activates this button.</p> <p>Click the Edit BOM button to access the BOM Summary page, where you can edit the attributes of the target BOM.</p> <hr/> <p>Note: You cannot copy a BOM to a target business unit and item ID if the assembly item or any of its components is not defined in the target business unit. If components do not exist in the target business unit, you can deselect the copy check boxes and add the balance of the BOM. You can then add the missing components in the target business unit and use the Manufacturing BOMs component to complete the BOM structure.</p> <hr/> <p>If the specific BOM already exists at the target business unit, you are prompted to overwrite the existing BOM with the information that you are currently copying. If you overwrite the existing BOM, the BOM in the target business unit is deleted and the source BOM is added.</p> <hr/> <p>Note: You cannot copy a BOM to itself.</p> <hr/>

Component Details

<i>Field or Control</i>	<i>Description</i>
Copy	Select to specify components to copy to the target BOM. If you deselect this check box, you can exclude a particular component row from being copied. If the component is revision-controlled, you can also exclude a specific component and revision combination from being copied.
Copy Sub (copy substitutes)	Select to copy specified substitutes.

Copy BOM Detail Page

Use the Copy BOM Detail page (EN_BOM_COPY_DET) to view details of the BOM that you are copying.

Navigation:

Manufacturing Definitions > BOMs and Revisions > Maintain BOMs and Revisions > Copy Manufacturing BOMs > Copy BOM > Copy BOM Detail

This example illustrates the fields and controls on the Copy BOM Detail page. You can find definitions for the fields and controls later on this page.

The screenshot shows the 'Copy BOM Detail' page with the following sections:

- Target BOM (BOM2)**:
 - Unit: US008, BOM Code: 1, Item ID: MT3000, Description: Mountain Bike, Womans, Std UOM: EA.
 - Buttons: Edit BOM
- Copy Options**:
 - Copy Assembly Text, Copy Component Text, Copy Assembly Att, Copy Component Att, Copy Assembly Docs, Copy Component Docs (all checked).
 - Buttons: View Source, View Target, Apply.
 - Dropdown: Same as Except.
- Component Details Table**:

Copy	Copy Sub	Component ID	Description	Comp Rev	Op Seq	Pos Nbr	Effective	Obsolete
<input checked="" type="checkbox"/>	<input type="checkbox"/>				0			

Field or Control	Description
Target BOM (BOM2)	<p>You can select to copy assembly text attachments and documents, as well as copy component text, attachments, and documents.</p> <hr/> <p>Note: You can copy documents only if you've selected the identical item IDs for both the source BOM and target BOM.</p> <hr/>
View Source	Click to view the original that you are copying and the copying choices that you've made.
View Target	Click to preview how the BOM will appear after the copy.

Field or Control	Description
Same as Except	<p>Select to indicate how the BOM is copied. Values include:</p> <ul style="list-style-type: none"> • <i>Exclude All</i>: The system copies no components to the target BOM. • <i>Exclude Item Range</i>: Fields appear so that you can enter a range of component IDs or position numbers that the system does not copy. • <i>Exclude Pos Range</i> (exclude position range): Fields appear so that you can enter a range of component IDs or position numbers that the system does not copy. • <i>Include All</i>: The system marks all components on the source BOM to be copied. • <i>Include Date Range</i> • <i>Include Item Range</i>: This feature is the same as the exclude feature except that you enter the range of items that you want to copy. • <i>Include Pos Range</i> (include position range): This feature is the same as the exclude feature except that you enter the range of position numbers that you want to copy. • <i>Include Revision Range</i>: You copy all components that are in effect between the specified dates or revisions. • <i>Include Date Range</i> and <i>Include Revision Range</i> • If you want to exclude a range of dates or revisions, select <i>Exclude All</i> and then include portions (by revision and date). <p>You can use the Same as Except field values with any combination. For example, you can initially select <i>Exclude All</i>, click Apply, and then select <i>Include Item Range</i> to copy only those items that fall within the range.</p> <ul style="list-style-type: none"> • You can also select <i>Include Item Range</i> or <i>Exclude Item Range</i> multiple times and click Apply after each selection to include or exclude chunks of items. The effect is cumulative, not exclusive. <p>You can then deselect a component's Copy check box or click Exclude All to deselect all the check boxes.</p>
Apply	Click once after you've selected the Same as Except value.
Copy	Select a component's check box to specify components or component revisions.
Copy Sub (copy substitutes)	Select to copy specified substitutes to the target BOM.

Engineering Considerations - Transferring BOMs

If you have PeopleSoft Engineering installed, you can also transfer multiple BOMs immediately from PeopleSoft Engineering to PeopleSoft Manufacturing or from PeopleSoft Manufacturing to PeopleSoft Engineering.

Related Links

“Transferring BOMs and Routings” (PeopleSoft Engineering)

Copy Outputs Page

Use the Copy Outputs page (EN_BOM_COPY_OUT) to copy output rows from the source BOM to the target BOM.

Navigation:

Manufacturing Definitions > BOMs and Revisions > Maintain BOMs and Revisions > Copy Manufacturing BOMs > Copy Outputs

<i>Field or Control</i>	<i>Description</i>
Copy	Select to designate that you want an output row to be copied from the source BOM to the target BOM. The primary item and co-products are always copied along with the output quantity, resource allocation percentage, and cost allocation percentage.



Delete BOMs Page

Use the Delete BOMs page (EN_BOM_DELETE) to delete BOMs for assembly or end items.

Navigation:

Manufacturing Definitions > BOMs and Revisions > Maintain BOMs and Revisions > Delete Manufacturing BOMs > Delete BOMs

<i>Field or Control</i>	<i>Description</i>
Unit, From Item ID, To Item ID, and BOM Type	Enter values for the BOMs to delete.
BOM Code	Enter a value in this field if you want to delete only a specific BOM code. If you leave the field blank, then all BOMs for the item are retrieved.
Search	Click to display the list of production or rework BOMs for the assembly items that you are deleting.

Field or Control	Description
	Click the Select All button to select each Delete? check box. Use this option to include or exclude assemblies that you want to delete.
	Click the Deselect All button to deselect each Delete? check box. For each assembly, the system deletes all BOM components, regardless of effectivity date or revision. All assembly BOMs scheduled for deletion have header, outputs, related text, attachments, components, and reference designators deleted. Only the BOM codes with the Delete? check box selected are deleted. The system displays an error message if you try to delete a BOM code that's part of a production option. The Delete BOMs process checks the system and warns you if the BOM is used in a production area or if production has the <i>Entered</i> status (production is planned, but a BOM and routing have not yet been frozen for production).

Note: Because the system copies BOMs to production, deleting a BOM has no impact on production with the status *Firmed* or *Released*.

Verifying BOMs

If BOMs are poorly designed, they can contain unwanted loops. A looping BOM occurs when an assembly has itself as a component of one of its subassemblies. To locate these loops in product structures, run BOM verification regularly. You can also use online BOM verification to check for looping BOMs. You set this option at the manufacturing business unit level by using the MFG Business Unit Options page. However, to improve BOM maintenance performance when BOMs are complex and deep, use the scheduled verification process and set online BOM verification to **Never Verify Online**.

Pages Used to Verify BOMs

Page Name	Definition Name	Usage
<u>BOM Verification Page</u>	EN_BOM_VERIFY_REQ	Locate unwanted loops in BOMs.
<u>Delete BOM Verification Rows Page</u>	EN_BOM_VERIF_DEL	Delete records created by the BOM verification request.

BOM Verification Page

Use the BOM Verification page (EN_BOM_VERIFY_REQ) to locate unwanted loops in BOMs.

Navigation:

Manufacturing Definitions > BOMs and Revisions > Identify Looping BOMs > BOM Looping Verification > BOM Verification

Field or Control	Description
All Dates/Revs (all dates and revisions)	Select to verify all dates and revisions of the BOM.
BOM Code	Enter the priority code of the BOM that you want to verify.
Depth	Enter a value to specify how many levels to verify.
Delete Rows, If No Errors	<p>Select to delete unnecessary BOM explosion table records. The verification request process adds a series of records to the BOM Explosion table. These records take up space and are of no use if there are no looping BOMs.</p> <p>You can also use the Delete BOM Verification Rows page to save space.</p> <p>The BOM Verification process (ENPBEXPV) checks only the primary BOM and routing when exploding at levels greater than 1. If there is more than one way to make a particular co-product output, you need to specify which BOM is the primary way to make the co-product. This indicates to the system which BOM to verify for the co-product.</p> <p>By selecting an associated primary BOM on the Define Business Unit Item - Manufacturing: General page, you designate which BOM to verify.</p> <p>The BOM Verification process takes both co-products and multiple BOM codes into account when checking if loops exist.</p>
Run	<p>Click to run the request. Process Scheduler runs the BOM Verification process at user-defined intervals.</p> <p>You receive a message only if the system finds a looping BOM.</p> <p>View the results of the BOM Verification process by using the BOM Verification Status page.</p>

See the product documentation for *PeopleTools: Process Scheduler*

Delete BOM Verification Rows Page

Use the Delete BOM Verification Rows page (EN_BOM_VERIF_DEL) to delete records created by the BOM verification request.

Navigation:

Manufacturing Definitions > BOMs and Revisions > Identify Looping BOMs > Delete BOM Verification Details > Delete BOM Verification Rows

The BOM Verification process adds a series of records to the BOM Explosion table. These records take up space and are not used if there are no looping BOMs.

<i>Field or Control</i>	<i>Description</i>
Unit and Process Instance	Select values to delete BOM Explosion table records. If you want to view all records for the business unit, leave the Process Instance field blank.
Search	Click to retrieve the selected records.
Delete?	Select to indicate which records to delete.
Save	Click to delete the selected records.

Note: You can also use the **Delete? Rows, If No Errors** field on the BOM Verification Request page to delete these records.

Defining BOM, ECR, and ECO Access by Supplier

To define access privileges for any supplier if you want them to view BOMs, ECRs, and ECOs, use the BOM Access by Supplier component. Use the EN_IC_BOM_PRIV_CI component interface to load data into the tables for this component.

You must define access privileges for any supplier if you want the supplier to view BOMs, ECRs, and ECOs. After you define the access privileges, associate these privileges with specific business unit items.

Note: You must have PeopleSoft Engineering installed to use this functionality.

For both the BOM inquiry and the ECR, you must use the BOM Access by Supplier page to enable the supplier to access information.

For ECOs, this page is optional. If a supplier is an approver on a change order, then that change order is automatically made available to that supplier. Suppliers can also view any ECO or ECR if the supplier has been granted access to view at least one of its items affected by the ECO.

Page Used to Define BOM, ECR, and ECO Access Privileges for Suppliers

<i>Page Name</i>	<i>Definition Name</i>	<i>Usage</i>
<u>BOM Access by Supplier Page</u>	EN_IC_BOM_PRIV	<p>Define privileges to view BOMs and ECOs and, in the case of ECRs, to add information.</p> <p>In addition, use this page to associate business unit items with suppliers. This enables you to grant suppliers item access by SetID and supplier code.</p>

BOM Access by Supplier Page

Use the BOM Access by Supplier page (EN_IC_BOM_PRIV) to define privileges to view BOMs and ECOs and, in the case of ECRs, to add information.

In addition, use this page to associate business unit items with suppliers. This enables you to grant suppliers item access by SetID and supplier code.

Navigation:

Manufacturing Definitions > BOMs and Revisions > Maintain BOMs and Revisions > BOM Access by Supplier > BOM Access by Supplier

Note: You need to define access only for the top-level assembly item, not for each component item row.

<i>Field or Control</i>	<i>Description</i>
Update ECR	<p>Select to grant the supplier the privilege of viewing and creating ECRs. This privilege is associated with the supplier, rather than with a specific item.</p> <p>By default, the check box is deselected. The supplier does not see Add, Upload, Save, and Delete buttons when viewing ECRs.</p> <hr/> <p>Note: Suppliers can change only the ECRs that they have created.</p> <hr/>
Add ECR Attachment and Add ECO Attachment	<p>Select to define whether the supplier can upload documents into ECRs and ECOs.</p> <p>Selecting these check boxes also enables suppliers to delete ECR and ECO attachments. Although they can delete ECR attachments that they own during any session, they can delete ECO attachments only during the session in which they added them (and only before saving the page).</p>
Item ID	Select all items that you want to be visible to the specified supplier.

This table outlines what the supplier can access, based on the settings you define with this page:

Check Box	Supplier Capability	Default
View MBOM	View the item MBOM for the specified BOM type and BOM code.	Selected
View EBOM	View the item EBOM for the specified BOM type and BOM code.	Selected
View ECR	View the ECRs associated with the item, including those not specifically entered by the supplier. You can use the Not Accessible by Suppliers check box on the ECR Header page to override this setting and block a supplier's access to a specific ECR.	Not Selected
View ECO	View the ECOs associated with the item, including those not specifically entered by the supplier. You can use the Not Accessible by Suppliers check box on the ECO Header page to override this setting and block a supplier's access to a specific ECO.	Not Selected

For example, if supplier V1 has access to business unit item MT2000, and only **View BOM** is selected, then supplier V1 can inquire only on the BOM for MT2000 and cannot access any other information. When the supplier signs on, only the Bill of Material Inquiry navigation selection is available.

If you've granted the supplier access to view ECRs and ECOs, the navigation selection **Engineering Change Order and Engineering Change Request** is accessible to the supplier when the supplier signs on. The ECR and ECO maintenance headers contain a **Not Accessible by Suppliers** check box. If selected, that option blocks access to the specified ECRs and ECOs. Therefore, even if you have granted suppliers access by using the BOM Access by Supplier page, you can deny them access to specific ECOs or ECRs.

Making Mass BOM Changes

Understanding Mass BOM Changes

Production departments need the ability to apply mass maintenance additions and changes directly to BOMs. This functionality is similar to the mass maintenance features in PeopleSoft Engineering, but it is also available in PeopleSoft Manufacturing, because not all changes go through PeopleSoft Engineering.

Note: If you have PeopleSoft Engineering installed, you can use the engineering mass maintenance functionality, including making mass changes to MBOMs or EBOMs by either ECO or mass maintenance code (MMC). This PeopleSoft Manufacturing mass maintenance documentation assumes that you do not have PeopleSoft Engineering installed.

Mass maintenance enables you to apply, in a single MMC process, the same set of changes to many manufacturing BOMs. For example, you can change all occurrences of one component for another or even add components to an assembly. Without this functionality, you must change one BOM at a time. Mass maintenance is a powerful tool that can increase productivity tremendously.

The BOM mass maintenance code setup page enables you to define an MMC that can later be applied to an assembly range or assembly list. An MMC enables you to define a specific set of component changes such as reference designator and component dimension changes: a component can be added and associated BOM information can be changed. The MMC enables you to designate that specific multiple output values are to be changed or added. You can even designate that automatic revisions are to be generated for revision-controlled items. There is also an inquiry that enables you to view all BOM mass maintenance exceptions.

Note: In addition to generating mass maintenance changes to BOMs, the mass maintenance process enables you to create new revision numbers automatically, based on a revision scheme that you define for the business unit.

Related Links

“Understanding Mass BOM Changes” (PeopleSoft Engineering)

Defining BOM Mass Maintenance Codes

To define manufacturing BOM mass maintenance codes, use the BOM Mass Maintenance (MBOM_MASS_MAINT) component.

This section provides an overview of BOM mass maintenance codes

Pages Used to Define BOM Mass Maintenance Codes

Page Name	Definition Name	Usage
<u>Search Page</u>	EN_BOM_MMC_SRCH	Identify the specific existing outputs or components to change. Specifying components also enables you to identify the BOMs that are impacted.
Search - Dimensions Page	EN_BOM_MMC_DIM_SP	Enter component dimension search criteria.
<u>Search - Reference Designator Page</u>	EN_BOM_MMC_REF_SP	Enter reference designator search criteria.
Search - Substitutes Page	EN_BOM_MMC_SUB_SP	Search for substitutes everywhere they are used.
<u>Manufacturing Assembly/Component Matches Page</u>	EN_BOM_MMC_VW_SP	This display-only page allows you to view the number of assemblies that match the search criteria that you have entered and view matching BOMs.
<u>Change Page</u>	EN_BOM_MMC_NEW	Specify new component values, once you have selected the set of components that you want to change on the Search page.
<u>Change - Dimensions Page</u>	EN_BOM_MMC_DIM2_SP	Make mass changes to component dimensions.
<u>Change - Reference Designators Page</u>	EN_BOM_MMC_REF2_SP	Make mass changes to reference designators.
<u>Change - Substitutes Page</u>	EN_BOM_MMC_SUB2_SP	Mass change a substitute everywhere it's used.
<u>Add Page</u>	EN_BOM_MMC_ADD	Add components or outputs to assemblies. The system adds these components or outputs to each BOM identified by the values that you entered on the Search page. Use the Process BOM Mass Maintenance pages to designate, at a later time, the specific assemblies to be affected by these changes.
Add - Dimensions Page	EN_BOM_MMC_DIM3_SP	Add component dimensions, if you are adding using the <i>Component</i> sequence type.

Page Name	Definition Name	Usage
Add - Reference Designators Page	EN_BOM_MMC_REF3_SP	Add reference designators, if you are adding using the <i>Component</i> sequence type.
<u>Add - Substitutes Page</u>	EN_BOM_MMC_SUB3_SP	Add a substitute everywhere it's required.

Related Links

“Defining Additional Common Information” (Application Fundamentals)

[Quantity Rounding Exceptions in PeopleSoft Manufacturing](#)

Understanding BOM Mass Maintenance Codes

Use the BOM Mass Maintenance pages to create and maintain BOM mass maintenance codes. These pages enable you to specify multiple BOM component or output changes and additions, including substitute items. A MMC consists of search pages, which allow you to identify existing components that are to be impacted, Change pages that allow you to change instances of those specific components on specific BOMs, and add pages that allow for the introduction of new components and detail information. After you've used these pages to define MMC codes, you can implement the changes directly, using the Process BOM Mass Maintenance by MMC page.

Note: To maintain components en masse for revision-controlled BOMs, enter effective and obsolete dates for the revision on these pages, regardless of whether the revision is controlled by revision name or effectivity date.

Prior to accessing any MMC pages, you must select a business unit and a MMC. The MMC value can be generated automatically.

Important! Any MMCs created in PeopleSoft Manufacturing are available only in manufacturing, and MMCs created in PeopleSoft Engineering are available only in engineering.

Note: To provide greater flexibility when defining MBOMs, the **Quantity** field does not need to follow the quantity precision rules defined for the item. A warning is issued if you define a decimal quantity value for an item whose quantity precision value is a whole number. This is an example of when you may need the quantity precision flexibility. If 1 B0004 component is required to make 2 assembly A0001s, then when defining the BOM, the QPA for B0004 would be 0.5. If you applied the rounding rules to the QPA, then it would round the QPA for B0004 to 1, and thereby inflate the production costs.

Related Links

“Defining Additional Common Information” (Application Fundamentals)

Prerequisites

Prior to making BOM mass maintenance changes, define:

- The appropriate assemblies and BOMs.

- Any revision-controlled items with automatic revisions if you plan to create automatic revisions.

Search Page

Use the Search page (EN_BOM_MMC_SRCH) to identify the specific existing outputs or components to change.

Specifying components also enables you to identify the BOMs that are impacted.

Navigation:

Manufacturing Definitions > BOMs and Revisions > BOM Mass Changes > BOM Mass Maintenance Codes

This example illustrates the fields and controls on the BOM Mass Maintenance Code - Search page. You can find definitions for the fields and controls later on this page.

The screenshot displays the search interface for BOM Mass Maintenance Codes. At the top, there are buttons for 'Search', 'Change', and 'Add'. Below these, the 'Business Unit' is set to 'US008' and the 'Mass Maint Code' is 'MMC0000003'. An 'Auto Revision' checkbox is present. The search criteria section includes:

- *Description: Change Component
- *Mass Maint Seq: 10
- *Sequence Type: Component

 A 'Matches' section follows, titled 'Where Search Values Are', containing various search fields:

- Component ID: PS1004
- Comp Rev: []
- Eff Date: []
- Obs Date: []
- Op Seq: []
- Quantity: []
- Per: []
- Yield: []
- Pos: []
- Sub Supply: []
- Non-Owned: []
- Teardown: []

 At the bottom, there is a 'Search Seq' field set to 1, and several checkboxes for 'Update Flag', 'Dimensions', 'Ref Designs', and 'Substitutes'.

Before you associate any changes or additions to an MMC, you can use the Search page to identify which specific outputs, components, or component revisions to change on the BOM.

When adding components, use the Search page to further identify the BOMs to which the new component should be added. For example, you may want to add component ID LT5001 only on BOMs that already have a component ID called LT5000 and a 12/31/97 obsolete date or perhaps where you already have component ID LT5000 and LT5001 defined. Similarly, you can use the Search page to further identify to which BOMs the new output should be added.

Note: On these pages, the fields that appear vary, depending on the choice of values in the required **Sequence Type** field. The page examples that you see are based on the value *Component* having been selected in the **Sequence Type** field. However, if you select *Output*, the system doesn't display the component ID, component revision, quantity, yield, position, if the item is supplied by a subcontractor, if the item is non-owned, or if it is a teardown item. It also does not display the dimensions, reference designators, and substitutes. Instead, it displays the output item, output type, output quantity, resource allocation percentage, and cost allocation percentage fields.

Field or Control	Description
Auto Revision	Select this check box to apply schemes for this mass maintenance code that automatically update revisions when a change event occurs. You actually generate the automatic revisions when you run the mass maintenance functionality.
Mass Maint Seq (mass maintenance sequence) and Descr (description)	<p>Enter a mass maintenance sequence number and its description. The mass maintenance sequence number enables you to set up more than one set of changes for a single mass maintenance code. The sequence number determines the order in which the changes are applied.</p> <hr/> <p>Note: The maximum number of sequence numbers that you can enter for a specific mass maintenance code is 20.</p>
Sequence Type	<p>Select <i>Component</i> or <i>Output</i>.</p> <p>If you select <i>Component</i>, enter the component search values. This optionally includes standard BOM fields such as Component ID, Comp Rev (component revision), Op Seq(operation sequence), Eff Date, (effectivity date), Obs Date (obsolete date), and quantity Per. The system searches for values that meet, at the same time, all of the criteria that you enter.</p> <hr/> <p>Note: The effective date and obsolete date that you enter indicates the precise date on which the component becomes effective or obsolete on the BOM.</p> <hr/> <p>If you select <i>Output</i> as the sequence type, then you can, optionally, select the output item and output type. You can also enter an output quantity, resource percentage, and cost allocation percentage.</p> <p>If you don't want to change a specific component, then leave the Component ID field blank, and select criteria based on the other fields. If you leave any field on the Component Search page blank, the system searches for BOM components without considering the blank search field. For example, if you leave Component ID blank and just enter a yield of 50, then all components with a yield of 50 are selected.</p> <p>To search for multiple components or outputs within a sequence, use the Where Search Values Are group box to enter "and" searches for more than one component or output on a BOM.</p>
Update Flag	<p>While searching for BOMs that contain multiple components or outputs, you may only want to actually make changes to a subset of all components or outputs.</p> <p>Select this check box to indicate which components or outputs you want updated by the Mass Maintenance process.</p>

Manufacturing Assembly/Component Matches Page

Use the Manufacturing Assembly/Component Matches page (EN_BOM_MMC_VW_SP) to this display-only page allows you to view the number of assemblies that match the search criteria that you have entered and view matching BOMs.

Navigation:

Manufacturing Definitions > BOMs and Revisions > BOM Mass Changes > BOM Mass Maintenance Codes > Search

Click the **Matches** link.

This example illustrates the fields and controls on the Manufacturing Assembly/Component Matches page. You can find definitions for the fields and controls later on this page.

Field or Control	Description
Count	<p>Click this button to view the number of assemblies that match the search criteria that you entered. The page displays MBOM totals. These values are the number of MBOMs that will be affected, assuming that you plan to perform mass maintenance processing for all BOMs in the business unit that meet the search criteria. The actual MBOMs to be changed can be determined by assembly list, by range, when the mass maintenance code is applied later.</p> <hr/> <p>Note: If you anticipate that a large number of BOMs are going to be affected by the search criteria, click the Count button before attempting to view the BOMs, to avoid viewing too much data online.</p>

Field or Control	Description
View BOMs	<p>Click this button to view manufacturing assembly matches to the criteria that you entered. This display of assembly matches lists the assemblies that can be affected by this mass maintenance sequence. When the mass maintenance code is applied later, this list of assemblies can be further restricted, by supplying a range of assemblies, a specific list of assemblies, or an ECO that contains assemblies with BOM changes.</p> <p>If you selected <i>Output</i> as the sequence type on the Search page, the assembly matches display the output item and output type instead of the component ID.</p>

Search - Reference Designator Page

Use the Search - Reference Designator page (EN_BOM_MMC_REF_SP) to enter reference designator search criteria.

Navigation:

Manufacturing Definitions > BOMs and Revisions > BOM Mass Changes > BOM Mass Maintenance Codes > Search

Click the **Ref Desigs** link.

For a given sequence, you can search using multiple reference designators. If you enter more than one reference designator, the system searches for BOM components, using a logical "and" between reference designators. To search references designators using an "or" logical, use multiple sequences.

Component Substitutes - Search Page

Use the Component Substitutes - Search page (EN_BOM_MMC_SUB_SP) to search for substitutes everywhere they are used.

Navigation:

Manufacturing Definitions > BOMs and Revisions > BOM Mass Changes > BOM Mass Maintenance Codes > Search

Click the **Substitutes** link.

You can narrow the search by using all or any combination of the substitute item search criteria.

Field or Control	Description
Sub Item (substitute item)	<p>Enter a value to search for a specific component substitute on a BOM.</p> <p>To search for a specific component substitute with a particular priority, then enter both the sub-item and the priority.</p> <p>To search for a specific component substitute with a particular conversion rate, enter both the sub-item and the conversion rate.</p>
From Date and To Date	Enter values for these fields to narrow the search.

Change Page

Use the Change page (EN_BOM_MMC_NEW) to specify new component values, once you have selected the set of components that you want to change on the Search page.

Navigation:

Manufacturing Definitions > BOMs and Revisions > BOM Mass Changes > BOM Mass Maintenance Codes > Change

This example illustrates the fields and controls on the BOM Mass Maintenance Code - Change page. You can find definitions for the fields and controls later on this page.

Use this page to change values or obsolete the components specified on the Search page.

Field or Control	Description
Component ID	<p>Enter a new value if you intend to change the Component ID field.</p> <hr/> <p>Note: This would typically be done for correcting BOMs. If you intend to keep the history of a component change, you should leave this field blank.</p> <hr/>
Output Item and Output Type	<p>If you selected <i>Output</i>, you can enter the required output change to data on this page. The effectivity dates operate in the same manner as they do for a component sequence type.</p>

Using Automatic Revisions and Effectivity Dates

Field or Control	Description
Eff Date (effective date) and Obs Date (obsolete date)	<p>These values determine the specific effectivity date changes mass maintenance will make to the BOM for the searched components. For example for obsolete components, leave the effective date value blank, and specify an obsolete date or use the second field next to the Obs Date field to derive an obsolete date for the component.</p> <p>In the second field you can select <i>Prior Date</i> or <i>Schd Date</i> for the obsolete date.</p> <p>If you select <i>Schd Date</i> for the effective date, at process time, the system translates this into the process run date.</p>
Obs Date (obsolete date)	<p>Select one of these values:</p> <ul style="list-style-type: none"> <p><i>Prior Date</i>: The day before the schedule date which is the process run date.</p> <p>This is used, for example, to obsolete a component the day before a new component is to take its place.</p> <p><i>Schd Date</i> (scheduled date): This date varies, depending on whether you selected the Auto Revision check box on the Search page.</p> <p>If revisions aren't automatically incremented, the schedule date is the run date of the process. This for example can be used to make a component obsolete on the run date when there is no component to take its place.</p> <p>If revisions are being automatically incremented, the obsolete date will have the obsolete date of the newly created revision.</p>

Field or Control	Description
Auto Revision	If this check box is selected, and you specify the schedule date for both the effective date and the obsolete date. The system displays a warning that the component will be effective for only one day.

Note: You can enter only one effective date. Therefore, if you specify a calendar date and then select *Schd Date*, the system clears the calendar date. Similarly, if you select a *Schd Date* and then enter a calendar date, the system clears the scheduled date. The **Obs Date** fields operate in the same manner.

This table lists the automatic revision impact that the second set of **Eff Date** and **Obs Date** fields have on both the revisions and the dates reflected on the BOMs. This example applies only to items that have been defined as revision-controlled on the Define Business Unit Item - Manufacturing: General page. Also, there is an example of how the dates will change on the BOM if the schedule date is 06/15/03 and the newly created revision is the latest revision for the item.

Change Obsolete Date to	None	Scheduled Date	Prior Date
When Effective Date = None	<p>Creates new automatic revision.</p> <p>There is no BOM component effectivity date change.</p> <p>Example: Both of the dates in the Eff Date and Obs Date fields are unchanged.</p>	<p>Creates new automatic revision.</p> <p>The system changes the obsolete date on the selected BOMs to the obsolete date of the newly added automatic revision.</p> <p>Example: The value in the Eff Date field is unchanged; the value in the Obs Date field is 12/31/2099. (The obsolete date of the new revision added on 6/15/03).</p>	<p>Creates new automatic revision.</p> <p>The system changes the obsolete date on the selected BOMs to the obsolete date of the revision just prior to the newly added automatic revision.</p> <p>Example: The value in the Eff Date field is unchanged; the field value in the Obs Date field is 06/14/03 (one day before new revision is active).</p>

Change Obsolete Date to	None	Scheduled Date	Prior Date
When Effective Date = Schd Date	<p>Creates new automatic revision.</p> <p>The system changes the effective date of the BOM.</p> <p>Example: The value in the Eff Date field is <i>06/15/03</i>. (This is the start date of new revision.) The obsolete date is unchanged.</p>	<p>Creates new automatic revision.</p> <p>The system changes the BOM effective date to the Mass Maintenance Code process run date.</p> <p>The system changes the obsolete date on the selected BOMs to the obsolete date of the new revision.</p> <p>Example: The value of the <i>Eff Date</i> field is <i>06/15/03</i>. (This is the start date of new revision.) The value in the Obs Date field is <i>12/31/2099</i>.</p>	<p>This combination is not allowed, because it would cause the effective date of the component to be after the due date. You must select another combination.</p>

As you can see from this table, with the exception of the schedule date and prior date combination, all scenarios are valid and lead to the automatic generation of revisions for revision control and automatic revision items.

This table lists items that have *not* been defined as using automatic revisions.

Change Obsolete Date to	None	Scheduled Date	Prior Date
When Effective Date = None	<p>There is no component effective date mass change.</p> <p>Example: Both of the dates in the Eff Date and Obs Date fields are unchanged.</p>	<p>The system changes the obsolete date on the selected BOMs to the Mass Maintenance Code process run date.</p> <p>Example: The value of the Eff Date field is unchanged; the value of the Obs Date field is <i>06/15/03</i>.</p>	<p>The system changes the obsolete date on the selected BOMs to the date prior to the Mass Maintenance Code process run date.</p> <p>Example: The value in the Eff Date field is unchanged; the value in the Obs Date field is <i>06/14/03</i>.</p>
When Effective Date = Schd Date	<p>The system changes the BOM effective date to the Mass Maintenance Code process run date.</p> <p>Example: The value in the Eff Date field is <i>06/15/00</i>; the value in the Obs Date field is unchanged.</p>	<p>The system changes the BOM effective date and the obsolete date to the Mass Maintenance Code process run date.</p> <p>Example: The Eff Date field is <i>06/15/00</i>; the value in the Obs Date field is <i>06/15/00</i>.</p>	<p>This combination is not allowed. You must select another combination.</p>

Change - Dimensions Page

Use the Change - Dimensions page (EN_BOM_MMC_DIM2_SP) to make mass changes to component dimensions.

Navigation:

Manufacturing Definitions > BOMs and Revisions > BOM Mass Changes > BOM Mass Maintenance Codes > Change

Click the **Dimensions** link.

Enter the existing dimension on the Component Dimensions - Search page (optional), and then enter a new value on the Component Dimensions - Change page. Both pages are accessed by clicking buttons on the appropriate page. Entering the existing dimension on the Component Dimensions - Search page is necessary only when it needs to be part of the search criteria. For example, to change the weight for all occurrences of component LT5000 to 10, enter 10 on the Change page. If it should be changed only where its current weight is 9, then enter 9 on the Search page and 10 on the Change page.

Change - Reference Designators Page

Use the Change - Reference Designators page (EN_BOM_MMC_REF2_SP) to make mass changes to reference designators.

Navigation:

Manufacturing Definitions > BOMs and Revisions > BOM Mass Changes > BOM Mass Maintenance Codes > Change

Click the **Ref Desigs** link.

To add, change, or delete reference designators, specify the reference designators on the Reference Designators - Search page only if it needs to be part of the search criteria.

Otherwise, use the Reference Designators - Change page to specify an **Action** of *Add*, *Change*, or *Delete*. When adding, specify only the new reference designator; when deleting, specify only the reference designator to be deleted; and when changing, specify the current and new reference designators.

Change - Substitutes Page

Use the Change - Substitutes page (EN_BOM_MMC_SUB2_SP) to mass change a substitute everywhere it's used.

Navigation:

Manufacturing Definitions > BOMs and Revisions > BOM Mass Changes > BOM Mass Maintenance Codes > Change

Click the **Substitutes** link.

This example illustrates the fields and controls on the Component Substitutes - Change page. You can find definitions for the fields and controls later on this page.

Component Substitutes - Change [Help](#)

Change Substitutes

Unit **US008** Mass Maint Code **MMC0000003** Mass Maint Seq **10**

Substitute Items Find | View All First 1 of 1 Last

*Action Add + -

Current Values

Substitute Item ID

Priority Conversion Rate

From Date To Date

New Values

New Substitute Item Pedal, Clipless

New Priority New Rate

New From Date New To Date

Field or Control	Description
Action	<p>Select one of these values:</p> <ul style="list-style-type: none"> • <i>Add</i> • <i>Change</i> • <i>Delete</i> <p>Adding, changing, and deleting component substitutes works in a similar fashion as the reference designators, except that you have more information to maintain.</p> <p>If adding a new substitute, specify all the required new values.</p> <p>If deleting a substitute, specify as many of the current values as necessary to perform the delete. If you are changing substitute information, enter the current and new values.</p> <p>For example, to delete all occurrences of LT5001 as a substitute, then enter only LT5001 as the substitute item. To delete only the substitute LT5001, if it has priority 1, then enter LT5001 as the substitute item and 1 as the priority.</p>

Current Values

Field or Control	Description
Substitute Item ID	This is the current default value that comes from the business unit.
Priority, Conversion Rate, From Date, and To Date	<p>If deleting a substitute, specify as many of the current values to perform the deletion.</p> <p>For example, to delete all occurrences of LT5001 as a substitute, then only enter LT5001 as the substitute item ID.</p> <p>If you only want to delete the substitute LT5001 if it has priority 1, then enter <i>LT5001</i> as the substitute item ID and <i>1</i> as the priority.</p> <p>If changing substitute information, enter the current values.</p>

New Values

Field or Control	Description
New Substitute Item	<p>Enter the value for the new substitute component.</p> <p>If you're adding a new substitute, you must specify all of the required new values.</p>
New Priority, New From Date, New To Date, New (conversion), and Rate	<p>If you want to change the parameters of the new substitute item, enter values where applicable. Otherwise, any values that you don't specify here for the new substitute item priority, effective dates, and conversion rate remain unchanged on the BOM.</p> <p>You can also change the parameters for the original item here. Enter only the fields that you want to change.</p>

Add Page

Use the Add page (EN_BOM_MMC_ADD) to add components or outputs to assemblies.

The system adds these components or outputs to each BOM identified by the values that you entered on the Search page. Use the Process BOM Mass Maintenance pages to designate, at a later time, the specific assemblies to be affected by these changes.

Navigation:

Manufacturing Definitions > BOMs and Revisions > BOM Mass Changes > BOM Mass Maintenance Codes > Add

This example illustrates the fields and controls on the BOM Mass Maintenance Code - Add page. You can find definitions for the fields and controls later on this page.

Note: Automatic revision operates only for those items that are defined as using automatic revisions with the Define Business Unit Item - Manufacturing: General page.

Field or Control	Description
Component ID	<p>Enter a component if you selected <i>Component</i> as the sequence type on the BOM Mass Maintenance Code - Search page.</p> <p>Enter associated values that you want to add to the selected BOMs that meet the search criteria specified with the Component Search page.</p> <p>You can add multiple components per Mass Maint Seq (mass maintenance sequence) code.</p> <p>You can also add a placeholder item as a component. If the MMC is later applied to manufacturing BOMs that don't allow placeholders, the process indicates that BOM change as an exception, and the BOM won't be changed.</p>
Output Item and Output Type	<p>If you selected a <i>Output</i> as the sequence type on the BOM Mass Maintenance - Search page, you must enter values and any additional required output data.</p>

Note: The values that you select on these pages are subject to the same validation checks that apply to any MBOM component or output value. Some of these checks occur when you create the mass maintenance code, and the remaining validation checks occur when the MMC is applied.

Related Links

[Change Page](#)

Add - Substitutes Page

Use the Add - Substitutes page (EN_BOM_MMC_SUB3_SP) to add a substitute everywhere it's required.

Navigation:

Manufacturing Definitions > BOMs and Revisions > BOM Mass Changes > BOM Mass Maintenance Codes > Add

Click the **Substitutes** link.

This example illustrates the fields and controls on the Component Substitutes - Add page. You can find definitions for the fields and controls later on this page.

<i>Field or Control</i>	<i>Description</i>
	Click the Copy Substitute Push button to display all valid substitute items for the business unit.

To add all valid substitute items for the business unit, click **OK**.

If you don't want to add all valid substitute items for the business unit, enter each individual substitute item that you want to add. In addition, enter the priority, from date, to date, and conversion rate for each substitute.

Note: Substitute items must be unique for the item. You can't enter the same item twice as a substitute with different dates. For example, substitute A with effective dates from 01/01/99 to 02/01/99 and substitute A with effective dates from 02/01/00 to 08/30/00 couldn't be substitutes for the same item. In this case, define a different substitute for the second set of effective dates.

Example: Mass BOM Changes

To better understand how you can use these three pages to effect desired mass change, let's look at an example.

To make a component obsolete on several BOMs and introduce another component in its place:

1. Create an MMC code by entering the search criteria (with the Search page) that identifies the component you want to make obsolete.

Then, on the Change page, specify the date that the component is to become obsolete (or select an effective date or obsolete date value).

2. Add the new component information on the Add page.

This includes required information such as the operation sequence and effective date for the new component.

3. If the new component requires dimension/reference designator/substitute information, add the information (with the **reference designator/reference designator/substitute** button), as required.
4. Run the Process BOM Mass Maint by MMC page.

Making BOM Mass Changes and Creating Automatic Revisions

You can make BOM mass changes and create automatic revisions using MMCs.

To create automatic revisions using the mass maintenance by the Mass Maintenance Codes process:

1. Define the MMC using the BOM Mass Maintenance component.
2. Run the Mass Maintenance by MMC process.

The system creates a new revision effective on the Mass Maintenance by MMC process run date.

Pages Used to Make Mass Changes Using Mass Maintenance Codes

<i>Page Name</i>	<i>Definition Name</i>	<i>Usage</i>
Mass Maint Code Options	EN_MASSMNT_REQ2	Define the MMC options for the BOM Mass Maintenance COBOL SQL process (ENPMMAIN).
Assembly Item Options	EN_MASSMNT_REQ3	Select the items to which the BOM Mass Maintenance process will be applied.
Select Assemblies by Items Where Used	EG_BOM_WHEREUSE_SP	Quickly populate affected assemblies into the primary page.
Select Assemblies by Items Where Used: Enter Dimensions	EN_BOM_DIM_SP	Specify the dimensions of the component.
Select Assemblies by Items Where Used - Reference Designators	EG_BOM_WU_REF_SP	Specify the reference designator of the component.

Page Name	Definition Name	Usage
Mass Maint Except	EN_MMC_TRN_STAT	View the reasons that BOMs weren't changed by the BOM Mass Maintenance process.

Mass Maint Code Options Page

Use the Mass Maint Code Options page (EN_MASSMNT_REQ2) to define the MMC options for the BOM Mass Maintenance COBOL SQL process (ENPMMAIN).

Navigation:

Manufacturing Definitions > BOMs and Revisions > BOM Mass Changes > Apply BOM Mass Changes by MMC > Mass Maint Code Options

This example illustrates the fields and controls on the Mass Maint Code Options page. You can find definitions for the fields and controls later on this page.

Field or Control	Description
Unit and Mass Maintenance Code	<p>Enter values to apply to a range or list of assemblies.</p> <p>If the MMC has been set to include automatic revisions, then the system automatically creates revisions. Revisions are effective as of the run date of this process or the date that you enter in the Auto Revision Effective Date field.</p> <hr/> <p>Note: Only items that have been defined as revision-controlled with automatic revisions and also set up to use auto revisions (with the BOM Mass Maintenance - Search page) will be auto-revision incremented.</p>

Field or Control	Description
Auto Revision Effective Date	<p>Enter the effective date to be used by all new auto-revisions that are created in this process run. If this field is left blank, then today's date is used as the new revision effective date. Keep in mind that all revisions within one process run will use the same date.</p> <p>If the date entered in this field provides a date that is earlier than an existing revision, then the revision will be given an obsolete date. Obsolete dates are based on the effectivity of the next revision. However, the most effective way to tie component obsolescence and new component effectivity to auto-revisions is to take advantage of the <i>Schedule Date</i> or <i>Prior Date</i> options offered on the Change page or the Add page of the BOM Mass Maintenance Codes component. This will eliminate possible errors caused by user-entered dates that do not correspond with the effective date selected for the new revisions.</p>
Update Options	<p>Select an update option. Values are:</p> <ul style="list-style-type: none"> • <i>Validate and Update</i>: Validates and updates the BOMs, depending on the update option based on: • <i>Only if all BOMs are valid</i> • <i>Any valid BOMs</i> • <i>Validate Only</i>: Validates any valid BOMs. <p>You can select <i>Validate Only</i> on the Mass Maintenance Exceptions page to determine whether there are any validation problems with the BOMs. You can then make any necessary corrections, before you actually update the BOMs.</p> <hr/> <p>Note: When running Mass Maintenance by ECO to create new revisions only, you must run the process using the <i>Validate and Update</i> value to create new revision numbers.</p>
Staged BOM Data Option	<p>Select an option to determine what should be done with the data that was used during the Mass Maintenance process:</p> <ul style="list-style-type: none"> • <i>Delete Stage Results</i>: The system doesn't save any results of the Mass Maintenance process, and you cannot use the Mass Maintenance Staged BOMs component to view the changed BOMs or correct errors. • <i>Stage Results</i>: You can use the Mass Maintenance Staged BOMs component to see which BOMs were updated by the Mass Maintenance process, correct BOMs that returned an <i>error</i> status and resubmit the process.

<i>Field or Control</i>	<i>Description</i>
Report Only Mode	<p>Select to view the results of the Mass Maintenance process by using the Mass Maintenance Staged BOMs component.</p> <p>If you don't select Report Only Mode, you can use the Mass Maintenance Staged BOMs component to view the staged BOMs, update errors and submit corrected BOMs for reprocessing.</p>

Related Links

[Change Page](#)

Assembly Item Options Page

Use the Assembly Item Options page (EN_MASSMNT_REQ3) to select the items to which the BOM Mass Maintenance process will be applied.

Navigation:

Manufacturing Definitions > BOMs and Revisions > BOM Mass Changes > Apply BOM Mass Changes by MMC > Assembly Item Options

<i>Field or Control</i>	<i>Description</i>
Item Options	<p>Select an item option. Values are:</p> <ul style="list-style-type: none"> • Range: Also select the BOM type and BOM code. • List of Assembly Items
	<p>Click the Search button to search for items to add to the list of assembly items.</p>
Run	<p>Click to run this request. PeopleSoft Process Scheduler runs the BOM Mass Maintenance COBOL SQL process at user-defined intervals.</p>

See the product documentation for *PeopleTools: Process Scheduler*

Selecting Assemblies by Items Where Used Page

Use the Select Assemblies by Items Where Used page (EG_BOM_WHEREUSE_SP) to quickly populate affected assemblies into the primary page.

Navigation:

Manufacturing Definitions > BOMs and Revisions > BOM Mass Changes > Apply BOM Mass Changes by MMC > Assembly Item Options

Click the **Where Used** link.

This example illustrates the fields and controls on the Select Assemblies by Items Where Used page. You can find definitions for the fields and controls later on this page.

This page enables you to quickly populate affected assemblies into the primary page.

Field or Control	Description
Search	Values are: <ul style="list-style-type: none"> <i>Components Only</i>: System displays basic component information and all higher-level subassemblies or assemblies that contain the selected item. <i>Components and Substitutes</i>: System displays all higher-level subassemblies or assemblies that contain the selected item, including substitutes. <i>Outputs Only</i>: System displays basic output information, including output type, BOM Code, output quantity, and effectivity dates. <i>Substitutes Only</i>: System displays substitutes for the selected item.
Sel (select)	Select the check box for all the outputs that you would like to transfer to the main page.
Item ID, Op Seq (operation sequence), and BOM Code	Enter values for these fields.

Field or Control	Description
Search	Click this button to populate the page.
View	Select either <i>Indented</i> or <i>No-Indent</i> .
Sel (select)	Select this check box for all the components that you would like to transfer to the main page.
Comp Rev (component revision)	<p>This field appears if the component is revision controlled. If you enter a component revision, the Select Assemblies by Items Where Used page returns all assemblies where that component is an exact match or where the current revision is used.</p> <p>If you leave the field blank, the system returns assemblies that use any revision of the component.</p>

Validation Checks

All requested changes made with the Process BOM Mass Maintenance by MMC page are validated before any MBOM changes are made. The system checks the interaction of all components and outputs on the product structure: these same checks are made within the BOM maintenance pages.

Mass Maint Except Page

Use the Mass Maint Except page (EN_MMC_TRN_STAT) to view the reasons that BOMs weren't changed by the BOM Mass Maintenance process.

Navigation:

Manufacturing Definitions > BOMs and Revisions > BOM Mass Changes > Mass Maintenance Exceptions > Mass Maint Except

“

This example illustrates the fields and controls on the Mass Maintenance Exceptions - Mass Maintenance Except page. You can find definitions for the fields and controls later on this page.

Use this page to review the mass maintenance exceptions.

Click the **Count** button to view the number of exceptions.

After you've reviewed the exceptions and made any needed changes to the BOMs or mass maintenance data, you can then re-run the Mass Maintenance process.

Viewing and Correcting Mass Maintenance Staged BOMs

As part of the Mass Maintenance process, you can correct BOM messages with data errors using the Staged BOMs pages. You can view each BOM message and correct the errors using these pages. You can then change the status to *reprocess* and submit the BOM for reprocessing immediately or use the Process Staged BOMs process to reprocess a range of BOMs.

This section discusses how to view and Correct Mass Maintenance Staged BOMs

Pages Used to View and Correct Mass Maintenance Staged BOMs

Page Name	Definition Name	Usage
Update Staged BOM Details - BOM Status Page	EN_TRN_BOM_STAT	View, and possibly update, the results from a BOM Mass Maintenance process. You must have run BOM Mass Maintenance with <i>Stage Result</i> as the value of the Staged BOM Data Options field.
Update Staged BOM Details - Summary Page	EN_TRN_BOM_HDR	View and update the results from a BOM Mass Maintenance process.
Update Staged BOM Details - Header: Assembly Text Page	EN_TRN_BOM_TEXT	View and update the results from a BOM Mass Maintenance process. Update Staged BOM Details - Header: Outputs Page
Update Staged BOM Details - Header: Outputs Page	EN_TRN_BOM_OUT	View and update the results from a BOM Mass Maintenance process.
Update Staged BOM Details - Components: Component Details	EN_TRN_BOM_CMP	View and update the results from a BOM Mass Maintenance process. Update Staged BOM Details - Header: Outputs Page
Update Staged BOM Details - Components: Reference Designators Page	EN_TRN_BOM_CMPDESG	View and update the results from a BOM Mass Maintenance process.

Page Name	Definition Name	Usage
Update Staged BOM Details - Components: Dimensions Page	EN_TRN_BOM_CMPDIM	View and update the results from a BOM Mass Maintenance process.
Update Staged BOM Details - Components: Substitutes Page	EN_TRN_BOM_SUB	View and update the results from a BOM Mass Maintenance process.

Update Staged BOM Details - BOM Status Page

Use the Update Staged BOM Details - BOM Status page (EN_TRN_BOM_STAT) to view, and possibly update, the results from a BOM Mass Maintenance process.

Navigation:

Manufacturing Definitions > BOMs and Revisions > BOM Mass Changes > Update Staged BOM Details > BOM Status

This example illustrates the fields and controls on the Update Staged BOM Details - BOM Status page. You can find definitions for the fields and controls later on this page.

Field or Control	Description
BOM State	The value that appears is <i>Manufacturing</i> . The BOM state must be valid or the system considers the message an error.
BOM Code	Enables you to assign a primary and up to 98 alternate BOMs. There must be a BOM code or the system considers the message an error.

Field or Control	Description
Status	<p>Indicates the eligibility of this BOM for further processing. You can receive BOM error messages with any of these statuses:</p> <ul style="list-style-type: none"> • <i>Complete</i>: You can't update the staged results for this BOM in Data Definition Maintenance, because the BOM has already been updated in the system. You can only view the BOM when it's in this status. You cannot modify it. • <i>Error</i>: There is at least one data validation error in the staged results for this BOM. You can change to <i>Cancelled</i> or <i>Reprocess</i>. • <i>In Process</i>: When processing of a transaction is initiated, the status of the transaction record is set to <i>In Process</i>. • <i>Incomplete</i>: An Incomplete transaction is a transaction that's still being created by the transaction pages. The status changes to new when the transaction is ready to be processed by the background processes. The system won't process an incomplete transaction. • <i>New</i>: The staged results are valid, but the original BOM hasn't been updated yet. The BOM is eligible for update and reprocessing. You can change it to <i>Cancelled</i> or <i>Reprocess</i>. • <i>Reprocess</i>: When you correct errors using the Transaction Maintenance Detail pages, you can change the BOM status to <i>Reprocess</i>.
BOM Type	<p>Displays the BOM type. Values are <i>Production</i> or <i>Rework</i>. Production BOMs are used as the basis for manufacturing assemblies. Use rework BOMs when you have a standard rework process where you include additional components to repair BOMs. The BOM type must be valid or the system considers the message an error.</p>

If you are correcting multiple messages, you can manually change the error status of each message to *Reprocess* after you've corrected the data. Then run the BOM Loader process to reprocess the data for multiple messages. The system changes reprocess and new messages to the *complete* status after confirming that there are no errors in the message.

To correct a single message, select the **Reprocess** check box, to set the message status to *Reprocess*, and click **OK** or **Apply** to initiate the validation background process.

Messages

In the **Messages** group box, the system displays the error message and the result of the message.

This page lists all of the errors and warnings for the BOM, whether it's for the overall BOM, for a specific component, or for output. The **Result** column indicates the severity of the message: *W* indicates a warning and doesn't stop the BOM from being valid, and *E* indicates an error and must be fixed for the BOM to be valid.

Related Links

[Processing Staged BOMs](#)

Update Staged BOM Details - Summary Page

Use the Update Staged BOM Details - Summary page (EN_TRN_BOM_HDR) to view and update the results from a BOM Mass Maintenance process.

Navigation:

Manufacturing Definitions > BOMs and Revisions > BOM Mass Changes > Update Staged BOM Details > Summary

This example illustrates the fields and controls on the The Update Staged BOM Details - Summary page. You can find definitions for the fields and controls later on this page.

BOM Status		Summary		Header		Components	
Unit:	US008	Process Instance:	9629	Source Cd:	Make	BOM Result: No Errors	
Item ID:	MT2000	Professional Road Bike, Womans		BOM State:	Manufacturing	BOM Code:	1
BOM State:	Manufacturing	BOM Code:	1	Serial Control:	N	Status:	New
BOM Type:	Production	BOM Qty:	1	Std UOM:	EA	Reprocess:	<input type="checkbox"/>

*Component ID	Description	Comp Rev	Op Seq	*Eff Date	*Obs Date	Quantity	Std UOM	*Per		
FR7002	Bike Frame, Aluminium		10	01/01/1985	12/31/2095	1.0000	EA	A	+	-
FR7005	Front Fork	BB	10	01/01/1985	12/31/2095	1.0000	EA	A	+	-
FR7012	Primer Paint		40	01/01/1985	12/31/2095	0.5000	GAL	A	+	-
FS3000	Bolt		10	01/01/1985	12/31/2095	10.0000	EA	A	+	-
FS3001	Washer		10	01/01/1985	12/31/2095	10.0000	EA	A	+	-

Field or Control	Description
Component ID , Comp Rev (component revision), Op Seq (operation sequence), Eff Date (effective date), Obs Date (obsolete date), Quantity , and Per	You can change values for these fields.

Related Links

[Manufacturing BOMs - Summary Page](#)

Update Staged BOM Details - Header: Outputs Page

Use the Update Staged BOM Details - Header: Outputs page (EN_TRN_BOM_OUT) to view and update the results from a BOM Mass Maintenance process.

Navigation:

Manufacturing Definitions > BOMs and Revisions > BOM Mass Changes > Update Staged BOM Details > Header > Outputs

This example illustrates the fields and controls on the The Update Staged BOM Details - Header: Outputs page. You can find definitions for the fields and controls later on this page.

Output Summary Tab

For each output, you can change the output type, output item, operation sequence, effective dates, and output quantity.

Attributes Tab

You can change the resource allocation percentage and cost allocation percentage.

Related Links

[Header: Outputs Page](#)

Processing Staged BOMs

After you've viewed and corrected the staged BOMs, run the Process Staged BOMs Application Engine process (EN_BOM_MSG) to reprocess the BOMs.

Page Used to Process Staged BOMs

<i>Page Name</i>	<i>Definition Name</i>	<i>Usage</i>
Process Staged BOMs Page	EN_RUN_BOMSTAGE	Reprocess corrected staged BOMs using the Process Staged BOMs process.

Process Staged BOMs Page

Use the Process Staged BOMs page (EN_RUN_BOMSTAGE) to reprocess corrected staged BOMs using the Process Staged BOMs process.

Navigation:

Manufacturing Definitions > BOMs and Revisions > BOM Mass Changes > Process Staged BOMs

This example illustrates the fields and controls on the The Process Staged BOMs process page . You can find definitions for the fields and controls later on this page.

Field or Control	Description
Update Options	Select an update option. Values are: <ul style="list-style-type: none"> • <i>Validate Only</i>: Validates the data but doesn't load or change BOM tables. • <i>Validate and Transfer</i>: Validates the data and loads and changes BOM tables.
Re-process any Errors	If you are processing a large number of BOMs, you can correct the errors in the BOM pages but leave the status as <i>Error</i> . You then select this check box while running the BOM Loader process, and the system reprocesses transactions with the statuses of <i>New</i> , <i>Reprocess</i> , and <i>Error</i> . If this check box is deselected, only transactions with statuses of <i>New</i> and <i>Reprocess</i> are processed. This option is only applicable when you select <i>Validate Only</i> or <i>Validate and Transfer</i> .

Field or Control	Description
Purge Stage and Error Records	<p>Select this check box to delete the error transactions from the staging table once you have run this process.</p> <ul style="list-style-type: none"> • If you select <i>Validate and Transfer</i> and Purge Stage and Error Records, the BOMs will first be validated and then transferred to the BOM tables. <p>If any of the BOMs were invalid, the BOM tables won't be updated, but they will be deleted from the stage and error records.</p> <ul style="list-style-type: none"> • If you select <i>None</i> and Purge Stage and Error Records, the BOMs won't be validated or changed. <p>The stage and error records will be purged. This combination can be used to clean up after you have completed processing BOMs.</p>
Run	Click to run this request. PeopleSoft Process Scheduler runs the Staged BOMs process at user-defined intervals.

See the product documentation for *PeopleTools: Process Scheduler*

Displaying Bills of Material

Understanding Display of BOMs

PeopleSoft Manufacturing provides several inquiries for BOMs.

Common Elements Used in Display of Bills of Material

<i>Field or Control</i>	<i>Description</i>
BOM State	Appears by default as <i>Manufacturing</i> and is display-only.
BOM Type	<p>Select a BOM type. Values are:</p> <ul style="list-style-type: none"> <i>Production</i>: This is the default BOM type. Manufacturing BOMs can be used for standard manufacturing processes. <i>Rework</i>: Create rework BOMs when you have a standard kit of components used in rework or repair.
View	<p>You can view summary data with these options:</p> <ul style="list-style-type: none"> Indented with Dates Indented with Revs (indented with revisions) Non-Indented with Dates Non-Indented with Revs <p>The indented options provide an indented (tree) BOM structure for the selected depth.</p>
All Dates/Revs	Select this check box to search all effective dates and revisions for the item's BOM.
Eff Date (effective date) and Obs Date (obsolete date)	The beginning and ending dates for the BOM. When entering selection criteria for BOMs, use the Eff Date field for items without revisions or to further specify the effective date for a BOM for a specified revision.

Displaying BOM Structures

This section discusses how to display BOM Structures:

Pages Used to Display BOM Structures

Page Name	Definition Name	Usage
Manufacturing BOMs - Summary	EN_BOM_INQUIRY	View BOM component structure at a summary or general level, including the indented BOM structure.
Output List	EN_BOM_LIST_OUT_SP	View primary, co-products, and by-products produced from this BOM.
Component Substitutes	EN_BOM_INQ_SUB	View BOM component substitute items.
Assembly Text	EN_BOM_INQ_HEADER	View BOM assembly text.
Assembly Attachments	EN_BOM_INQ_ATT	View BOM assembly attachments.
Assembly Documents	EN_BOM_INQ_DC	Display BOM assembly documents. You must have PeopleSoft Engineering installed to access this page.
Header - Outputs	EN_BOM_INQ_OUTS	Display BOM assembly outputs.
Components - Component Details	EN_BOM_INQUIRY_D	Display BOM component detail such as effectivity dates, quantities, yield, and unit of measure (UOM).
Text	EN_BOM_INQ_D_TXT	Display BOM component text.
Attachments	EN_BOM_INQ_CATT	Display BOM component attachments.
Documents	EN_BOM_INQ_CDC	Display BOM component documents. You must have PeopleSoft Engineering installed to access this page.
Reference Designators	EN_BOM_INQ_REF	Display BOM component reference designators.
Dimensions	EN_BOM_INQ_CDIM	Display BOM component dimensions.

Page Name	Definition Name	Usage
BOM Report	EN_BOM_REPORT	Generate manufacturing BOM reports.

Manufacturing BOMs - Summary Page

Use the Manufacturing BOMs - Summary page (EN_BOM_INQUIRY) to view BOM component structure at a summary or general level, including the indented BOM structure.

Navigation:

Manufacturing Definitions > BOMs and Revisions > Review BOM Information > Manufacturing BOMs > Summary

This example illustrates the fields and controls on the Manufacturing BOMs - Summary inquiry page. You can find definitions for the fields and controls later on this page.

Lvl	Component ID	Description	Op Seq	Eff Date	Obs Date	Eff Rev	Obs Rev	Quantity	Std UOM	Source Cd
1	GR8000	Gear, Sugishita	50	01/01/1985	12/31/2099	A	---	1.0000	EA	Buy
1	GR8002	Chain, Sugishita	50	01/01/1985	12/31/2099	A	---	1.0000	EA	Buy
1	GR8007	Derailleurs, Sugishita	40	01/01/1985	12/31/2099	A	---	1.0000	EA	Buy
1	GR8012	Cassette LX145 8 Speed	30	01/01/1985	12/31/2099	A	---	1.0000	EA	Buy
1	GR8200	Axle Carrier	10	01/01/1985	12/31/2099	A	---	1.0000	EA	Buy

Field or Control	Description
Unit, Item ID, BOM Type, BOM Code, Eff Date (effective date), Revision	Enter the basic information about the BOM.
Depth	Enter the number of levels that you want to view by specifying the depth. If you select a depth of 1, this page displays only the top level of the BOM.

Note: You can select any valid BOM code. However, the system always calculates lower levels based on the primary BOM code 1, regardless of the depth that you enter.

After you make the selections, click the **Search** button to view the data. The system sorts the summary in this sequence:

1. Assembly

2. Subassembly
3. Component
4. Operation sequence
5. Effective date

Note: If you specify a component revision during BOM maintenance, the component revision appears on the Summary tab. If the component is revision-controlled, but the field is left blank because this is the current revision, this inquiry displays the revision code that's current for the component, based on the top-level effective date or revision that you entered.

Click a link in the **Component ID** column to access component details.

Attributes Tab

<i>Field or Control</i>	<i>Description</i>
Outputs	Click this link to view the Outputs for lower-level items (if it is a multiple output BOM).
Substitutes	Click this link to view substitute data.

Component Substitutes Page

Use the Component Substitutes page (EN_BOM_INQ_SUB) to view BOM component substitute items.

Navigation:



- **Manufacturing Definitions > BOMs and Revisions > Review BOM Information > Manufacturing BOMs > Summary**

Click the **Substitutes** link under the Attributes tab.

- **Manufacturing Definitions > BOMs and Revisions > Review BOM Information > BOM Summarized**

Click the **Substitutes** link.

This example illustrates the fields and controls on the Component Substitutes inquiry page. You can find definitions for the fields and controls later on this page.

Component Substitutes						
Item	SR2001	Gear Subassembly	Std UOM	EA		
Component ID	GR8000	Gear, Sugishita	Std UOM	EA	Pos Nbr	0
Op Seq	50	Eff Date	01/01/1985	Obs Date	12/31/2099	
Eff Rev	A	Obs Rev	---			
Substitute Items						
			Personalize Find View All  	First	1 of 1	Last
Priority	Substitute Item ID	Description	From Date	To Date	Conversion Rate	Std UOM
1	GR8001	Gear, Campani	01/01/2000	12/31/2099	1.00000000	EA

Substitutes and related data such as **Conversion Rate** and effectivity dates appear in order of priority.



Header - Outputs Page

Use the Header - Outputs page (EN_BOM_INQ_OUTS) to display BOM assembly outputs.

Navigation:

Manufacturing Definitions > BOMs and Revisions > Review BOM Information > Manufacturing BOMs > Header > Outputs

This example illustrates the fields and controls on the Header - Outputs page. You can find definitions for the fields and controls later on this page.

Summary Header Components							
Assembly Text		Assembly Attachments		Assembly Documents		Outputs	
Unit:	US008	Item ID:	SR2001 	Gear Subassembly			
BOM Type:	Production	BOM Code:	1	Source Code:	Make		
Revision:	A	<input type="checkbox"/> All Dates/Revs	BOM Qty:	1	Std UOM:	EA	
Eff Date:	08/07/2009						
Depth:	1						
Outputs							
Output Type	Output Item	Description	Op Seq	Eff Date	Obs Date	Output Qty	Std UOM
Primary	SR2001	Gear Subassembly	0	01/01/1900	12/31/2099	1.0000	EA
 Notify							
Summary Header Components							

The values in the header data (for the **Unit**, **Item ID**, **BOM Type**, **BOM Code** and **Eff Date** or **Revision**, **Depth** fields) are defaults values from the Summary page.

Note: Regardless of the depth that you entered, only outputs for the top-level item appear on this page. You can, however, use the Manufacturing BOMs inquiry - Summary: Summary: Attributes page to view lower level outputs. You do this by clicking the **Outputs** link. This link appears only if the component has multiple outputs on its BOM.

The system only explodes primary co-products for the BOM code that you specified. You cannot enter a co-product and see it exploded downward. Rather, you must enter the primary to which that co-product is associated to view the co-product details.

Related Links

[Header: Outputs Page](#)

Components - Component Details Page

Use the Components - Component Details page (EN_BOM_INQUIRY_D) to display BOM component detail such as effectivity dates, quantities, yield, and unit of measure (UOM).

Navigation:

Manufacturing Definitions > BOMs and Revisions > Review BOM Information > Manufacturing BOMs > Components > Component Details

This example illustrates the fields and controls on the Components - Component Details page. You can find definitions for the fields and controls later on this page.

The values in the header data, for the item, BOM type, BOM code, revision, and effective date are default values from the Summary page.

Standard component data for the component revision, operation sequence, yield, subcontracted supply, teardown, and effectivity dates also appear.

Displaying Summarized BOMs

This section discusses how to display Summarized BOMs:

Pages Used to Display Summarized BOMs

<i>Page Name</i>	<i>Definition Name</i>	<i>Usage</i>
BOM Summarized	EN_BOM_SUMMARY	View, at all levels, all components that comprise an assembly's product or rework structure. This page enables you to view the quantity of components for an assembly regardless of level. Use it to determine component requirements, at all levels, based on a specific assembly demand quantity.
Component Substitutes	EN_BOM_INQ_SUB	View BOM component substitute items.
BOM Summarized Outputs	EN_BOM_SUMM_OUTS	Display BOM summarized outputs.

BOM Summarized Page

Use the BOM Summarized page (EN_BOM_SUMMARY) to view, at all levels, all components that comprise an assembly's product or rework structure.

This page enables you to view the quantity of components for an assembly regardless of level. Use it to determine component requirements, at all levels, based on a specific assembly demand quantity.

Navigation:

Manufacturing Definitions > BOMs and Revisions > Review BOM Information > BOM Summarized

This example illustrates the fields and controls on the BOM Summarized inquiry page. You can find definitions for the fields and controls later on this page.

BOM Summarized
BOM Summarized_Outputs

*Unit

*Item ID Professional Road Bike, Womens

*BOM Type *BOM Code

Revision Std UOM Source Code

Eff Date Depth BOM Qty

Required Qty Assembly Starts Qty Routing Code

View

Chunk Size

1 to 13 of 13

Components								Personalize Find
Lvl	Component ID	Description	Op Seq	Quantity	Std UOM	Per	Qty Required	Qty Available
1	FR7002	Bike Frame, Aluminium	10	1.0000	EA	Asy	1.0000	10.0000
1	FR7005	Front Fork	10	1.0000	EA	Asy	1.0000	675.0000
1	FR7012	Primer Paint	40	0.5000	GAL	Asy	1.0000	0.0000
1	FS3000	Bolt	10	10.0000	EA	Asy	10.0000	2193.0000
1	FS3001	Washer	10	10.0000	EA	Asy	10.0000	3013.0000
1	FS3002	Nut	10	10.0000	EA	Asy	10.0000	57744.0000

<i>Field or Control</i>	<i>Description</i>
Unit, Item ID, BOM Type, BOM Code, Eff Date (effective date), and Revision	Select information to specify the BOM.
Search	Click to display the summarized BOM.
Required Qty (required quantity)	<p>Enter this value for the assembly item to determine the total number of each component required, at all levels, to produce a specific quantity of the assembly item. The system multiplies each component's quantity per assembly by this value to determine the component required quantity that appears in the lower portion of the page.</p> <p>Click the Search button again to display the calculated required quantities.</p> <hr/> <p>Note: To view a summarized BOM, enter a Required Qty of <i>I</i>.</p>

Field or Control	Description
Depth	<p>If you select a depth of <i>1</i>, this page displays only the top level of the BOM.</p> <p>If you select the <i>Rework</i> as the BOM type and <i>1</i>, as the depth, the system displays only rework BOMs. If you select a depth greater than <i>1</i>, the system displays rework BOMs for the first level and manufacturing BOMs for all lower levels.</p> <hr/> <p>Note: You can select any valid BOM code, but regardless of the depth that you enter, the system calculates all lower levels based on the primary BOM code (1).</p> <hr/>
Routing Code	Select the appropriate routing for the item.
Assembly Starts Qty	Displays the beginning quantity required based on the required quantity. This amount accounts for any operation yield loss during the production process.
Summary	Lists only the Component ID , Description , and Qty Required fields and summarizes the total required quantity for the component across all levels. The quantity required includes the amount needed to offset both component yield and operation yield losses. The current quantity available from business items attributes also appears.
Detail	Click to display data for all fields and to use the indented View field.

The system sorts the summary alphanumerically by component ID for level 1 items and summarizes the displayed data by quantity, regardless of where the component occurs in the product structure.

Note: If substitute items or multiple outputs exist for a component, those links appear following the **Qty Available** field.

If there are outputs associated with any of the components, an **Outputs** link appears. Click an **Output** link to access the Output Item Details page.

BOM Summarized Outputs Page

Use the BOM Summarized Outputs page (EN_BOM_SUMM_OUTS) to display BOM summarized outputs.

Navigation:

Manufacturing Definitions > BOMs and Revisions > Review BOM Information > BOM Summarized > BOM Summarized Outputs

This example illustrates the fields and controls on the BOM Summarized Outputs inquiry page. You can find definitions for the fields and controls later on this page.

BOM Summarized		BOM Summarized Outputs	
Unit	US008		
Item ID	MT2000	Professional Road Bike, Womans	
BOM Type	Production	BOM Code	1 Source Code Make
Revision	A	Std UOM	EA BOM Qty 1
Eff Date	01/07/2014	Depth	1
Required Qty	1.0000		
Outputs			
Output Type	Output Item	Description	Op Seq
Primary	MT2000	Professional Road Bike, Womans	0
Output Qty	Expected Output Quantity	Std UOM	Per
1.0000	1.0000	EA	Asy

Note: The system only explodes primary co-products for the BOM Code specified. Only outputs at the top level are displayed, regardless of the Depth entered.

Field or Control	Description
Expected Output Qty	Represents the anticipated output of each primary, co-product, recycle and waste product, based on the required quantity you enter. This is calculated as follows: ((Required Qty / BOM Qty) × Output Quantity).

Displaying BOM Costs

To create cost versions, use the Cost Versions component.

See “Understanding the Manufacturing Standard Cost Foundation” (PeopleSoft Cost Management).

This section provides an overview of how costs are determined for a BOM

Pages Used to Display BOM Costs

Page Name	Definition Name	Usage
Costed BOM	EN_BOM_INQ_COSTED	Display costed summary manufacturing BOM data. You cannot view configured item costs using this page.
Output Costs	EN_BOMCOST_OUT_SP	Display, by output type, all lower-level costing details for each co-product based on the costing percentage split.
Detailed Item Costs	EN_ITEMCOST_OUT_SP	Display This Level Cost and Lower Level Costs by cost element for the selected item ID and output type.

Page Name	Definition Name	Usage
Component Detail Costs	EN_ITEMCOST_SP	Display the manufacturing BOM component details. You can display the Extended This Level Cost and Extended Lower Level Costs, by cost element, for the selected component item, cost type, and cost version.
BOM Costed Report	EN_BOM_COST_REPORT	Generate a hard-copy report that details associated manufacturing BOM costs.

Understanding BOM Costs

To determine the costing impact of BOM changes to an assembly, you can display the costs of an assembly, its components, and outputs by cost type and cost version. This is useful for determining the costing impact of manufacturing BOM changes on an assembly.

The Costed BOM page performs a mini cost roll-up on the assembly that you enter. It calculates the assembly's cost (including all outputs) by summarizing the cost of the components and outputs based on the BOM in effect on the date specified or for the revision specified. Routing costs are not recalculated.

Here is how the system performs the cost roll-up:

- It looks at the components and outputs in effect for the selected BOM code, based on the as of date, and it uses BOM code *I* for all lower levels.
- It includes the routing cost by using the existing This Level labor, machine, subcontracting, and overhead costs for the cost type and cost version based on the cost roll-up performed.
- It uses the existing This Level labor, machine, subcontracting, and overhead costs for the cost type and cost version.

The system uses a BOM code of 1 and a routing code of 1 by default, but you can override the BOM and routing codes. The roll-up uses the item's material costs for the cost type and version selected. Costs for each of the assembly item's components must exist for the cost type and cost version selected to calculate the costs correctly. Floor stock items are not included in the cost roll-up.

Note: Expensed and planning items are not included in the cost roll-up. No costs are required for expensed or planning items, because no quantity on hand is maintained in PeopleSoft Inventory.

You maintain cost types and versions within PeopleSoft Cost Management. Cost types enable you to perform costing simulations and what-if analyses and to calculate new standard costs prior to updating production costs. Cost versions are iterations of a particular cost calculation for a cost type. You can have multiple versions of costs for each cost type. Cost roll-ups for production items are calculated by cost type and cost version. You cannot display costed BOM information for rework BOMs.

Once you've performed the BOM cost roll-up using the selected cost type, cost version, BOM code, and routing code, you can use the inquiry to determine how the item's cost might be impacted by subsequent changes to the BOM.

Related Links

“Understanding the Manufacturing Standard Cost Foundation” (PeopleSoft Cost Management)

Costed BOM Page

Use the Costed BOM page (EN_BOM_INQ_COSTED) to display costed summary manufacturing BOM data.

You cannot view configured item costs using this page.

Navigation:

Manufacturing Definitions > BOMs and Revisions > Review BOM Information > Costed BOM

This example illustrates the fields and controls on the Costed BOM inquiry page. You can find definitions for the fields and controls later on this page.

Costed BOMs

*Unit

*Item ID Creamy Tomato Sauce Bottled, 28 oz.

*Cost Type Current *Cost Version

*BOM Code Routing Code

Eff Date

Initial Std Cost Load

BOM Qty 375 CS

Cost as Batch

View Output Costs Chunk Size 1 to 5 of 5

Components		Personalize Find <input type="button" value="Print"/> <input type="button" value="Refresh"/>						
First	1-5 of 5	Last						
Lvl	Type	Component ID	Description	Cost Req. Qty	Std UOM	Per	Extended Cost	
1	Component	00000000000020013	Creamy Tomato Sauce - Processed - Spice - Tomatoes - Cream	2.6666667	GAL	Order	2.1501	
1	Component	00000000000020025	Bottle, 28 oz.	12.0000000	EA	Order	0.4776	
1	Component	00000000000020028	Screwtop	12.0000000	EA	Order	0.0060	
1	Component	00000000000020029	Label - 28oz Creamy Tomato	12.0000000	EA	Order	0.0312	
1	Component	00000000000020030	Packing Box	1.0000000	EA	Order	0.0189	

Field or Control	Description
<p>Unit, Item ID, Cost Type, Cost Version, BOM Code, and Routing Code</p>	<p>Select the appropriate information for the BOM.</p> <hr/> <p>Note: The cost version that you select must be valid for the cost type that you selected. In addition, to correctly calculate total cost, costs for each of the assembly item's purchased components must exist for the cost type and cost version that you selected. This is accomplished by rolling up the cost type and cost version within PeopleSoft Cost Management.</p> <hr/> <p>You can select any valid BOM code, but regardless of the depth that you enter, the system calculates all lower levels based on the primary BOM code. As long as the BOM exists, you can enter a BOM code other than the one used for the latest cost type version where a roll-up was performed. In this case, the Output Costs page does not display any cost version cost details, because they do not exist (no roll-up was performed). In addition, if you enter a BOM code that does not exist for a cost version, the routing code is deselected and no This Level Costs are included in the calculations. The routing code must also be valid for the cost version, because it is used to calculate the This Level Costs for the inquiry.</p> <hr/> <p>Note: When the Routing Code prompt table does not display any routing codes or displays a routing code of 0, and a routing exists, either no routing exists for the assembly or no This Level Costs were generated for the BOM being costed.</p> <hr/>
	<p>Click the Item Search button to access the Item Search Criteria page and select a different item.</p>
<p>Eff Date (effective date) and Revision</p>	<p>Enter this information for the BOM that you want to view.</p>
<p>Cost as Batch</p>	<p>If the item is a single output item with a BOM quantity greater than 1, you can access this check box. Deselect the check box to cost the item in terms of the production of 1 unit of the end-item or select the check box to roll up all component costs and This Level Costs, based on the BOM quantity.</p> <p>If the item entered is a multiple output item, this check box is selected and is display only. In this case, the results rendered by the inquiry represent the total cost of the batch, and the required quantities and extended cost calculated are for the entire batch (based on the BOM quantity), as opposed to one unit of the batch.</p>
<p>Depth</p>	<p>Enter the number of levels for which you want to display BOM component-costed information.</p> <hr/> <p>Note: Select the maximum depth for revision-controlled BOMs.</p> <hr/>

Field or Control	Description
Required Qty (required quantity)	<p>Represents the required quantity (for each component) to build the item ID specified. This quantity depends on the Cost as Batch setting.</p> <p>If Cost as Batch is selected, it is the required quantity to build the batch. If it's not selected, then it's the required quantity to build one of the items. This field factors in assembly BOM quantity, component quantity per assembly or order, component yield, and operation yield.</p> <p>Even though they will have only a purchased cost associated with them, by-products also appear. If the by-product is a <i>recycle</i> by-product, then the cost is negative; if it's a <i>waste</i> by-product, then the cost is positive.</p> <p>If the item does not have a purchase cost, the cost is 0.</p>
Extended Cost	<p>Displays the component's cost for the cost type and version specified, multiplied by the required standard quantity UOM.</p>

Cost Calculation for a Revision-Controlled BOM

There are times when the same revision-controlled BOM may reflect different costs:

- If you enter a depth of *less than* the maximum number of levels for the costed BOM, the lower-level costs that appear reflect those costs generated by the original cost roll-up for this cost version and date.
- If you enter the *maximum depth* for the costed BOM, the lower-level costs that appear reflect the most current BOM and routing, and not the cost version that you entered on the Costed BOM page.

In addition, if changes occur to the BOM and routing after the cost roll-up, the cost of the BOM where you entered a depth of less than the maximum may reflect different costs from the cost from the maximum depth BOM. Both of these costed BOMs are considered correct, depending on the depth that you enter.

This diagram illustrates the cost calculation for a revision-controlled BOM:

The following diagram illustrates how your entry in the **Depth** field of the Costed BOM inquiry page can impact the top-level cost. In this case, component G was replaced with the higher-cost component H on April 1st. The last cost rollup was on March 1st. If the depth field has a value of *1*, then the displayed top-level cost on the Costed BOM inquiry page does not display the new component cost. However, if the depth is *5*, then the new component is used and the newer top-level cost is displayed:

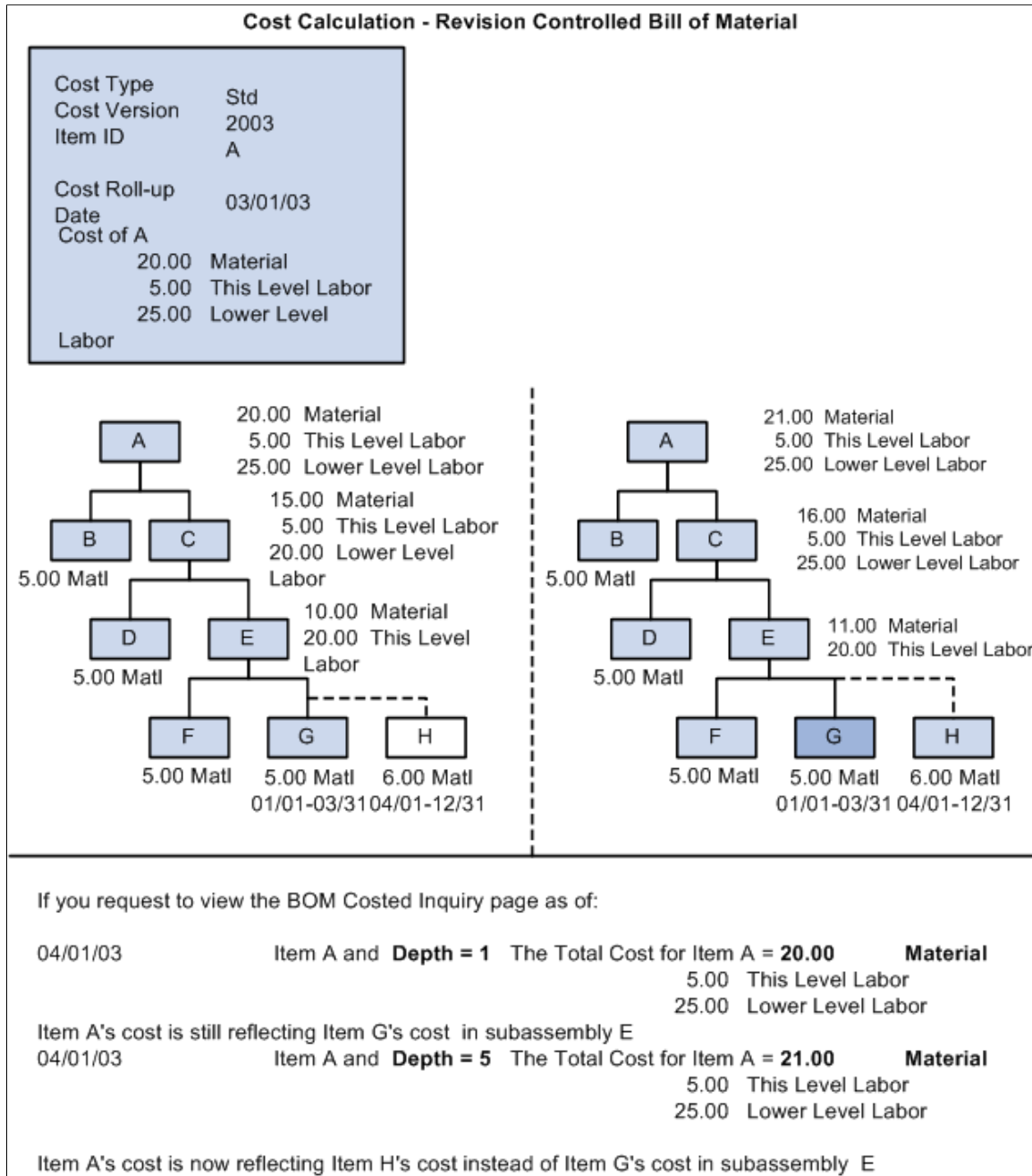

The system derives the cost of the assembly from the component's This Level (top level) and Lower Level Costs for the cost type, cost version, BOM and routing codes that you selected. It calculates costs for all assemblies and subassemblies that fall within the depth that you entered. If the BOM code is not 1, then the outputs on the Output Costs page reflect the outputs of this BOM code, and the components listed for level 1 are based on that BOM code. Lower levels always use BOM code 1. The routing code that you entered is used solely to determine the This Level Costs included in the calculation total costs.

Note: If the component appears as a subassembly, only This Level Costs appear on this page for the subassembly. Lower Level Costs for the subassembly appear on this page within the child components that appear for the subassembly.

Total cost is the sum of all the extended costs of all components on a BOM for a given effectivity date or revision, plus any This Level Costs for the item. The system computes the costs for each component and then totals for the assembly item.

By-products also appear on this page because their costs are incorporated into the assembly cost in the same manner as components. If the by-product is a *recycle* by-product, the cost impact is negative and is subtracted from the total cost. If it is a *waste* by-product, the cost is positive and is added to the total cost unless the item does not have a purchase cost, in which case the cost is 0.

Note: While you can run a Costed BOM inquiry for a purchased item that has a BOM, the system calculates only the material costs, based on the material costs for the components specified and the cost type and version that you select.

Related Links

“Understanding the Manufacturing Standard Cost Foundation” (PeopleSoft Cost Management)

Output Costs Page

Use the Output Costs page (EN_BOMCOST_OUT_SP) to display, by output type, all lower-level costing details for each co-product based on the costing percentage split.

Navigation:

Click the **Output Costs** link on the Costed BOM page.

This example illustrates the fields and controls on the Output Costs page. You can find definitions for the fields and controls later on this page.

Output Costs

Item ID: 000000000000020036 Creamy Tomato Sauce Bottled, 28 oz.
BOM Code: 1 **Routing Code:** 1
BOM Quantity: 375
Cost Type: CUR Current Costs
Cost Version: REV1 Initial Std Cost Load

Output Costs			
Output Type	Output Items	Description	Associated Primary BOM
Primary	000000000000020036	Creamy Tomato Sauce Bottled, 2	000000000000020036

Cost Version Total: 2.9364

Inquiry Total: 2.9364

Total Costs Difference: 0.0000

[Return](#)

Note: Due to rounding differences, you may see a small variance (+ or – 0.0003) between the cost version and the inquiry costs in this inquiry. This occurs when the system displays the costed BOM results for an item that's either a batch item or has batch assembly items at lower levels.

Item Cost Details Tab

<i>Field or Control</i>	<i>Description</i>
Cost Version Item Cost	Displays the last stored cost.
Inquiry Item Cost	Displays the new cost of the item being queried.
Delta	Displays the difference between the Cost Version Item Cost and the Inquiry Item Cost fields.

Batch Cost Details Tab

Select the Batch Cost Details tab.

This example illustrates the fields and controls on the Output Costs page: Batch Cost Details tab. You can find definitions for the fields and controls later on this page.

Output Type	Output Items	Description	Inquiry Batch Cost
Primary	00000000000020036	Creamy Tomato Sauce Bottled, 2	97.4088

Note: You can access this page only if you selected the **Cost as Batch** check box on the Costed BOM page.

<i>Field or Control</i>	<i>Description</i>
Inquiry Batch Cost	Displays the total cost from the Costed BOM page multiplied by the cost percentage of the primary product or co-product.

Details Tab

This tab displays BOM costs broken down by output type. For example, a process has two co-products, A and B. Co-product A has a cost allocation percentage of 60, and co-product B has a cost percentage of 40. One row shows A, with 60 percent of the costs, and another row shows B, with 40 percent of the costs.

Note: The cost allocation percentages must equal 100.

Related Links

[Assigning Associated Primary BOMs](#)

Header: Outputs Page

Component Detail Costs Page

Use the Component Detail Costs page (EN_ITEMCOST_SP) to display the manufacturing BOM component details.

You can display the Extended This Level Cost and Extended Lower Level Costs, by cost element, for the selected component item, cost type, and cost version.

Navigation:

Click a **Component ID** on the Costed BOM page.

<i>Field or Control</i>	<i>Description</i>
Cost Elmnt (cost element)	Displays a category of costs that you defined, such as materials, labor, or overhead.

Field or Control	Description
Calc Quantity (calculated quantity)	The system multiplies the cost by the calculated quantity to determine the extended cost.
Extended This Level Cost	Displays the item's extended cost of putting the components together. This cost is also known as the conversion cost.
Extended Lower Level Cost	Displays the item's extended cost of its components prior to their assembly at this level.
Total	The field on the left sums the This Level Costs for all cost elements, and the field on the right sums the Lower Level Costs for all cost elements.

Example

If A is a component on an assembly and is itself a subassembly composed of components B and C, and the cost of B is 20.00, and the cost of C is 30.00, then A's Lower Level Cost is 50.00 (not considering extended costs). If the cost of putting B and C together is 25.00, then A's This Level Cost is 25.00. For the assembly on which A is a component, the top-level assembly's Lower Level Cost is 75.00 (A's This Level Cost plus the Lower Level Cost).

Rounding

PeopleSoft Cost Management calculates the different extended costs by multiplying cost by the calculation quantity. It displays the cost results to four decimal places for viewing purposes. Calculation quantity can represent a value from four to ten decimal places. The QPA rounding setting determines the decimal range for the calculated quantity.

Related Links

“Installation Options - Manufacturing Page” (Application Fundamentals)

Comparing Manufacturing BOMs

This section lists common elements and discusses how to compare manufacturing BOMs:

Pages Used to Compare Manufacturing BOMs

Page Name	Definition Name	Usage
Compare BOMs - BOM Selections Page	EG_BOM_COMPARE1E	View the comparison of two manufacturing BOMs.

Page Name	Definition Name	Usage
“BOM Selections - Component Details Page” (PeopleSoft Engineering)	EG_BOM_COMPARE2	View BOM component differences.
Compare BOMs - Component Detail: Attachments Page	EG_BOM_COMPARE8	View differences in component attachments for two selected BOMs. “BOM Selections - Component Details Page” (PeopleSoft Engineering)
Compare BOMs - Component Detail: Documents Page	EG_BOM_COMPARE7	View component document differences for two selected BOMs. You must have PeopleSoft Engineering installed to access this page. “BOM Selections - Component Details Page” (PeopleSoft Engineering)
Compare BOMs - Component Detail: Reference Designators Page	EG_BOM_COMPARE9	View differences in reference designators for the two selected BOMs. “BOM Selections - Component Details Page” (PeopleSoft Engineering)
Compare BOMs - Component Detail: Dimensions Page	EG_BOM_COMPARE5	View dimension differences in two selected BOMs. “BOM Selections - Component Details Page” (PeopleSoft Engineering)
“BOM Selections - Component Details: Substitutes Page” (PeopleSoft Engineering)	EG_BOM_COMPARE_SUB	View component substitute differences for two selected BOMs.
Compare BOMs - Assy Header: Differences Page	EG_BOM_COMPARE1D	View assembly differences between the two selected BOMs. “BOM Selections - Assembly Header: Outputs Page” (PeopleSoft Engineering)
Compare BOMs - Assy Header: Attachments Page	EG_BOM_COMPARE1C	View differences in BOM attachments. “BOM Selections - Assembly Header: Outputs Page” (PeopleSoft Engineering)

Page Name	Definition Name	Usage
Compare BOMs - Assy Header: Documents Page	EG_BOM_COMPARE1B	View differences in assembly documents for the two selected BOMs. You must have PeopleSoft Engineering installed to access this page. “BOM Selections - Assembly Header: Outputs Page” (PeopleSoft Engineering)
“BOM Selections - Assembly Header: Outputs Page” (PeopleSoft Engineering)	EG_BOM_COMPARE10	View the output differences between two selected BOMs.
BOM Compare Report - BOM Compare Report	EN_BOM_COMP_REPORT	Define the two manufacturing BOMs that you want to compare.
BOM Compare Report - Print Options	EN_BOM_COM_REPORT2	Select the details that you want to appear on the BOM Compare report.

Common Elements Used in This Section

Field or Control	Description
Differences	<p>Displays the differences between the two BOMs. Values include:</p> <ul style="list-style-type: none"> • <i>Added</i>: The component has been added to the Target BOM (BOM2). • <i>Deleted</i>: The component has been deleted from the Baseline BOM (BOM1). <p>The system determines whether a component has been deleted, by comparing the component IDs, operation sequences, and effectivity dates.</p> <ul style="list-style-type: none"> • <i>Chg</i> (change): Indicates that the component exists on both BOMs, but there are differences in the component attributes. • <i>Chg BOM1</i>: If you have made a component change to the baseline BOM, the components appear listed. • <i>Chg BOM2</i>: If you have made a component change to the target BOM, the components appear listed. <hr/> <p>Note: The system lists a change when any information other than the component, operation sequence, or effective date has changed.</p> <hr/>

Compare BOMs - BOM Selections Page

Use the Compare BOMs - BOM Selections page (EG_BOM_COMPARE1E) to view the comparison of two manufacturing BOMs.

Navigation:

Manufacturing Definitions > BOMs and Revisions > Review BOM Information > Compare BOMs > BOM Selections

This example illustrates the fields and controls on the Compare BOMs - BOM Selections inquiry page. You can find definitions for the fields and controls later on this page.

BOM Selections

Unit:

*BOM Type:

Baseline BOM (BOM1)

*BOM State:

Item ID: Plain Sauce Bottled, 28oz

*BOM Code: Eff Date: All Dates/Revs:

Target BOM (BOM2)

BOM State: Manufacturing

Item ID: Creamy Tomato Sauce Bottled, 28 oz.

*BOM Code: Eff Date: All Dates/Revs:

Baseline BOM (BOM1)

<i>Field or Control</i>	<i>Description</i>
Item ID	Select an item for the baseline BOM.
	Click the Item Search button to access the Item Search Criteria page and select a different item.
BOM Code	Select a BOM code for the baseline BOM. You can select any valid BOM code, but regardless of the depth that you select, the system calculates all lower levels based on the primary BOM code.

Field or Control	Description
Eff Date	Enter the effective date for the baseline BOM if you do not want to use all dates and revisions.
All Dates/Revs	Select to compare all effective dates and revisions for the baseline BOM.

Target BOM (BOM2)

Field or Control	Description
Item ID	Select an item for the baseline BOM.
BOM Code	Select a BOM code for the baseline BOM. You can select any valid BOM code, but regardless of the depth that you select, the system calculates all lower levels based on the primary BOM code.
Eff Date	Enter the effective date for the baseline BOM if you do not want to use all dates and revisions.
All Dates/Revs	Select to compare all effective dates and revisions for the baseline BOM.

Compare BOMs - Component Detail: Component Details Page

Use the Compare BOMs - Component Detail: Component Details page (EG_BOM_COMPARE2) to view BOM component differences.

Navigation:

Manufacturing Definitions > BOMs and Revisions > Review BOM Information > Compare BOMs > Component Detail > Component Details

This example illustrates the fields and controls on the Compare BOMs - Component Detail - Component Details page: Attributes tab. You can find definitions for the fields and controls later on this page.

BOM Selections
Component Detail
Assy Header

Component Details
[Attachments](#)
[Documents](#)
[Reference Designators](#)
[Dimensions](#)
[Substitutes](#)

Unit: US012
BOM Type: Production

Baseline BOM (BOM1)

Item ID: 00000000000020024
Plain Sauce Bottled, 28oz

BOM Code: 1

Target BOM (BOM2)

Item ID: 00000000000020036
Creamy Tomato Sauce Bottled, 2

BOM Code: 1

Component Details
Customize | Find | First | 1-10 of 10 | Last

Attributes
Rtg/BOM/PID
Text

Differences	Component ID	Description	Comp Rev	Op Seq	Eff Date	Obs Date	Std UOM	Quantity	Per	Source Cd
Added.	00000000000020013	Creamy Tomato Sauce - Processed - Spice - Tomatoes - Cream		20	01/01/1900	12/31/2099	GAL	1000.0000	Order	Make
Chg BOM1	00000000000020025	Bottle, 28 oz.		10	01/01/1900	12/31/2099	EA	660.0000	Order	Buy
Chg BOM2.	00000000000020025	Bottle, 28 oz.		10	01/01/1900	12/31/2099	EA	4500.0000	Order	Buy
Deleted.	00000000000020026	Plain Sauce - Processed		20	01/01/1900	12/31/2099	GAL	150.0000	Order	Make
Chg BOM1	00000000000020028	Screwtop		20	01/01/1900	12/31/2099	EA	660.0000	Order	Buy
Chg BOM2.	00000000000020028	Screwtop		20	01/01/1900	12/31/2099	EA	4500.0000	Order	Buy
Added.	00000000000020029	Label - 28oz Creamy Tomato		30	01/01/1900	12/31/2099	EA	4500.0000	Order	Buy
Chg BOM1	00000000000020030	Packing Box		40	01/01/1900	12/31/2099	EA	55.0000	Order	Buy
Chg BOM2.	00000000000020030	Packing Box		40	01/01/1900	12/31/2099	EA	375.0000	Order	Buy
Deleted.	00000000000020065	Label - 28oz Plain Sauce		30	01/01/1900	12/31/2099	EA	660.0000	Order	Buy

The header data appears by default from the Compare BOMs - BOM Selections inquiry page.

Rtg/BOM/PID Tab

This page displays routing, BOM, and production ID differences between the selected BOMs.

Field or Control	Description
Subs Exist	If substitutes exist for a component, this field is selected.
Sub Supply	If the component is supplied by a subcontractor, this field is selected.

Related Links

[Components: Substitutes Page](#)

Compare BOMs - Component Detail: Substitutes Page

Use the Compare BOMs - Component Detail: Substitutes page (EG_BOM_COMPARE_SUB) to view component substitute differences for two selected BOMs.

Navigation:

Manufacturing Definitions > BOMs and Revisions > Review BOM Information > Compare BOMs > Component Detail > Substitutes

Substitute Items Tab

The system displays the substitutes' differences, including substitute item ID, description, and the original component ID.

Attributes Tab

The system displays the substitutes' differences, including substitute item ID, operation sequence, effective date, standard unit of measure, and conversion rate.

Compare BOMs - Assy Header: Outputs Page

Use the Compare BOMs - Assy Header: Outputs page (EG_BOM_COMPARE10) to view the output differences between two selected BOMs.

Navigation:

Manufacturing Definitions > BOMs and Revisions > Review BOM Information > Compare BOMs > Assy Header > Outputs

Dates Tab

This page displays output date differences including information such as output type, output item, operation sequence, and effectivity dates.

Attributes Tab

This page displays attribute differences including information such as output type, output item, quantity per, source code, serial control resource allocation, and cost allocation percentages.

Checking the BOM Verification Status

This section discusses how to Check the BOM Verification Status:

Pages Used to Check the BOM Verification Status

<i>Page Name</i>	<i>Definition Name</i>	<i>Usage</i>
BOM Verification Page	EN_BOM_VERIFY_REQ	Locate unwanted loops in BOMs.
Delete BOM Verification Rows Page	EN_BOM_VERIFY_DEL	Delete records created by the BOM Verification Request.
BOM Verification Status - BOM Verification Detail Page	EN_BOM_VERIFY_STAT	View, on a summary level, a list of all verified BOMs or a list of all looping BOMs discovered after running the Verification Request.
BOM Verification Status - BOM Verification Detail Page	EN_BOM_VERIFY_DET	View a detailed list of all looping BOM components discovered as a result of running the BOM Verification Request. BOM Verification Status - BOM Verification Detail Page

BOM Verification Page

Use the BOM Verification page (EN_BOM_VERIFY_REQ) to locate unwanted loops in BOMs.

Navigation:

Manufacturing Definitions > BOMs and Revisions > Identify Looping BOMs > BOM Looping Verification

<i>Field or Control</i>	<i>Description</i>
All BOM paths verified	Select this option to display all verified BOMs by top-level assembly.
BOMs with errors only	Select this option to display all looping BOMs, along with the specific looping lower-level assembly and component items.
Search	Click to check for looping BOMs. If the system does not detect any loops, a message appears. If the system detects any looping BOMs, they appear at the bottom of this page.
Details	Click this link for any top-level assembly with errors to access the BOM Verification Status - BOM Verification Detail page.

Delete BOM Verification Rows Page

Use the Delete BOM Verification Rows page (EN_BOM_VERIF_DEL) to delete records created by the BOM Verification Request.

Navigation:

Manufacturing Definitions > BOMs and Revisions > Identify Looping BOMs > Delete BOM Verification Detail

The verification request process adds a series of records to the BOM Explosion table. These records take up space and are of no use if there are no looping BOMs. You can use this page to delete these records by process instance.

BOM Verification Status - BOM Verification Detail Page

Use the BOM Verification Status - BOM Verification Detail page (EN_BOM_VERIFY_DET) to view a detailed list of all looping BOM components discovered as a result of running the BOM Verification Request.

Navigation:

Manufacturing Definitions > BOMs and Revisions > Identify Looping BOMs > BOM Verification Status > BOM Verification Status

Click a **Detail** link.

<i>Field or Control</i>	<i>Description</i>
Lvl (level)	Displays the level where the loop in a BOM occurred.
Component ID	Displays the specific component where the loop in a BOM occurred.
BOM Code	Displays the BOM code for the BOM in which the loop occurred.
Pos Nbr (position number), Op Seq , Eff Date , Obs Date , and Associated Primary BOM	Displays this additional information for the BOM in which the loop occurred.

Viewing Item Where-Used Information

This section discusses how to select and view item where-used information.

Pages Used to View Item Where-Used Information

<i>Page Name</i>	<i>Definition Name</i>	<i>Usage</i>
<u>Item Where Used Page</u>	EN_BOM_WHEREUSED	Display all the BOMs on which an item appears. This information is useful when you want to analyze the impact a change to an item can have on all existing BOMs.
<u>Item Where Used Express Page</u>	EN_ITEMWHERE_USED	Display all the BOMs on which a component is used. This information is useful when you want to analyze the impact a change to an item can have on all existing BOMs.
Item Where Used (report) Page	EN_WHEREUSED_RPT	Generate the Components/Substitutes Where Used report that lists all BOMs on which a component appears. This information is useful when you want to analyze the impact a component change can have on all existing BOMs.

Item Where Used Page

Use the Item Where Used page (EN_BOM_WHEREUSED) to display all the BOMs on which an item appears.

This information is useful when you want to analyze the impact a change to an item can have on all existing BOMs.

Navigation:

Manufacturing Definitions > BOMs and Revisions > Review BOM Information > Item Where Used

This example illustrates the fields and controls on the Item Where Used page. You can find definitions for the fields and controls later on this page.

Item Where Used

*Search:

Unit:

Item ID: Tomatoes, Chopped, and Mixed

*BOM Type: Std UOM: GAL BOM Code: Source Cd: Make

Eff Date: All Dates/Revs

Levels Up: Top Levels only

*View:

Component/Substitute Where Used Customize | Find | | First 1-3 of 3 Last

Lvl	Item ID	Description	BOM Code	Op Seq	Quantity
1	00000000000020013 <-	Creamy Tomato Sauce - Processe	1	20	975.0000
1	00000000000020020 <-	Classic Spaghetti Sauce - Proc	1	30	975.0000
1	00000000000020039 <-	Canned Tomatoes	1	20	12.0000

Field or Control	Description
Search	Select to display only certain types of data. Values are <i>Components Only</i> , <i>Components and Substitutes</i> , <i>Outputs Only</i> , and <i>Substitutes Only</i> .
Unit, Item ID, BOM Type, Eff Date (effective date) or Revision, BOM Code, and Levels Up	Enter this information about the item, as appropriate.
Levels Up and Top Levels Only	Enter <i>1</i> , to see just the item's parent assembly. The larger the number, the higher the level; for example, level 3 is three levels higher in the BOM structure than the item. To view just the final end item in which the selected item is an item, select Top Levels only . If you have requested more than one level, an arrow appears next to the item's immediate parent in the Item ID field.
Search	Click to retrieve the selected item where-used information.

If you selected *Components Only* or *Components and Substitutes* in the **Search** field, the system displays all higher-level subassemblies or assemblies that contain the selected item. You'll also see the levels at which the items appear in the higher-level items. The left arrow (←) in the display points to the item that directly uses the item selected.

Components and Substitutes and *Substitutes Only* appear if the component for the item is a substitute.

If you selected *Outputs Only* in the **Search** field, the system displays information according to output type, including:

- Item ID

- BOM code
- Operation sequence
- Output quantity

If the component is revision-controlled, a **Comp Rev** field also appears as a search parameter. If you enter a component revision, this page returns all assemblies where that component matches or is blank. If you leave the component revision blank, the inquiry returns assemblies that use any revision of the component.

Related Links

[Component Use Up](#)

Item Where Used Express Page

Use the Item Where Used Express page (EN_ITEMWHERE_USED) to display all the BOMs on which a component is used.

This information is useful when you want to analyze the impact a change to an item can have on all existing BOMs.

Navigation:

Manufacturing Definitions > BOMs and Revisions > Review BOM Information > Item Where Used Express

This example illustrates the fields and controls on the Item Where Used Express page. You can find definitions for the fields and controls later on this page.

The screenshot shows the 'Item Where Used Express' interface. At the top, there are search fields: Business Unit (US008), *Component ID (FR7005), *BOM Type (Production), Effective Date (01/01/1900), Levels (1), and Source Ctd (Buy). There are also checkboxes for 'All Dates/Revs' and 'Active Items Only', and a 'Search' button. Below the search fields is a 'Find' button. The main area displays a table titled 'Item Where Used' with columns for Level, Item ID, Description, BOM Code, and Operation Sequence. The table contains 8 rows of data.

Level	Item ID	Description	BOM Code	Operation Sequence
1	MT2000	Professional Road Bike, Womans	1	10
1	MT3000	Mountain Bike, Womans	1	10
1	MT3010	Mountain Bike, Womans - Limite	1	10
1	MT3020	Mountain Bike, Womans - Millen	1	10
1	SR1001	Omega 500 Touring Bike	1	10
1	SR1002	Carrera 6000 Hi Performance Ro	1	10
1	SR1003	Mt. Whitney 3000 Mountain Bike	1	10

<i>Field or Control</i>	<i>Description</i>
Business Unit, Component ID, BOM Type, BOM Code, Effective Date and Levels	Enter this information about the item, as appropriate.
All Dates/Revs (Revisions)	Select to search for components with all dates and revisions. Selecting this inactivates the Effective Date field.
Active Items Only	Select to only include active items. The system disregards inactive items while searching if this is selected.

Chapter 11

Defining Resources

Understanding Resources

This section lists common elements and discusses resource setup.

Common Elements Used to Define Resources

<i>Field or Control</i>	<i>Description</i>
Crew Status, Machine Status, and Tool Status	<p>This field is for informational purposes. Values are:</p> <ul style="list-style-type: none">• <i>Available</i>: The resource is available for use.• <i>Pending</i>: The new resource is not yet approved for use in production and cannot be associated with a work center.• <i>Unavail</i> (unavailable): The crew is not available, but you can associate it with work centers, tasks, routings, and production. This is only an option for crew status.• <i>In Repair</i>: The resource is in repair, but you can associate it with work centers, tasks, routings, and production. This is not an option for crew status.• <i>Schd Maint</i> (scheduled maintenance): The resource is scheduled for maintenance. This is not an option for crew status.

Resource Setup

Resources are the crews, machines, and tools used at work centers to complete tasks. Resources are consumed for the duration of a task and can be reused after the task is complete. You can also use PeopleSoft Supply Planning to analyze resources.

Before using resources, consider these steps:

1. If you are using PeopleSoft Asset Management, you can link PeopleSoft Manufacturing machines and tools to asset information maintained in PeopleSoft Asset Management.

To make that link, define machines and tools as assets in PeopleSoft Asset Management. This link enables you to view detailed machine and tool asset, service, and repair information from the Define Machine page and the Define Tool page.

2. Define tools as a noncosted item in PeopleSoft Inventory to maintain quantity on-hand information for tools, as well as stock them in regular inventory locations.

This enables you to purchase, receive, and stock tools without including them in the asset balance.

Related Links

[Bills of Material](#)

“Understanding Item Control Values” (PeopleSoft Managing Items)

Defining Resources

To define resources, use the Define Crew Resource (EN_CREWS), Define Machine Resources (EN_MACHINES), and the Define Tool Resource (EN_TOOLS) components.

This section provides an overview of resource planning and discusses how to define resources.

Pages Used to Define Resources

<i>Page Name</i>	<i>Definition Name</i>	<i>Usage</i>
Crews - Define Crew Page	EN_CREW	Define crews that you can later associate with work centers.
Crews - Text	EN_CREW_TEXT	Enter crew text.
Machines - Define Machine Page	EN_MACHINE	Define the machines that you can later associate with work centers on the routings.
Machines - Manufacturer Page	EN_MACH_MANUFACTUR	Define the machine manufacturer and associated data.
Machines - Text	EN_MACH_TEXT	Enter machine text.
Tools - Define Tool Page	EN_TOOL	Define tools that you can later associate with work centers on the routings.
Tools - Location Page	EN_TOOL_LOCATION	Define the tool location, including the inventory attributes and typical storage location.
Tools - Manufacturer Page	EN_TOOL_MANUFACTUR	Define the tool manufacturer and associated data.
Tools - Text	EN_TOOL_TEXT	Enter text for a tool.

Crews - Define Crew Page

Use the Crews - Define Crew page (EN_CREW) to define crews that you can later associate with work centers.

Navigation:

Manufacturing Definitions > Resources and Routings > Resources > Define Crews

<i>Field or Control</i>	<i>Description</i>
Crew Size	The system uses crew size as the default value on work center, task, routing, and production pages if, on those pages, you specify the crew as the primary crew. When you specify a work center on an item's routing, the system uses crew size as a factor when it calculates the item's labor costs.
Calendar Code	Select an associated calendar code. Define calendar codes on the Calendar Code Definition page.

Related Links

[Calendar Code Definition Page](#)

Machines - Define Machine Page

Use the Machines - Define Machine page (EN_MACHINE) to define the machines that you can later associate with work centers on the routings.

Navigation:

Manufacturing Definitions > Resources and Routings > Resources > Define Production Machines

<i>Field or Control</i>	<i>Description</i>
Machine Status	<p>Values are:</p> <ul style="list-style-type: none"> <i>Available:</i> The machine is available for use. <i>In Repair:</i> The machine is in repair, but you can associate it with work centers, tasks, routings, and production. <i>Pending:</i> A new machine is not yet approved for use in production and cannot be associated with work centers. <i>Sched Maint</i> (scheduled maintenance): The machine is scheduled for maintenance. <p>This field is informational only.</p>

Field or Control	Description
Link to AM (link to asset management)	To track the machine as an asset by linking an asset number to the tool, select <i>AM Asset</i> . The PeopleSoft Asset Management Business Unit and Asset ID fields then become active. If you select <i>Non-AM</i> , the system does not create a link to PeopleSoft Asset Management.
AM Asset (asset management asset)	Click to view the machine's asset information with the Review Assets pages in PeopleSoft Asset Management.
AM Service (asset management service)	Click to view the machine's asset service and repair details with the Review Service/Repair Detail pages in PeopleSoft Asset Management.

Related Links

“Understanding Adding and Maintaining Assets” (PeopleSoft Asset Management)

“Understanding Asset Maintenance, Repair, Warranties, and Insurance” (PeopleSoft Asset Management)

Machines - Manufacturer Page

Use the Machines - Manufacturer page (EN_MACH_MANUFACTUR) to define the machine manufacturer and associated data.

Navigation:

Manufacturing Definitions > Resources and Routings > Resources > Define Production Machines

Enter or change the manufacturer information for the selected machine:

- Serial ID
- Manufacturer name
- Model
- Product version
- Production date
- Plant
- Contact

Note: This page is only for informational purposes. If you have entered similar data in PeopleSoft Asset Management, you do not need to enter this information here.

Tools - Define Tool Page

Use the Tools - Define Tool page (EN_TOOL) to define tools that you can later associate with work centers on the routings.

Navigation:

Manufacturing Definitions > Resources and Routings > Resources > Define Production Tools

Note: Defining tools is optional.

Field or Control	Description
Tool Status	<p>Values are:</p> <ul style="list-style-type: none"> • <i>Available</i>: The tool is available for use. • <i>In Repair</i>: The tool is in repair, but you can associate it with work centers, tasks, routings, and production. • <i>Pending</i>: A new tool is not yet approved for use in production and cannot be associated with work centers. • <i>Sched Maint</i>: The tool is scheduled for maintenance. <p>You can associate it with work centers, tasks, routings, and production. This field is informational only.</p>
Link to AM (link to asset management)	<p>To track the tool as an asset by linking an asset number to the tool, select <i>AM Asset</i>.</p> <p>The PeopleSoft Asset Management Business Unit and Asset ID fields then become active.</p> <p>If you select <i>Non-AM</i>, the system does not make a link with PeopleSoft Asset Management.</p>
AM Asset (asset management asset)	Click to view the tool's asset information with the Review Assets pages in PeopleSoft Asset Management.
AM Service (asset management service)	Click to view the tool's asset service and repair details with the Review Service/Repair Detail pages in PeopleSoft Asset Management.

Tools - Location Page

Use the Tools - Location page (EN_TOOL_LOCATION) to define the tool location, including the inventory attributes and typical storage location.

Navigation:

Manufacturing Definitions > Resources and Routings > Resources > Define Production Tools > Location

If you have previously defined the tool as an item in PeopleSoft Inventory, you can enter the tool's inventory attributes.

Field or Control	Description
Cage Number	Enter an inventory cage number. This field is informational only.
Item ID	Select an ID for a noncosted item.
Area, Lev 1 (level 1), Lev 2 (level 2), and Lev 3 (level 3)	(Optional) Select the inventory storage area and inventory location where this tool is stored. The system displays the number of storage levels defined for each storage area.

Tools - Manufacturer Page

Use the Tools - Manufacturer page (EN_TOOL_MANUFACTUR) to define the tool manufacturer and associated data.

Navigation:

Manufacturing Definitions > Resources and Routings > Resources > Define Production Tools > Manufacturer

Enter or change the any of the manufacturer information for the selected tool:

- Serial ID
- Manufacturer name
- Model
- Product version
- Production date
- Plant
- Contact

Note: This page is for informational purposes only. If you have entered similar data in PeopleSoft Asset Management, do not need to enter this information here.

Viewing Where-Used Resource Data

This section provides an overview of resource searching and lists the pages used to view where resources are used on work centers, tasks, routings, and in production.

Pages Used to View Where-Used Resource Data

Page Name	Definition Name	Usage
Used on Work Centers Page	EN_RSRC_WHERE_WC	View resources used on work centers.
Used on Tasks Page	EN_RSRC_WHERE_TASK	View resources used on tasks.
Used on Routings Page	EN_RSRC_WHERE_RTG	View resources used on routings.
Used in Production Page	EN_RSRC_WHERE_PRD	View resources used in production.
Resources Where Used Report Page	RUN_ENS1004	View where-used information about resources on work centers, tasks, routings, and in production.

Understanding Resource Searching

When viewing where-used resources data, you control the data and pages that you see by selecting resources and by changing the search selection.

Note: The system searches for the use of any individual crew, machine, or tool simultaneously. It does not search for cases where a combination of the resources is used, but rather where any one of them is used.

You can search for production, routings, tasks, work centers, or all of these. The Search field on a particular page is automatically populated by the value that mirrors the page. For example, if you access the Used on Work Centers page, the default value in the Search field is *Work Centers*. If you search for the default value, the system populates the current page with data after you click the **Search** button.

If you search for another value or search for all values, you access the page that corresponds with your choice. For example, if you are on the Used on Work Centers page, and you select *Only Task*, in the **Search** field, you move to the Used on Tasks page. In this example, you then click the **Search** button to view the tasks on which the selected resources are used. Before clicking the **Search** button, you can change the selected resources that are populated by the previous page.

Chapter 12

Defining Work Centers

Understanding Work Centers

A work center can consist of one or more people and machines, and it can represent a logical grouping of machines, a department, or a cost center. You can assign each operation or task on a routing to a work center where the operation or task takes place. Additionally, you can assign resources (crews, machines, or tools) to each work center.

Common Element Used in Work Centers

<i>Field or Control</i>	<i>Description</i>
Work Center	Displays the unique identifier for the work center.

Prerequisites

Before you begin to fully use the work center functionality, complete these setup steps:

1. If you want to associate different resources to work centers, you must define the resources before creating and maintaining work centers.
2. If you want to maintain work center exceptions to the production calendar, then create alternate calendar codes and create the calendar for the alternate calendar code using the Calendar Code Definition page.

You can associate a calendar code with each work center whose operating times differ from the production calendar defined for the business unit.

3. To define conversion codes by work center, as opposed to by task, set the business unit rate maintenance to *By Work Center* by using the **Rate Maintenance/Defaulting** group box on the MFG Business Unit Options page.
4. Define conversion codes and their associated labor, machine, and overhead rates or costs within PeopleSoft Cost Management.

You can assign a conversion code and up to four conversion overhead codes to the work center.

5. Because you must associate a WIP inventory location with each work center, these inventory locations must be defined before adding work centers.

Related Links

[Understanding Resources](#)

[MFG Business Unit Options Page](#)

“Understanding the Manufacturing Standard Cost Foundation” (PeopleSoft Cost Management)

Defining Work Centers

To create and maintain work centers and their associated resources, conversion codes, text, locations, departments, and distribution types by business unit, use the Work Center Definition component (WORK_CENTERS). To define overhead rates, use the Overhead Rates component.

See *PeopleSoft Cost Management Documentation*

If you have enabled PeopleSoft Workflow and when you add a new work center, or when you change any attribute in an existing work center, the system optionally sends the Workcenter Change workflow notification to the roles that you've defined, such as an engineering manager or cost accountant.

This section discusses how to:

1. Define work center attributes.
2. Define work center resources.
3. Define work center planning options.
4. Associate conversion codes with work centers.
5. Associate conversion overhead codes with work centers.
6. View work center where-used data.

Pages Used to Define Work Centers

Page Name	Definition Name	Navigation	Usage
Define Work Center - Definition	EN_WORK_CENTER	Manufacturing Definitions > Resources and Routings > Tasks and Work Centers > Define Work Centers	Define and maintain work centers for use on routings.
Define Work Center - Text	EN_WORK_CENTER_TXT	Manufacturing Definitions > Resources and Routings > Tasks and Work Centers > Define Work Centers > Define Work Center > Text	Enter up to 254 characters of text to associate with the work center.

Page Name	Definition Name	Navigation	Usage
Define Work Center - Attachments	EN_WC_ATT	Manufacturing Definitions > Resources and Routings > Tasks and Work Centers > Define Work Centers > Define Work Center > Attachments	Attach work center-related documents. Click the Get Attachment button to launch the multimedia object that is associated with the work center. Select the type of media that you want to attach and enter the file name.
Define Work Center - Resources	EN_WC_RESOURCE	Manufacturing Definitions > Resources and Routings > Tasks and Work Centers > Define Work Centers > Define Work Center > Resources	Define work center resources.
Define Work Center - Planning Opts (planning options)	EN_AGGREG_WC	Manufacturing Definitions > Resources and Routings > Tasks and Work Centers > Define Work Centers > Define Work Center > Planning Opts	Define the planning options associated with the work center.
Define Work Center - Conv Code (conversion code)	EN_WC_CONCODE	Manufacturing Definitions > Resources and Routings > Tasks and Work Centers > Define Work Centers > Define Work Center > Conv Code	Associate conversion codes with the corresponding labor and machine rates for the work center.
Define Work Center - Conv Ovhd Codes (conversion overhead codes)	EN_WC_CONOHCODE	Manufacturing Definitions > Resources and Routings > Tasks and Work Centers > Define Work Centers > Define Work Center > Conv Ovhd Codes	Associate work center conversion overhead codes.

Related Links

[Your Enterprise Data Flow](#)

[Delivered Workflows for PeopleSoft Manufacturing](#)

Define Work Center - Definition Page

Use the Define Work Center - Definition page (EN_WORK_CENTER) to define and maintain work centers for use on routings.

Navigation:

Manufacturing Definitions > Resources and Routings > Tasks and Work Centers > Define Work Centers

This example illustrates the fields and controls on the Define Work Center - Definition page. You can find definitions for the fields and controls later on this page.

Define Task	Resources	Times	Conversion Code	Conversion Ovhd Codes
Definition		Text		Attachments
Business Unit		US008		
Task Code		SUB-1		
Description		Subcontracted Painting		
Short Description		Sub Paint		
*Work Center		SUB-1 Paint		
*Intensity		Labor Time		
Count Point Control		Planning Defaults		
<input type="checkbox"/> Count Point		<input type="checkbox"/> Continuous Scheduling		
		<input type="checkbox"/> Ignore Capacity		
Subcontracting				
<input checked="" type="checkbox"/> Subcontracted				
Supplier ID		SCM0000004		
Subcontracted Item		<input type="text"/>		Std UOM

Before defining routings, you can define a master dictionary of tasks or jobs that can be performed at work centers.

Field or Control	Description
Department	(Optional) Enter the department code, which is informational only and is used for reporting purposes.

Field or Control	Description
Distrib. Type (distribution type)	<p>(Optional) Predefine distribution types within PeopleSoft Cost Management. When used in conjunction with the assembly completion transaction, the distribution types can determine the general ledger accounts when posting earned conversion costs, such as labor, machine, subcontracting, and overhead costs.</p> <p>The distribution type appears by default as the value defined in PeopleSoft Inventory for the transaction group for earned conversion costs.</p>
Average Daily Hours	<p>Enter the average number of hours that the work center is in operation each day. This field determines the operation's setup, fixed run, run rates, and post-production times in hours, when the time unit for an operation is expressed in days for planning and costing purposes.</p> <p>For example, suppose that you set the run rate for an operation to 100 units per day and the work center's average daily hours to 8 hours, the system converts this to 100 units per 8 hours.</p>
Default Queue Time	<p>Enter the default amount of time that a job must wait before it can be processed by this work center. The value is copied to a task when you create a task and specify queue time on the task. The system copies it to a routing when you assign a task to an operation sequence on the routing.</p>
Queue Time Unit	<p>Designate whether the default queue time is in <i>Minutes</i>, <i>Days</i>, or <i>Hours</i>.</p>

Note: If you change the average daily hours and the run rates on routing operations are expressed in units-per-day, revisit all routing operations that use the work center and adjust the run rates accordingly.

Note: The **Default Queue Time** field and the **Queue Time Unit** field do not appear if you use PeopleSoft Supply Planning.

Work Center Calendar Code

Field or Control	Description
Calendar Code	<p>You can associate a calendar code with the work center. Use the Calendar Code Definition page to define calendar codes.</p> <p>If you intend to use a production calendar, as opposed to a five-day work week definition, define at least one calendar code and the associated calendar. You can define alternate calendar codes with alternate calendars. A calendar code entered here indicates that the work center has different hours of operation from the business unit.</p> <p>If you enable PeopleSoft Workflow and change a work center calendar code, the Work Center Calendar Code Change workflow notifies the planner of the change. The planner may want to reschedule production.</p>
Run-time Calendar Code	<p>Displays which calendar code is used for scheduling the work center.</p>

When you associate a calendar code that is different from the current runtime calendar code—or when you associate a calendar code for the first time—the system optionally sends a workflow notification to selected roles that you have defined. This workflow notifies the role, such as a production control manager, that the calendar originally used for scheduling is not synchronized with the calendar code that is specified for the work center.

See [Delivered Workflows for PeopleSoft Manufacturing](#).

Work Center WIP Location

You can select the WIP location to which material associated with the operation is delivered for use in production. This is also the WIP location from which material is consumed upon operation or assembly completion (if the component, production area, or item's issue method is set to *Issue* or *Replenish*.)

Field or Control	Description
Owned and Non-Owned	<p>Indicate a WIP location for both owned and non-owned inventory. The system can only issue owned components to (and consume them from) owned WIP locations. Likewise, the system can only issue non-owned material to (and consume it from) non-owned locations.</p> <p>Consigned inventory is issued to non-owned WIP locations. Once consumed, it is considered owned. If you never use consigned inventory, maintain non-owned inventory, or issue non-owned inventory to production, you can leave these fields blank.</p>

Note: If you use consigned components, you must define both an owned location and a non-owned location. Consigned components are consumed from a non-owned location but, once consumed, can only be returned to an owned location.

Related Links

[Calendar Code Definition Page](#)

Define Work Center Resources Page

Use the Define Work Center Resources page (EN_WC_RESOURCE) to define work center resources.

Navigation:

Manufacturing Definitions > Resources and Routings > Tasks and Work Centers > Define Work Centers > Define Work Center > Resources

This example illustrates the fields and controls on the Define Work Center Resources page. You can find definitions for the fields and controls later on this page.

The screenshot shows the 'Define Work Center Resources' page with the following elements:

- Tabs: Define Work Center, Resources (selected), Planning Opts, Conv Code, Conv Qvhd Codes
- Business Unit: US008
- Work Center: BR-ASSY Brake Assembly Work Center
- Section: Costing Resource Defaults
 - Crew Size: 1.00
 - Machine Resources: 1.00
- Section: Resources Used on Work Centers

*Resource Type	Crew/Machine/Tool	Description	Status	Priority		
Primary Crew	ASSY03	Assembly Crew 3	Available	10	+	-
Alt Crew	ASSY01	Assembly Crew 1	Available	10	+	-
Primary Machine	BRAKE01	Brake Assembly Equipment 1	Available	10	+	-

Costing Resource Defaults

Field or Control	Description
Crew Size	(Optional) Enter the number of people at the work center. This value appears by default from the primary crew specified in the work center definition.
Machine Resources	(Optional) Enter the number of machines at the work center. If multiple machines exist in the work center and you want to factor their costs into an item's cost, enter that factor here.

Although these are optional fields, the system uses the crew size and machine resources information when it calculates standard labor and machine costs for items in the standard cost calculations.

In some cases, the system also uses crew size and machine resources when it calculates the per unit cost of an item, as well as the earned labor and machine amounts in PeopleSoft Manufacturing. The system only uses crew size and machine resources in labor and machine cost calculations if the value of the labor and machine rate is defined as a rate per hour, rather than a rate per unit. If the value is per unit, it's expected to be factored in and the system doesn't include it in the calculation. However, if the rate is per hour, the system uses the crew size in the calculation.

The system only uses crew size and machine resources for runtime labor and machine calculations. Setup times, for example, are typically of fixed duration and amount. Therefore, it is assumed that you have already factored in crew size and machine resources when you define them.

To better understand an item's cost calculation and the earned labor cost calculations, consider these equations. For setup time operations, the item's cost calculation equation is:

$$\begin{aligned} &(\text{Setup labor or machine rate per hour}) \times (\text{Setup time [in hours]}) = \text{Setup cost} \\ &(\text{Setup cost}) \div (\text{Item's average order quantity}) = \text{Per unit setup cost} \end{aligned}$$

When calculating earned setup costs in PeopleSoft Manufacturing, the system calculates the setup cost for the production quantity. It does not divide by the average order quantity.

For runtime operation, the cost calculation equation differs, depending on whether the labor or machine rate is a rate per unit or rate per hour. If it's a rate per unit, then the applicable per unit item cost equation is the labor or machine rate per unit. To calculate the earned labor or machine run cost, the system uses this equation:

$$(\text{Run labor or machine rate}) \times (\text{Units completed}) = \text{Cost}$$

If the labor or machine rate is a rate per hour, then the applicable per unit item cost equation is as follows:

Field or Control	Description
Labor	$(\text{Crew size}) \times (\text{Labor rate for run}) \times (\text{Run time [in hours]}) = \text{Labor run cost}$
Machine	$(\text{Machine resources}) \times (\text{Machine rate for run}) \times (\text{Run time [in hours]}) = \text{Machine run cost}$

To calculate the earned labor or machine run costs in production, the system multiplies the per unit cost by the quantity completed at the operation.

The system copies the resources to the task when you enter the work center for the task. It copies the resources to the routing when you specify the task for an operation, or, if you are not using tasks, when you specify the work center for the routing operation. If you choose not to define resources, you can enter the crew size and number of machines used in the work center here.

Resources Used on Work Centers

<i>Field or Control</i>	<i>Description</i>
Resource Type and Crew/ Machine/Tool	<p>Select a type and resource to associate with the work center. You can only associate one <i>Primary Tool</i>, <i>Primary Crew</i>, and <i>Primary Machine</i> with the work center, but you can designate unlimited <i>Alternate Crews</i>, <i>Machines</i>, or <i>Tools</i>. A primary resource is the preferred resource to be used in production.</p> <p>You can assign tools, crews, and machines to multiple work centers.</p>
Status	Indicates the availability of a resource for this work center.
Priority	<p>Enter a whole-number ranking to indicate which resource has preference over others when considering multiple resources. The lower the priority assigned to a resource, the more likely it is that the resource will be chosen. You can manually specify a priority for the task resource or work center resource. The priority appears by default onto the routing. The primary resource for tool, crew, and machine automatically changes to a priority of 10. Other resources of like type automatically change to a priority of 20. The priority setting enables you to designate the order in which PeopleSoft Supply Planning uses resources.</p>

If you use PeopleSoft Supply Planning, you must enter at least one resource in the resource list (crew or machine) at each work center. PeopleSoft Supply Planning only uses the priority that you define on the routing.

Note: To specify a resource on a task or routing, first associate it with the work center in which the task or operation is performed.

Changing the resources for a work center does not change the resources for any routing operation that is using the work center. Furthermore, you cannot delete a work center resource if it is being used on a task or routing.

The system only copies primary resources when it copies routings to production.

Define Work Center - Planning Opts (planning options) Page

Use the Define Work Center - Planning Opts (planning options) page (EN_AGGREG_WC) to define the planning options associated with the work center.

Navigation:

Manufacturing Definitions > Resources and Routings > Tasks and Work Centers > Define Work Centers > Define Work Center > Planning Opts

This example illustrates the fields and controls on the Define Work Center - Planning Opts page. You can find definitions for the fields and controls later on this page.

Define Work Center	Resources	Planning Opts	Conv Code	Conv Qvhd Codes
Business Unit US008				
Work Center BR-ASSY Brake Assembly Work Center				
Resource Class	Time	<input type="checkbox"/>	Ignore Violations	
Bucket Size	Weekly	<input type="checkbox"/>	Continuous Scheduling	
Allocation Strategy	Proportional	<input type="checkbox"/>	Ignore Capacity	
Availability %	100			
Capacity/Multiplier/Units Set Personalize Find View All First 1 of 1 Last				
*Effective Date	Multiplier / Units			
01/01/1900		5.00	<input type="button" value="+"/>	<input type="button" value="-"/>

Field or Control	Description
Resource Class	<p>Because work centers are modeled as aggregate resources in PeopleSoft Supply Planning, define each work center as either an aggregate resource by time or an aggregate resource by unit. Values are:</p> <ul style="list-style-type: none"> <i>Time</i>: You can plan for all resources based on the amount of time available in the time bucket that you select. <i>Unit</i>: You can plan for all resources based on the number of units the resources can produce in a time bucket. The default resource class is <i>Time</i>.
Bucket Size	Enter the summation period, the period over which you are aggregating. Values are <i>Daily</i> , <i>Weekly</i> , and <i>Monthly</i> . The default is <i>Weekly</i> .
Allocation Strategy	Enter a value to specify how you plan to spread the time and unit over the bucket size. Values are <i>Start</i> , <i>Finish</i> , and <i>Proportional</i> . This determines whether if the task is stretched across two or more buckets—in its entirety—is placed in the first bucket, the last bucket, or spread proportionally across all buckets. The default is <i>Proportional</i> .
Availability %	Define a percentage of the total capacity time that the resource is available for use. You might take into consideration scheduled maintenance or include a buffer for unexpected repairs when you define the percentage. You can change the resource availability percentage for all the aggregate resources. The default is <i>100</i> .

Field or Control	Description
Ignore Violations	<p>Select to prevent the solvers from analyzing and resolving capacity issues impacting the work center. When this check box is selected, capacity issues—although not recognized by the solvers—will appear in the PeopleSoft Supply Planning Violations workbench if they are before the capacity fence defined for the planning instance. By selecting the Ignore Violations check box on noncritical work centers, you enable the solvers to ignore these work centers and focus on critical work centers for capacity repair.</p> <p>Select this check box to generate what-if scenarios.</p>
Continuous Scheduling	<p>Select to complete the corresponding operation in a single run of continuous valid calendar time, with no gaps allowed between shifts. This field is used as a routing operation default.</p>
Ignore Capacity	<p>Select to prevent solvers from considering the corresponding operation as required capacity for the work center. This field is used as a routing operation default.</p>

Capacity Multiplier/Units Set

This is used by the system to determine the available capacity on a work center. Because these sets are effective-dated, you can use the **Capacity Multiplier/Units** grid to vary the work center's available capacity over time.

If you define the work center as an aggregate resource by time, the system uses the capacity multiplier to represent the number of identical work centers that exist for scheduling purposes.

For example, suppose that you define a work center as an aggregate resource by time with weekly buckets, and it has a capacity multiplier of 2, with an effective date of March 5, 2005. Then, beginning on March 5, 2005, PeopleSoft Supply Planning treats this aggregate resource as two identical work centers that it can use simultaneously for jobs. If the work center has 40 hours of available calendar time in a weekly bucket, then the available capacity for the bucket, based on a capacity multiplier of 2, would be 80 hours total. PeopleSoft Supply Planning uses this capacity multiplier to determine the work center's available capacity until the next capacity multiplier becomes effective.

If you define the work center as an aggregate resource by unit, the system uses the capacity units to represent the number of units that can be produced on that work center in an entire bucket (assuming a calendar of 24 hours per day, seven days per week, during the entire bucket).

For example, suppose that you define a work center as an aggregate resource by unit with weekly buckets. If this resource has capacity units of 100 with an effective date of April 10, 2005, then, beginning on April 10, 2005, PeopleSoft Supply Planning treats this work center as being capable of producing 100 units per week (based on a calendar of 24 hours per day, seven days per week). The actual available capacity for this work center is then calculated by factoring in the actual production calendar during each weekly bucket. If the work center has 40 hours of available calendar time in a weekly bucket, then the available capacity for the bucket, based on a capacity unit of 100, would be $(100 \text{ units} \times 40 \text{ hours per week}) \div (24 \text{ hours per day} \times 7 \text{ days per week}) = 24 \text{ units}$. PeopleSoft Supply Planning uses these

capacity units to determine the work center's available capacity until the next capacity multiplier becomes effective.

Define Work Center - Conv Code (conversion code) Page

Use the Define Work Center - Conv Code (conversion code) page (EN_WC_CONCODE) to associate conversion codes with the corresponding labor and machine rates for the work center.

Navigation:

Manufacturing Definitions > Resources and Routings > Tasks and Work Centers > Define Work Centers > Define Work Center > Conv Code

This example illustrates the fields and controls on the Define Work Center - Conv Code page. You can find definitions for the fields and controls later on this page.

The screenshot shows the 'Define Work Center - Conv Code' page. At the top, there are navigation tabs: 'Define Work Center', 'Resources', 'Planning Opts', 'Conv Code' (selected), and 'Conv Ovhd Codes'. Below the tabs, the 'Business Unit' is 'US008' and the 'Work Center' is 'BR-ASSY Brake Assembly Work Center'. A 'Conversion Code' input field contains '4402' with a search icon, and an 'Assembler' field is empty. Below this is a table titled 'Conversion Rates' with a toolbar containing 'Personalize', 'Find', 'View All', and pagination controls 'First 1-5 of 8 Last'. The table has the following data:

Conversion Rate Type	Rate	Per	Cost Elmnt	Short Description
Labor Setup Rate	9.5000	Hour	300	Set Up Lab
Labor Fixed Run Rate	9.0000	Hour	301	Run Labor
Labor Run Rate	0.1500	Unit	301	Run Labor
Labor Post Prod Rate	5.5000	Hour	302	Post Prod
Machine Setup Rate	8.8500	Hour	400	Set Up Mac

Enter the conversion code that you want to associate with the work center.

Conversion Codes

The system copies conversion codes and their associated labor, machine, and overhead rates and costs into the item's routing when you assign the work center to a routing operation. The system uses the conversion codes to calculate the cost of the operation using the work center. Conversion costs are optional, but if you define them, the system can calculate the labor, machine, and overhead costs associated with manufactured items during cost roll-ups. When the routing is copied, the system uses PeopleSoft Manufacturing costs to calculate the earned labor, machine, and overhead costs that are added to the WIP inventory value when operation or end item completions are recorded.

Conversion Rates

The system displays the conversion rates from the Costing Conversion Rates page. The rates displayed are from the frozen conversion rate and costs that were updated during the last cost update and revaluation. When production costs are updated using a selected cost type and version, the system copies the conversion rates and conversion overhead rates—which are used to calculate the item cost—into a frozen conversion rate record. The system uses those frozen rates to calculate earned labor, machine, and overhead costs when end items are completed at operations or to stock.

Additionally, the system uses the rates to calculate the cost of end items scrapped during manufacturing. You must have a labor or machine rate or cost for each costing operation time type specified on the routing. For example, suppose that you enter a costing labor setup time on the routing. There must be a corresponding labor setup rate per hour for the system to calculate the operation cost and include it in the item's cost.

Related Links

“Understanding the Manufacturing Standard Cost Foundation” (PeopleSoft Cost Management)

Define Work Center - Conv Ovhd Codes (conversion overhead codes) Page

Use the Define Work Center - Conv Ovhd Codes (conversion overhead codes) page (EN_WC_CONOHCODE) to associate work center conversion overhead codes.

Navigation:

Manufacturing Definitions > Resources and Routings > Tasks and Work Centers > Define Work Centers > Define Work Center > Conv Ovhd Codes

This example illustrates the fields and controls on the Define Work Center - Conv Ovhd Codes page. You can find definitions for the fields and controls later on this page.

Ovhd	Description	Type	Ovhd Rate	Ovhd %	Cost Elmnt	Description
6501	Assembly	% of Labor Amt		55.0	500	Ovhd - Lab
6504	Depreciation	Amt Per Mach Hr	3.8500		501	Ovhd - Mac
6505	Administration	Per Unit Amt	0.6500		502	Ovhd per U

Enter the overhead code that you want to associate with the work center. The system displays the overhead rates from the Conversion Ovhd Codes page. The rates appear from the frozen conversion overhead rates and costs that were updated during the last cost update and revaluation. When production costs are updated using a selected cost type and version, the system copies the conversion rates and conversion overhead rates—which are used to calculate the item costs—into a frozen conversion rate record. The system uses those frozen rates to calculate earned labor, machine, and overhead costs when end items are completed at operations or to stock. You can associate up to four codes with a work center.

Note: The system copies the overhead rates and costs into the item's routing when you assign the work center to a routing operation. The system uses these codes to calculate the cost of the operation that uses the work center.

Related Links

“Understanding the Manufacturing Standard Cost Foundation” (PeopleSoft Cost Management)

Creating Work Center Groups

To create and maintain work center groups, use the Work Center Groups (EN_WC_GRP) component.

PeopleSoft Manufacturing enables you to define work center groups. That way, in PeopleSoft Supply Planning you can analyze aggregate capacity and detail resource usage for a subset of work centers contained in a planning instance.

To create a work center group, all work centers must share the same:

- Allocation strategy
- Resource class
- Bucket size

Page Used to Create Work Center Groups

<i>Page Name</i>	<i>Definition Name</i>	<i>Usage</i>
<u>Work Center Groups Page</u>	EN_WC_GRP_PG	Define work center groups.

Work Center Groups Page

Use the Work Center Groups page (EN_WC_GRP_PG) to define work center groups.

Navigation:

Manufacturing Definitions > Resources and Routings > Tasks and Work Centers > Define Work Center Groups

This example illustrates the fields and controls on the Work Center Groups page. You can find definitions for the fields and controls later on this page.

To define a work center group:

1. Enter a description of the new work center group.
2. Add the work centers to the group.

3. After you've added all the work centers, select the common allocation strategy, resource class, and planning bucket size.
4. Click **Save** to create the work center group.

Viewing Work Center Where-Used Data

Using the Review Work Center Where Used component, you can view the tasks, routings, and production that are associated with a selected work center. On all pages in this component, you can control the data and pages that you see by changing the **Search** field selection. Initially, the page automatically displays the choice that mirrors the page; for example, the value is initially *Only Tasks* for the Work Centers Used on Tasks page. You can change this to *Search All* or to search for *Only Tasks*, *Only Routings*, or *Only Production*.

If you select *Select All* after entering the business unit and work center, the system populates all pages in this group with data. If you select only the default, the system populates only the current page with data, after you click the **Search** button.

If you select something other than the default or *Search All*, you access the page that corresponds with your choice. For example, if you are on the Work Centers Used on Tasks page and you select *Only Routings*, you access the Work Centers Used on Routings page. Then, click the **Search** button to view the routings that are associated with a specific work center. You can change the selected options, which appear by default from the previous page, before you click **Search**.

This section discusses how to:

- View work centers used on tasks.
- View work centers used on routings.
- View work centers used in production.

Pages Used to View Work Center Where-Used Data

Page Name	Definition Name	Usage
<u>Used on Tasks inquiry Page</u>	EN_WC_WHERE_TASK	View tasks associated with a specific work center.
Work Center Where Used - Used on Routings (inquiry) Page	EN_WC_WHERE_RTG	View routings whose operations use a specific work center.
<u>Work Center Where Used - Used in Production Page</u>	EN_WC_WHERE_PRD	View production IDs or production schedules that use a specific work center.
Work Centers Where Used Report Page	RUN_ENS1006	Generate the Work Centers Where Used report (ENS1006).

Used on Tasks inquiry Page

Use the Used on Tasks inquiry page (EN_WC_WHERE_TASK) to view tasks associated with a specific work center.

Navigation:

Manufacturing Definitions > Resources and Routings > Tasks and Work Centers > Review Work Center Where Used > Used on Tasks

Select the **Subcontracted** check box if the task is a subcontracted operation.

Select the **Count Point** check box if the operation step is a count point. Count points enable you to record assembly completion information at preset operations. The default for this field comes from the Define Task - Definition page or the Routing Definition - Summary page.

Used on Routings inquiry Page

Use the Used on Routings inquiry page (EN_WC_WHERE_RTG) to view routings whose operations use a specific work center.

Navigation:

Manufacturing Definitions > Resources and Routings > Tasks and Work Centers > Review Work Center Where Used > Used on Routings

Field or Control	Description
Rtg State (routing state)	Values are: <ul style="list-style-type: none"> • <i>PR</i> (production) • <i>EN</i> (engineering)
Routing Types	Values are: <ul style="list-style-type: none"> • <i>PR</i> (production) • <i>TR</i> (teardown) • <i>RW</i> (rework)
Routing	Indicates whether this routing is the primary (routing code <i>1</i>) or an alternate routing (routing codes <i>2-99</i>) for the routing type
Op Seq (operation sequence)	Indicates the operation step that uses the work center.

Work Center Where Used - Used in Production Page

Use the Work Center Where Used - Used in Production page (EN_WC_WHERE_PRD) to view production IDs or production schedules that use a specific work center.

Navigation:

Manufacturing Definitions > Resources and Routings > Tasks and Work Centers > Review Work Center Where Used > Used in Production

The system displays all production that uses the work center. It segregates production information by those items in a production area—using production IDs and the items that are managed by production schedules. In the case of production IDs, it displays the production IDs that have an operation that uses the work center. For all other production, the system displays the production area and the item ID in which it is produced. In both cases, it displays the operation sequence along with the operation's status, start date, start time, due date, and due time.

Related Links

[Define Routings - Summary Page](#)

Copying Work Centers

Rather than entering new work centers from scratch, you can copy a work center and then make changes. Additionally, if another business unit's work centers have similar attributes, you can copy data from one business unit to another and then change the information for the specified business unit.

This section discusses about Copy Work Centers:

Pages Used to Copy Work Centers

<i>Page Name</i>	<i>Definition Name</i>	<i>Usage</i>
Copy Work Centers - Work Centers Page	EN_WC_COPY	Copy a range of work centers, optionally including associated resources and text.
Copy Work Centers - Work Center WIP Locations Page	EN_WC_COPY_LOC	Copy both owned and non-owned work center WIP locations.

Copy Work Centers - Work Centers Page

Use the Copy Work Centers - Work Centers page (EN_WC_COPY) to copy a range of work centers, optionally including associated resources and text.

Navigation:

Manufacturing Definitions > Resources and Routings > Tasks and Work Centers > Copy Work Centers > Work Centers

This example illustrates the fields and controls on the Copy Work Centers - Work Centers page. You can find definitions for the fields and controls later on this page.

The screenshot shows the 'Copy Work Centers - Work Centers' page. At the top, there are tabs for 'Work Centers' and 'Work Center WIP Locations'. Below the tabs, there are input fields for '*Unit:' (US008), 'From Work Center:' (BR-ASSY), and '*To Work Center:' (FI-ASSY). A 'Search' button is located to the right of the 'To Work Center' field. Below these fields is the 'Target Defaults' section, which includes 'Default BU:' (US008), 'Default WC:' (Source WC), and checkboxes for 'Copy Resrc', 'Copy Att', 'Copy Text', 'Copy Cap Mult', and 'Overwrite WC'. At the bottom is the 'Copy Attributes' table, which lists the source work centers and their attributes.

Copy WC	Work Center	Description	Copy Resrc	Copy Att	Copy Text	Copy Cap Mult	Target BU	Target Work Center	Overwrite
<input checked="" type="checkbox"/>	BR-ASSY	Brake Assembly Work Center	<input checked="" type="checkbox"/>	<input checked="" type="checkbox"/>	<input checked="" type="checkbox"/>	<input checked="" type="checkbox"/>	US008	BR-ASSY	<input type="checkbox"/>
<input checked="" type="checkbox"/>	FI-ASSY	Final Assembly Work Center	<input checked="" type="checkbox"/>	<input checked="" type="checkbox"/>	<input checked="" type="checkbox"/>	<input checked="" type="checkbox"/>	US008	FI-ASSY	<input type="checkbox"/>

Target Defaults

Field or Control	Description
Default BU (default business unit)	Select the default business unit. If you are copying work centers within the same business unit, you can accept the default business unit. If you are copying to another business unit, select the business unit to which you want to copy as the default business unit.
Default WC (default work center)	Select <i>Source WC</i> (source work center) or <i>Leave Blank</i> . You can copy a single work center or a range of work centers. If you select <i>Source WC</i> , the system displays the source work center codes in the Target Work Center field under Copy Attributes . If you select <i>Leave Blank</i> , the Target Work Center field is blank. You can enter a different work center code in this field.
Search	Click to retrieve the selected information.

Copy Attributes

You can copy the resources, text, and associated attachments from the source work center to the target work center. You can make the default that you want to overwrite an existing target work center overwrite work center with information from the source work center.

Field or Control	Description
Copy Cap Mult (copy capacity multiplier)	When you select this check box, the system creates a default record with an effective date of 01/01/1900 and a capacity multiplier of 1.0 for the new target work center.
Copy Resrc (copy resources)	If you select this check box, the system copies all of the resources in the source work center to the target work center, along with the resource priorities.

You can change the selections on an individual basis, including deselecting the **Copy WC** check box, if you decide not to copy the original work center.

If you select *Leave Blank* as the default work center in the page header, enter the work center codes for the target business unit. If the target work center already exists in the target business unit, and you select the **Overwrite** check box, the system deletes all existing target work center data and replaces it with the source work center data.

If the WIP inventory locations specified on the source work center do not exist in the target business unit—or if you are using different levels of locations in the two business units—enter the WIP locations for the target work centers on the Work Center WIP Locations page.

Note: If you copy the resource information along with the work center, the resources must already exist in the target business unit. If they do not exist, the system displays an error message and does not copy the work center.

Copy Work Centers - Work Center WIP Locations Page

Use the Copy Work Centers - Work Center WIP Locations page (EN_WC_COPY_LOC) to copy both owned and non-owned work center WIP locations.

Navigation:

Manufacturing Definitions > Resources and Routings > Tasks and Work Centers > Copy Work Centers > Work Center WIP Locations

This example illustrates the fields and controls on the Copy Work Centers - Work Center WIP Locations page. You can find definitions for the fields and controls later on this page.

WIP Locations		Personalize Find View All 1-2 of 2 First Last										
Target BU	Target Work Center	Owned Area	Owned Lev 1	Owned Lev 2	Owned Lev 3	Owned Lev 4	Non-Owned Area	Non-Owned Lev 1	Non-Owned Lev 2	Non-Owned Lev 3	Non-Owned Lev 4	
US008	BR-ASSY	SA	AIS1	ROW	BIN1		NOWN	BIN				
US008	FI-ASSY	FA	AIS1	ROW			NOWN	BIN				

<i>Field or Control</i>	<i>Description</i>
Owned Area and Non-Owned Area	<p>Enter both the owned and the non-owned inventory storage areas. Specify all inventory locations if the target business unit is different from the source business unit.</p> <p>The system displays the number of storage levels, such as Lev 1 (level 1), Lev 2 (level 2), Lev 3 (level 3), and Lev 4 (level 4), defined for each storage area.</p>
Save	The copy is completed when you click Save .

Related Links

“Understanding Inventory Material Storage Structures” (PeopleSoft Inventory)

Chapter 13

Maintaining Tasks

Understanding Tasks

Tasks are jobs that can be performed within a manufacturing facility. When defining a task, you can set up default data, such as times and rates, that the system copies to an item's routing when you select the task for a given operation. Multiple items can reference the same task, or you can set up unique tasks for each item.

You must define work centers before defining tasks. Before setting up tasks, you can define resources (crews, machines, and tools), and associate them with work centers.

To define conversion codes by task (as opposed to by work center) set the business unit rate maintenance to *By Task* in the **Rate Maintenance/Defaulting** group box on the MFG Business Unit Options page. You define conversion codes and their associated labor, machine, and overhead rates or costs within PeopleSoft Cost Management. You can assign a conversion code and up to four conversion overhead codes to the task.

Related Links

“Understanding the Manufacturing Standard Cost Foundation” (PeopleSoft Cost Management)

Common Elements Used in Tasks

<i>Field or Control</i>	<i>Description</i>
Task Code	Displays a unique identifier for the specified task.
Work Center	Displays a unique identifier for the specified work center.
 (attachments button)	<p>Click the Attachments button to launch the multimedia object attached to the task.</p> <ul style="list-style-type: none">You can enter a set of planning times and rates. Click the Planning to Costing Rate Copy button to have the system the same set of times and rates for costing.You can add a set of costing times and rates. Click the Costing to Planning Rate Copy button to have to system add the same set of costing times and rates for planning.

Defining and Maintaining Tasks

To define and maintain tasks, use the Task Definition (TASKS1) component.

You can create and maintain, by business unit, the master list of jobs or tasks that can be performed in the manufacturing process. You can also define the tasks' intensity and associated work centers, resources, operation times, conversion codes, attachments, and text information. You can associate multiple tasks with the same work center.

The use of tasks is optional, but it reduces duplication of maintenance within routings. If you perform the same task on multiple items, define the task only once and then reference that task on each item's routing. The system copies the associated task information into the item's routing. At the routing level, you can change any attribute of the task that is specific to the item without affecting the task definition.

If each item requires unique processes or operations, you do not have to define task information. However, you do need to define the work center, resources, times, and conversion codes on the routing for each item.

When you add a new task or when you change any attribute in an existing task, the system optionally sends the Task Change workflow notification to the selected roles that you've defined, such as an engineering manager or cost accountant.

This section discusses how to:

1. Define task attributes.
2. (Optional) Define task resources.
3. Define task operation times.
4. (Optional) Define task conversion codes.
5. View task where-used data.

Pages Used to Define and Maintain Tasks

Page Name	Definition Name	Usage
Define Task - Definition Page	EN_TASKS	Define task information such as the time required to complete the task, the resources used for the task, and the task intensity.
Text Page	EN_TASK_TXT	Enter text about a task. Use this page to enter up to 254 characters of text. Use the Attachments page for larger blocks of text. Define Task - Definition Page

Page Name	Definition Name	Usage
Attachments Page	EN_TASK_ATT	Specify task attachments. Define Task - Definition Page
Define Task - Resources Page	EN_TASK_RESOURCE	(Optional) Define task resources.
Define Task - Times Page	EN_TASK_TIME	Define task operation times and run rates.
Define Task - Conversion Code Page	EN_TASK_CONCODE	(Optional) Define conversion codes associated with the labor and machine rates for a task.
Conversion Overhead Code Page	EN_TASK_CONOHCODE	(Optional) Define task conversion overhead codes. You can select up to four overhead codes. The system displays data from the current production overhead rates.
Tasks Where Used - Used on Routings	EN_TASK_WHERE_RTG	View all routings on which the task is specified.
Tasks Where Used - Used in Production	EN_TASK_WHERE_PRD	View all production that is associated with a specific task.
Tasks Where Used Page	RUN_ENS1006B	View the routings and production associated with either a selected task or a range of tasks within a particular business unit.

Related Links

[Your Enterprise Data Flow](#)

[Delivered Workflows for PeopleSoft Manufacturing](#)

Define Task - Definition Page

Use the Define Task - Definition page (EN_TASKS) to define task information such as the time required to complete the task, the resources used for the task, and the task intensity.

Navigation:

Manufacturing Definitions > Resources and Routings > Tasks and Work Centers > Define Tasks > Define Task > Definition

This example illustrates the fields and controls on the Define Task - Definition page. You can find definitions for the fields and controls later on this page.

Define Task		Resources	Times	Conversion Code	Conversion Qvhd Codes
Definition	Text	Attachments			
Business Unit		US008			
Task Code		SUB-1			
Description		<input type="text" value="Subcontracted Painting"/>			
Short Description		<input type="text" value="Sub Paint"/>			
*Work Center		<input type="text" value="SUB-1"/>		Paint	
*Intensity		<input type="text" value="Labor Time"/>			
Count Point Control		Planning Defaults			
<input type="checkbox"/> Count Point		<input type="checkbox"/> Continuous Scheduling			
		<input type="checkbox"/> Ignore Capacity			
Subcontracting					
<input checked="" type="checkbox"/> Subcontracted					
Supplier ID		<input type="text" value="SCM0000004"/>			
Subcontracted Item		<input type="text"/>		Std UOM	

Before defining routings, you can define a master dictionary of tasks or jobs that can be performed at work centers.

After entering the business unit and task code, associate the task with a work center. You can associate multiple tasks with the same work center, but tasks can only take place in one work center.

Field or Control	Description
Intensity	<p>Select to determine the basis of your scheduling. You can base the start and end date of the operation on the operation's labor time (if it is labor intensive) or machine time (if it is machine intensive). Alternately, you can base the start and end date on the longer of the two times or on the sum of the labor time and the machine time (that is, the cumulative time).</p> <hr/> <p>Note: If you define a task as subcontracted, the system sets the intensity to <i>Labor Time</i>.</p> <hr/>

<i>Field or Control</i>	<i>Description</i>
Count Point	<p>Select to make the task a count point operation. A count point indicates the operations on a routing that record completions and scrap. You can define count points on the Define Routings - Summary page.</p> <hr/> <p>Note: Count points are optional and are used on only production IDs.</p> <hr/>
Planning Defaults	<p>Select either or both of these options:</p> <ul style="list-style-type: none"> • Continuous Scheduling: Select to complete the corresponding operation in a single run of continuous valid calendar time, with no down time. • Ignore Capacity: Select to prevent PeopleSoft Supply Planning solvers from checking the corresponding operation for capacity violations.

Note: If you change a task by using one of these pages and the task is already associated with a routing operation, it does not change the routing information. Go to the Define Routings - Summary page to change the routing.

Subcontracting

<i>Field or Control</i>	<i>Description</i>
Subcontracted	<p>Select to specify a task this is performed by an outside subcontractor rather than in house. PeopleSoft Purchasing uses this information when creating subcontracted purchase orders.</p> <p>If you select this check box, the Supplier and Subcontracted Item fields appear.</p>
Supplier	<p>(optional) Select the supplier who will provide subcontracted services for this task. PeopleSoft Purchasing uses this information when creating subcontracted purchase orders.</p>

Field or Control	Description
Subcontracted Item	<p>(optional) Select the subcontracted item. If you select the subcontracted item and if you are using PeopleSoft Purchasing, then PeopleSoft Purchasing will generate a subcontracted purchase order for this specific subcontracted item.</p> <hr/> <p>Note: Subcontracted items are defined at a SetID level.</p> <hr/> <p>See “Defining Items at the SetID Level” (PeopleSoft Managing Items).</p> <p>See Understanding Subcontracting Using PeopleSoft Manufacturing.</p>

Related Links

[Define Routings - Summary Page](#)

[Recording End Item Completions Using Count Points](#)

Define Task - Resources Page

Use the Define Task - Resources page (EN_TASK_RESOURCE) to (Optional) Define task resources.

Navigation:

Manufacturing Definitions > Resources and Routings > Tasks and Work Centers > Define Tasks > Define Task > Resources

This example illustrates the fields and controls on the Define Task - Resources page. You can find definitions for the fields and controls later on this page.

Resource Defaults and Resources Used on Tasks

The system copies the resource defaults, as well as the information from the **Resources Used on Tasks** field associated with the work center into the task information.

Field or Control	Description
Resource Type and Crew/Machine/Tool	Edit resources (crews, machines, and tools) by selecting a resource type and the specific crew, machine, and tool, provided that you have already associated the resource with the task's work center. For example, on the Work Center pages, you can specify primary and alternate machines for the work center. On the Define Task - Resources page, you can change those selections for the particular task.
Qty Used (quantity used)	When you select a <i>Primary</i> or <i>Alternate</i> tool as a resource type, the quantity used field becomes available for entry. Enter the tool quantity required to perform the task. This field is for informational purposes only.
Priority	<p>You can manually specify a priority for the task resource. The priority is an integer ranging from 1 to 999. The primary resource for a tool, crew, and machine automatically changes to a priority of 10. Other resources of like type automatically change to a priority of 20.</p> <p>Using the priority factor, choose between a crew and a machine, irrespective of their resource type. The priority appears by default on the routing.</p>

Note: Only one primary crew and one primary machine can be associated with the task. You can, however, have unlimited primary tools and alternate crews, machines and tools.

Note: You cannot associate crew and machine resources with subcontracted tasks.

Define Task - Times Page

Use the Define Task - Times page (EN_TASK_TIME) to define task operation times and run rates.

Navigation:

Manufacturing Definitions > Resources and Routings > Tasks and Work Centers > Define Tasks > Define Task > Times

This example illustrates the fields and controls on the Define Task - Times page. You can find definitions for the fields and controls later on this page.

Task times are divided into labor and machine setup, run, fixed run, and post production. Additionally, you can have separate sets of times and run rates for planning and costing purposes. You can define in-transit and queue time for planning purposes only. When defining time and run rates, define only the types that apply to the task.

Setting Schedule Options

<i>Field or Control</i>	<i>Description</i>
Simultaneous Setup and Queue	Select if setup for an operation can occur during the defined queue period. If this check box is selected, the system uses the longer of the two times when determining the lead time of an operation. When you associate a task with a routing operation, this option is not valid if the task is the first operation on the routing.
	The function of the Planning to Costing Rate Copy and the Costing to Planning Rate Copy buttons depends on existing planning or costing values on the page.

Note: If you are using PeopleSoft Supply Planning, you cannot select the **Simultaneous Setup and Queue** option.

Setting Operation Times and Rates

In the **Operation Times** group box, define the manufacturing times or rates:

Field or Control	Description
Setup	<p>This is the amount of time required to prepare an item, machine, or work center for production. This might involve calibration of a machine or running samples before the start of production. Express setup time in minutes, hours, or days.</p> <p>When the time is expressed in days, the system determines the number of operational hours in a day by using the average daily hours for the work center assigned to the task. When determining an operation's lead time, the scheduling function uses the setup time and does not factor in the number of units that must be processed. You can also specify that setup can be done during a work center's queue time or that operation setup can take place anytime after the start of production, except at the first operation.</p>
Run	<p>This is the amount of time necessary to process one unit, with the rate expressed in minutes, hours, or days. Alternatively, the number of units that can be processed in one time period, with the rate expressed in units per minute, units per hour, or units per day. When determining the lead time of an operation, the scheduling function calculates the total run time by factoring in the number of units to be produced.</p>
Fixed Run	<p>This is the amount of time necessary to complete the task, regardless of the number of units processed. For example, if it takes 24 hours to burn in a board, and the process must run for 24 hours if it's burning in 1 board or 10 boards, you can express this time as fixed run. Fixed run time is added to the total lead time of the operation. You can express it in minutes, hours, or days.</p>
Post Production	<p>This is the amount of time required to clean up, flush, or break down a machine, a work center or an area, once production has been completed. The system does not include post-production time in the operation lead time calculation because it is assumed that this occurs when the units have moved on to the next operation. The system includes it in the item's cost. You can express post-production time in minutes, hours, or days.</p>
Queue	<p>Used in operation scheduling, this is the amount of time that units must wait at an operation before setup or processing can begin. You cannot define queue time for the first operation.</p> <p>For subsequent operations, however, you can define a queue time and whether or not setup can occur during the queue time. You can express queue time in minutes, hours, or days. The system does not include queue time in the operation's cost nor is it considered in PeopleSoft Supply Planning.</p>

Field or Control	Description
Intransit	Used in operation scheduling, this is the amount of time required to transport completed units from one operation to the next. Express in-transit time in minutes, hours, or days. In-transit time is not included in the operation's cost nor is it considered in PeopleSoft Supply Planning.

When setting up the task times and rates, you can designate a set of times and rates for planning purposes and a set of times and rates for costing purposes. You do not need to include all the planning times for scheduling the operation or task, nor do you need to include all the costing times in the item's cost. Simply select the time types that are appropriate for the task. The system displays this data on the Routing Operations - Times page when you select the task code that you want to associate with the operation sequence.

Note: If you define a task as subcontracted, you can only maintain queue, in-transit, and labor times.

You can make changes to the task times on an item-by-item basis on the Routing Operations - Times page without affecting the task master data. Conversely, if you change task information on the Task Times page after the task has been assigned to a routing, the item's routing information is not automatically changed.

Field or Control	Description
Op Time (operation time) and Op Rate (operation rate)	After selecting the operation type, enter an operation time or operation rate.

Field or Control	Description
Time/Rate Unit	<p>If you enter an operation time, then the values are:</p> <ul style="list-style-type: none"> • <i>Days</i> • <i>Hours</i> • <i>Minutes</i> <p>For example, if you enter 5 in the Op Time field and <i>Days</i> in the Time/Rate Unit field, one unit would be completed every five days for the operation. You express setup, fixed run, post-production, queue, and in-transit times in terms of operation times. You can define a run in terms of operation time or a run rate.</p> <p>If you enter an operation rate, then the values are:</p> <ul style="list-style-type: none"> • <i>Units/Day</i> • <i>Units/Hour</i> • <i>Units/Minute</i> <p>For example, suppose that you enter 3 in the Op Rate field and <i>Units/Day</i> in the Time/Rate Unit field. Then, three units are completed every day for the operation. Use only operation rates to define run times.</p>

Note: If a task is already linked to a routing, and you change any times and rates for the task with this page, the system does not update the routing data. If you want the data to be identical, make the change using the Routing Time page.

Including Setup

You can only select the **Inc. Setup** (include setup) check box for the *Planning Labor Setup* and *Planning Machine Setup* operation types. In all other cases, the **Inc. Setup** check box is deselected and is unavailable for selection. If you do not select include setup, setup can begin before any production units arrive at the work center. Setup can occur at any time after the start of production, and the system does not include it as part of the item's lead time, except at the first operation. If you include setup, the setup time is factored into the task or operation's lead time. The system always includes setup in the lead time calculation of the first operation, if setup is specified, regardless of the check box setting.

PeopleSoft Supply Planning Considerations

If you are using PeopleSoft Supply Planning, be aware that:

- If, in the item planning attributes, you've elected to maintain rates based on routings and resources as opposed to a lead time, then you must define labor or machine planning times (such as setup, run, or fixed run).

Do this so that PeopleSoft Supply Planning can schedule operations and determine work center or resource capacity.

- PeopleSoft Supply Planning does not consider labor or machine post-production time as a requirement on the work center or the work centers resources.
- PeopleSoft Supply Planning does not consider queue and in-transit times, even if you have specified them for the task.

Costing Considerations

To calculate costs for a given item, operation, and time type, you must have a corresponding costing rate type defined for a given cost version. For example, if you have a costing fixed run time of five hours defined on the task here, you should define a fixed run conversion rate (for example, 100.00 USD per hour) on the Costing Conversion Rates page.

If you intend to cost the operation using a fixed amount per unit, as opposed to a rate per hour, you must include a corresponding costing operation time type. The costing operation time can represent the amount of time to complete the task, and the system uses it to calculate earned hours. However, the system uses the amount per unit in calculating the cost, regardless of the time specified. If you do not specify a costing time, the system does not include the per unit cost, even if there's a rate defined for the code assigned to the task.

Define Task - Conversion Code Page

Use the Define Task - Conversion Code page (EN_TASK_CONCODE) to (Optional) Define conversion codes associated with the labor and machine rates for a task.

Navigation:

Manufacturing Definitions > Resources and Routings > Tasks and Work Centers > Define Tasks > Define Task > Conversion Code

Conversion costs are optional, but you define them so the system can calculate labor, machine, and overhead costs that are associated with manufactured items during cost roll-ups. The system uses these costs within PeopleSoft Manufacturing to calculate earned labor, machine, and overhead costs that are added to work in process inventory value when operation or assembly completions are recorded.

After you enter the task's conversion code, the system displays the conversion rate type, as well as labor and machine data from the current production rates.

The rates that appear are from the frozen conversion rates and costs updated during the last cost update and revaluation.

If the labor or machine rate is in cost per unit, and you want to include the cost in the cost roll-up calculation, select a corresponding costing rate type. For example, suppose that labor run rate is .50 per unit, the task, or ultimately the routing, must have an entry for costing labor run time in order for the .50 to be included in the operation's cost.

Related Links

[Understanding Work Centers](#)

Tasks Where Used Page

Use the Tasks Where Used page (RUN_ENS1006B) to view the routings and production associated with either a selected task or a range of tasks within a particular business unit.

Navigation:

Manufacturing Definitions > Tasks and Work Centers > Tasks Where Used Report

<i>Field or Control</i>	<i>Description</i>
Routing Code	On the routing inquiry, the routing code indicates whether this routing is the primary (routing code 1) or alternate (routing codes 2-99) routing for the routing type.
Production Area	On the production inquiry, the system displays all production on which the task is performed. It segregates the production information by those items in a production area using production IDs and those items that are managed by production schedules.
Production ID	In the case of production ID, it displays the production IDs that have an operation that uses the task. For all other production, the system displays the item and the production area in which it is produced. In both cases, it displays the operation sequence, along with the operation's start time and date and due date and time.

Related Links

[Understanding Work Centers](#)

Copying Tasks

This section discusses how to copy tasks and associated attributes.

Page Used to Copy Tasks

<i>Page Name</i>	<i>Definition Name</i>	<i>Usage</i>
Copy Tasks Page	EN_TASK_COPY	Copy a range of tasks, including associated times, text, and resources. If another business unit's tasks have similar attributes, you can copy data from one business unit to another and then change the information for the specific business unit.

Copy Tasks Page

Use the Copy Tasks page (EN_TASK_COPY) to copy a range of tasks, including associated times, text, and resources.

If another business unit's tasks have similar attributes, you can copy data from one business unit to another and then change the information for the specific business unit.

Navigation:

Manufacturing Definitions > Resources and Routings > Tasks and Work Centers > Copy Tasks > Copy Tasks

This example illustrates the fields and controls on the Copy Tasks page. You can find definitions for the fields and controls later on this page.

The screenshot shows the 'Copy Tasks' interface. At the top, there are search fields for '*Unit' (US008), 'From Task Code' (BRAKE - Brake Assembly), and '*To Task Code' (WHEEL - Wheel Assembly), with a 'Search' button. Below this is the 'Target Defaults' section, which includes 'Default BU' (US008), 'Default Task' (Source Task), and checkboxes for 'Copy Resrc', 'Copy Att', 'Copy Text', 'Copy Times', and 'Overwrite Task'. The 'Copy Attributes' section features a table with columns for 'Copy Task', 'Task Code', 'Description', 'Copy Times', 'Copy Resrc', 'Copy Text', 'Copy Att', 'Work Center', 'Target BU', 'Target Task', and 'O/W'. The table lists three tasks: BRAKE (Brake Assembly), FINAL (Final Assembly), and FORK (Add Fork), each with checkboxes for the copy options and a 'Target Task' field.

You can copy a single task or a range of tasks. After you enter the source information, click the **Search** button to display the task information.

Field or Control	Description
Unit	Select the business unit from which the tasks are copied.
From Task Code and To Task Code	Select the (alphanumeric) range of tasks codes for which you want data copied.
Search	Click to populate the fields in the lower half of the page.
Default BU (default business unit)	The system displays the source business unit as the target business unit. Use this option if you are copying tasks within a business unit. Otherwise, specify the business unit to which the system copies the source information.

Field or Control	Description
Default Task	<p>Values are:</p> <ul style="list-style-type: none"> • <i>Source Task</i>: The system displays the source task codes in the Target Task field in the lower-right part of the page. • <i>Leave Blank</i>: The Target Task field is blank. You can enter a different task code in this field. If you are copying tasks within a business unit, select this option and enter the new task codes.
Field or Control	Description
Copy Times, Resources, Text, and Attachments	<p>You can copy the times, resources, text, and attachments associated with the source task to the target task. If you select Copy Resrc (copy recourses), the system copies all of the resources in the source work center to the target work center, along with the resource priorities.</p> <p>You can change all of these selections on an individual basis on the detail part of the screen, including deselecting the Copy Task check box, if you decide not to copy the individual task after all. You can also change the target business unit.</p>
O/W (overwrite)	Select to make the default overwrite a target task with the information from the source task.
Task Code	<p>If you select <i>Leave Blank</i> as the default task in the page header, enter the task code for the target business unit. If the target task already exists in the target business unit and you select the O/W check box, the system deletes the information from the target task and replaces it with the source task data.</p> <hr/> <p>Note: If you copy resource information along with the task, the resources must already exist in the target business unit. If they do not exist, the system displays an error message and does not copy the task.</p> <hr/>
Save	When you click this button, the copy is complete.

Structuring Routings

Understanding Routings

You can create and maintain routings by using PeopleSoft Manufacturing. Creating a routing includes defining the routing code, operations, scheduling options, routing times, conversion costs, routing text, attachments, and the associated tasks, count points, work centers, and resources. You can specify a routing by business unit for any manufactured or purchased item.

When you add a new routing, or when you change any attribute in an existing routing, the system optionally sends a workflow notification to the selected roles defined by you—such as engineering manager or cost accountant.

You can also maintain routings for consigned items that you manufacture.

If you have enabled PeopleSoft Workflow, when a change is made to a routing, the system uses the Routing Change workflow to notify the manufacturing engineer (or other defined role) that a change has been made to a routing.

Related Links

[Delivered Workflows for PeopleSoft Manufacturing](#)

Understanding Yield by Operation in PeopleSoft Manufacturing

In many manufacturing processes, some parent items (such as subassemblies, primary items, or final assemblies) are lost during manufacturing. This loss manifests itself as assembly scrap, which can result from breakage, poor quality, or nonconformance to specifications. Operation yield enables you to specify the quantity of goods expected to make it through the process. The expected lost can then be incorporated into the cost of the usable end items. Additionally, planning can take into account process yield and increment the demand by the expected loss so that demand is still met once the manufacturing process has been completed. This function enables you to specify a yield percentage on the routing operation step and calculates the additional resources necessary to meet the scheduled quantity with the anticipated yield loss.

The system calculates the quantities required at the beginning of each operation sequence based on the yield percentage. When you create new production, you can enter either the beginning or ending quantities, and the system calculates the other quantity automatically.

Determining Order Quantities Using PeopleSoft Supply Planning

When you use yield by operation and you want to ensure that the demand quantity is met, use an inflated production quantity. This enables the ending production quantity to fulfill the demand should a standard yield loss occur.

Determining Operation Yield Percentages

You can specify a yield percentage at each routing operation by using the Define Routings - Summary page.

Note: You do not have to use yield by operation. If you do not anticipate any yield loss during the production phase, you'll accept the default yield percentage value of 100 percent yield (or accept the default values) at all operation sequences.

Related Links

[Understanding Production IDs and Production Schedules](#)

[Define Routings - Summary Page](#)

Common Elements Used in Routings

<i>Field or Control</i>	<i>Description</i>
Routing Type	<p>Select the type of routing. Options are:</p> <ul style="list-style-type: none"> • <i>Production:</i> This is the default routing type. Production routings are used for standard manufacturing processes. • <i>Rework:</i> Create rework routings when you have a standard rework process. Rework routings list the routing steps that are commonly used for reworking an assembly. • <i>Teardown:</i> Use for breaking down an assembly into its component parts and returning the components back to inventory. Teardown routings can differ from the production routing, but they can use any of the existing tasks or work centers defined for production. Teardown outputs can be produced at any operation. Operations that produce teardown outputs cannot be subcontracted. <hr/> <p>Note: Rework and teardown routings are used with production IDs only.</p>
Cumulative Yield	<p>This display-only field indicates the percentage of beginning quantity for the manufactured end item that is expected at the end of the production process as defined on the item's routing.</p> <p>The cumulative yield is the compounded yield across the entire routing. This yield is applied to determine order quantities,</p>
Op Seq (operation sequence)	<p>Enter a value to sequence operations on a routing. It is advisable to increment operation sequence numbers by a set amount—for example, 5 or 10—in case you need to add operations at a later date.</p>

Prerequisites

Before creating and maintaining routings you must, *at a minimum*:

- Define work centers where jobs or tasks are performed.
- Define conversion codes, if you want to calculate conversion costs.
- Define conversion rates (such as labor, machine, and overhead rates or costs), if you want to calculate conversion costs.

When defining routings, you have several options regarding information that you can associate with a routing. These steps are optional:

1. Define resources.

Resources can be crews (people), machines, or tools. You can associate resources with a work center. If you are scheduling using PeopleSoft Supply Planning, you must define at least one crew or machine for each operation.

2. Define the master list of tasks to be performed in the manufacturing process.

Tasks are useful if the same task is performed when manufacturing several items. You need to define the processing information only once on the task and then assign the task to the routings of those items.

3. Define count points.

Count points are an automated way to predefine when in the item's routing you want to record completions and scrap costs. If an operation is designated as a count point, assembly completions must be recorded at that operation. Material is only consumed—and labor and overhead are only earned—from the previous count point.

Note: Count points can be used only on production IDs.

Related Links

[Understanding Work Centers](#)

“Understanding the Manufacturing Standard Cost Foundation” (PeopleSoft Cost Management)

[Recording End Item Completions Using Count Points](#)

Maintaining Routings

To create and maintain routings, use the Routing Definition (EN_ROUTING) component.

To define file locations, use the File Locations (FILE_LOC) component.

This section discusses how to maintain routings

Pages Used to Maintain Routings

Page Name	Definition Name	Usage
<u>Define Routings - Summary Page</u>	EN_RTG_SUMMARY	Assign item operations and attach tasks and work centers to a routing.
Define Routings - Header: Description	EN_RTG_HEADER	Define header information such as the routing type and code.
Define Routings - Header: Documents	EN_RTG_HEADER_DC	Associate, access, and manage pertinent routing header documents in the embedded document management system. You must have PeopleSoft Engineering installed to access this page.
Define Routings - Header: Attachments	EN_RTG_HEADER_ATT	Attach files to the routing header information.
Define Routings - Operations: Resources	EN_RTG_RESOURCE	Define routing resources.
Define Routings - Operations: Scheduling	EN_RTG_SCHED	Select operation scheduling options for routings.
Define Routings - Operations: Times	EN_RTG_TIME	Define routing operation times and rates for an operation.
Define Routings - Operations: Conv Cost Codes (conversion cost codes)	EN_RTG_CONCOST	Associate routing conversion cost codes with an operation. Conversion rates and costs are associated with each code. The system uses these rates and costs to determine the labor, machine, and overhead cost of the operation.
Define Routings - Operations: Text	EN_RTG_OP_TXT	Attach text to an operation.
Define Routings - Operations: Documents	EN_RTG_OP_DC	Associate, access, and manage pertinent routing operation documents in the embedded document management system. You must have PeopleSoft Engineering installed to access this page.
Define Routings - Operations: Attachments	EN_RTG_OP_ATT	Specify routing operation attachments.

Page Name	Definition Name	Usage
Routing Report	RUN_ENS1001	View the routing information for manufacturing or engineering routings.

Define Routings - Summary Page

Use the Define Routings - Summary page (EN_RTG_SUMMARY) to assign item operations and attach tasks and work centers to a routing.

Navigation:

Manufacturing Definitions > Resources and Routings > Routings > Define Routings > Summary

This example illustrates the fields and controls on the Define Routings - Summary page. You can find definitions for the fields and controls later on this page.

The screenshot shows the 'Define Routings - Summary' page with the following details:

- Business Unit:** US008
- Item ID:** MT2000 (Professional Road Bike, Womans)
- Std UOM:** EA
- Source:** Make
- Routing Code:** 1
- Routing State:** Manufacturing
- Routing Type:** Production
- Cum Yield %:** 100.0000

The 'Operation List' table is as follows:

*Op Seq	Task Code	Description	Sub	Count Point	*Work Center	Description	Yield %		
10	FORK	Add Fork	<input type="checkbox"/>	<input type="checkbox"/>	FI-ASSY	Final Assembly Work Center	100.00	+	-
20	FINAL	Final Assembly	<input type="checkbox"/>	<input type="checkbox"/>	FI-ASSY	Final Assembly Work Center	100.00	+	-
30	INSP	In Process Inspection	<input type="checkbox"/>	<input type="checkbox"/>	INSP	In Process Inspection	100.00	+	-
40	PAINT	Prime and Paint	<input type="checkbox"/>	<input type="checkbox"/>	PAINT01	Painting Work Center 1	100.00	+	-
50	INSP	In Process Inspection	<input type="checkbox"/>	<input type="checkbox"/>	INSP	In Process Inspection	100.00	+	-

The operation sequences defined here correspond to the operation sequences that you specify for components on the item's BOM. If you have not assigned operation sequences to the item's BOM and you want to issue a component to the operation's WIP location, return to the BOM Maintenance component after you have added the item's routing.

Field or Control	Description
Task Code	<p>(Optional) Enter this code to copy to the operation all related task and resource data— including whether the task is subcontracted— work center, queue, setup, run, and post-production time information. If you have not predefined tasks, examine all succeeding pages and links to ensure that you set up the correct data for the designated item operation.</p> <p>If you do not enter a task code, you need to manually enter extensive task data, including work center, routing time, resource, scheduling options, text attachments, and conversion rate code data on the subsequent pages.</p> <hr/> <p>Note: If you change the task code, the system deletes the old task information and copies the associated new task information into the item's routing. After you specify the task on the routing, this page does not reflect changes you make to the task in the Define Tasks component.</p> <hr/>
Sub (subcontracted)	<p>This check box is selected if the task is a subcontracted operation.</p> <p>You can change whether the task is subcontracted on this routing without affecting the default task information.</p>
Work Center	<p>If you enter a task code, the page displays the work center associated with the task.</p> <p>If you haven't entered a task, you must enter a valid work center for the operation.</p> <p>You can change the work center for this task on this routing without affecting the default task information. If you change the work center, the system deletes the resources defined for the old work center and then adds the resources associated with the new work center. Also, if you are maintaining conversion costs by work center, the system adds the new conversion rates and deletes the old rates.</p> <hr/> <p>Note: Changing either task information or the work center after the item's cost has been calculated and updated in PeopleSoft Cost Management can result in process change variances for the item on any production subsequent to the change. These variances continue until the item's cost is recalculated and updated.</p> <hr/>
Yield %	<p>Indicates the percentage of manufacturing items expected at the end of the operation sequence. The default value comes from the routing; you can change the value here.</p>

Field or Control	Description
Count Point	<p>(Optional) Select to define an operation step as an operation count point. Count points can be used only on production IDs. You can predefine the count point operations by selecting the Count Point check box on the Define Task page, the Define Routings page, and the Operation List Maintenance page.</p> <p>By default, this check box shows the count point setting from the Task Definition page.</p> <hr/> <p>Important! If you are using count points, the last operation step and any subcontracted operations must be defined as count points.</p>

Related Links

[Your Enterprise Data Flow](#)

Define Routings - Header: Description Page

Use the Define Routings - Header: Description page (EN_RTG_HEADER) to define header information such as the routing type and code.

Navigation:

Manufacturing Definitions > Resources and Routings > Routings > Define Routings > Header > Description

This example illustrates the fields and controls on the Define Routings - Header: Description page. You can find definitions for the fields and controls later on this page.

The screenshot shows a web interface for defining routing headers. At the top, there are three tabs: 'Summary', 'Header' (which is selected), and 'Operations'. Below the tabs, there are links for 'Description', 'Documents', and 'Attachments'. The main content area displays several fields and controls:

- Business Unit:** US008
- Item ID:** MT2000
- Std UOM:** EA
- Source Make:** Professional Road Bike, Womans
- Cum Yield %:** 100.0000
- Routing Code:** 1
- Routing State:** Manufacturing
- Routing Type:** Production

Below these fields, there are two input boxes: 'Description' with the value 'Pro Road Bike, Wmn' and 'Short Desc' with the value 'Pro Road'. There are two checked checkboxes: 'Copy Routing to Production' and 'Copy Routing to Planning'. A 'Priority' field is set to '1'. At the bottom, there is a large 'Text' area with a small icon in the bottom right corner.

Field or Control	Description
Unit, Item ID, Routing Type, and Routing Code	<p>Enter information about a routing to add or maintain the routing for an owned item.</p> <p>The system reserves a routing code of <i>1</i> for an item's primary production routing and uses it as the default routing for planning and costing (in PeopleSoft Supply Planning, PeopleSoft Cost Management, and PeopleSoft Manufacturing), including production conversion cost calculations. You can specify up to 98 alternate routings for production, rework, or teardown routing types by entering additional routing codes (greater than <i>1</i>) for the same routing type.</p> <hr/> <p>Note: You can add routings only for assembly items that are both owned and approved. Also, you can maintain routings only for those items whose business unit item attribute Used in Manufacturing is set to <i>Yes</i>.</p> <hr/> <p>Although you can add a routing for both manufactured and purchased items, you cannot add a routing for floor stock, planning, expensed, or configured items. If you add a routing for an item that references another item for its routing information, you receive a warning message. The item's own routing is never considered unless you change its reference routing information on the Define Business Unit Item - Manufacturing page.</p> <hr/> <p>Note: When adding a routing for an item with an item status of Hold or Discontinue, you receive a warning message. Similarly, when updating a routing for an item with an item status of Hold or Discontinue, you receive a warning message at save time. However, these warning messages do not prevent you from performing the action.</p>
Routing Code	Enter a value to give the routing a unique numeric identifier.
Copy Routing to Production	<p>Select this check box to copy the routing to operation lists for production IDs or production schedules. This enables you to track operation details and record completions of specified operations.</p> <p>If you do not copy the routing to production, the system still uses the routing to calculate costs and calculate planning start or end order and schedule dates. If a rework routing is specified, the check box is automatically selected and is unavailable for selection.</p>

<i>Field or Control</i>	<i>Description</i>
Copy Routing to Planning	<p>If you use PeopleSoft Supply Planning, select this check box to schedule at the operation level while optimizing resources. This check box is unavailable for rework and teardown routings.</p> <p>However, if a rework or teardown routing has been copied to production for a specific production ID, that routing becomes the operation list used as the production option for the production ID.</p>
Priority	<p>If you use PeopleSoft Supply Planning, enter a routing priority to specify the order in which PeopleSoft Supply Planning uses alternate routings when planning production. The lower the priority number, the higher the priority.</p> <p>Rework and teardown routings have no priority numbers.</p>
MR (master routing)	<p>If the item's routing is a master (or reference) routing currently used by another item, an MR button appears on all the pages in this component. Click this button to display the Master Routing Where Used inquiry page. Use that inquiry to determine whether the changes made to a routing are applicable to all items for which it's a reference routing.</p> <hr/> <p>Note: You receive a warning if you modify an item's routing that is used by another item.</p> <hr/>

Engineering Considerations

<i>Field or Control</i>	<i>Description</i>
ECO	<p>If you are using PeopleSoft Engineering and there are outstanding engineering change orders (ECOs) pending for the item—and you have selected the ECO Pending Alert check box on the ECO Item Status page—the system displays the ECO button next to the assembly Item ID field in this entire component. Click the ECO button to see information about pending ECOs associated with the item.</p>

Related Links

“Defining Master Routings” (PeopleSoft Engineering)

[Defining and Maintaining Revisions](#)

Define Routings - Header: Attachments Page

Use the Define Routings - Header: Attachments page (EN_RTG_HEADER_ATT) to attach files to the routing header information.

Navigation:

Manufacturing Definitions > Resources and Routings > Routings > Define Routings > Header > Attachments

<i>Field or Control</i>	<i>Description</i>
File Ext (file extension)	Select the type of media to attach. <hr/> Note: You must set up file extensions in advance on the File Locations page. <hr/>
Document ID	Enter the file name.
	Click the Attachments button to launch the multimedia object attached to the routing header.

Related Links

“File Locations Page” (PeopleSoft Source to Settle Common Information)

Define Routings - Operations: Resources Page

Use the Define Routings - Operations: Resources page (EN_RTG_RESOURCE) to define routing resources.

Navigation:

Manufacturing Definitions > Resources and Routings > Routings > Define Routings > Operations > Resources

This example illustrates the fields and controls on the Define Routings - Operations: Resources page. You can find definitions for the fields and controls later on this page.

The screenshot displays the 'Define Routings - Operations: Resources' page. At the top, there are tabs for 'Summary', 'Header', and 'Operations'. Below these are various fields for routing details: Business Unit (US008), Item ID (MT2000), Professional Road Bike, Womans, Routing Code (1), Routing State (Manufacturing), Source (Make), Cum Yield % (100.0000), and Routing Type (Production). The 'Operations' section includes fields for *Op Seq (10), Task Code (FORK), *Work Center (FI-ASSY), and Operation Yield % (100.0000). The 'Resources' section is a table with columns for *Resource Type, Crew/Machine/Tool, Description, Status, Qty Used, and Priority. It lists three resources: Primary Crew (ASSY01), Alt Crew (ASSY02), and Primary Machine (FINAL01).

Operations

Field or Control	Description
Op Seq, Task Code, and Work Center	These values appear by default from the Define Routings - Summary page, but they can be changed here.
Continuous Scheduling	Select to indicate that the operation is continuous, cannot be stopped once started, and must be completed in one run.
Crew Size	<p>Specifies the number of people at the work center. This value appears by default from the specified task or, if no task has been specified, from the work center.</p> <p>If you change the crew size after the item's cost has been calculated and updated, the change results in process change variances for the item on any production subsequent to the change. These variances continue until the item's cost is recalculated and updated.</p>
Machine Resources	Specifies the number of machines at the work center. This value appears by default from a specified task or, if no task has been specified, from the work center.
Ignore Capacity	Select to indicate that Planning should not check a work center's available capacity.

Note: Specifying resources on the routing operation is optional. You can delete existing resources if they are not appropriate for use with the manufactured item.

Resources

Field or Control	Description
Resource Type	<p>The resource must have been previously associated with the work center.</p> <p>Select to designate the type of resource. Options are:</p> <ul style="list-style-type: none"> • <i>Primary Crew</i> • <i>Primary Machine</i> • <i>Primary Tool</i> • <i>Alternate Crew</i> • <i>Alternate Machine</i> • <i>Alternate Tool</i> <hr/> <p>Note: You can have only one of each primary resource type. You can have unlimited alternate crews, machines, and tools.</p>
Crew/Machine/Tool	Specify the code for the resource.
Qty Used (quantity used)	If the resource changed or added is a tool, enter the quantity used.
Priority	(Optional) Manually specify a priority for the routing resource. The priority is an integer that ranges from 1 to 999. Using the priority factor, you can choose between a crew and a machine, regardless of the resource types.

Note: You cannot associate crew and machine resources with subcontracted tasks and operations, and you cannot associate resources that have a Pending status with a production routing.

Define Routings - Operations: Scheduling Page

Use the Define Routings - Operations: Scheduling page (EN_RTG_SCHED) to select operation scheduling options for routings.

Navigation:

Manufacturing Definitions > Resources and Routings > Routings > Define Routings > Operations > Scheduling

This example illustrates the fields and controls on the Define Routings - Operations: Scheduling page. You can find definitions for the fields and controls later on this page.

The screenshot displays the 'Operations' tab of the 'Define Routings - Operations: Scheduling' page. It features several sections:

- Resources:** Business Unit (US008), Item ID (MT2000), Professional Road Bike, Womans.
- Scheduling:** Routing Code (1), Routing State (Manufacturing), Routing Type (Production).
- Task Details:** *Op Seq (10), Task Code (FORK), *Work Center (FI-ASSY).
- Intensity:** A dropdown menu set to 'Longest'.
- Operation Overlap:** A dropdown menu set to 'No Overlap'.
- Subcontracting:** A checkbox labeled 'Subcontracted'.

Scheduling

Field or Control	Description
Op Seq, Task Code, and Work Center	These values appear by default from the Define Routings - Summary page, but they can be changed here.
Subcontracted	This option is selected if the operation is being performed by a supplier. You cannot deselect this check box if purchase orders have been created for this outside supplier.
Supplier ID	If the subcontracted supplier was defined at the task level, then the name of the supplier appears in this field. Otherwise, you can select the appropriate supplier for this subcontracted operation.
Subcontracted Item	If this value was defined at the routing level, then the item appears in this field. You can change the value in this field. The subcontracted item will be used on any subcontracted purchase orders that are created for this operation.
Count Point	The check box is selected if the operation sequence is a count point. This display-only field appears by default from the Define Routings - Summary page.

Field or Control	Description
Simultaneous Setup and Queue	<p>Select this check box if setup can occur during the queue time of an operation. If selected, the system uses the longer of the two times when determining production start and end dates.</p> <hr/> <p>Note: You cannot select this check box for the first operation in a routing. You also cannot select it if you are using PeopleSoft Supply Planning.</p> <hr/>
Intensity	<p>Use this field to determine the basis of the scheduling. Base the start and end date of the operation on labor time, machine time, or both. Options are:</p> <ul style="list-style-type: none"> • <i>Labor Time:</i> Use for labor intensive operations. • <i>Machine Time:</i> Use for machine intensive operations. • <i>Longest:</i> Use to base scheduling on the longer of the two times, evaluated for each time type within the operation. • <i>Cumulative:</i> Use to base scheduling on the sum of the machine time and labor time.

Operation Overlap

Field or Control	Description
Op Overlap (operation overlap)	<p>Select to indicate whether a subsequent operation can begin before the completion of the preceding operation. Options are:</p> <ul style="list-style-type: none"> • <i>No Overlap:</i> The subsequent operation does not overlap. • <i>Percentage:</i> The subsequent operation overlaps by a percentage of elapsed run time completed. <p>If you select this option, the Overlap % (overlap percentage) field appears.</p> <ul style="list-style-type: none"> • <i>Send Ahead:</i> The subsequent operation begins when a specified number of units are accumulated or finished. <p>If you select this option, the Send Ahead field appears.</p>

Field or Control	Description
Overlap % (overlap percentage)	<p>An overlap percentage of <i>100</i> means that the next operation can begin setup at the same time as the current operation's start of run. An overlap percentage of <i>5</i> means that 95 percent of the operation run must be completed before the next one can start.</p> <hr/> <p>Note: This value cannot be less than <i>0</i> or more than <i>100</i>, and there can be no overlap on the last routing operation sequence. Do not define operation overlap on an operation before a subcontracted operation because all assemblies and subassemblies must be sent out to the subcontractor as a batch. Because the supplier can send the item back in multiple batches, the system allows, on a subcontracted operation, operation overlap for send-ahead quantity and percentage.</p>
Send Ahead	<p>Specify the number of units that need to be accumulated or finished before they can be sent to the next operation and the next operation can begin. The quantity must be a positive number.</p> <hr/> <p>Important! If an operation has a fixed run rate assigned to it, the preceding operation cannot have a send-ahead quantity because fixed run operations require that the entire quantity is available at the beginning of the run. For example, operation 1 cannot have a send-ahead quantity assigned if operation 2 has a fixed run time.</p> <hr/> <p>Note: For multiple output batch items (where at least one co-product exists), the send-ahead quantity or percentage overlap is specified in terms of the BOM quantity, as defined on the primary item's BOM.</p>

Note: To provide greater flexibility when defining BOMs, PeopleSoft Manufacturing does not require the **Quantity** field to follow the quantity precision rules defined for the item. A warning is issued if you define a decimal quantity value for an item whose quantity precision value is a whole number. For example, if one B0004 component is required to make two assembly A0001s, then when defining the BOM, the quantity per assembly (QPA) for B0004 would be 0.5. If PeopleSoft Manufacturing applied the rounding rules to the QPA, then it would round the QPA for B0004 to 1, and thereby inflate the production costs.

Define Routings - Operations: Times Page

Use the Define Routings - Operations: Times page (EN_RTG_TIME) to define routing operation times and rates for an operation.

Navigation:

Manufacturing Definitions > Resources and Routings > Routings > Define Routings > Operations > Times

This example illustrates the fields and controls on the Define Routings - Operations: Times page. You can find definitions for the fields and controls later on this page.

Operations

You can insert a new operation in the same manner as on the Define Routings - Summary page.

<i>Field or Control</i>	<i>Description</i>
Op Seq, Task Code, and Work Center	<p>These values appear by default from the Define Routings - Summary page, but they can be changed here. You can change the task associated with any added or existing operation.</p> <p>If you have already associated a task code with an operation, and you change the task, the system deletes the existing task information, including work center, resources, task times, and scheduling options and adds the new task information for the specific operation. Also, if you define the conversion rates at the task level, the system deletes the old task rates and adds the new rates.</p> <p>If you change the work center, the system deletes the resources associated with the old work center and adds the new work center's resources. If you maintain conversion rates at the work center level, the system deletes the old rates and adds the new rates.</p>



Operation Times

In the **Operation Times** group box, the times or run rates appear by default from the task information, if defined. You can modify the manufacturing times or rates for fixed run, post production, run, and setup

for the task. Changing the times and run rates here has no effect on the default master task information. If you did not specify a task, you can enter the times necessary to complete this operation.

If you are changing the operation costing times and run rates after the item's cost has been calculated and updated, the change results in process change variances for the item on any production subsequent to the change. These variances continue until the item's cost is recalculated and updated. If you are changing the operation from a regular task to a subcontracted one, you cannot select machine times or rates for the operation.

Field or Control	Description
Type	Specify the type of operation time, and then enter an operation time or rate.
Op Time (operation time)	Enter the operation time.
Time Unit	If you enter an operation time, this field has the following options <i>Days</i> , <i>Hours</i> , and <i>Minutes</i> . For example, if you enter 5 in the Op Time field and <i>Days</i> in the Time Unit field, one unit is completed every five days for the operation. The system determines the number of hours in a day by the work center's average daily hours as defined in the Work Center Definition page.
Op Rate	Enter the operation rate. You can specify operation rates only for planning or costing run times.
Rate Unit	If you enter an operation time, you can select <i>Units/Day</i> , <i>Units/Hour</i> , or <i>Units/Minute</i> . For example, if you enter 3 in the Op Rate field and <i>Units/Day</i> in the Rate Unit field, three units are completed every day for the operation.
Inc Setup (include setup)	Select to include setup in the operation lead time calculation. You can only select this check box for <i>Planning Labor Setup</i> and <i>Planning Machine Setup</i> operation types. If you do not select include setup, setup can begin before any production units arrive at the work center. Setup can occur at any time after the start of production, and the system does not include it as part of the item's lead time, except at the first operation. If you include setup, the setup time is factored into the task or operation's lead time. The system always uses setup in the lead time calculation of the first operation, if setup is specified, regardless of the check box setting.

Field or Control	Description
	Click the Planning to Costing Rate Copy button if you've entered or modified the planning times and want to copy the planning-related types to the costing rates.
	Click the Costing Rate to Planning Copy button if you've entered or modified the costing times and want to copy the costing-related types to the planning rates.

Note: If you are defining routing times for a batch item (a multiple output item with at least one co-product), then both the routing times and rates for costing and planning must relate to the in-process batch item's BOM quantity. The routing times and rates are not related to the individual outputs. For example, if the BOM quantity for item ID 10001 is 1000, and the BOM's primary output quantity for 10001 is 500—this is, for every batch of 1000, you anticipate receiving 500—the routing times and rates must be defined in terms of the 1000 and not 500.

Note: You can change any production times or rates for the task for the specific item routing without affecting the master task information. If you make a change here, and you want to make the task data identical, you need to also make the change in the Task Time page. The reverse is also true. Once you have associated times or rates with an operation, changing the task's master data will not affect this data on this page.

The system allows only these times for subcontracted tasks and operations:

- Queue.
- In-transit.
- Planning and costing labor setup, run, fixed run, and post-production.

You cannot specify machine times for subcontracted tasks and operations.

Costing Considerations

Here are some costing considerations when defining operation times and rates:

- To calculate costs for a given item, operation, or time type, you must have a corresponding costing rate type defined for a particular cost version.

For example, if you have a costing fixed run time of five hours defined on the task, you should also have defined within PeopleSoft Cost Management a fixed run conversion rate (for example, 100.00 per hour) associated with the cost version and conversion code combination.

- If you intend to cost the operation using a fixed amount per unit (as opposed to a rate per hour), you must include a corresponding costing operation time type.

The costing operation time can represent the amount of time to complete the task, and the system uses it to calculate earned hours. However, the system uses the amount per unit in calculating the cost,

regardless of the time specified. If you do not specify a costing time, the system does not include the per-unit cost even if there's a rate defined for the code assigned to the task.

PeopleSoft Supply Planning Considerations

If you are using PeopleSoft Supply Planning, you need to be aware that:

- If, in the item planning attributes, you elected to maintain rates based on routings and resources (as opposed to a lead time), you must define labor or machine planning times (setup, run, or fixed run) in order for PeopleSoft Supply Planning to schedule operations and determine work center or resource capacity.
- PeopleSoft Supply Planning uses labor or machine post-production time as a requirement on the work center or the work centers resources.
- PeopleSoft Supply Planning uses queue and in-transit times, if they are specified for the task.
- If you have indicated that setup is not included for scheduling purposes (that is, setup can begin at any time after the start of production), the system does not use it for capacity planning purposes.

Related Links

[Understanding Tasks](#)

Define Routings - Operations: Conv Cost Codes Page

Use the Define Routings - Operations: Conv Cost Codes page (EN_RTG_CONCOST) to associate routing conversion cost codes with an operation.

Conversion rates and costs are associated with each code. The system uses these rates and costs to determine the labor, machine, and overhead cost of the operation.

Navigation:

Manufacturing Definitions > Resources and Routings > Routings > Define Routings > Operations > Conv Cost Codes

This example illustrates the fields and controls on the Define Routings - Operations: Conv Cost Codes page. You can find definitions for the fields and controls later on this page.

<div style="display: flex; justify-content: space-between;"> Summary Header Operations </div>																																		
Resources	Scheduling	Times	Conv Cost Codes	Text	Documents	Attachments																												
Business Unit	US008		Std UOM	EA	Source	Make																												
Item ID	MT2000				Cum Yield %	100.0000																												
	Professional Road Bike, Womans				Routing Type	Production																												
Routing Code	1	Routing State	Manufacturing																															
<div style="border: 1px solid black; padding: 5px;"> <p>Conversion Cost Codes Find View All First 1 of 5 Last</p> <table style="width: 100%; border-collapse: collapse;"> <tr> <td style="width: 15%;">*Op Seq</td> <td style="width: 35%;">Task Code</td> <td style="width: 15%;">*Work Center</td> <td style="width: 35%;"></td> </tr> <tr> <td>10</td> <td>FORK <input type="text"/></td> <td>FI-ASSY <input type="text"/></td> <td>Final Assembly Work Center</td> </tr> <tr> <td></td> <td> <input type="text" value="4402"/> <input type="text"/> </td> <td>Assembler</td> <td></td> </tr> <tr> <td></td> <td> <input type="text" value="6501"/> <input type="text"/> </td> <td>Assembly</td> <td></td> </tr> <tr> <td></td> <td> <input type="text" value="6505"/> <input type="text"/> </td> <td>Administration</td> <td></td> </tr> <tr> <td></td> <td> <input type="text" value="6506"/> <input type="text"/> </td> <td>Support</td> <td></td> </tr> <tr> <td></td> <td> <input type="text"/> <input type="text"/> </td> <td></td> <td></td> </tr> </table> </div>							*Op Seq	Task Code	*Work Center		10	FORK <input type="text"/>	FI-ASSY <input type="text"/>	Final Assembly Work Center		<input type="text" value="4402"/> <input type="text"/>	Assembler			<input type="text" value="6501"/> <input type="text"/>	Assembly			<input type="text" value="6505"/> <input type="text"/>	Administration			<input type="text" value="6506"/> <input type="text"/>	Support			<input type="text"/> <input type="text"/>		
*Op Seq	Task Code	*Work Center																																
10	FORK <input type="text"/>	FI-ASSY <input type="text"/>	Final Assembly Work Center																															
	<input type="text" value="4402"/> <input type="text"/>	Assembler																																
	<input type="text" value="6501"/> <input type="text"/>	Assembly																																
	<input type="text" value="6505"/> <input type="text"/>	Administration																																
	<input type="text" value="6506"/> <input type="text"/>	Support																																
	<input type="text"/> <input type="text"/>																																	

Field or Control	Description
Op Seq, Task Code, and Work Center	<p>These values appear by default from the Define Routings - Summary page, but they can be changed here. If you maintain conversion rates at the work center level, the system displays the conversion codes that are associated with the operation's work center.</p> <p>If you maintain conversion rates at the task level and entered a task code, the system displays the conversion codes that are associated with the operation's task.</p>
Conversion Code	<p>Select a value to change the labor, machine, or overhead cost for a specific operation on a routing.</p> <p>To view the labor, machine, and overhead rates or costs assigned to the code, see the Conversion Code page and the Conversion Overhead Code page for the task or work center.</p> <hr/> <p>Note: Changing conversion codes creates variances until the item cost is recalculated and updated.</p>
First Conversion Ovhd Code (first conversion overhead code), Second Conversion Ovhd Code , Third Conversion Ovhd Code , and Fourth Conversion Ovhd Code	<p>Select up to four conversion overhead codes in these fields. The codes are used to calculate the overhead costs associated with the operation.</p>

Note: If you specify the labor or machine rate in cost per unit and you want to include the cost in the cost roll-up calculation, you must also define the corresponding costing rate type. For example, if the labor run rate is 0.50 per unit, the task (or the routing) needs an entry for costing labor run time so that the 0.50 is included in the operation's cost.

Note: The rates displayed are the current rates used in production to calculate earned labor, machine, and overhead costs. These costs are copied into a frozen production rate record during the production cost update and inventory revaluation process and are based on the rates associated with the cost type and version used to calculate the new production costs.

Define Routings - Operations: Attachments Page

Use the Define Routings - Operations: Attachments page (EN_RTG_OP_ATT) to specify routing operation attachments.

Navigation:

Manufacturing Definitions > Resources and Routings > Routings > Define Routings > Operations > Attachments

<i>Field or Control</i>	<i>Description</i>
Op Seq, Task Code, and Work Center	These values appear by default from the Define Routings - Summary page, but they can be changed here. Specify the operation with which you want to associate the attachment.
File Ext (file extension)	Select the type of media you want to attach. Note: You must set up file extensions in advance on the File Locations page.
Document ID	Enter the file name.

Related Links

“File Locations Page” (PeopleSoft Source to Settle Common Information)

Defining and Viewing Master Routings

To assign an item family routing, use the Item Family Routing Assignment (EN_RTG_FAMILY) component. To assign a routing to a specific group of items, use the Item Group Routing Assignment (EN_RTG_GROUP) component.

This section provides an overview of master routings and discusses how to:

- Define master routings.
- View manufacturing master routings where-used information.

Pages Used to Define and View Master Routings

<i>Page Name</i>	<i>Definition Name</i>	<i>Usage</i>
<u>Manufacturing: General Page</u>	MFB_ATTRIB	Define a master routing for an item.
<u>Master Routing Where Used Page</u>	EN_RTG_MST_WH_USED	Display the items that reference an item as its reference routing. You can display master routing where-used information for an item.
Master Rtg Where Used Report Page	RUN_ENS1003	Generate the Master Routing Where Used report.

Understanding Master Routings

You can define master or reference routings in PeopleSoft Inventory on the Manufacturing page within the Define Business Unit Item component. If many items have the same processing steps, you can create a master routing that many items can use as their individual routing.

You have four options:

- An item can have its own set of routings.
- You can directly link an item to the routings of another item.
- You can link the routings of a particular item to an inventory item group.

This option indicates that the item uses the set of routings assigned to its inventory item group.

Note: Before creating this link, you need to define an item group and assign that item group to a reference routing item in PeopleSoft Inventory.

- You can link the routings of a particular item to an inventory item family.

This option indicates that the item uses the set of routings assigned to its inventory item family.

Note: Before creating this link, you need to define an item family and assign that item family to a reference routing item in PeopleSoft Inventory.

Note: Cost roll-ups, PeopleSoft Supply Planning, and PeopleSoft Manufacturing always use the routing indicated—the item's own routing, the referenced item's routing, or the routing assigned to its group or family. Items use the reference routing item's rework and teardown routings in addition to the production routing. Also, in PeopleSoft Manufacturing, the reference or master routing is displayed everywhere that a routing code is displayed.

Changing the reference item's routing does not affect current production that has a production status of Firm, Released, or In Process, because the routing has already been copied into the operation list. However, subsequent production of the listed items are affected by the master routing item changes.

Related Links

“Understanding Item Control Values” (PeopleSoft Managing Items)

Manufacturing: General Page

Use the Manufacturing: General page (MFB_ATTRIB) to define a master routing for an item.

Navigation:

Items > Define Items and Attributes > Define Business Unit Item > Manufacturing > General

This example illustrates the fields and controls on the Manufacturing - General page. You can find definitions for the fields and controls later on this page.

Master Routing Option

<i>Field or Control</i>	<i>Description</i>
Item	Select to link an item directly to the routing of the item that you select in the Reference Routing Item field. The default is the item itself.
Item Group	Select to link the routings of a reference routing Item to an item group. To use this option you must first define item group routings on the Group Rtg Assignment page.

Field or Control	Description
Item Family	Select this option to link the routings of a reference routing item to an item family. To use this option, you must first define item group routings on the Family Rtg Assignment page.

Related Links

“Define Business Unit Item - Manufacturing: General Page” (PeopleSoft Managing Items)

“Understanding Item Control Values” (PeopleSoft Managing Items)

Master Routing Where Used Page

Use the Master Routing Where Used page (EN_RTG_MST_WH_USED) to display the items that reference an item as its reference routing.

You can display master routing where-used information for an item.

Navigation:

Manufacturing Definitions > Resources and Routings > Routings > Review Master Rtg Where Used > Master Routing Where Used

This example illustrates the fields and controls on the Master Routing Where Used page. You can find definitions for the fields and controls later on this page.

Master Routing Where Used

Business Unit US008 Routing State Manufacturing

Master Routing Item SR1001 Omega 500 Touring Bike



Std UOM EA Lot Control

Source Code Make Serial Control

Planner Code AW Revision Control

Items								Personalize Find	First 1-6 of 6 Last
Item ID	Description	Std UOM	Lot Cntl	Serial	Source Cd	Revision	Planner Code		
LT5010	Custom Road Bicycle	EA	<input checked="" type="checkbox"/>	<input type="checkbox"/>	Make	<input type="checkbox"/>	AW		
LT5011	Custom Road Bicycle Wheel	EA	<input checked="" type="checkbox"/>	<input type="checkbox"/>	Make	<input type="checkbox"/>	LK		
SR1002	Carrera 6000 Hi Performance Ro	EA	<input type="checkbox"/>	<input checked="" type="checkbox"/>	Make	<input type="checkbox"/>	AW		
SR1003	Mt. Whitney 3000 Mountain Bike	EA	<input type="checkbox"/>	<input checked="" type="checkbox"/>	Make	<input type="checkbox"/>	AW		
SR1301	Denali 500 Touring Bike	EA	<input type="checkbox"/>	<input checked="" type="checkbox"/>	Make	<input type="checkbox"/>	AW		
SR3001	Diablo 500 Touring Bike	EA	<input type="checkbox"/>	<input type="checkbox"/>	Make	<input type="checkbox"/>	AW		

Field or Control	Description
Item and Desc (description)	The page displays basic information about the item.

<i>Field or Control</i>	<i>Description</i>
	Click the Production for an Item button next to the Master Routing Item field to view all production that is using the referenced (master) routing.
	Click the Production for an Item button next to the item ID to access the Production Item List page to view item where-used production information for the specified item.

Copying Routings

This section discusses the Copy routings detail.

Pages Used to Copy Routings

<i>Page Name</i>	<i>Definition Name</i>	<i>Usage</i>
<u>Copy Routing Page</u>	EN_RTG_COPY	Copy routing data from one item to another within a business unit or, optionally, across business units.
<u>Copy Routing: Detail Page</u>	EN_RTG_COPY_DET	Review the data to be copied.

Copy Routing Page

Use the Copy Routing page (EN_RTG_COPY) to copy routing data from one item to another within a business unit or, optionally, across business units.

Navigation:

Manufacturing Definitions > Resources and Routings > Routings > Copy Routings > Copy Routings

This example illustrates the fields and controls on the Copy Routing page. You can find definitions for the fields and controls later on this page.

Copy Routing
Copy Routing Detail

Source Routing

*Unit

*Item ID

*Routing Type Production ▼

*Routing Code

Cumulative Yield %

Std UOM

Target Routing

*Unit

*Item ID

Routing Code

Cumulative Yield %

Std UOM

Operations Personalize | Find | View All | | First ◀ 1 of 1 ▶ Last

Op Seq	Task Code	Description	Work Center	Description	Yield %
0					100.0000

Source Routing

<i>Field or Control</i>	<i>Description</i>
Routing Code	Select the code for the desired source business unit and item ID combination.
Routing Type	Select for the source routing. After you select a routing type for the source routing, the system uses the same routing type by default for the target routing.
Search	Click to display the routing information associated with source business unit and item.
Cumulative Yield	Displays the cumulative yield that will be copied if all operations are copied.

Target Routing

<i>Field or Control</i>	<i>Description</i>
Routing Code	Select the code for the desired target business unit and item ID combination. You cannot specify as the target an item that has a source code of floor stock, expense, or planning. If you want to use one item's routing as the basis for the routing of another item with similar processing, enter the same business unit for both the source and the target.
Routing Type	The target routing type is the same as for the source.

Operations

<i>Field or Control</i>	<i>Description</i>
Copy	Select to copy any specific row of data.
Sub (subcontracted)	If the task is subcontracted, this check box is selected.
Count Point	If the source routing or target routing contains an operation sequence that is a count point, this check box is selected.

Copy Routing: Detail Page

Use the Copy Routing: Detail page (EN_RTG_COPY_DET) to review the data to be copied.

Navigation:

Manufacturing Definitions > Resources and Routings > Routings > Copy Routings > Copy Routing Detail

This example illustrates the fields and controls on the Copy Routing Detail page. You can find definitions for the fields and controls later on this page.

The screenshot shows the 'Copy Routing Detail' page. It is divided into three main sections:

- Target Routing:** Contains fields for 'Unit' (US001) and 'Item ID', with an 'Edit Rtg' button and 'Std UOM' label.
- Copy Options:** A grid of checkboxes for copying various attributes:
 - Copy Operation Times (checked)
 - Copy Operation Resources (checked)
 - Copy Assembly Text (checked)
 - Copy Assembly Docs (checked)
 - Copy Operation Text (checked)
 - Copy Assembly Att (checked)
 - Copy Operation Text (checked)
 - Copy Operation Att (checked)
 - Copy Operation Docs (checked)
 There are also 'View Source', 'View Target', and 'Apply' buttons, and a 'Same as Except' dropdown menu.
- Operations:** A table with columns: Op Seq, Task Code, Description, Work Center, Description, and Yield %. The first row shows a yield of 100.0000. Navigation controls like 'Personalize', 'Find', 'View All', and 'First 1 of 1 Last' are visible above the table.

You can copy the associated routing operation times, resources, text, attachments, and documents, as well as assembly text, attachments, and documents. If you do not want to copy routing attributes, deselect the attributes by deselecting the appropriate check boxes.

Note: You can copy documents only if you have selected identical item IDs for both the source routing and target routing.

Field or Control	Description
Copy	Select which operations to copy or not copy by selecting or deselecting the appropriate check boxes.

Field or Control	Description
Same as Except	<p>Use to select the operations to copy. The options are:</p> <ul style="list-style-type: none"> • <i>Exclude All:</i> Use this option to deselect all the check boxes. You can then select only the operations that you want to copy by selecting their Copy check boxes. • <i>Exclude Op Seq Range:</i> Use this option to exclude by ranges. When you select this option, the system displays the From and To Seq Nbr (sequence number) fields. Enter the range of operations that you want to exclude and then click the Apply button. • <i>Include All:</i> Use this option to select all the check boxes. You can then deselect only the operations that you do not want to copy by deselecting the appropriate Copy check boxes. • <i>Include Op Seq Range:</i> Use this option to include by ranges. When you select this option, the system displays the From and To Seq Nbr (sequence number) fields. Enter the range of operations that you want to include and then click the Apply button.
Copy Operation Resources	Copy all resources in the source work center to the target work center, along with the resource priorities.
View Source	Click to view the source item's routing and the operations selected to copy.
View Target	Click to preview how the target item's routing will look when it's copied.
Save	Click to complete the copying process. If the exact business unit, item ID, routing type, and routing code combination already exist as the target, the system prompts you to overwrite the existing routing. If you overwrite the routing, the system deletes the target routing and replaces it with the source routing. The Edit Routing button appears so that you can access the Routing Maintenance component to make changes to the copied routing.
Edit Routing	Click to edit the source item's routings with the Define Routings - Summary page.

PeopleSoft Engineering and Transferring Routings

If you have PeopleSoft Engineering installed, you can also transfer multiple routings at the same time from Engineering to Manufacturing or from Manufacturing to Engineering.

Related Links

“Transferring BOMs and Routings” (PeopleSoft Engineering)

Deleting Routings

This section discusses how to delete routings.

Page Used to Delete Routings

<i>Page Name</i>	<i>Definition Name</i>	<i>Navigation</i>	<i>Usage</i>
Delete Routings	EG_RTG_DELETE	Manufacturing Definitions > Resources and Routings > Routings > Delete Routings > Delete Routings	Delete routings for a range of items.

Delete Routings Page

Use the Delete Routings page (EG_RTG_DELETE) to delete routings for a range of items.

Navigation:

Manufacturing Definitions > Resources and Routings > Routings > Delete Routings > Delete Routings

This example illustrates the fields and controls on the Delete Routings page. You can find definitions for the fields and controls later on this page.

Delete Routings Search

*Unit



From Item ID Professional Road Bike, Womans

To Item ID Mountain Bike, Womans

*Routing Type Routing Code

Routing State

Routings					Personalize Find View All First 1-2 of 2 Last
Item	Description	Routing	Source Cd	Delete?	
MT2000	Professional Road Bike, Womans	1	Make	<input type="checkbox"/>	
MT3000	Mountain Bike, Womans	1	Make	<input type="checkbox"/>	

Field or Control	Description
Routing Type, Routing Code, From Item ID, and To Item ID	Select the values, including the ID range, for the items whose routings you want to delete.
Delete?	Select for every item whose routing you want to delete.
	Click the Select All button to select all the Delete? check boxes.
	Click the Deselect All button to deselect all the Delete? check boxes.

Note: You cannot delete an item's routing code if it's in use in a production area. Also you cannot delete a routing code if firm or released production IDs or production schedules exist.

Viewing Manufacturing Routing Comparisons

This section lists common elements and discusses how to:

- Compare manufacturing routings.
- Compare manufacturing routing header detail differences.
- Compare operational detail differences.
- Compare operation resource differences.
- Compare operation time differences.

Pages Used to View Manufacturing Routing Comparisons

Page Name	Definition Name	Usage
“Routing Comparison - Rtg Selections Page” (PeopleSoft Engineering)	EG_RTG_INQ_CMP	Display the comparison of two manufacturing routings or the same manufacturing item based on two different routing codes.
<u>Routing Comparisons - Header: Details Page</u>	EG_RTG_HDR_CMP	Display header details of the routing comparisons.

Page Name	Definition Name	Usage
“Routing Comparison - Header: Details Page” (PeopleSoft Engineering)	EG_RTG_HDC_CMP	Display any header document information that is associated with selected routings. You must have PeopleSoft Engineering installed to access this page.
Routing Comparison - Header: Attachments Page	EG_RTG_HATT_CMP	Display header attachment information for the two routings that you've compared.
<u>Routing Comparison - Operations: Details Page</u>	EG_RTG_OPS_CMP	Display the differences in operations for the two routings.
<u>Routing Comparison - Operations: Resources Page</u>	EG_RTG_RSRC_CMP	Display differences in resources for the two manufacturing routings.
<u>Routing Comparison - Operations: Times Page</u>	EG_RTG_TIME_CMP	Display operation time differences.
Routing Comparison - Operations: Documents Page	EG_RTG_OPDC_CMP	Display the routing document differences. You must have PeopleSoft Engineering installed to access this page.
Routing Comparison - Operations: Attachments Page	EG_RTG_OPAT_CMP	Display differences in operation attachments.
Routing Compare Report Page	RUN_ENS1002	Generate a hard-copy report that extensively compares an item's primary or alternate routings to another item's routing. Alternatively, you can select the primary or any alternate routing and compare it to any of the item's other routings.

Common Elements Used in This Section

<i>Field or Control</i>	<i>Description</i>
Differences	<p>Displays the differences between two routings. Possible values are:</p> <ul style="list-style-type: none"> • <i>Added</i>: Indicates an element has been added to the target routing (RTG2) that does not appear on the baseline routing (RTG1). • <i>Deleted</i>: Indicates an element appears on the baseline routing, but doesn't appear on the target routing. • <i>Chg (change)</i>: Indicates that the element exists on both routings, but there are differences in the operation attributes. • <i>Chg RTG1</i>: Specifies the attributes of the baseline routing. • <i>Chg RTG2</i>: Specifies the attributes of the target routing.

Routing Comparison - RTG Selections Page

Use the Routing Comparison - RTG Selections page (EG_RTG_INQ_CMP) to display the comparison of two manufacturing routings or the same manufacturing item based on two different routing codes.

Navigation:

Manufacturing Definitions > Resources and Routings > Routings > Routing Comparison > RTG Selections

This example illustrates the fields and controls on the Routing Comparison - RTG Selections page. You can find definitions for the fields and controls later on this page.

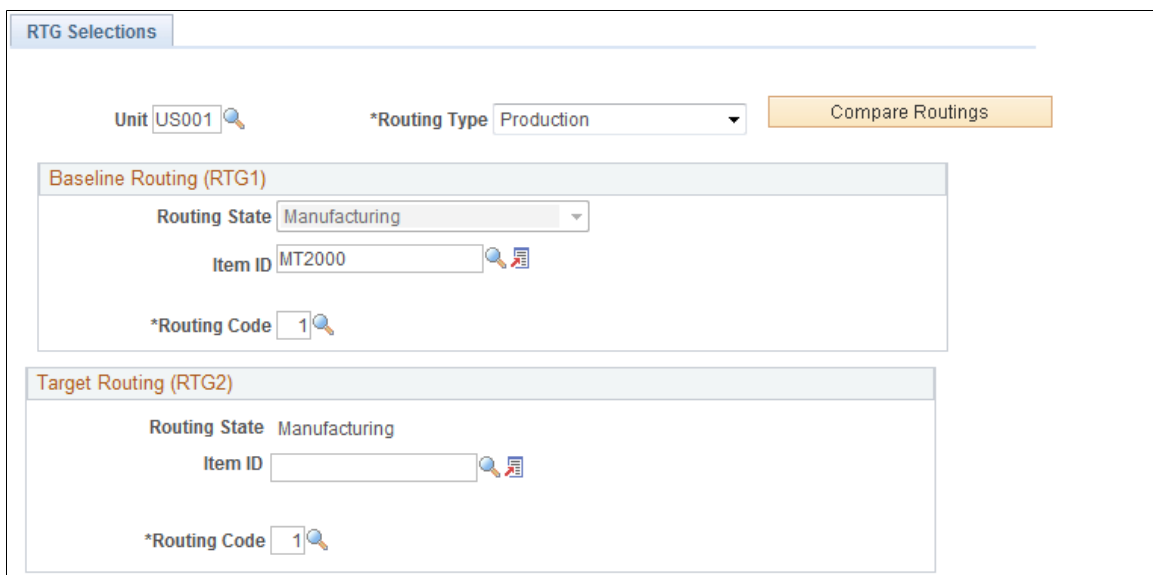

The screenshot shows the 'RTG Selections' page with the following fields and controls:

- Unit:** Text input field containing 'US001' with a search icon.
- *Routing Type:** Dropdown menu set to 'Production'.
- Compare Routings:** Orange button.
- Baseline Routing (RTG1):**
 - Routing State:** Dropdown menu set to 'Manufacturing'.
 - Item ID:** Text input field containing 'MT2000' with search and document icons.
 - *Routing Code:** Text input field containing '1' with a search icon.
- Target Routing (RTG2):**
 - Routing State:** Text label 'Manufacturing'.
 - Item ID:** Text input field with search and document icons.
 - *Routing Code:** Text input field containing '1' with a search icon.

Baseline Routing (RTG1)

<i>Field or Control</i>	<i>Description</i>
Routing State	Appears by default as <i>Manufacturing</i> and is display-only.
Item ID	Select the item ID of the baseline routing to use for the comparison.
Routing Code	Select a routing code that is valid for the specified item ID.

Target Routing (RTG2)

<i>Field or Control</i>	<i>Description</i>
Item ID	Select the item ID of the target routing to use for the comparison.
Routing Code	Select a routing code that is valid for the specified item ID.

Click the **Compare Routings** button to display the comparison of the two routings.

Routing Comparisons - Header: Details Page

Use the Routing Comparisons - Header: Details page (EG_RTG_HDR_CMP) to display header details of the routing comparisons.

Navigation:

Manufacturing Definitions > Resources and Routings > Routings > Routing Comparison > Header > Details

This example illustrates the fields and controls on the Routing Comparisons - Header: Details page. You can find definitions for the fields and controls later on this page.

RTG Selections		Header		Operations	
Details		Documents		Attachments	
Unit: US008		Rtg Type: Production			
Baseline Routing (RTG1)			Manufacturing Routing (RTG2)		
Rtg State: Manufacturing		Rtg State: Manufacturing			
Item ID: MT2000 Professional Road Bike, Womans		Item ID: MT3000 Mountain Bike, Womans			
Routing Code: 1		Routing Code: 1			
Routing	Description / Short Descr	Copy to Prdn.	Copy to Planning	Text	
RTG1	Pro Road Bike, Wmn Pro Road Priority 1	<input checked="" type="checkbox"/>	<input checked="" type="checkbox"/>	<input type="text"/>	
RTG2	Mountain Bike, Womans Mt Bike Wm Priority 1	<input checked="" type="checkbox"/>	<input checked="" type="checkbox"/>	<input type="text"/>	

Field or Control	Description
Routing, Description, Priority, Text, Copy to Prdn (copy to production), and Copy to Planning	These fields display the routing header data for both routings, including whether the routing is to be copied to production and planning.

Related Links

[Define Routings - Header: Description Page](#)

Routing Comparison - Operations: Details Page

Use the Routing Comparison - Operations: Details page (EG_RTG_OPS_CMP) to display the differences in operations for the two routings.

Navigation:

Manufacturing Definitions > Resources and Routings > Routings > Routing Comparison > Operations > Details

This example illustrates the fields and controls on the Routing Comparisons - Operations: Details page. You can find definitions for the fields and controls later on this page.

The screenshot displays the 'Routing Comparisons - Operations: Details' page. It features a navigation bar with tabs for 'RTG Selections', 'Header', and 'Operations'. Under 'Operations', there are sub-tabs for 'Details', 'Resources', 'Times', 'Documents', and 'Attachments'. The main content area is divided into two panels: 'Baseline Routing (RTG1)' and 'Manufacturing Routing (RTG2)'. Below these panels is a table titled 'Operation Details' with the following data:

Differences	Op Seq	Task Code	Description	Count Point	Sub	S/Q	Intensity	Send Ahead	Yield %
Chg RTG1	40	PAINT	Prime and Paint	<input type="checkbox"/>	<input type="checkbox"/>	<input type="checkbox"/>	Longest		100.0000
Chg RTG2	40	SUB-1	Subcontracted Painting	<input type="checkbox"/>	<input checked="" type="checkbox"/>	<input type="checkbox"/>	Labor Time		100.0000

This page displays the differences in the operation sequence and other related operation detail information.

Operations tab

This page displays the differences including information such as task codes, count points, subcontracting status, setup and queue, intensity, operation yield percentages, and send-ahead quantities.

Resources tab

This page displays resource differences in work centers, crew size, and machines.

Conversion/Overheads tab

This page displays conversion and overhead differences, including information such as conversion codes and overhead conversion codes associated with the operations.

Supplier Details and Subcontracted tabs

These pages display supplier details and subcontracted information differences associated with the operations.

Routing Comparison - Operations: Resources Page

Use the Routing Comparison - Operations: Resources page (EG_RTG_RSRC_CMP) to display differences in resources for the two manufacturing routings.

Navigation:

Manufacturing Definitions > Resources and Routings > Routings > Routing Comparison > Operations > Resources

This example illustrates the fields and controls on the Routing Comparison - Operations: Resources page. You can find definitions for the fields and controls later on this page.

The screenshot displays the 'Operations' tab of a routing comparison page. It includes the following sections:

- Summary:** Business Unit US008, Item ID MT2000 (Professional Road Bike, Womans), Routing Code 1, Std UOM EA, Source Make, Cum Yield % 100.0000, Routing State Manufacturing, Routing Type Production.
- Operations:** *Op Seq 10, Task Code FORK, *Work Center FI-ASSY, Crew Size 1.00, Machine Resources 1.00, Operation Yield % 100.0000. Includes checkboxes for Continuous Scheduling and Ignore Capacity.
- Resources Table:**

*Resource Type	Crew/Machine/Tool	Description	Status	Qty Used	Priority
Primary Crew	ASSY01	Assembly Crew 1	Available	0.0000	10
Alt Crew	ASSY02	Assembly Crew 2	Available	0.0000	10
Primary Machine	FINAL01	Final Assembly Equipment 1	Available	0.0000	10

The page displays differences in operation sequence, resource types, crews, machines, tools, quantity used, and priority.

If there is a difference in resource priority between two routing codes for a single item, or between two items, it appears on this page.

Routing Comparison - Operations: Times Page

Use the Routing Comparison - Operations: Times page (EG_RTG_TIME_CMP) to display operation time differences.

Navigation:

Manufacturing Definitions > Resources and Routings > Routings > Routing Comparison > Operations > Times

This example illustrates the fields and controls on the Routing Comparison - Operations: Times page. You can find definitions for the fields and controls later on this page.

RTG Selections
Header
Operations

[Details](#) [Resources](#) [Times](#) [Documents](#) [Attachments](#)

Unit: US008 **Rtg Type:** Production

Baseline Routing (RTG1)
Rtg State: Manufacturing
Item ID: MT2000
 Professional Road Bike, Womans
Routing Code: 1

Manufacturing Routing (RTG2)
Rtg State: Manufacturing
Item ID: MT3000
 Mountain Bike, Womans
Routing Code: 1

Operation Times Customize | Find | First 1-6 of 6 Last

Differences	Op Seq	Time / Resource Type	Op Time	Time Unit	Op Rate	Rate Unit	Inc. Setup
Deleted	40	Planning Labor Fixed Run	15.00	Minutes			<input type="checkbox"/>
Added	40	Planning Labor Run	0.00		200.00	Units/Hour	<input type="checkbox"/>
Deleted	40	Planning Machine Fixed Run	1.00	Hours			<input type="checkbox"/>
Deleted	40	Costing Labor Fixed Run	15.00	Minutes			<input type="checkbox"/>
Added	40	Costing Labor Run	0.00		200.00	Units/Hour	<input type="checkbox"/>
Deleted	40	Costing Machine Fixed Run	1.00	Hours			<input type="checkbox"/>

This page displays differences in operation sequences, time or resource types, operation times, time units, operation rates, and rate units. It also indicates whether the time is included in the setup.

Defining Production Options

Understanding Production Options

Some companies' products have either cyclical or seasonal variations in their method of producing an item. They need the ability to define different effective-dated BOM and routing combinations at different times of the year and, at the same time, have planning recommend those combinations based on production order due dates. For the discrete user, the main advantage in using this functionality is that you can link a BOM and routing code together, specify which BOM and routing combinations can be extracted to PeopleSoft Supply Planning, and use these predefined combinations in PeopleSoft Manufacturing. Optionally, you can ensure that the production ID maintenance users select only valid combinations.

Production options are effective-dated BOM and routing combinations that can be extracted to PeopleSoft Supply Planning and used in production. Once you have defined the BOMs and routings, you can link individual production BOM codes to specific production routings, enabling you to define sets of valid BOM and routing combinations for an item. By specifying an effective and obsolete date for each combination, you can take into account seasonal variations in production. You can also indicate whether the production option is to be included in PeopleSoft Supply Planning, which determines whether the combination is valid in the planning instance and considered in the optimization process. During the optimization process, PeopleSoft Supply Planning recommends a production option based on the due date of the planned order.

During the production option definition, you can:

- Assign individual production options to specific production areas.
- List all production areas where an item can be built.
- Attach text and documents to production options.

A set of inquiries enables you to view all the data related to the production options, including component and output mix through which you can view, by operation, the components used and the outputs from that operation. In addition, you can copy production options within or between business units and automatically create production options for all or a range of items or production areas.

This flowchart provides a top-level view of how you can use production options:

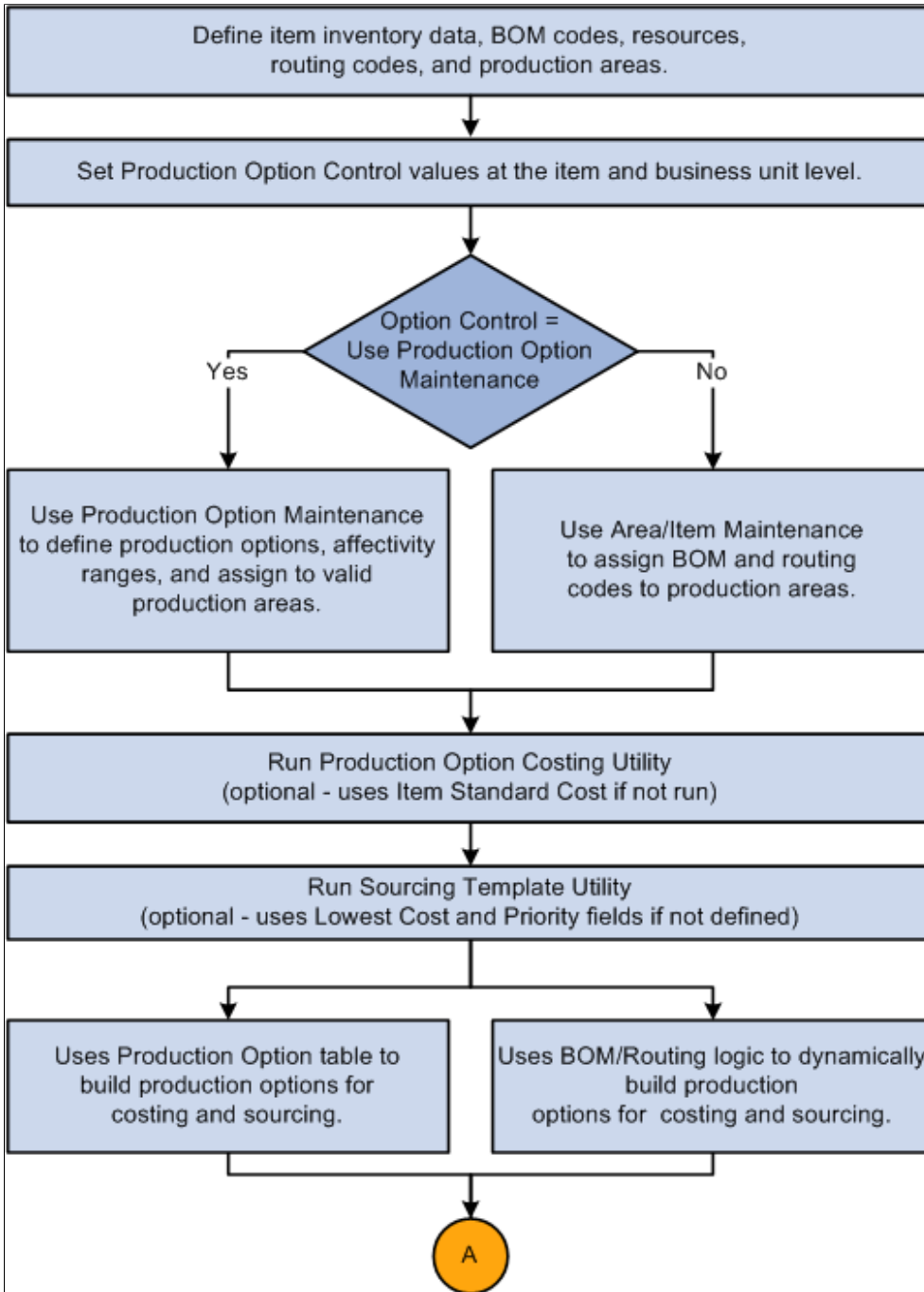

This flowchart continues to provide a top-level view of how you can use production options:

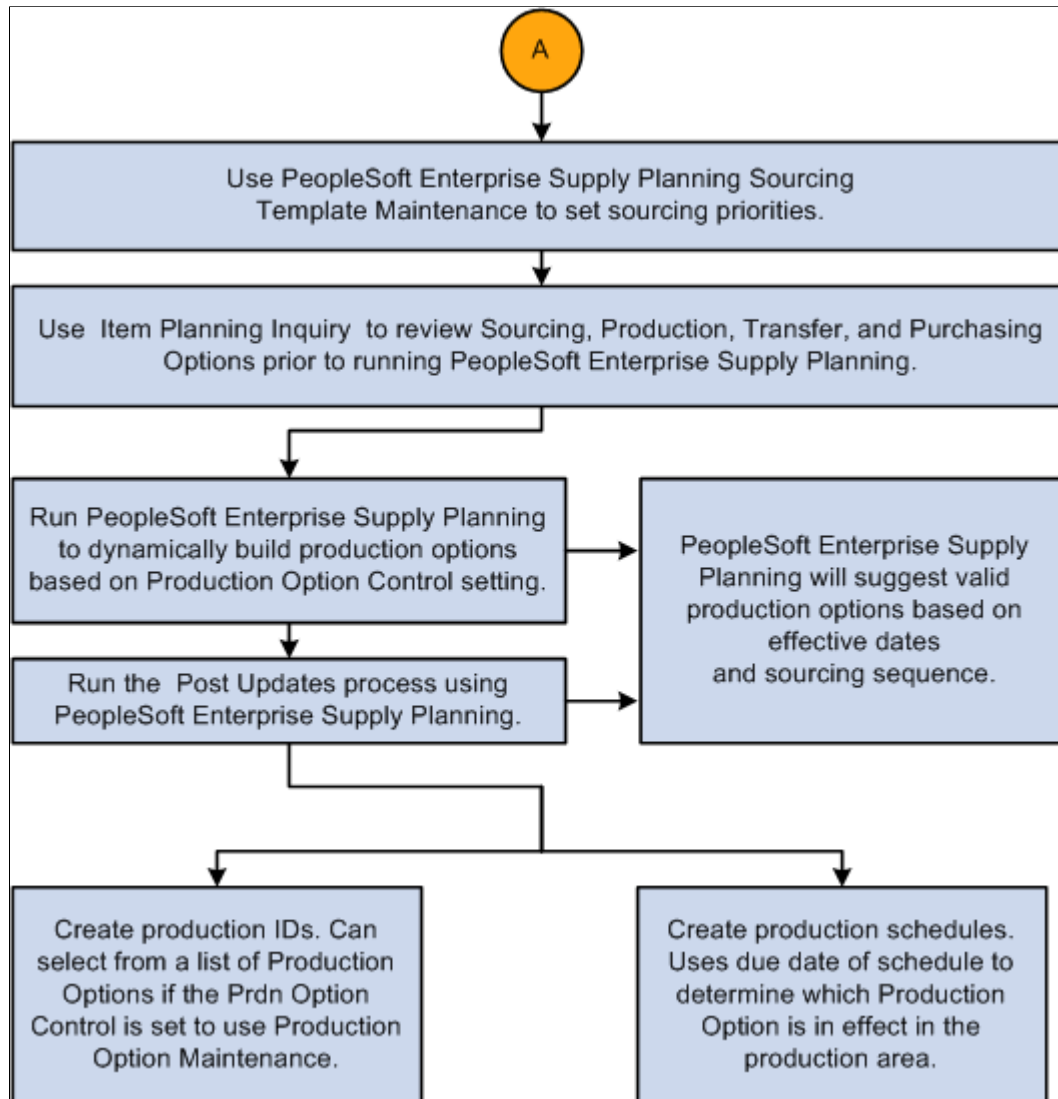

Prerequisites

Before you begin defining and maintaining production options, you must perform several setup tasks:

1. Decide which items will use production options.
2. Define BOMs and routings for items using production options.
3. If you plan to associate production options with production areas, then production areas must already be defined within PeopleSoft Manufacturing using the Area - Summary page.

Related Links

[Understanding Production Areas](#)

[Understanding BOM Maintenance](#)

[Understanding Routings](#)

Defining Items that Are to Use Production Options

This section discusses how to define items that will use production options.

Page Used to Define Items that Are to Use Production Options

Page Name	Definition Name	Navigation	Usage
Define Business Unit Item - Manufacturing: General	GEN_ATTRIB_INV	Items > Define Items and Attributes > Define Business Unit Item > Manufacturing > General	Define production option control information for an item.

Define Business Unit Item - Manufacturing: General Page

Use the Define Business Unit Item - Manufacturing: General page (GEN_ATTRIB_INV) to define production option control information for an item.

Navigation:

Items > Define Items and Attributes > Define Business Unit Item > Manufacturing > General

This example illustrates the fields and controls on the Define Business Unit Item - Manufacturing: General page. You can find definitions for the fields and controls later on this page.

The screenshot displays the 'Define Business Unit Item - Manufacturing: General' page for item MT2000. The page is organized into several sections:

- General Information:** Unit US008, Item ID MT2000, Standard Unit of Measure EA, and item name 'Professional Road Bike, Womans'.
- Production Area:** Set to 'FINAL'. Includes checkboxes for 'Calc Comp Yield at Completion' and 'Phantom Item'.
- Source Code:** Set to 'Make'. Includes 'Average Order Qty' (10.0000) and 'Associated Primary BOM' (MT2000).
- Component Issue Method:** Radio buttons for 'Issue' (selected), 'Kit', and 'Replenish'.
- BOM Usage:** Checkboxes for 'Revision Control' and 'Auto Revision'. Radio buttons for 'By Effectivity Date' and 'By Revision'.
- Master Routing Option:** Radio buttons for 'Item' (selected), 'Item Group', and 'Item Family'. Includes 'Reference Routing Item' (MT2000).
- Production Option Control:** Radio buttons for 'Use BOM/ Routing Defaults' (selected), 'Use Prdn Option Maintenance', and 'Valid Production Options only'. Includes 'BOM Code' and 'Routing Code' fields.
- Backflush Lot Option:** Radio buttons for 'Default from BU' (selected), 'Manual', 'Earliest Expiration Date', and 'Earliest Available Date'. Includes 'BU Backflush Option' (Manual).
- Production Lead Times:** Fields for 'Fixed Lead Time' and 'Variable Lead Time', both with 'Hours' dropdown menus. Includes a 'Use Lead Time' checkbox.

Production Option Control

<i>Field or Control</i>	<i>Description</i>
Use BOM/Routing Defaults	<p>Use to create specific BOM and routing combinations for PeopleSoft Supply Planning.</p> <p>If you select Use BOM/Routing Defaults, you cannot access the production option maintenance pages for the item, but you can limit the production options that are created in PeopleSoft Supply Planning by using the BOM Code and Routing Code fields.</p>
Use Prdn Option Maintenance (use production option maintenance)	<p>If you select Use Prdn Option Maintenance for a specific item ID, you can access the specified item using the Production Option Maintenance component. With these pages, you can define specific BOM and routing combinations that can be extracted to PeopleSoft Supply Planning and used in PeopleSoft Manufacturing. You can define effective start and end dates for the combinations in addition to assigning the combinations to valid production areas.</p> <p>If you select Use Prdn Option Maintenance, select Valid Production Options only to use only predefined production options when creating production IDs.</p> <p>If any BOM or routing combination is valid, leave this blank.</p>

Note: You can only select **Use Prdn Option Maintenance** if no area or items have been defined for the specific item. If you have already assigned an item to a production area in PeopleSoft Manufacturing, you cannot select **Use Prdn Option Maintenance** for that same item on the Define Business Unit Item - Manufacturing: General page. You can, however, create production options by running the Autocreate Production Options process, which sets the item's **Production Options** group box to **Use Prdn Option Maintenance** rather than **Use BOM/Routing Defaults**.

Note: If you have marked an item to **Use Prdn Option Maintenance**, you must set the planning rates to be based on routings; you cannot select them to be based on lead time. If the item is already going to be produced based on lead times, you cannot select the **Use Prdn Option Maintenance** option on the Define Business Unit Item - Manufacturing: General page.

This table outlines the production options that you can create by entering various values in the **BOM Code** and **Routing Code** fields:

<i>BOM Code and Routing Code Setting</i>	<i>Production Option Created</i>
If both are blank.	System creates a production option for every possible BOM and routing combination.

BOM Code and Routing Code Setting	Production Option Created
If BOM Code field is not blank and Routing Code field is blank.	System creates a production option for all routing codes with the specific BOM code selected.
If Routing Code field is not blank and BOM Code field is blank.	System creates production options for all BOMs with the specific routing code selected.
If both are not blank.	System creates one production option for the single, specified BOM and routing combination.

By selecting a specific BOM and routing code, you can limit the number of BOM and routing combinations that are extracted by PeopleSoft Supply Planning. For example, by selecting a specific BOM code and routing code, you eliminate all but this specific combination from consideration by PeopleSoft Supply Planning. At the other extreme, if you leave both fields blank, then PeopleSoft Supply Planning extracts all possible combinations.

This example illustrates various BOM and routing values and the production options that would be created by various BOM code and routing code settings.

If a specific item has BOM codes 1, 2, and 3 and routing codes 1 and 2, here are the numbers of production options created in PeopleSoft Supply Planning, based on the **BOM Code** and **Routing Code** field settings:

BOM Code	Routing Code	Production Options Created	Total Combinations
Blank	Blank	1-1, 1-2, 2-1, 2-2, 3-1, 3-2	6
1	Blank	1-1, 1-2	2
Blank	2	1-2, 2-2, 3-2	3
1	2	1-2	1

The number of production options created in PeopleSoft Supply Planning depends on the BOM and routing default values.

Note: Only routing codes that have the **Copy Routing to Planning** check box selected in the Routing Definition - Header: Description page are copied to PeopleSoft Supply Planning.

Note: You can only select **Use BOM/Routing Defaults** if there are no production options defined for the item. If production options exist, you must manually delete them first.

Also, if you select **Use BOM/Routing Defaults**, use the Production Area Maintenance set of pages to define area BOM and routing combinations.

<i>Production Option Control Setting</i>	<i>Steps Based on Control Setting</i>
<p>Select Use Prdn Option Maintenance to:</p> <ul style="list-style-type: none"> Define specific BOM and routing combinations that can be extracted to PeopleSoft Supply Planning or used to create production IDs and schedules. Effective-date the BOM and routing combinations; this can be used to handle seasonal variations in the product mix. 	<ol style="list-style-type: none"> Create BOM and routing codes for an item. Use the Production Option Maintenance pages to link the BOM and routing codes together and (optionally) assign them to production areas. Select the Incl Plan (include in planning) check box to specify which BOM and routing combinations should be extracted to PeopleSoft Supply Planning. Create production IDs and production schedules for the item.
<p>Select Use BOM/Routing Defaults, if specific BOM and routing combinations are not required.</p> <p>Additionally, it's possible to limit the number of BOM and routing combinations extracted to PeopleSoft Supply Planning using the BOM and routing fields.</p>	<ol style="list-style-type: none"> Create BOM and routing codes for an item. Use the Production Area Maintenance pages to define area BOM and routing combinations.

Related Links

“Define Business Unit Item - Planning: Fences Page” (PeopleSoft Managing Items)

[Define Routings - Header: Description Page](#)

[Understanding Production Areas](#)

“Define Business Unit Item - Manufacturing: General Page” (PeopleSoft Managing Items)

Creating Production Options

To create production options, use the Define Production Options (EN_PDO_MAINT) component.

The Production Option Maintenance pages enable you to specify multiple production variations for an item and control the variations by effectivity dates. You do this by linking specific production BOM codes with specific production routings at the item level.

This section discusses how to Create Production Options:

Pages Used to Create Production Options

<i>Page Name</i>	<i>Definition Name</i>	<i>Usage</i>
Production Option Maintenance - Definition Page	EN_PDO_BR	Define production options and effective-dated BOM and routing combinations that can be extracted to PeopleSoft Supply Planning.

Page Name	Definition Name	Usage
<u>Production Option Maintenance - Production Area Page</u>	EN_PDO_BR_PA	Associate production areas with each production option.
Production Option Maintenance - Text Page	EN_PDO_BR_TXT	Add production option text.
Production Option Maintenance - Documents Page	EN_PDO_BR_DC	Associate documents with production options. You must have PeopleSoft Engineering installed to access this page.
<u>Production Option Maintenance - Attachments Page</u>	EN_PDO_BR_ATT	Attach multimedia objects or files that relate directly to the production option. Once attached, you can view these objects directly from this page.

Common Elements in This Section

Field or Control	Description
	<p>Click the Item Search button to access any of these pages:</p> <ul style="list-style-type: none"> • Component/Output Mix Inquiry: Select to view the components and outputs associated with the corresponding routing operation for the BOM code and routing code specified. • BOM Maintenance and Routing Maintenance: If you did not specify a BOM or routing code, access the BOM Maintenance or Routing Maintenance components in Add mode. However, if you entered a BOM or routing code, then you will view that BOM or routing in Update mode. • Copy Previous Row: This page enables you to copy data from the previous row, and this option is only available on a newly inserted row. You can then make changes to the effective and obsolete dates, descriptions, and indicate whether this new production option should be available for extraction to PeopleSoft Supply Planning.

Production Option Maintenance - Definition Page

Use the Production Option Maintenance - Definition page (EN_PDO_BR) to define production options and effective-dated BOM and routing combinations that can be extracted to PeopleSoft Supply Planning.

Navigation:

Manufacturing Definitions > Production Options > Define Production Options > Definition

This example illustrates the fields and controls on the Define Production Options - Definition page. You can find definitions for the fields and controls later on this page.

Definition		Production Area	Text	Documents	Attachments			
Unit	US012	Std UOM	GAL	Source Cd	Make			
Item ID	000000000000020020		Rtg Itm	00000000000020020				
Classic Spaghetti Sauce - Processed - Mixed Spice & Tomatoes								
Production Options Personalize Find View All [?] [] First 1-6 of 12 Last								
BOM	Routing	*Eff Date	*Obs Date	*Description	Short Desc	Incl Plan		
1	1	01/01/2000	06/30/2000	Winter / Spring Classic	Winter / S	<input checked="" type="checkbox"/>	+	-
1	1	01/01/2001	06/30/2001	Winter / Spring Classic	Winter / S	<input checked="" type="checkbox"/>	+	-
1	1	01/01/2002	06/30/2002	Winter / Spring Classic	Winter / S	<input checked="" type="checkbox"/>	+	-
1	1	01/01/2003	06/30/2003	Winter / Spring Classic	Winter / S	<input checked="" type="checkbox"/>	+	-
1	1	01/01/2004	06/30/2004	Winter / Spring Classic	Winter / S	<input checked="" type="checkbox"/>	+	-
1	1	01/01/2005	06/30/2005	Winter / Spring Classic	Winter / S	<input checked="" type="checkbox"/>	+	-

Field or Control	Description
Rtg Itm (routing item)	Displays the master routing item if the item selected is linked to a master routing.
BOM and Routing	If you are adding a new production option, select the BOM code and routing code that you want to define as a production option for the item that you selected.
Eff Date (effective date) and Obs Date (obsolete date)	Enter the effectivity dates of the production option.
Incl Plan (include in planning)	Select if you want to make the production option available for extraction to PeopleSoft Supply Planning. This field appears by default from the Copy to Routing check box in Routing Maintenance. If the Copy to Routing check box is selected, then this field is automatically selected.
	Click the Select All or Deselect All buttons to control the Incl Plan field.

Related Links

[Understanding BOM Maintenance](#)

[Understanding Routings](#)

[Viewing Component and Output Mix and Production Options](#)

Production Option Maintenance - Production Area Page

Use the Production Option Maintenance - Production Area page (EN_PDO_BR_PA) to associate production areas with each production option.

Navigation:

Manufacturing Definitions > Production Options > Define Production Options > Production Area

This example illustrates the fields and controls on the Define Production Options - Production Area page. You can find definitions for the fields and controls later on this page.

The screenshot displays the 'Production Area' page for a production option. At the top, there are tabs for 'Definition', 'Production Area', 'Text', 'Documents', and 'Attachments'. Below the tabs, the following information is shown:

- Unit: US012, Std UOM: GAL, Source Cd: Make
- Item ID: 00000000000020020, Rtg Itm: 00000000000020020
- Classic Spaghetti Sauce - Processed - Mixed Spice & Tomatoes

The 'Production Options' section includes:

- BOM: 1, Routing: 1
- *Eff Date: 01/01/2000, *Obs Date: 06/30/2000
- *Description: Winter / Spring Classic

The 'Production Areas' section contains a table with the following data:

*Production Area	Revision	Primary	*Method	*Status	Rate Qty per Shift
SAUCE		<input checked="" type="checkbox"/>	Issue	Active	

The **BOM**, **Routing**, **Description**, **Eff Date** (effectivity date), and **Obs Date** (obsolete date) fields appear by default from the Production Option - Definition page. For each production option, you can add one or more production areas using the **Production Area** field.

Note: You can select only one primary production area. Also, only one BOM and routing combination can be in effect in a production area at one time.

Because the same fields are being updated, the **Revision**, **Primary**, **Maintain PID** (maintain production ID), **Method**, **Status**, and **Rate Qty per Shift** (rate quantity per shift) fields operate identically to those fields on the Production Area Maintenance pages in PeopleSoft Manufacturing.

Related Links

[Understanding Production Areas](#)

Production Option Maintenance - Attachments Page

Use the Production Option Maintenance - Attachments page (EN_PDO_BR_ATT) to attach multimedia objects or files that relate directly to the production option.

Once attached, you can view these objects directly from this page.

Navigation:

Manufacturing Definitions > Production Options > Define Production Options > Attachments

Attachments

<i>Field or Control</i>	<i>Description</i>
File Ext (file extension)	Select the type of media that you want to attach. Set up file extensions using the File Locations page.
Document ID and Description	Enter the file name and description of the multimedia file that you are attaching.
	Click the Attachments button to launch the multimedia object attached to the production option.

Using the Autocreate Production Options Process

You can automatically create production options by item ID or by production area. By using the autocreate production options process, you can quickly convert items that are currently not using production options to use production options.

Page Used to Create Production Options Automatically

<i>Page Name</i>	<i>Definition Name</i>	<i>Usage</i>
<u>Autocreate Production Options Page</u>	EN_PDO_AUTOCREATE	Create production options automatically by item ID or by production area.

Autocreate Production Options Page

Use the Autocreate Production Options page (EN_PDO_AUTOCREATE) to create production options automatically by item ID or by production area.

Navigation:

Manufacturing Definitions > Production Options > Autocreate Production Options

This page is useful for users who are new to the production option functionality. You can use it to create production options quickly for all or a range of items or production areas. Begin by selecting either **Item ID** or **Production Area**. Then, depending on your choice, the **Item ID** or **Prdn Area** (production area) fields become available for selection.

When you click the **Save** button, the system converts all items that are currently not using production options to using production options. For all items converted to production options, the item's **Production Option Control** value on the Define Business Unit Item - Manufacturing: General page is set to **Use Prdn Option Maintenance**. You can then access the item on the Production Option maintenance pages.

This function automatically adds the BOM and routing combination defined in the production area as a production option.

Note: If an item is going to be produced based on lead times rather than routings, the item is not converted, because items set to **Use Prdn Option Maintenance** cannot use lead times.

Note: If you have already assigned an item to a production area in PeopleSoft Manufacturing, then you cannot select Use Production Option for that same item on the Define Business Unit Item - Manufacturing: General page. You can, however, create production options by using the autcreate functionality.

Related Links

“Define Business Unit Item - Planning: Fences Page” (PeopleSoft Managing Items)

Copying Production Options

You can copy production options from one item to another and across business units, if needed. This section lists common elements and discusses how to copy production options.

Page Used to Copy Production Options

<i>Page Name</i>	<i>Definition Name</i>	<i>Usage</i>
Copy Production Options Page	EN_PDO_COPY	Copy production options from one item to another.

Common Elements Used in This Section

<i>Field or Control</i>	<i>Description</i>
	<p>Click the View Related Links button to access any of these pages:</p> <ul style="list-style-type: none"> Item Search: Search for a different item. BOM Copy: Copy BOMs from one business unit and item ID combination to another business unit. Routing Copy: Copy routings from one business unit and item combination to another business unit. Area Maintenance: View or maintain items for a specific production area. Production Option Maintenance: View or maintain existing production options.

Copy Production Options Page

Use the Copy Production Options page (EN_PDO_COPY) to copy production options from one item to another.

Navigation:

Manufacturing Definitions > Production Options > Copy Production Options

This example illustrates the fields and controls on the Copy Production Options page. You can find definitions for the fields and controls later on this page.

Copy Production Options

Source

Unit Std UOM GAL

Item ID Classic Spaghetti Sauce - Proc

Target

Unit Std UOM GAL

Item ID Creamy Tomato Sauce - Processe

View Source Copy Prdn Area Same As Except

View Target Copy Text

Copy Att

Production Options Personalize | Find | View All | | First 1 of 12 Last

Copy	BOM	Routing	Eff Date	Obs Date	Description	Incl Plan
<input checked="" type="checkbox"/>	1		1 01/01/2000	06/30/2000	Winter / Spring Classic	<input checked="" type="checkbox"/>

Source

<i>Field or Control</i>	<i>Description</i>
Unit and Item ID	Select the business unit and item ID whose production option you want to copy. <hr/> Note: If the source item has been identified as using production options, but has no actual production options defined, then the system displays an error message, because there are no options to copy. <hr/>
Search	Click to display the production options for the source item.

Target

Field or Control	Description
Unit and Item ID	Select the business unit and item ID. The target item ID cannot be identical to the source item ID. If the target item already has production options defined, the system provides the option either to not continue or to overwrite the existing production options on the target; you cannot overwrite any production option that is already in use on a production order.
Copy Prdn Area (copy production area), Copy Text and Copy Att (copy attachment)	Select to copy production areas, text, and attachments to the target item.
Same As Except	<p>Select the production options to be copied by using this field.</p> <p>Values are:</p> <ul style="list-style-type: none"> • <i>Excl All</i> (exclude all): Deselects all the rows. • <i>Incl All</i> (include all): Selects all the rows. • <i>Incl Date</i> (include date): Enables you to specify a date range, and the system selects the options that are effective in that date range. <p>If you've already selected a row, but it does not fall in the date range, the system does not deselect the row. You can click the Apply button to apply the selection that you made in the Same As Except field.</p> <p>For example, suppose that you select <i>Excl All</i> and then click the Apply button, the system deselects all the rows.</p>
View Source and View Target	Click to view the production options for the respective items.
Copy	<p>Select the rows that you want to copy to the target item.</p> <hr/> <p>Note: You must select at least one production option to copy or the system displays an error message.</p> <hr/>
Save	Click and the system completes the copy.

Related Links

[Copy BOM Page](#)

[Copying Routings](#)

[Production Area: Summary Page](#)

Creating Production Options

Viewing Component and Output Mix and Production Options

This section discusses how to View Component and Output Mix and Production Options.

Pages Used to View Component and Output Mix and Production Options

Page Name	Definition Name	Usage
<u>Component/Output Mix - Operation (inquiry) Page</u>	EN_PDO_INQ_SUM	Enter the search for the component and output mix, and view the routing operation sequences associated with BOM and routing combinations. You can view operation information such as tasks and work centers.
<u>Component/Output Mix - Operation (inquiry) Page</u>	EN_PDO_INQ_DTL	View the component and output mix by routing operation for a BOM and routing combination at a particular time. This inquiry displays the inputs and outputs at each operation for a specific BOM and routing combination.
Production Option - Definition (inquiry)	EN_PDO_BR_INQ	View production option data.
<u>Production Option - Production Area (inquiry) Page</u>	EN_PDO_BR_INQ_PA	View the production area data that is defined for the production option.
Production Option - Text Page(inquiry)	EN_PDO_BR_INQ_TXT	View production option text.
Production Option - Documents Page (inquiry)	EN_PDO_BR_INQ_DC	View documents that are associated with the production option. You must have PeopleSoft Engineering installed to access this page.
Production Option - Attachments Page (inquiry)	EN_PDO_BR_INQ_ATT	View attachments that are associated with the production option.
<u>Production Option Selection Page</u>	EN_PDO_SEL_SP	View and select existing production options.
Update Production Page(in PeopleSoft Supply Planning)	PL_SRC_PROD_SP	

Component/Output Mix - Operation (inquiry) Page

Use the Component/Output Mix - Operation (inquiry) page (EN_PDO_INQ_SUM) to enter the search for the component and output mix, and view the routing operation sequences associated with BOM and routing combinations.

You can view operation information such as tasks and work centers.

Navigation:

Manufacturing Definitions > Production Options > Review Component/Output Mix > Operation

This example illustrates the fields and controls on the Component/Output Mix - Operation page. You can find definitions for the fields and controls later on this page.

Operation
Component/Output

Business Unit:

Item ID:

BOM: Routing:

Eff Date:

Prdn Opt Cntl: Prdn Opt

Rtg Itm: 000000000000020013

Creamy Tomato Sauce - Processed - Spice - Tomatoes - Cream

BOM Qty: 1000

Operation & List						
Op Seq	Task Code	Description	Sub	Work Center	Description	Yield %
10			<input type="checkbox"/>	PUMP	Pump Sauce	100.0000
20			<input type="checkbox"/>	MIX	Mix Sauce	100.0000
30	COOKCR	Cook Creamy Sauce	<input type="checkbox"/>	COOK	Cook Sauce	100.0000
40	QC-CR	Quality Control - Creamy	<input type="checkbox"/>	QC/ADJ	Quality Control	100.0000

<i>Field or Control</i>	<i>Description</i>
Unit and Item ID	Select the business unit and item ID for the BOM and routing combination that you want to view.
	<p>Click the View Related Links button to select one of these pages:</p> <ul style="list-style-type: none"> Item Search: You can select a different item. Production Option Selection: You can view existing production options.
BOM, Routing, Revision and Eff Date (effectivity date)	<p>Select the desired BOM, routing, effectivity date, and revision. If the item is revision-controlled, the system pulls the BOM revision data. If it's not revision-controlled, the system sets the effectivity date to today's date.</p> <p>In addition, the system displays the BOM Qty.</p>

Field or Control	Description
Prdn Opt Cntl (production option control)	Displays the production option control, which indicates whether the item has been defined as using production options with the Define Business Unit Item - Manufacturing: General page. Therefore, it displays either <i>Prdn Opt</i> (use production option maintenance) or <i>BOM/Rtg</i> (BOM and routing combination defaults).
Rtg Itm (routing item)	Displays the item's reference routing. All of the data that appears is for the item's reference routing, if one exists. <hr/> Note: All of the data that appears is for the item's reference routing, if one exists. <hr/>
Search	Click to populate the operation list. This section displays the operation sequence for the BOM and routing combination that you selected. The page also indicates whether the operation sequence is subcontracted, and displays the work center and its description. In addition, clicking the Search button populates the Component/Output page in this component.

Note: A production option does not have to exist for you to view the BOM and routing combination data. You view the same information in either case. In addition, use this inquiry for multiple what-if scenarios.

Related Links

[Production Area: Summary Page](#)

[Creating Production Options](#)

“Define Business Unit Item - Manufacturing: General Page” (PeopleSoft Managing Items)

Component/Output Mix - Component/Output (inquiry) Page

Use the Component/Output Mix - Component/Output (inquiry) page (EN_PDO_INQ_DTL) to view the component and output mix by routing operation for a BOM and routing combination at a particular time.

This inquiry displays the inputs and outputs at each operation for a specific BOM and routing combination.

Navigation:

Manufacturing Definitions > Production Options > Review Component/Output Mix > Component/Output

<i>Field or Control</i>	<i>Description</i>
Yield %	This display-only field indicates the percentage of manufacturing items expected at the end of the operation sequence.

Note: If the BOM component and output operation sequence do not match the header operation sequence, an asterisk appears in front of the number. The header operation that appears against the output or component is an operation assigned when defining the BOM and might not match the routing operation. For components, the component appears as part of the first operation sequence. For outputs, the output appears as part of the last operation sequence.

Production Option - Definition (inquiry) Page

Use the Production Option - Definition (inquiry) page (EN_PDO_BR_INQ) to view production option data.

Navigation:

Manufacturing Definitions > Production Options > Review Production Options > Definition

<i>Field or Control</i>	<i>Description</i>
	Click the Item Search button to view the components and outputs at each routing operation for a specific BOM and routing combination.

Production Option - Production Area (inquiry) Page

Use the Production Option - Production Area (inquiry) page (EN_PDO_BR_INQ_PA) to view the production area data that is defined for the production option.

Navigation:

Manufacturing Definitions > Production Options > Review Production Options > Production Area

<i>Field or Control</i>	<i>Description</i>
	Click the Item Search button to view the components and outputs at each routing operation for a specific BOM and routing combination.

Production Option Selection Page

Use the Production Option Selection page (EN_PDO_SEL_SP) to view and select existing production options.

Navigation:

- **Production Control > Define Production > Production IDs/Schedules > Define a Production Area > Summary > Summary**

Click the **Item Search** button next to the Item to access the Production Option Selection page.

- **Production Control > Define Production > Production IDs/Schedules > Maintain PIDs > Production ID Maintenance**

Click the **Production Option Selection** button next to the **BOM** or **Routing** fields.

- **Supply Planning > Define Planning Attributes > Sourcing Templates > Define Sourcing Templates**

Click the **Production** button to select a production option.

<i>Field or Control</i>	<i>Description</i>
Select	Select this check box to populate the production option data on the page that called this page.

Using Production Options with Other PeopleSoft Applications

You define production options in PeopleSoft Manufacturing, but they also are present in PeopleSoft Supply Planning and PeopleSoft Cost Management. While the specifics of these impacts are discussed in the respective pieces of application documentation, this is a high-level discussion of the cross-product use of production options.

This section discusses how to:

- Use production options with PeopleSoft Supply Planning.
- Use production options with PeopleSoft Manufacturing.

Using Production Options with PeopleSoft Supply Planning

The **Production Option Control** check box (set at the item and business unit level on the Define Business Unit Item - Manufacturing: General page) determines how production options (formerly build options) are created in PeopleSoft Supply Planning.

There are two production option control options:

- **Use Prdn Option Maintenance** (production option maintenance).
- **Use BOM/Routing Defaults.**

Use Production Option Maintenance Setting

There are two different settings for the Production Option Control flag. If you select **Use Prdn Option Maintenance**, you can define specific BOM and routing combinations with effective dates assigned to

each combination. You make these definitions with the Production Option Maintenance pages. All BOM and routing combinations with the **Incl Plan** (include in planning) check box are visible to PeopleSoft Supply Planning.

Use BOM and Routing Defaults Setting

If you select **Use BOM/Rtg Defaults** as the production option, you cannot define and maintain specific effective BOM and routing combinations, but you can still limit the number of production options created in PeopleSoft Supply Planning. For example, suppose that you have BOM codes 1, 2, and 3 and routing codes 1 and 2, then there are potentially six production options that can be created in PeopleSoft Supply Planning, if there is no way to limit that number. However, you can limit that number by using the **BOM Code** and **Routing Code** fields on the Define Business Unit Item - Manufacturing: General page. For example, if you select one specific BOM code and one specific routing code, then only one combination is extracted by PeopleSoft Supply Planning.

Other Production Option Planning Information

Regardless of the setting, it's possible to view the PeopleSoft Supply Planning production options before running PeopleSoft Supply Planning by using the Item Planning Inquiry.

It's also possible to cost production options using the Production Option Costing Utility, so that an accurate build cost is sent to PeopleSoft Supply Planning for each production option. This utility effectively rolls up the costs for all production options in the range of items selected. Both the batch cost (total cost) and the unit cost can be viewed through the Item Planning Inquiry.

Using the sourcing template function, you can prioritize the production, transfer, and purchase options for an item and business unit, so that you have full control over how PeopleSoft Supply Planning creates new supply for the item.

Since PeopleSoft Supply Planning has visibility into the effective dates defined against the production option, the PeopleSoft Supply Planning application recommends new planned production orders based on the current, effective BOM and routing combinations.

Related Links

“Define Business Unit Item - Manufacturing: General Page” (PeopleSoft Managing Items)

“PeopleSoft Supply Planning Overview” (PeopleSoft Supply Planning)

Using Production Options with Production

This section discusses how the manufacturing process uses production options.

Production ID Maintenance

If you select **Use Prdn Option Maintenance** for an item on the Define Business Unit Item - Manufacturing: General page, then any production options that you have predefined are available for selection in production ID maintenance. In addition, if the **Valid Production Only** check box is selected, only those BOM and routing combinations that have been set up in production option maintenance can be selected. If the check box is deselected, then any combination of BOM and routing codes can be entered for the item. The BOM and routing fields automatically change to the current BOM and routing combination that is effective for that item in the selected production area.

Production Schedule Maintenance

The item, production area, and the due date for each production schedule determine which BOM and routing combination is assigned to that schedule.

Although different BOM and routing combinations can be assigned to the same production area and item, there can be only one combination in effect at any one time. The due date of the schedule determines which BOM and routing combination is selected for that production schedule.

When completing against a production schedule, the BOM and routing effective date on the Record Completions/Scrap page determines the particular BOM and routing to be used for the production schedule. The BOM and routing effective date automatically changes to the current system date, and this field determines which combinations will be selected and appear in the **BOM Code** and **Routing Code** fields. For non-revision controlled items, this date is used to decide which BOM and routing combination will be used. A second effective date is used for the components and outputs. If the item is revision-controlled, then both the revision code and BOM and routing effective date must be selected. The revision code determines the components and outputs in effect for this revision, and the BOM and routing effective date determines the BOM and routing combination to use.

Related Links

[Understanding Recording Completions and Scrap](#)

Using Serial Genealogy in PeopleSoft Manufacturing

Understanding Serial Genealogy

This diagram illustrates PeopleSoft and serial processing prior to Release 8.9

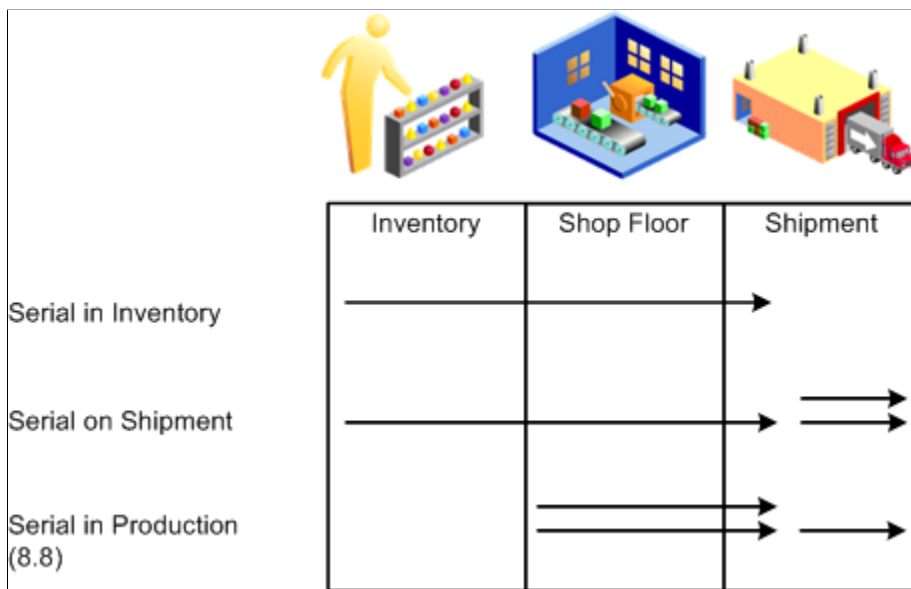

With PeopleSoft Manufacturing, you can trace the location and constituent components of finished goods items and trace source and usage of component parts during the production process.

Serial genealogy tracks the source and destination of any serialized item. A serialized item may be used in a serialized assembly, scrapped, used in a higher level serialized assembly that is then shipped to a customer.

Serial IDs may be associated with the production IDs at any time during the manufacturing process.

For rework or teardown production IDs, you do not manually associate serial IDs to the assembly. The serial association occurs when you issue the assembly that is to be reworked or torn down through the picking process or kit issues.

In addition to associating a serial ID with the assembly item, you can associate component serial IDs with an assembly serial ID.

You can correct errors by disassociating the serial ID from the assembly or disassociating the component from the assembly serial ID.

In addition, we provide an inquiry that displays the genealogy of a serialized item through multiple levels of BOMs. This inquiry also displays the transaction information associated with the serialized item.

Note: Serial genealogy is tracked with *single* output production orders (IDs) only.

Serial genealogy is not tracked on:

- Production schedules.
- Production IDs with multiple outputs such as co-products or by-products.
- Components with an quantity code of *per order*.

This diagram illustrates the serial genealogy process flow from setting the options on the item definition, to creating the production ID, issuing material, assigning serial IDs to assembly, assigning components to assembly, recording completions, and reviewing genealogy:

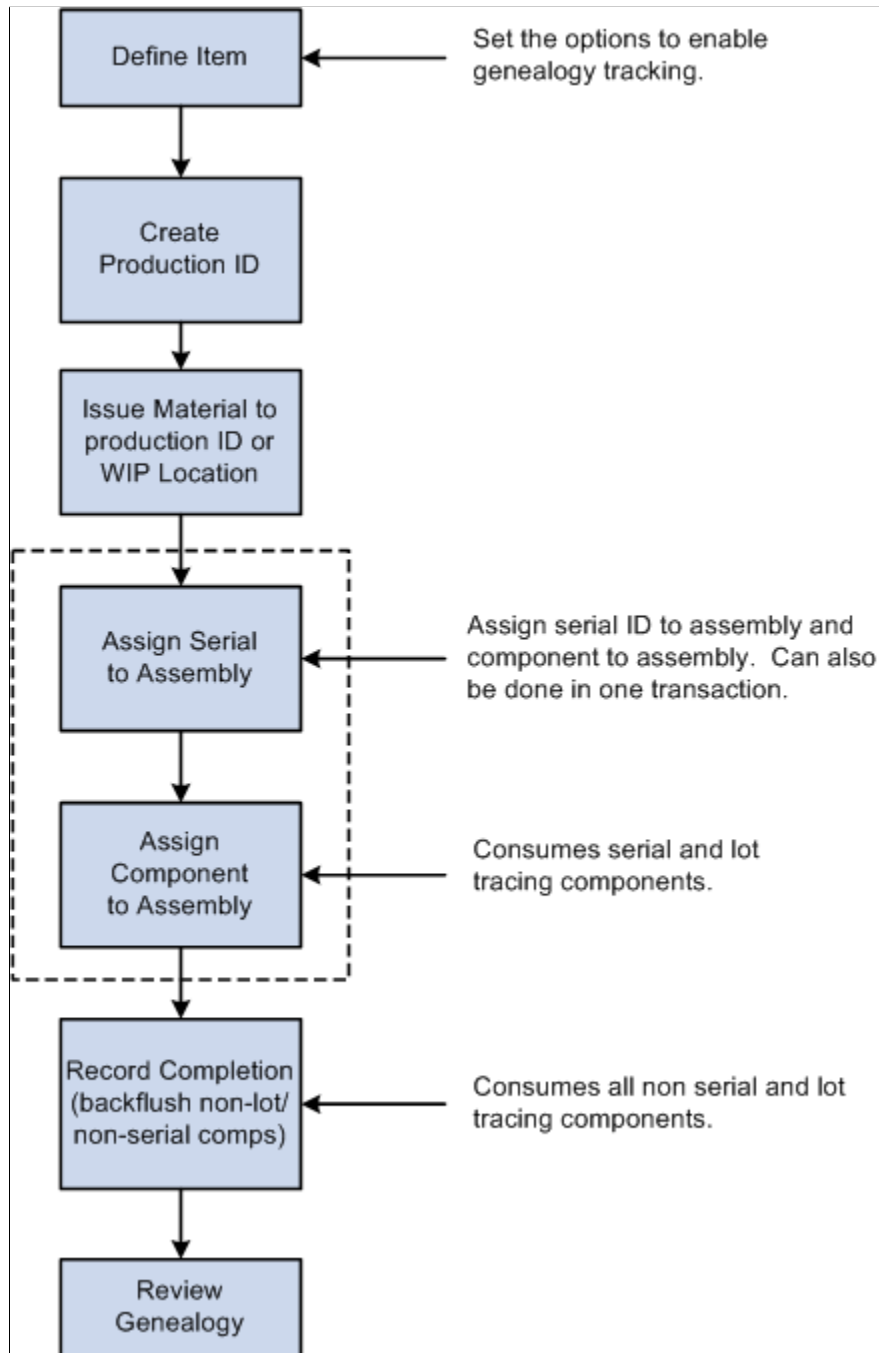

Related Links

[Understanding Production IDs and Production Schedules](#)

[Understanding Component Issue Methods](#)

[Understanding Recording Completions and Scrap](#)

[Understanding the Process of Recording Completions and Scrap Using Electronic Data Collection](#)

[Understanding the Production Close Process](#)

Setting Up Items to be Traced by Serial Genealogy

This section outlines the steps necessary to use serial genealogy:

1. Define and approve the item that will use serial genealogy using the Define Items - Inventory: Tracking Description page.

Set the appropriate serial tracking options.

2. Create a BOM and add the serial genealogy item using the Maintain BOMs and Revisions - Manufacturing BOMs: Summary page.
3. Create a production ID for the item to be produced using the Production ID Maintenance page.
4. Issue material to production using the various material issue processes.
5. Associate the serial ID to the assembly using the Assembly Serial page.
6. Associate the component serial ID or lot ID to the assembly using the Component Serial page.
Review the association by accessing the Genealogy Search (review) page.
Use the Maintain Serial Genealogy component to maintain or associate additional serial IDs.
7. Complete production using the Record Completions and Scrap component.

Note: You can associate a serial ID to an assembly at any time during the manufacturing process.

Serial ID Tracking Control

PeopleSoft Manufacturing enables you to track serial IDs by providing various options to determine the exact amount of control that you need.

Serial control indicates that you want to track the serial ID for each material movement transaction:

- **Ship Serial:** Indicates that you want to track the serial ID when you ship an item.
- **Serial in Production:** Indicates if you want to trace the genealogy of the assembly item during production.
- **Trace Usage:** Indicates if you want to trace the component as it is used in a specific serial assembly.

The combination of these options determines the level of serial control.

Page Used to Set Up Items to be Traced by Serial Genealogy

<i>Page Name</i>	<i>Definition Name</i>	<i>Usage</i>
<u>Define Item: Inventory - Tracking Description Page</u>	INV_ITEMS_DEFIN2	Set serial genealogy options to enable genealogy tracing.

Related Links

[Understanding Recording Completions and Scrap](#)

[Understanding BOM Maintenance](#)

“Defining Items at the SetID Level” (PeopleSoft Managing Items)

Define Item: Inventory - Tracking Description Page

Use the Define Item: Inventory - Tracking Description page (INV_ITEMS_DEFIN2) to set serial genealogy options to enable genealogy tracing.

Navigation:

Items > Define Items and Attributes > Define Item > Inventory > Tracking Description

Item Tracking

<i>Field or Control</i>	<i>Description</i>
<p>Serial in Production</p>	<p>Select this option if you want to track the key serial and lot components that make up this assembly item. You will assign a serial ID to the item during the manufacturing process. You will also identify serial and lot components that are used to produce this item.</p> <p>This field can be used with and without the serial control option. If you do select serial control, then you will enter the serial ID for all material movement transactions. If you do not select the serial control option, then the system tracks the serial ID during the production process. This means that you assign a serial ID to the item during production and associate serial and lot components to this serial assembly. During completions you'll complete the serial ID to inventory.</p> <hr/> <p>Note: Typically, if you select Serial in Production, either <i>Serial Control</i> or <i>Ship Serial</i> will also be enabled. If you select serial in production and not serial control, during subsequent inventory movements of this item, you will not need to enter the serial ID.</p> <hr/>

Field or Control	Description
Trace Usage	<p>This option is used for component items and enables associating the component's serial or lot ID with a higher-level assembly item whose serial in production option is selected.</p> <p>Values include:</p> <ul style="list-style-type: none"> • <i>Serial</i>: Select to enable this component's serial ID to be tracked in a higher level assembly whose Serial in Production option has been selected. <p>If the component's Lot Control option has been selected, then both the serial ID and Lot ID will be tracked.</p> <ul style="list-style-type: none"> • <i>Lot</i>: Select to enable this component's lot ID to be tracked in a higher level assembly whose serial in production option is Yes. <p>To select the trace usage option of Lot, the item's lot control option must be selected.</p> <ul style="list-style-type: none"> • <i>None</i>: Select if you do not want to track this item. <p>Similar to serial in production, trace usage can be used in conjunction with the Serial Control option. If Serial Control option is selected, then the serial ID will be identified in inventory, and this serial ID remains with the item throughout the entire manufacturing process. If serial control is not selected, then the serial ID will not be identified in inventory but a serial ID will be specified when the item is associated with a serial assembly. This allows tracking the genealogy without requiring the need to track the serial ID in inventory.</p>

Note: Typically, if you select the trace usage option of Serial or Lot, the assembly items that this item is used on is set to Serial in Production.

Note: If you change any of these values, it will have an effect on *new* production. Any existing production will retain the serial in production value at the time that the production ID was created. Components will retain the values at the time the component list is created.

Related Links

“Defining Items at the SetID Level” (PeopleSoft Managing Items)

Associating Assembly Items and Components

You can associate assembly items to serial IDs and components to serialized assemblies by using the Assembly Serial page. You can access this page from the Production Control or SCM Integrations navigations.

This section discusses how to Associate Assembly Items and Components.

Pages Used to Associate Assembly Items and Components

Page Name	Definition Name	Usage
<u>Assembly Serial Page</u>	BCT_MG_PRDN	Associate serial IDs with assembly items of a production ID. Use Transaction Code 800 — <i>Associate Assembly</i> to associate a serial ID with a production ID.
<u>Component Serial Page</u>	BCT_MG_USAG	Associate serial or lot components with an assembly serial (Transaction Code 802). Can also be used to associate a serial ID with an assembly and associate the component serial ID or lot ID with that serial assembly (Transaction Code 804).

Assembly Serial Page

Use the Assembly Serial page (BCT_MG_PRDN) to associate serial IDs with assembly items of a production ID.

Use Transaction Code 800 — Associate Assembly to associate a serial ID with a production ID.

Navigation:

- **Production Control > Process Production > Production Genealogy > Record Assembly Serial**
- **SCM Integrations > Create Transactions > Manufacturing > Assembly Serial Association**

This example illustrates the fields and controls on the Assembly Serial page. You can find definitions for the fields and controls later on this page.

Assembly Serial Association

Business Unit US008 Last Trans Nbr. 3000000000000142000000001

Transaction Code 0800 Associate Assembly

Production ID PRD00223 Area GEARS Status In Process

Item ID SR2201 Gear Subassembly

Quantity 2.0000

Serial ID	Find	First	1-2 of 2	Last
1	Serial ID			
2	Serial ID			

Error Messages Personalize | Find | First 1 of 1 Last

Message	Go to Error Row	DateTime
1	Go to Error Row	

Use this page to associate a serial ID to the production ID.

Note: The **Serial in Production** option must be selected for the production ID.

To associate a serial ID with an assembly using Transaction Code 800 - Associate Assembly:

1. Select the Production ID.
2. Enter a **Quantity**. The Serial ID group populates with the number of lines based on the quantity entered.
3. Enter a **Serial ID** to associate with the production ID.
4. Upon saving this page, any errors, such as the serial ID may have already been associated with a different production ID, display in **Error Messages**.

Note: If you made the association using the Production Control navigation, the transaction is processed upon save. However, if you used the SCM Integrations navigation, the transaction will not be processed until you run the Process Serial Association process.

See [Making Serial Associations Using the Batch Process](#).

Component Serial Page

Use the Component Serial page (BCT_MG_USAG) to associate serial or lot components with an assembly serial (Transaction Code 802).

Can also be used to associate a serial ID with an assembly and associate the component serial ID or lot ID with that serial assembly (Transaction Code 804).

Navigation:

- **Production Control > Process Production > Production Genealogy > Record Component Serial**
- **SCM Integrations > Create Transactions > Manufacturing > Component Serial Association**

This example illustrates the fields and controls on the Component Serial page. You can find definitions for the fields and controls later on this page.

Associate serial or lot components to a serial assembly by using Transaction Code *0802 - Associate Component*.

If you're associating both assemblies and components, use Transaction Code *0804 - Associate Assembly & Component*.

Field or Control	Description
Production ID and Serial ID	Enter values.
Associate Assembly Serial	If you're using Transaction Code 804, this check box will be automatically selected. When selected, the system associates the serial ID with the production ID. Once the first serial association is saved, this check box will be deselected so you can associate additional component serial IDs to the serial assembly. If you want to associate serial IDs to assemblies and component serials, then you should select this check box.
Component ID	Enter the component that you're associating or disassociating from the production ID.

Field or Control	Description
Op Seq, Orig Comp ID and Per	You do not have to enter values for these fields. The system will populate them. If the component ID exists at multiple operation sequences or the component is a substitute item you will need to specify this information in order to identify the exact component you are associating or disassociating.
Quantity	Enter the number of components that you are associating or disassociating.
Serial ID	The Serial ID group populates the number of lines based on the quantity entered. Enter or select the appropriate serial ID number.
Lot ID	Enter or select the appropriate lot ID
Error Messages	View any errors associated with the component association.

Note: Upon Save, the production ID field is not deselected. You can add (associate) another component. If you made the association using the Production Control navigation, the transaction is processed upon save. However, if you used the SCM Integrations navigation, the transaction will not be processed until you run the Process Serial Association process.

In addition, issue and replenish components are consumed from the WIP location upon association. Kit components are associated as they have already been consumed on the production ID.

See [Making Serial Associations Using the Batch Process](#).

Disassociating Assemblies and Components

Use the Assembly Serial and Component Serial pages to disassociate serial IDs from assemblies, and to remove components from serialized assemblies. Access these pages from the Production Control or SCM Integrations navigations.

This section discusses how to:

- Disassociate assemblies from serial IDs.
- Disassociate components from serialized assemblies.

Pages Used to Disassociate Assemblies and Components

<i>Page Name</i>	<i>Definition Name</i>	<i>Navigation</i>	<i>Usage</i>
Assembly Serial	BCT_MG_PRDN	<ul style="list-style-type: none"> • Production Control > Process Production > Production Genealogy > Record Assembly Serial • SCM Integrations > Create Transactions > Manufacturing > Assembly Serial Association 	<p>Disassociate serial IDs with assembly items of a production ID.</p> <p>Use Transaction Code <i>0801-Disassociate Assembly</i> to disassociate a serial ID from the assembly.</p>
Component Serial	BCT_MG_USAG	<ul style="list-style-type: none"> • Production Control > Process Production > Production Genealogy > Record Component Serial • SCM Integrations > Create Transactions > Manufacturing > Component Serial Association 	<p>Disassociate serial or lot components with an assembly serial.</p>

Assembly Serial Page

Use the Assembly Serial page (BCT_MG_PRDN) to disassociate serial IDs with assembly items of a production ID.

Use Transaction Code 0801- Disassociate Assembly to disassociate a serial ID from the assembly.

Navigation:

- **Production Control > Process Production > Production Genealogy > Record Assembly Serial**
- **SCM Integrations > Create Transactions > Manufacturing > Assembly Serial Association**

To disassociate a serial ID with an assembly by using Transaction Code 801 - Disassociate Assembly:

1. Select the Production ID.
2. Enter a **Quantity**. The Serial ID group populates with the number of lines based on the quantity entered.
3. Enter a **Serial ID** to disassociate from the production ID.
4. Upon saving this page, any errors, such as the serial ID may have already been associated with a different production ID, display in **Error Messages**.

Note: If you made the disassociation using the Production Control navigation, the transaction is processed upon save. However, if you used the SCM Integrations navigation, the transaction will not be processed until you run the Process Serial Association process.

See [Making Serial Associations Using the Batch Process](#).

Component Serial Page

Use the Component Serial page (BCT_MG_USAG) to disassociate serial or lot components with an assembly serial.

Navigation:

- **Production Control > Process Production > Production Genealogy > Record Component Serial**
- **SCM Integrations > Create Transactions > Manufacturing > Component Serial Association**

To disassociate a component from a serial assembly, use Transaction Code 803 - Disassociate Component.

1. Select the **Production ID** (serial assembly).
2. Select a **Serial ID** to disassociate from the production ID.
3. Select the **Component ID** to be disassociated.
4. Enter a **Quantity** of the component to be disassociated.
5. Upon saving this page, any errors, such as the serial ID may have already been associated with a different production ID, display in **Error Messages**.

Note: If you made the disassociation using the Production Control navigation, the transaction is processed upon save. However, if you used the SCM Integrations navigation, the transaction will not be processed until you run the Process Serial Association process.

See [Making Serial Associations Using the Batch Process](#).

Maintaining Production Being Traced by Serial Genealogy

This section discusses how to maintain production being traced with serial genealogy.

Page Used to Maintain Production Being Traced by Serial Genealogy

<i>Page Name</i>	<i>Definition Name</i>	<i>Navigation</i>	<i>Usage</i>
Genealogy Search (process)	SF_TRACE_U_SRCH	Production Control > Process Production > Production Genealogy > Maintain Serial Genealogy	Select the production ID to which you want to do an association or disassociation.
Maintain Genealogy	SF_TRC_MAINT	Production Control > Process Production > Production Genealogy > Maintain Serial Genealogy	View the parent serial ID information.
Production Picking	BCT_MG_PIK	SCM Integrations > Create Transactions > Manufacturing > Create Mfg Pick Txn	For rework or teardown production IDs, enter the serial ID for the assembly items being reworked or torn down. The system associates the serial ID to the production ID.
Kit Issue/Return Location Kit Issue/Return Kit Issue/ Return Location page	SF_KIT_ISSUE_EXPR BCT_MG_MIS	<ul style="list-style-type: none"> • Production Control > Process Production > Issue Materials > Issue/Return Kit Components • SCM Integrations > Create Transactions > Manufacturing > Issue and Return Kit Comp 	For rework or teardown production IDs, enter the serial ID for the assembly items being reworked or torn down. The system associates the serial ID to the production ID.
Review Plan	SF_PICK_TRANS	Production Control > Process Production > Issue Materials > Review Inventory Pick Plan	For rework or teardown production IDs, enter the serial ID of the assembly items being reworked or torn down. The system associates the serial ID to the production ID.
Recording Completions and Scrap	SF_COMPL_ID BCT_MG_CPL	<ul style="list-style-type: none"> • Production Control > Process Production > Complete Production > Record Completions and Scrap • SCM Integrations > Create Transactions > Manufacturing > Record Completions and Scrap 	Associate assembly serial IDs if the serial that is being completed and has not already associated.

Reviewing Serial Genealogy Information

This section discusses how to Review Serial Genealogy Information

Pages Used to Review Serial Genealogy Information

<i>Page Name</i>	<i>Definition Name</i>	<i>Usage</i>
<u>Genealogy Search (review) Page</u>	SF_TRC_SER_INQ1	Enter selection criteria for serial genealogy inquiry. Use the Review Serial Genealogy to view the genealogy of an item/serial. You can also view where the item/serial currently is at, such as which higher level assembly item it has been used in or to which customer it has been shipped.
Genealogy (review) Page	SF_TRC_SER_INQ2	Displays genealogy information for the item (serial ID) specified in the search criteria. Displays where used and genealogy information. <u>Genealogy Search (review) Page</u>
<u>Genealogy with Traceability Page</u>	SF_TRC_SER_INQ3	View transaction information for the item/serial ID specified in the search criteria. Information is displayed in a grid format.
Transaction (review) Page	SF_TRC_SER_INQ4	View transaction information associated with the specific serial or lot ID. Information is displayed in a pop up window. <u>Genealogy Search (review) Page</u>

Genealogy Search (review) Page

Use the Genealogy Search (review) page (SF_TRC_SER_INQ1) to enter selection criteria for serial genealogy inquiry.

Use the Review Serial Genealogy to view the genealogy of an item/serial. You can also view where the item/serial currently is at, such as which higher level assembly item it has been used in or to which customer it has been shipped.

Navigation:

Production Control > Process Production > Production Genealogy > Review Serial Genealogy

This example illustrates the fields and controls on the Genealogy Search page. You can find definitions for the fields and controls later on this page.

Genealogy Search

*SetID

Business Unit

Item ID

Diablo 500 Touring Bike

Serial ID

Lot ID

Search

Display Options

Levels

Non-Indented Indented

Where Used

Genealogy

Transaction Information

Last Transaction

Field or Control	Description
Item ID and Serial ID	Enter values.

Display Options

Select any of these display options:

Field or Control	Description
Levels	Enter the number of levels that you want to display. The default is 99.
Non-Indented or Indented	<ul style="list-style-type: none"> • <i>Non-Indented</i>: Select if you do not want a non-indented format. • <i>Indented</i>: Select if you want to view the genealogy structure in an indented format.
Where Used	Select this check box if you want to go up the genealogy tree to display where the serial ID is used. This check box is not limited to just production where used. Information relating to which customer the item has been shipped to will also display.
Genealogy	Select if you want to see the children of the serial selected.
Transaction Information	Select if you'd like to view the transaction history for the item. <hr style="border: 0.5px solid black;"/> <p>Note: You must select this option to access the Genealogy with Traceability page.</p>

Field or Control	Description
Last Transaction	Select if you want to see the last transaction that has occurred for this item or serial ID. For example, if the last transaction is a shipment transaction, the customer to whom this serial ID has been shipped displays.

Genealogy (review) Page

Use the Genealogy (review) page (SF_TRC_SER_INQ2) to displays genealogy information for the item (serial ID) specified in the search criteria.

Displays where used and genealogy information.

Navigation:

Enter information on the Genealogy Search (review) page and click the **Search** button.

This example illustrates the fields and controls on the Genealogy page. You can find definitions for the fields and controls later on this page.

The screenshot shows the Genealogy (review) page interface. At the top, there are tabs for 'Genealogy Search' and 'Genealogy'. Below the tabs, search criteria are displayed: SetID SHARE, Business Unit US008, Item ID SR3001, Lot ID, Levels 99, View Non-Indented, Diablo 500 Touring Bike, and Serial ID G2003H057. To the right, the 'Item Type' section includes checkboxes for Serial Control, Lot Control, Shipping Serial Control, and Serial in Prdn, along with a Trace Usage dropdown set to None. Below this is a table titled 'Where Used/ Components' with columns for Lvl, Item ID, Description, Serial ID, Lot ID, UOM, and Quantity. The table lists various subassemblies and their quantities.

Lvl	Item ID	Description	Serial ID	Lot ID	UOM	Quantity
0	SR3001	Diablo 500 Touring Bike	G2003H057		EA	
1	LT5000	Standard Wheel Subassembly		LOT-5001	EA	2.0000
1	SR2201	Gear Subassembly	J2003K088		EA	1.0000
2	GR8000	Gear, Sugishita	G890A10		EA	1.0000
2	GR8500	Crank Set Subassembly	X2003Y099		EA	1.0000
3	GR8301	Bottom Bracket Axle	B2003C123		EA	1.0000
2	HB7300	Hub Subassembly	S70103	LOT-7001	EA	1.0000
1	SR2300	Brake Subassembly	S30301		EA	1.0000

Item Type

Field or Control	Description
Serial Control, Lot Control, Shipping Serial Control, Serial in Prdn, and Trace Usage	These item attributes are display only and are the default values from the Define Items component.

Where Used Components

<i>Field or Control</i>	<i>Description</i>
Serial ID	Click to access the transaction information for the item.
Lot ID	Click to access the transaction information for the item.

Transaction Information Tabs

Access any of these Transaction Information tabs:

<i>Field or Control</i>	<i>Description</i>
Common	View general information such as date and time of transactions, such as production association, or production disassociation and quantities of the items.
Production	View production information such as Prdn ID, Prdn Type, production Area, and Prdn ID split information such as To Prdn ID and To Prdn Area.
Shipment	View shipping information such as Ship To ID, Customer Name, Order No., Ship to, and RMA Number.
Inventory	View inventory-related information such as the Storage Area where the item is stored.
Purchasing	View purchasing-related information such as Order No, Order Line, Supplier ID, Supplier Name, and Return to Vendor ID.

Genealogy with Traceability Page

Use the Genealogy with Traceability page (SF_TRC_SER_INQ3) to view transaction information for the item/serial ID specified in the search criteria.

Information is displayed in a grid format.

Navigation:

Enter information on the Genealogy Search (review) page. You must select **Transaction Information** as a display option on the Genealogy Search page.

Click the **Search** button.

This example illustrates the fields and controls on the Genealogy with Traceability page. You can find definitions for the fields and controls later on this page.

The screenshot shows the 'Genealogy with Traceability' page. At the top, there are tabs for 'Genealogy Search', 'Genealogy', and 'Genealogy with Traceability'. Below the tabs, there are search criteria: SetID (SHARE), Levels (99), Business Unit (US008), View (Non-Indented), Item ID (SR3001), Diablo 500 Touring Bike, Lot ID, and Serial ID (G2003H057). There is also an 'Item Type' section with checkboxes for Serial Control, Lot Control, Shipping Serial Control (checked), and Serial in Prdn. The Trace Usage is set to None.

Below the search criteria, there is a section titled 'Where Used/ Components' with a 'Find' button and a dropdown menu showing '1-8 of 8'. Below this, there is a table with columns for 'Lvl', 'Item ID', 'Serial ID', and 'UOM'. The table shows one row for 'Diablo 500 Touring Bike' with Serial ID G2003H057 and UOM EA. Below the table, there is a 'Transaction Information' section with a 'Personalize' button and a 'Find' button. The 'Transaction Information' section has tabs for 'Common', 'Production', 'Shipment/WO Issue', 'Inventory', and 'Purchasing'. Below the tabs, there is a table with columns for 'Inv BU', 'Description', 'Date/Time', 'Updated By', 'Base Qty', and 'UOM'. The table shows three rows of transaction information for the item 'Diablo 500 Touring Bike'.

Inv BU	Description	Date/Time	Updated By	Base Qty	UOM
US008	Shipped	10/28/03 4:59:41.000000PM	SAMPLE	1.0000	EA
US008	Production Completion	10/28/03 3:38:05.000000PM	SAMPLE	1.0000	EA
US008	Production Association	10/28/03 3:35:55.000000PM	SAMPLE	1.0000	EA

This page appears when you select the **Transaction Information** display option on the Genealogy Search page.

Making Serial Associations Using Third-Party Systems

This section discusses how to make serial associations for production using third-party systems such as electronic data collection or a MES.

PeopleSoft Manufacturing uses the Production Serial Association EIP to import production data that has been associated with serial genealogy by an external system.

Related Links

[Your Enterprise Data Flow](#)

“Setting Up Service Operations” (PeopleSoft Supply Chain Management Integration)

Making Serial Associations Using the Batch Process

You can use the Run Serial Associations (SF_TRC) batch process to associate or disassociate production from serial genealogy. You'll run this batch process if you associated or disassociated production using the SCM Integrations navigation. You will also need to run this process if you have used the Production Serial Association EIP to load associate or disassociate transactions.

Page Used to Make Serial Associations Using the Batch Process

<i>Page Name</i>	<i>Definition Name</i>	<i>Usage</i>
Run Serial Assoc Page	RUN_SF_TRC	<p>Run the batch process for a specific business unit or all business units. You can also run the process based on a specific EIP, range of EIPs or all EIPs.</p> <p>Process serial associations that were loaded through EIPs or through the data collection pages under the SCM Integrations navigation. EIPs can be sent from third-party systems such as a data collection system or a manufacturing execution system (MES).</p>

Generating Serial ID Labels

This section discusses how to generate bar code labels for serialized items.

Page Used to Generate Serial ID Labels

<i>Page Name</i>	<i>Definition Name</i>	<i>Usage</i>
Serial Label Page	RUN_INS6035	Create barcoded serial labels for serialized items.

Generating Serial Genealogy Exception Reports

You can generate serial genealogy exception reports that list those production IDs that have association inconsistencies.

This section discusses how to generate exception reports for production being traced by serial genealogy, and how to correct the exception messages that may occur.

Page Used to Generate Serial Genealogy Exception Reports

<i>Page Name</i>	<i>Definition Name</i>	<i>Usage</i>
Genealogy Except (report)	RUN_SF_TRC001	Generate a report that lists those production IDs that have association inconsistencies.

Reviewing Genealogy Exception Report Messages

This table discusses the exception messages that you may encounter when you generate a Genealogy Exception Report.

Genealogy Report Exception Messages

<i>Exception Message</i>	<i>Warning Description</i>
Assembly Exceptions Serial IDs not associated with Assembly Scrap	There is assembly scrap that does not have a serial ID associated with it. If you want to associate serial IDs to the scrap, you will need to reverse the scrap and then rescrap.
Serial IDs associated > Completed + Scrap	There are serial IDs associated with the production ID that have not been completed or scrapped. You should verify that the serial IDs are still in production
Component serial/lot association rows do not exist	There are completed serial assemblies that do not have any serial or lot components associated. You may need to enter the component association transactions.
Component Exceptions Component Issue <> Trace Usage	You have consumed more serial IDs than have been associated with an assembly. You should verify the correct component associations have been recorded.
Component serial/lot association rows do not exist	You have consumed quantity but no component association rows have been recorded. You should verify the correct component associations have been recorded.
Comp List qty per <> Sum of Trace Issue Qty	You have associated more or less quantity than what is scheduled. You should verify the correct component associations have been recorded.

Related Links

[PeopleSoft Manufacturing Reports: A to Z](#)

Setting Up Production Areas

Understanding Production Areas

Set up production areas before you begin tracking manufacturing processes on the shop floor. Define the production area's default WIP locations, the WIP, rework and teardown accounts, items that are manufactured within each production area, and how each item will be manufactured.

You can associate multiple items with a production area, or you can associate an item with multiple production areas. For example, you can designate one production area for regular production of an item and another for rework or teardown production.

You can define how to move components to the shop floor and how to track production information. For example, do you want to use discrete orders or do you want to track production by day and shift?

When planned orders are generated, they are associated with a production area defined for an item. A production area can:

- Represent a production line, production cell, or manufacturing process.
- Contain all of the work centers necessary to manufacture an item.

Before defining the production area and item relationship, determine how you plan to use production areas to track production on the shop floor:

- Decide whether you plan to use discrete production orders (production IDs) or use production schedules to manufacture repetitively.
- Determine how you plan to issue components to production for each production area and item combination.
- Define a set of WIP accounts for each production area.

Note: You cannot delete production areas.

Tracking Production

After you determine which items are going to be manufactured in each production area, decide whether you want to use discrete production IDs or production schedules to manufacture repetitively in each production area.

Use production IDs if:

- Your company plans to perform completions at intermediate operations to track material and labor and machine usage.

- A subcontractor will perform any operation on the item's routing.

Selecting the Component Issue Method for Each Item

When defining production areas, determine how you want to issue components to production for each item. PeopleSoft Manufacturing provides you with these component issue methods:

- Issue
- Kit
- Replenish
- Use component's

Issue Method

With this method, use picking plans to translate requested stock into material picking instructions for stockroom processing. Once the material has been pulled and the picking plan is confirmed, the system decrements the picked quantities from the quantity available at the stockroom location and issues it to the WIP location. PeopleSoft Manufacturing supports PUSH and PULL picking methods:

Term	Definition
PUSH picking plan	The system determines the locations from which to pick each item and creates a hard reservation for this item when you generate the pick list. A hard reservation reserves the item in a specific location. Once a hard reservation exists, the item is unavailable for other inventory transactions.
PULL picking plan	The system suggests locations from which the stockroom personnel can pull the items. The stockroom personnel then enters the actual location information. When using the PULL method, PeopleSoft Manufacturing does not make a hard reservation at the time the picking plan is generated. Also, the system does not block items from inclusion in other inventory pick lists until after the picking plan is reviewed and confirmed.

Kit Method

Use this method to issue material directly to a production ID rather than to the WIP location, thus preventing other orders from using the material. The kitted material is charged to the production order upon material release, rather than backflushed when an operation or order is completed. The Kit method is the default method for issuing end items for rework and teardown production. The system issues any additional components required for rework or teardown production using the issue method set for each item on the production area and item level. The Kit method is generated by default from the Define Business Unit Item - Manufacturing: General page; you can override it on the Production Area - Item Detail page.

Note: The Kit method is valid with production IDs only.

The Kit method relies on PUSH and PULL pick plans, as does the Issue method. If a completed end item is used on a higher-level end item and the component is issued using the Kit method, you can route the completed end item directly to the production ID.

Replenish Method

In some cases, you may want only a fixed quantity to sit on the shop floor, especially when space is a constraint. Additionally, there may be some items that don't need to be allocated to specific orders or to a production run. In these cases, use the Replenish method. This method assumes that you are stocking components in the WIP storage areas associated with the work center where you use the components. These components are typically stocked to a defined on-hand quantity that you establish. When the quantity on hand for an item falls below its minimum stocking quantity in that location, a Kanban request (if using PeopleSoft Flow Production) or workflow notification is sent indicating that the location must be replenished.

Before you move components into the replenishment locations in the production area:

- Specify the replenishment point for each component that you manage using the Replenish method.
- Specify the issue multiple used to replenish the WIP location.
- Define both of these parameters for each WIP location using the Prdn Replenish Locations - Prdn Replenish Detail page in PeopleSoft Inventory.

If you are using PeopleSoft Flow Production:

- Define other replenishment defaults using the Prdn Replenish Locations - Prdn Replenish Detail page to define how the replenishment is triggered for each WIP location using the WIP Replenishment Mode: Backflush, Kanban Card, or Manual.
- Specify how the replenishment request is communicated with the WIP Replenishment Method: Pull List, Pull Ticket, or Workflow.
- Determine if the material comes from an inventory location, feeder line, or supplier using the WIP Replenishment Source.

If you are using PeopleSoft Flow Production, you can also replenish the WIP locations directly from an inventory location, feeder line, or supplier using Kanban cards or online replenishment requests.

Use Component's Method

To issue some components using one method and others using another method, select Use Component's Method option when defining the component issue method for each production area and item.

To issue the components using any or all of the issue methods for a single end item, select Use Component's Method. When using this method, the system looks at the component's issue method defined at the business unit and item level to determine how to issue the component to the shop floor. Define the default by indicating the issue method for the item using the Item Attributes by Unit - Manufacturing Attributes page.

Related Links

[Prdn Replenish Locations Page](#)

“Defining Items at the Business Unit Level” (PeopleSoft Managing Items)

Setting Up WIP Accounts for Location Accounting

If you are using location accounting to provide financial visibility based on where the items reside, you must:

- Indicate that location accounting is required for the business unit.
- Define a set of account ChartFields for each storage area including WIP and inventory locations.
- Define production area accounts for regular, rework, and teardown production.

Note: You should indicate that location accounting is required and define a set of account ChartFields when you set up the business units and inventory storage areas.

To use location accounting, define a set of account ChartFields, such as account, operating unit, department, product, and project ID for each storage area and production area. These are the accounts that the accounting line generation process debits or credits for material movement, earned conversion costs, and variance transactions. This tables lists some examples:

<i>Transaction</i>	<i>System Debits</i>	<i>System Credits</i>
Issue material to production	WIP storage area or location account	Inventory storage area or location from which material is issued
Backflushing of an item in the production area	Production area account for all material consumption	WIP storage area or location account
Kit item issued to production	Production area account	Material storage area account
Accounting for earned labor, machine costs, and applied overhead	Production area account	Earned labor or applied overhead accounts when you set up the account distribution
End items completed to stock	Account associated with the storage area where the completed items are sent	Production area account

The ChartField functionality provides the necessary features to write debit and credit transactions to the appropriate accounts depending on the type of production taking place.

Related Links

“Defining and Maintaining Material Storage Locations” (PeopleSoft Inventory)

“Understanding Cost Structure” (PeopleSoft Cost Management)

PeopleSoft Supply Planning Considerations

If you are using PeopleSoft Supply Planning, the system uses production area information to determine whether the item should be manufactured using production IDs or production schedules. When determining where the order should be produced, the system looks first for a production area that manufactures the item using the selected BOM and routing combination.

If there are multiple production areas defined for the BOM, routing, and item combinations, the system assigns the planned order based on the item's *primary* production area. Set the primary production area on the Primary Production Area page.

If no production areas have been defined for the BOM, routing, and item combination, the default is the production area, as defined on the Define Business Unit Item - Manufacturing page.

Related Links

[Select Primary Production Area for this Item Page](#)

Common Elements Used in Setting Up Production Areas

<i>Field or Control</i>	<i>Description</i>
Production Area	Area where the end item was manufactured.
WIP Location (owned and non-owned)	The default storage locations for a production area where material is issued or from where material is consumed.
Item	End item being manufactured.
Eff Date (effective date) and Obs Date (obsolete date)	Dates represent the effectivity of the BOM and routing combination set up in the Production Option Maintenance component.
Rate Qty per Shift (production rate quantity per shift)	Default for the daily shift quantity when you are maintaining production schedules.

Field or Control	Description
 (item search button)	<p>Click the Item Search button to access links to various other pages, such as:</p> <ul style="list-style-type: none"> • Item Search: To select a different item. • Production Option Selection: To select a specific production option to be used to manufacture an item. • Primary Production Area: To designate a primary production area where the item is typically manufactured. • Component/Output Mix Inquiry: To view input and outputs by operation sequence for the item. • BOM Maintenance: To modify the BOM information for an item. • Routing Maintenance: To modify the routing information for an item.

Prerequisites

Before you define production areas:

- All WIP locations that you plan to use as production area default WIP locations must be defined as WIP locations using the Storage Areas page in PeopleSoft Inventory.

Define WIP accounts for each production type (*Production*, *Rework*, or *Teardown*) that you plan to perform in the production area.

Note: If you plan to use consigned items as components, define both owned and non-owned WIP locations. Consigned items are stored in non-owned WIP locations until they are consumed. Once consumed, if they are returned to stock, they're returned to an owned location.

- The items that you manufacture must be defined as approved, owned, and standard-costed manufacturing items in PeopleSoft Inventory.
- All applicable transaction accounts and ChartFields must be defined.
- Optionally define valid production options with the Production Option Maintenance components if you're producing co-products and by-products.

Related Links

[“Defining and Maintaining Material Storage Locations” \(PeopleSoft Inventory\)](#)

[“Defining Items at the SetID Level” \(PeopleSoft Managing Items\)](#)

[“Understanding PeopleSoft ChartFields” \(Application Fundamentals\)](#)

[Understanding Production Options](#)

Defining Production Areas

To define and maintain production areas, use the Production Area Maintenance (SF_PRDN_AREA) component.

This section discusses how to:

- Define general information about the production area.
- Select the primary production area.
- Define production area accounts.
- Define production area and item detail.
- Delete production area and item combinations.

Note: The system defines production areas at the business unit level.

Pages Used to Define Production Areas

<i>Page Name</i>	<i>Definition Name</i>	<i>Usage</i>
Production Area: Summary Page	SF_PRDN_AREA_SUM	Define and maintain general information for each production area, indicate default WIP locations, and identify items to be manufactured within a production area. You receive a message if the range of items for the production area exceeds the default of 100.
Select Primary Production Area for this Item Page	SF_PRDNAREA_SEL_SP	Select the default location where the production item will typically be manufactured.
Production Text	SF_PRDN_AREA_HD_TX	Associate text with any production area. Production Control > Define Production > Production IDs/Schedules > Production Area > Production Text
Production Area: Accounts Page	SF_PRAREA_ACCT	Define WIP accounts for production areas.
Production Area: Item Detail Page	SF_PRDN_AREA_ITEM	Define production details for each item associated with a production area.

Page Name	Definition Name	Usage
Area Maintenance - Item Detail - Item Text	SF_PRDN_AREA_IT_TX	Attach production area and item text relating to specific items that are manufactured within a production area. Production Control > Define Production > Production IDs/Schedules > Production Area > Item Detail > Item Text
Production Areas for an Item (inquiry)	SF_PRDN_ITEM_INQ	View all production areas in which an item is manufactured. Production Control > Define Production > Review Production Information > Production Areas for an Item
Production Text for Area/Item (inquiry)	SF_PRDN_ID_TX_INQ	View the text associated with the production area and item. Production Control > Define Production > Review Production Information > Production Areas for an Item > Production Text for Area/Item

Production Area: Summary Page

Use the Summary - Summary page (SF_PRDN_AREA_SUM) to define and maintain general information for each production area, indicate default WIP locations, and identify items to be manufactured within a production area.

Navigation:

Production Control > Define Production > Production IDs/Schedules > Define a Production Area

This example illustrates the fields and controls on the Summary - Summary page: Effectivity tab. You can find definitions for the fields and controls later on this page.

Summary
Accounts
Item Detail

Summary [Production Text](#)

Business Unit: US008

Production Area: FINAL Description:

WIP Location Owned: *Area: FA Level 1: AIS1 Level 2: ROW1 Level 3: Level 4:

WIP Location Non-Owned: NOWN BIN

Area Maintenance Summary
Customize | Find | View All | First 1-3 of 9 Last

Effectivity
Other
🔍

	*Item	Description	BOM	Routing	Eff Date	Obs Date		
<input type="button" value="🔍"/>	MT2000 <input type="button" value="📄"/>	Professional Road Bike, Womans	<input style="width: 30px;" type="text"/> 1 <input type="button" value="🔍"/>	<input style="width: 30px;" type="text"/> 1 <input type="button" value="🔍"/>	01/01/1900	12/31/2099	<input type="button" value="⊕"/>	<input type="button" value="⊖"/>
<input type="button" value="🔍"/>	MT3000 <input type="button" value="📄"/>	Mountain Bike, Womans	<input style="width: 30px;" type="text"/> 1 <input type="button" value="🔍"/>	<input style="width: 30px;" type="text"/> 1 <input type="button" value="🔍"/>	01/01/1900	12/31/2099	<input type="button" value="⊕"/>	<input type="button" value="⊖"/>
<input type="button" value="🔍"/>	MT3010 <input type="button" value="📄"/>	Mountain Bike, Womans - Limite	<input style="width: 30px;" type="text"/> 1 <input type="button" value="🔍"/>	<input style="width: 30px;" type="text"/> 1 <input type="button" value="🔍"/>	01/01/1900	12/31/2099	<input type="button" value="⊕"/>	<input type="button" value="⊖"/>
<input type="button" value="🔍"/>	MT3020 <input type="button" value="📄"/>	Mountain Bike, Womans - Millen	<input style="width: 30px;" type="text"/> 1 <input type="button" value="🔍"/>	<input style="width: 30px;" type="text"/> 1 <input type="button" value="🔍"/>	01/01/1900	12/31/2099	<input type="button" value="⊕"/>	<input type="button" value="⊖"/>
<input type="button" value="🔍"/>	SR1001 <input type="button" value="📄"/>	Omega 500 Touring Bike	<input style="width: 30px;" type="text"/> 1 <input type="button" value="🔍"/>	<input style="width: 30px;" type="text"/> 1 <input type="button" value="🔍"/>	01/01/1900	12/31/2099	<input type="button" value="⊕"/>	<input type="button" value="⊖"/>
<input type="button" value="🔍"/>	SR1002 <input type="button" value="📄"/>	Carrera 6000 Hi Performance Ro	<input style="width: 30px;" type="text"/> 1 <input type="button" value="🔍"/>	<input style="width: 30px;" type="text"/> 1 <input type="button" value="🔍"/>	01/01/1900	12/31/2099	<input type="button" value="⊕"/>	<input type="button" value="⊖"/>
<input type="button" value="🔍"/>	SR1003 <input type="button" value="📄"/>	Mt. Whitney 3000 Mountain Bike	<input style="width: 30px;" type="text"/> 1 <input type="button" value="🔍"/>	<input style="width: 30px;" type="text"/> 1 <input type="button" value="🔍"/>	01/01/1900	12/31/2099	<input type="button" value="⊕"/>	<input type="button" value="⊖"/>
<input type="button" value="🔍"/>	SR1301 <input type="button" value="📄"/>	Denali 500 Touring Bike	<input style="width: 30px;" type="text"/> 1 <input type="button" value="🔍"/>	<input style="width: 30px;" type="text"/> 1 <input type="button" value="🔍"/>	01/01/1900	12/31/2099	<input type="button" value="⊕"/>	<input type="button" value="⊖"/>

Field or Control	Description
<p>WIP Location Owned and Non-Owned</p>	<p>Enter values for the production area. If you are producing items that include non-owned components, for example, you are the subcontractor and the customer is supplying the components, define a non-owned WIP location in addition to the owned WIP location. Additionally, if you receive items that are consigned to you by the suppliers, they must be stocked in a non-owned location until they are consumed in production.</p> <hr/> <p>Note: All consigned items are set up as non-owned. However, consigned manufactured items must be moved to owned WIP locations during the completions process.</p> <hr/> <p>If you are exclusively using owned components in the WIP location, you do not need to identify a non-owned WIP location. Owned inventory can only be issued from and received into an owned inventory location. Likewise, non-owned inventory can only be issued from and received into a non-owned inventory location.</p> <hr/> <p>Note: The transfer of consigned inventory from a non-owned location to an owned location results in the recognition of the payment liability.</p> <hr/> <p>The owned and non-owned WIP locations for a production area indicate the locations where material should be issued or consumed, if the component's issue method is set to <i>Issue</i> or <i>Replenish</i> and any of these conditions exist:</p> <ul style="list-style-type: none"> • No routing exists for the item. • An invalid WIP location is associated with any work center on the item's routing. • The operation sequence on any of the item's components is zero or nonexistent.
<p>Storage Area</p>	<p>The system displays the number of storage levels in the Area, Level 1, Level 2, Level 3, and Level 4 fields that have been defined for each storage area.</p>

Effectivity Tab

Field or Control	Description
<p>Item</p>	<p>Select an item. You can associate one or more items with each production area. You can specify any approved item, except floor stock, planning, and expensed items.</p> <hr/> <p>Note: When adding an end item with an item status of <i>Hold</i> or <i>Discontinue</i>, you receive a warning message.</p> <hr/>

Field or Control	Description
 (detail button)	Click the Detail button to access the Item Detail page.

Field or Control	Description
<p>BOM and Routing</p>	<p>Enter values for these fields.</p> <p>If you are maintaining production IDs, you can associate BOM and routing code combinations, along with their effectivity dates, with the production area and item combination. This is the default that appears when manually adding a production ID for the area and item combination. Change the BOM or routing code to manufacture the item using an alternate BOM or routing.</p> <p>If you're maintaining production schedules, the BOM and routing codes that you define are the BOMs and routings used to manufacture the item in the production area and cannot be changed on the individual production schedules.</p> <p>If the BOM and routing combinations for the item have been defined using the Production Option Maintenance component:</p> <ul style="list-style-type: none"> • You can select from those predefined production options which can have effective-dated combinations. • You can assign the combinations to production areas in the Production Option Maintenance component. <hr/> <p>Note: If you have not used the Production Option Maintenance component to define the combinations for the item, you can select from any valid BOM or routing combination, but you won't be able to assign effective dates.</p> <hr/> <p>There's a difference between using BOM and routing combinations when maintaining production IDs and using them when maintaining production schedules. The BOM and routing area combination for production IDs is really a default combination, depending on the effective date, but it can be overridden manually.</p> <p>For production schedules, the BOM and routing and area combination is the combination that is actually used on that schedule. It is based on the business unit and item production area for which the schedule was created. You cannot override the BOM and routing area combination if you are using production schedules.</p> <p>Both production IDs and production schedules use BOM and routing area combination effective dates if they are defined.</p> <p>The routing indicates whether this is the primary routing (routing code 1) or alternate routing (routing codes 2 through 99). You can leave this field blank or select a predefined BOM and routing for the item. The routing that you specify should designate the routing used to manufacture the item in this</p>

Field or Control	Description
	<p>production area. If a primary routing exists for this item, the system automatically provides this routing as a default.</p> <hr/> <p>Note: Routing codes cannot be entered for expensed or planning items.</p> <hr/> <p>When defining a routing code for the item, the system verifies the item's planning attributes to determine whether the item is scheduled using the item's routing or a fixed and variable lead time.</p> <p>When a lead time is used, the system issues a warning that the routing code specified will be ignored for planning and scheduling purposes</p> <p>When a routing is used for scheduling and one is not specified with the item, the system issues a warning that the item cannot be scheduled.</p> <p>If you have selected the Valid Production Options only check box in the Production Option Control group box on the Define Business Unit Item - Manufacturing page in PeopleSoft Inventory, you can only define BOM and routing combinations set up in the Production Option Maintenance component.</p> <hr/> <p>Note: Associate a production area to a production option.</p> <hr/>
Eff Date (effective date)	<p>This field is available if you have the same BOM and routing combination with multiple effective dates (such as seasonal changes for multiple years).</p>

Note: There can be only *one* valid BOM and routing combination effective for an item per production area for a specific time period. However, you can create multiple combinations providing the effectivity dates do not overlap.

Other Tab

<i>Field or Control</i>	<i>Description</i>
Revision	<p>Select the revision for the item if the item is revision-controlled and you want to manufacture a specific configuration of the item. This revision becomes the default when adding production IDs or production schedules. The revision defined on the production ID or production schedule determines the BOM used when producing the item.</p> <p>When you leave this field blank and no revision is specified on the production ID or the production schedule, the system uses the due date of the production to determine which BOM to use to produce the item. If the item's effectivity is not revision-controlled, this field is unavailable.</p>
Maintain PID (maintain production ID)	<p>Select if:</p> <ul style="list-style-type: none"> • You are planning to maintain production IDs for this item. • Incremental backflushing or completions are going to be performed. • Count points have been defined on the item's routing. • A subcontractor is to perform an operation on the item's routing.
Primary	<p>If this production area is the item's primary production area, this check box is selected and unavailable. Select the primary production area on the Area Maintenance - Summary: Primary Production Area page.</p>
Rate Qty per Shift (production rate quantity per shift)	<p>Use this field only for production schedules. It is unavailable if the Maintain PID check box is selected.</p>

Related Links

[Understanding Production Options](#)

[Understanding BOM Maintenance](#)

“Understanding PeopleSoft Engineering Bills of Material” (PeopleSoft Engineering)

“Define Business Unit Item - Manufacturing: General Page” (PeopleSoft Managing Items)

[Understanding Tasks](#)

Select Primary Production Area for this Item Page

Use the Select Primary Production Area for this Item page (SF_PRDNAREA_SEL_SP) to select the default location where the production item will typically be manufactured.

Navigation:

Production Control > Define Production > Production IDs/Schedules > Define a Production Area

Click the **Item Search** button and click the **Primary Production Area** link.

This example illustrates the fields and controls on the Select Primary Production Area for this Item page. You can find definitions for the fields and controls later on this page.

Select Primary Production Area for this Item Help

Production Areas							Personalize Find View All	First 1-2 of 2 Last
Primary Prdn Area	Area	Item	BOM Code	Routing	Eff Date	Obsolete Date		
<input checked="" type="checkbox"/>	FINAL	MT2000	1	1	01/01/1900	12/31/2099		
<input type="checkbox"/>	REWORK	MT2000	1	1	01/01/1900	12/31/2099		

The primary production option identifies the primary production area for a specific BOM and routing code combination. This occurs because PeopleSoft Supply Planning enables you to plan for multiple BOM and routing code combinations. This primary production area option enables PeopleSoft Supply Planning to determine the production area that the production ID or production schedule to be manufactured.

This example illustrates how this works:

<i>Production Area</i>	<i>BOM Code</i>	<i>Routing Code</i>	<i>Primary Production Area?</i>
AREA1	1	1	Yes
AREA2	1	1	No
AREA3	2	2	Yes
AREA4	2	2	No

Using this example, if PeopleSoft Supply Planning generates one supply record (such as a production ID) with a BOM and Routing code equal to 1 and one with a BOM and routing code equal to 2, then the system would use AREA1 for the first supply record and AREA2 for the second supply record.

Note: Because primary production areas are defined at the BOM and routing combination level and these combinations can be effective-dated, the production area is the primary production area only for the dates specified on the combination.

<i>Field or Control</i>	<i>Description</i>
Primary Prdn Area (primary production area)	<p>If you enter the page and the correct primary production area is selected, then click the Cancel button to return to the Area Maintenance - Summary page.</p> <p>To change the primary production area, select the check box next to the production area that you want to designate as the primary location where this item is manufactured. When you click OK, the system accepts your changes.</p>

Production Area: Accounts Page

Use the Production Area: Accounts page (SF_PRAREA_ACCT) to define WIP accounts for production areas.

Navigation:

Production Control > Define Production > Production IDs/Schedules > Define a Production Area > Accounts

ChartFields that you define on this page are used as the debit or credit accounts when material is received or issued from the production ID or production schedule assigned to the production area. The accounts that you assign here track in-process inventory.

Important! Before you can associate accounts to the production area, you must first define ChartFields using the Define Values page. Select **Set Up Financials/Supply Chain > Common Definitions > Design ChartFields > Define Values**.

<i>Field or Control</i>	<i>Description</i>
Location Accounting Required	To use location accounting, select the Location Accounting option when defining options on the PeopleSoft Inventory Options page.
Production Type	Select to define ChartFields. You can define a set of accounts for production, rework, and teardown production.
Cost Element	<p>To define production area ChartFields, enter a different ChartField for each element of an item's cost, apply a single ChartField to all cost elements, or enter a combination of the two.</p> <p>For example, if item A has a material cost element of 100 and item B has a material cost element of 101, define ChartFields on this page for both cost elements. If you want to use the same ChartField, regardless of the cost element, leave the field blank.</p>

Field or Control	Description
Cost Element, Account, Alternate Account, Operating Unit, Fund Code, Department, Program Code, Class Field, Budget Reference, Product, Project, Affiliate, Fund Affiliate, and Statistics Code	<p>Select the ChartFields appropriate for this production area. When you create accounting entries, the system debits the ChartFields specified here for any material consumption, kit issues, earned labor, applied overhead, or favorable variances, and credits the ChartFields for any end item completions to stock or to another production area, end item scrap, or unfavorable variances.</p> <p>Enter a value if you want the transaction quantity incorporated as part of the accounting information.</p> <hr/> <p>Note: If you have the Combo Edit (combination edit) option set on the PeopleSoft Inventory Business Unit Options page, the system performs ChartField combination edits that you enter on this page.</p> <hr/>
Save	<p>The system verifies that the ChartField combinations are valid.</p> <p>If the ChartField combinations that you enter are valid, the system accepts the entry. If the ChartField combinations that you enter are not valid, the system displays a message giving you a count of the ChartField combinations that are in error, with a check mark next to them. You can correct the combinations before you proceed.</p>

Related Links

“Setting Up Location Accounting” (PeopleSoft Inventory)

“Understanding ChartField Combination Editing” (Application Fundamentals)

Production Area: Item Detail Page

Use the Production Area: Item Detail page (SF_PRDN_AREA_ITEM) to define production details for each item associated with a production area.

Navigation:

Production Control > Define Production > Production IDs/Schedules > Define a Production Area > Item Detail

This example illustrates the fields and controls on the Production Area: Item Detail page. You can find definitions for the fields and controls later on this page.

Field or Control	Description
Owned and Non-Owned WIP Locations	You can change the values for these fields.

Area Maintenance Detail

Field or Control	Description
Item	Appears for each production ID or production schedule. The item cannot be changed or deleted once a production ID or production schedule has been created for the item.
Rtg Itm (routing item)	Displays the routing used to manufacture this item. The end item may have its own routing or reference another item's routing for its manufacturing methods. The referenced routing can be assigned directly to the end item, its item group, or its item family.
BOM and Routing codes	You can change the values for these fields.
Revision	(Optional) Select a revision to use for this item.
Rate Qty per Shift (production rate quantity per shift)	Whether you can enter a whole number or a decimal in this field depends on the item's unit of measure and quantity precision combination defined in PeopleSoft Inventory.

Field or Control	Description
Source Cd (source code)	Displays the value for the assembly item. Only items with a source code of <i>Make</i> or <i>Buy</i> can be assigned to a production area.
Prdn Opt Cntl (production option control)	Displays the value that indicates whether the item has been defined as using production options with the Item Attributes by Unit - Manufacturing page.
Maintain Production IDs	Deselect this check box if there is no existing production for this item and if you want to change from maintaining production IDs to maintaining production schedules.
Primary Prdn Area (primary production area)	The check box is selected and unavailable if this is the item's primary production area. Select the primary production area on the Primary Production Area page accessed through the Area Maintenance - Summary page.
Component Issue Method	<p>Indicates how the end item's components are issued for production.</p> <p>See Selecting the Component Issue Method for Each Item.</p> <hr/> <p>Note: The component issue method can be different in each production area for the same item.</p> <hr/>
Status	Select Active or Inactive . If you select Inactive , then new production IDs or production schedules cannot be defined for the production area or item. However, you can maintain any production that you've previously defined, and track any existing production in process until it's completed and closed.

Field or Control	Description
Completion Warnings	<p>Select a value to indicate the situations in which warnings should be sent during the completions process:</p> <ul style="list-style-type: none"> • Pending Component Issue Qty: Select this check box to send warnings if there are pending component issue quantities during a backflush. Pending quantities can be caused to incomplete lot IDs, negative quantities when the business unit does not allow negative quantities, or other causes. • Outstanding Comp. Issue Qty: Select this check box to send warnings if there are outstanding component issue quantities. This warning occurs if you are completing quantity at the last operation sequence and at least one component's total issue quantity is less than the scheduled quantity.

Related Links

“Establishing Quantity Precision and Rounding Rules for Items” (PeopleSoft Managing Items)

Defining and Viewing Master Routings

Select Primary Production Area for this Item Page

Deleting Production Area and Item Combinations

You can delete an existing production area and item combination only if there are no production IDs or production schedules for that production area or item.

You can archive and purge production IDs and production schedules by using the Production Data Archiving process.

See Understanding the Production Archive and Purge Process.

Maintaining Production Orders and Production Schedules

Understanding Production IDs and Production Schedules

PeopleSoft Manufacturing's flexible model enables you to define, maintain, and track production by discrete batches or by production schedules. Production IDs can be used when it's necessary to track information using discrete orders or batches. Production schedules can be used when you want to manage production by day or shift. Alternatively, you can simply backflush an item within a production area even though a schedule has not been previously established, and the system automatically creates the supporting production schedule for you.

You can also use production IDs to create rework orders to track material, machine, and labor costs associated with the rework production. Teardown orders use production IDs to track costs associated with tearing down an end item into its component parts.

When you defined the production areas for the manufacturing items, you indicated whether you wanted to track production at a detailed level using production IDs, or at a summary level using production schedules. Production IDs also enable you to report intermediate completions at various operations in an item's manufacturing process. In addition, production IDs enable you to set up any operation on the item's routing as a subcontracted operation.

If you use production schedules, you can create multiple schedule quantities per shift. You enter quantities for each day of the week, and the system determines the start date when the production schedule is added. This enables you to sequence production throughout the day.

If you are using PeopleSoft Supply Planning, you'll generate production ID and production schedule recommendations for regular production when you create the plan and schedule production. PeopleSoft Supply Planning sends recommendations to PeopleSoft Manufacturing in the form of messages.

You can accept and process recommendations (planning messages) to add new production or to apply changes to existing production. The planning messages that recommend changes to existing production include:

<i>Term</i>	<i>Definition</i>
Schedule changes	PeopleSoft Supply Planning recommends a scheduling change when start and end times are changed, when production calendars change, or when work centers or resources are no longer available for the originally scheduled production times.

<i>Term</i>	<i>Definition</i>
Cancellation recommendations	PeopleSoft Supply Planning recommends cancellation when it finds that the specified production is no longer needed because the demand for an order or scheduled quantity no longer exists.

Important! PeopleSoft Supply Planning does not recommend creating rework or teardown production. Create rework and teardown production IDs manually using PeopleSoft Manufacturing.

Before you create production IDs and production schedules, you need to determine the type of production. The following sections review production types and provide an overview of the production creation process—from generating planned production to scheduling production IDs and production schedules.

Related Links

[Understanding Recording Completions and Scrap](#)

Production Types

When you manufacture items, you may need to perform additional work on a completed end item that has already been moved out of production and into stock. You might need to do this to correct a defect in the end item, convert the end item to a different end item, implement an engineering change, tear down an end item into its component parts, or for any purpose other than the normal build of an end item from its production bill of material (BOM).

PeopleSoft Manufacturing provides three production types:

<i>Term</i>	<i>Definition</i>
Production	Use this type for regular manufacturing. The system uses the production BOM to determine the material that needs to be issued and consumed. The BOM is also used as the basis for valuation and for calculating cost variances. In addition, the system also uses the specified production routing for the end item to determine the operations that are necessary to manufacture the end item.

Term	Definition
Rework	<p>Use this type when you need to do additional or repair work on a completed end item. In this case, the system can use a rework BOM to issue and consume material when you have a standard rework process that requires additional components. Whether or not you have a rework BOM, the system automatically adds the end item being reworked to the component list when you release the rework production ID. The system automatically applies the kit issue method to the end item being reworked when the component list is created. You can add other components to the component list as needed to repair or rework the end item, and the system uses the issue method set at the production area and item level for each component.</p> <p>The issue method appears automatically from the Define Business Unit Item - Manufacturing page, and it can be overridden on the Production Area - Item Detail page.</p> <p>You cannot use multiple outputs with rework production; the output list only includes the reworked item as the end item. In addition, you can create a rework routing for standard rework processes with common operations. When a rework routing has been defined and then selected for the rework production ID, an operation list is automatically created. Because the use of an operation list is optional for rework production, you can also manually create and maintain an operation list as needed to repair or rework the end item.</p> <p>You can change the production type from <i>Production</i> to <i>Rework</i>, or from <i>Rework</i> to <i>Production</i>, if the status is <i>Firmed</i>. If it's in the <i>Released</i> status, you can change the production type as long as subcontracted purchase orders have not been generated against the production ID.</p> <p>If you are changing the production type to <i>Rework</i> in the <i>Released</i> status, the system automatically adds the end item to be reworked to the component list with the kit issue method. Either select a rework BOM code or modify the component list by manually adding any additional items that you need for rework in addition to the end item. You can select a rework routing code.</p> <p>If you change the production type to <i>Production</i>, you are prompted to create a new component list. PeopleSoft Manufacturing then builds a new component list and operation list automatically.</p> <p>Material consumed and labor- and machine-time expended for rework are highly visible on production reports and inquiries.</p> <hr/> <p>Note: PeopleSoft Manufacturing uses only production IDs for rework production.</p>

Term	Definition
Teardown	<p>Use this type when you need to break down an end item into its component parts and return the components to inventory. The system does not use a BOM for teardown production, but it issues the completed end item as the component. You designate the component parts that result from tearing down the end item as teardown outputs on the output list. You can use either of these methods to create teardown production IDs:</p> <ul style="list-style-type: none"> • Base a teardown production ID on an existing production ID so that the original configuration can be retrieved and torn down. • Specify teardown components on a production BOM and a teardown routing so that you can set up a default configuration and teardown steps in advance if no existing production ID is available. <p>If a production ID is not selected, the output list is based on the components designated as teardown components on the item's production BOM. The operation list is always based on the teardown routing if one is defined and selected.</p> <p>You can change the production type from <i>Production</i> to <i>Teardown</i>, or from <i>Teardown</i> to <i>Production</i>, if the status is <i>Firmed</i>. If you are changing from <i>Teardown</i> to <i>Rework</i> in the <i>Released</i> status, you can either select a rework BOM code or rebuild the component list by adding items that you need in addition to the end item. You can also select a rework routing code.</p> <p>If you are changing from <i>Teardown</i> to <i>Production</i>, create a new component list. In this case, the item's regular BOM is used.</p> <hr/> <p>Note: PeopleSoft Manufacturing uses only production IDs for teardown production.</p> <hr/>

Production Statuses

Every production ID and production schedule has a status that indicates where the production ID or production schedule is in the production cycle. These statuses are used throughout PeopleSoft Manufacturing.

Entered

The system recognizes a production ID's quantity, start date, and due date, but the order has no operation list or component list. In addition, the system creates a display-only output list for production with the status *Entered*. If production is for a single output item, an output list is generated with the end item listed as the primary item.

You can:

- Change the production order's status from *Entered* to *Firmed* or *Released* using the Production ID Maintenance component, the Production ID Status Change page, or the Production Schedule Status Change page.
- Record end item completions and scrap for *Entered* orders if you release production using the Record Completions/Scrap component.
- Select an option at the business unit level to release production IDs automatically, to prompt you when releasing production IDs, or to not release production IDs automatically.

Firmed

A *Firmed* production ID or production schedule has a quantity, start date, and due date, but the BOM and routing are frozen and the component and operation lists exist. In addition, the output list also exists and can be changed. You cannot generate a picking plan for a *Firmed* order.

You can:

- Change the production status from *Firmed* to *Released* using either the Production ID Maintenance component, the Production Schedule Maintenance component, the Production ID Status Change page, or the Production Schedule Status Change pages.
- Change the order from *Firmed* to *Entered* using the same pages.

Record end item completions and scrap for *Firmed* orders if you release production using the Record Completions/Scrap component.

- Select an option at the business unit level to release production IDs automatically, to prompt you when releasing production IDs, or to not release production IDs automatically.

If you change the production start quantity or the production end quantity, the system recalculates the component requirements accordingly. If the production ID or production schedule contains multiple outputs such as primary items, co-products and by-products, the system also recalculates new output quantities.

In addition, if you're using operation yield, the system then readjusts starting or ending quantities for single output and multiple output production.

You can enter either a new start quantity or a new end quantity, but not both.

If a new routing code or revision is specified or the due date of production is changed, you can recreate the component and operation lists based on the new information associated with the production ID.

If a rework production ID is added and a rework BOM and routing have been defined, the routing is copied to create an operation list. Additionally, the item to be reworked is added automatically to the component list with the kit issue method. An output list is created with the rework item as the primary output.

If a teardown production ID is added, a component list is created with the teardown item as the component. The system assigns the kit issue method to the item to be torn down. If there are any additional components, the system issues them using the issue method set for each item on the production area and item level. If you have previously defined a teardown routing, it is copied to create an operation list. An output list is created based on either the component list of another production ID or the teardown components designated on the item's production BOM.

Released

In the *Released* status, the production has a component list, an operation list, and an output. All of these can be modified. Additionally, each operation's start date, due date, and time are determined. Once released, changing a production ID can result in the deletion of the existing component list and operation list. The lists are then re-added, based on the new information associated with the production ID.

If you change the production start quantity or production end quantity, the system recalculates the component requirements accordingly. If the production ID or production schedule contains multiple outputs (primary items, co-products and by-products), the system recalculates new output quantities.

For rework production IDs, the system creates a component list with the reworked end item as a component. The scheduled quantity is the same as the production ID quantity.

If you have created a rework BOM for the item, the system copies that to the component list as well. If additional material is needed to complete the rework, you can manually add the items to the component list. The system issues the additional components using the issue method set for each item at the production area and item level.

If you have created a rework routing, the system copies it to the operation list. If there is no rework routing, the system does not create an operation list for rework production, but you can manually create one. An output list is created with the rework item as the only output.

You can:

- Generate a picking plan.
- Record completions and scrap.
- Modify the production start quantity or production end quantity.
- Add or change by-products for production.
- Change the status from *Released* to *Firmed* or *Entered*, except for a production ID with subcontracted operations if a purchase order has been generated against the production ID.

In Process

When you have recorded production transactions such as issuing or consuming components and recording completions, scrap, or actual hours, the system automatically changes the production status to *In Process*. You can only change the text, the scheduling method, the production quantity, and the production ID's start or due date and time, depending on the scheduling method.

You can modify the production start quantity or production end quantity for a production ID or production schedule in the *In Process* status after production has been started.

- If you increase or decrease the production start or production end quantity, the system recalculates the component requirements accordingly.

If the production ID or production schedule contains multiple outputs (primary items, co-products and by-products), the system recalculates new output quantities.

- If you decrease the production start or production end quantity, the system verifies that you are not decreasing the order quantity to less than what has already been reported as completed or scrapped.

You receive warning messages if components have been over-issued or over-consumed based on the new order quantity.

In either case, the system adjusts the component scheduled quantities to reflect the new order quantity and marks the production ID as changed so that PeopleSoft Supply Planning reschedules the operations during the next planning run.

You can also:

- Generate production ID splits for production IDs with a status of *In Process*.
- Change *In Process* orders back to *Released* or another prior status if any completion quantities (at an operation or to stock) have been completely reversed.

To do this, you must reverse all end item completions and scrap, return components to stock, and reverse all actual hour recordings to correct completions or actual hours errors that have been reported against a particular production ID.

You cannot modify operation yields once the order is in process.

Note: You cannot change the production quantity if the production ID has a subcontracted operation and you've generated a purchase order for the ID.

Pending Complete

The *Pending Complete* status indicates that the scheduled production start or production end quantity has been completed or production for the day and shift has been completed, and you have selected the Production Completed check box on the Complete Production page in the Record Completions/Scrap component.

Complete

To change production to the *Complete* status, the scheduled quantity must be finished and you must have run the Close Production process to close the production ID or production schedule to any material movement. After an order is in the *Complete* status, you cannot record any operation or end item completions or any additional component consumption or scrap.

Note: Production must be in the *In Process* or *Pending Complete* status before you can change it to *Complete*.

Closed for Labor

The system sets the *Closed for Labor* status when you run the Close Production process to close the production ID or production schedule to any additional actual labor or machine hour recording. You can change the production status *Closed for Labor* from *In Process*, *Pending Complete*, or *Complete*.

Closed for Accounting

When you run the Close Production process to accounting, the system sets the production status to *Closed for Accounting*, which closes the production ID to all transactions and records the variances associated with production.

Canceled

The *Canceled* status cancels existing production quantities associated with a production ID. You can cancel production if the production status is *Entered*, *Firmed* or *Released*. You cannot cancel a production ID with subcontracted operations if a purchase order has been generated against the production ID.

Related Links

[MFG Business Unit Options Page](#)

[Understanding Releasing Production and Changing Production Statuses](#)

[Understanding Recording Completions and Scrap](#)

[Understanding the Production Close Process](#)

Production Status Changes

When the status on the production ID or production schedule is changed, these actions occur:

Status	Action
Entered (new order)	Creates a header record, but an operation list or component list is not created. In addition, a display-only output list is created.
Entered to Firmed	Creates frozen operation and component list.
Entered to Released	Creates operation and component list.
Firmed (new order)	Creates header, operation list, and component list.
Firmed to Released	Status change only.
Firmed to Entered	Deletes operation list and component list.
Released (new order)	Creates header, operation list, and component list.
Released to Entered	Deletes operation list and component list.
Released to Firmed	Status change only.

Rework Production

Rework production works in a manner similar to regular production, but with several exceptions. Add rework production IDs for current production in the *Released* status. The system automatically creates the component list using the rework BOM for rework production IDs, and it copies the end item to be reworked to the component list. The system assigns the kit issue method to the end item to be reworked when the component list is created and uses the issue method set at the production area and item level for each additional component. The default issue method is set on the Define Business Unit Item -

Manufacturing page and can be overridden on the Production Area - Item Detail page. If the item has a rework routing defined, the system copies the routing to the operation list. Create rework production IDs with the *Firmed* status for production scheduled for future dates. The system creates frozen rework component lists and operation lists.

Teardown Production

You cannot create teardown production IDs in the *Entered* status; you must create them with a status of *Firmed* or *Released*. The system assigns the kit issue method to the end item to be torn down when the component list is created and uses the issue method set at the production area and item level for each additional component. The default issue method is set on the Define Business Unit Item - Manufacturing page and can be overridden on the Production Area - Item Detail page. The system creates the teardown output list, either by copying the components on the original production ID or by using the teardown components designated on the BOM.

Effect of Serial Genealogy on Rework or Teardown Production

If you're using serial genealogy, the serial association occurs when the assembly item is issued to the production through kit issues or the picking process. You are prompted to enter the serial ID that is issued to the rework or teardown production ID.

Related Links

[Understanding Releasing Production and Changing Production Statuses](#)

Creation of New Production IDs or Production Schedules

Create production IDs or production schedules by:

- Automatically creating production IDs or production schedules based on recommendations generated by PeopleSoft Supply Planning.
- Manually adding production IDs by using PeopleSoft Manufacturing pages.
- Manually adding production schedules by using PeopleSoft Manufacturing pages.

Note: Use the PeopleSoft Supply Planning solvers to manage and schedule the shop floor.

Actual Dates and Production Due Dates

All production IDs and production schedules maintain production date and shift information, as well as actual date and time information.

Production date and shift information is defined as the working day and shift (or manufacturing day and shift) during which component and production scheduling may be done. Define the production dates and shifts through the business unit's production calendar or the work center calendars. For example, on the production calendar for the month of March, you specify that you are working three shifts on 3/29/07. You just defined a production date of 3/29/07 with three production shifts: 1, 2, and 3. In this example, shift 1 runs from 7 a.m. to 3:30 p.m. When the start date and time or due date and time is determined, the time is converted to the appropriate shift. In this example, a start time of 2 p.m. would equate to shift 1.

Actual date and time is defined as the actual date and time the production is scheduled to begin or end based on the standard calendar. In most cases, the production dates and actual dates are the same. If you have production shifts that span multiple standard calendar dates, the actual date for production may be different than the production date. The system determines the actual date by the actual time that the production is scheduled to start or end within the production shift and the operation start quantity.

These examples explain and illustrate the differences between how PeopleSoft Manufacturing determines production date and shift information as well as actual date and time information when a shift:

- Begins and ends on the same calendar date.
- Spans multiple calendar dates.

Shift That Begins and Ends on the Same Standard Calendar Date

Suppose that a company runs seven days a week with one shift that starts at 7 a.m. and ends at 4 p.m. A production schedule can now be defined for a production due date and due shift. In the example, the actual due date is 3/25/07 and the due time is 3:30 p.m. Because this shift does not span multiple standard calendar dates, the production due date and shift for the production is 3/25/07, shift 1.

Shift That Spans Multiple Calendar Dates

For shifts that span multiple dates, define whether the start time or end time of the shift is associated with the manufacturing production dates. Define this option when setting up the shift codes using the Shift Codes page. Associate this shift code with a manufacturing production date and shift when maintaining production or work center calendars.

Based on whether you want the start time or end time of the shift to be associated with the manufacturing production date, the system first determines the actual date and time information and then the production date and shift information. These examples illustrate how the system determines the production date and shift based on whether you want the start time or end time of the shift to be associated with the manufacturing production date.

Example 1: Production Date Time Set to Start Time

Suppose that a company runs three shifts and the third shift starts at 8 p.m. and ends at 2 a.m. This shift is defined with the start time associated with the production date. A production schedule can now be defined for a production due date and due shift. In the present example, production is due to end on 3/26/07 at 1:30 a.m. Because the shift in which production takes place actually begins on 3/25/07 at 8 p.m., the production date and shift is recorded as 3/25/07, shift 3. The actual date and time appears as 3/26/07 at 1:30 a.m.

Example 2: Production Date Time Set to End Time

Suppose that a company runs three shifts, and the first shift starts at 10 p.m. and ends at 6 a.m. This shift is defined with the end time associated with the production date. A production schedule can now be defined for a production due date and due shift. In the present example, production is due to end on 3/27/07 at 5:30 a.m. Because the shift ends at 6 a.m. and the flag indicates the production date is set to the shift's end time, the production due date and shift is 3/27/07, shift 1. The actual due date and time appears as 3/27/07 at 5:30 a.m.

When defining production IDs, you specify the actual date and time information, and the system determines the corresponding production date and shift information. When defining production schedules,

you specify the production date and shift information, and the system determines the corresponding actual date and time. For production schedules, you can specify the actual time within the production shift. In this case, the system determines the actual date.

Regular Production Scheduling

For each production ID or production schedule that you create, a scheduling method (forward or backward) is defined either automatically or manually, depending on how the production ID or production schedule is created.

Production IDs and Production Schedules Using PeopleSoft Supply Planning

PeopleSoft Supply Planning analyzes supply and demand and determines whether new planned production needs to be generated. If new production is required, the system generates a planning message to recommend creation of a new production ID or production schedule. When a planned manufacturing order is generated within PeopleSoft Supply Planning, it is always backward scheduled based on the required delivery date and the routing or item's lead times to determine the start date of production.

If you are using the PeopleSoft Supply Planning solvers to schedule and reschedule production:

- Freeze production within PeopleSoft Supply Planning and apply the frozen requirement to the production within PeopleSoft Manufacturing.

For example, PeopleSoft Supply Planning sends a planning message for a new production ID back to PeopleSoft Manufacturing with the requirement that production is frozen.

- Using PeopleSoft Manufacturing, convert the recommendation into a production ID with an *Entered*, *Firmed*, or *Released* status.

If you are using the Production ID Maintenance component to change any information on the production ID that affects scheduling, the system displays a warning message that indicates production is frozen and any of the changes result in rescheduling the production. You can override the frozen status by proceeding and changing the information, or you can cancel the changes.

Within PeopleSoft Manufacturing, you can manually freeze production. Do this by selecting Frozen Production on the Planning Attribute page for production IDs or by selecting the Frozen check box on the Production by Area Details page for production schedules.

PeopleSoft Supply Planning uses planning lead times or routing times when scheduling production, and it takes into account the following factors that affect the actual start date and time and actual due date and time of each operation:

- Capacity and material availability.
- Planning labor or machine setup, run, and fixed run times or run rates.
- Operation overlap, based on an overlap percentage or send-ahead quantity.
- Operation intensity, based on machine, labor, cumulative, or longest.
- Operation yield.

- The work center calendar, if one exists.
- The production calendar, if one exists.
- The five-day work week calendar, when no other calendar exists.

Reviewing, Approving, and Applying Production Messages

Once a plan has been created and recommendations are made, planning messages are returned to the transactional system using the Post Updates process (PL_POST). Once the messages are received, you can:

- Review and approve the production messages using the Approve Production Updates component.
Use this component to select the messages that you want to review, then look at the production details, status details, and configuration code information to select which messages you want to approve.
- Review any exception messages generated when the production messages are applied by using the Review Post Errors component.
Use this component to select the exceptions that you want to review, then look at the exception details, dates and quantities, and configuration code information.
- Apply the production messages to PeopleSoft Manufacturing to take action on the recommendations made by PeopleSoft Supply Planning by using the Apply Production Updates page.

Related Links

[Update Production Page](#)

Production IDs and Production Schedules Using PeopleSoft Manufacturing

You can use PeopleSoft Manufacturing to create production IDs and production schedules.

Creating Production IDs

You can use the Production ID Maintenance component to add or maintain a production ID one at a time. When you manually add a production ID, determine whether production is forward or backward scheduled. The selection is based on whether you know when you want to start production or when the item is due:

- If the production ID is based on the completion date and time, or due date and time, it is *backward* scheduled, and the system calculates the actual start date and time.
- If the production ID is based on the start date, it is *forward* scheduled, and the system determines when the assemblies will be completed.

Automatic calculation of the opposing date and time applies only if you specify a routing for the production ID. In addition, the system calculates the production start date and shift as well as the production due date and shift associated with both the actual start date and time and due date and time.

If a production ID is added in the *Firmed* or *Released* status, the actual start dates and times and due dates and times for each operation in the manufacturing process are also calculated.

You can also add or maintain production ID information one week at a time using the Production by Area pages. This gives you a one-week view of all production taking place in a selected production area. By navigating to the details by day, you can view daily production ID and production schedule information. When adding production IDs, you select the date on which production will be completed and the system automatically backward schedules the production ID to determine the start date of production.

Creating Production Schedules

Production schedules are always entered with a quantity due for a day of the week, and the system determines the production start date and production start shift using backward scheduling.

Note: Because production schedules are always backward scheduled, you enter the production *end* quantity, and the system calculates the required production start quantity.

When you manually add a production schedule in the *Entered* status, the system:

- Determines the production start date and shift when the production due date and shift are entered.
- Determines the actual start date and time as well as the actual due date and time for the production start date and shift and production due date and shift, respectively.

When you add a schedule in the *Firmed* status or release a production schedule, the system must:

- Calculate an actual start date and time or due date and time.
- Calculate actual start dates and times and due dates and times for each operation in the manufacturing process.

Calculating Start and Due Dates for Production IDs and Production Schedules in PeopleSoft Manufacturing

PeopleSoft Manufacturing calculates start and due dates based on the production item's routing, and does not include other production that uses the required work centers or resources. If capacity and material availability are concerns, manually add a production ID or production schedule using PeopleSoft Manufacturing. When you add the production, estimate start and due dates and then schedule the actual start and due dates for the production ID or production schedule using PeopleSoft Supply Planning.

If you are using PeopleSoft Manufacturing to schedule production, there are several factors that affect the actual start date and time and actual due date and time of each operation in addition to the planning lead times:

- Operation overlap, based on a percentage or send-ahead quantity.
- Setup that can occur during queue time (or at any time once production begins).
- Setup time that is included in scheduling the operation.
- Operation intensity.
- Work center calendar, if one exists.
- Production calendar, if one exists.
- Five-day work week calendar.

- Operation yield.

Define these factors when you set up manufacturing data for each business unit, item, work center, or routing. Once the system creates the operation list for the production ID or production schedule, it reschedules each operation any time that the operation list is modified.

Related Links

[Production IDs and Production Schedules Using PeopleSoft Supply Planning](#)

[Production Scheduling in PeopleSoft Manufacturing](#)

Production IDs Using PeopleSoft Product Configurator

The production configuration process:

- Takes the detailed configuration information captured in PeopleSoft Order Management and sends requirements to PeopleSoft Manufacturing.

The production configuration rules enable you to dynamically specify component and operation list elements without having to have standard BOMs or routings for each specific configuration.

- Generates configured production IDs, component lists, operation lists, and configured costs.

You can manually create a production ID for a configured item, and create the operation list and component list.

Rework and Teardown Production

You can use PeopleSoft Manufacturing to manually create rework and teardown production IDs, or create an operation list:

- Manually create rework and teardown production IDs using PeopleSoft Manufacturing.

The process of creating rework or teardown production IDs is the same as for regular production. However, because the use of an operation list is optional for rework or teardown production, PeopleSoft Manufacturing does not automatically determine the actual start date and time or actual due date and time for rework or teardown production, unless you have previously created a rework or teardown routing that is then copied to the operation list.

- Manually create an operation list if a rework or teardown routing has not previously been defined.

If you create an operation list for the rework or teardown production, the tasks and work centers associated with it are used for scheduling. If an operation list does not exist, manually enter the scheduling information, indicating the actual start date and time and due date and time for production IDs.

Once the production ID is created:

- Modify the appropriate start and due dates manually.
- If capacity and material availability are concerns and you've created a component list and operation list for the rework or teardown production, schedule the production ID using PeopleSoft Supply Planning.

PeopleSoft Supply Planning treats rework and teardown requirements for a resource in the same manner as regular production.

Note: You cannot create rework or teardown production IDs using PeopleSoft Supply Planning. However, you can schedule rework or teardown production IDs to repair capacity restraints using PeopleSoft Supply Planning.

Related Links

[Regular Production Scheduling](#)

Production ID Splits

Occasionally, during the production process you may need to split a single production ID into two or more production orders. With PeopleSoft Manufacturing, you can split production when:

- A portion of the production quantity needs to be split out because of a change in processing steps.
- A portion of the production quantity must be split due to material shortages or capacity issues.

This enables you to complete what you can and close out the order. The remaining quantities requiring material or resources remain on an open order.

- Production variations occur, such as unplanned outputs that need to be completed separately and put away using a different item number.

Perform production ID splits for this type of production orders:

- Production
- Rework
- Teardown

You can:

- Split configured production IDs; however, you can only split the configured order to a new *configured* production ID.
- Split production IDs that have subcontracted operations; however, you must perform the production split before running the Select Subcontract Prdn for PO process (SFS5000).

Assign a new item number to the new production order if the final end item produced differs from the original item.

- Manually adjust operation lists for production that has not started.

Material, earned conversion costs and actual conversion hours are split across the From and To orders on an operation-by-operation basis. Scrap costs remain with the original production ID.

- Correct and modify the component material split across orders even after the order has been split by using the PID to PID Component Transfers (production-ID to production-ID component transfers) page.

- Split multiple outputs—primary items, co-products, by-products—to the new (To) production ID if there are still remaining quantities.

In addition, the system copies any resources, attachments, text, or documents to the new (To) production ID. The system maintains the split history at the production header level, and you can view the history by using the Production ID Split History inquiry page.

- Make manual changes to the components by using the Production ID Comp Transfer page after a production ID split.

You cannot perform production ID splits under these circumstances:

- Production IDs that have subcontracted operations in process cannot be split.
- Co-products cannot be split to primary items.
- Splits across production types—production to teardown, rework to production, or teardown to rework—are not allowed.
- Production IDs cannot be split if pegged.

Note: Production schedules cannot be split.

When splitting production IDs being tracked by serial genealogy, you are prompted for the assembly serial IDs that are being split. These serial IDs will be associated with the new production ID. In addition, the component genealogy associated with the serial assemblies being split is moved to the new production ID.

Production order splits are permanent, and after they're created, the production orders cannot be rejoined at a later operation. Each production ID becomes a separate entity that must be closed and the costs must be reported independently. If more than two production IDs are required, the split must be run multiple times. When the entire quantity of a production ID is moved to one or more new production IDs, the status of the original production ID is set to *Canceled*.

Both the original (From) and the new (To) production IDs can be rescheduled in PeopleSoft Supply Planning.

Related Links

[Recording Completed Operations and Scrap for Subcontracted Operations](#)

[Generating Production ID Splits](#)

Frozen Production

If you are maintaining production that was scheduled using PeopleSoft Supply Planning, the production ID may have a frozen status. The frozen status indicates that a decision was made to hold or firm up the due date and that changes to these production IDs or production schedules within PeopleSoft Manufacturing could result in a change to the schedule created by PeopleSoft Supply Planning.

- Set a default at the manufacturing business unit level to create all new rework or teardown orders with a frozen status, indicating that you do not want PeopleSoft Supply Planning to reschedule those orders.

- Override this default using the Planning Attribute page, which is available from the Production ID Maintenance component and the Production by Area Details component.
- If the production ID or production schedule has a frozen status and you change information that affects the actual start or due dates and times, PeopleSoft Manufacturing displays a warning message indicating that the production is frozen.
- You can continue, or you can cancel the changes.

If you proceed with changing the production ID or production schedule, the production ID or production schedule is no longer frozen.

Changes to the production that affect the actual start date and time or actual due date and time include:

- Item ID
- Status
- Production quantity
- Production type
- Actual start date and time
- Actual due date and time
- Production start date and shift
- Production due date and shift
- Routing code
- Operation yield
- Revision

Related Links

[MFG Business Unit Options Page](#)

[Update Production Page](#)

Manufacturing Execution System Integration

If you're using PeopleSoft Manufacturing with a Manufacturing Execution System (MES), the system publishes messages for the MES when you add or modify production IDs or production schedules. The system publishes production order messages when you:

- Change the production status of a production ID or production schedule to *Released*.
- Modify a released production ID or production schedule.
- Change the production status of a production ID or production schedule from *Released* to an earlier status.
- Change a component list or operation list.

- Change an output list.
- Split a production ID.

When the system publishes a production order for the MES:

- The system includes the component list and operation list, with attachments and documents, as well as the output list for the production ID or production schedule.
- You release production IDs or production schedules in either PeopleSoft Manufacturing or the MES.
- You perform detailed production scheduling, production monitoring, and reporting in the MES.

Related Links

[Integrating with an Electronic Data Collection System](#)

Common Elements Used in Production Orders and Production Schedules

<i>Field or Control</i>	<i>Description</i>
Production ID	The production order identifier.
Prdn Area (production area) and Production Area	The area where the end item is generated.
Item ID	The item being manufactured.
Prdn Start Qty (production start quantity)	The quantity of an end item at the beginning of the manufacturing process. For production IDs, if you enter this quantity, the system calculates the production end quantity, factoring in operational yield.
Prdn End Qty (production end quantity)	The quantity of an end item to be manufactured. For production IDs, if you enter this quantity, the system calculates the production start quantity. For production schedules, you enter the production end quantity since all production schedules are backward scheduled and the system calculates the production start quantity.
Expected Prdn Qty (expected production quantity)	The quantity anticipated at the end of the production process. This amount reflects any operation yield.
Production Status	The current status of the production ID.

Field or Control	Description
BOM Code	The BOM priority code used to manufacture the item.
Routing Code	The routing priority code used to manufacture the item.
Component ID	The component identifier.
Sch Method (scheduling method)	<p>Values are:</p> <ul style="list-style-type: none"> • <i>Forward</i>: System uses the production start date as a basis for creating the schedule for the production ID. This method is used only with production IDs. • <i>Backward</i>: The system uses the production completion date as a basis for creating the schedule for the production ID or production schedule. Production schedules are always backward scheduled.
Start Date , Start Time , Due Date , and Due Time	The beginning and completion dates and times for the production based on the scheduling method. Forward scheduling uses start dates and times; backward scheduling uses due dates and times.
Revision	Code is indicated if item is revision-controlled.
Production Type	Type of production being manufactured: <i>Production, Rework, or Teardown.</i>
Serial in Prdn (serial in production)	<p>This display-only field indicates if you want to track the key serial and lot components that make up this assembly item. This is defined at the item level using the Inventory - Tracking Description page.</p> <p>See Define Item: Inventory - Tracking Description Page.</p>
Prdn Date Option (production date option)	<p>Select one of these values:</p> <ul style="list-style-type: none"> • All • Prdn Start (production start) • Range • Prdn Due (production due)

Prerequisites

Before you create production IDs and production schedules, make sure that:

- Items have been defined in PeopleSoft Inventory.
- BOMs have been created for the assembly item.
- Production areas are defined.
- The items you'll be manufacturing, tearing down, or reworking are linked to a production area by using the production Area Maintenance component or the Production Option Maintenance component.

The production area and item relationship must have an *Active* status.

- All items you'll be tracking using production IDs have the MA ID (maintain production IDs) check box selected on the production Area Maintenance Summary page.
- The production calendar is defined.
- The five-day work week is defined for the business unit if you are not using production calendars.

Optionally, you can define:

- A primary routing or alternate routing for the items you'll be manufacturing.

For reworking assemblies, you can also define rework BOMs or rework routings.

- If you typically tear down finished end items into their component parts, define a teardown routing, defining the operations necessary in the teardown process.

Additionally, indicate on the production BOM which components are outputs from a teardown process.

- Any revisions for revision-controlled items that you manufacture.
- Any work center calendars.

Creating Production IDs

The first step in defining a discrete manufacturing order is to create a production ID. Once you've generated a production plan, manually enter any discrete production or rework orders for those items that were not included in the new production recommendations from PeopleSoft Supply Planning.

When you change any information on an existing production ID, the system optionally sends the Production ID Change workflow notification to selected roles that you defined. These roles could include a planner, buyer, or a production control manager.

You can create production IDs for production, rework, or teardown orders.

If you want to automatically create operation and component lists, you must define BOMs and routings for the end item.

This section discusses how to define and maintain Production ID

Pages Used to Define and Maintain Production IDs

Page Name	Definition Name	Usage
<u>Production ID Maintenance Page</u>	SF_PRDNID_MAINT	Create and maintain a single production ID for production, rework, or teardown orders.
<u>Production Start Date/Shift or Production Due Date/Shift Page</u>	SF_PRDN_DUE_SBP	Display production start date and shift information or production due date and shift information for the selected production ID.
<u>Production Option Selection Page</u>	EN_PDO_SEL_SP	Select a different BOM and routing code combination that you want to use for the production ID.
Process/Output Options Page	SF_PRNT_OPT_SP	Select the print options for printing production documents at save. <u>Production ID Maintenance Page</u>
<u>Teardown Original Production ID Search Page</u>	SF_TRDN_PID_SEC	Locate the original production ID used to create the teardown item. This page is used for teardown orders only.
<u>Update Production Page</u>	PL_PLAN_ATTRIB	Freeze the production ID's component list and operation list in the PeopleSoft Supply Planning system.
<u>Production ID Detail Page</u>	SF_PRDNID_STATIC	View production ID and scheduling data.
Production ID Text Page	SF_PRDNID_TEXT	Associate text with any production ID. <u>Production ID Detail Page</u>
<u>Production ID Outputs Page</u>	SF_PRDN_OUTPUT	Maintain and display production output information.

Page Name	Definition Name	Usage
Traceability Page	SF_PRDN_TRC	View the assembly serials that have been associated with the production ID. You can only access this page if the serial IDs have been associated with the production ID. Production ID Maintenance Page
Production History Page	SF_TRANS HIST	View production transaction history.
Production History Details inquiry Page	SF_TXN_HIST_SP	View transaction history details based on the selection criteria. Production History Page
Production ID Comp Transfers Page	SF_COMP_TRANSFER	Transfer components between production IDs to cover shortages. Correct errors after a production ID split.
Production Detail Page	SF_PID_SEC	View production details.
Production by Area Summary Page	SF_PA_SCH_SUMMARY	Add, modify, and view all production for a specific production area.
Production by Area Details Page	SF_PA_SCH_DT_MAINT	Add, modify, and view production details for all production for a specific production area.
Production by Area (inquiry) Page	SF_PA_SCH_SUM_INQ	View all production in a specific production area. Define at least one production schedule or production ID.
Production Selection Page	SF_PRDN_ITEM_SEL	Access production, rework, and teardown information for a specific item. View production IDs, production schedules, or a combination of both. Define at least one production ID or production schedule for an item.

Page Name	Definition Name	Usage
Production List Page	SF_PRDNID_ITEM_VW	<p>Access production, rework, and teardown information for a specific item.</p> <p>View production IDs, production schedules, or a combination of both. Use this page to see the status of production for a production area at the operation level.</p> <p>Define at least one production ID or production schedule for an item.</p>
Production for an Area/Item - Production Detail Page	SF_PRDNINQ_STATIC	Display production, rework, or teardown details associated with any production ID displayed on the Production for an Item inquiry page.
Operation Detail Page	SF_PRDN_DATA_DTL	View operation list details.
Production Output Page	SF_PRDID_ITEM_OUT	<p>View output information for a specific item.</p> <p>Define at least one production ID for an item.</p>
Production Text Page	SF_PRDNINQ_PRTXT	View text associated with any production ID.
Production Inquiry - Production Selection Page	SF_PRDN_SELECTION	Define production criteria for the production inquiry.
Production Inquiry Page	SF_PRDN_MAINT_INQ	<p>View production information for a particular production ID.</p> <p>Enter production information on the Production Selection page before accessing this page.</p>
Production Detail Inquiry Page	SF_PRDN_STAT_INQ	Display additional details for the selected production.
Production Output Page	SF_PRDN_OUTPUT_INQ	View output information for production IDs.
Production Text Inquiry Page	SF_PRDN_TEXT_INQ	Display text associated with the selected production.

Page Name	Definition Name	Usage
Production Output Mix Inquiry - Production Selection Page	SF_COMP_OUT_SEL	Enter the search criteria for the production ID whose component and output data you want to display. Define at least one production ID with multiple outputs.
Prdn Op Summary (production operation summary) Page	SF_COMP_OUT_SUM	Display production operation sequence data at a summary level, including task and work center information.
Prdn Output/Component Details Page	SF_COMP_OUT_DTL	Display specific production component and output ID production data by operation sequence at a detail level.
Production Report Selection Page	RUN_SFS2004	Generate a production report for a range or all actual start dates, selected production statuses, and a range or all production IDs.

See the product documentation for *PeopleTools: Workflow Technology*

Related Links

[Understanding BOM Maintenance](#)

[Understanding Routings](#)

[Delivered Workflows for PeopleSoft Manufacturing](#)

Common Elements Used in This Section

Field or Control	Description
Op Seq (operation sequence)	The operation step in the manufacturing process where the components are required.
Prdn Start Date (production start date)	Date production is or was to have started.
Prdn Due Date (production due date)	Date production is or was due to be completed.
Prdn Due Shift (production due shift)	Shift that the production is or was due to be completed.
Expected Yield	The aggregate yield percentage for the production order when all operation yields are combined.
Source Cd (source code)	End item source code. Options are <i>Make</i> or <i>Buy</i> .

Field or Control	Description
Task Code and Description	Task code number and description of the task being performed.
Sub (subcontracted operation)	Indication that the operation step is a subcontracted operation.
Work Center	Work center where the operation step is performed.
Configuration Code	Indication that the output or component is a configured item.
Output Qty (output quantity)	Output production quantities based on per assembly or per order setting.
Per	Quantity qualifier. Options are <i>Asy</i> (assembly) or <i>Ord</i> (order).
Res % (resource allocation percentage)	Percentage that determines how much of the BOM batch quantity the primary and co-product represents. It is used during completions to determine what percentage of the components should be consumed for the primary and co-product. The total resource allocation percentage should always equal 100 percent.
Qty (quantity)	Component quantity required based on per assembly or order.
Sched Qty (schedule quantity)	Quantity required for the production start or production end quantity.
Issue Qty (issue quantity)	For components using the issue or replenishment material issue method, this is the quantity consumed from the WIP location for the component and is charged to WIP. For components using the kit method, this is the quantity issued directly to the production ID.
Orig Comp ID (original component ID) and Description	Original component if the current component is a substitute item.

Production ID Maintenance Page

Use the Production ID Maintenance page (SF_PRDNID_MAINT) to create and maintain a single production ID for production, rework, or teardown orders.

Navigation:

Production Control > Define Production > Production IDs/Schedules > Maintain PIDs > Production ID Maintenance

Select a Production Type.

This example illustrates the fields and controls on the Production ID Maintenance page. You can find definitions for the fields and controls later on this page.

Production ID Maintenance		Production ID Detail	Production ID Text
Business Unit	US008	Production Type	Production
		Production ID	PRD00239
*Status	Entered	Action Menu	
*Production Area	FINAL	<input type="checkbox"/> Serial in Prdn	
*Item ID	MT2000	<input type="checkbox"/> Print at Save	
Prdn Start Qty	1.000 EA	Expected Yield %	100.0000
Prdn End Qty	1.000 EA	Expected Prdn Qty	
BOM Code	1	Rtg Itm	MT2000
*Sch Method	Backward	Due Date/Time	
Start Date/Time		Prdn Doc. Status	Do not Print
Revision			
Config Code			

Field or Control	Description
Status	<p>You can add a production ID with a production type of <i>Production</i> in either the <i>Entered</i>, <i>Firmed</i>, or <i>Released</i> status.</p> <p>You can add a rework or teardown production ID with a <i>Firmed</i> or <i>Released</i> status only.</p>

Note: *Pend Cmpl* (pending complete), *Completed*, *Clsd/Labor* (closed for labor), and *Clsd/Acctg* (closed for accounting) are used when tracking and closing production, but they are not used when creating or maintaining a production ID.

Maintaining Production ID Information

Field or Control	Description
Production Area	<p>Select to indicate where this production will take place. Once you select a production area, you can view the items produced in that production area by selecting an item ID. You cannot add a production ID for an item that has not previously been defined in the production area selected. Additionally, you must have selected to maintain production IDs for the production area and item combination.</p> <p>The production area and item combination must have an <i>Active</i> status to add a new production ID.</p>

Field or Control	Description
<p>Item ID</p>	<p>Select one of the items produced in the production area. You can change the item for any production ID in the <i>Entered</i> or <i>Firmed</i> status.</p> <p>If the production ID has a status of <i>Released</i>, you can change the item for any production as long as subcontracted purchase orders have not been generated against the production ID.</p> <p>If you change the item ID:</p> <ul style="list-style-type: none"> • The production ID is rescheduled upon saving the page based on the scheduling method for the production ID and the new item's routing, if one exists. • The system deletes the existing component list and operation list, and it then creates a new component list and operation list for the new item. <p>Once production has a status of <i>In Process</i>, you cannot change the item ID on the production ID.</p> <hr/> <p>Note: If you need to change the item ID for <i>In Process</i> production, you can split the production ID into a new production ID—moving the remaining quantity in process—and simultaneously specify a new item.</p> <p>When adding a production ID for an item with item status of <i>Hold</i> or <i>Discontinue</i>, you'll receive a warning message. However, there is no warning for rework or teardown production type. If the production ID for an item has a status of <i>Hold</i>, the system gives you the option to cancel that order at save time.</p> <hr/>

Field or Control	Description
<p>Prdn Start Qty (production start quantity)</p>	<p>Displays the quantity required at the beginning of the production process. This quantity may be entered, or it may be calculated when the end quantity is entered. If calculated, this quantity will be rounded up at each operation to account for any operation yield.</p> <p>You can change the production start or production end quantity for a production ID with a status of <i>Entered</i>, <i>Firmed</i>, <i>Released</i>, or <i>In Process</i>. Changing the production quantity reschedules the actual start or due date and time of the production ID.</p>

Field or Control	Description
Prdn End Qty (production end quantity)	<p>Displays the quantity expected at the end of the production process. This quantity may be entered or it may be calculated when the start quantity is entered. If calculated, this quantity will be rounded down at each operation to account for any operation yield.</p> <p>Production end quantity may be changed when operation yields are maintained. As production is reported against the production ID, the end quantity is updated to reflect actual production yields.</p>
Expected Prdn Qty (expected production quantity)	<p>Displays the quantity expected at the end of the production process. This is the expected quantity at the time production was started. It is not updated to reflect actual production variances, but it is updated if the production ID quantity is manually changed.</p>

Note: Whether the quantity is a whole number or a decimal depends on the item's unit of measure and quantity precision combination defined in PeopleSoft Inventory.

Note: The production start quantity and production end quantity may not be the same due to operation yield allowances.

Once you add the production ID, keep these points in mind when you change the production start or production end quantity:

- If the production ID is *Firmed* or *Released*, the system recalculates the component's scheduled quantities.
- If the production ID is *In Process* and you increase or decrease the order quantity, the system adjusts the component's scheduled quantities to reflect the new order quantity and marks the production ID as changed so that PeopleSoft Supply Planning reschedules the operations during the next planning run.
- If you have decreased the production quantity and have already issued components, you might have a surplus of components at the WIP location.
- If you have decreased the production start or production end quantity and already kitted material to the production ID, a usage variance results at accounting close time if the excess material is not returned to stock.
- If you change the production quantity and the production ID is released and backward scheduled, the system automatically recalculates the actual start date and time.
- If you change the production start or production end quantity and the production ID is released and forward scheduled, the system automatically recalculates the actual due date and time.

In this case, the system prompts you to delete the existing component list.

- If you select *Yes* to the Component List for Production ID prompt, the system deletes the component list and then creates a new component list for the production ID, based on the BOM in effect on the new production due date.
- If you select *No*, the system uses the existing component list for production.
- If you change the production quantity, and the production ID is *Firmed* or *Released*, and subcontracted purchase orders have been created, the system sends a purchase order change request to PeopleSoft Purchasing, indicating a change in production start or production end quantity.

Note: If a subcontracted operation has more than one purchase order, the system will not automatically create change requests. You will need to manually create the change requests.

- You cannot decrease the production quantity to a quantity less than the quantity that has already been completed to stock.

Warning! A warning is issued if you decrease the production start quantity to a quantity less than the number of serial IDs associated.

Field or Control	Description
BOM Code and Routing Code	<p>The values appear by default for the production area and item combination effective for the area and item as of the current date. Change the BOM and routing codes if alternate routings are used for this production ID.</p> <p>Only the BOM and routing codes for the item and the selected production type are available. For example, suppose that you select the <i>Rework</i> production type, you can only select rework BOMs or rework routings if either are defined. Rework and teardown routings are optional. If you do not select a rework or teardown routing, the system does not create an operation list for the production ID, and you need to manually enter the actual start date and time and actual due date and time. For teardown production, the production BOM (or an original production ID) is used to determine the teardown output list. The end item is copied to the component list.</p>
Rtg Itm (routing item)	Displays the item whose routing is used to manufacture, rework, or tear down the end item. Each assembly item can have its own unique primary and alternate routings or reference another item's primary and alternate routings.
Due Date/Time	If you change the due date and time for the production ID so that a different BOM and routing combination is used, a warning message appears enabling you to accept the new BOM and routing combination.

Note: Effectivity dates apply only if you use the Production Option Maintenance component to define the valid BOM and routing combinations.

BOM and routing combinations can be viewed in the Production Option Maintenance component.

Select valid production options (predefined BOM and routing combinations) for the item. If you select the **Valid Production Options only** option on the Item Attributes by Unit - Manufacturing page, then only the predefined combinations can be entered or selected.

Field or Control	Description
 (production option button)	Click the Production Option button to access the Production Option Selection page.

Note: If you create a component list and there are operations linked to the components that do not exist on the routing, the system treats those components as linked to the first operation sequence. This is similar to how the system handles a component with a 0 operation sequence. Unmatched output by-products, on the other hand, are linked to the last operation.

Once you add the production ID, keep these points in mind if you make any changes to the routing code:

- The system recalculates the production ID's actual start or due date and time based on the new routing's lead times and scheduling parameters.
- If the production ID is in the *Firmed* or *Released* status, changing the routing code also deletes the existing operation list.

The system creates a new operation list for the production ID using the routing code specified.

- If the production ID is in the *Firmed* or *Released* status, you can change the routing code only if a subcontracted purchase order has not been generated against the production ID.
- If the production ID is forward scheduled and the due date and time for production has changed based on the new routing, the system prompts you to delete the existing component list.

If you select *Yes* to the **Component List for Production ID** prompt, the system deletes the component list and creates a new one based on the BOM in effect on the new due date.

Field or Control	Description
Sch Method (scheduling method)	If you are using the production start date as a basis for creating the schedule for the production ID, select <i>Forward</i> . If you are using the production completion date as a basis for creating the schedule for the production ID, select <i>Backward</i> .

Field or Control	Description
Start Date/Time or Due Date/Time	<p>If you selected a routing, enter only one of these dates. The system automatically calculates the other date once you define whether the production for this item is based on forward or backward scheduling.</p> <p>Keep these points in mind when entering a start date and time or a due date and time:</p> <ul style="list-style-type: none"> • If a routing is not used, manually enter both the start and due dates/times, regardless of the scheduling method selected. • When using <i>Forward</i> scheduling and entering a start date, the first minute of operation for the earliest shift of the day appears as the default time. <p>If the earliest shift spans multiple days, the first minute of the date specified appears as the default time (for example, 12 a.m.).</p> <ul style="list-style-type: none"> • When using <i>Backward</i> scheduling and entering a due date, the last minute of operation for the latest shift of the day appears as the default time. <p>If the latest shift spans multiple days, the last minute of the date specified appears as the default time (for example, 11:59 p.m.).</p> <hr/> <p>Note: If capacity and material availability are concerns, estimate the start and due dates when you create or maintain the production ID using PeopleSoft Manufacturing, and then schedule the production ID's start and due dates using PeopleSoft Supply Planning.</p> <hr/>
Revision	<p>If a revision was specified for the area and item, it is displayed here. Otherwise, if the item is revision-controlled, the BOM revision in effect as of the due date for the order is used.</p> <p>Changing the revision is valid only if the item is revision controlled. Select an alternate revision if alternates have been specified. If you are changing the revision and the production ID is in <i>Firmed</i> or <i>Released</i> status, the system prompts you to replace the existing component list.</p> <ul style="list-style-type: none"> • If you select <i>Yes</i> to the Component List for Production ID prompt, the system deletes the component list and adds a new one based on the BOM's effectivity date • If you select <i>No</i>, the system uses the existing component list for the production ID.

Field or Control	Description
<p>Prdn Doc Status (production document status)</p>	<p>Indicates whether production documents have been printed. Values are:</p> <ul style="list-style-type: none"> • <i>Do not print</i>: This is the default if the production ID status is <i>Entered</i>. • <i>Ready to Print</i>: This is the default if the production ID status is <i>Firmed</i>. <p>The system prints production documents when the production ID's status is <i>Firmed</i> or later.</p> <ul style="list-style-type: none"> • <i>Printed</i>: This indicates that documents have already been printed. <p>You can only print production documents when the production ID's status is <i>Firmed</i> or later.</p>
<p>Print at Save</p>	<p>Select to print production documents for the production ID at save time.</p>

Field or Control	Description
Action Menu	<p>Select any of these pages to access additional information:</p> <ul style="list-style-type: none"> • <i>Update Comp List</i> (update component list): Click to access the Update Component List component, where you can make changes to the component list for this production ID. See Understanding Component Lists. • <i>Update Op List</i> (update operation list): Click to access the Update Operation List component, where you can make changes to the operation list for this production ID. See Understanding Operation Lists. • <i>View Outputs</i>: Click to access the Production ID Outputs page to view the outputs associated with this production ID. • <i>View Serial Info</i>: Click to access the Traceability page, where you can view the assembly serial IDs that have been associated with this production ID. • <i>Review Proactive Costing</i>: Click to access the PID Costing page to view the current costs of a production ID based on the component list and operations list. The costs are a snapshot of the production ID's costs at a particular point in time. See "Proactive Production Cost - PID Cost Page" (PeopleSoft Cost Management). • <i>Planning Attributes</i>: Click to access the Planning Attribute page. See Update Production Page. • <i>Peg to Demand</i>: Click to access the Pegging Workbench to peg the production ID to a sales order. • <i>Show Pegged Demand</i>: Click to access the Pegging Inquiry page to view any pegged orders. See "Understanding Pegging" (PeopleSoft Supply Chain Management Common Information). • <i>Setup Print Options</i>: Click to access the Process/Output Options page to select different print criteria for the production documents. • <i>Process Monitor</i>: Click to access the Process List page.

Field or Control	Description
	See <i>PeopleTools: PeopleSoft Process Scheduler Documentation</i>

Adding and Maintaining Production IDs Using a Weekly View

You can also maintain and view production IDs by using the Production by Area pages.

See [Production by Area Summary Page](#).

Production Start Date/Shift or Production Due Date/Shift Page

Use the Production Start Date/Shift or Production Due Date/Shift page (SF_PRDN_DUE_SBP) to display production start date and shift information or production due date and shift information for the selected production ID.

Navigation:

Production Control > Define Production > Production IDs/Schedules > Maintain PIDs > Production ID Maintenance

Click the **Detail** button next to the **Start Date/Time** or **Due Date/Time** fields.

The first or last minute of the production shift is based on these scenarios:

- For *Forward* scheduling, the system uses the work center calendar for the routing's first operation, if one exists.
- For *Backward* scheduling, the system uses the work center calendar for the routing's last operation, if one exists.
- If work center calendars do not exist for the routing's first or last operation's work center, the system uses the production calendar, if one exists.
- If a production calendar does not exist, the shift's start or end time specified for the five-day work week is used.
- If you are changing the due date and time and a routing is specified, the system recalculates the start date and time.

Conversely, if you are changing the start date and time, the system recalculates the due date and time. The production start date and shift and the production due date and shift associated with the start date and time and due date and time are also determined.

- If the production ID is in the *Firmed* or *Released* status and you replace the start date and time or due date and time, the system updates the operation list with each operation's new start and due dates and times.
- If you are changing the due date or the due date changes as a result of a change in start date, the system prompts you to delete the existing component list.

If you select *Yes* to the **Component List for Production ID** prompt, the system deletes the component list and adds a new one based on the BOM in effect on the new due date.

- If the production ID is in the *Firmed* or *Released* status and a subcontracted purchase order has been generated against the production ID, any changes that result in a change to the start date and time or due date and time may affect the purchase order due date.

The system displays a warning message when changes occur that result in a change to the start dates and times and the due dates and times.

Teardown Original Production ID Search Page

Use the Teardown Original Production ID Search page (SF_TRDN_PID_SEC) to locate the original production ID used to create the teardown item.

This page is used for teardown orders only.

Navigation:

Production Control > Define Production > Production IDs/Schedules > Maintain PIDs > Production ID Maintenance

Click the **Search** button next to the Original PID field to access this page.

This example illustrates the fields and controls on the Teardown Original Production ID Search page: Production tab. You can find definitions for the fields and controls later on this page.

Teardown Original Production ID Search

Search Criteria

Business Unit: US008 Item ID: MT2000 Search

Completion History Professional Road Bike, Womans

Serial ID: 🔍

Lot ID: 🔍

Production ID Date

Prdn Due Date Range:

From: 🔍 To: 🔍

Config Code: 🔍

Original Production ID Customize | Find | View All | 📄 | 📊 | First 1-2 of 4 | Last

Production Details Configuration Code 📄

Production ID	Status	Prdn Start Date	Prdn Due Date	Area	BOM Code	Routing	Prdn Start Qty	UOM	Prdn End Qty	UOM	Compl Qty
<input type="checkbox"/> DW01	Pend Cmpl	08/05/2009	08/05/2009	FINAL	1	1	10.0000	EA	10.0000	EA	10.0000
<input type="checkbox"/> PRD00121	Pend Cmpl	07/28/2000	07/28/2000	FINAL	1	1	25.0000	EA	25.0000	EA	25.0000

Return

Note: If the production type is *Teardown*, the output list is based on the components used on a previous production ID or on the components designed as teardown outputs on the item's BOM.

Select **Completion History**, and if the serial ID and lot ID exist for the original order, select values.

You can also select a production due date range or configuration code from the available options. After you make the selections, click **Search** for a list of production IDs. If multiple production IDs were used

to create the item, the system generates a list of production IDs, but it only selects production IDs with a status of *In Process* or later status with a production type of *Production*.

Production Tab

Select the check box next to the original production ID that you're tearing down.

Update Production Page

Use the Update Production page (PL_PLAN_ATTRIB) to freeze the production ID's component list and operation list in the PeopleSoft Supply Planning system.

Navigation:

Production Control > Define Production > Production IDs/Schedules > Maintain PIDs > Production ID Maintenance

Click the **Planning Attribute** link.

<i>Field or Control</i>	<i>Description</i>
Frozen Substitutes	Select to freeze substitutes in PeopleSoft Supply Planning. When you send the production ID to PeopleSoft Supply Planning, the Planning engine does not include substitute components.
Frozen Production	Select to freeze the production ID in the PeopleSoft Supply Planning system. This means that when you send the production ID to PeopleSoft Supply Planning, the Planning engine does not reschedule the production ID. Set a default at the manufacturing business unit level to create all new rework or teardown orders with a frozen status, indicating that you do not want PeopleSoft Supply Planning to reschedule those orders.

Related Links

[MFG BU Prdn Options Page](#)

[Understanding Production Options](#)

[Understanding Routings](#)

[Production ID Outputs Page](#)

[Understanding Component Issue Methods](#)

Production ID Detail Page

Use the Production ID Detail page (SF_PRDNID_STATIC) to view production ID and scheduling data.

Navigation:

Production Control > Define Production > Production IDs/Schedules > Maintain PIDs > Production ID Detail

This example illustrates the fields and controls on the Production ID Detail page. You can find definitions for the fields and controls later on this page.

Production ID Maintenance		Production ID Detail		Production ID Text	
Unit	US008	Production Type	Production	Production ID	PRD00239
Item ID	MT2000	Status	Entered		
Professional Road Bike, Womens					
Prdn Start Qty	1.0000 EA	BOM Code	1	Routing	1
Prdn End Qty	1.0000 EA				
Frozen Sub	No	Print Docs	No	OM Unit	
Frozen	No	Print Count		Order No	
Actual Date/Time Information			Prdn Date/Shift Information		
Start Date/Time	08/05/2014	2:10PM	Prdn Start Date/Shift	08/05/2014	1
Due Date/Time	08/06/2014	7:30AM	Prdn Due Date/Shift	08/06/2014	1
Completed Qty	0.0000	Scrapped Qty	0.0000	Expected Yield %	100.0000

Field or Control	Description
Frozen Production	Indicates whether a decision was made to hold or firm up the due date for this production ID by PeopleSoft Supply Planning. Change production information using the Production ID Maintenance page. If you change production information and the status is <i>Yes</i> , the system displays a warning message indicating that the production ID has been frozen by PeopleSoft Supply Planning and the change results in the production ID being rescheduled. You can continue or cancel the changes. If you change this information, the production ID is no longer frozen and the status changes to <i>No</i> .
Frozen Substitutes	Indicates whether the system has frozen substitutes in the PeopleSoft Supply Planning system. This means that when you sent this production ID to PeopleSoft Supply Planning, the Planning engine did not include substitute components.
OM Business Unit (Order Management business unit), Sales Order No and Configuration Code	These fields display sales order information if the production ID results from a sales order configured in PeopleSoft Order Management.
Print Count	Indicates the number of times that production documents have been printed for the production ID.
Prdn Doc Status (production document status)	Indicates whether production documents have been printed.
Completed Qty (completed production start or production end quantity)	Indicates whether assemblies have been completed to stock, routed to another WIP location, or issued directly to another production ID.

Field or Control	Description
Scrapped Qty (scrapped quantity)	Indicates the number of assemblies that have been scrapped in process.

Production ID Outputs Page

Use the Production ID Outputs page (SF_PRDN_OUTPUT) to maintain and display production output information.

Navigation:

- **Production Control > Define Production > Production IDs/Schedules > Maintain PIDs > Production ID Maintenance.** If you're adding a new production ID, the Production ID Outputs page is not available until after you save the page.
- Select *View Outputs* from the **Action Menu** on the Production ID Maintenance page.

This example illustrates the fields and controls on the Production ID Outputs page. You can find definitions for the fields and controls later on this page.

Production ID Maintenance
Production ID Detail
Production ID Text
Production ID Outputs

Business Unit US008	Production ID PRD00239
Item ID MT2000 Professional Road Bike, Womans	Status Entered
Production Type Production BOM 1	Routing 1
Prdn Start Qty 1.0000 EA	Prdn End Qty 1.0000 EA

Output List
Find | View All
First 1 of 1 Last

*Output Type Primary

Op Seq

Output Quantity 1.0000 EA

Qty Compl To Date

*Output Item MT2000

Professional Road Bike, Womans

Per Asy

Output Schd Qty 1.0000

Peg to Demand

Source Cd Make Serial

Res % 100

Output List

Field or Control	Description
Output Type	<p>Values are:</p> <ul style="list-style-type: none"> • <i>Primary</i>: Main output from the manufacturing process. • <i>Co-Product</i>: Item that—along with the primary item or output—is planned for and produced as part of the manufacturing process. <p>It shares the cost of the process, and there may be independent demand in planning for this item.</p> <ul style="list-style-type: none"> • <i>Recycle or Waste</i>: By-product item that is incidental to the manufacturing process. <p>It can be either a waste product or a recycle by-product, which can be used as an input to other processes. The by-product has either a relief (negative) cost for recycle by-products or a disposal (positive) cost for waste by-products. There would probably not be independent demand for by-products.</p> <ul style="list-style-type: none"> • <i>Teardown</i>: Component items that result from tearing down a completed end item. <p>Components can be reused in other production and can be returned to stock or routed to another production ID. This output type is available only for teardown production IDs.</p>
Op Seq (operation sequence)	<p>Operation step in which the output is generated. For primary and co-products, this is always the <i>last</i> operation. By-products and teardown outputs can be generated at any intermediate operation. If the operation sequence is 0 or does not exist on the operation list, it is assumed the output is generated at the last operation.</p>

Field or Control	Description
<p>Output Sched Qty (output scheduled quantity)</p>	<p>Output quantity based on the scheduled quantity but adjusted for scrap. The format for this display-only field may depend on the item's unit of measure and quantity precision combination defined in PeopleSoft Inventory.</p> <p>For example, suppose that item ID A0007 has a unit of measure of <i>EA</i> and a natural round, whole number combination. In that case, only whole numbers entered appear.</p> <ul style="list-style-type: none"> • Co-product quantity. <p>If the primary or co-product is expressed in terms of a quantity per order, the quantity specified on the BOM is the output quantity, regardless of the expected output quantity for the production ID or production schedule.</p> <p>If the primary or co-product output quantity is expressed in terms of a quantity per assembly, a QPA will first be determined. The primary or co-product QPA is $(\text{BOM output quantity}) \div (\text{BOM quantity})$. The expected completions for the primary or co-product are $(\text{Expected completions at the last operation}) \times (\text{Primary or co-product QPA})$.</p> • By-product quantity. <p>When determining the output for the recycled and waste products, the system uses the expected start quantity for the operation where the by-product is completed.</p> <p>If the by-product output quantity is expressed in terms of a quantity per order, the quantity specified on the BOM will be used, regardless of the operation start quantity.</p> <p>If the by-product output quantity is expressed in terms of a quantity per assembly, a QPA for each output will be calculated. The QPA is determined by dividing the by-product output quantity by the BOM quantity. The by-product output quantity for the PID and schedule is determined by multiplying the operation expected start quantity by the QPA.</p>
<p>Release Type</p>	<p>This field is used by PeopleSoft Supply Planning and indicates if the entire quantity of an end item at an operation should be completed at the end of the operation. Select <i>None</i> for no incremental release. Select <i>Over Time</i> to indicate that you want a specified quantity of end items to be on hand before completions occur.</p>

Field or Control	Description
Release Offset	This field is used by PeopleSoft Supply Planning and works with the <i>Over Time</i> option of release type. Enter the quantity of end items to be on hand before completions occur.
Peg to Demand	Click this link to access the Pegging Workbench page to peg the production ID to a sales order.
Show Pegged Demand	Click this link to access the Pegging Inquiry page to view any pegged orders.

See “Understanding Pegging” (PeopleSoft Supply Chain Management Common Information).

Adding Unplanned By-Products

Field or Control	Description
	<p>Click the Add button to add an additional (unplanned) by-product. You can add or change <i>Recycle</i>, <i>Teardown</i>, or <i>Waste</i> by-products on the production ID; however, you cannot add or change primary items or co-products.</p> <hr/> <p>Note: You can only add teardown outputs to a <i>Teardown</i> type production ID. Similarly, you cannot add recycle or waste outputs to a <i>Teardown</i> production ID. However, you can change the output quantity, operation sequence, and Per field for any by-products.</p> <hr/>
Output Qty (output quantity)	Whether you can enter a whole number or a decimal depends on unit of measure and quantity precision combination that was defined for the item in PeopleSoft Inventory.
Res % (resource percentage)	Indicates the resource percentage for the primary and co-products.

Important! Only by-products such as recycle or waste products can be added or changed. You cannot change or add primary items or co-products.

If you are maintaining a rework production ID, the output page lists only the reworked item as the end item. You cannot define co-products or by-products with rework.

Generating Production ID Splits

When required, you can split a single production ID into two or more production orders.

You can only split production with a status of *In Process*. Quantities can be split by operation based on the quantity that still exists at the original production ID operation sequence. You can also split a batch production ID order that has at least one co-product or by-product in addition to the primary item. You can split the entire production quantity to a new production ID, item ID or production area. All new production IDs will also have a production status of *In Process*.

You can only split production IDs. You cannot split production schedules.

Note: You cannot split an *In Process* production ID if there are pending pick plans, pending bar code transactions, or subcontracted operations that are also in process.

If you want to split a *Pending Complete* production ID, change the production status to *In Process*. You must reopen production to change the status back to *In Process*.

If you split a production ID that is being traced using serial genealogy, be aware of these issues:

- You select the assembly serial IDs to split.

These serial IDs become disassociated from the original production ID and become associated with the new production ID. Any components associated with split assembly serial IDs are automatically transferred to the new production ID.

- If the new (To) item is not using serial genealogy, you will no longer be able to track genealogy information.

In this scenario, the new production ID will not have any historical genealogy information.

- You can use the associate serial commands to associate additional serial numbers with the new production ID.
- You cannot transfer components to another production ID if they have been previously associated with a production ID using serial genealogy, unless those components are associated to an assembly serial that is being split.

In that case, they are automatically transferred. You cannot make serial associations when transferring components during the production ID split process.

This section lists common elements and discusses how to Generate Production ID Splits

Pages Used to Generate Production ID Splits

<i>Page Name</i>	<i>Definition Name</i>	<i>Usage</i>
<u>Production ID Split - Header Page</u>	SF_SPLITID_HDR	Define production ID split information. Split only production IDs with a status of <i>In Process</i> .

Page Name	Definition Name	Usage
Production ID Split - Operation List Page	SF_SPLITID_OP	Indicate the production quantity to be split from the original production ID at specific operation steps. Quantities can be split by operation based on the quantity that exists at the original production ID operation sequence.
PID Split Component List Page	SF_SPLITID_CMP_SEC	Edit components to be transferred to the new production ID. PID Split Component List Page
Production ID Split - History Page	SF_SPLITID_HIST	View production ID split history. PID Split Component List Page
Production History Page	SF_TRANSHIST	View production transaction history. PID Split Component List Page
Production History Details Page	SF_TXN_HIST_SP	View transaction history details. PID Split Component List Page
Production ID Comp Transfer Page	SF_COMP_TRANSFER	Correct errors after a production ID split. Use this page to transfer components between production IDs to cover shortages.
Component Detail Page	SF_COMPTR_COMP_SEC	View component shortages for the From production ID or the To production ID.

Related Links

[Production ID Splits](#)

Common Elements Used in This Section

Field or Control	Description
Component ID	Component that is in effect for the production ID at the time of the production split. The component may be a substitute item.
Op Seq (operation sequence)	Operation step in which the components are required.

Field or Control	Description
From Production ID	Original (From) production ID. If the production ID has been split multiple times, there is a separate entry for each split. The asterisk (*) indicates the original production ID.
To Production ID	New (To) production ID number. A new number is created each time the original production ID is split.
Split Qty (split quantity)	Production quantity split to the new production ID.
From Prdn Area and Description	Location where the original production ID was being manufactured.
To Prdn Area and Description	Location where the new production ID is to be manufactured.
From Date, From Time, To Date, and To Time	Beginning and ending date for the production that you want to view. The date and time fields refer to the date and time when the completion transaction was recorded.
Date Timestamp	Date and time the production ID split transaction occurred.
Inquiries	Option that enables you to view specified production transaction information. Values are: <ul style="list-style-type: none"> • <i>Completions Detail</i> • <i>Component Consumption</i> • <i>Operation Detail</i>

Production ID Split - Header Page

Use the Production ID Split - Header page (SF_SPLITID_HDR) to define production ID split information.

Split only production IDs with a status of In Process.

Navigation:

Production Control > Process Production > Split Production > Production ID Split > Header

This example illustrates the fields and controls on the Production ID Split - Header page. You can find definitions for the fields and controls later on this page.

Header		Operation List	
From Production			
Unit	US008	Production ID	PRD00221
Status	In Process	Prdn Type	Production
Production Area	GEARS	Gear Assembly	
Item ID	GR8500	Crank Set Subassembly	
Rtg ltm	GR8500	BOM	1
Sch Method	Backward	Routing	1
		Revision	
Prdn Start Qty	10.0000	EA	Prdn End Qty
			10.0000 EA
Start Date/Time	10/29/2003 7:14PM	Due Date/Time	10/29/2003 11:00PM
To Production			
Split Qty	<input type="text" value="0.0000"/>	EA	*To Prdn ID <input type="text" value="NEXT"/>
			New Rev <input type="text"/>
*To Prdn Area	<input type="text" value="GEARS"/>	Gear Assembly	
*To Item ID	<input type="text" value="GR8500"/>	Crank Set Subassembly	

Field or Control	Description
From Production	Displays the production header data from the production ID that you are going to split.
Split Qty (split quantity)	<p>If the production ID that you want to split has no operation list, enter the total quantity that you want to split from the original production ID. Whether you can enter a whole number or a decimal depends on the unit of measure and quantity precision combination that was defined for the item in PeopleSoft Inventory.</p> <p>For example, if item ID A0007 has a unit of measure of <i>EA</i> and a natural round, whole number combination, then you can only enter whole numbers. If you enter an incorrect number format, you'll receive an error message.</p> <p>If this field is unavailable, enter the split quantity on the Operation List page because there may be several operation steps with quantities that can be split.</p> <hr/> <p>Note: You cannot split a higher quantity than what is remaining at the operation sequence. For example, suppose that there is a quantity of 20 at operation sequence 10. Then you cannot split more than 20. If you enter a higher split quantity than the quantity that is available, you receive an error message.</p> <hr/>
View Trace Info	Click to access the Traceability page, where you can view the assembly serial IDs that have been associated with this production ID.
To Prdn ID (to production ID)	Enter a value for the new production ID if you are not using automatic numbering. If you are using automatic numbering, retain <i>NEXT</i> as the value.

Field or Control	Description
New Rev (new revision)	<p>Enter a value if the item is revision-controlled and this new production ID represents a new revision for the end item.</p> <hr/> <p>Note: Changes to the revision on the To item ID as reflected on the To production ID header only. Components copied during the production ID split process are based on the From production ID's component list and are not based on the revision number entered in the New Rev field.</p>
To Prdn Area (to production area)	<p>Select the area where the new production ID is processed. The production area for the To production ID can differ from the production area of the From production ID, but the end item must be assigned to the production area where you are moving the split quantities.</p> <p>If you select an area that has a WIP storage location that differs from the From production area, you receive a warning message indicating that any material issued in WIP is not automatically transferred to the new area's WIP location. Use the EZ Transfer page or the Material Release page to move the components to the new WIP location.</p>
To Item ID	<p>You can split the original production ID to the same item or to a different item. However, you cannot split a primary item to a batch item—that is, an item that has at least one co-product. If you're splitting a batch item to a different batch item, then the new item inherits the by-products from the original item ID as long as they are not fully completed on the from Production ID. In that case, they are not copied.</p> <hr/> <p>Note: If the To item ID in a production ID split has an item status of <i>Hold</i> or <i>Discontinue</i>, you receive a warning message; however, the warning message does not prevent you from performing the action.</p> <hr/> <p>These situations cannot exist when selecting a value:</p> <ul style="list-style-type: none"> • The To item ID cannot exist as a component on the parent component list. • The To item ID cannot exist on the parent output list as a by-product because the To item ID would be the end item as a primary item and a by-product. • The To item ID cannot be changed on rework or teardown orders.

Field or Control	Description
Config Code (configuration code)	Select or enter a value if the item is configured: <ul style="list-style-type: none"> • If the From item ID and the To item ID are identical, you can change the configuration code for the To production ID. • If you split to a different item, the system prompts you to select a new configuration code for the To item ID. • If the configuration code changes during the split process, you can change the sales order for the new To production ID.

Related Links

“Making Stock Location Transfers Online” (PeopleSoft Inventory)

Issuing Material to the Shop Floor

“Managing Inventory by Item Status” (PeopleSoft Managing Items)

Production ID Split - Operation List Page

Use the Production ID Split - Operation List page (SF_SPLITID_OP) to indicate the production quantity to be split from the original production ID at specific operation steps.

Quantities can be split by operation based on the quantity that exists at the original production ID operation sequence.

Navigation:

Production Control > Process Production > Split Production > Production ID Split > Operation List > Header

Enter information on the Header page before accessing this page.

This example illustrates the fields and controls on the Production ID Split - Operation List page. You can find definitions for the fields and controls later on this page.

Header		Operation List											
From Production													
Unit	US008	Production ID	PRD00221	Prdn Start Qty	10.0000	Prdn End Qty	10.0000	EA					
To Production													
Split Qty	0.0000	EA	*To Prdn ID	NEXT	<input checked="" type="checkbox"/> Reset Prdn Doc	Print Docs	Ready						
Select Assy Serials													
Operation List													
Personalize Find View All First 1-3 of 3 Last													
Op Seq	Work Center	Description	Quantity Issued to Operation	Qty Completed and Thru Oper	Qty Scrapped	Qty Still at Op	Split Qty	Op Yld %	Scrap Pct	Count Point	Task Code	Description	
10	GR-ASSY	Gear Assy	10.0000	2.0000	0.0000	8.0000	<input type="text"/>	100.0000	0.00	<input type="checkbox"/>	GEAR	Gear Assy	
20	INSP	Proc Insp	2.0000	2.0000	0.0000	0.0000		100.0000	0.00	<input type="checkbox"/>	INSP	Proc Insp	
30	TEST	Testing	2.0000	2.0000	0.0000	0.0000		100.0000	0.00	<input type="checkbox"/>	TEST	Testing	

To Production

Field or Control	Description
Split Qty (split quantity)	Appears only on the header of this page, when the From production ID has operations and reflects the total split quantity for the To production ID.
To Prdn ID (to production ID)	Use <i>NEXT</i> if you are using automatic numbering, or enter a specific production ID number for the new production ID.
Reset Prdn Doc (reset production documents)	Select to reprint the production documents for the To production ID.
Components	<p>Click to view the production ID Components page. Use this page to make changes to the components that you're copying to the To production ID. This button is unavailable until a split quantity is entered at an operation.</p> <hr/> <p>Note: If you are splitting the entire production quantity to a new production ID, you cannot make adjustments to the components.</p> <hr/>

Operation List

This information appears for the From production ID, and is used to split operation data to the new production ID:

Field or Control	Description
Op Seq (operation sequence)	Operation step in which processing has or will be take place. Components or ingredients can be added here.
Work Center and Description	Current location where the From production ID is processed. These fields are display-only and cannot be changed here.
Quantity Issued to Operation	Production quantity of assemblies completed at the prior operation and sent to the current operation. If the operation is the first operation in the process, the quantity issued to operation is the production ID quantity.
Qty Completed and Thru	Quantity completed at the operation. This quantity does not include any scrapped assemblies. These fields are display-only and cannot be changed here.

Field or Control	Description
Qty Scrapped (quantity scrapped)	Number of assemblies that have been scrapped at the operation sequence. This field is display-only.
Qty Still at Op (quantity still at operation)	Production quantity that is considered still in process and that can be split to a new production ID. This display-only field is calculated using this formula: (Issued quantity) - (Quantity completed and through the operation) + Scrapped quantity)
Split Qty (split quantity)	Enter the production quantity to be transferred to a new production ID. Enter a split quantity for each operation that has a quantity remaining at the operation. However, you cannot split a quantity that is greater than the quantity still at the operation sequence. Note: You can split the entire original production quantity if you have not recorded any completions or scrap at any prior operations.
Scrap Pct (scrap percentage)	A weighted average of the scrap percentage specified when recording end item completions and scrap. This percentage represents the percentage of run time expended before the end item is scrapped.
Count Point	The check box is display-only if this operation sequence is a count point. Define an operation step as a count point on the new production ID by using the Operation List Maintenance page.
Task Code and Description	Task that is performed at the operation step.

See the product documentation for *PeopleTools: Process Scheduler*

PID Split Component List Page

Use the PID Split Component List page (SF_SPLITID_CMP_SEC) to edit components to be transferred to the new production ID.

Navigation:

Production Control > Process Production > Split Production > Production ID Split > Operation List

Enter a Split Qty (split quantity) on the Production ID Split - Operation List page. Click Tab and click the **Components** button.

Issue Quantities Tab

Field or Control	Description
Issue Qty (issue quantity)	For components using the issue or replenishment material issue method, this is the quantity consumed from the WIP location for the component and is charged to WIP. For components using the kit method, this is the quantity issued directly to the production ID.
Yield Loss Qty (yield loss quantity)	Represents the number of components lost or damaged during the production run.
To Issue Qty (to issue quantity)	<p>Represents the quantity of the component to be transferred to the new production ID. It's automatically calculated based on the end item quantity being transferred and the QPA of the component. This field is available if there are remaining assemblies that can be transferred at the operation sequence where the production ID split is occurring and components are tied to the operation sequence.</p> <p>Enter the quantity that you want to transfer to the To production ID.</p>
To Yield Loss Qty (to yield loss quantity)	<p>The quantity of components that was scrapped during the assembly process and consumed from the WIP location. This amount is transferred to the To production ID. This field is available if there are remaining assemblies that can be transferred at the operation sequence where the production ID split is occurring and the components are tied to the operation sequence.</p> <p>Enter the quantity that you want to transfer to the new (To) production ID.</p>
Iss Qty Total (issue quantity total)	The total number of components to be issued to the To production ID. For lot- or serial-controlled items, this quantity represents the sum of lot or lot quantities that you specified on the Lot/Serial page, which you access by clicking the button on the first column of the row. This field is display-only and cannot be changed here.

Pending Quantities tab

Field or Control	Description
Sched Qty (schedule quantity)	Represents the quantity per assembly based on the quantity entered and production quantity.
Pend Issue (pending issue)	Displays the quantity used based on the quantity completed at the operation multiplied by the quantity per assembly. If the component's quantity is expressed per order, this is the quantity for each order. This quantity has not yet been consumed from the WIP location due to material shortages.
Pend Loss (pending loss quantity)	Represents the quantity of components scrapped during the assembly process but not yet consumed from the WIP location due to material shortages. This quantity is based on the From production ID.
To Sched Qty (to scheduled quantity)	Displays the total number of components scheduled to be used for the To production ID.
To Pend Issue (to pending issue quantity)	Represents the new (To) production ID quantity used based on the quantity completed at the operation multiplied by the quantity per assembly. If the component's quantity is expressed as per order, this is the quantity for each order.
To Pend Loss (to pending loss quantity)	Represents the quantity of components scrapped during the assembly process but not yet consumed from the WIP location due to material shortages.
Original Component ID	Displays the name of the original component ID.
OK	Click to return to the Operation List page.

Field or Control	Description
Save	<p>Click to process the production ID split. When you save the page, the production ID split is generated and these actions occur:</p> <ul style="list-style-type: none"> • The To production ID is created with a production status of <i>In Process</i>. <p>All assemblies completed and scrapped prior to the production ID split remain with the From Production ID.</p> <ul style="list-style-type: none"> • The From production ID routing and associated component list information are copied to the To production ID. • If the components use the issue method, quantities issued are carried forward based on the split quantity. <p>Issue quantities after the split operation are not carried forward.</p> <ul style="list-style-type: none"> • Scrap costs remain with the From production ID. <p>However, you can make scrap adjustments to the To Production ID during the completions process.</p>

Note: If you are splitting the entire production quantity, all the material, actual labor and machine hours, earned conversion costs, actual conversion costs, and scrap costs are copied to the To production ID. The production status of the original production ID is set to *Canceled*, and it has a production quantity of 0.

Note: You can make manual changes to the To production ID by using the Production ID Maintenance, Component List Maintenance, or Operation List Maintenance pages. Make changes to the production start or production end quantity, BOM code, scheduling method, start date and time, or due date and time.

Related Links

[Production ID Maintenance Page](#)

[Understanding Recording Completions and Scrap](#)

Production ID Comp Transfer Page

Use the Production ID Comp Transfer page (SF_COMP_TRANSFER) to correct errors after a production ID split.

Use this page to transfer components between production IDs to cover shortages.

Navigation:

Production Control > Process Production > Split Production > Production ID Comp Transfers > Production ID Comp Transfer

This example illustrates the fields and controls on the Production ID Comp Transfer page. You can find definitions for the fields and controls later on this page.

Production ID Comp Transfer

*Business Unit

*Production ID Detail

*To Production ID Detail

Shortage Type Option

Production Shortages

Pending Shortages

Both Production and Pending

Search

View Short

Component List
Personalize | Find | View All | | First 1-4 of 10 Last

Details

Configuration Code

Component ID	Op Seq	Quantity	Std UOM	Per	Sched Qty	Issue Qty	To Sched Qty	To Issue Qty	Shortage	To Op Seq	Transfer Qty	Original Component ID
FR7001	10	1.0000	EA	Asy	100.0000	70.0000	0.0000	0.0000	0.0000	<input type="text" value="0"/>	<input type="text"/>	FR7001
FR7005	10	1.0000	EA	Asy	100.0000	70.0000	12.0000	2.0000	10.0000	<input type="text" value="10"/>	<input type="text"/>	FR7005
FR7012	20	1.0000	GAL	Asy	100.0000	40.0000	12.0000	2.0000	10.0000	<input type="text" value="20"/>	<input type="text"/>	FR7012
HB9002	30	1.0000	EA	Asy	100.0000	0.0000	12.0000	0.0000	12.0000	30	<input type="text"/>	HB9002

Note: You can only perform component transfers on production orders with a status of *In Process*. In addition, only production ID materials that have actually been issued from the original production ID can be transferred to the To production ID.

Click the **Detail** link to view production details for either the From production ID or the To production ID.

Field or Control	Description
Shortage Type Option	<p>You can view all components on the From production ID or only the components that currently have shortages on the To production ID. If you view component shortages, the values are:</p> <ul style="list-style-type: none"> <i>Pending Shortages:</i> System displays all pending shortages that exist when the pending consumed quantity and the pending yield loss quantity is greater than 0. <p>This condition indicates that the component was not found in the WIP location or storage location if kitting (kit issues create pending quantities in some instances) or insufficient quantity on hand was found and the full quantity could not be issued. A pending issue quantity could exist on the newly split production ID if there are material shortages for the component.</p> <ul style="list-style-type: none"> <i>Production Shortages:</i> System displays all production shortages that exist when the issue and yield loss quantity is less than the component's scheduled quantity. <i>Both Production and Pending:</i> System displays all components on the To production ID, including those that have both production and pending shortages.
Search	Click to retrieve the selected production ID information.
View Short	Click to view the components that have shortages.

<i>Field or Control</i>	<i>Description</i>
View All	Click to retrieve all components.
	<p>Click the Component Search button to access these links:</p> <ul style="list-style-type: none"> • From Component: Click to view component detail information for the From production ID that was split. • To Component: Click to view component detail information for the To production ID. • To Component List: Click to view the component list of the To production ID if the component appears more than twice on the To production ID.

Component List

<i>Field or Control</i>	<i>Description</i>
Issue Qty (issue quantity)	Number of components already issued or consumed on the From production ID.
To Sched Qty (to schedule quantity)	Scheduled or required component quantity on the To production ID based on production quantity and component's quantity per assembly or quantity per order.
To Issue Qty	Number of components already issued to the To production ID.
To Op Seq (to operation sequence)	Select the operation step in which the component is added to the To production ID.
Transfer Qty (transfer quantity)	Enter the quantity of the component that you want to transfer to the To production ID. If you enter a quantity that is less than the quantity that is outstanding, a pending issue quantity remains.
Original Component ID	Appears if the component was a substitution for another component requirement.

Creating Production Schedules

After fine-tuning the production plan, you may need to use the Production Schedule pages to manually enter or maintain production that you want to track by day and shift.

Important! Both production IDs and production schedules can be created and maintained by using these pages.

Production schedules can be created and maintained for each production area and item combination. You can add a schedule for production quantities that are in the *Entered* status at the summary level. Because you define production quantities due on a specific production due date and shift, production schedules are always backward scheduled. You also can maintain multiple production schedules per shift, and you can set the due time as well as the due date.

Note: You cannot use production schedules to track rework, teardown production, or regular production using the kit issue method. Rework BOMs and routings and teardown routings are not available for production schedules.

When you change any information on an existing production schedule, you can have the system send the Production ID Change workflow notification to selected roles that you define. These roles might include a planner or buyer or a production control manager.

This section lists common element and discusses how to Create Production Schedules:

Pages Used to Create Production Schedules

Page Name	Definition Name	Usage
<u>Production by Area Summary Page</u>	SF_PA_SCH_SUMMARY	Define and maintain production schedules. Add production IDs, or add, modify, and view all production for a specific production area.
Total by Production Area, Shift Page	SF_PA_SCH_SHIFT	View the schedule quantity by shift due for each day of the week. <u>Production by Area Summary Page</u>
<u>Production by Area Details Page</u>	SF_PA_SCH_DT_MAINT	View details for a production schedule or production ID. Add production IDs, modify, or view details for <i>all</i> production in a specific production area. You must define at least one production schedule or production ID before you can access this page.
Production by Area	SF_PA_SCH_SUM_INQ	View all production in a specific production area. Define at least one production schedule or production ID. <u>Production by Area Details Page</u>
<u>Production Output List Page</u>	SF_SCH_OUTPUT_LIST	View or add production output information.

Page Name	Definition Name	Usage
Production Selection Page	SF_PRDN_ITEM_SEL	Access production, rework, and teardown information for a specific item. View production IDs, production schedules, or a combination of both. Define at least one production ID or production schedule for an item.
Production List Page	SF_PRDNID_ITEM_VW	Access production information for a specific production schedule. Use this page to see the status of all production for a production area at the operation level. Define at least one production schedule for an item.
Production for an Item - Production Detail Page	SF_PRDNINQ_STATIC	Display production, rework, or teardown details associated with any production ID displayed on the Production for an Area/Item inquiry page.
Operation Detail Page	SF_PRDN_DATA_DTL	View operation list details.
Production Item Output	SF_PRDID_ITEM_OUT	View output information for a specific item. Define at least one production ID or production schedule for an item.
Production Text	SF_PRDNINQ_PRTXT	View text associated with any production schedule or production ID.
Production Inquiry - Production Selection	SF_PRDN_SELECTION	Define production criteria for the production inquiry.
Production Inquiry	SF_PRDN_MAINT_INQ	View production information for a particular production schedule or production ID. Enter production information on the Production Selection page before accessing this page.
Production Detail Inquiry	SF_PRDN_STAT_INQ	View additional details for selected production.
Production for an Item - Production Item List	SF_PRDNID_ITEM_VW	View a production summary for a selected item.

Page Name	Definition Name	Usage
Production Output	SF_PRDN_OUTPUT_INQ	View output information for production IDs or production schedules. Enter production information on the Production Selection page before accessing this page.
Production Text Inquiry	SF_PRDN_TEXT_INQ	View text associated with the selected production.
Production Output Mix Inquiry - Production Selection	SF_COMP_OUT_SEL	Enter the search criteria for the production schedule whose component and output data that you want to display. Define at least one production schedule or production ID with multiple outputs.
Prdn Op Summary (production operation summary)	SF_COMP_OUT_SUM	View production operation sequence summary data at a summary level, including task and work center information. Enter search criteria in the Production Output Mix Selection page to see data that appears in this inquiry.
Prdn Output/Component Details	SF_COMP_OUT_DTL	View specific production component and output ID data by operation sequence at a detail level. Enter production information on the Production Selection page before accessing this page.
Production History	SF_TRANSHIST	View production transaction history.
Production History Details	SF_TXN_HIST_SP	View transaction history details based on the selection criteria such as Completions Detail, Consumption Detail, or Operation Detail.
Production Schedule by Area Report	RUN_SFS2007	View total quantities, by item, produced each day for each repetitive production area.

Related Links

[Delivered Workflows for PeopleSoft Manufacturing](#)

Common Elements Used in This Section

<i>Field or Control</i>	<i>Description</i>
Frozen	Select to freeze this production schedule in the PeopleSoft Supply Planning system.
Frozen Sub (frozen substitutes)	Select to freeze substitutes in the PeopleSoft Supply Planning system. When you send the production schedule to PeopleSoft Supply Planning, the Planning engine does not include substitute components.
Revision	Select if you want to use alternate revisions for the item if the item is revision-controlled.

Production by Area Summary Page

Use the Production by Area Summary page (SF_PA_SCH_SUMMARY) to define and maintain production schedules.



Add production IDs, or add, modify, and view all production for a specific production area.

Navigation:

Production Control > Define Production > Production IDs/Schedules > Production by Area Summary

This example illustrates the fields and controls on the Production by Area Summary page. You can find definitions for the fields and controls later on this page.

<i>Field or Control</i>	<i>Description</i>
Date Query	Enter the production due date to add or view production for the appropriate workweek. After you enter a date, the system displays the corresponding day of the week.
	Click the Fetch button to retrieve the production information, to add a new production schedule or production ID, or to make changes to existing production.

Field or Control	Description
Due Shift (production due shift)	<p>The system displays the shift when the production start quantity will be completed.</p> <p>The system also displays the schedule quantity due for each day of the week.</p>
	<p>Click the Production Detail button to select one of these links:</p> <ul style="list-style-type: none"> • Details: Click to access the Production by Area Details page to make changes to the production quantities by day. • Shift Total: Click to access the Total by Production Area, Shift page to view additional production information.
	<p>Click Insert to add a production quantity for an item in the selected area.</p> <hr/> <p>Note: Click the Insert Row button to enter a row on this page. To delete a production start or production end quantity, use the Production by Area Details page.</p> <hr/>
	<p>Click the Reset Selection button to clear the information that appears in the grid and select a new area or date.</p>
Due Shift	<p>Enter a production due shift for the item and scheduled quantity.</p>
Item	<p>Enter an item value. You can maintain production quantities for items that are manufactured using either production schedules or IDs. The only restriction is that the item must be defined for the production area selected.</p> <p>Once you save the information, you cannot change the item; you can only delete the schedule.</p>

Note: When adding an assembly with item status of *Hold*, you will receive a warning message. The warning message does not prevent you from performing the action. The system also gives you the option to cancel at save time.

Production Quantity

Enter the quantity on the day the week that you want the production to be completed. If you have specified a rate quantity per shift for the area and item, you can view and select that rate by clicking the down arrow in the appropriate day column. For example, the day that you choose for the quantity is the production due date. Whether you can enter a whole number or a decimal may depend on the item's unit of measure and quantity precision combination defined in PeopleSoft Inventory. For example, suppose that item ID A0007 has a unit of measure of *EA* and a natural round, whole number combination. Then you can only enter whole numbers. If you enter an incorrect number format, you receive an error message.

The system automatically calculates the production start date and shift as well as the actual start date and time and actual due date and time once you click the **Process** button. In addition, when you enter a quantity for a day:

- The system adds the quantity on the date corresponding to the day of the week in which the quantity was entered.

The time is set to the last hour of operation for the last work center on the item's routing.

- If you're using operation yield, the system calculates the production start quantity based on the production end quantity.

Because production schedules are always backward scheduled, you enter the production *end* quantity.

- You can change the due time at the production detail level.

Field or Control	Description
	Click the Production Detail button next to the Quantity field on the day of the week that you want to change. Click the Detail link to complete the transfer.

Important! You must click the **Process** button to save the schedule before you can access the Detail page.

You can change the due time for the scheduled production from the Detail page. You can define and maintain multiple production quantities, each with a different due time.

All changes to quantities for a day must be done at the production *detail* level.

You cannot delete production quantities in the Production by Area Summary page. Navigate to the Production by Area Details page to delete quantities.

If a routing is not defined for the item and you've entered a quantity for a shift and a day on this page, you must define the production start date and production start shift on the Production by Area Details page. The system automatically changes the due time to the last hour of operation based on the production calendar. The start date and shift automatically changes to the due date and shift. The time automatically changes to the first hour of operation based on the production calendar. You can change the actual start date and time within the production start shift as well as the actual due time within the production due shift.

The system displays production due shift options based on these scenarios:

- The system uses the work center calendar for the routing's last operation, if one exists.
- If a work center calendar does not exist for the routing's last operation's work center, the system uses the production calendar, if one exists.
- If a production calendar does not exist, the shift for the five-day work week is available.

If you are adding production on the summary page, they are added in the *Entered* status. Access the Detail page to change the status or add production in the *Firmed* or *Released* statuses.

Click the **Process** button to save the production schedule or production ID. The system then calculates the production start date, time, and shift.

Note: If capacity and material availability are concerns, estimate the production start and production due dates and shifts when you create or maintain production using PeopleSoft Manufacturing, and then schedule the production schedule's or production ID's production start and production due dates and shifts using PeopleSoft Supply Planning.

The **Process** button uses Remote Call for three-tier processing. Remote Call is a PeopleCode API function that provides a means of calling a Tuxedo service from a PeopleSoft application. A typical use of Remote Call is to run data-intensive, performance-sensitive programs near or on the database server. If you experience a time-out or other error when adding or changing production information, use the Reschedule Production process (SFPCRSCH).

Production Status Change and Effects

If you are changing production information, the production status determines what changes you can make:

Production Status and Action	System
If production is in the <i>In Process</i> status and you increase or decrease the order quantity on the Detail page.	Adjusts the component scheduled quantities to reflect the new order quantity and marks the production as changed so that the Planning Engine reschedules the operations during the next planning run.
If production is in the <i>Released</i> status and you change production information such as due time or production quantity on the detail page.	Updates the component list and operation list with the new information.
If production is in the <i>Firmed</i> status and a routing is specified.	Recalculates the production start date and production start shift. The actual start date and time and due date and time are also recalculated.

See the product documentation for *PeopleTools: PeopleCode Language Reference*

Related Links

[Understanding Production Calendars](#)

[Understanding Recording Completions and Scrap](#)

“Managing Inventory by Item Status” (PeopleSoft Managing Items)

“Establishing Quantity Precision and Rounding Rules for Items” (PeopleSoft Managing Items)

[Rescheduling Production](#)

Production by Area Details Page

Use the Production by Area Details page (SF_PA_SCH_DT_MAINT) to view details for a production schedule or production ID.

Add production IDs, modify, or view details for all production in a specific production area.

Navigation:

- **Production Control > Define Production > Production IDs/Schedules > Production by Area Details**



Click the **Production Detail** button and select the **Details** link.

- **Production Control > Define Production > Production IDs/Schedules > Production by Area Summary**

Click the **Production Detail** button and select the **Details** link.

This example illustrates the fields and controls on the Production by Area Details page. You can find definitions for the fields and controls later on this page.

Field or Control	Description
Prdn Due Date (production due date), Prdn Due Shift (production due shift), Item ID , Prdn Start Date , (production start date) and Prdn Start Shift (production start shift)	Enter values for these fields to retrieve production information.
Search	Click to display the selected production information.
Compl Qty (completed quantity)	Indicates whether assemblies have been completed to stock or routed to another production area.
Scrap Qty (scrapped quantity)	Displays the number of assemblies that have been scrapped in process.

Field or Control	Description
	<p>Click the Insert button to add new production quantities.</p> <p>Each quantity that you add on the Production by Area Details page has the same business unit, production area, item ID, routing, routing item, and production due date. The system calculates the total production quantity for the production due date or on the Production by Area Summary page.</p> <p>You can only add production in the <i>Entered</i>, <i>Firmed</i>, and <i>Released</i> statuses, and you can delete <i>Entered</i>, <i>Firmed</i>, and <i>Released</i> schedules.</p>
Rtg Itm (routing item)	Displays the referenced item's routing. The end item can either have its own unique routing or reference another item's routing.
Due Time	The actual due date and time when production should be completed for the given production due date and production due shift.
Prdn Start Qty (production start quantity)	Displays the beginning quantity at the <i>first operation</i> of the manufacturing process. The system will adjust this quantity to account for any operation yield.
Prdn End Qty (production end quantity)	Displays the quantity <i>expected</i> at the end of the manufacturing process. This is the production quantity that you entered in the days of the week fields on the Production Area by Summary page.
	Click to Output List button to access the Production Output List page.

Production Status Change and Effects

Production Status and Action	Effect
<i>Firmed</i> or <i>Released</i>	The system recalculates the component scheduled quantities taking into account any operation yield.
<i>In Process</i> and you increase or decrease the production start or production end quantity	The system adjusts the component scheduled quantities (taking into account any operation yield) to reflect the new schedule quantity and marks the production as changed so that the Planning Engine reschedules the operations during the next planning run.
You decreased the production quantity and have already issued components	There might be a surplus of components at the WIP location.

Production Status and Action	Effect
You changed the production start or production end quantity and the production is released	The system automatically recalculates the actual start date and time taking into account any operation yield.

Related Links

[Defining and Viewing Master Routings](#)

Production Output List Page

Use the Production Output List page (SF_SCH_OUTPUT_LIST) to view or add production output information.

Navigation:

Production Control > Define Production > Production IDs/Schedules > Production by Area Details

Click the **Output List** button.

Output List Tab

Field or Control	Description
Output Type	Select either <i>Recycle</i> or <i>Waste</i> by-products. <hr/> Note: <i>Teardown</i> output items can only be used on teardown production IDs. <hr/>
Output Quantity	Enter the production start quantity and indicate if whether this quantity is per assembly or per order.

Note: You cannot change or add primary or co-products. However, you can change or add recycle and waste by-products.

Output Detail Tab

Field or Control	Description
Output Schd Qty (output schedule quantity)	Enter the values for the item being produced. Whether you enter a whole number or a decimal depends on the item's unit of measure and quantity precision combination defined in PeopleSoft Inventory.

Field or Control	Description
<p>BOM and Routing codes</p>	<p>Values appear and are automatically assigned from the BOM and routing code combination defined for the production area and item combination for regular production.</p> <p>Because BOM and routing combination effectivity dates are defined at the area and item level, the BOM and routing combination appears by default based on the combination in effect on the due date of the schedule. Therefore, you can have multiple BOM and routing combinations for the same area and item combination, and this affects completions.</p> <hr/> <p>Note: Because production is always backward scheduled using these pages, the production due date is used to check the BOM and routing combination effectivity dates.</p> <hr/>
<p>Prdn Start Date (production start date), Prdn Start Shift (production start shift), and Start Time</p>	<p>These fields indicate the actual date, shift, and time when production should begin, as follows:</p> <ul style="list-style-type: none"> • If a routing is not defined for the production area and item, the actual start time defaults to the due date and due time. Change the start date and time as necessary. • If a routing is defined for the production area and item, the system calculates the actual start date and time based on the item's routing and production start or production end quantity. <p>The actual due time automatically changes to the last minute of the specified shift using the calendars associated with the last operation. The last minute for the specified shift is based on the work center's calendar for the work center associated with the last operation in the item's routing. If not, the system uses the production calendar. If a production calendar does not exist, the system uses the shift for the five-day work week. Change the due time to any valid time that falls within the production due shift specified. If the shift spans multiple dates, the system determines the actual due date based on the production due date, production due shift, and actual due time specified.</p>
	<p>Click the Process button to save changes to the production schedule. The system calculates the production start date, time, and shift.</p>

Viewing Production Transaction History

Use the Production History page to track material and labor transactions associated with the WIP as an end item is manufactured on the shop floor. View production transaction history based on a business unit, production ID, or schedule and a date range or see all transactions recorded by a particular user ID. Within PeopleSoft Manufacturing, each operation or end item completion transaction is recorded with the date and time stamp as the end item is produced on the shop floor.

You can review previously posted transactions and navigate to the details of each transaction. You can also see where the completed assemblies are routed—either to an inventory storage location or to another production ID.

Pages Used to View Production Transaction History

<i>Page Name</i>	<i>Definition Name</i>	<i>Usage</i>
Production History Page	SF_TRANSHIST	View production transaction history.
Production History Details Page	SF_TXN_HIST_SP	View production history details based on the selection criteria. Production History Page

Common Element Used in This Section

<i>Field or Control</i>	<i>Description</i>
	Click the Item Search button to access the Item Search link to select a different item.

Production History Page

Use the Production History page (SF_TRANSHIST) to view production transaction history.

Navigation:

Production Control > Define Production > Review Production Information > Production History

This example illustrates the fields and controls on the Production History page. You can find definitions for the fields and controls later on this page.

The screenshot shows the 'Production History' page with the following fields and controls:

- *Business Unit:** US008
- Production ID:** PRD00223
- Production Area:** GEARS
- Item ID:** SR2201 (Gear Subassembly)
- From Date/Time:** 08/07/2009 12:00AM
- To Date/Time:** 08/07/2009 11:59PM
- User ID:** (empty)
- Component ID:** (empty)
- *Inquiries:** Completions Detail
- Search** button
- All Transactions** checkbox (checked)
- Navigation controls: 1 to 0 of 0

Below the filters is a table titled 'Valid Productions' with columns: Area, Item ID, Description, Prdn Due Date, Prdn Due Shift, BOM Code, and Routing Code. The table is currently empty.

The type of production information that appears depends on the selection of inquiry values on the Production History page. You can view production transaction history for:

- Completions detail
- Component consumption
- Operation detail

Selection Criteria Options

There are several ways to view production information using the Production History page. Narrow the selection by entering a From date and time and To date and time range with any of these options. For example, to view a production ID for a specific date range, enter a beginning date and an ending date.

Field or Control	Description
Production ID	Use to select a specific production ID. When you make this selection, the production area and item ID are unavailable for selection, but the system displays the area and item associated with the production ID. If you're selecting the completions detail for a single production ID, you automatically access the Production History Details page.
Production Area	Select <i>all</i> production based on the production area. This includes both production IDs and production schedules for all items.
Item ID	Select all production schedules for a particular item in the area specified.
User ID	Select production recorded by a specific user.

Field or Control	Description
Component ID	View all production that uses this specific component. This field is only available when you select <i>Component Consumption</i> . If you want to view all component consumption usage, leave this field blank.
All Transactions	Select this option to view all transactions for the selected criteria.
Search	Click to retrieve the transaction history information based on the selection criteria.

Rescheduling Production

Reschedule selected production IDs or production schedules with a status of *Entered*, *Firmed*, *Released*, or *In Process*.

Pages Used to Reschedule Production

Page Name	Definition Name	Usage
<u>Reschedule Production Page</u>	SF_PRDN_RSCH_REQ	Reschedule selected production IDs or production schedules. Use this page to reschedule multiple production IDs and production schedules simultaneously. You must have defined at least one production ID or production schedule.
<u>Production Selection Page</u>	SF_PRDN_RELSE_REQ2	Define additional information for production that you want to reschedule. You must have defined at least one production ID or production schedule.

Reschedule Production Page

Use the Reschedule Production page (SF_PRDN_RSCH_REQ) to reschedule selected production IDs or production schedules.

Use this page to reschedule multiple production IDs and production schedules simultaneously.

Navigation:

Production Control > Define Production > Production IDs/Schedules > Reschedule Production

<i>Field or Control</i>	<i>Description</i>
Order Statuses	You can reschedule production with a production status of: <ul style="list-style-type: none"> • Entered • Firmed • Released • In Process
Start Date Range	Choose production for all dates, or enter a range of dates. Any production whose operation is due to start within the actual start date range specified is included.

Production Selection Page

Use the Production Selection page (SF_PRDN_RELSE_REQ2) to define additional information for production that you want to reschedule.

Navigation:

- **Production Control > Process Production > Release Production > Request Prdn Status Change > Production Selection**
- **Production Control > Define Production > Production IDs/Schedules > Reschedule Production > Production Selection**

Report Request Parameters

<i>Field or Control</i>	<i>Description</i>
Select Production IDs and Select Production Schedules	Indicate whether you want to reschedule production for a particular production ID or schedule, for a range of production IDs, production schedules, or for all production types by selecting both check boxes.
Check Subcontracted Operations	Select to have the system to include production IDs with subcontracted operations.
Run	Click to run the Reschedule Production process at user-defined intervals.

Maintaining Component Lists

Understanding Component Lists

When the system releases production to the shop floor, it creates a component list for the production quantity specified and associates it with the production ID or production schedule. With the creation of a component list, PeopleSoft Manufacturing provides you with the ability to alter the bill of material (BOM) to accommodate item substitutions or configuration changes. You can also associate attachments with each component on the component list.

Once you define a production area/item combination and create a production ID or production schedule for an item, you can verify and change the production requirements before or after releasing production to the shop floor.

You can create a component list by:

- Manually changing a production ID or production schedule status from *Entered* to *Firmed* or *Released* or running the batch release process for a range of production IDs or production schedules.

When the production status is changed to *Firmed* or *Released* for:

- Regular production: The system copies the valid BOM in effect on the production due date or for the specified revision into the component list for the production ID or production schedule.

For a configured end item, the component list comprises standard items, as well as the options and features selected for the particular configuration. For this type of production, a component cannot be the same item ID as the item ID being produced. Floor stock and expensed items appear for informational purposes only.

- Rework production for an item without a rework BOM: The system creates a component list with the reworked end item as the only component and assigns the Kit issue method.

The scheduled quantity is the same as the production quantity. If additional material is needed to complete the rework, manually add the items to the component list using the Edit/Issue Components page. Additionally, if component requirements are known prior to the start of rework, you can specify those components using the Update Component List pages. This enables you to issue the additional components, along with the end item being reworked, using the Material Pick Plan. The system issues any additional components required for rework production using the issue method set for each item at the production area/item level.

- Rework production for an item with a rework BOM: The system bases the component list on the rework BOM and automatically adds the reworked end item as a component and assigns the Kit issue method.

For the reworked end item, the scheduled quantity is the same as the production quantity. For additional components on the rework component list, the system calculates the scheduled quantity based on the quantity per component and the rework production quantity.

- **Teardown production:** The system automatically adds the end item to be torn down as a component when the production is released and assigns the Kit issue method.

You can't change or delete the end item, but you can add additional components if necessary. The scheduled quantity is the same as the production quantity. The system issues any additional components required for teardown production using the issue method set for each item at the production area/item level. These additional components can't be substituted. The scheduled quantity is the same as the production quantity.

- Processing new production recommendations for production IDs and production schedules from PeopleSoft Supply Planning in PeopleSoft Manufacturing.
- Recording an end item or production completion.

If you specify a production schedule quantity or production ID quantity that still has a status of *Entered* or *Firmed* during the completions and scrap reporting process, the system prompts to release the production and creates the component list. The ability to release production during the completion process is dependent on the manufacturing business unit options.

- Adding a production schedule after you have completed manufacturing an item.

When you add a production schedule quantity at the same time that you record operation completions and scrap, the system automatically creates the production schedule, releases production, and creates the component list. After backflushing, components are consumed and costs are posted for the completed quantity.

- Running the production configuration process for a configured order.

When the production ID for the configured item is created, the status is automatically set to *Released*, and the component list is created based on the options and features selected during the configuration process.

The component lists created differ depending on whether the component list is for regular, teardown, or rework production or for a configured item. For regular production, the system uses the end item's BOM to create the component list. For teardown production, the component list consists of the item that you are tearing down, which is automatically issued using the Kit issue method. For rework production, the system bases the component list on the rework BOM if there is one and automatically adds the reworked end item as a component and assigns it the kit issue method. If a rework BOM doesn't exist, the system creates a component list with only the reworked end item as a component.

For a configured item, the component list is created using the options and features selected during sales order entry. You can modify either component list by adding new components, deleting existing components, or changing the quantity per assembly or per order, scheduled quantity, or component yield. You can't specify configured items as a component on a component list for a non-configured end item. Configured items can have other configured items as components. You can't change the rework or teardown end item on the component list.

This section discusses how to:

- Create component lists for regular production.
- Create component lists for rework production.

- Create component lists for teardown production.
- Modify the component list during the production process.

Creating Component Lists for Regular Production

To create a component list for regular production, the system copies the item's BOM. The component list defines the required components for the production quantity. You define which BOM to use for production by selecting the appropriate revision of the BOM or using the BOM in effect at the time production is due.

Note: Components that are supplied by an outside supplier aren't included when creating the component list. These components are marked as subcontractor-supplied on the item's BOM.

Note: Floor stock and expensed items are included on the component list for informational purposes only. Although the system calculates and displays a scheduled quantity, these items aren't included in any pick plan and therefore won't be issued to production during the material release process.

When creating the component list, the system determines the scheduled quantities and current scheduled quantities for each of the end item's components. Scheduled quantity is based on this formula:

$$[(\text{operation start quantity} \times \text{quantity per assembly}) / \text{component yield}]$$

The scheduled quantity is calculated based on the quantity of the end item started at the operation where the component is used. In addition, the system also initializes the components operation sequence and quantity per assembly or per order with information from the BOM. The components issue method defined for the end item within the production area is also defined at this time.

If you're adding a new component, the scheduled quantity is calculated the same as when a production ID is created ($\text{operation start qty} \times \text{qty per assy} / \text{component yield}$).

If you're changing the scheduled quantity, then the system calculates the quantity per assembly: $\text{QPA} = (\text{current component scheduled qty} \times \text{component yield}) / \text{operation start qty}$. The operation start quantity factors in any planned yield loss or actual scrap that has occurred at prior operation sequences.

If you're changing the QPA, then the current scheduled quantity is recalculated using the operation start quantity at the operation sequence where the component is required.

Related Links

[Understanding BOM Maintenance](#)

Creating Component Lists for Rework Production

PeopleSoft Manufacturing creates the component list for rework production somewhat differently than for regular production. When the rework production ID is released, the system adds the end item being reworked to the component list, with a scheduled quantity the same as the production quantity. The system assigns the kit issue method to the end item being reworked. Additionally, if the end item being reworked has a rework BOM associated with the rework production ID, the system calculates the additional component requirements and adds them to the component list on the rework BOM. The system issues any additional components required for rework production using the issue method set for each item on the production area/item level. The issue method defaults from the Define Business Unit

Item - Manufacturing page; you can override it on the Production Area - Item Detail page. The operation sequence of the reworked end item is automatically set to 0. The operation sequence of the additional components reflects the operation sequence specified on the rework BOM. If you haven't predefined a rework BOM, you can add other components to the component list as needed to repair or rework the end item.

Creating Component Lists for Teardown Production

PeopleSoft Manufacturing creates the component list for teardown production by copying the item that you are tearing down into the component list with a scheduled quantity the same as the order quantity. If additional material is needed to tear down the item, manually add those components to the component list. The issue method for the end item being torn down is automatically set to Kit. The system issues any additional components required for teardown production using the issue method set for each item at the Production Area/Item level. The issue method defaults from the Define Business Unit Item - Manufacturing page; you can override it on the Production Area - Item Detail page.

Modifying the Component List

You can modify the component list after the release of the production ID—even if production is in process. If you have already consumed or issued components on the component list, you can't delete those components from the production ID. However, you can:

- Add, change, or delete other components.

However, for teardown or rework production, you can't delete the teardown or reworked end item from the component list. Additionally, you can only add a configured item as a component if the end item is also a configured item.

- Change the operation sequence.
- Change component quantities.
- Indicate whether the component is issued per assembly or per order.
- Change the component yield.

When you modify a component list and if you are integrating to a third-party Manufacturing Execution System (MES), PeopleSoft Manufacturing uses the Production Order Update Enterprise Integration Point (EIP) to publish a message to the MES with the transaction information. The MES then subscribes to that message and updates the MES information.

In addition, you can also view and edit a limited number of components associated with a production ID or production schedule. Select a subset of components by using various filters. Use this when you do not want to select all the components associated with the production ID or production schedule.

Related Links

[Integrating with an Electronic Data Collection System](#)
[Manufacturing Execution System Integration](#)

Common Elements Used in Component Lists

<i>Field or Control</i>	<i>Description</i>
Prdn ID (production ID)	The production order identifier.
Item ID	The name and description of the item being manufactured.
Config Code (configuration code)	A unique identifier for costing and inventory tracking purposes. The configuration code appears if the end item is a configured item.
Production Status	The current status of the production.
Production Area	The area where the item is being manufactured.
Prdn Type (production type)	The type of production being manufactured: <i>Production</i> , <i>Rework</i> , or <i>Teardown</i> .
Op Seq (operation sequence)	The operation step where the component is added.
Prdn Start Qty (production start quantity)	The starting quantity for the production ID or production schedule at the beginning of the manufacturing process.
Prdn End Qty (production end quantity)	The quantity expected for the production ID or production schedule at the end of the manufacturing process.
Expected Yield % (expected yield percentage)	The percentage that you expected for the production ID or production schedule at the end of the manufacturing process.
Component ID and Description	The name of the component being used in the selected production.
Source Cd (source code)	Valid source codes are <i>Make</i> , <i>Buy</i> , <i>Expensed</i> , or <i>Floor Stock</i> .

Maintaining Component List Information

This section discusses how to:

- Define component selection criteria.
- Select specific components.
- Maintain the component list summary.

- Make item substitutions.
- Maintain component detail.
- View component status information.
- Associate component documents.
- Specify component attachments.
- Delete components from component lists.

Pages Used to Maintain Component List Information

Page Name	Definition Name	Navigation	Usage
Update Component List - Production Selection	SF_COMP_MAINT_SEL	Production Control > Define Production > Production IDs/Schedules > Update Component List > Production Selection	Select a specific production ID or production schedule to add, change, or delete components when the production status is <i>Firmed</i> , <i>Released</i> , or <i>In Process</i> . Define at least one production ID or production schedule with a production status of <i>Firmed</i> , <i>Released</i> , or <i>In Process</i> .
Component List Selection	SF_SELECT_COMPS_SP	Click the Select Components link on the Update Component List - Production Selection page.	Select specific components to modify.
Update Component List - Summary: Summary	SF_COMP_MAINT_GRD	Production Control > Define Production > Production IDs/Schedules > Update Component List > Summary > Summary	Add, change, or delete components when the production ID or schedule status is <i>Firmed</i> , <i>Released</i> , or <i>In Process</i> .
Item Substitution	SF_COMP_MAINT_GRD_DET	Production Control > Define Production > Production IDs/Schedules > Update Component List > Summary > Summary Click the Item Search button next to the Component ID.	Display or change substitute items selected by PeopleSoft Supply Planning, based on the criteria that you specify.

Page Name	Definition Name	Navigation	Usage
Update Component List - Production Text	SF_COMP_PRDN_TEXT	Production Control > Define Production > Production IDs/Schedules > Update Component List > Summary > Production Text	Display or modify text associated with production.
Update Component List - Detail: Detail	SF_COMP_MAINT2	Production Control > Define Production > Production IDs/Schedules > Update Component List > Detail > Detail	View additional information for a component.
Component Detail	SF_COMP_MAINT2_SP	Production Control > Define Production > Production IDs/Schedules > Update Component List > Detail > Detail Click the Detail button.	View component detail activity at a summary level.
Update Component List - Detail: Component Text	SF_COMP_TEXT	Production Control > Define Production > Production IDs/Schedules > Update Component List > Detail > Component Text	Associate or modify text with any component on a component list. For regular production, any component text from the BOM is copied, along with the component at the time the component list is created.
Update Component List - Detail: Documents	SF_COMP_DC	Production Control > Define Production > Production IDs/Schedules > Update Component List > Detail > Documents	Associate, access, and manage pertinent component documents in the embedded document management system. You must have PeopleSoft Engineering installed to access this page.
Update Component List - Detail: Documents Details	DC_DOC_DETAILS_SP	Production Control > Define Production > Production IDs/Schedules > Update Component List > Detail > Documents Click the Detail button for the selected document.	View additional information about the selected document from the document vault. You must have PeopleSoft Engineering installed to access this page.

Page Name	Definition Name	Navigation	Usage
Update Component List - Detail: Attachments	SF_COMP_ATT	Production Control > Define Production > Production IDs/Schedules > Update Component List > Detail > Attachments	Associate attachments with the components. Any component attachments from the BOM, and not associated with phantom items, are copied along with the components at the time that the component list is created.
Component List - Production Selection inquiry	SF_COMP_SELECTION	Production Control > Define Production > Review Production Information > Component List > Production Selection	Select the production ID or production schedule information to view a component list.
Component List - Summary: Summary inquiry	SF_COMP_LIST_GRD	Production Control > Define Production > Review Production Information > Component List > Summary > Summary	View a summary of the component list.
Component List - Summary - Production Text inquiry	SF_COMP_LIST_PRTXT	Production Control > Define Production > Review Production Information > Component List > Summary > Production Text	Display text associated with the production.
Component List - Detail: Detail inquiry	SF_COMP_LIST2	Production Control > Define Production > Review Production Information > Component List > Detail > Detail	Display detail for a specific component.
Component List - Detail: Component Text inquiry	SF_COMP_LIST_TXT	Production Control > Define Production > Review Production Information > Component List > Detail > Component Text	Display text for a component.
Component List - Detail: Documents inquiry	SF_COMP_LIST_DC	Production Control > Define Production > Review Production Information > Component List > Detail > Documents	Display component documents for each component. You must have PeopleSoft Engineering installed to access this page.

Page Name	Definition Name	Navigation	Usage
Component List - Detail: Attachments inquiry	SF_COMP_LIST_ATT	Production Control > Define Production > Review Production Information > Component List > Detail > Attachments	Display component attachments for each component.
Comp Where Used Selection (components where used selection)	SF_COMPWUSE_INQ	Production Control > Define Production > Review Production Information > Component Where Used in Prdn	Select the components that you want to view.
Component Where Used List	SF_COMPWUSE_GRD	Production Control > Define Production > Review Production Information > Component Where Used in Prdn > Component Where Used List	View where components are used in production. Click the View Related Links button to access other pages to view additional component information, such production details, item substitution, and operation details.
Component Selection report page	RUN_SFS2006	Production Control > Define Production > Reports > Component Where Used Report > Component Selection	Select the components for the Component Where Used in Production report.

Update Component List - Production Selection Page

Use the Update Component List - Production Selection page (SF_COMP_MAINT_SEL) to select a specific production ID or production schedule to add, change, or delete components when the production status is Firmed, Released, or In Process.

Define at least one production ID or production schedule with a production status of Firmed, Released, or In Process.

Navigation:

Production Control > Define Production > Production IDs/Schedules > Update Component List > Production Selection

This example illustrates the fields and controls on the Update Component List - Production Selection page. You can find definitions for the fields and controls later on this page.

<i>Field or Control</i>	<i>Description</i>
Production ID	Select to view or maintain the component list for a specific production ID.
Production Area and Item	Enter values in both fields to view or maintain the component list for production schedules. The production schedule information is based on the start date of production or when production is due to be completed.
Select Components	Click this link to access the Component List Selection page, where you can retrieve specific components.

Date Type

<i>Field or Control</i>	<i>Description</i>
Prdn Start (production start) and Prdn Start Date (production start date)	Select Prdn Start to view the production schedules that are or were due to begin on a specific production start date. Select the production start date for the production schedule. Scroll through the list until you find the specific production schedule that you'd like to view.
Prdn Due (production due) and Prdn Due Date (production due date)	Select Prdn Due to view production schedules based on production due dates. Scroll through the list until you find the specific production schedule that you'd like to view. Select the production due date for the production schedule.

Field or Control	Description
Prdn Due Shift (production due shift) or Prdn Start Shift (production start shift)	<p>Select a valid shift for the production schedule based on either when the shift ends or when the shift begins.</p> <hr/> <p>Note: If multiple production schedules exist for the production area/item/date/shift, then a warning appears followed by a listing of the production schedules from which you can select one production schedule to maintain.</p> <hr/>
Search	Click the Search button to retrieve the information associated with the production ID or production schedule.

Component List Selection Page

Use the Component List Selection page (SF_SELECT_COMPS_SP) to select specific components to modify.

Navigation:

Click the **Select Components** link on the Update Component List - Production Selection page.

This example illustrates the fields and controls on the Component List Selection page. You can find definitions for the fields and controls later on this page.



Component List Selection [Help](#)



Business Unit US008 **Production ID** PRD00235



Op Sequence Range

All Op Sequences
 Range From Op Seq To

Component Range

All Components
 Range From Comp ID  To 
 Description
 List of Components

Component List Personalize | View All |  First  1-5 of 10  Last

Component ID	Description
	
	
	

Op Sequence Range

<i>Field or Control</i>	<i>Description</i>
All Op Sequences (all operation sequences)	Select this option if you do not want to filter by operation sequence.
Range	Enter a range of operation sequences.

Component Range

Select one of these options:

- **All Components**
- **Range**
- **Description:** Enter the words or strings included in the component's description. The system retrieves any component whose description contains the words or string that you enter in this field.

Note: The values for this field are case sensitive.

- **List of Components:** Select specific components to retrieve.

Note: You can use both the **Op Sequence Range** and **Component Range** options to further filter the selection criteria.

Click **OK** to retrieve the selected components and access the Summary page.

Click **Cancel** to return to the Production Selection page.

Update Component List - Summary: Summary Page

Use the Update Component List - Summary: Summary page (SF_COMP_MAINT_GRD) to add, change, or delete components when the production ID or schedule status is Firmed, Released, or In Process.

Navigation:

Production Control > Define Production > Production IDs/Schedules > Update Component List > Summary > Summary

This example illustrates the fields and controls on the Update Component List - Summary: Summary page: Qty Data tab. You can find definitions for the fields and controls later on this page.

The screenshot shows the 'Summary' page for production ID PRD00229. The 'Qty Data' tab is active, displaying a table of components. The table has the following data:

*Component ID	Description	Op Seq	Quantity	Std UOM	*Per	*Yield	Sched Qty
FR7002	Bike Frame, Aluminium	10	1.0000	EA	ASY	100.0000	100.0000
FR7005	Front Fork	10	1.0000	EA	ASY	100.0000	100.0000
FS3000	Bolt	10	1.0000	EA	ASY	100.0000	100.0000
FS3001	Washer	10	1.0000	EA	ASY	100.0000	100.0000
FS3002	Nut	10	1.0000	EA	ASY	100.0000	100.0000
LT5000	Standard Wheel Subassembly	30	1.0000	EA	ASY	100.0000	100.0000

Field or Control	Description
Print at Save	Select this check box if you want to print production documents at save time.
Setup Print Options	Click this link to access the Process/Output Options page to select different print criteria for the production documents.

Component Summary

Field or Control	Description
Component ID	Select the component being added.
Item Search	Click to search for the item ID using various search criteria.
Op Seq (operation sequence)	<p>Determines where in the manufacturing process that you need the components. PeopleSoft Manufacturing uses the work center associated with each operation, and the WIP location associated with each work center to determine where to deliver components. The component's issue method in combination with the operation sequence determines when and where the material is delivered and how the system updates inventory in the WIP location or the issue quantity on the component list.</p> <p>When the operation sequence is set to zero or an invalid operation sequence is specified, it is assumed that the component item will be used at the first operation. In this case, PeopleSoft Supply Planning uses the recorded completions and scrap at the first operation to calculate the correct kit component quantity on hand.</p>
Quantity	Enter the number of components required based on per assembly or per order.
Per	Displays the component requirements in amounts per <i>Asy</i> (assembly) with a unit of 1, or per <i>Ord</i> (order), an amount regardless of the order size.
Yield	Displays the expected percentage of usable components within a batch of components issued to production. You can change the component yield here. If you change the yield, the system recalculates the schedule quantity for the component relating to this production only.
Sched Qty (schedule quantity)	<p>Enter the number of components required for the batch production.</p> <p>To calculate the scheduled quantity with a known quantity per assembly:</p> <p>Scheduled Quantity = operation start quantity * [Quantity Per Assembly / (Component Yield / 100)]</p>

Quantity Per Calculations

You can calculate the quantity per assembly or per order.

- To calculate the quantity per assembly with a known scheduled quantity:

$$\text{Quantity Per Assembly} = [(\text{Scheduled Quantity} / \text{operation start quantity}) \times (\text{Component Yield} / 100)] + .00005^*$$

*.00005 is used for rounding

- To calculate the quantity per order with a known scheduled quantity:

$$\text{Quantity Per Order} = \text{Scheduled Quantity}$$

Important! To provide greater accuracy when modifying component data, we don't require the **Quantity** field to follow the quantity precision rules defined for the item. A warning is issued if you define a decimal quantity value for an item whose quantity precision value is a whole number.

Scheduled Quantity Calculations

You can calculate the scheduled quantity per assembly or per order.

- To calculate the scheduled quantity with a known quantity per assembly:

$$\text{Scheduled Quantity} = \text{Production Start Quantity} \times [\text{Quantity Per Assembly} / (\text{Component Yield} / 100)]$$

Note: The production start quantity in this calculation denotes the starting quantity required at the operation sequence associated with the component. If there is no operation sequence, then the production start quantity is the starting quantity of the production ID or production schedule.

- To calculate the scheduled quantity with a known quantity per order:

$$\text{Scheduled Quantity} = \text{Quantity Per Order}$$

Note: The format for the Scheduled Quantity on this page may be determined by the item's unit of measure and quantity precision combination that was defined in PeopleSoft Inventory.

Other tab

<i>Field or Control</i>	<i>Description</i>
Op Seq (operation sequence)	Enter the operation step where the component is to be added.
Qty on Hand (quantity on hand)	The system displays the total, available quantity on hand for the component.

Issue Method

When you set the component issue method to *Issue*, material is delivered to the work center WIP location. When you record end item completions for the operation, the components associated with that operation sequence are consumed from the work center's WIP location. At that point, the system decrements the quantity on hand in the WIP location and updates the issue quantity on the component list.

Components using the Replenishment method are handled in a manner similar to those using the Issue method. Material is delivered to the WIP location using the production replenishment pages as a result of a worklist notification.

When you record end item completions, the components associated with that operation sequence are consumed from the work center's WIP location. At that point, the system decrements the quantity on hand in the WIP location and updates the issue quantity on the component list.

If you are using PeopleSoft Flow Production, you can also replenish the WIP locations directly from an inventory location, feeder line, or supplier using Kanban Cards or online replenishment requests.

When you use the Kit component issue method, the operation sequence is only a reference for the material handler. Kitted material is delivered to the work center tied to the operation sequence, but the system charges the material directly to the production ID upon issue. The material isn't issued to the work center's WIP location, nor consumed when the operation is completed. The system updates the issue quantity on the component list when the material is released to production.

When you add a new component to the component list, the operation sequence defaults to zero. A component with an operation sequence of zero means that the component will be used at the first operation. If an invalid operation sequence has been specified on the end item's BOM, the system assumes that it will be used at the first operation.

For the phantom item's components, the system assigns the phantom's operation sequence to all of its components.

If an invalid operation sequence has been specified on the end item's BOM, or the operation sequence is set to zero, the system issues the components to the production area's WIP location. Owned components are issued only to owned WIP locations. Likewise, non-owned components are issued only to non-owned WIP locations.

Serial Control

The **Serial Control** check box is a display-only field that indicates if the component is serial-controlled.

Teardown

The **Teardown** check box designates the component as a potential teardown output. This value is copied from the BOM Component Detail page. If a production ID is selected as the basis for a teardown order, the components designated as teardown are considered the outputs from the teardown production.

Substitute

The **Substitute** check box designates that a substitution has already taken place. This value is copied from the Component List Substitution detail page.

MES and Component Lists

When you modify a component list, if you are integrating to a third-party MES, PeopleSoft Manufacturing uses the Production Order Update EIP to publish a message to the MES with the transaction information. The MES then subscribes to that message and updates the MES information.

Related Links

[PeopleSoft Manufacturing Reports: A to Z](#)

[Understanding Production IDs and Production Schedules](#)

“Managing Inventory by Item Status” (PeopleSoft Managing Items)

Item Substitution Page

Use the Item Substitution page (SF_COMP_MAINT_GRD_DET) to display or change substitute items selected by PeopleSoft Supply Planning, based on the criteria that you specify.

Navigation:

Production Control > Define Production > Production IDs/Schedules > Update Component List > Summary > Summary

Click the **Item Search** button next to the Component ID.

<i>Field or Control</i>	<i>Description</i>
Substitute Items	Displays the original component and a list of valid substitutes for the original component. PeopleSoft Supply Planning selects the component based on the criteria that you selected.
Sel (select)	Select this check box to manually override the Supply Planning component selection.
OK	Click to return to the component list Summary page where the substitution selection appears.
Substitute	Indicates if the component is a substitute.
Orig Comp ID (original component ID) and Description	The values are display only. A difference between the component ID and original component ID indicates that a substitution has taken place.

Update Component List - Detail: Detail Page

Use the Update Component List - Detail: Detail page (SF_COMP_MAINT2) to view additional information for a component.

Navigation:

Production Control > Define Production > Production IDs/Schedules > Update Component List > Detail > Detail

This example illustrates the fields and controls on the Update Component List - Detail: Detail page. You can find definitions for the fields and controls later on this page.

Field or Control	Description
Component Details	Summarizes the activity of the component for the production ID or production schedule.
Orig Comp ID (original component ID)	Displays the original component ID, if this component is a substitute, as well as the issue method for the component. There are several component issue methods: <i>Production Issue</i> , <i>Production Kit</i> , and <i>Production Replenishment</i> .
Source Cd (source code)	Values are <i>Make</i> , <i>Buy</i> , <i>Expenses</i> , or <i>Floor Stock</i> .
Sched Qty (current scheduled quantity) and Yield	Fields are display only, but you can change this information.
Quantity	Displays the calculated quantity per assembly or per order. The system calculates the quantity per by dividing the quantity per assembly by the BOM's BOM quantity. You designate the level of precision for the calculated quantity per in the manufacturing installation options page.
Config Code (configuration code)	Displays a code if the item is configured. If you add a configured item to the component list, you must add the configuration code here. Note: For serial-controlled items, values in the Quantity Per and Scheduled Quantity fields must be whole numbers.

<i>Field or Control</i>	<i>Description</i>
Non-Owned Item	Indicates that the component is supplied by the customer or is a consigned item. Approved consigned items can be added to component lists.
Teardown	Designates the component as a potential teardown output. This value is copied from the BOM Component Detail page.

Related Links

“Understanding Consigned Purchases in Inventory Management” (PeopleSoft Inventory)

Component Detail Page

Use the Component Detail page (SF_COMP_MAINT2_SP) to view component detail activity at a summary level.

Navigation:

Production Control > Define Production > Production IDs/Schedules > Update Component List > Detail > Detail

Click the **Detail** button.

This example illustrates the fields and controls on the Component Details page. You can find definitions for the fields and controls later on this page.

Component Detail

Component ID	FR7002	Std UOM	EA	Source Cd:	Buy
	Bike Frame, Aluminium				
Issue Method:	Issue				
Pending Issue Qty	0.0000	Pending Yield Loss Qty	0.0000		
Yield Loss Qty	0.0000	Pending Pick Quantity	0.0000		
Issue Qty	0.0000				

<i>Field or Control</i>	<i>Description</i>
Pending Issue Qty (pending issue quantity)	Displays the quantity used based on the quantity completed at the operation multiplied by the quantity per assembly. If the component's quantity is expressed as per order, this is the per order quantity. The per order quantity is completely consumed at the first backflush. This quantity hasn't yet been consumed from the WIP location due to material shortages.

Field or Control	Description
Yield Loss Qty (yield loss quantity)	Displays the quantity that was scrapped during the end item process and consumed from the WIP location.
Issue Qty (issue quantity)	For components using the <i>Issue</i> or <i>Replenishment</i> material issue method, this is the quantity that was consumed from the WIP location for the component and that was charged to work in process. For components using the <i>Kit</i> method, this is the quantity issued directly to the production ID.
Pending Yield Loss Qty (pending yield loss quantity)	Displays the quantity of components that was scrapped during the end item process but that has not yet been consumed from the WIP location due to material shortages.
Pending Pick Quantity	Displays the quantity that is awaiting issue to the WIP location or to the production ID to satisfy the scheduled component requirement. The pick plan has already been generated for these components but they haven't yet been reviewed and released to production.

Update Component List - Detail: Documents Page

Use the Update Component List - Detail: Documents page (SF_COMP_DC) to associate, access, and manage pertinent component documents in the embedded document management system.

You must have PeopleSoft Engineering installed to access this page.

Navigation:

Production Control > Define Production > Production IDs/Schedules > Update Component List > Detail > Documents

This example illustrates the fields and controls on the Update Component List - Detail: Documents page. You can find definitions for the fields and controls later on this page.





The screenshot displays the 'Update Component List - Detail: Documents' page. It features several tabs: 'Production Selection', 'Summary', and 'Detail'. The 'Detail' tab is active, showing component information for 'Mountain Bike, Womans - Millennium Edition'. Fields include Business Unit (US008), Prdn ID (PRD00229), Status (Released), Item ID (MT3020), Area (FINAL), Prdn Type (Production), UOM (EA), Prdn Start Qty (100.0000), Prdn End Qty (100.0000), and Expected Yield % (100.0000). A 'Serial in Prdn' checkbox is present. Below the component details is a 'Component Detail' section for 'Bike Frame, Aluminium' with a search for Component ID 'FR7002' and Op Seq '10'. It also shows Std UOM (EA) and Source Code (Buy). At the bottom, a 'Documents' table is shown with columns: Sel, Document Name, Title, and Fixed. The table currently has one row with 'N' in the Fixed column.



Note: You must have PeopleSoft Engineering installed before you can access this page.

Using the Documentum Component Options page, you control the document management buttons that appear on this page.

Component Details and Documents

The system displays all the documents associated with this component list, including the document name and title, and whether the document is fixed or not. When you fix an associated document to a page, a specific version of the document is "permanently" associated with the page.

<i>Field or Control</i>	<i>Description</i>
	Click to view document detail.
	Click to query the Documentum database.
	Click to view document contents.
	Click to launch Documentum.
	Click to edit documents in the Documentum database.

<i>Field or Control</i>	<i>Description</i>
	Click the Checkout button to check out documents from the vault. Click the Checkin button to check in documents from the vault. Click the Cancel the Checkout/Checkin button to cancel these operations.
	Click the Fix/Unfix Versions to change versions.
	Click to copy links.

Related Links

“Understanding Document Management in PeopleSoft Engineering” (PeopleSoft Engineering)

Update Component List - Detail: Attachments Page

Use the Update Component List - Detail: Attachments page (SF_COMP_ATT) to associate attachments with the components.

Any component attachments from the BOM, and not associated with phantom items, are copied along with the components at the time that the component list is created.

Navigation:

Production Control > Define Production > Production IDs/Schedules > Update Component List > Detail > Attachments

<i>Field or Control</i>	<i>Description</i>
Component ID and Op Seq (component ID and operation sequence)	Enter values that you want to associate with the component.
File Ext (file extension)	Select the type of media that you want to attach to the component.
Document and Description	Specify the file name and description of the item.
	Click the Attachments button to launch the multimedia object attached to the component.

Deleting Components from the Component List

When deleting components, the system checks to see if material was issued to the location associated with the component's operation sequence, if material was consumed during a backflush or if material

was issued using a production kit. A warning message appears if material was issued to the location. If material was consumed during a backflush, issued directly to the production ID, or an inventory picking plan has already been created for the component, the system won't allow you to delete the component. To delete the component, reverse the backflush, unconsume or debit the component, and then delete it.

Maintaining Operation Lists

Understanding Operation Lists

When the system releases production to the shop floor, it freezes the item's routing for the production quantity specified and copies it to the operation list. In addition, you can also modify the operation list to take into account known capacity constraints for machines that may be unavailable.

The operation list documents the operations necessary to manufacture, rework, or teardown the assembled item. The system creates the operation list by copying the routing to production. During the manufacturing process, it may be necessary to add operations, delete operations, or change an operation's work center, queue time, intransit time, production time, or the actual start and end date of the operation.

You can create operation lists for both production IDs and production schedules using PeopleSoft Manufacturing. Operation lists are automatically created for regular production. For rework production, the system creates an operation list using a rework routing if one exists. If you have not created rework routings, you have the option to manually create an operation list. For teardown production, you can base the operation list on a teardown routing or optionally, manually create an operation list.

Related Links

[Understanding Routings](#)

Creating Operation Lists

You can create an operation list for regular production by:

- Accepting planning messages and converting planned orders into firmed or released production IDs or production schedules.
- Changing the production status from Entered to Firmed or Released.

When production has a status of *Firmed* or *Released*, the system copies a routing into its associated operation list. The system uses the master routing option defined for the item to determine which routing to copy. The end item can have either its own routing or can reference another item's routing, the routing of the item assigned to its item group or to its item family.

- Recording a completion for the production quantity.

When you specify a production ID that has a status of *Entered* or *Firmed* during the completions and scrap reporting process, upon request, the system releases the production, and creates the operation list for production with a status of Entered production. Releasing production IDs when recording completions and scrap is dependent on how you've set up the PeopleSoft Manufacturing business unit options. You can only record completions for a production schedule with a status of Firmed or Released. If the production schedule is Entered, you must change the status to Firmed or Released before recording completions.

- Adding a production schedule after you have completed manufacturing an item.

When you add a production schedule quantity at the same time you're recording operation completions and scrap, the system automatically creates the production schedule, releases production, and creates the component and operation lists. After backflushing, components are consumed, operations are recorded as complete, scrap is recorded, and costs are posted for the completed quantity.

- Running the production configuration process for a configured order.

When the production ID is created for the configured item, the operation list is created based on the tasks selected during sales order entry.

PeopleSoft Manufacturing creates an operation list for rework production using a rework routing, if it exists. If you want to create an operation list for reworked items that do not have rework routings, you must manually enter the scheduling information. For teardown production, the system uses a teardown routing for the operation list. Or, manually create the operation list, and manually enter the start date and due date. If you're using PeopleSoft Supply Planning and material and capacity constraints are concerns, you'll want to use the Optimizer to schedule rework and teardown production based on the operation list that you created.

When the system creates the operation list, it copies the routing along with its details to production. Routing details include the operation sequences, count points, attachments, and all the planning and costing times, such as queue time, intransit time, and run rates, associated with each operation. The system displays the item whose routing is copied. When the end item utilizes a master routing, the copied routing can be that of another item, the one assigned to the end item's family or to its item group. If an item references a master routing, it also uses the reference routing item's rework routing if one exists. At the same time, it determines each operation's start and due date based on the start or due date of the production ID or production schedule. If PeopleSoft Supply Planning is not installed, the system also takes into account setup, operation overlap, and the possibility of simultaneous setup and queue. As assemblies are completed at each operation, PeopleSoft Manufacturing tracks the quantity issued to the operation, as well as the quantity completed and scrapped at each operation.

You can modify the operation list using the Update Operation List component. You may add, delete or change operations if end item completions, scrap, or earning of setup costs have not occurred at the operation. You may change existing operations by modifying standard production times, tasks, or work centers.

If you're maintaining production schedules using the PeopleSoft Supply Planning solver, the production of one or more of the operations may have a frozen status. The frozen status indicates that a decision was made to hold or firm up the production ID, production schedule, or operation's due date and that changes within PeopleSoft Manufacturing could result in a change to the schedule created by PeopleSoft Supply Planning. If the production or operation has a frozen status, and you change information that impacts the actual start or due dates and times, PeopleSoft Manufacturing displays a warning message indicating that the operation or production is frozen. You have the option to continue or cancel the changes. If you proceed with changing the operation or production, the operation or production is no longer frozen.

When you modify an operation list and if you're integrating to a third-party Manufacturing Execution System (MES), PeopleSoft Manufacturing uses the Production Order Update EIP to publish a message to the MES with the transaction information. The MES then subscribes to that message and updates the MES information.

Related Links

[Understanding Tasks](#)

[Your Enterprise Data Flow](#)

Considering Subcontracted Operations

If you use outside suppliers to perform an operation, set up and maintain the routing and operation list to take this into consideration. A subcontracted operation can be defined when setting up a task, a work center, an operation on a routing, or when creating or maintaining an operation list.

When you specify that an operation will be performed by a subcontractor, also select a preferred supplier for performing the work. If you do not select a preferred supplier, PeopleSoft Purchasing uses autosourcing to determine the supplier.

If you're creating or maintaining a subcontracted operation, note that:

- Any production with one or more subcontracted operations on the operation list must be tracked using a production ID.
- If you're using count points, all subcontracted operations must be defined as a count point.
- You must copy the routing to production during release.

Select the Copy Routing to Production check box on the Routing header to ensure that the routing is copied to production during the release process.

- You can specify only labor planning and costing operation times.
- You cannot generate multiple outputs such as co-products or by-products at subcontracted operations.

Related Links

[Define Routings - Header: Description Page](#)

Common Elements Used in Operation Lists

<i>Field or Control</i>	<i>Description</i>
Production Area	Area where the item is being manufactured.
Item and Description	Name and description of the item being manufactured.
Config Code (configuration code)	Unique identifier for costing and inventory tracking purposes. The configuration code appears if the end item is a configured item.
Production Status	Current status of the production.

Field or Control	Description
Prdn ID (production ID)	Production order identifier.
Sch Method (scheduling method)	Scheduling method used to manufacture the item. Values are <i>Forward</i> and <i>Backward</i> .
Prdn Type (production type)	Type of production being manufactured. Values are <i>Production</i> , <i>Rework</i> , and <i>Teardown</i> .
Prdn Start Qty (production start quantity)	The quantity required at the beginning of the production process. This quantity will be inflated to account for any operation yield if the system calculates the <i>beginning</i> production quantity.
Prdn End Qty (production end quantity)	The quantity expected at the end of the production process. This quantity will be rounded down to account for any operation yield if the system calculates the <i>ending</i> production quantity.
Source Cd (source code)	Code indicates if the production is <i>Make</i> or <i>Buy</i> .
Routing Code	Routing code associated with the selected production.
Rtg Item (routing item)	Item on which the referenced item's routing is based.
Frozen	Indicates if the production is frozen by PeopleSoft Supply Planning.
Op Seq (operation sequence)	Operation step where the process occurs.
Work Center	Work center location where the operation step and tasks are performed.
Operation Start Date	Date the operation step is or was due to begin.
Start Time	Time the operation step is or was due to begin.
Operation Due Date	Date the operation step is or was due to be completed.
Due Time	Time the operation step is or was due to be completed.
Calculate Yield and Reschedule	If you change the work center, task, operation sequence, or one or more operation type or time, click this link to update the schedule.

Maintaining Operation List Information

PeopleSoft Manufacturing copies the routing, if one exists, for the end item or its reference routing to the production ID or production schedule when the status of the production ID or production schedule changes from *Entered* to *Firmed* or *Released*. In addition, it also copies the routing or its reference routing when an end item or operation completion is recorded for the production quantity.

This section discusses how to:

- Select operation lists.
- Maintain the operation list summary.
- Maintain operation times.
- Maintain operation resources.
- Associate conversion cost codes with an operation.
- Maintain operation scheduling.
- View operation list summary information.

Pages Used to Maintain Operation List Information

Page Name	Definition Name	Navigation	Usage
Production Selection	SF_OP_MAINT_SEL	Production Control > Define Production > Production IDs/ Schedules > Update Operation List > Production Selection	Select a specific production ID or production schedule to add, change, or delete operations when the production status is <i>Firmed</i> or higher.
Summary - Summary	SF_OP_SUMMARY	Production Control > Define Production > Production IDs/ Schedules > Update Operation List > Summary > Summary	Add, change, or delete operations on the operation list.
Summary - Production Text	SF_OP_PRDN_TEXT	Production Control > Define Production > Production IDs/ Schedules > Update Operation List > Summary > Production Text	Display or modify text associated with the production ID or production schedule.

Page Name	Definition Name	Navigation	Usage
Summary - Production Detail	SF_OP_PRDN_HDR	Production Control > Define Production > Production IDs/Schedules > Update Operation List > Summary > Production Detail	Display production ID or production schedule detail.
Details - Times	SF_OP_TIME	Production Control > Define Production > Production IDs/Schedules > Update Operation List > Details > Times	Review or modify an operation's labor or machine planning queue and intransit times as well as planning and costing, setup, run, fixed run, and postproduction times and run rates.
Detail - Operation Text	SF_OP_TEXT	Production Control > Define Production > Production IDs/Schedules > Update Operation List > Details > Operation Text	Add or modify text associated with the production.
Detail - Documents	SF_OP_DC	Production Control > Define Production > Production IDs/Schedules > Update Operation List > Details > Documents	Associate, access, and manage pertinent operation documents in the embedded document management system. You must have PeopleSoft Engineering installed to access this page.
Detail - Attachments	SF_OP_ATT	Production Control > Define Production > Production IDs/Schedules > Update Operation List > Details > Attachments	Associate attachments with an operation. The attachment associations may have been previously defined when creating or maintaining the routing.
Details - Resources	SF_OP_RESOURCE	Production Control > Define Production > Production IDs/Schedules > Update Operation List > Details > Resources	Review or modify the resources assigned to each operation on the operation list.
Details - Conv Cost Codes	SF_OP_CONCOST	Production Control > Define Production > Production IDs/Schedules > Update Operation List > Details > Conv Cost Codes	Add, change, or delete conversion cost codes for an operation.

Page Name	Definition Name	Navigation	Usage
Details - Scheduling	SF_OP_SCHED	Production Control > Define Production > Production IDs/Schedules > Update Operation List > Details > Scheduling	Maintain operation scheduling options. Several scheduling options can be selected for operations, including simultaneous setup and queue, planning intensity, and operation overlap.
Production Selection inquiry	SF_OP_SELECTION	Production Control > Define Production > Review Production Information > Operation List > Production Selection	Select the production ID or production schedule to view an operation list.
Summary - Summary inquiry	SF_OP_LIST	Production Control > Define Production > Review Production Information > Operation List > Summary > Summary	View operation list information for selected production.
Summary - Production Text Inquiry	SF_OP_LIST_PRTXT	Production Control > Define Production > Review Production Information > Operation List > Summary > Production Text	Display text associated with the production ID or production schedule.
Detail - Operation Text inquiry	SF_OP_LIST_TEXT	Production Control > Define Production > Review Production Information > Operation List > Detail > Operation Text	Display text associated with the operation.
Detail - Documents	SF_OP_LIST_DC	Production Control > Define Production > Review Production Information > Operation List > Detail > Documents	Display operation documents for each operation. You must have PeopleSoft Engineering installed to access this page.

Production Selection Page

Use the Production Selection page (SF_OP_MAINT_SEL) to select a specific production ID or production schedule to add, change, or delete operations when the production status is Firmed or higher.

Navigation:

Production Control > Define Production > Production IDs/Schedules > Update Operation List > Production Selection

<i>Field or Control</i>	<i>Description</i>
Production ID	Select a value if you want to maintain the operation list for a specific production ID.
Production Area and Item	Select values if you want to maintain the operation list for production schedules.
Date Type	Select a date type. Production schedule information can be based on the start date of production or when production is due to be completed.
Prdn Start (production start)	Select this option if you want to view production schedules based on the production start date.
Prdn Due (production due)	Select this option if you want to view production schedules based on the production due date.
Prdn Due Shift (production due shift)	Select a valid production shift. Note: If multiple production schedules exist for the production area, item, date, or shift, then a warning appears followed by a listing of the production schedules from which you can select one production schedule to maintain.
Search	Click this button to retrieve the information associated with the selected production.

Summary - Summary Page

Use the Summary - Summary page (SF_OP_SUMMARY) to add, change, or delete operations on the operation list.

Navigation:

Production Control > Define Production > Production IDs/Schedules > Update Operation List > Summary > Summary

This example illustrates the fields and controls on the Update Operation List- Summary: Summary page. You can find definitions for the fields and controls later on this page.

Production Selection		Summary	Detail					
Summary		Production Text		Setup Print Options				
Business Unit US008		Area FINAL		<input type="checkbox"/> Print at Save				
Prdn ID PRD00229				<input type="checkbox"/> Serial in Prdn				
Status Released		Prdn Type Production		UOM EA				
Item ID MT3020				Prdn Start Qty 100.0000				
Mountain Bike, Womans - Millennium Edition				Prdn End Qty 100.0000				
				Expected Yield % 100.0000				
Component Summary								
Personalize Find View All First 1-6 of 13 Last								
Qty Data Other								
*Component ID	Description	Op Seq	Quantity	Std UOM	*Per	*Yield	Sched Qty	
FR7002	Bike Frame, Aluminium	10	1.0000	EA	ASY	100.0000	100.0000	
FR7005	Front Fork	10	1.0000	EA	ASY	100.0000	100.0000	
FS3000	Bolt	10	1.0000	EA	ASY	100.0000	100.0000	
FS3001	Washer	10	1.0000	EA	ASY	100.0000	100.0000	
FS3002	Nut	10	1.0000	EA	ASY	100.0000	100.0000	
LT5000	Standard Wheel Subassembly	30	1.0000	EA	ASY	100.0000	100.0000	
Maintain PIDs/Schedules		Update Op List		Process Monitor				

Field or Control	Description
Sort Operations by	Select <i>End Date</i> , <i>Op Seq</i> (operation sequence), or <i>Start Date</i> .
Print at Save	Select this check box if you want to print production documents at save time for a particular production ID.
Setup Print Options	Click this link to access the Process/Output Options page to select different print criteria for the production documents.
Calculate Yield and Reschedule	When inserting, changing, or deleting an operation, use this link to recalculate the operation quantities and start and due dates. You will be given the option of maintaining the existing start or end quantity and recalculating the other.

Details Tab

Field or Control	Description
Op Seq (operation sequence)	<p>Add, change, or delete operations (tasks) on the operation list. You can also change the operation sequence) by renumbering the operations.</p> <p>You cannot delete an operation from the operation list once completions or scrap have been recorded for the operation.</p> <hr/> <p>Note: You cannot delete a subcontracted operation if a purchase order has been created.</p>

Field or Control	Description
	<p>Click the Add button to add a new operation sequence. The operation can be added in any order.</p> <p>The operations are reordered when you click the Save button.</p>
Task Code and Description	<p>Task being performed at the operation step. Select a value if tasks have been predefined in PeopleSoft Manufacturing. Task codes are optional, but they facilitate data entry.</p>
Work Center	<p>If no task code is entered, you must select the work center where the new operation will take place.</p> <hr/> <p>Note: Changing the task code can affect the task times, resources, scheduling options, conversion rates, and the work center.</p> <hr/> <p>Changing either task information or the work center may result in process change variances in production. Production variances occur any time the cost of the operation differs from the cost of the operation used to determine the item's standard cost.</p>

Field or Control	Description
<p>Operation Start Date and Operation Due Date</p>	<p>Changing these values automatically reschedules prior and subsequent operations.</p> <p>To change an operation's start time (if forward scheduled) or due time (if backward scheduled), select the operation to be changed and the appropriate time based on the production ID's scheduling method. If you're changing the operations for a production schedule, change only the due time because all production schedules are backward scheduled. The scheduling method of the production ID or production schedule appears in the Operation Summary header.</p> <hr/> <p>Note: The system uses the production start quantity of an operation to calculate the scheduled quantities in the component list.</p> <p>For multiple output production IDs, the system uses the production end quantity of the last operation to calculate the quantities for the primary products and co-products in the output list. For by-products, the system uses the production end quantity of the last operation.</p> <p>For multiple output production schedules, the system uses the production end quantity of the last operation to calculate the quantities for the primary, co-products, and by-products in the output list.</p> <hr/> <p>Note: Changing the production quantity may require the operation start or due dates to change.</p> <hr/>

Field or Control	Description
<p>Calculate Yield and Reschedule</p>	<p>Click this link to see the impact of a date or time or work center change. This recalculates the operations based on the changes made. Using this button without saving the page allows you to create what-if scenarios for the production ID or production schedule.</p> <p>If you add an operation to the first row of the operation list, the production ID or production schedule start date or time appears by default, even when the production ID is backward scheduled. If the production is backward scheduled, the system automatically recalculates the start date or time once you enter the due date or time.</p> <p>If you change the work center for an operation and the current start date or time or due date or time does not fall within the hours of operation for the work center, the system reschedules the date or time to a valid date or time once you click the Calculate Yield and Reschedule link. Valid dates or times are based on the work center calendar if a calendar code has been associated with it. If not, the valid working days are based on the runtime production calendar. If one is not specified, the system assumes a five-day work week with the valid hours of operation based on the shift code specified for the five day work week.</p> <hr/> <p>Note: If capacity and material availability are concerns, estimate the start and due dates and times when you create or maintain an operation using PeopleSoft Manufacturing, and then optimize the operation's start and due dates and times using PeopleSoft Supply Planning.</p> <hr/> <p>Important! Change operation list dates one at a time. When one of the dates is changed, the remaining date and time fields are unavailable. To change multiple operations, select the first operation to be changed, enter the changes, and then click the Reschedule button. Once the system reschedules all operations, select the next operation to be changed and continue.</p> <hr/>
<p>Save</p>	<p>Click this button before exiting the page to save the results of the recalculation.</p>

Yield By Operation Tab

Field or Control	Description
Yield %	<p>Displays the percent that you expect at this operation sequence. The default value is defined on the routing, which is used on the production ID, but you can change the percentage here. If you change the percentage, the system will adjust the starting and ending quantities at all subsequent operations. In addition, the operation start and due times may change.</p> <hr/> <p>Note: This percentage cannot be changed once any completions or the scrap process has been performed against the production ID.</p> <hr/>
Assy Starts Qty (assembly starts quantity)	<p>Displays the beginning quantity required at the beginning of the operation. This is the ending quantity of the <i>previous</i> operation. This amount will account for any operation yield loss during the production process.</p>
Exptd Cmpl Qty (expected completed quantity)	<p>Displays the quantity that you expect to complete at the end of the operation. This amount will account for any operation yield loss during the production process</p>

Other

Field or Control	Description
Sub (subcontracted)	<p>Select this option if the operation is being sent to an outside supplier. A subcontracted operation can be defined when setting up a task or a work center, or you can specify it here. Keep these in mind when creating or maintaining subcontracted operations:</p> <ul style="list-style-type: none"> • You can select or deselect the subcontracted check box as long as the purchase order for the subcontracted operation hasn't been created. • You cannot change the work center or task from a work center or task that is subcontracted to one that is not, once a purchase order for the subcontracted work has been created. • You cannot change the operation sequence if a purchase order for the subcontracted work has been created. • You can change the operation scheduling if a purchase order for the subcontracted work has been created. <p>However, if the operation scheduling changes affect when the subcontracted work is received back from the supplier, the system sends a purchase order change request to PeopleSoft Purchasing, indicating a change in scheduling for the production ID.</p> <ul style="list-style-type: none"> • If you're using count points, all subcontracted operations must be defined as a count point. <p>In addition, the last operation step must be a count point.</p> <ul style="list-style-type: none"> • You cannot have teardown outputs at subcontracted operations.
Count Point	<p>Select this option if you want to define an operation step as a count point. Count points allow you to record completions at predefined operation steps. Material is consumed and labor and overhead will be earned back to the previous count point.</p>

Field or Control	Description
Frozen	<p>Select this option to freeze this operation. If you've set up the Automatic Freeze Planning option for the business unit, the system automatically flags any operation sequences as frozen if processing has begun and you've recorded any of these transactions for that operation: actual hours, operation completions, operation scrap, setup complete, by-product or co-product completions. The system will not automatically freeze an operation if you've recorded material consumption (issue, kit, or edit components) unless you've also recorded completions for that operation. You have to deselect the Frozen check box if you do not want the In Process or Complete production operation to be frozen.</p> <p>Also, if you select the Frozen check box on the production ID or production schedule, all operations for that order are frozen. You can also manually change this option here.</p>

Manufacturing Execution System (MES) and Operation Lists

When you modify an operation list, if you're integrating with a third-party MES, PeopleSoft Manufacturing uses the Production Order Update EIP to publish a message to the MES with the transaction information. The MES then subscribes to that message and updates the MES information.

Related Links

[PeopleSoft Manufacturing Reports: A to Z](#)

[Understanding Tasks](#)

[Understanding Work Centers](#)

[Recording End Item Completions Using Count Points](#)

Details - Times Page

Use the Details - Times page (SF_OP_TIME) to review or modify an operation's labor or machine planning queue and intransit times as well as planning and costing, setup, run, fixed run, and postproduction times and run rates.

Navigation:

Production Control > Define Production > Production IDs/Schedules > Update Operation List > Details > Times

This example illustrates the fields and controls on the Details - Times page. You can find definitions for the fields and controls later on this page.

Define Task
Resources
Times
Conversion Code
Conversion Qyhd Codes

Business Unit US008

Task Code PAINT Prime and Paint

Schedule Option

Simultaneous Setup and Queue

Operation Times

[Personalize](#) | [Find](#) | [View All](#) | [Print](#) | [First](#) | [1-4 of 4](#) | [Last](#)

*Time / Resource Type	Operation Time	Time Unit	Operation Rate	Rate Unit	Inc. Setup	+	-
Planning Labor Fixed Run	15.00	Minutes			<input type="checkbox"/>	+	-
Planning Machine Fixed Run	1.00	Hours			<input type="checkbox"/>	+	-
Costing Labor Fixed Run	15.00	Minutes			<input type="checkbox"/>	+	-
Costing Machine Fixed Run	1.00	Hours			<input type="checkbox"/>	+	-

Field or Control	Description
<p>Op Seq (operation sequence), Task Code, Work Center, Start Dt/Time (start date and time), and Due Dt/Time (due date and time)</p>	<p>These values appear by default from the Operation Summary page, although you have the option to change them here.</p> <p>If you change the task, the system deletes all task-related information defined for the operation including work center, resources, task times, and scheduling options. The system then adds the new task information to the current operation sequence. If conversion rates are defined at the task level, the system replaces the conversion and conversion overhead rates with the new rates.</p> <p>If completions or scrap for this operation was recorded, the Op Seq (operation sequence), Task Code, and Work Center fields are unavailable.</p> <p>You can change the work center if you have not recorded completions or scrap for this operation sequence. If you change the work center, the system deletes the resources associated with the old work center and adds the new work center resources. If conversion rates are defined at the work center level, the system replaces the rates with the new rates.</p>
<p>Calculate Yield and Reschedule</p>	<p>To change the work center, task, or operation sequence, click this link to update the schedule.</p> <p>To save the results of the recalculation, click the Save button before exiting the page.</p>

Field or Control	Description
Operation Type (operation times or run rates)	<p>These values appear by default from the routing information. These times and rates may have originated from the task, if one is specified, and modified for this particular item. If a task wasn't specified, the times and rates were entered on the routing for the end item. You can modify the planning labor and machine times or rates for fixed run, post production, run, and setup. If a task was specified for the operation, change any of the production times or rates for the task without affecting the master task information.</p> <p>To make changes to the master task, update the operation times and rates using the Task Time page in PeopleSoft Manufacturing.</p> <p>If you're changing the operation costing times and run rates, the change may result in process change variances in production. This occurs when the cost of the operation differs from the cost used to determine the standard cost of the end item. If you're changing the operation from a regular task to a subcontracted one, you cannot select machine times or rates for the operation.</p>
Op Time (operation time) and Op Rate (operation rate)	<p>You can modify these values. Use operation rates for runtimes only:</p> <ul style="list-style-type: none"> If you enter an operation time, you can enter <i>Days</i>, <i>Hours</i>, or <i>Minutes</i> in the Time Unit field. <p>For example, if you entered 5 in the Op Time field and <i>Days</i> in the Time/Rate Unit field, then one unit will be completed every five days for the operation. Setup, fixed run, and post production must be expressed in terms of operation times. Run is defined in terms of operation time or a run rate.</p> <ul style="list-style-type: none"> If you enter an operation rate, you can enter <i>Units/Day</i>, <i>Units/Hour</i>, or <i>Units/Minute</i> in the Rate Unit field. <p>For example, if you entered 3 in the Op Rate field and <i>Units/Day</i> in the Time/Rate Unit field, then three units will be completed every day for the operation. You can only use operation rates to define runtimes.</p>
Inc. Setup (include setup)	<p>Select this option when calculating operation lead times and can only be selected for the <i>Planning Labor Setup</i> and <i>Planning Machine Setup</i> operation types. The check box is not available for selection for all other operation types. The system always includes setup in the lead time calculation for the first operation. If this option is not selected, setup can physically begin prior to any production units arriving at the work center. However, the system calculates the start date and time of the operation to reflect the latest time the setup should begin to meet its due date and time.</p>
Save	<p>Click this button if you want to save the results of the recalculation.</p>

Warning! Queue and intransit planning times as well as setup and post-production planning and costing times are allowed for subcontracted operations. If you're using PeopleSoft Supply Planning, queue and intransit times are ignored.

Field or Control	Description
Costing Considerations	<p>To calculate costs for a particular item, operation, or time type, you must have a corresponding costing rate type defined along with a frozen conversion or conversion overhead rate or cost.</p> <p>For example, if you had a costing labor fixed runtime defined for an item, you should also have defined a labor fixed run rate per hour or per unit within PeopleSoft Cost Management for the conversion code specified on the operation list.</p>
Costing Operation Time Type	<p>Include a corresponding value if you intend to cost the operation using a fixed amount per unit, as opposed to a rate per hour.</p> <p>The costing operation time can represent the amount of time to complete the task and the system uses it to calculate earned hours. However, the system uses the amount per unit in calculating the cost, regardless of the time specified. If you do not specify a costing time, the system will not include the per unit cost even if there's a rate defined for the code assigned to the operation.</p>

Details - Resources Page

Use the Details - Resources page (SF_OP_RESOURCE) to review or modify the resources assigned to each operation on the operation list.

Navigation:

Production Control > Define Production > Production IDs/Schedules > Update Operation List > Details > Resources

This example illustrates the fields and controls on the Details - Resources page. You can find definitions for the fields and controls later on this page.

Production Selection
Summary
Details

[Times](#)
[Operation Text](#)
[Documents](#)
[Attachments](#)
[Resources](#)
[Conv Cost Codes](#)
[Scheduling](#)

Unit: US008 In Process **Prdn ID:** PRD00231 **Prdn Start Qty:** 200.0000 EA
Area: FINAL **Prdn Type:** Production **Prdn End Qty:** 200.0000 EA
Item ID: MT3020 **Source Cd:** Make **Expected Yield %:** 100.0000
 Mountain Bike, Womans - Millennium Edition Frozen **Sch Method:** Forward
Rtg Itm: MT3020 **Routing Code:** 1 [Calculate Yield and Reschedule](#)

Operation Detail
Find | View All | First 1 of 4 Last

***Op Seq:** + -
Task Code: [Add Fork](#) **Start Dt/Time:**
***Work Center:** [Final Assy](#) **Due Dt/Time:**

Crew Size: **Machine Resources:**

Resources
Customize | Find | View All | First 1-2 of 2 Last

Resource	Crew/Machine/Tool	Description	Status	Qty Used		
Crew	<input type="text" value="ASSY01"/> Add	Assembly Crew 1	Available		+	-
Machine	<input type="text" value="FINAL01"/> Add	Final Assembly Equipment 1	Available		+	-

When maintaining the operation list, you can optionally define the crews, machines, and tools that will be used at work centers to perform specific tasks. In addition, keep these in mind when maintaining operation resources:

- You cannot associate resources with a *Pending* status to an operation.
- You can have no more than one primary crew, one primary machine, and one primary tool associated with each operation.
- You cannot assign crews or machines to a subcontracted operation.

Field or Control	Description
Op Seq (operation sequence), Task Code , Work Center , Start Dt/Time (start date and time), and Due Dt/Time (due date and time)	These values appear by default from the Operation Summary page, although you have the option to change them. If you change the task, the system deletes all task-related information defined for the operation including work center, resources, task times, and scheduling options. The system then adds the new task information to the current operation sequence. If conversion rates are defined at the task level, the system replaces the conversion and conversion overhead rates with the new rates.
Calculate Yield and Reschedule	If you change the work center, task, or operation sequence, click this link to update the schedule. To save the results of the recalculation, click the Save button before exiting the page.

Crew Size, Machine Resources, and Resource Types

You can change the costing resource attributes (crew size and machine resources). These attributes appear by default from the work center. Crew size is the number of people at the work center. The Machine Resources field displays the number of machines at the work center. The system uses both the crew size and machine resources to determine the standard cost of an item. Therefore, if you're changing the operation's crew size or machine resources, the change may result in process change variances for the production ID.

For each operation, the resource information appears by default from the resources associated with the work center that you assigned to the task, and therefore the operation. Only the primary crew, machine, and tools are copied to the operation list. You can enter additional resources (crews, machines, and tools) by selecting a resource type and the specific crew, machine, or tool. The resource's description, status, and, when the resource is a tool, quantity used appears. The resource must already be defined as a primary or alternate resource for the work center. You can also assign resources without assigning a task to the operation.

Details - Conv Cost Codes Page

Use the Details - Conv Cost Codes page (SF_OP_CONCOST) to add, change, or delete conversion cost codes for an operation.

Navigation:

Production Control > Define Production > Production IDs/Schedules > Update Operation List > Details > Conv Cost Codes

This example illustrates the fields and controls on the Details - Conv Cost Codes page. You can find definitions for the fields and controls later on this page.

*Op Seq	Task Code	*Work Center	Conversion Code	Description
10	FORK	FI-ASSY	4402	Assembler
			6501	Assembly
			6505	Administration
			6506	Support

Conversion cost codes determine the labor, machine, outside processing, and overhead cost of the operation. When defining the costs, you associate a conversion rate or cost to each conversion code. The code is then entered on the task or work center, depending on the manufacturing installation options. The system then associates the corresponding rates with the operation when it copies the task or work center to the routing or operation list.

Field or Control	Description
Conversion Code	Displays the associated values with the operation's work center if you're maintaining conversion rates at the work center level.
Conversion Ovhd Codes (conversion overhead codes)	<p>To view the actual labor, machine, outside processing, and overhead rates or costs assigned to the code, see the Conversion Code and Conversion Overhead Code pages for the task or work center.</p> <p>To change the labor, machine, or overhead cost for a specific operation, select a new conversion code to determine the new labor and machine costs. You can also select up to four codes that calculate the overhead costs associated with the operation.</p> <hr/> <p>Note: If you change the conversion code or the conversion overhead codes, and the rates associated with the new codes differ from the old ones, the change results in cost variances for the production ID or production schedule quantity.</p> <hr/>

Details - Scheduling Page

Use the Details - Scheduling page (SF_OP_SCHED) to maintain operation scheduling options.

Several scheduling options can be selected for operations, including simultaneous setup and queue, planning intensity, and operation overlap.

Navigation:

Production Control > Define Production > Production IDs/Schedules > Update Operation List > Details > Scheduling

This example illustrates the fields and controls on the Details - Scheduling page. You can find definitions for the fields and controls later on this page.

Production Selection
Summary
Details

[Times](#)
[Operation Text](#)
[Documents](#)
[Attachments](#)
[Resources](#)
[Conv Cost Codes](#)
[Scheduling](#)

Unit:	US008	In Process	Prdn ID:	PRD00231	Prdn Start Qty:	200.0000 EA
Area:	FINAL		Prdn Type:	Production	Prdn End Qty:	200.0000 EA
Item ID:	MT3020		Source Cd:	Make	Expected Yield %:	100.0000
	Mountain Bike, Womans - Millennium Edition		<input type="checkbox"/> Frozen	Sch Method:	Forward	
Rtg Itm:	MT3020		Routing Code:	1	Calculate Yield and Reschedule	

Operation Detail
Find | View All First 1 of 4 Last

*Op Seq:	<input type="text" value="10"/>					
Task Code:	<input type="text" value="FORK"/>	Add Fork	Start Dt/Time:	<input type="text" value="04/24/2006"/>	<input type="text" value="7:00AM"/>	
*Work Center:	<input type="text" value="FI-ASSY"/>	Final Assy	Due Dt/Time:	<input type="text" value="04/25/2006"/>	<input type="text" value="9:00AM"/>	

Intensity: Count Point

Operation Overlap

Op Overlap:

Subcontracting

Subcontracted

Vendor ID:

Subcontracted Item: Std UOM:

Field or Control	Description
Op Seq (operation sequence), Task Code, and Work Center	These fields are unavailable if completions or scrap for this operation have been previously recorded.
Simultaneous Setup and Queue	<p>Select this option if setup can occur during the queue time of an operation. If you select this option, the system considers the longer of the two times when determining actual production start or due dates.</p> <hr/> <p>Note: The Simultaneous Setup and Queue check box is not available if the page is displaying the first operation in a routing, if setup is not included for the operation, or if you're using PeopleSoft Supply Planning.</p>
Count Point	<p>This option is selected if the operation sequence is a count point. This field is display-only and appears by default from the Summary page. Count points enable you to record completions at predefined operation steps. Material will be consumed and labor and overhead will be earned back to the previous count point. Count points are optional, and are used only on production IDs.</p>

Field or Control	Description
Frozen Operation	<p>Displays if the operation has been frozen by PeopleSoft Supply Planning. This check box indicates that a decision was made to hold or firm up the due date and that changes to the operation could result in a change to the operation's start and due dates and times. If the operation is frozen, and you change information that impacts the start/due dates and times, PeopleSoft Manufacturing displays a warning message indicating that the operation is frozen. You have the option to continue or cancel the changes. If you proceed with changing this information, the operation is no longer frozen.</p>
Intensity	<p>This value appears by default from the task and determines the basis of the scheduling. The start and due date of the operation can be based on either the operation's labor time (labor intensive) or machine time (machine intensive). Alternatively, the start and due date can be based on the longest (longest of the two times, evaluated for each time type within the operation). For example, if labor setup is 7 minutes, machine setup is 10 minutes, labor run is 20 minutes, machine run is 25 minutes, labor fixed run is 11 minutes, and machine fixed run is 7 minutes, the total operation time would be Machine Setup (10) + Machine Run (25) + Labor Fixed Run (11) = 36 minutes. Or, the start and due date can be based on the cumulative (the sum of the machine and labor time).</p> <p>Make sure that you select an intensity that matches the resource used. For example, if you select Machine Time, you must be using machines to perform all or part of the operation and machine times or rates should have been specified for setup, run, fixed run, or all three.</p>

Field or Control	Description
<p>Op Overlap (operation overlap)</p>	<p>Values include:</p> <ul style="list-style-type: none"> • <i>No Overlap</i>: No operation overlap. • <i>Percentage</i>: If you select this option, the Overlap % (overlap percentage) field appears. <p>This is the percentage of processing time remaining at one operation before the next operation can start. An overlap percentage of 100 percent means that the next operation can start at the same time as the current operation. An overlap percentage of 5 percent means that 95 percent of the operation must be completed before the next can start. Operation overlap cannot be less than 0 or more than 100 percent, and there can be no overlap on the last routing operation sequence or prior to a subcontracted operation. However, the supplier can send the end item back in multiple shipments. Therefore, you can define operation overlap for a subcontracted operation.</p> <ul style="list-style-type: none"> • <i>Send Ahead</i>: An overlap by a specific quantity completed at the operation. <p>If you select this option, the Send Ahead field appears. In this case, enter the number of units that need to be accumulated or finished before they can be sent to the next operation and the next operation can begin. The send ahead quantity must be a positive number. Whether you can enter a whole number or a decimal may depend on the item's unit of measure and quantity precision combination that was defined in PeopleSoft Inventory. For example, if Item ID <i>A0007</i> has a unit of measure of <i>EA</i> and a Natural Round, Whole number combination, then you can enter only whole numbers. If you enter an incorrect number format, you'll receive an error message.</p> <p>The default setting for Op Overlap is <i>No Overlap</i>. If you select No Overlap, the Send Ahead and Overlap % fields are not available.</p> <hr/> <p>Important! If an operation has a fixed run rate assigned to it, the preceding operation cannot have a send ahead quantity assigned to it because fixed run operations assume the entire quantity is available at the beginning of the run. For example, operation 1 cannot have a send ahead quantity assigned if operation 2 has a fixed runtime.</p>
<p>Subcontracted</p>	<p>This option is selected if the operation is being performed by a supplier. You cannot deselect this check box if purchase orders have been created for this outside supplier.</p>
<p>Supplier ID</p>	<p>If the subcontracted supplier was defined at the task level, then the name of the supplier appears in this field. Otherwise, you can select the appropriate supplier for this subcontracted operation.</p>

Field or Control	Description
Subcontracted Item	<p>If this value was defined at the routing level, then the item appears in this field. You can change the value in this field.</p> <hr/> <p>Note: The subcontracted item will be used on any subcontracted purchase orders that are created for this operation.</p> <hr/> <p>Note: The UOM for the subcontracted item and the end item must be identical.</p> <hr/>

Summary - Summary inquiry Page

Use the Summary - Summary inquiry page (SF_OP_LIST) to view operation list information for selected production.

Navigation:

Production Control > Define Production > Review Production Information > Operation List > Summary > Summary

Operation Summary

The system displays the operation list, along with operation details for each operation sequence. Operation details include:

Field or Control	Description
Quantity Issued to Operation	Displays the quantity completed at the prior operation. In the case of the first operation, it is the production quantity completed and scrapped at the first operation.
Quantity Completed and Thru Oper (quantity completed and through operation)	Displays the quantity completed at the operation. This quantity does not include any scrapped assemblies.
Qty Scrapped (quantity scrapped)	Displays the total number of assemblies scrapped at the operation.
Scr Pct (scrap percentage)	Displays a weighted average of the scrap percent complete specified when recording end item completions and scrap. This percentage represents the amount of runtime earned and scrapped for the particular operation.

Releasing Production and Changing Production Statuses

Understanding Releasing Production and Changing Production Statuses

Releasing production to the shop floor is the first step in the production process. You can release production for production IDs when maintaining production, or you can release production independently of the maintenance process. You can also release production when you record an operation or end item completion. Following the production release process, you can also generate production documents for production IDs and dispatch lists for production IDs and production schedules.

When you change the production status to *Released*, production is sent to the shop floor and is available to start manufacturing the item. When you change an order's status, there may be significant consequences.

If you change the status to *Released* and you integrate with a third-party manufacturing execution system (MES), PeopleSoft Manufacturing uses the Production Order Update enterprise integration point (EIP) to publish a message to the MES with the transaction information. The MES then subscribes to that message and updates the MES information.

This section discusses:

- Review of the Material Readiness report.
- Release of production.
- Reversal of production statuses.

Review of the Material Readiness Report

Before releasing production IDs and production schedules to the shop floor, it is recommended that you run the Material Readiness report to determine which production orders have all of the material available and which production orders have material shortages.

Related Links

[Running the Material Readiness Report](#)

Release of Production

Before you can generate a picking plan and begin production, you must first release production for any production IDs or production schedules in the *Entered* or *Firmed* status. To accomplish this, you need to change the status for production IDs or production schedules from *Entered* or *Firmed* to *Released*.

Note: You must create rework or teardown production IDs with a status of *Released* unless the production is scheduled for the future. In that case, you can create *Firmed* rework or teardown production IDs. PeopleSoft Manufacturing doesn't support rework or teardown production schedules.

You have several options when releasing production to the shop floor:

- Releasing a production ID during production ID maintenance.

When manually adding a production ID, you have the option of setting the status to *Released*. You can also change the status of an existing production ID from *Entered* or *Firmed* to *Released*.

- Releasing individual production IDs independently of the production ID maintenance process.

Use this method when you want to separate the release function from the maintenance function. Using this method gives control to the individuals who determine when production should be released. If you intend to create picking plans and kit, pick, or pull components to the shop floor, you must release production before generating pick plans.

To release production IDs independently of the production ID maintenance process, use the Production ID Status Change page.

- Releasing individual production schedules before the start of production.

Use this method when you want to release production schedules. If you intend to create picking plans and pick or pull components to the shop floor, you must release production before generating pick plans.

To release production schedules, use the Production Schedule Status Change page.

- Releasing multiple production IDs or production schedules as a batch.

Use this method when you want to release multiple IDs or production schedules simultaneously. You can release a range of production IDs or production schedules, or you can release a range of items or production areas.

To release multiple production IDs or production schedules, use the Production Status Change Process page.

- Releasing production by recording an operation or an end item completion.

Use this method when you're utilizing a streamlined production operation. If you are using production IDs, you can record completions at an operation or at end item completion. If you are using production schedules, you can backflush only at end item completion. When you perform a completion or backflush, the production ID or production schedule is automatically released. This method assumes that you are automatically replenishing components in the work-in-progress (WIP) locations and are not generating pick reports.

To release production while recording an operation or an end item completion, use the Record Completions and Scrap page. The ability to release production when recording completions or scrap is dependent on how you've configured the environment when setting up the PeopleSoft Manufacturing business unit options.

Related Links

[Understanding Component Lists](#)

Understanding Operation Lists

Reversal of Production Statuses

Besides releasing production, you can also use the Production ID Status Change page and the Production Schedule Status Change page to change an order's status from *Entered*, *Firmed*, *Released*, or *In Process* to a prior status. This applies to production, rework, and teardown orders.

To change an order from *In Process* to a prior status, you need to reverse all end item completions and scrap, return components to stock, and reverse all actual hour recordings. These include:

- Component issues
- Component yield loss
- Pending issues
- Pending loss quantities
- Operation completions
- Co-product and by-product completions
- End item completions
- End item scrap
- Outstanding bar code transactions
- Earned costs
- Scrap costs
- Actual hours

Common Elements Used in Production

<i>Field or Control</i>	<i>Description</i>
Production ID	The production order identifier.
Production Status	Current status of the production.
Production Area	Area where the end item is generated.
Item	The end item being manufactured.
Production Type	Type of production being manufactured. Values are <i>Production</i> , <i>Rework</i> , and <i>Teardown</i> .

Field or Control	Description
Prdn Start Date/Shift (production start date/shift)	Actual production start date and shift that production is or was to begin for the production schedule.
Prdn Due Date/Shift (production due date/shift)	Actual production due date and time that production is or was to be completed for the production schedule.
Start Date/Time and Due Date/Time	Actual production start date and time and due date and time for the production ID.
Production Qty (production quantity)	Quantity of end item to be manufactured.
BOM and Routing codes	Codes that designate the BOM and routing used to manufacture the end item.
Rtg Itm (routing item)	The routing that the end item uses. The end item can use its own routing or the routing designated for its family or item group.
Config Code (configuration code)	Code that is displayed if the end item is configured. This code is used with production IDs only.
Revision	If the item is revision controlled, the code that determines which BOM is used when producing the item.

Running the Material Readiness Report

Before releasing production IDs and production schedules to the shop floor, you will want to determine which production orders have all of the material available and which production orders have material shortages. Production orders with all material available can be released to the shop floor. Production orders with shortages need to be investigated to determine when production can be released to the shop floor. Run the Material Readiness report to determine if the production ID or production schedule is ready to release and to view the quantities and readiness status of the components.

The Material Readiness report includes two to three sections:

1. *Report Criteria section:* This section details the options you have selected on the run control pages for the Material Readiness report.
2. *Production Detail section:* This section displays production readiness by production ID or production schedule. You produce this section by selecting the Production Report check box on the Material Readiness Report run control page.
3. *Component Summary section:* This section displays time-phased demand and supply quantities by component item ID and determines if there is enough available quantity to meet the demand. You

produce this section by selecting the Summarized Component Report check box on the Material Readiness Report run control page.

This example illustrates the fields and controls on the Example of the Report Criteria section of the Material Readiness report. You can find definitions for the fields and controls later on this page.

ORACLE		Enterprise Production Control		Material Readiness Report		Report Date
US008 COLORADO BIKE MFG/OUTDOOR						7/6/09 3:52 PM
Page 1 of 4						
Report Criteria						
Report Instance ID	9396					
Account for Order Time	No					
Production Report	Yes					
Readiness State	Ready, Unready					
Component Detail	Yes					
Unready Components Only	No					
Component Sort	Op Sequence, Component					
Sort Order	Readiness	Ascending	Break: No			
Summarized Components Report	Yes					
Report Demand	Yes					
Report Supply	Yes					
Report Pegs	Yes					
Sort Order	Component ID	Ascending	Break: No			
Production IDs Selected	Yes					
Production ID	PRD00232	-	PRD00233			
Schedules Selected	No					
Through Date	7/26/09					
Production Status	Firmed, Released					
Demand Options	Yes					
Include Demand	Yes					
Date Range	6/21/09	-	7/26/09			
Priority Order	Sales Order, Stock Request, Transfer, Production					
Supply Options	Yes					
Include Supply	Yes					
Date Range	6/26/09	-	7/26/09			
Approved Requisitions	Yes					
Include Null Dates	Yes					
Include WIP in QOH	Yes					
Entered Production	No					
Co-Products/By-Products	Yes					

The report criteria section displays your selection criteria entered on the run control for the Material Readiness Report (Production Control, Process Production, Release Production, Material Readiness Report).

This example illustrates the fields and controls on the Example of the Production Detail section of the Material Readiness report. You can find definitions for the fields and controls later on this page.

ORACLE Enterprise Production Control		Material Readiness Report Production Detail				Report Date 7/6/09 3:52 PM		Page 2 of 4	
Production ID PRD00233 Item ID SR2100 Description Brake Subassembly Start Qty 10.0000 Start Date 7/15/09 7:00 AM BOM Code 1 Ready No				Production Area FINAL Status Released Configuration Code End Qty 10.0000 End Date 7/15/09 9:40 AM Routing Code 1					
Ready	Component ID/ Description /Configuration	Source Code/ UOM	Op/ QTY Code	Date/Time	Short QTY	Open Demand QTY	Available Supply QTY	Total Available/ Reserved QTY	Total Demand/ Incoming Supply QTY
No	BR4400 Yoke, Brake Subassembly	Buy EA	10 Asy	7/15/09 7:00 AM	5.0000	10.0000	5.0000	35.0000 0.0000	75.0000 75.0000
	BR4401 Tension Adjustment Screw	Buy EA	10 Asy	7/15/09 7:00 AM	0.0000	10.0000	1452.0000	1462.0000 0.0000	20.0000 0.0000
	BR4402 Brake Cable	Buy EA	10 Asy	7/15/09 7:00 AM	0.0000	10.0000	1695.0000	1695.0000 0.0000	20.0000 0.0000
Production ID PRD00232 Item ID SR2100 Description Brake Subassembly Start Qty 10.0000 Start Date 7/13/09 7:00 AM BOM Code 1 Ready Yes				Production Area FINAL Status Released Configuration Code End Qty 10.0000 End Date 7/13/09 9:40 AM Routing Code 1					
Ready	Component ID/ Description /Configuration	Source Code/ UOM	Op/ QTY Code	Date/Time	Short QTY	Open Demand QTY	Available Supply QTY	Total Available/ Reserved QTY	Total Demand/ Incoming Supply QTY
	BR4400 Yoke, Brake Subassembly	Buy EA	10 Asy	7/13/09 7:00 AM	0.0000	10.0000	30.0000	35.0000 0.0000	75.0000 75.0000
	BR4401 Tension Adjustment Screw	Buy EA	10 Asy	7/13/09 7:00 AM	0.0000	10.0000	1462.0000	1462.0000 0.0000	20.0000 0.0000
	BR4402 Brake Cable	Buy EA	10 Asy	7/13/09 7:00 AM	0.0000	10.0000	1695.0000	1695.0000 0.0000	20.0000 0.0000

The production detail section of the Material Readiness report displays production readiness by production ID or production schedule. The quantities displayed on this report are calculated based on your selection criteria on the run control for the Material Readiness Report (Production Control, Process Production, Release Production, Material Readiness Report).

For each component in the production order, the following fields are displayed:

Field or Control	Description
Ready	Displays <i>No</i> when there is not enough quantity of a component to complete this production order on the date and time needed. For example, in the previous page shot, the item ID BR4400 in production ID PRD00233 is not ready because there is not enough supply on the date that the production ID needs the quantity.
Component ID / Description / Configuration	Displays the item ID and description of the component used in this production order. For configured items, the configuration code is displayed.
Source Code/UOM	Displays the source code of the component (such as <i>Make</i> or <i>Buy</i>) and the standard unit of measure of the component. All of the component's quantity fields on this report are expressed in this unit of measure.

Field or Control	Description
Op/QTY Code	<p>The Op Code field displays the operation sequence where this component is consumed within the production order.</p> <p>The QTY Code field displays the component requirements in amounts per <i>Asy</i> (assembly) or per <i>Ord</i> (order).</p>
Date/Time	Displays the date and time that this component is needed for production based on the start date of the operation sequence using the component.
Short QTY	Displays the shortage of the component that is not available for this production order on the date and time needed. The shortage quantity is calculated using the following columns in the same row: Open Demand QTY field less Available Supply QTY field. If the Available Supply QTY field is greater than the Open Demand QTY field then enough stock is available and the Short QTY field is blank or zero.
Open Demand QTY	Displays the quantity of this component needed for this operation sequence of this production order. The open demand quantity is calculated as follows: (current scheduled quantity) less (the quantity already issued). The (current scheduled quantity) is the number of components required for the operation sequence or batch production and includes the yield percentage.

Field or Control	Description
<p>Available Supply QTY</p>	<p>Displays the component quantity that this report estimates will be available in this business unit on the date and time of this row. This available supply quantity is calculated as follows:</p> <ul style="list-style-type: none"> • Component quantity that is currently available in this business unit. The details of this quantity are described on the BU Available Qty field of the component summary section. • Plus the component quantity in the WIP locations of this business unit if you have selected the Incl WIP in Starting Qty check box on the Material Readiness Report-Supply/Demand page. • Less the quantity that is estimated to be consumed by other demands before the current production order is scheduled to use the component. Based your selection criteria on the run control for the Material Readiness Report, the types of demand can include; other production orders, sales orders, work orders, material stock requests, interunit transfers, planned transfers, or planned production. The demand quantity for this current production order is not subtracted from this Available Supply QTY field. • Plus supply quantity for this component that is estimated to arrive in the business unit before this current production order needs the stock. Based your selection criteria on the run control for the Material Readiness Report, the types of supply can include; requisitions, purchase orders, interunit transfers coming into the business unit, received quantities that are in the Putaway Staging tables, other production orders, planned purchase orders, planned transfers, and planned production orders. <p>The Available Supply QTY field does not include pegged supply or pegged demand. A pegged quantity is not considered available quantity because it is already committed to a specific demand or supply.</p>
<p>Total Available/Reserved QTY</p>	<p>The Total Available QTY field displays the total available quantity that is currently in this business unit. This field includes:</p> <ul style="list-style-type: none"> • Component quantity that is currently available in this business unit. The details of this quantity are described on the BU Available Qty field of the component summary section. • Plus the component quantity in the WIP locations of this business unit if you have selected the Incl WIP in Starting Qty check box on the Material Readiness Report-Supply/Demand page. <p>The Reserved Qty field displays the component quantity that is soft-reserved within this business unit.</p>

Field or Control	Description
Total Demand/Incoming Supply QTY	<p>The Total Demand QTY field displays the sum of all open demand for this component in the date range specified. This field includes pegged quantities. Based on your selection criteria on the Material Readiness Report-Supply/Demand page, demand can include production orders (ready, unready, or both), sales orders, work orders, material stock requests, interunit transfers, planned transfers, and planned production. The date range is specified in the Past Due Demand Days and Future Demand Days fields. The current production order is included in this total.</p> <p>The Incoming Supply QTY field includes stock of this component that is going to be delivered to this business unit in the date range specified. The component's available quantity within a business unit will be increased when incoming supply is received into the business unit. This field includes pegged quantities. Based on your selection criteria on the Material Readiness Report-Supply/Demand page, the incoming supply can include stock from requisitions, purchase orders (order quantity less the quantity that has already been received), interunit transfers coming into the business unit, received quantities that are in the Putaway Staging tables, production orders (scheduled quantity less the already completed quantity), planned purchase orders, planned transfers, and planned production orders. The date range is specified in the Past Due Supply Days and Future Supply Days fields.</p>

This example illustrates the fields and controls on the Example of the Component Summary section of the Material Readiness report. You can find definitions for the fields and controls later on this page.



Enterprise Control

US008 COLORADO BIKE MFG/OUTDOOR

Material Readiness Report

Component Summary

Report Date 7/6/09 3:52 PM

Page 3 of 4

Item ID	BR4400	Description	Yoke, Brake Subassembly		Peg Qty	20.0000
Source Code	Buy	Open Demand Qty	75.0000		Incoming Supply	75.0000
Unit of Measure	EA	Available Qty	35.0000		BU Available Qty	30.0000
Buyer Code	VP1 Kenneth Schumacher	Primary Vendor Name	BIKE-001		WIP Qty	5.0000
Planner Code	LK Kabratsi,Lou	Shortage	Yes			

Time-Phased Demand and Supply								
Short	Order Type	Order No	Date	Order/ Adjust QTY	Available QTY	Ship Customer/ Vendor Name	Peg Type	Peg Order/ Customer
	Purchase Order	US001/0000000205/1	Staged	+ 5.0000 0.0000	40.0000	ERNIE'S-001		
	Purchase Order	US001/0000000205/1	7/3/09 12:00 AM	+ 10.0000 0.0000	50.0000	ERNIE'S-001		
	Stock Request	US008/MSR0000070/1/1	7/3/09 1:30 PM	- 20.0000 0.0000	30.0000	USA - Colorado		
	Production Demand	US008/PRD00232/10	7/13/09 7:00 AM	- 10.0000 0.0000	20.0000			
	Stock Request	US008/MSR0000071/1/1	7/15/09 3:00 PM	- 15.0000 0.0000	5.0000	USA - Colorado		
Yes	Production Demand	US008/PRD00233/10	7/15/09 7:00 AM	- 10.0000 0.0000	-5.0000			
	Purchase Order	US001/0000000206/1	7/16/09 12:00 AM	+ 60.0000 20.0000	35.0000	ERNIE'S-001	Stock Request	US008/MSR0000072/1 USA - Colorado
	Stock Request	US008/MSR0000072/1/1	7/20/09 2:01 PM	- 20.0000 20.0000	35.0000	USA - Colorado	Purchase Order	US001/0000000206/1

Item ID	BR4401	Description	Tension Adjustment Screw		Peg Qty	0.0000
Source Code	Buy	Open Demand Qty	20.0000		Incoming Supply	0.0000
Unit of Measure	EA	Available Qty	1462.0000		BU Available Qty	1462.0000
Buyer Code	VP1 Kenneth Schumacher	Primary Vendor Name	BIKE-001		WIP Qty	0.0000
Planner Code	LK Kabratsi,Lou	Shortage				

Time-Phased Demand and Supply								
Short	Order Type	Order No	Date	Order/ Adjust QTY	Available QTY	Ship Customer/ Vendor Name	Peg Type	Peg Order/ Customer
	Production Demand	US008/PRD00232/10	7/13/09 7:00 AM	- 10.0000 0.0000	1452.0000			
	Production Demand	US008/PRD00233/10	7/15/09 7:00 AM	- 10.0000 0.0000	1442.0000			

The component summary section of the Material Readiness report displays demand and supply by component item ID and determines if there is enough available quantity to meet the demand. The quantities displayed on this report are calculated based on your selection criteria on the run control for the Material Readiness Report (Production Control, Process Production, Release Production, Material Readiness Report).

For each component the following fields are displayed:

Field or Control	Description
Unit of Measure (in component heading)	Displays the standard unit of measure used for this component in all quantity fields.
Open Demand Quantity (in component heading)	<p>Displays the sum of all open demand for this component in the date range specified. This field includes pegged quantities. Based on your selection criteria on the Material Readiness Report-Supply/Demand page, demand can include production orders (ready, unready, or both), sales orders, work orders, material stock requests, interunit transfers, planned transfers, and planned production. The date range is specified in the Past Due Demand Days and Future Demand Days fields.</p> <p>The details for the open demand quantity are displayed in the rows under the component heading. For example, in the page shot above the open demand quantity of 75 EA for item ID BR4400 is a total of the negative quantities in the Order/Adjust QTY column, including the stock requests and production IDs (20 + 10 + 15 + 10 + 20).</p>
Available Qty (in component heading)	Displays the total component quantity that is currently available in this business unit. This field includes the BU Available Qty field (in the component heading of this page), plus the quantity in the WIP locations of this business unit if you have selected the Incl WIP in Starting Qty check box on the Material Readiness Report-Supply/Demand page.
Shortage (in component heading)	Displays <i>Yes</i> when there is not enough supply to meet the demands for this component.
Peg Qty (in component heading)	Displays the amount of incoming supply that is pegged to a demand. This field displays zero if you have not selected the Report Peg Information check box on the Material Readiness Report run control page. Due to the additional amount of data, selecting the Report Peg Information check box may slow the performance of this report.

Field or Control	Description
Incoming Supply (in component heading)	<p>Displays the quantity of component stock that is going to be delivered to this business unit in the date range specified. The component's available quantity within a business unit will be increased when incoming supply is received into the business unit. This field includes pegged quantities. Based on your selection criteria on the Material Readiness Report-Supply/Demand page, the incoming supply can include stock from requisitions, purchase orders (order quantity less the quantity that has already been received), interunit transfers coming into the business unit, received quantities that are in the Putaway Staging tables, production orders (scheduled quantity less the already completed quantity), planned purchase orders, planned transfers, and planned production orders. The date range is specified in the Past Due Supply Days and Future Supply Days fields.</p> <p>The details for the incoming supply quantity are displayed in the rows under the component heading. For example, in the page shot above the incoming supply quantity of 75 EA for item ID BR4400 is a total of the positive quantities in the Order/Adjust QTY column. In this example, incoming supply consists of three purchase orders (5 + 10 + 60).</p>
BU Available Qty (in component heading)	<p>Displays the total component quantity that is currently available in this business unit. Available quantity is calculated as follows:</p> <ul style="list-style-type: none"> • Quantity on hand in the business unit. • Less stock with an inventory status of Rejected. • Less reserved or allocated stock. • Less stock with an inventory status of Restricted or Hold. This stock is subtracted unless you have selected the Incl Non Open in Avail check box on the Inventory Definition - Business Unit Options page (Inventory business unit). <p>The quantities in WIP locations are reserved; therefore, not included in this quantity.</p>
WIP Qty (in component heading)	<p>Displays the component quantity within the WIP locations of this business unit.</p>
Time-Phased Demand and Supply (group box)	<p>Provides the details to the Open Demand Qty field and the Incoming Supply field in the component header and highlights any time period where a shortage will occur. This grid displays the changes to the available quantity of the component within the date range specified on the Material Readiness Report-Supply/Demand page. Rows display an increase in available quantity due to incoming supply and a decrease due to demand.</p>
Short	<p>Displays <i>Yes</i> on the date/time row where a shortage of component quantity will occur.</p>

Field or Control	Description
Order Type	Displays the type of demand or supply on the current row. The types of demand can include production orders, sales orders, work orders, material stock requests, interunit transfers, planned transfers, and planned production. The types of incoming supply can include requisitions, purchase orders, interunit transfers coming into the business unit, received quantities that are in the Putaway Staging tables, production orders, planned purchase orders, planned transfers, and planned production orders.
Order No	Displays the source or destination business unit, order number, and line number of the demand or supply. For demand-type production IDs, the business unit, production ID, and operation sequence are displayed. For demand-type production schedules, the business unit, production area, and operation sequence are displayed.
Date	<p>Displays the date and time when the component quantity is needed for this demand or when the incoming supply is scheduled to be received in the business unit. The word <i>Staged</i> is displayed if the incoming supply is currently in the Putaway Staging tables.</p> <p>For example, in the previous page shot, row 1 shows a purchase order that has been received but not yet putaway. In addition, rows 2 and 3 show past due supply and demand because the report date is 7/6, the purchase order was due 7/3, and the stock request was due to ship on 7/3. Also, notice that rows 5 and 6 both show demand that is needed on 7/15 but based on priorities, the stock request gets the quantity before the production ID even though the production ID has an earlier date/time.</p>
Order/Adjust QTY	<p>The Order QTY field displays the open quantity on the order. Incoming supply is shown as a positive quantity and demand is shown as a negative quantity.</p> <p>The Adjust QTY field displays the reserved quantity and the amount of the open quantity that is pegged for this demand or supply row. For supply transactions, the Adjust Qty field is only peg quantity, but for demand transactions, the Adjust QTY field is the sum of pegged quantity and reserved quantity. This field is populated if you have selected the Report Peg Information check box on the Material Readiness Report run control page. Due to the additional amount of data, selecting the Report Peg Information check box may slow the performance of this report.</p>

Field or Control	Description
Available QTY (in the Time-Phased Demand and Supply group box)	<p>Displays the estimated available quantity for this date/time row. The first row is calculated by starting with the Available Qty field in the component heading and then adding or subtracting the Order QTY field in the current row. Incoming supply increases the available quantity while demand decreases the available quantity. Following rows are calculated by taking the amount in the Available QTY field of the previous row, then adding or subtracting the Order QTY field in the current row.</p> <p>For example, in the previous page shot, row 7 displays a purchase order that is pegged to a stock request. The purchase order quantity is for 60 each; 20 of that 60 is pegged to a stock request. The Adjust Qty field represents the 20 that is pegged. The impact to available quantity is a positive 40 (that is, 60 less 20). The Peg Order/Customer column displays the stock request that is pegged to the purchase order. Also, the purchase order quantity does not change the Available QTY field because its pegged.</p> <p>In addition, in the previous page shot, row 8 displays a stock request that is pegged to a purchase order. The Adjust Qty represents the pegged quantity. Again, the stock request quantity does not change the Available QTY field because its pegged.</p>
Ship Customer/Supplier Name	<p>The customer name is displayed for sales orders, material stock requests, and demand-side production IDs with a configured item or pegged quantity.</p> <p>The supplier name is displayed for requisitions or purchase orders.</p> <p>For interunit stock requests, the source or destination business unit is displayed.</p>
Peg Type	<p>Displays the type of demand or supply that this row is linked to in a peg chain. For example, if the current row is a purchase order (supply-side), then it can be linked to a material stock request (demand-side).</p> <p>This column is populated if you have selected the Report Peg Information check box on the Material Readiness Report run control page. Due to the additional amount of data, selecting the Report Peg Information check box may slow the performance of this report.</p>

Field or Control	Description
Peg Order/Customer	<p>Displays the business unit, order number, line number, and customer name of the order that this row is linked to in a peg chain. For example, if the current row is a purchase order (supply-side), and it is linked to a material stock request (demand-side); then this row displays the information about the material stock request. The word <i>Multiple</i> is displayed if the current row is pegged to more than one transaction.</p> <p>This column is populated if you have selected the Report Peg Information check box on the Material Readiness Report run control page. Due to the additional amount of data, selecting the Report Peg Information check box may slow the performance of this report.</p>

Formatting the Material Readiness Report with Oracle's BI Publisher

The Material Readiness Report uses the BI Publisher to create the layout of the report. BI Publisher is a template-based reporting solution that separates the data extraction process from the report layout and enables the reuse of extracted application data into multiple report layouts. You can change the format or layout of this report without changing the underlying program that controls the business logic. The format and layout includes the appearance of the report and addition or removal of fields on the report as long as those fields are available as part of the SF_MATRDY application engine process.

The delivered data for the Material Readiness Report in BI Publisher (Reporting Tools, BI Publisher) includes:

- Report Definition: SF_MATRDY
- Data Source ID: SF_MATRDY_DATA
- Template ID: SF_MATRDY_1
- Template File: SF_MATRDY_ENG.RTF

Pages Used to Run the Material Readiness Report

Page Name	Definition Name	Usage
Material Readiness Report Page	RUN_SF_MTLRDY	<p>Enter search criteria and options to run the material readiness report. This report determines the material readiness of a production run by checking the available quantity of component materials.</p> <p>Material Readiness Report- Supply/ Demand Page</p>
Material Readiness Report- Supply/ Demand Page	RUN_SF_MTLRDY_SD	Select the sources of supply and demand used when calculating the material readiness report.

Material Readiness Report Page

Use the Material Readiness Report page (RUN_SF_MTLRDY) to enter search criteria and options to run the material readiness report.

This report determines the material readiness of a production run by checking the available quantity of component materials.

Navigation:

Production Control > Process Production > Release Production > Material Readiness Report

This example illustrates the fields and controls on the Material Readiness Report run control page (1 of 2). You can find definitions for the fields and controls later on this page.

Material Readiness Report
Supply/Demand

Run Control ID d8
Report Manager
Process Monitor
Run

Business Unit
Language Code

Account for Order Time

Production Report Options

<input checked="" type="checkbox"/> Production Report	Sort Option	Order	Break
<input checked="" type="checkbox"/> Report Ready Production	<input type="text" value="Readiness"/>	<input type="text" value="Ascending"/>	<input type="checkbox"/>
<input checked="" type="checkbox"/> Report Unready Production	<input type="text"/>	<input type="text"/>	<input type="checkbox"/>
<input checked="" type="checkbox"/> Report Component Detail	<input type="text"/>	<input type="text"/>	<input type="checkbox"/>
<input type="checkbox"/> Unready Components Only	<input type="text"/>	<input type="text"/>	<input type="checkbox"/>

Component Sort

Summarized Component Options

<input checked="" type="checkbox"/> Summarized Component Report	Sort Option	Order	Break
<input checked="" type="checkbox"/> Report Demand	<input type="text" value="Component ID"/>	<input type="text" value="Ascending"/>	<input type="checkbox"/>
<input type="checkbox"/> Report Supply			
<input type="checkbox"/> Report Peg Information			

This example illustrates the fields and controls on the Material Readiness Report run control page (2 of 2). You can find definitions for the fields and controls later on this page.

Production Selection

Select Production IDs

Prdn Area To **All Areas**

Prdn ID To **All PIDs**

Item ID **All Items**

Select Production Schedules

Prdn Area To **All Areas**

Item ID **All Items**

Production Date Selection

Lead Time From Thru

Lead Days

Select Production Status

Firmed **Released**

The Material Readiness Report run control page includes the selection criteria and options to produce the material readiness report. The material readiness report can include one or both of the following report options:

- Production Detail section
- Component Summary section

Field or Control	Description
Unit	Enter the PeopleSoft Manufacturing business unit of the production run.
Account for Order Time	Select this check box to sort supply and demand by date and time. Deselect this check box to ignore due time when determining readiness. The system assumes that the supply for a date is available for the demand needed that day.

Production Report Options group box

Use this group box to generate the production detail section of the material readiness report and to enter the options for this section. The production detail section displays production readiness by production ID or production schedule.

Field or Control	Description
Production Report	Select this check box to include the production detail section within the material readiness report.

Field or Control	Description
Report Ready Production and Report Unready Production	<p>Select the Report Ready Production check box to display production IDs and production schedules that are ready for production in the report.</p> <p>Select the Report Unready Production check box to display production IDs and production schedules that are not ready for production in the report.</p> <p>Use these check boxes to determine what is displayed on the report output. These options give you the flexibility to tailor the report to search specifically for production that is ready to go or to look for production that is not ready. Select one or both check boxes. By deselecting one of these check boxes you are limiting the report output to just ready production or just unready production.</p>
Sort Option	<p>Specify up to four sort levels for the production report section of the material readiness report. Within each level, you can sort by:</p> <ul style="list-style-type: none"> • <i>Assembly Item</i> • <i>Production</i> (production ID, production schedule, or both) • <i>Production Area</i> • <i>Readiness</i> The READY_FLG field contains the values of <i>Y</i> (yes) or <i>N</i> (no). • <i>Start Date</i> (NEW_START_DTTM) <p>Each lower sort is within the sort specified above it. For example, you might want to sort the production by readiness, then sort by the production ID, and then sort the start date.</p>
Order	<p>Select <i>Ascending</i> or <i>Descending</i> for the corresponding Sort Option field.</p>
Break	<p>Select this check box to create a page break for every value change in the corresponding sort option. For example, if you have selected the sort option of <i>Production</i> and the production ID changes, then a new page is started.</p>

Field or Control	Description
Report Component Detail	Select this check box to display the components associated with production and each component's readiness status. If a specific production ID or production schedule does not have component requirements, (for example, a rework or teardown might not have components) then the production is flagged as <i>Ready</i> .
Unready Components Only	Select this check box to display only the unready components on the report component detail section of the production report. This option enables you to focus on the issues preventing the start of production. This check box is only available if you have selected the Report Component Detail check box above.
Component Sort	Select the sort order for the report component detail section of the production report. The sort options are: <ul style="list-style-type: none"> • <i>Component Sort</i> in ascending order by component ID. • <i>Op Seq</i>: Sort in ascending order by operation sequence. This check box is only available if you have selected the Report Component Detail check box above.

Summarized Component Options group box

Use this group box to generate the component summary section of the material readiness report and to enter the options for this section. The component summary section displays time-phased demand and supply quantities by component item ID. This enables you to view the impact that each demand or supply order has on the available quantity and determine if there is enough available quantity to meet your demand.

Field or Control	Description
Summarized Component Report	Select this check box to include the component summary section within the material readiness report.
Report Demand	Select this check box to display the details of demand for this component. Demand can include production orders, sales orders, work orders, material stock requests, planned transfers, and planned production that need this component.

Field or Control	Description
Report Supply	Select this check box to display the details of supply for this component. Supply can include available stock in the business unit plus incoming supply from purchase orders, completed production, or material stock requests.
Report Peg Information	Select this check box to display additional information about a peg quantity. Additional information includes the customer or supplier associated with a pegged quantity. Note: Due to the additional amount of data, selecting the Report Peg Information check box may slow the performance of this report.
Sort Option	Select how the component summary section should be sorted on the report. The options are: <ul style="list-style-type: none"> • <i>Buyer ID</i> • <i>Component ID</i>
Order	Select <i>Ascending</i> or <i>Descending</i> for the Sort Option field.
Break	Select to create a page break at the sort level chosen in the Sort Option field.

Production Selection group box

Use this group box to enter the search criteria to select the production IDs and production schedules to be evaluated by the material readiness report for component availability.

Field or Control	Description
Select Production IDs	Select this check box to include production IDs in this report.
Select Production Schedules	Select this check box to include production schedules in this report.
Prdn Area and To	Define one production area or a range of production areas to select specific production IDs or production schedules. The page location of these fields determine whether they impact the production ID selection or the production schedule selection.

Field or Control	Description
Prdn ID and To	Enter a specific production ID or a range of production ID to be included on the material readiness report.
Item ID and To	<p>Define one item ID or a range of items to select specific production IDs or production schedules.</p> <p>The page location of these fields determine whether they impact the production ID selection or the production schedule selection.</p>
All Areas	<p>Select this check box to include all production areas within this business unit in your search criteria. When this check box is selected, the Prdn Area field is deselected.</p> <p>The page location of this check box determines whether it impacts the production ID selection or the production schedule selection.</p>
All PIDs	Select this check box to include all production IDs within this business unit in your search criteria. When this check box is selected, the Prdn ID field is deselected. The selected production IDs must also meet the additional selection criteria on this page.
All Items	<p>Select this check box to include all item IDs within this business unit in your search criteria. When this check box is selected, the Item ID field is deselected.</p> <p>The page location of this check box determines whether it impacts the production ID selection or the production schedule selection.</p>

Field or Control	Description
Production Date Selection	Enter date selection criteria for production IDs or production schedules that are due to start within the days selected. The options are: <ul style="list-style-type: none"> • <i>Date:</i> Enter the date range for the production start time in the From and Thru fields. • <i>Lead Time:</i> Enter the number of days before production start time in the Lead Days field. For example, if you enter 3, then the system selects production IDs and production schedules with a start time within the next three days from today. • <i>Today:</i> Select to include production with a start date of today.
Select Production Status	Select the status of the production IDs and production schedules to be included in the material readiness report. Select the Firmed check box, the Released check box or both.

Material Readiness Report- Supply/Demand Page

Use the Material Readiness Report- Supply/Demand page (RUN_SF_MTLRDY_SD) to select the sources of supply and demand used when calculating the material readiness report.

Navigation:

Production Control > Process Production > Release Production > Material Readiness Report > Supply/Demand

This example illustrates the fields and controls on the Material Readiness Report-Supply/Demand page (1 of 2). You can find definitions for the fields and controls later on this page.

This example illustrates the fields and controls on the Material Readiness Report-Supply/Demand page (2 of 2). You can find definitions for the fields and controls later on this page.

The Material Readiness Report- Supply/Demand run control page provides the selection criteria for the type of demand and supply to be included in the calculation of the material readiness report.

Sources of Demand group box

Use this group box to determine what sources of demand are used in the calculation of the material readiness report. The component's available quantity within the business unit is reduced by demand for this same component from other production orders, sales orders, work orders, material stock requests, interunit transfers, planned transfers, and planned production.

Field or Control	Description
Include Demand	<p>Select this check box to include other demands for the component quantity in the material readiness calculation, such as other production orders, sales orders, work orders, material stock requests, interunit transfers, planned transfers, and planned production.</p> <p>When this check box is not selected, the material readiness calculation determines if there is enough stock to meet production requirements by comparing the component quantity needed to the current quantity available in the business unit.</p>
Past Due Demand Days	<p>Use this field to help determine the time range to collect unfulfilled demand. Enter the number of days before today's date to include past due demand. For example, if you enter 5 days and today is June 5th, then the readiness calculation includes any unfulfilled demand that was needed on June 1st through today.</p>
Future Demand Days	<p>Use this field to help determine the time range to collect unfulfilled demand. Enter the number of days into the future to include future demand. For example, if you enter 10 days and today is June 5th, then the readiness calculation includes any unfulfilled demand that will be needed from today through June 15th.</p>

Field or Control	Description
<p>Priority Fields</p>	<p>Use the priority fields to determine the relative priority for various types of demand. If two or more transactions have the same due date, then the entries here determine how the current component stock quantity is distributed. Use the following fields to prioritize demand types:</p> <ul style="list-style-type: none"> • Production Priority field for other production IDs and production schedules. • Stock Request Priority field for material stock requests from PeopleSoft Inventory. • Interunit Priority field for material stock requests that are interunit orders. • Sales Order Priority field for sales orders from PeopleSoft Order Management. • Priority field under the Plan Transfer Demand check box for planned transfers from PeopleSoft Supply Planning. • Priority field under the Plan Production Demand check box for planned production orders from PeopleSoft Supply Planning. • Priority field beside the Work Order Demand check box for work orders from PeopleSoft Maintenance Management. <p>For example, if you enter 1 in the Sales Order Priority field, 2 in the Stock Request Priority field, 3 in the Production Priority field, and 4 in the Interunit Priority field, then the material readiness report distributes available quantity needed on the same date/time to a sales order first, a material stock requests second, a production order third, and a interunit transfer fourth.</p> <p>These priority settings only impact the material readiness report.</p>
<p>Plan Transfer Demand</p>	<p>If PeopleSoft Supply Planning is installed, select this check box to include planned transfers in the demand side of the material readiness calculation. Define which planned transfers should be included based on the Approval, Status (planned, firm planned, or both), and Frozen fields in this row. Use the Priority field to determine the relative priority of planned transfers compared to other types of demand.</p>

Field or Control	Description
Plan Production Demand	If PeopleSoft Supply Planning is installed, select this check box to include planned production in the demand side of the material readiness calculation. Define which planned production should be included based on the Approval, Status (planned, firm planned, or both), and Frozen fields in this row. Use the Priority field to determine the relative priority of planned production compared to other types of demand.
Work Order Demand	If PeopleSoft Maintenance Management is installed, select this check box to include work orders in the demand side of the material readiness calculation. Use the Priority field to determine the relative priority of work orders compared with the other sources of demand (production orders, sales orders, material stock requests, interunit transfers, planned transfers, and planned production).

Sources of Supply group box

Use this group box to determine what sources of supply are used in the calculation of the material readiness report. The component's available quantity within a business unit is increased by incoming supply from purchase orders, interunit transfers, or production.

Field or Control	Description
Include Supply	Select this check box to include other sources of supply for the component quantity in the material readiness calculation, such as purchase orders, incoming interunit transfers, or other production. When this check box is not selected (default), the material readiness calculation uses the current quantity available in the business unit as the source of supply.
Past Due Supply Days	Use this field to help determine the time range to collect incoming supply. Enter the number of days before today's date to include past due supply from incoming supply sources, such as; purchase orders, incoming interunit transfers, or other production. For example, if you enter 5 days and today is June 5th, then the readiness calculation includes any incoming supply that was due on June 1st through today.

Field or Control	Description
Future Supply Days	Use this field to help determine the time range to collect incoming supply. Enter the number of days into the future to include future supply from incoming supply sources, such as: purchase orders, incoming interunit transfers, or other production. For example, if you enter 10 days and today is June 5th, then the readiness calculation includes any incoming supply that will be received from today through June 15th.
Approved PO Requisitions	If PeopleSoft Purchasing is installed, select this check box to include approved requisitions in the supply side of the material readiness calculation. Only approved requisitions that specify the PeopleSoft Inventory business unit and a due date are counted.
Include null due date reqs	Select this check box to include approved requisitions with a blank due date. The report uses today's date as the due date for these requisitions. This check box is only available if you have selected the Approved PO Requisitions check box.
Incl WIP in Starting Qty	Select this check box to add the available quantity within a WIP location to the current available quantity of the business unit. A WIP location is a material storage location within the business unit that is defined as a WIP location.
Entered Status Production	Select this check box to include production orders in the <i>Entered</i> status in the supply side of the calculation.
Co-Products / By-Products	Select this check box to include co-products and by-products in the supply side of the calculation.
Plan Purchase Orders	If PeopleSoft Supply Planning is installed, select this check box to include planned purchase orders in the supply side of the calculation. Define which planned purchase orders should be included based on the Approval, Status (planned, firm planned, or both), and Frozen fields in this row.
Plan Transfer Supply	If PeopleSoft Supply Planning is installed, select this check box to include planned transfer orders in the supply side of the calculation. Define which planned transfers should be included based on the Approval, Status (planned, firm planned, or both), and Frozen fields in this row.

Field or Control	Description
Plan Production Supply	If PeopleSoft Supply Planning is installed, select this check box to include planned production orders in the supply side of the calculation. Define which planned production should be included based on the Approval, Status (planned, firm planned, or both), and Frozen fields in this row.

Changing Production ID Statuses

This section discusses how to use the Production Status Change components to release production or change production statuses for production IDs.

Pages Used to Change Production ID Statuses

Page Name	Definition Name	Usage
<u>Production ID Status Change Page</u>	SF_PRDN_STATUS_MA	Release or change the production status of a single production ID. If you didn't release production during the creation or maintenance of the production ID, use this page to change the status of a production ID from <i>Entered</i> or <i>Firmed</i> to <i>Released</i> . You can also use this page to change a production ID from <i>In Process</i> to a prior status. You must define at least one production ID.
<u>Release Production Selection Page</u>	SF_PRDN_RELSE_REQ	Change the production status and release multiple production IDs and production schedules. Define at least one production ID or production schedule with a status of <i>Entered</i> or <i>Firmed</i> .
<u>Production Selection Page</u>	SF_PRDN_RELSE_REQ2	Define additional production status change and release criteria.
Dispatch List Selection Page	RUN_SFS2002	Generate a dispatch list. Define at least one production ID or production schedule.
Production Selection - Report Page	RUN_SFS2002B	Define additional production criteria for the dispatch list.

Page Name	Definition Name	Usage
Print Production Documents Page	RUN_SFS2003	Print production documents for selected production IDs. Define at least one production ID.
Dispatch Inquiry - Selection Page	SF_DISP_LIST_SEL	Select all scheduled tasks for a work center by a particular date or range of dates that you'd like to view. Production IDs must have a production status of either <i>Released</i> or <i>In Process</i> .
Dispatch Inquiry - Results Page	SF_DSP_LIST_GRD	Display the requested dispatch list information.

Production ID Status Change Page

Use the Production ID Status Change page (SF_PRDN_STATUS_MA) to release or change the production status of a single production ID.

If you didn't release production during the creation or maintenance of the production ID, use this page to change the status of a production ID from Entered or Firmmed to Released. You can also use this page to change a production ID from In Process to a prior status.

Navigation:

Production Control > Process Production > Release Production > Change Production ID Status

Production ID Details

When no revision is specified, the system uses either the start or due date (based on the BOM explosion date option in the Manufacturing definition page) of the production for determining the bill of material used for producing the item.

To release production, change the **Production Status** from *Entered* or *Firmmed* to *Released*.

Click the **Save** button to run the release process.

Note: You cannot change rework or teardown production IDs back to the *Entered* status.

Click the **Save** button to run the production status change process.

If you have reversed all transactions for an *In Process* production ID, you can change it to a prior status such as *Entered*, *Firmmed*, or *Released*. If you change the status back to *Firmmed* or *Released*, no changes to the operation or component list are made.

You can also set the production ID's status back to *Entered* from *Released*. In this instance, the system deletes the production ID's component list and operation list. If you set the status to *Firmmed*, the system doesn't delete the component list and operation list, but it updates the status.

If you change the status of a released production ID and you integrate with a third-party MES, PeopleSoft Manufacturing uses the Production Order Update EIP to publish a message to the MES with the transaction information. The MES then subscribes to that message and updates the MES information.

Related Links

[Understanding BOM Maintenance](#)

[Understanding Production IDs and Production Schedules](#)

Changing Production Schedule Statuses

This section discusses how to Change Production Schedule Statuses

Pages Used to Change Production Schedule Statuses

<i>Page Name</i>	<i>Definition Name</i>	<i>Usage</i>
Production Schedule Status Page	SF_PRDNSCH_STAT_MA	Change the status of a single production schedule from <i>Entered</i> or <i>Firmed</i> to <i>Released</i> . If you do not release the schedule as you're adding it, you can release it here. Change a production schedule from <i>In Process</i> to a prior status. You must define at least one production schedule.
Dispatch List Selection Page	RUN_SFS2002	Generate a dispatch list. Define at least one production ID or production schedule.
Production Selection - Report Page	RUN_SFS2002B	Define additional production criteria for the dispatch list.
Print Production Documents Page	RUN_SFS2003	Print production documents for production IDs with a production document status of <i>Ready to Print</i> , reprint production documents, or print production documents for the specified production IDs regardless of the production document print status.
Dispatch Inquiry - Selection Page	SF_DISP_LIST_SEL	Select all scheduled tasks for a work center by a particular date or range of dates that you'd like to view. Production schedules must have a production status of either <i>Released</i> or <i>In Process</i> .

Page Name	Definition Name	Usage
Dispatch Inquiry - Results Page	SF_DSP_LIST_GRD	Display the requested dispatch list information.

Production Schedule Status Page

Use the Production Schedule Status page (SF_PRDNSCH_STAT_MA) to change the status of a single production schedule from Entered or Firmed to Released.

If you do not release the schedule as you're adding it, you can release it here. Change a production schedule from In Process to a prior status.

Navigation:

Production Control > Process Production > Release Production > Change Prdn Schedule Status > Prod Sched Status Change

Production Schedule Detail

When no revision is specified, the system uses either the start or due date (based on the BOM explosion date option on the Manufacturing definition page) of the production for determining the bill of material used for producing the item.

To release production, change the production status from *Entered* or *Firmed* to *Released*. If the change was from *Entered* when you save this page, the system creates the end item's component list and operation list by copying the item's bill of material and routing. Additionally, the routing operations start and due dates and times are calculated. Also, this change enables you to make manual changes to the output list, if desired. If the change was from *Firmed*, only the status is updated, and the operation, component, and output lists are unchanged.

If you have reversed an *In Process* production schedule, you can change it to a prior status such as *Entered*, *Firmed*, or *Released*. If you change the status back to *Firmed* or *Released*, no changes to the operation, component, or output lists are made. You can also set the production schedule status back to *Entered* from *Released*. In this instance, the system deletes the production schedule's component list and operation list, and manual changes to the output list are no longer allowed. If you set the status to *Firmed*, the system doesn't delete the component list and operation list, but it updates the status.

You can also set the production schedule's status back to *Entered* from *Firmed* or *Released*. In this instance, the system deletes the production schedule's component list and operation list. In addition, the output list is regenerated and cannot be manually maintained.

When you change the status of a released production schedule, if you are integrating to a third-party MES, PeopleSoft Manufacturing uses the Production Order Update EIP to publish a message to the MES with the transaction information. The MES then subscribes to that message and updates the MES information.

Changing Production Statuses and Releasing Multiple Production IDs and Schedules Simultaneously

This section discusses how to Change Production Statuses and Releasing Multiple Production IDs and Schedules simultaneously.

Pages Used to Change Production Statuses and Releasing Multiple Production IDs and Schedules Simultaneously

<i>Page Name</i>	<i>Definition Name</i>	<i>Usage</i>
<u>Release Production Selection Page</u>	SF_PRDN_RELSE_REQ	Change the production status and release multiple production IDs and production schedules. Define at least one production ID or production schedule with a status of <i>Entered</i> or <i>Firmed</i> .
<u>Production Selection Page</u>	SF_PRDN_RELSE_REQ2	Define additional production status change and release criteria.

Release Production Selection Page

Use the Release Production Selection page (SF_PRDN_RELSE_REQ) to change the production status and release multiple production IDs and production schedules.

Navigation:

Production Control > Process Production > Release Production > Request Prdn Status Change > Request Prdn Status Change

Report Request Parameters

Enter a request ID and select the business unit.

Current Status and Convert Production To

In the **Current Status** group box, select whether the current production is *Entered* or *Firmed*, and whether you want to change the production status from:

- *Entered* to *Firmed*
- *Entered* to *Released*
- *Firmed* to *Released*

Note: You cannot use the Production Status Change process to reverse orders and change them to prior statuses. Use the Production ID Status Change page or the Production Schedule Status Change page to change production to prior statuses.

Number of Days Out

Enter the number of days out for the production status change. This number indicates the beginning date and the number of days into the future. The default is zero (0); this is the current system date. For example, enter 0 in both the beginning and **to** fields if you want to change production with the current system date. If you want to change *Entered* production to *Released* beginning one day from the current system date and three days into the future, enter 1 in the beginning field and 3 in the **to** field.

Note: Any production considered to be past due is assumed to start on the current system date. Therefore, you must enter 0 in the beginning **Number of Days Out** field to include past due production information.

Inc Past Due

Select the **Inc Past Due** (include past due) check box to include all production of that status with a due date earlier than the early fence in the selection criteria.

Note: You can only select the Inc Past Due check box with one of the entered rows.

Production Selection Page

Use the Production Selection page (SF_PRDN_RELSE_REQ2) to define additional production status change and release criteria.

Navigation:

Production Control > Process Production > Release Production > Request Prdn Status Change > Production Selection

<i>Field or Control</i>	<i>Description</i>
Select Production IDs	Enter values to change the production status and release production for production IDs by indicating one or more of these values: <ul style="list-style-type: none"> • Prdn ID (production ID) • Prdn Area (production area) • Item ID

Field or Control	Description
Select Production Schedules	<p>Enter values to change the production status or release production schedules.</p> <p>You can select the production schedules you want to change by selecting all or a range of production schedules based on:</p> <ul style="list-style-type: none"> • Production area • Item ID
Start Date Range	<p>This field is used with the production selected. For example, you can change the production status and release a specific production ID, all production for a specific item, or production for a specific item that's due to start within the date range specified.</p>
Run	<p>Click to run this request. Process Scheduler runs the Production Release process (SFPARELS) at user-defined intervals.</p>

Manufacturing Execution System

When you perform this transaction changing production order statuses, if you are integrating to a third-party MES, PeopleSoft Manufacturing uses the Production Order Update EIP to publish a message to the MES with the transaction information. The MES then subscribes to that message and updates the MES information.

Issuing Material to Production

Understanding Component Issue Methods

After releasing production, you need the proper components to manufacture the item on the shop floor. There are several ways to make sure that the materials are there. You can stock components in the WIP locations, you can issue material directly to a production ID, or you can move the components to the shop floor when material is needed at a work center. You can also move material to production using electronic data collection.

You can issue material to production in the same manner that you control component items. In some instances, you may want only a fixed quantity located on the shop floor, especially when space is limited. In addition, there may be some items that do not need to be allocated to specific orders or a production run. In this case, you'll want to keep components on hand in the WIP locations to fulfill this need. PeopleSoft Manufacturing supports three methods of issuing components to the shop floor: Issue, Kit, and Replenish.

You define the issue method for each component of an end item at the production area and end item level. Define the issue method by selecting one of these options:

Term	Definition
Issue	Use this method to generate a picking plan and issue material directly from inventory to the operation's work center for all components. When you select this option, all the components for the end item are issued using this method.
Kit	Use this method to generate a picking plan and issue material from inventory directly to a production ID. During the picking process, the components are assembled into batches or kits. When you select this option for regular production, all the components for the end item are issued using this method. For rework and teardown production, the end item to be reworked or torn down is issued using the kit method. The system issues any additional components required for rework or teardown production using the issue method set for each item at the production area and item level. This issue method appears automatically from the Define Business Unit Item - Manufacturing page, and it can be overridden on the Production Area - Item Detail page.

Term	Definition
Replenish	<p>Use this method to stock all of the components for the end item in the WIP locations. The system doesn't generate pick plans for component requirements. However, the system uses the Replenishment Notification workflow to notify a defined role when the quantity on hand in the WIP location falls below a minimum stocking quantity. When you select this option, all components for the end item are managed using replenishment.</p> <p>If you're using PeopleSoft Flow Production, and the issue method is replenish, you can also replenish the WIP locations directly from an inventory location, feeder line, or supplier using Kanban cards or online replenishment requests.</p>
Component's Method	<p>Use this method when you want to mix the method of issuing components. With this option, you can issue some of the components using the issue method, some using the kit method, and others using the replenishment method. In this case, you'll use the component's method that is defined on the Define Business Unit Item pages.</p>

Note: Quantities of an item that are stored in a nettable, available WIP location and that are reserved for production use are not available for other purposes.

Related Links

[“Define Business Unit Item - Manufacturing: General Page” \(PeopleSoft Managing Items\)](#)

[Production Area: Item Detail Page](#)

[Delivered Workflows for PeopleSoft Manufacturing](#)

Common Elements Used in Issuing Material to Production

Field or Control	Description
Production ID	The production order identifier.
Production Area	The production area identifier where the manufacturing process occurs.
Item ID	The item and description of the item being manufactured.
Prdn Type (production type)	The type of production being processed. Values are <i>Production</i> , <i>Rework</i> , and <i>Teardown</i> .
Start Date	The date the production is or was due to begin.

Field or Control	Description
Due Date	The date the production is or was due to be completed.
Component Issue Methods	Options are <i>Issue</i> , <i>Kit</i> , or <i>Replenish</i> .
Prdn Start Qty (production start quantity)	The quantity required at the beginning of the production process. This quantity is rounded up to account for any operation yield if the system calculates the production start quantity based on the production end quantity.
Prdn End Qty (production end quantity)	The quantity expected at the end of the production process. This quantity is rounded down to account for any operation yield if the system calculates the production end quantity based on the production start quantity.
Serial in Prdn (serial in production)	A display-only check box that indicates if serial genealogy information is captured for the production ID.
Trace Usage	A field indicating whether serial or lot genealogy is captured for the component ID. If the component's trace usage is serial or lot and the assembly's Serial in Prdn option is selected, then genealogy information is captured. Values are <i>Serial</i> , <i>Lot</i> , and <i>None</i> .

Related Links

[Understanding Serial Genealogy](#)

Using the Issue Method

Use this method to issue components for a defined period of production. When using the issue method, you generate a picking plan that specifies certain parameters for picking components. For example, you might have the system to recommend the location from which to pick the components, or you might want to view all locations and then select one. You can also specify that you want to pick enough components to cover production for a certain number of days, for a date range, or for current production.

Once you define how you want to pick the material, you use picking plans to translate requested stock into material picking instructions for stockroom processing. After the material has been pulled and the picking plan is confirmed, the system decrements the picked quantities from the quantity available at the stockroom location.

When choosing the material to pick, the system uses the existing on-hand inventory quantity in the WIP location. This logic includes all component requirements for the specified time frame and nets that against the existing quantity in the WIP location as well as all pending pick plans ready to release. The logic also takes into account any operation yield. This ensures that excess material in the WIP location is always used before additional material is issued. In addition, PeopleSoft Manufacturing includes all production from the beginning time, taking into account all previous material shortages.

Note: Quantities of an item that are stored in a nettable, available WIP location and reserved for production use are not available for other purposes.

With this method, you can set a minimum quantity for the item in a specific WIP location. This enables you to maintain a buffer or a safety stock in the location to ensure sufficient quantity on hand is always available.

If you display substitutions on the pick plan, the process verifies that sufficient quantity on hand exists to pick the full issue quantity. If not, all effective substitute items with available quantities are listed, along with their locations. The substitute items listed are based on the list of substitutes defined in the business unit's item attributes for the original component.

Related Links

[Reviewing and Confirming Picking Plans](#)

Using the Kit Method

Use this method to issue components directly to production IDs for discrete production runs. When using the kit method, you generate a PUSH or PULL picking plan in the same manner as the issue method. The material is then assembled into batches or kits. You cannot use kitting with production schedules.

When additional kitted components are required for a production ID—or when excess material must be returned back to stock—use the Issue/Return Kit Components page. If you need to return a kit in its entirety, use the Component De-Kit page.

Kitting is the required issue method for rework and teardown end items. The end item to be reworked or torn down is issued using the kit method from a non-nettable storage location. The system issues any additional components required for rework or teardown production using the issue method set for each item at the production area and item level. This issue method appears automatically from the Define Business Unit Item - Manufacturing page, and it can be overridden on the Production Area - Item Detail page.

If you display substitutions on the pick plan, the process verifies that sufficient quantity on hand exists to pick the full, required quantity for the specified production ID or operation. If not, all effective substitute items with available quantities are listed, along with their locations. The substitute items listed are based on the list of substitutes defined in the business unit item attributes for the original component.

Using the Replenishment Method

To define storage locations, use the Storage Locations (STOR_LOCATIONS) component. To define storage area locations, use the Storage Areas (STORAGE_AREAS) component.

To define replenishment locations, use the Production Replenish Locations component (REPL_LOCATIONS). Use the REPL_LOCATIONS_CI component interface to load data into the tables for this component.

Use the replenishment method to stock components in the WIP locations at the work center where you use the component. These components are typically stocked to a defined on-hand quantity that you establish.

During completions, the components are consumed from the WIP location. When the quantity on hand for an item falls below its replenishment quantity in that location, a workflow notification is sent to the stockroom, indicating the location must be replenished.

If you use PeopleSoft Flow Production, you can also use Kanban cards, pull tickets, and pull lists to communicate the replenishment request. Before you move components into replenishment locations, specify the replenishment point for each component that you manage by using the replenishment method. You must also specify the issue multiple that is used to replenish the WIP location. Define both of these parameters using the Define Business Unit items pages. If you use PeopleSoft Flow Production, you can also replenish the WIP locations directly from an inventory location, feeder line, or supplier using Kanban cards or online replenishment requests.

Pages Used to Use the Replenishment Method

<i>Page Name</i>	<i>Definition Name</i>	<i>Usage</i>
<u>Prdn Replenish Locations Page</u>	SF_REPL_INV	Define production replenishment locations. This is required if you use PeopleSoft Flow Production. If you use PeopleSoft Manufacturing without PeopleSoft Flow Production, you can set up production replenishment defaults if you use the replenishment component-issue method.
<u>Prdn Replenish Detail Page</u>	SF_REPL_INV_DTL	If you have PeopleSoft Flow Production installed, define how WIP locations are replenished. If you use PeopleSoft Manufacturing without Flow Production, set up defaults if you use the replenishment component-issue method. <u>Prdn Replenish Locations Page</u>

Prdn Replenish Locations Page

Use the Prdn Replenish Locations page (SF_REPL_INV) to define production replenishment locations.

This is required if you use PeopleSoft Flow Production. If you use PeopleSoft Manufacturing without PeopleSoft Flow Production, you can set up production replenishment defaults if you use the replenishment component-issue method.

Navigation:

Inventory > Maintain Storage Locations > Define Prod Replenishment

<i>Field or Control</i>	<i>Description</i>
WIP locations	Select the storage location for the item. The storage levels that appear depend on the storage structure established on the Inventory Options page.

Field or Control	Description
<p>Iss Mult (issue multiple) and Repl Point (replenishment point)</p>	<p>Define values for these fields.</p> <p>When the quantity on hand in the WIP location drops below the specified replenishment point, the system issues a workflow replenishment request indicating that additional material needs to be supplied, and it uses the issue multiple that you specify on this page.</p> <p>If you use PeopleSoft Flow Production, the system uses the issue multiple for the Kanban quantity.</p> <hr/> <p>Note: If you haven't installed PeopleSoft Flow Production, the system uses the replenishment point for only those items that have a replenishment mode of <i>Backflush-Controlled</i>.</p>
<p>WIP Min Qty (WIP minimum quantity)</p>	<p>Enter a value to indicate the minimum amount of the item that you want stored at the WIP location and that is not associated with a specific order.</p>
<p>WIP RPL Source (WIP replenishment source)</p>	<p>Select to specify where to send the PeopleSoft Flow Production replenishment request and which source supplies the WIP location. Options are:</p> <ul style="list-style-type: none"> • <i>Feeder:</i> A feeder line creates subassemblies that it feeds into the main production line. <p>Once you have used a specified quantity of the subassemblies, you send a replenishment signal to start production on the feeder line.</p> <ul style="list-style-type: none"> • <i>Inventory:</i> You replenish the WIP location directly from an inventory location. • <i>Supplier:</i> You replenish the WIP location by directly receiving purchased components from a supplier.
<p>Repl Max Qty (replenishment maximum quantity), WIP RPL Source (WIP replenishment source), WIP RPL Mode (WIP replenishment mode), WIP RPL Type (WIP replenishment type), and WIP RPL Method (WIP replenishment method)</p>	<p>If you do not use PeopleSoft Flow Production, these fields are unavailable. In that case, the system uses the default replenishment mode of <i>Backflush Controlled</i> and a replenishment method of <i>Workflow</i>.</p>
<p>Repl Max Qty (replenishment maximum quantity)</p>	<p>If you are using PeopleSoft Flow Production, this field is set to the maximum amount of the item that you want stored at any WIP location using the item. This quantity includes the item's on-hand quantity and any open requests already made. The system issues a warning if you perform a replenishment transaction that exceeds the replenishment maximum quantity.</p> <hr/> <p>Note: This field is available for only those items using the <i>Manual</i> replenishment mode.</p>

Related Links

[Prdn Replenish Locations Page](#)

Prdn Replenish Detail Page

Use the Prdn Replenish Detail page (SF_REPL_INV_DTL) to if you have PeopleSoft Flow Production installed, define how WIP locations are replenished.

If you use PeopleSoft Manufacturing without Flow Production, set up defaults if you use the replenishment component-issue method.

Navigation:

Inventory > Maintain Storage Locations > Production Replenish Locations > Prdn Replenish Detail

Click the **Production Replenishment Detail** button on the Production Replenish Locations page.

<i>Field or Control</i>	<i>Description</i>
Repl Point (replenishment point) and Iss Mult (issue multiple)	Define values for these fields.
Repl Max Qty (replenishment maximum quantity)	<p>If you are using PeopleSoft Flow Production, enter a value to set the maximum amount of the item that you want stored at any WIP location using the item. It includes the item's on-hand quantity and any open requests already made.</p> <hr/> <p>Note: This field is available for only those items using the <i>Manual</i> replenishment mode.</p> <hr/>

Field or Control	Description
<p>WIP RPL Mode (WIP replenishment mode)</p>	<p>Select to indicate how PeopleSoft Flow Production generates replenishment requests for the item. Options are:</p> <ul style="list-style-type: none"> • <i>Backflush Controlled</i>: You consume components from the WIP location while backflushing completions. <p>When the quantity on hand falls below the replenishment point, the system automatically generates a replenishment request to bring the on-hand quantity back above the replenishment point. The replenishment request is a multiple of the issue multiple. For example, if the replenishment point is 60, the on-hand quantity is 30, and the issue multiple is 20, then the system generates a replenishment request for 40 to bring the on-hand WIP location quantity back above the replenishment point.</p> <ul style="list-style-type: none"> • <i>Kanban Card</i>: The replenishment process uses Kanban cards as a manual request for material. <p>Kanban cards are either entered or imported into the system and then printed out. A Kanban card would be attached to a box of components. Each Kanban card has a Kanban ID.</p> <ul style="list-style-type: none"> • <i>Manual</i>: A visual indicator signifies that the WIP location needs replenishment, and you scan in the item ID and WIP location to generate a replenishment request for the specified issue multiple. <p>This request includes the replenishment quantity and source location associated with that item and WIP location. This is largely used with electronic data collection.</p> <hr/> <p>Note: If you are using Kanban cards with PeopleSoft Flow Production, you can select a WIP replenishment type to designate whether you want the Kanban card to be used one time or to be reusable. This field is available only if you select <i>Kanban Card</i> for the WIP replenishment mode.</p> <hr/>

Field or Control	Description
WIP RPL Source (WIP replenishment source)	<p>Select to specify where to send the PeopleSoft Flow Production replenishment request and which source supplies the WIP location. Options are:</p> <ul style="list-style-type: none"> • <i>Feeder</i>: A feeder line creates subassemblies that it feeds into the main production line. Once you use a certain quantity of the subassemblies, you send a replenishment signal to start production on the feeder line. If you select <i>Feeder</i> as the WIP replenishment source, the WIP Production Area field becomes available. Select the WIP production area that serves as a feeder line for the item. • <i>Inventory</i>: You replenish WIP location directly from an inventory location. If you select <i>Inventory</i> as the WIP replenishment source, the Source Location fields become available for entry. Select the source storage location that replenishes this item. The location field is not mandatory but, if completed, it must be a valid location. The storage levels that appear depend on the storage structure established on the Inventory Options Page. • <i>Supplier</i>: Use supplier replenishment to replenish the WIP location by directly receiving purchased components from a supplier. If you have selected <i>Supplier</i> as the WIP replenishment source, the Supplier ID and Supplier Location fields become available. Select the supplier ID and supplier location that directly replenish this item. You can override this before dispatch if necessary.
WIP RPL Method (WIP replenishment method)	<p>Select to designate how the PeopleSoft Flow Production replenishment request is communicated. You must select <i>Backflush</i> or <i>Manual</i> as the WIP replenishment mode to use WIP replenishment methods. The WIP replenishment method options are:</p> <ul style="list-style-type: none"> • <i>Workflow</i>: The system generates a worklist entry that links to the Production Replenishment worklist, and uses defaults for the item, quantity, and From and To WIP locations. You can override the values to complete the transfer. • <i>Pull Ticket</i>: You create a one-time replenishment request through either a backflush or a manual scan and run the pull ticket print process to print the pull ticket. This is similar to a one-time Kanban card. • <i>Pull List</i>: A pull list is a list of Kanban requests that you use in a manner similar to the one that you use for a pick list. You scan in Kanban IDs to transfer quantities. You run the pull list process on a scheduled basis that picks up all new requests. You scan in the Kanban ID from the pull list to transact each request.

Creating and Processing Picking Plans

PeopleSoft Manufacturing uses picking plans to translate requested stock into material picking instructions for stockroom processing. The system supports PUSH and PULL picking methods:

<i>Field or Control</i>	<i>Description</i>
PUSH picking plan	The system determines the locations from which to pick each item, and it creates a hard reservation for the item when you generate the pick list. A hard reservation reserves the item in a specific location. Once a hard reservation exists, the item is unavailable for other inventory transactions.
PULL picking plan	The system lists all available locations from which the picker can pull the items. The picker then enters the actual location information. When pulling material to production, PeopleSoft Manufacturing doesn't make a hard reservation at the time that the picking plan is generated.

Note: Item quantities in WIP are not available to fulfill sales orders or material stock requests.

You can create a picking plan for items in a production area that use the production issue or production kitting material issue methods. Floor stock and expensed items are never kitted or issued.

If you pick lot-controlled items and the lot is not yet available (or has already expired), the picking plan report prints the applicable date. If the date has already passed, the lot has expired. If the date is in the future, the lot is not yet available. The picking plan displays material from a lot as available even if it has expired, but you can then change the location using the Review Plan process (SFS6000).

The system generates picking plans for production IDs and production schedules in the *Released* or *In Process* status.

To create and process a picking plan for issue or kit components:

1. Create a picking plan using either a PUSH or PULL picking method by using the Picking Options page.
2. Pick the material.

If you use the PULL method, record the picked components and the storage area and location from which they were picked. If you use the PUSH method, confirm that the components were picked from the storage area and location recommended in the pick plan. You can simultaneously confirm the picking plan and release material to production. To automatically initiate the Material Release process, select **Release at Save**, confirm the pick plan, and then save the page. Alternatively, you can schedule the process by running the Update Pick Batch process. Confirm the pick plan and selecting either the Update Pick Batch process or the Update Pick Batch and Release process.

3. Review and confirm the picking plan using the Review Plan page.

If you pick quantity for the pick line in phases, then you should not check the complete option until you execute the final pick.

4. Issue material to the shop floor using the Material Release page, if the release process wasn't automatically initiated from the Update Pick Batch process or the Update Pick Batch and Release process.

Pages Used to Create and Process Picking Plans

Page Name	Definition Name	Usage
<u>Picking Options Page</u>	RUN_SFS6000	Generate picking plans for production. You can generate pick plans for production with a status of <i>Released</i> or <i>In Process</i> .
<u>Pick Plan Extract Page</u>	RUN_SFS6000_SEC	Indicate that you want to print the extract file for bar codes, and indicate where the file is located.
<u>Picking Options - Production Selection Page</u>	RUN_SFS6000B	Define the range of production IDs, production schedules, production areas, and item IDs for which you want to generate a picking plan.
<u>Runtime Settings Page</u>	RUN_SFS6000A	Indicate the maximum number of locations to display once quantity has been fulfilled when running a pull pick plan and when displaying substitute items. Also, use this page to set the commit level during processing. The commit level is the number of components that are processed between updates to the database and is used to minimize database locking. This page is typically hidden, and it should be only be accessed by a system administrator. Once this page has been configured, the page should again be hidden.
<u>Review Plan - Production Selection Page</u>	SF_ISS_DIALOG	Select the specific pick batch that you want to review. You must generate at least one pick plan by using the Material Picking Plan process.
<u>Review Plan Page</u>	SF_PICK_TRANS	Confirm that the material was pulled from the suggested stores location, or to indicate from which location the material was pulled. You must generate at least one pick plan by using the Material Picking Plan process.

Page Name	Definition Name	Usage
Pick Batch Options Page	RUN_SFS6002	Select the report parameters for the pick batch you'd like to update. You must first generate a pick plan for selected production.
Update Pick Batch - Production Selection Page	RUN_SFS6002B	Select the production to update.
Material Release Page	RUN_SFS6001	Issue material to the shop floor. Use this page if you selected the Do Not Release at Save option on the Review Plan page or if you did not select the two-step process in the Update Pick Batch component. You must pick and confirm at least one pick plan.

Related Links

“Lot Control Information Page” (PeopleSoft Inventory)

Picking Options Page

Use the Picking Options page (RUN_SFS6000) to generate picking plans for production.

You can generate pick plans for production with a status of Released or In Process.

Navigation:

Production Control > Process Production > Issue Materials > Create Picking Plan > Picking Options

This example illustrates the fields and controls on the Picking Options page. You can find definitions for the fields and controls later on this page.

Field or Control	Description
Report Only Mode	Select to preview the pick plan before running it. The system does not create material reservations in Report Only mode because it is an information-only report.
Substitutes	Select to print substitutes on the pick plan. However, if you do not want the picker to pick substitutes, run the pick plan without displaying any substitutes. In this case, you can also run the pick plan in Report Only mode first, list substitutes, and then make the substitution on the component list before running the final pick plan. Note: Substitute items for rework and teardown end items do not appear. Once a partial pick has been done using an item or its substitute, it must be completed with the same item. No partial picking is permitted. If there is a shortage of the original item and it has substitutes, the substitutes appear on the pick plan. They are distinguished by a border around the substitute items. Note: The pick plan does not perform automatic substitutions.
Reprint Pick Batch	Select to reprint a previously printed pick batch.
Pick Batch ID	This edit box becomes available when you select Reprint Pick Batch. Select the pick batch ID number. If this is the first time you're printing the picking plan, do not select the Reprint Pick Batch check box.

Field or Control	Description
System (Push) or Picker (Pull)	<p>Indicate whether the system uses one of the following methods to determine the locations from which it picks components:</p> <ul style="list-style-type: none"> • If you select the PUSH method, the system recommends from which inventory locations to pick the material. <p>When the system uses this method, it transfers the material from the suggested location upon material release. You can change the location prior to confirmation in the Review Plan page.</p> <ul style="list-style-type: none"> • If you use the PULL method, you decide which inventory location from which to pull the material and enter that information in the Review Plan page. <p>The picking plan displays all locations (up to a maximum of 10) where available inventory is located.</p>
Issue Method Option	<p>Select from the following options: Issue, Kit, and Both Issue and Kit. Subsequent selection options depend on the issue method selected here.</p>

Field or Control	Description
Issue	<p>When this method is selected, components on production IDs or schedules whose issue method is set to Production Issue are picked. Because these components are sent to WIP locations for consumption during end-item completions, the Production Selection process prompts you for WIP location information.</p> <p>The issue method uses netting to determine the amount of components to send to the WIP locations. The system includes all requirements through the selected date, even past due requirements when a date range is entered. It also checks requirements from production areas outside the selected range of production areas, if they share the same WIP locations.</p> <p>For each required component, the system determines the available quantity on hand in the WIP location. If the quantity on hand is negative, the system treats it as 0. The system then determines the required quantity of the component for the selected production. The system also reviews the quantity of in-process picking plans for the component and the WIP location.</p> <p>The system then checks the WIP minimum quantity, which is defined at the item and location level. It defines the additional quantity to be issued over and above the demand for <i>Issue</i> components. If all requirements occur as planned—and no additional material is issued to the WIP location—the component should have this quantity remaining in the WIP location.</p> <p>Once all demand is calculated (quantity required + WIP minimum quantity), it's netted against all supply (quantity on hand in the WIP location + all pending pick plans destined for the location). If the demand is greater than the supply, that amount appears on the pick plan. If supply is greater than demand, the component is not printed on the pick plan.</p>
Kit	<p>When this method is selected, components on production IDs whose issue method is set to Production Kit are picked. Because these components are issued directly to a production ID and are not consumed from WIP locations during end item completions, you specify the production area, production ID, and operation to which you want to send material. You cannot send material to a WIP location. The pick plan nets the component's scheduled quantity against the issued quantity. If the scheduled quantity is greater than the issued quantity, it prints the quantity on the pick plan. If the issued quantity is equal to or greater than the scheduled quantity, the system considers that component requirement fulfilled and does not print it on the pick plan.</p>
Both Issue and Kit	<p>This method assumes that you're picking components for production regardless of the issue method. Using this option, some components are sent to WIP locations and some directly to a production ID. On the Production Selection page, you specify to which production ID kitted components are sent as well as which WIP locations are stocked.</p>

Field or Control	Description
Production Type	Select <i>Production</i> , <i>Rework</i> , or <i>Teardown</i> . <hr/> Note: A component with the item status of <i>Hold</i> for the production type <i>Production</i> cannot be picked. However, a component with item status of <i>Hold</i> for rework and teardown production can be picked. <hr/>
Picking Report Sort	You can sort the picking plan by component, location, or production area. The production area option is available for only pull and push kits.
Break	Select to indicate that you want each component or location to print on its own separate page. The options available depend on the issue method selected. These are the valid combinations and sort options:

Push or Pull	Issue Method	By Component	By Location	By Production Area/ ID
Push	Kit	Yes	Yes	Yes
Push	Issue, Both	Yes	Yes	No
Pull	Kit	Yes	No	Yes
Pull	Issue, Both	Yes	No	No

Field or Control	Description
<p>Picking Date/Shift Selection</p>	<p>Indicate the production start dates and shifts for which you want to include picking plans. This information is required. The system issues a picking plan for all components associated with operations due to start within specified periods. Options are:</p> <ul style="list-style-type: none"> <p><i>Date Range:</i> The system picks all components associated with operations due to start on or between the From and Thru date and shifts specified.</p> <p>For example, if you enter from <i>3/1/02 shift</i> through <i>3/2/02 shift 1</i>, the pick plan includes all the material required for production scheduled to start on 3/1/02 shifts 1, 2, or 3 and 3/2/02 shift 1. If you have selected <i>Issue</i> as the issue method, the From date field is unavailable. The pick plan automatically includes all requirements from the beginning time and nets that against what was already consumed (issued to the production ID or production schedule), pending pick plans ready to release and any quantity remaining in the WIP location. This ensures all past due shortages are fulfilled.</p> <p><i>Lead Time:</i> Enter the number of days of production that you want to pick in the Lead Days field.</p> <p>The current date is considered one lead day. Once the lead days are entered, the date through which production is picked is displayed in the Thru date and shift fields. Because the production or work center calendars are not used, the number of lead days also includes weekends in its Thru date calculation.</p> <p><i>Today:</i> Select this option to run pick plans for all components associated with operations due to start on the current day.</p> <p>When selected, the Thru date automatically appears as the current date and shift 3. This indicates a pick plan will be run for all shifts. You can change the date or shift if you want to pick for a different day or through a different shift. When you exit the page and return, the Thru date automatically displays the current date and shift 3, regardless of what was entered and saved in a previous session.</p>
<p>Print Bar Code</p>	<p>Select to have the system print bar codes for bar coded fields on the Pick List.</p> <hr/> <p>Note: PeopleSoft SCM applications do not support the printing of bar codes from processes running on OS390 servers. You should run your SQRs that print barcodes on a process scheduler server that is running on a non-OS390 operation system.</p> <hr/>

Field or Control	Description
<p>Print Bar Coded Control Flags</p>	<p>Select to attach an item's control flags to the bar code printed on each line of the Picking Plan report. These control flags enable the electronic data collection system to prompt for the lot ID, serial ID, staged date, or shipping serial ID immediately after the user scans the bar-coded line number field. For cases that do not require control flags (for example, when you are using a wedge to scan the pick batch ID or pick batch line number bar codes directly into the Inventory Picking page), you might prefer not to select this check box.</p> <p>The format for the bar code printed for each detail line is LSDAH:99999, where:</p> <ul style="list-style-type: none"> • L = Lot ID Control Flag • S = Serial ID Control Flag • D = Staged Date Control Flag • A = Actual Cost Control Flag • H = Shipping Serial ID Control Flag • : = Constant • 99999 = Line Number <hr/> <p>Note: PeopleSoft Inventory delivers printer settings for all Structured Query Report (SQR) output to a generic line printer. However, when printing bar coded information on reports, such as the Material Putaway Plan report and the Picking Plan report on a printer control language printer (for example, HP LaserJet), you must first define the printer type accordingly. You can do this by changing the printer type settings that PeopleSoft Inventory delivers in SETENV.SQC from LINEPRINTER to HPLASERJET.</p> <hr/> <p>If you use electronic data collection, you can create a pick plan extract file. This file can be downloaded to a data collection device and used instead of a paper pick plan. The extract file is ASCII format and contains all the information included within the regular pick plan.</p>

Pick Plan Extract Page

Use the Pick Plan Extract page (RUN_SFS6000_SEC) to indicate that you want to print the extract file for bar codes, and indicate where the file is located.

Navigation:

Production Control > Process Production > Issue Materials > Create Picking Plan > Picking Options

Click the **Attachment** button to select a Pick Plan Extract file.

<i>Field or Control</i>	<i>Description</i>
Print Extract File	Select to create a picking plan extract file.
File Directory and File Name	Enter the location to which you want to save the pick plan extract.
OK	Click to return to the Picking Options page.

Picking Options - Production Selection Page

Use the Picking Options - Production Selection page (RUN_SFS6000B) to define the range of production IDs, production schedules, production areas, and item IDs for which you want to generate a picking plan.

Navigation:

Production Control > Process Production > Issue Materials > Create Picking Plan > Production Range

<i>Field or Control</i>	<i>Description</i>
Production Area Information	<p>The production selection options available on this page depend on the material issue method that you choose on the picking options page.</p> <p>For example, if you select the kit method on the picking options page, the WIP Location Range for Issues group box items are not available.</p>
Prdn Areas (production areas)	<p>You can select one of these options when generating picking plans for components using the issue or kit method:</p> <ul style="list-style-type: none"> • All: If you select this option and the issue method you selected is issue, you can additionally enter a range of WIP locations. • Range: If you select this option, the system checks all WIP locations for the production selected.
Options for Kits	<p>You can select one of these options when generating picking plans for components using the kit method:</p> <ul style="list-style-type: none"> • All • Range • Prdn ID: You can also indicate either all or a range. • Item ID: You can also indicate either all or a range.

Field or Control	Description
WIP Location Range for Issues	<p>Select All or Range if all production areas use the issue method. Within the range of storage area, you can further define the selection by any of the four location levels set up in the inventory. If you selected a range of production areas, you cannot select a range of WIP locations.</p> <hr/> <p>Note: If you're selecting consigned kit issue components, including lot- and serial-controlled components, the system picks from <i>both</i> owned and non-owned WIP storage locations.</p>
Run	Click to run this request. Process Scheduler runs the Pick Plan process and report (SFS6000) at user-defined intervals.

Runtime Settings Page

Use the Runtime Settings page (RUN_SFS6000A) to indicate the maximum number of locations to display once quantity has been fulfilled when running a pull pick plan and when displaying substitute items. Also, use this page to set the commit level during processing. The commit level is the number of components that are processed between updates to the database and is used to minimize database locking.

Navigation:

Production Control > Process Production > Issue Materials > Create Picking Plan > Runtime Settings

Field or Control	Description
Pick Plan Commit Batch	This field controls database pick plan commit level processing.
Pick Plan Commit Batch	<p>Enter the number of components that you want to process before a database update is performed.</p> <p>If you do not want to do intermittent commits, then set the commit level to a higher number that is larger than the normal number of components that are usually processed within a pick plan. You may need to try different commit levels to achieve the maximum level of performance while minimizing database locking. The default is <i>100</i>.</p>
Max Pull/Substitute Locations (maximum pull/substitute locations)	Enter the maximum number of locations that you want displayed when running a pull pick plan. This value is also used to determine the number to display for substitute components and their locations. The default is <i>10</i> .

Reviewing and Confirming Picking Plans

Once you generate the picking plan, you must review the plan, make any modifications to PUSH picking plans before picking the material, and enter the picking locations for the material if you're using the PULL method to issue material. You can modify the picking plan before or after you pick the material.

Review Plan - Production Selection Page

Use the Review Plan - Production Selection page (SF_ISS_DIALOG) to select the specific pick batch that you want to review.

Navigation:

Production Control > Process Production > Issue Materials > Review Plan > Production Selection

<i>Field or Control</i>	<i>Description</i>
Unit and Pick Batch ID	When reviewing the pick plan, these fields are required.
Line #, Component ID, Production ID, and WIP Location	You can use these fields to narrow the selection or as a way to view the pick plan.
Pick Batch ID	Enter the number associated with the batch. You can select the ID for the entire pick batch, or you can select From Line # and To Line # to review part of the pick batch. The pick list line number is a sequential number corresponding to each heading on the report, the component and production ID, or production schedule and operation for kitted production, or a component and a WIP location for issue production.
Component ID	Enter to review a picking plan for a specific component ID.
Production ID	Enter to review a picking plan for a specific production ID.
WIP Location and storage Area	For picking plans using the issue method, enter values for these fields and for the levels of locations defined for the PeopleSoft Inventory business unit to review a picking plan for a specific location.
Search	Click to retrieve the selected pick plan.

Review Plan Page

Use the Review Plan page (SF_PICK_TRANS) to confirm that the material was pulled from the suggested stores location, or to indicate from which location the material was pulled.

Navigation:

Production Control > Process Production > Issue Materials > Review Inventory Pick Plan





Enter information on the Production Selection page and click the **Search** button to retrieve the plan.



This example illustrates the fields and controls on the Review Plan page. You can find definitions for the fields and controls later on this page.

Field or Control	Description
<p>Release</p>	<p>Select how you want the material release to occur. Options are:</p> <ul style="list-style-type: none"> <p><i>No Release at Save:</i> Upon saving the page, material is reserved but not released to the production floor.</p> <p>You can release material to the production floor by using the Material Release page.</p> <p><i>Release at Save:</i> Upon saving the page, material is reserved and released to the production floor.</p> <p>The system automatically runs the Material Release process, which decrements the quantity on hand in the selected stores locations and issues the material to the WIP locations or to the production ID.</p>

Field or Control	Description
<p>Kit Components</p>	<p>Where substitutes exist, the Comp ID (component ID) field is available, and you can display substitutes for the component.</p> <p>The substitute component list is obtained from the BOM. No partial substitutions are allowed if components have previously been issued.</p> <hr/> <p>Note: When a kit component is substituted, the component list is updated to reflect the substitution when you click Save on the Review Plan page.</p> <hr/> <p>If a substitution is done on a PUSH pick plan, the original component is unpicked and the new component quantity picked. If the substitution is done on a PULL pick plan and a pick has already been recorded, the substitution is treated the same as for a PUSH plan.</p>
<p>Issue Components</p>	<p>For issue components that are consigned, the pick plan prints only non-owned material locations. If this component exists in an owned location, it must be manually transferred to an owned WIP location to be used in production. This cannot be done using the pick list.</p> <p>The substitute component list is obtained from the business unit level because the component may be associated with multiple end items, resulting in multiple substitute item lists.</p> <p>Where substitutes exist, the Comp ID (component ID) field is available, and you can display substitutes for the component.</p> <p>When an issue component is substituted, you must maintain the information at the component list on the Component List Maintenance page or the Edit/Issue Components page to record the substitution on the appropriate production IDs and production schedules. Until the data is updated or if another pick plan is run, the system attempts to pick the original component again.</p>
<p> (storage location search button)</p>	<p>The system displays the number of storage levels defined for each storage location. Click the Storage Location Search button to search for a different storage area.</p> <p>If you're using the PUSH material issue method, the recommended storage area appears. You can modify the storage area, if you pulled material from an alternate location, as well as the quantity picked. If you need to change the picking location for a component, set the quantity to 0 or delete the existing row, and insert a new row.</p>

Field or Control	Description
Storage Area	<p>If you're selecting consigned kit issue components, including lot- and serial-controlled components, you can pick from <i>both</i> owned and non-owned WIP storage locations if material exists in both.</p> <p>If you're using the PULL material issue method, specify the storage location such as <i>Aisle, Level 1, Level 2, Level 3, and Level 4</i>, depending on the storage level setup.</p> <p>When using the PULL material issue method for rework or teardown production, you can override the typical method and select a nettable location.</p>
Container ID	Enter the value if you're picking from containers.
Confirm	<p>After reviewing each entry, you can confirm the selection by selecting this option. If you confirm an item with the item status of <i>Hold</i>, you'll receive a warning at save time. However, you are not prevented from confirming the pick. Only those components that have been confirmed are released to production.</p> <hr/> <p>Note: If you're modifying previously saved pick information, only the quantities can be modified. If you want to change picking location information, set the quantity to 0 or delete the row, and insert a new row.</p> <hr/>
Completed	<p>Select to indicate that you are finished picking this pick line location. This option works with the Confirm option as follows</p> <ul style="list-style-type: none"> • If you select both Complete and Confirm, you cannot pick additional quantity for this pick line location after the material release process has been run. • If you do not select Complete but you do select Confirm, you can pick additional quantity for this pick line location after the material release process has been run. • If you select Complete but you do not select Confirm, then the Material Release process does not process this pick line. • If you do not select Complete or Confirm, then the material release process does not process the pick line.

Field or Control	Description
Lot ID and Serial ID	<p>If you're using the PUSH material issue method, the serial ID is the serialized component that should have been picked from the storage area. If the component is lot-controlled, the system displays the lot ID from which the component should have been picked. If you need to change the serial ID or lot ID for a component, set the quantity to 0 and insert a new row.</p> <p>If you're using the PULL material issue method, specify the serial ID or lot ID for each component that you picked.</p> <p>If you are entering data for rework or teardown production IDs that are using serial genealogy, keep these points in mind:</p> <ul style="list-style-type: none"> • If the assembly is serial-controlled and the Serial in Prdn option is selected and the component being issued is the assembly item, then you must enter a serial ID when prompted. • If the assembly is not serial-controlled, but the Serial in Prdn option is selected, then you must enter a serial ID when prompted. • The serial association occurs during the update. <hr/> <p>Note: If the component to be issued is not serial-controlled but trace usage is serial, the Pick Plan process does not suggest the serial ID to pick. You must indicate which serial IDs are to be picked. The system verifies that the components have not been assigned to another production ID.</p> <hr/> <p>Note: This logic is also applied to other kit issues.</p>
	<p>If you do not need to make any changes to locations or quantities (or once all changes and selections have been made), you can confirm all of the suggested locations and quantities at one time when you click the Confirm All button at the top of the page.</p>
	<p>Click the Unconfirm All button to reverse all confirmed locations and quantities.</p>
	<p>If you do not pick any of the items on the pick plan, click the Delete All button to remove these rows from the pick plan. This relieves any hard material stock reservations that have been made.</p>
Confirm	<p>You can confirm selected pick lines by selecting this check box to indicate that these pick lines are correct and material is ready to be released.</p>
	<p>Click the Next button to access additional items in the scroll area.</p>

<i>Field or Control</i>	<i>Description</i>
	Click the All Complete button to indicate that all pick lines have been picked and there is no other quantity to be picked.
	Click the All Incomplete button to indicate that all pick lines are not complete. This indicates that you may want to pick additional quantities for specific pick lines.
Save	Click to process the review plan.

Updating Pick Batches

Use the Update Pick Batch component to review the plan for a pick batch as a whole, or for a range of components, WIP locations, or production. This enables you to confirm, unconfirm, complete, uncomplete, or delete entire pick batches rather than maintaining each component one at a time. When you select the delete option, it will not affect any lines that have been previously released. Use this transaction to clear any unpicked pick lines.

In addition, you can simultaneously update the pick batch and release material to production using this component by running the Update Pick Batch and Material Release process (SFCNREL) or the Update Pick Batch process (SFS6002).

Setting Pick Batch Options

You can select pick batch options to update.

To select pick batch options to update:

1. Access the Pick Batch Options page.
2. Enter the following information:
 - a. Select the pick batch ID.
 - b. Select all or a range of line numbers.
 - c. Select the option of **Confirm**, **Unconfirm**, or **Delete (Unreserve)**.
 - d. Select the option of **Complete**, **Incomplete**, or **Unchanged**.
 - e. To update the pick batch only, select **Update Only - No Report**.
 - f. To delete the pick batch detail, select **Update and Report**.

Note: All items specified on the pick plan are confirmed, even if they have been placed on hold subsequent to the generation of the pick plan.

Selecting Production Pick Batches

You can select production pick batches.

To select a production pick batch:

1. Access the Production Selection page.
2. If you're updating a pick batch for kitted material, select a range of production IDs or item IDs.
3. (Optional) Click the **Item Search** button next to the **Item ID** field to access the **Item Search** link to locate a different item.
4. Select all or a range of WIP locations by storage location, depending on the storage level setup, when updating a pick batch for components using the Issue method.
5. (Optional) Click the **Storage Area Location** button next to the **WIP location** fields to access the **Storage Location Search** link to select a different storage location.
6. Click **Run** to run this request.

You can choose to run the Update Pick Batch and Material Release (SFCONREL) process or the Update Pick Batch (SFS6002) process. The Update Pick Batch and Material Release process is a two-step process that simultaneously updates pick batches and releases material to the production floor. This process must run on a server. If you do not want to release material to production at this point, select the Update Pick Batch process. Process Scheduler runs either process at user-defined intervals.

Related Links

“User Preferences - Manufacturing Page” (Application Fundamentals)

“Understanding Inventory Material Storage Structures” (PeopleSoft Inventory)

Issuing Material to the Shop Floor

You can issue material to the shop floor.

To run the Material Release process to issue material to production:

1. Access the Material Release page.
2. Indicate whether you want to release material for all confirmed picking plans, or only for those picking plans that are associated with a single pick batch.
3. Click **Run** to run this request. Process Scheduler runs the Material Release process at user-defined intervals.

Note: Items with the item status of *Hold* can be released.

Related Links

[PeopleSoft Manufacturing Reports: A to Z](#)

Replenishing WIP Locations

As you're completing assemblies at either an operation or to stock, components using the replenish method are consumed from the WIP location associated with the operation sequence that you're completing. Once the quantity on hand for the component falls below the recommended stocking level, the WIP location must be replenished. The Replenishment Notification workflow can be used to notify the stockroom that a set quantity should be moved to the WIP location. If you are using PeopleSoft Flow Production, you can also use Kanban cards, pull tickets, and pull lists to communicate the replenishment request. WIP locations can be replenished directly from an inventory location, feeder line, or supplier using Kanban cards or online replenishment requests

Pages Used to Replenish WIP Locations

<i>Page Name</i>	<i>Definition Name</i>	<i>Usage</i>
<u>Worklist Page</u>	WORKLIST	(Optional) Issue components whose issue method is <i>Replenish</i> . Backflush material to create worklist entries for components whose issue method is <i>Replenish</i> .
<u>Prdn Replenish Locations Page</u>	SF_REPL_INV	(Optional) Define production replenishment locations. This is required if you're using PeopleSoft Flow Production. If you're using PeopleSoft Manufacturing without PeopleSoft Flow Production, you can set up production replenishment defaults if you use replenishment as the component issue method.
<u>Kanban Transfers Page</u>	BCT_INV_TRFR	(Optional) Enter or scan in Kanban transfers to replenish WIP location using electronic data collection.

Worklist Page

Use the Worklist page (WORKLIST) to (Optional) Issue components whose issue method is Replenish.

Backflush material to create worklist entries for components whose issue method is Replenish.

Navigation:

Worklist > Worklist

The worklist entry includes the business unit, component ID, destination location, and the source location. The system recommends an issue quantity based on the item's issue multiple. When you select the worklist entry, the system displays to the Kanban Transfers page.

Kanban Transfers Page

Use the Kanban Transfers page (BCT_INV_TRFR) to (Optional) Enter or scan in Kanban transfers to replenish WIP location using electronic data collection.

Navigation:

- SCM Integrations, Create Transactions, Manufacturing, Kanban Transfer
- Production Control, Process Production, Transact Kanbans, Scan Kanban Transfers, Kanban Transfer
- SCM Integrations, Create Transactions, Inventory, Storage Location Transfer, Inventory Transfer

Field or Control	Description
Transfer Qty (transfer quantity)	The total quantity required at the WIP location.
Stocking UOM	You can change the stocking UOM by changing the UOM that appears next to the transfer quantity field. If the business unit parameter allows negative inventory balances, you can drive the on-hand quantity of the source location negative.
Original Location	The location from which you picked the material. The system supplies a default original location based on the information defined on the Item/Replenish Location page or the WIP Replenishment page in business unit items. You can override the suggested location if you picked the material from a different location.
Area	Enter the appropriate area from which you're transferring material.

Capacity Checking and Replenishing WIP Locations

If the item is designated as an isolate item on the Inventory-Shipping/Handling page in the Define Business Unit Item component, you can replenish it to only empty WIP locations or to locations containing stock with the same item ID. The system prevents you from moving an isolate item to a WIP location with other items.

If you designate a WIP location as storing only one item on the Volume/Weight Capacity page, the system replenishes only material with that item ID to the location. If you do not specify an item ID for a single-item WIP location, the first replenishment transaction to the empty WIP location defines the only item ID that the location can contain until the item quantity has been fully depleted.

Related Links

- “Allowing Negative Inventory and Displaying Warning Messages” (PeopleSoft Inventory)
- “Inventory Definition - Business Unit Definition Page” (PeopleSoft Inventory)
- “Define Item - Inventory: Shipping/Handling Page” (PeopleSoft Managing Items)

Processing Kit Issues and Returns

Use the Issue/Return Kit Components page to issue additional material to a production ID or return excess material back to stock. When processing kit issues and returns, you can only select production where at least one component from the component list has an issue method of kit.

You can only process kit issues and returns for production with *Released*, *In Process*, or *Pending Complete* statuses. If the production ID is in the *Released* status and you issue material using this page, the status is updated to *In Process*. You cannot return a component that is not included on the component list, but you can issue different components by adding a row. You cannot return more than was issued for the component nor can you do a miscellaneous issue or return of an expensed item.

Capacity Checking and Processing Kit Issues and Returns

For kit returns, if you designate a storage location as storing only one item on the Volume/Weight Capacity page (accessible from the Material Storage Locations page), the system only puts away material with that item ID in the location. If you do not specify an item ID for a single-item storage location, the first putaway transaction to the empty storage location defines the only item ID that the location can contain until the item quantity has been fully depleted. If the storage location is flagged as storing one item, the system prevents you from returning a different item to that location. If the WIP location is flagged as storing one item, the system prevents you from issuing a different item to that location.

Pages Used to Process Kit Issues and Returns

Page Name	Definition Name	Usage
Kit Issue/Return Summary Page	SF_KIT_ISSUE_HDR	Issue additional kit components to production and return excess or defective components back to stock. You must define a production ID with at least one component using the kit issue method.
Kit Issue/Return Location Page	SF_KIT_ISSUE_EXPR	Indicate where you want to return kit components.
Kit Issue/Return Detail Page	SF_KIT_ISSUE_DET	Edit additional kit components details.
Directed Putaway Locations Page	IN_PTWY_LOC	(Optional) Use directed putaway rules for the component that you're returning to inventory. If directed putaway is not activated on the Putaway Rules page in PeopleSoft Inventory, the Directed Putaway link is unavailable.
Lot/Serial Number Selection Page	SF_SERIAL_WRK	Indicate the lot ID and serial numbers of the components to be issued or returned.

Page Name	Definition Name	Usage
<u>Issue/Return Kit Components Page</u>	SF_KIT_ISSUE_DET	Edit or view detailed information for each component on the component list.

Related Links

- “Inventory Options Page” (PeopleSoft Inventory)
- “Setting Up PeopleSoft Inventory Structure Tables” (PeopleSoft Inventory)
- “Defining Items at the Business Unit Level” (PeopleSoft Managing Items)

Common Elements Used in This Section

Field or Control	Description
Prdn Start Qty (production start quantity)	The quantity required at the beginning of the operation sequence or production process. This quantity is rounded up to account for any operation yield.
Prdn End Qty (production end quantity)	The quantity expected at the end of the operation sequence or production process. This quantity is rounded down to account for any operation yield.



Kit Issue/Return Summary Page

Use the Kit Issue/Return Summary page (SF_KIT_ISSUE_HDR) to issue additional kit components to production and return excess or defective components back to stock.

Navigation:

Production Control > Process Production > Issue Materials > Issue/Return Kit Components > Kit Issue/Return Summary

This example illustrates the fields and controls on the Kit Issue/Return Summary page. You can find definitions for the fields and controls later on this page.

Field or Control	Description
Print at Save	Select to print production documents for a particular production ID at save time.
Setup Print Options	Click to access the Process/Output Options page to select different print criteria for the production documents.
	Click the Issue/Return Location button to access the Issue/Return Location page to select a specific location to which you want to return the kit components.
	Click the Detail button to access the Kit/Issue Return Detail page to view additional component details.
Component ID	<p>Displays all components used to manufacture the end item that are issued to production using the Kit method. Each component ID is a valid item ID for the business unit.</p> <p>For regular production, the system displays the components in effect for the end item at the due date of production or for the item revision if one is specified. For rework production, the end item is the only component listed unless the item has a rework BOM or you have previously maintained the component list and added those components necessary to rework the end item. Teardown production is similar to rework in that the end item to be torn down is the only component listed unless you included additional material on the component list.</p> <p>You can change any component to a different item ID, or add a new component or substitute. You cannot change the component ID or operation sequence that it is associated with after any quantity has been issued.</p> <p>For all production types, when adding a new component with item status of <i>Discontinue</i>, you receive a warning message. For regular production, you receive a warning message when adding a component with item status of <i>Hold</i>. In both cases, receiving the warning message does not prevent you from performing the action. For rework and teardown, components with item status of <i>Hold</i> are issued.</p> <p>For regular production, you cannot add the end item as a component. For rework production, you cannot delete the reworked end item from its component list. For teardown production, you cannot delete the end item to be torn down from its component list. Duplicate components can exist as long as the operation sequence is unique.</p> <hr/> <p>Note: Consigned kit components can be issued from both owned and non-owned WIP storage locations. However, consigned kit components are returned to owned WIP locations only.</p> <hr/>

Field or Control	Description
	<p>Click the Item Search button to access one of these pages.</p> <ul style="list-style-type: none"> • Item Search: To search for the item ID using various search criteria. • Item Availability: To determine whether the item you want to use is available. • Item Substitution: To display substitutes.
Pending Issue Quantity	<p>Enter the additional amount to be issued for each component as a pending issue quantity. If you've added a new component, enter the amount of the new component that will be issued. If you're returning components, enter the amount as a negative quantity. The system allows only quantities up to the component list issue quantity to be returned. You cannot process returns for components that do not exist on the component list.</p>
Pending Yield Loss Quantity	<p>If a certain number of the components were lost either during the issue process or during production, enter that amount in the pending yield loss quantity.</p>

Note: If you have enabled PeopleSoft Workflow, the system uses the Replenishment Notification workflow to notify the production supervisor (or other defined role) that there is a non-zero quantity in the pending issue field of a component.

Adding Components

You can add components to a component list.

To add components to the component list:

1. Click the **Add** button and select the component ID.
2. Select the operation sequence at which the component is used, and indicate whether the component quantity is per assembly or per order.

The operation sequence is 0 by default. Change the operation to indicate where the component is used.

3. Enter the pending issue quantity and any pending yield loss quantity.

Note: For teardown and rework production, the system suggests that you issue the end item to be torn down or reworked from a non-nettable location, but you can issue from any location.

4. Click **Save** to save the changes.

Related Links

[PeopleSoft Manufacturing Reports: A to Z](#)

“Checking Item Availability” (PeopleSoft Inventory)
 Item Substitution Page
 Delivered Workflows for PeopleSoft Manufacturing

Kit Issue/Return Location Page

Use the Kit Issue/Return Location page (SF_KIT_ISSUE_EXPR) to indicate where you want to return kit components.

Navigation:

Production Control > Process Production > Issue Materials > Issue/Return Kit Components > Kit Issue/Return Location

This example illustrates the fields and controls on the Kit Issue/Return Location page. You can find definitions for the fields and controls later on this page.

Field or Control	Description
Issue Qty Total (issue quantity total)	Displays the total quantity to be issued.
Non-Owned	Indicates if the component is either non-owned or consigned. You can issue additional configured, kit components from both owned and non-owned WIP storage locations.
Storage Area	Select a value to indicate the storage area.

Field or Control	Description
	<p>Click the Storage Location Search button to select a different storage location.</p> <p>If you're returning a component to inventory and you do not want to use the default putaway location, you can use directed putaway to determine the component's putaway location. The system suggests putaway locations that meet the predefined rules for directed putaway. For example, you might want to put away items in zones or based on available space or weight constraints. You can override the system-suggested storage location if necessary.</p> <hr/> <p>Note: Consigned kit components must be returned to owned storage locations.</p>
Container ID	<p>Specify the container if you want to move the quantity to or from a container. If a container is specified and the container exists in a storage area, the system displays the storage location for the container. If the container doesn't exist in a location or if a container is not specified, enter the storage area from which the components are issued or to which they will be returned.</p>
Quantity	<p>Enter the issue or return quantity. If you're returning components, enter the quantity to be returned as a negative number. To issue components, enter the quantity to be issued as a positive number.</p>

Selecting Directed Putaway Locations

Click the **Directed Putaway** link on the Kit Issue/Return location page to use directed putaway rules for the component that you're returning to inventory.

Note: If directed putaway is not activated on the Putaway Rules page in PeopleSoft Inventory, the **Directed Putaway** link is unavailable.

If more than one option meets the putaway rules, the system displays all options. Use the check boxes to select a location. The system suggests a storage area, including storage levels such as *Aisle Level 1*, *Level 2*, *Level 3*, and *Level 4*, that have been defined.

You also indicate the putaway rule, whether or not to mix stage dates or lots, and whether or not it's the default rule on the Putaway Rules page.

Capacity Checking and Directed Putaway

For kit returns, if you designate a storage location as storing only one item on the Volume/Weight Capacity page (accessible from the Material Storage Locations page), the system only puts away material with that item ID in the location. If you do not specify an item ID for a single-item storage location, the first putaway transaction to the empty storage location defines the only item ID that the location can contain until the item quantity has been fully depleted. If the storage location is flagged as storing one item, the system prevents you from returning a different item to that location.

Related Links

- “Defining Serial Control and Shipping Serial Control” (PeopleSoft Inventory)
- “Establishing a PeopleSoft Inventory Business Unit Structure” (PeopleSoft Inventory)
- “Understanding Receiving and Putaway Processing” (PeopleSoft Inventory)

Issue/Return Kit Components Page

Use the Issue/Return Kit Components page (SF_KIT_ISSUE_DET) to edit or view detailed information for each component on the component list.

Navigation:

Production Control > Process Production > Issue Materials > Issue/Return Kit Components > Kit Issue/Return Detail

<i>Field or Control</i>	<i>Description</i>
Serial IDs	<p>If you are issuing additional serial-controlled components, this page displays the serial numbers of the components in the storage location. If you're returning components, the page displays the serial IDs that were already issued to the production ID.</p> <p>If you are returning components on a production ID that has the Serial in Production option selected but the components are not serial-controlled, you must select a serial ID when prompted. The system disassociates the component from the assembly serial ID when you save the page.</p> <p>If you are returning components on a rework or teardown production ID that has the Serial in Production option selected, you must select a serial ID when prompted. The system disassociates the component from the assembly serial ID when you save the page.</p>
Sel (select)	<p>Select the serial-numbered components that you want to issue or return by selecting one or more check boxes.</p> <p>If you're issuing additional serial-controlled, consigned kit issue components, you can pick from <i>both</i> owned and non-owned WIP storage locations.</p> <p>If you're returning serial controlled, consigned kit issue components, you can only select the component's owned WIP storage locations.</p>
Lot ID	<p>The component's lot number indicates if the item is both serial- and lot-controlled. Otherwise, the default value is <i>NONE</i>.</p>
Issue Quantity	<p>Indicates the display-only issue quantity for serial-controlled items. It should always be <i>1.0000</i> for items with serial numbers.</p>

<i>Field or Control</i>	<i>Description</i>
OK	Click to accept the selections and to return to the Kit Issue/Return Location page. The lot and serial numbers that you selected appear on the Kit Issue/Return Location page.

Lot/Serial Number Selection Page

Use the Lot/Serial Number Selection page (SF_SERIAL_WRK) to indicate the lot ID and serial numbers of the components to be issued or returned.

Navigation:

Production Control > Process Production > Issue Materials > Issue/Return Kit Components > Kit Issue/Return Location

Click the **Select Lot/Serial** link.

<i>Field or Control</i>	<i>Description</i>
Lot ID	<p>If you're issuing components, this page displays the lot associated with the storage location. If you're returning components, the page displays the lot IDs for the components that were already issued to the production ID.</p> <p>If you're issuing additional lot-controlled, consigned kit issue components, you can pick from both owned and non-owned WIP storage locations.</p> <p>If you're returning lot-controlled, consigned kit issue components, you can only select the component's owned WIP storage locations.</p> <p>If an assembly item's Serial in Prdn option is selected and you are returning a lot-controlled component, the system disassociates the lot component from the assembly serial ID when you save the page.</p>
Issue Quantity	Specify the quantity of components that you want to issue or return from each lot.
OK	Click to accept the selections and to return to the Kit Issue/Return Location page. The lot and serial numbers that you selected appear on the Kit Issue/Return Location page.

Kit Issue/Return Detail Page

Use the Kit Issue/Return Detail page (SF_KIT_ISSUE_DET) to edit additional kit components details.

Navigation:

Production Control > Process Production > Issue Materials > Issue/Return Kit Components > Kit Issue/Return Detail

<i>Field or Control</i>	<i>Description</i>
Pending Issue Qty (pending issue quantity) and Pending Yield Loss Qty (pending yield loss quantity)	Although these values appear by default from the Kit Issue/Return Summary page, you can change the quantities here.
Issue Qty (issue quantity)	Displays the quantity issued from the storage location and charged to work in process.
Yield Loss Qty (yield loss quantity)	<p>Displays the component quantity that was scrapped during end item completion or lost during the issuing process.</p> <hr/> <p>Note: If you're issuing additional material and the storage location doesn't have sufficient unreserved quantity but the business unit is set up to allow negative quantity and to notify you when it is driven negative, the system will display a warning. If you continue, the location's quantity on hand is decremented and the issue quantity for the component is updated when you save the page.</p> <hr/>

Processing Component De-Kits

If you need to return a complete kit to stock or reverse all kit transactions for a production ID, use the Component De-Kit component.

Note: You cannot de-kit production IDs if completions, scrap, or actual labor times have been recorded.

Note: If you are de-kitting a production ID that is traced by serial genealogy, the components associated with the production ID are automatically disassociated during the de-kit process.

Page Used to Process Component De-Kits

<i>Page Name</i>	<i>Definition Name</i>	<i>Usage</i>
<u>Component De-Kit Selection Page</u>	RUN_SFS6003	<p>Return a complete kit to stock, or to reverse all kit transactions for a production ID.</p> <p>You can only de-kit a production ID with an <i>In Process</i> production status.</p>

Component De-Kit Selection Page

Use the Component De-Kit Selection page (RUN_SFS6003) to return a complete kit to stock, or to reverse all kit transactions for a production ID.

Navigation:

Production Control > Process Production > Issue Materials > De-Kit Components

Field or Control	Description
Return to Location and Default Putaway Location	<p>The defaults for these fields appear. The components are returned to their default putaway location if one has been previously defined.</p> <p>If you want to return the kit to a specific location, the location fields become available. If you're returning both owned and non-owned inventory (including consigned items), you must specify a owned components location as well as a non-owned components location. When a specific location is selected, all components are returned to the location specified. Consigned items are returned to an owned location.</p> <p>If you're returning lot or serial-controlled, consigned kit issue components, you can select only the component's owned WIP storage locations.</p> <hr/> <p>Note: All components with item status of <i>Hold</i> can be returned to inventory.</p> <hr/>
Directed Putaway	<p>Select this option if you're using directed putaway to select a location.</p>
Storage Area	<p>The system displays the number of storage levels, such as <i>Aisle Level 1 Level 2, Level 3, and Level 4</i> that have been defined for each storage area.</p>
Run	<p>Click to run this request. Process Scheduler runs the Component De-kit process (SFS6003) at user-defined intervals.</p> <p>Once the process runs, the production ID's status is changed back to <i>Released</i> as long as no other components have been issued with issue methods of issue or replenish.</p>

Capacity Checking and De-Kitting Components

If capacity checking is activated, the system updates the location's capacity balances when de-kitting components.

For kit returns, if you designate a storage location as storing only one item on the Volume/Weight Capacity page (accessible from the Material Storage Locations page), the system only puts away material with that item ID in the location. If you do not specify an item ID for a single-item storage location, the first putaway transaction to the empty storage location defines the only item ID that the location can contain until the item quantity has been fully depleted. If the storage location is flagged as storing one item, the system prevents you from returning a different item to that location.

Related Links

“Defining Serial Control and Shipping Serial Control” (PeopleSoft Inventory)

“Establishing a PeopleSoft Inventory Business Unit Structure” (PeopleSoft Inventory)

“Understanding Receiving and Putaway Processing” (PeopleSoft Inventory)

Issuing Material Using Electronic Data Collection

PeopleSoft Manufacturing enables you to use both the picking plan and the kit issues and returns processes with an electronic data collection system. You can access electronic data collection transactions through the SCM Integrations navigation, and you can process them using electronic data collection hardware.

When you save an electronic data collection transaction page, the page clears so that you can enter another transaction immediately. The transaction is saved in the transaction log until it is processed by background processes that continually scan the transaction log. Only selected pieces of information have edits to verify the data that is entered with electronic data collection transaction pages. The background processes validate all information before any updates are performed.

PeopleSoft Manufacturing provides the Production Picking EIP (PRODUCTION_PICKING) to import picking information from third-party systems.

Page Used to Issue Material Using Electronic Data Collection

<i>Page Name</i>	<i>Definition Name</i>	<i>Usage</i>
Production Picking Page	BCT_MG_PIK	Import picking information from third-party systems by using the Production Picking EIP.

Related Links

“Understanding Receiving and Putaway Processing” (PeopleSoft Inventory)

[PeopleSoft Manufacturing Integrations](#)

Processing Picking Plans Using Electronic Data Collection

You can use electronic data collection to run picking plans.

To run picking plans using electronic data collection:

1. Create a picking plan.

The picking plan can be either a paper report or alternatively, the download of the pick plan in the form of an extract file. If an extract file is created, it may be downloaded to the data collection device and used instead of a paper pick plan. You have the option to create an extract file when you request the picking plan.

2. Run the pick plan, which is performed by going to the physical warehouse and collecting the items and recording the pick information.

This step is performed using a hand held device, such as a Radio Frequency (RF) device or a batch data collector. If you use a pick plan extract file, the data collection activity has the advantage of electronically comparing the picker's input against the desired pick plan for immediate validation and correction. In a paper-based system, you manually record the pick plan feedback using a RF device. Another option is to enter the data at periodic intervals using a stationary workstation equipped with a wedge.

PeopleSoft Manufacturing production picking is based on the assumption that the warehouse already has the required bar code labels in place (such as item labels, storage location, bin, carton, and package labels) to facilitate the data collection. Various bar code labels are available through the PeopleSoft Inventory label generation process.

When a pick batch is complete, or at designated time intervals, the collected data is transferred to the main system to be processed and updated in the database. Any line transferred and residing in the bar code transaction log is available for processing.

The Production Pick Location process moves components to production from a storage location or container as per pick plan requirements. You can enter transactions using a bar code wedge reader or manually.

You can run these electronic data collection transactions using the Production Picking component:

- M301 - Production Pick Location
- M302 - Production Pick Line Complete
- M303 - Production Pick Batch Complete

Note: If your environment includes inventory transfer transactions from electronic data collection systems, such as keyboard wedges or the Inventory Transfer EIP, then you should verify that the Inventory Transfers process (IN_TRANSFER) has been run before processing any production picking transactions. Processing your picking data before the completion of any pending bin-to-bin transfer transactions can drive quantity in the material storage location negative and generate errors.

See “Transferring Materials Using the Inventory Transfer EIP” (PeopleSoft Inventory).

Pages Used to Process Picking Plans Using Electronic Data Collection

<i>Page Name</i>	<i>Definition Name</i>	<i>Usage</i>
<u>Production Picking Page</u>	BCT_MG_PIK	Run the Production Picking data collection process on transactions.

Page Name	Definition Name	Usage
<u>Production Picking Page</u>	BCT_MG_REQPICK	Continuously scan and process the electronic data collection transaction log as long as there are picking transactions in the log. There must be outstanding pick transactions in the electronic data collection transaction log.

Production Picking Page

Use the Production Picking page (BCT_MG_PIK) to run the Production Picking data collection process on transactions.

Navigation:

SCM Integrations > Create Transactions > Manufacturing > Create Mfg Pick Txn

Field or Control	Description
Pick Batch ID	Select a pick batch.
Pick Line	If you're using transaction M301 or M302, enter a value.

Field or Control	Description
Complete Flag	<p>Select a processing option. Values are:</p> <ul style="list-style-type: none"> • <i>Process Location</i>: Processes the entered values for the pick line location, and closes the pick line location against further transactions. Subsequent pick transactions can be entered for the pick batch. This value is used for transaction M301 • <i>Process Location - Incomplete</i>: Processes the entered values for the pick line location, and will allow for additional pick transactions for this same pick line location. This value is used for transaction M301. • <i>Pick Line Complete</i>: Processes the values for the current transactions and then closes the pick line against further transactions, clearing any remaining quantities for that line. This value is used for transaction M301. • <i>Pick Batch Complete</i>: Processes the values for the current transaction before shutting the entire pick batch to subsequent transactions. All remaining quantities for the batch are cleared. • <i>Pick Line as Planned</i>: Processes any values for the current transaction and then accept the quantities at the other locations for this line as reserved or designated on the pick plan. The line is then closed against further transactions. This completion level is appropriate for PUSH pick plans. This value is used for transactions M301 and M302. • <i>Pick Batch as Planned</i>: Processes any values for the current transaction and then accept the quantities for all other lines and locations for this batch as reserved or designated on the pick plan. The batch is then closed against further transactions. This completion level is appropriate for PUSH pick plans.
Component ID	<p>This field is used for transaction M301. If you're using the issue method and as long as valid substitutes exist, substitutions can be made. If the issue method is kit and the component has previously been picked, substitutions cannot be made and the field is unavailable.</p>
Quantity and Storage Loc (storage location)	<p>This field is used for transaction M301. Enter values for these fields.</p> <p>The system displays the number of storage levels that have been defined for each storage location.</p>

Field or Control	Description
	<p>Click the Storage Location Search button to select a different storage location.</p> <p>If you're issuing consigned kit issue components, including lot and serial-controlled components, you can pick from both owned and non-owned WIP storage locations.</p>
Container ID	Enter the value if you're picking the item from a container.
Lot ID or Serial ID	<p>Enter values if applicable.</p> <p>If you are capturing rework or teardown production IDs that are using serial genealogy, keep these points in mind:</p> <ul style="list-style-type: none"> • If the assembly is serial-controlled and the Serial in Production option is selected and the component being issued is the assembly item, then you must enter a serial ID when prompted. • If the assembly is not serial-controlled but the Serial in Production option is selected, then you must enter a serial ID when prompted. <p>See Processing Kit Issues and Returns.</p>

Related Links

[Creating and Processing Picking Plans](#)

Production Picking Page

Use the Production Picking page (BCT_MG_REQPICK) to continuously scan and process the electronic data collection transaction log as long as there are picking transactions in the log.

Navigation:

SCM Integrations > Process Transactions > Manufacturing > Process Mfg Pick Plan

Note: If no pick transactions exist in the log when a process scans the log, the process terminates and can be restarted by the Process Scheduler. Use the Process Scheduler with the background process to ensure that it runs continuously.

Field or Control	Description
Process Frequency	Because the background processes for electronic data collection run continuously and you use the Process Scheduler to restart the background processes, this value should be set to Always .

Field or Control	Description
Run	<p>Click to run this request at user-defined intervals. Select one of these processes:</p> <ul style="list-style-type: none"> • <i>Production Picking Process (SFPEPICK)</i> • <i>Pick Process and Matl Release (SFPIKREL)</i>

Processing Kit Issues and Returns Using Electronic Data Collection

You can use electronic data collection to process kit issues and returns.

You can process kit issues and returns for these electronic data collection transactions:

- 060A - Kit Issue to Production
- 060R - Kit Return from Production
- 060S - Kit Issue Substitute to Prdn

Pages Used to Process Kit Issues and Returns Using Electronic Data Collection

Page Name	Definition Name	Usage
<u>Kit Issue/Return Page</u>	BCT_MG_MIS	Enter issue or return transactions for kit components using electronic data collection.
<u>Kit Issue/Return background process Page</u>	BCT_MG_REQMISC	<p>Continuously scan the electronic data collection transaction log as long as there are kit issue or return transactions in the log.</p> <p>There must be transactions in the electronic data collection transaction log.</p>

Related Links

“Inventory Definition - Business Unit Definition Page” (PeopleSoft Inventory)

“Define Item - Inventory: Shipping/Handling Page” (PeopleSoft Managing Items)

Kit Issue/Return Page

Use the Kit Issue/Return page (BCT_MG_MIS) to enter issue or return transactions for kit components using electronic data collection.

Navigation:

SCM Integrations > Create Transactions > Manufacturing > Kit Issues>Returns > Kit Issue/Return

Field or Control	Description
Component ID	Enter the value of the component to be issued, returned, or substituted.
Sub Item (substitute item)	If you're substituting a component using transaction 060S, enter a value.
Quantity and Yield Loss Qty	Enter values to be issued, returned or substituted. These values must be positive numbers, even if you're returning material.
Container ID or Storage Area	Enter the location from which you issued the material.
	Click the Storage Location Search button to select a different storage location. If you're issuing consigned kit issue components, including lot and serial-controlled components, you can pick from both owned and non-owned WIP storage locations.
Serial ID or Lot ID	The system displays the values, if applicable. See Processing Kit Issues and Returns .
Quantity	This value is display-only for serial-controlled items.

Note: The format for several quantity fields on this page may be determined by the item's unit of measure and quantity precision combination that is defined in PeopleSoft Inventory.

Kit Issue/Return background process Page

Use the Kit Issue/Return background process page (BCT_MG_REQMISC) to continuously scan the electronic data collection transaction log as long as there are kit issue or return transactions in the log.

Navigation:

SCM Integrations > Process Transactions > Manufacturing > Process Kit Transactions

Important! If no transactions are in the log when a process scans the log, the process terminates. It can be restarted by the Process Scheduler. Use the Process Scheduler with the background process to ensure that it runs continuously.

Field or Control	Description
Process Frequency	Because the background processes for electronic data collection run continuously and you use the Process Scheduler to restart the background processes, this value should be set to Always .
Run	Click to run this request. Process Scheduler runs the Production Misc Issues>Returns process (SPPFMISC) at user-defined intervals.

Completing Operations and Recording Scrap

Understanding Recording Completions and Scrap

Within a manufacturing enterprise, you need to track end items as they make their way through the production area. With PeopleSoft Manufacturing, you can manage production by orders, repetitive schedules, backflushing, or creating a schedule to record completions and scrap after you have completed production. Subcontracted operations are fully supported. You can assign serial and lot numbers to completed end items and complete end items to containers while moving them to inventory or to another production area. While recording completed operations, the system accumulates manufacturing costs and variances. You can also record actual machine and labor hours for each production order or production schedule.

PeopleSoft Manufacturing tracks the serial genealogy of production. This enables you to trace the movement of a specific serialized assembly and its components throughout the manufacturing process.

Note: During completions, you can choose from serial IDs previously associated with a production ID, or you can enter a new serial ID for which the system automatically creates the serial association. Additionally, lot auto numbering only applies to configured orders.

PeopleSoft Manufacturing tracks the costs of material, labor, outside processing, and machines used to manufacture a product and manages the transactions necessary to report and track the status of a particular order or schedule by day and shift. The system supports these order types:

- Production IDs for regular, rework, or teardown production.
- Production schedules for tracking regular production by day and shift.

If you're recording completions and scrap for a production ID with subcontracted operations, you record the operation completions for the subcontracted operations slightly differently than for in-house production.

You can also record completions and scrap using electronic data collection.

See [Understanding the Process of Recording Completions and Scrap Using Electronic Data Collection](#).

Recording Completions with Multiple Outputs

You can also record completions and scrap for production IDs and production schedules that have multiple outputs. Multiple outputs consist of:

Term	Definition
primary items	The main outputs from the manufacturing process.
co-products	Items, along with the primary item, that are planned for and produced as part of the manufacturing process. Co-products share the cost of the process; there may be independent demand in planning for the primary item.
by-products	Items that can be either waste by-products, which need to be disposed, or recycle by-products, which can be used as inputs to other processes. By-products are incidental to the process and have either a relief (negative) cost for recycle by-products or a disposal (positive) cost for waste by-products. There is typically not independent demand for by-products.

Expected Output When Using Yield by Operation

The system recalculates the expected output quantities when over-completions or over-scrap are performed. Over-scrap is when the scrap quantity exceeds the expected scrap, based on the operation yield. For example, the system recalculates a new output quantity if the actual scrap quantity exceeds the expected scrap quantity at an operation.

Transferring Completions Data to PeopleSoft Quality

If your installation includes PeopleSoft Quality, and you have defined quality configuration information and quality plans in PeopleSoft Quality for a manufactured item and its process, then the Quality link is active on the Record Completions/Scrap page. You click this link to transfer to PeopleSoft Quality to initiate a data entry session to record quality control information for the manufacturing process.

Completions Actions and Effects to Quantities on Hand

This table lists the results of completions actions:

Completions Action	Results
Recording positive completions	<p>Decreases the business unit's on-hand quantity of the components, and increases the business unit's on-hand quantity of the completed end item.</p> <p>Decreases the storage location's quantity for the components, and increases the storage location's quantity for the completed end item.</p> <p>Decreases the lot quantity on-hand for lot-controlled components and increases the lot quantity on-hand for the completed end item, if it is lot-controlled.</p>

Completions Action	Results
Recording negative completions	<p>Increases the business unit's on-hand quantity of the components, and decreases the business unit's on-hand quantity of the end item.</p> <p>Increases the storage location's quantity for the components, and decreases the storage location's quantity for the end item.</p> <p>Increases the lot quantity on-hand for lot-controlled components and decreases the lot quantity on-hand for the end item, if it is lot-controlled.</p>
Recording completions to a non-WIP, nettable location	Increases the business unit's quantity available for the completed end item.
Recording negative completions to a non-WIP, nettable location	Decreases the business unit's quantity available for the end item, if the end item comes from a nettable, available, non-WIP location.
Recording positive completions to a nettable, available WIP location	Increases a business unit's quantity reserved for the completed end item.
Recording negative completions from a nettable, available WIP location	<p>Decreases a business unit's quantity reserved for the end item.</p> <p>Decreases the lot quantity available for the completed end item.</p>

Related Links

[“Understanding the Quality Data Collection Process” \(PeopleSoft Quality\)](#)

[Understanding Subcontracting Using PeopleSoft Manufacturing](#)

[Understanding BOM Maintenance](#)

Manage Production Using Discrete Orders

You can manage discrete orders for regular, rework, or teardown production by creating production IDs for each production quantity that you want to track. Once you've created the production ID, you release production, and then either generate pick lists to issue material to production or maintain a maximum quantity on hand for components in a WIP location.

Once production begins on the shop floor, perform the following steps. These steps assume that all operations are performed in-house and none of the operations are subcontracted.

To record completions and scrap for in-house production IDs:

1. Indicate whether the business unit will record completions and scrap production IDs using the online or deferred method by selecting the PID Completion option on the MFG BU Prdn Options page. Select one of these:

- a. **Online:** The background process calculates the associated production costs (such as earned labor and machine hours) and overhead conversion costs and consumes material utilizing the issue or replenishment issue methods.

- b. **Deferred:** This option indicates that you're running the completions process at a later time.

All associated production costs are calculated when the completions update background process is run. You must run the Prdn Compl/Scrap process (production completions and scrap process) if you select this option.

2. Record completions and scrap quantities for in-house production using the Record Completions/Scrap page.

Record completions by operation, by count point, or for the entire production quantity, or perform a partial backflush of completed end items.

3. (Optional) If you're completing a production ID with multiple outputs, the Outputs Detail area appears.

You can complete planned or unplanned by-products at any operation. Scrapped end items are recorded at the batch level, but not for each output. You must record completions and scrap for primary items and co-products at the last operation.

4. (Optional) Change component information using the Edit/Issue Components page.
5. (Optional) Transfer completions data to PeopleSoft Quality by clicking the Quality link.
6. (Optional) If you're using serial in production or serial- or lot-controlled items, and the components are issued to production using the Replenish or Issue method, select the serialized components or lots from which to consume the components.
 - a. Automatically generate serial numbers by using the Rapid Serial Numbers page.
 - b. Access the Edit/Issue Express page, or click the button next to the serial- or lot-controlled component on the Edit/Issue Components Summary page. For lot-controlled components you can use the backflush lot selection rule to automatically select lot IDs during backflush. For more information on the backflush lot selection rule, see the "Automatically Consuming Lot-Controlled Stock During a Backflush" section of this topic.
 - c. Use the **Route-To PID/Stor Locations** (route to production ID and storage locations) scroll area on the Record Completions/Scrap page to assign a lot if the completed end item is lot-controlled.

Note: You can move end items to an existing lot or create a new lot.

7. Move completed end items out of production.

You may route them to a production ID, to another production area for further processing, or to a stores inventory location. You cannot route waste by-products.

- a. (Optional) Click the Apply Defaults link to route the end items to a default putaway location.

Note: The completions process puts away items in their standard units of measure (UOM).

- b. (Optional) Select an alternate putaway location.

Note: If you're routing the end item to another production ID, the putaway process is not required.

- c. If you are using serial genealogy, you must perform completions at the last operation.

In addition, select the serial number for the appropriate assembly.

8. (Optional) Run the Completions Update process.

You run this process to update completions transactions that are staged by other processes, such as Edit Components updates, production completions, or subcontracted completions recorded through electronic data collection.

9. (Optional) Make reversing entries to correct data entry errors.

You can return components to their original storage location or to an alternate location. If you're returning lot- or serial-controlled components, you must select the serial IDs or lot IDs from which the components were originally consumed.

10. (Optional) Move excess components out of WIP locations using the Maintain Inventory navigation.

You can move these components to another production area or back to a stores inventory location. You can also move excess components from the production ID using the Kit issues transactions. Kit issue transactions are used for components whose issue method is Kit.

11. Record actual labor and machine hours.

12. Indicate that production is complete by using the Complete Production page.

Manage Production by Day and Shift (Production Schedules)

PeopleSoft Manufacturing generates a schedule for processing by day and shift for regular production by:

- Creating a production schedule as part of the supply planning process.
- Creating a production schedule at the end of a production run.

Note: Production schedules support in-house production only. If you have subcontracted operations on a routing, you must use a production ID to track production.

Once you've created the production schedule, you release production, and then either generate pick lists to issue material to production or maintain a maximum quantity on hand for components in a WIP location.

If a production schedule has not been created, you can still record completions. At that time, the system prompts you to automatically add the production quantity to the schedule.

To record completions and scrap for production schedules:

1. Record completions and scrap quantities for production schedules using the Record Completions/Scrap page.

Record completions and scrap for the entire production quantity, or perform a partial backflush of completed end items. You can record completions for production schedules with multiple outputs. However, all multiple outputs and scrap must be completed at the last operation.

Note: If a schedule for the production date and shift has not been created when recording end item completions and scrap, the system creates a production schedule and releases production.

2. (Optional) If you're completing a production schedule with multiple outputs, the Outputs Detail area appears.

You can add unplanned by-products. Scrapped end items are recorded at the batch level, but not for each output.

3. (Optional) Change component information using the Edit/Issue Components page.
4. (Optional) Transfer completions data to PeopleSoft Quality by clicking the Quality link.
5. (Optional) If you're using serial- or lot-controlled items, and the components are issued to production using the Replenish or Issue method, you must select the serialized components or lots from which to consume the components.
 - a. Automatically generate serial numbers by using the Rapid Serial Numbers page.
 - b. Access the Edit/Issue Express page, or click the button next to the serial- or lot-controlled component on the Edit/Issue Components Summary page. For lot-controlled components you can use the backflush lot selection rule to automatically select lot IDs during backflush. For more information on the backflush lot selection rule, see the "Automatically Consuming Lot-Controlled Stock During a Backflush" section of this topic.
 - c. Use the **Route-To PID/Stor Locations** scroll area on the Record Completions/Scrap page to assign a lot if the completed end item is lot-controlled.

Note: You can move end items to an existing lot or create a new lot.

6. Move completed end items out of production.

You may route them to a production ID, to another production area for further processing, or to a stores inventory location. You cannot route waste by-products.

- a. (Optional) Click the Apply Defaults link to route the end items to a default putaway location.

Note: The completions process puts away items in their standard UOMs.

- b. (Optional) Select an alternate putaway location.

Note: If you're routing the end item to another production ID, the putaway process is not required.

7. (Optional) Run the Completions Update process.

You run this process to update completions transactions that are staged by other processes, such as Edit Components updates, production completions, or subcontracted completions recorded through electronic data collection.

8. (Optional) Make reversing entries to correct data entry errors.

You can return components to their original storage location or to an alternate location. If you're returning lot- or serial-controlled components, you must select the serial IDs or lot IDs from which the components were originally consumed.

9. (Optional) Move excess components out of WIP locations using the Maintain Inventory navigation.

You can move these components to another production area or back to a stores inventory location.

10. Record actual labor and machine hours.

11. Run the Close Production SQR process to indicate that the production schedules are complete.

Automatically Consuming Lot-Controlled Stock During a Backflush

Backflush is a method of consuming components for a production ID or production schedule. The system backflushes components with an issue method of *Issue* or *Replenish*. Typically, backflushing occurs when completion or scrap quantity is entered for an assembly. Backflushing consumes material from the WIP locations.

When consuming lot-controlled components, the backflushing process must decide which lot IDs to choose within the WIP location. The backflush lot selection rule enables you to determine which lot IDs are automatically selected for consumption when a backflush is performed. The backflush lot selection rule can be defined at:

- The business unit-level using the MFG BU Prnd Options page. The options for the backflush lot selection rule are located in the Backflush Lot Option group box and include:
 - *Manual*:(default) Select this option to require the user to enter the specific lot IDs consumed during backflushing. The system does not automatically select any lot IDs.
 - *Earliest Expiration Date*: Select this option to have the system select the lot IDs for consumption based on the lot expiration date. The system first selects the lots with the earliest expiration dates.
 - *Earliest Available Date*: Select this option to have the system select the lot IDs for consumption based on the available date. The system first selects the lots with the earliest available dates.
- The business unit and item-level using the Define Business Unit Item - Manufacturing: General page. The options for the backflush lot selection rule are located in the Backflush Lot Option group box and include:
 - *Default from BU*: (default) Select to use the backflush lot selection rule defined at the manufacturing business unit level on the MFG BU Prnd Options page.
 - *Manual*
 - *Earliest Expiration Date*

- *Earliest Available Date*

The backflush lot selection rule defined at the business unit and item combination (the Define Business Unit Item - Manufacturing: General page) overrides the option selected at the business unit level (the MFG BU Prnd Options page).

See “Define Business Unit Item - Manufacturing: General Page” (PeopleSoft Managing Items).

See [MFG BU Prdn Options Page](#).

How the Backflush Process Uses the Backflush Lot Selection Rule

The backflush lot selection rule is used during the backflush process to determine the lots to consume from each WIP location for lot-controlled components. The Record Completions and Scrap-Edit/Issue Express page is one location where you can see some of the impacted fields:

This example illustrates the fields and controls on the The Record Completions and Scrap-Edit/Issue Express page. You can find definitions for the fields and controls later on this page.

If the backflush lot selection rule is *Manual*, then the backflush process does not default lot IDs. You must manually enter the specific lot IDs and the quantity from each lot for consumed lot-controlled components.

If the backflush lot selection rule is *Earliest Expiration Date* or *Earliest Available Date*, then the backflush process consumes lot-controlled components by choosing the lot IDs and quantities from each lot ID within the WIP locations. The following rules are applied:

- The backflush process does not override an existing lot entry but populates any blank fields or default-value fields.
- The process can select one or more lots. For example, if 15 units are needed, the first 8 units are selected from lot L200, when this lot is exhausted then the last 7 units are selected from lot L500.
- The process consumes lot-controlled stock until the consumed component is satisfied or the existing stock in the WIP location is exhausted. If there is not enough lot quantity in the WIP location, then the process leaves the remaining quantity in the pending issue quantity and pending loss quantity, as appropriate.
- If the rule finds multiple lots in the WIP location that could be used, then the first tiebreaker is the opposite date (that is, the *Earliest Expiration Date* rule uses the earliest available date and the *Earliest Available Date* rule uses the earliest expiration date). If there still are multiple lots, then the next tiebreaker is the ascending lot ID value.

- For consigned items, the process uses the stock in the owned WIP location. If more quantity is needed, then the non-owned WIP location is used.

The backflush lot selection rule cannot be applied to:

- Items that are both lot-controlled and serial-controlled.
- Items using serial genealogy.
- Items that has the component issue method of *Kit*.

For these items, the backflush lot selection rule is set to the value of *Manual*.

Components Impacted by the Backflush Lot Selection Rule

The backflush lot selection rule is applied during backflush and impacts the following components:

- Record Completions and Scrap (Production Control, Process Production, Complete Production, Record Completions and Scrap).
- Edit/Issues Components (Production Control, Process Production, Issue Materials, Edit/Issue Components).
- Receive Subcontract Assembly (Production Control, Process Production, Subcontract Production, Receive Subcontract Assembly).

The above components can be used in online or deferred mode. If you are using the online mode (PID Completion Option on the MFG BU Prdn Options page), the online pages display the results of the backflush lot selection rule; that is, the lot ID and quantity to be consumed from the WIP location. You can view and override the selected lot IDs and quantities. If you are using the deferred mode (PID Completion Option on the MFG BU Prdn Options page), the system does not consume the components until later; however, you can use the online pages to enter override lot IDs and quantities.

Using the online mode, if the backflush process has completed and then a field is changed that causes the pending quantities field to be recalculated, this causes a recalculation of backflush lot selection rule. Fields that trigger the recalculation of the pending quantities include:

- Completion Quantity
- Scrap Quantity
- Completion Op Sequence
- Back thru Op Sequence
- Component ID
- Component's Op Sequence
- Component's Qty Code
- Component's Qty Per
- Picking a substitute item

In addition, entering a pending issue quantity or a pending yield loss quantity when there is no completion or scrap quantity triggers the calculation of the backflush lot selection rule. If the lot consumption fields

have already been populated and then you manually change the pending issue quantity or a pending yield loss quantity, the system displays the following message:

Message Text: Recalculate the Lot IDs to consume (Y/N)?

Explanation: You have modified the pending issue or pending loss quantity for a component that contains values in its lot scroll. Select Yes to clear the lot scroll and repopulate based on the entered quantity - all other occurrences of this component on the component list which share the same WIP location will also have their Lot IDs recalculated. Select No to keep the pending quantity entered without changing the lot scroll - you will then need to modify the lot scroll so that its quantities correspond with the pending quantity entered. Select Cancel to cancel the action - the original pending quantity will be restored and the lot scroll will not be modified.

Using the Production Completions and Scrap Process with the Backflush Lot Selection Rule

Prdn Compl/Scrap (SFPDCDRV) process (Production Completions and Scrap process) can perform a backflush and looks to the backflush lot selection rule to determine the method for the lot consumption from the WIP locations. This Prdn Compl/Scrap process is located in both the SCM Integrations menu (SCM Integrations, Process Transactions, Manufacturing, Process WO Completions) and the Production Control menu (Production Control, Process Production, Complete Production, Process Completions and Scrap). The Production Completions and Scrap process uses data stored in the BCT tables to update the production tables and can record completions and scrap for:

- Electronic data collection files and other EIP messages. The data transactions are stored in the BCT tables.
- Online components using the deferred mode (PID Completion Option on the MFG BU Prdn Options page). The online data entry is stored in the BCT tables.

If you have selected the backflush lot selection rule of *Earliest Expiration Date* or *Earliest Available Date*, then the incoming files are not required to have a lot ID for consumed components. The lot ID is assigned during the Production Completions and Scrap process; therefore, the incoming files are not put in the error status for correction in the Transaction Maintenance component (SCM Integrations, Transaction Error Handling, Maintain Transactions, Transaction Maintenance). If the incoming file does contain some lot IDs for consumed components, then the Prdn Compl/Scrap process uses those entries rather than the backflush lot selection rule. In addition, the incoming files must contain the lot IDs for consumed components if you have selected the backflush lot selection rule of *Manual*.

See [Running the Completions Update COBOL/SQR Process \(SFPDCDRV\)](#).

Setting Up the Backflush Lot Selection Rule

Before changing the backflush lot selection rule in your PeopleSoft system, you should examine the physical movement in your WIP locations to:

- Verify the physical usage of the lot components in the WIP locations match the chosen backflush lot selection rule. For example, if stock with the earlier expiration date is selected first from the WIP location during production, then you should select the *Earliest Expiration Date* option for the backflush lot selection rule.
- Ensure your data movement transactions to and from the WIP locations are accurate and promptly recorded. If you are using data collection systems for material movement or completions and edit

component transactions, the batch jobs that process these transactions must be processed in a timely manner.

- Confirm that you have one primary method for entering completion transactions. If you vary the method used to record completions, (for example; sometimes using data collection completions and sometimes using on-line pages), then the backflush lot selection rule may cause inaccurate results due to timing issues.

Before changing the backflush lot selection rule, it is recommended that you process all pending transactions in the staging tables (BCT tables) that impact production completion. If pending transactions are in the BCT tables, use caution when changing the backflush lot selection rule on the MFG BU Prnd Options page or the Define Business Unit Item - Manufacturing: General page. Changing the rule can impact how the pending transactions are processed.

Integrating PeopleSoft Manufacturing with a Third-Party System

You can integrate PeopleSoft Manufacturing with an electronic data collection system or a Manufacturing Execution System (MES), or both.

Electronic Data Collection

You can use electronic data collection to collect completions and scrap transactions, then import them to PeopleSoft Manufacturing. You can also collect and import actual hours transactions using electronic data collection.

For actual hours, the data collection method employs the same breakout of hour types as the online method such as setup, run, fixed run, and post-production. Electronic data collection allows for individual or crew reporting as well as single or multiple machine reporting.

Use the Actual Hours EIP to import actual hours information from a third-party system.

See [Understanding the Process of Recording Completions and Scrap Using Electronic Data Collection](#).

Manufacturing Execution System (MES)

If you're integrating PeopleSoft Manufacturing to an MES, you can record operations completed, quantity completed, and scrap quantity in the MES. You can then import completion transactions to enable the optimization of production activities from production order launch to completion of finished goods. All production IDs, production schedules, and operations must be recognized in the PeopleSoft system; otherwise the system marks the transactions as errors in transaction maintenance. You then need to make corrections so that the transaction can be processed.

For multiple output transactions, you can record actual outputs in the MES, including completed quantities for co-products and by-products. You must send the completed output quantity if the batch quantity complete is not reported. You can report only unplanned by-products, not unplanned co-products.

You can also report the serial, lot, or container numbers for items produced or consumed in production. If the produced item requires lot, serial, or container details in the PeopleSoft system, the system marks transactions sent without this information as an error in transaction maintenance. For serial-controlled components or components that are both lot and serial-controlled, the serial numbers and lot IDs must be provided to the system or the transaction is marked in error to be corrected in transaction maintenance. For lot-controlled components, the incoming data must contain the lot IDs for consumed components if you have selected the backflush lot selection rule of *Manual*. If you have selected the backflush lot

selection rule of *Earliest Expiration Date* or *Earliest Available Date*, then the incoming files are not required to have a lot ID for consumed components.

You can also report component consumption and communicate it to PeopleSoft Manufacturing using the Production Order Issue EIP. This EIP is a batch subscribe (inbound), asynchronous message.

When you pass component usage from the MES, all component consumption for a production order is sent, regardless of whether the quantity consumed was the default quantity. If components consumed are under serial or lot control, the lot or serial numbers are passed from the MES to update PeopleSoft Inventory. For lot-controlled components, the lot IDs can be automatically added by the Prdn Compl/Scrap (SFPDCDRV) process if you have selected the backflush lot selection rule of *Earliest Expiration Date* or *Earliest Available Date*.

The system validates component consumption transactions coming into the PeopleSoft system to ensure that the production IDs and items are valid in the business unit. The items must be valid for the BOM or as substitutes. If the consumption transaction would drive inventory negative in a business unit where negative inventory is not permitted, the system doesn't process the transaction.

Related Links

[Recording Actual Machine and Labor Hours](#)

[Your Enterprise Data Flow](#)

Common Elements Used in Operations and Recording

<i>Field or Control</i>	<i>Description</i>
Production ID	The production order identifier.
Production Area	The area where the item is being manufactured.
Item ID	The name and description of the item being manufactured.
Op Seq (operation sequence)	The operation step where the item is being completed.
Config Code (configuration code)	A unique identifier for costing and inventory tracking purposes. The configuration code appears if the end item is a configured item.
Status	The current status of the production.
Prdn Type (production type)	The type of production being manufactured. Values are <i>Production</i> , <i>Rework</i> , or <i>Teardown</i> .
Prdn Start Qty (production start quantity)	The beginning quantity being produced for the selected production. The system considers any operation yield.

Field or Control	Description
Prdn End Qty (production end quantity)	The ending quantity being produced for the selected production. The system considers any operation yield.
BOM Code	The BOM priority code used during the production of this item.
Routing Code	The routing priority code used during the production of this item.
Revision code	The default value appears if the item entered is revision-controlled.
Source Cd (source code)	Indicates if the production is <i>Make</i> or <i>Buy</i> .
Quality	<p>Click this link to initiate a data entry session and access either the Data Entry - Subgroup Method page or the Data Entry - Sample Method page in PeopleSoft Quality, depending on the data entry method that you specified when creating the quality control plan. On the Data Entry pages in PeopleSoft Quality, you record quality control information for the manufacturing process for the item and then access the Record Completions/Scrap page.</p> <hr/> <p>Note: The Quality link is available for each end item in the Output Details scroll area. You can transfer completions data to PeopleSoft Quality for each end item.</p> <hr/>

Prerequisites

Before you begin production:

1. Review the production documents, if available, to determine if any of the items are serial- or lot-controlled, or if there are any subcontracted operations.
2. Verify that all items that you'll be manufacturing have been assigned to a production area.
 - If the production item will have multiple outputs, you must define the outputs by using the BOM Maintenance - Outputs page before generating the production ID or production schedule.
 - If you're tracking an item within a production area with production IDs, first generate the production ID for the item that you want to produce.
 - If you're using production schedules, you can predefine the production quantity to be produced for a shift, or you can enter the quantity produced when recording end item completions.
3. Verify that material has been issued directly to the production ID or that the production WIP locations have been stocked with adequate inventory.

Use the Shortage report to identify any potential component shortages before beginning production.

Recording Completed Operations and Scrap for In-House Production IDs

At some point during the in-house production process, you must record completed operations and scrap. Using the Record Completions and Scrap component, you can:

- Record completed operations for all or part of the production quantity.
- Record completions and scrap for the production run with multiple outputs.
- Scrap end items at an operation.
- Backflush the entire production run or order.
- Report completed setup or post production work independent of recording the completion of any end items.
- Automatically consume components based on the quantity completed.
- Automatically complete end items based on the batch completed quantity.
- Manually substitute components where there is a shortage of an item or an item is out of stock.
- Transfer completions data to PeopleSoft Quality, if your installation includes PeopleSoft Quality and you have defined quality configuration information and quality plans in PeopleSoft Quality for the manufactured item and its process.

You record quality control information for the manufacturing process for the end item and then access the Record Completions/Scrap page.

- Assign serial numbers and lot numbers to completed end items before moving them out of the production area.
- Route completed end items to another production ID or WIP location to be used on subsequent end item production.
- Route completed end items (including primary items, co-products, and recycle by-products) to another production ID or WIP location to be used on subsequent end item production.
- Indicate that production has been completed for the production ID.

Note: Primary items and co-products can be completed only at the last operation. By-products, such as recycle or waste, can be completed at any operation.

If you have enabled PeopleSoft Workflow, when you record end item scrap, the system sends notification to selected roles defined by you by using the Assembly PID Scrap Notification workflow. These roles might include a quality manager or a production control manager.

Pages Used to Record Completions and Scrap for In-House Production IDs

<i>Page Name</i>	<i>Definition Name</i>	<i>Usage</i>
<u>Production Selection Page</u>	SF_COMPL_SELECTION	Select a production ID to record completions and scrap. You must define at least one production ID.
<u>Record Completions/Scrap Page</u>	SF_COMPL_ID	Enter completions and scrap information for production IDs. In addition, use this page to move end items for production IDs with a single output or multiple outputs.
<u>Production Scrap Details Page</u>	SF_COMPL_SCRAP	Enter scrap quantities, if applicable.
Apply Defaults Page	SF_COMPL_DEFAULTS	Select the default putaway or alternate storage locations for completed end items.
<u>Rapid Serial Numbers Page</u>	MG_SERIALRG_PG_SBP	(Optional) Automatically generate serial numbers for production end items that are serial-controlled. You must define serial-controlled items in PeopleSoft Inventory.
Work Center Details Page	SF_WORK_CTR_SP	View work center-related information such as WIP locations.
Lot/Serial Number Selection Page	SF_ED_CMP_SBP_GRD	(Optional) Select the serial numbers of the serial-controlled components to be consumed during the completions process. You must enter a pending quantity greater than zero for a serial-controlled component before the Lot/Serial scroll area becomes available.
Lot/Serial Number Selection scroll area Page	SF_ED_CMP_SBP_GRD	(Optional) Identify the lots from which you want to consume lot-controlled components. You must enter a pending quantity greater than zero for a lot-controlled component before the Lot/Serial scroll area is available.

Page Name	Definition Name	Usage
<u>Complete Production Page</u>	SF_COMPL_PRDN	Indicate that production has been completed for a selected production ID.
<u>Production History Page</u>	SF_TRANSHIST	View production transaction history for production IDs.
Transaction History Details (inquiry) Page	SF_TXN_HIST_SP	View production transaction history details based on: <ul style="list-style-type: none"> • Completions Detail • Component Consumption • Operation Detail <u>Production History Page</u>

Understanding the Process of Recording Completions and Scrap for In-House Production IDs

With production IDs, you can:

- Record completions and scrap by operation.
- Record completions and scrap by count points.
- Record partial production completions.
- Complete an entire production ID.
- Move the completed end items to stock, WIP location, or another production ID.

Note: There is no difference between the method that you use to record completed and scrapped end items for regular production and the method that you use for rework production. When recording completions for teardown orders, you report the number of end items torn down. The system calculates the quantity of the teardown end items based on the quantity of the end items being torn down. As is the case with all production types, you can override the teardown quantity for each end item.

Using the Record Completions and Scrap component, you can record in-house operation or end item completions and scrap for production IDs with a status of:

- **Entered** or **Firmed:** The system automatically releases the production ID and the status changes to In Process.

The ability to release a production ID with a status of Entered or Firmed is dependent on the Manufacturing business unit production options for the autorelease of production IDs. When setting up the business unit, you can select Prompt for Auto Release, Auto Release, or No Auto Release.

- **Released:** The system changes the status to *In Process*.

- **In Process.**

Important! If you're using the production issue or production kit material issue method for regular production, you must still issue material to the WIP locations using the Pick Plan and Material Release components. If you're using the production replenishment method, ensure that sufficient inventory exists in the WIP location.

Production Selection Page

Use the Production Selection page (SF_COMPL_SELECTION) to select a production ID to record completions and scrap.

You must define at least one production ID.

Navigation:

Production Control > Process Production > Complete Production > Record Completions and Scrap > Production Selection

<i>Field or Control</i>	<i>Description</i>
Unit and Production ID	Enter values for the production ID that you want to record completions and scrap.
Search	Click to retrieve the selected production ID.

Record Completions/Scrap Page

Use the Record Completions/Scrap page (SF_COMPL_ID) to enter completions and scrap information for production IDs.

In addition, use this page to move end items for production IDs with a single output or multiple outputs.

Navigation:

Production Control > Process Production > Complete Production > Record Completions and Scrap > Record Completions/Scrap

This example illustrates the fields and controls on the Record Completions/Scrap page. You can find definitions for the fields and controls later on this page.

Production Selection		Record Completions/Scrap		Edit/Issue Components Summary		Edit/Issue Express						
Unit	US008	<input type="checkbox"/> Serial in Prdn		Prdn Type	Production	Process Monitor						
Production ID	PRD00127	Released		BOM Code	1							
Production Area	FINAL			Routing Code	1	<input type="checkbox"/> Print at Save						
Item ID	SR1002			UOM	EA	Setup Print Options						
Carrera 6000 Hi Performance Road Bike				Revision								
Prdn Start Qty	100.0000	Completed Qty	0.0000	Putaway	Stage for Putaway at Save Time	Action						
Prdn End Qty	100.0000	Scrapped Qty	0.0000	Complete Production								
Prdn% Completed	0.00											
Completed Qty	<input type="text" value="0.0000"/>	Op Seq	<input type="text" value="0"/>	Previous Operations								
Scrap Qty	<input type="text" value="0.0000"/>	Enter Scrap Data	Quality	<input checked="" type="checkbox"/> Update Prior Operations								
				Back Thru Operation <input type="text" value="0"/>								
Operations Data												
Op Seq	Work Center	Task Code	Count Point	Assy Starts Qty	Quantity Issued to Operation	Qty Cpl/Th	Assembly Qty Scrapped at Op	Expctd Cmpl Qty	Op Yld %	Setup Earned	Post Prod	Sub Op
10	FI-ASSY	FORK	N	100.0000	0.0000	0.0000	0.0000	100.0000	100.0000	N	N	N
20	PAINT01	PAINT	N	100.0000	0.0000	0.0000	0.0000	100.0000	100.0000	N	N	N
30	FI-ASSY	FINAL	N	100.0000	0.0000	0.0000	0.0000	100.0000	100.0000	N	N	N

Previous Completions Information

Field or Control	Description
Prdn Start Qty (production start quantity) and Prdn End Qty (production end quantity)	Displays default quantity values from the Production ID Maintenance component. These values are updated whenever the quantity completed is changed.
Prdn% Completed (production percentage completed)	Displays the percentage of the batch production quantity that has been completed prior to this transaction.
Completed Qty (completed quantity) and Scrapped Qty (scrapped quantity)	Displays a quantity that represents the quantity that has been completed at the last operation. Scrapped quantity represents the quantity that has been scrapped at all operations.

Field or Control	Description
Putaway Action	<p>Select which putaway process to use. Options are:</p> <ul style="list-style-type: none"> • <i>Putaway at Receipt Save Time</i>: Select to initiate the putaway process after you have recorded completions and saved the page. <p>This method creates a schedule process, which automatically initiates the putaway process.</p> <ul style="list-style-type: none"> • <i>Stage for Putaway at Save Time</i>: Select to designate that these completions will use the PeopleSoft Inventory putaway process at a later time. <hr/> <p>Note: Upon saving the page, either stage the item for putaway or initiate the putaway process.</p> <hr/> <p>Item completions are not allowed if the end item or a component of the end item is on hold. Similarly, item completions are prevented if a co-product or recycle by-product is on hold.</p> <p>However, completions are allowed for waste by-products with a hold status.</p>
Print at Save	Select this check box if you want to print production documents for this particular production ID at save time.
Setup Print Options	Click this link to access the Process/Output Options page to select different print criteria for the production documents.

Recording Operation Completions

Field or Control	Description
Completed Qty (completed quantity)	<p>Enter the entire production ID quantity or any portion of that quantity for each operation sequence that you want to record completions.</p> <p>You can enter completions as many times as necessary to complete the production quantity for the production ID. For production IDs with a single output, this field represents the quantity completed at the operation sequence.</p>

Field or Control	Description
Op Seq (operation sequence)	<p>Select the operation step where the end items were completed. You can record partial completions by specifying any valid operation sequence, even if prior operation completions haven't been recorded.</p> <p>If you're using count points and you enter an operation sequence that is not a count point, then you can record only scrap. When using count points, completion quantities can only be entered at operations flagged as count point operations.</p>
Update Prior Operations	<p>Select this option if you want to automatically record completions and scrap for prior in-house operations at the same time that you're recording completions for this operation.</p>
Back Thru Operation	<p>Indicate how far back you want to report completions by selecting the operation sequence. The quantity that you're currently completing is added to any previously completed quantities at <i>all</i> prior operations specified.</p> <p>If you're using count points, this field displays the operation after the previous count point.</p>
Previous Operations	<p>If you're recording prior operations at a later time, do not enter any information in this group box, and ensure that the Update Prior Operations check box is deselected.</p>
	<p>Click the Refresh button to update the information in the Operations Data grid.</p>

Viewing Operations Data

The **Operations Data** scroll area displays production details based on operation sequence. You can view operation-related information such as assembly starts quantity, scrap quantities, expected completed quantity, and operation yield.

Click the Work Center link to view work center-related information.

Example: Recording Completions

Production start quantity: 10

Quantity completed: 10

Completing at operation sequence: 30

In this example, you want to complete a quantity of 10 at operation sequence 30. You selected the **Update Prior Operations** check box on the Record Completions/Scrap page, and indicated that you wanted to update previous operations back to operation sequence 20. The system calculates any production and scrap completed at operation sequences 20 and 30:

<i>Operation Sequence</i>	<i>Quantity Issued</i>	<i>Quantity Completed Through</i>	<i>Quantity Scrapped</i>
10	10	10	0
20	10	0	0
30	0	0	0
40	0	0	0

Once you've completed 10 at operation 30 and updated back through 20, the operations appear as follows:

<i>Operation Sequence</i>	<i>Quantity Issued</i>	<i>Quantity Completed Through</i>	<i>Quantity Scrapped</i>
10	10	10	0
20	10	10	0
30	10	10	0
40	10	0	0

Warning! You cannot update prior subcontracted operations using this option. If there is a prior subcontracted operation and the **Update Prior Operations** check box is selected, the system ignores the subcontracted operation when recording the prior operations as completed. Use the Subcontract Receipt component to record completed operations and scrap for the subcontracted operation.

Yield by Operation Example: Completing Less Production End Quantity than Expected

When using yield by operation, the beginning production quantities at subsequent operations are affected when either good or scrap production quantities are greater than expected. This example illustrates the effect of yield by operation when you scrap more end items than you originally expected.

Operation sequence: 30

Operation start quantity: 80

Operation yield: 98 percent

Scrapped quantity: 5

Operation Sequence	Operation Start Quantity	Quantity Issued to Operation	Quantity Completed Through	Quantity Scrapped	Expected Completed Quantity	Operation Yield Percentage
10	80	80	80	0	80	100
30	80	80	70	5	75	98
40	75	70	0	0	75	100
50	75	0	0	0	67	90

In this example, a quantity of 80 was issued and completed through operation 10. Because there is a 100 percent operation yield, a quantity of 80 is expected at the end of this operation. The original quantity complete at operation 50 was 70.

However, at operation 30, there is a 98 percent operation yield, and overscrapping of a quantity of 5 also occurs. This means that out of the operation start quantity of 80, only 75 are expected to be completed. As these 75 flow through operations 40 and 50, further loss is expected at operation 50, and the expected completion quantity for the order is now 67.

Yield by Operation Example: Completing More End Items than Expected

This example illustrates the effect of yield by operation on subsequent operations when you scrap fewer end items than you originally anticipated.

Operation sequence: 30

Operation start quantity: 69

Operation yield: 98 percent

Scrapped quantity: 0

Operation Sequence	Operation Start Quantity	Quantity Issued to Operation	Quantity Completed Through	Quantity Scrapped	Expected Completed Quantity	Operation Yield Percentage
10	69	69	69	0	69	100
30	69	69	69	0	69	98
40	69	69	69	0	69	100

Operation Sequence	Operation Start Quantity	Quantity Issued to Operation	Quantity Completed Through	Quantity Scrapped	Expected Completed Quantity	Operation Yield Percentage
50	69	0	0	0	62	90

In this example, a quantity of 69 was issued and completed through operation 10. Because there is a 100 percent yield, a quantity of 69 is expected at the end of this operation. The original quantity expected complete at operation 50 was 60.

However, at operation 30, there is a 98 percent operation yield and underscraping occurred (scrapped less than expected). Out of the operation start quantity of 69, all were completed and continue to flow through production. As these 69 flow through operations 40 and 50, further loss is expected at operation 50, and the expected completion quantity for the order is now increased to 62.

Related Links

[Understanding Subcontracting Using PeopleSoft Manufacturing](#)

Production Scrap Details Page

Use the Production Scrap Details page (SF_COMPL_SCRAP) to enter scrap quantities, if applicable.

Navigation:

Production Control > Process Production > Complete Production > Record Completions and Scrap > Record Completions/Scrap

Click the Enter Scrap Data link.

Field or Control	Description
<p>Scrap Qty (scrap quantity)</p>	<p>Enter an amount if scrap was generated during production. Scrap can be recorded at any operation sequence, even if you are using count points. For production IDs with a single output, the scrap quantity represents the number of scrapped end items at the operation sequence. For production IDs with multiple outputs, this field represents the number of scrapped end items for the batch (BOM) quantity, and not for each output.</p> <p>If the scrap at an operation exceeds the expected scrap quantity, you should create a new planned production order to meet the demand.</p> <p>For serial genealogy production, you may enter the specific serial ID that is being scrapped. If the serial ID has not previously been associated, you are given the option to create the association.</p> <p>If a routing has operation yield, a reported scrap quantity that is not equal to the expected scrap quantity changes start and end quantities at subsequent operations. It also changes the expected end quantity for the production order.</p> <hr/> <p>Note: If the scrap quantity is greater than the production end quantity, the system updates the production start quantity so that the ending production quantity meets demand.</p> <hr/>
<p>Reason Code</p>	<p>Select a value. This field indicates why the end item was scrapped. Scrap reason codes were previously defined using the Reason Code pages in the Set Up Financials/Supply Chain navigation. This field is required when a scrap quantity is entered.</p>
<p>Scrap Pct (scrap production percentage)</p>	<p>(Optional) This field indicates the percentage that the end item was completed at the operation where the scrap occurred. For example, if the scrapped end items were 75 percent complete before they were scrapped, enter that percentage here. In this example, when calculating the cost of scrapped end items, the system allocates all prior operation costs, plus 75 percent of the runtime costs of the operation where the scrap occurred to each scrapped end item. This percentage is used to calculate the amount of conversion costs earned and scrapped at this operation.</p> <p>If no value is entered, 0 appears in this field.</p>
<p>Distrib. Type (distribution type)</p>	<p>(Optional) This field indicates the transaction distribution type for the scrap transaction. The distribution type in combination with the scrap transaction determines the correct accounting entries to post the scrap loss to the general ledger. The system displays the default distribution type for the production scrap transaction group. Default distribution types are defined using the Default Distribution Types page. You can override the distribution type for each transaction.</p>

Note: If you're scrapping production that has an operation yield less than 100 percent, the scrap cost calculation is not performed.

The difference in expected and actual scrap is recorded as operation yield variance.

With production IDs, you have the option of scrapping end items at any operation or at the end of production when you can complete end items to stock or another production area. If you're recording scrap at an intermediate operation on a multiple output production ID, you're recording the scrap quantity for the batch and not the individual output items.

When recording scrap at an intermediate operation, the scrap quantity is associated only to the operation where the scrap was recorded. However, if you have selected to complete back through prior operations, the scrapped quantity will be presumed to have been completed at those prior operations.

Example: Scrapping at Operation 30 and Completing Back Through Operation 10

With no prior completed quantity, if you scrap 10 units at operation 30, the operation list would look as follows:

<i>Operation Sequence</i>	<i>Quantity Issued</i>	<i>Quantity Completed Through</i>	<i>Quantity Scrapped</i>
10	10	10	0
20	10	10	0
30	10	0	10
40	0	0	0

Note: You cannot record scrap at the output level. Scrapped end items for production with multiple outputs are recorded at the *batch* (BOM) level.

Recording Scrap When Using Count Points

When using count points, scrap can be recorded at any operation, regardless of the count point designation. The system updates the scrap quantity for the operation where the scrap occurred. In addition, the system assumes the scrapped quantity was completed at all previous operations up to the previous count point.

Count point operations: 30, 60

Production start quantity: 15

Step 1

Production start quantity previously completed or issued: 10

<i>Operation Sequence</i>	<i>Quantity Issued</i>	<i>Quantity Completed Thru</i>	<i>Quantity Scrapped</i>
10	10	10	0
20	10	10	0
30 (count point)	10	10	0
40	10	0	0
50	0	0	0
60 (count point)	0	0	0

Step 2

Scrap quantity: 5

Scrapping at operation sequence: 30

<i>Operation Sequence</i>	<i>Quantity Issued</i>	<i>Quantity Completed Through</i>	<i>Quantity Scrapped</i>
10	15	15	0
20	15	15	0
30 (count point)	15	10	5
40	10	0	0
50	0	0	0
60 (count point)	0	0	0

Example 2

Production start quantity previously completed and issued: 10

Scrap quantity: 5

Scrapping at operation sequence: 50

<i>Operation Sequence</i>	<i>Quantity Issued</i>	<i>Quantity Completed Through</i>	<i>Quantity Scrapped</i>
10	10	10	0
20	10	10	0
30 (count point)	10	10	0
40	10	0	0
50	0	0	0
60 (count point)	0	0	0

In this example, you have recorded scrap at a noncount point operation. In this case, the system records completions for any previous operations back to the operation after the previous count point (operation 40):

<i>Operation Sequence</i>	<i>Quantity Issued</i>	<i>Quantity Completed Through</i>	<i>Quantity Scrapped</i>
10	10	10	0
20	10	10	0
30 (count point)	10	10	0
40	10	5	0
50	5	0	5
60 (count point)	0	0	0

Once an end item is scrapped, the scrap end item value is calculated and expensed. Item costs for expensed and floor stock items are not included in the end item scrap cost. The end item, including the components used to that point, and the labor, machine, and overhead costs earned to that point are no longer accounted for in WIP inventory.

Note: If you record scrap for an operation that precedes a subcontracted operation, and the purchase order has already been generated for the production quantity, the system sends a purchase order change request to PeopleSoft Purchasing, indicating a change in production quantity. This change must be processed before the end items are sent to the subcontractor.

Related Links

[Understanding Subcontracting Using PeopleSoft Manufacturing](#)

Rapid Serial Numbers Page

Use the Rapid Serial Numbers page (MG_SERIALRG_PG_SBP) to (Optional) Automatically generate serial numbers for production end items that are serial-controlled.

Navigation:

Production Control > Process Production > Complete Production > Record Completions and Scrap > Record Completions/Scrap

Click the Generate Serial IDs link.

<i>Field or Control</i>	<i>Description</i>
Serial Number Count	Displays the number of completed end items that the system assigns serial numbers. A serial number is assigned to all the end items indicated as completed on the Record Completions/Scrap page.
Serial ID Parameters	Displays default information from the Automatic Serial Number page.

Field or Control	Description
Serial Number Prefix, Multiplier, Serial Number Length, and Zero Pad	<p>You can use the default values for the business unit or item or you can override these defaults here.</p> <p>The serial number prefix can contain up to three alphabetic and numeric characters.</p> <p>The Multiplier field indicates the increment in which to assign serial numbers. For example, a multiplier of 1 increments each serial number that the system assigns by one. If the last serial number assigned was MFG00001, then the next serial number is MFG00002.</p> <p>Select Zero Pad if you want to use zeroes as placeholders for the serial number length that you defined.</p> <p>Use the Start Num (start number) field to specify the first serial number that you want to assign to the completed end items. If you enter a specific starting number, the serial numbers begins with that starting number. The default for this field is blank, and you do not have to enter a starting number. If you leave the field blank and click OK, you receive a warning that the starting serial number is blank and zero appears by default. In this case, the starting serial number is MFG00000. If you enter <i>1</i> in this field, the starting serial number is MFG00001.</p>
OK	<p>When you click this button, each completed end item, along with the corresponding serial number, appears in the Route-To PID/Stor Locations scroll area on the Record Completions/Scrap page.</p>

Recording End Item Completions Using Count Points

You can use count points to record end item completions.

To record completions and scrap for production IDs using count points:

1. Access the Record Completions/Scrap page.
2. Enter the **Completed Quantity** for the operation sequence.

If you enter the completed quantity first, only the count point operation steps are available.

3. Select the **Op Seq** (operation sequence) that is a count point.

If you click the operation sequence look up without entering a completed quantity, all operation sequences appear.

Note: When you record completions at the last operation (which must be a count point), the system assumes that you have or will complete at all prior count points. Therefore, the completed quantity is updated only back to the prior count point.

Because the system automatically completes back to the operation after the previous count point, the **Update Prior Operations** and the **Back Thru Operation** fields are unavailable and the operation after the prior count point (operation sequence) appears by default. This indicates that the quantity completed will also be recorded for operations up to, but not including, the prior count point. If you're recording completions at the first count point, the system automatically completes back through and including the first operation.

4. All other processes, such as entering scrap data and routing completed end items, remain the same as those used with completing production IDs at intermediate operations.

Example: Recording Completions Using Count Points

Count point operations: 30, 50

Production start quantity: 10

Step 1

Quantity completed: 10

Count point at operation sequence: 30

In this example, you want to complete a quantity of 10 at operation sequence 30, which is a count point. The system calculates any production and scrap completed at operation sequences 10, 20, and 30:

<i>Operation Sequence</i>	<i>Quantity Issued</i>	<i>Quantity Completed Through</i>	<i>Quantity Scrapped</i>
10	10	10	0
20	10	10	0
30 (count point)	10	10	0
40	10	0	0
50 (count point)	0	0	0

Step 2

Quantity completed: 5

Count point at operation sequence: 50

In this example, you want to complete production for a quantity of 5 at operation sequence 50, which is a production ID count point. The system doesn't include operation sequence 30 because it is the prior count point:

<i>Operation Sequence</i>	<i>Quantity Issued</i>	<i>Quantity Completed Through</i>	<i>Quantity Scrapped</i>
10	10	10	0
20	10	10	0
30 (count point)	10	10	0
40	10	5	0
50 (count point)	5	5	0

Recording End Item Completions at the Last Operation

To record completions at the last operation:

1. Access the Record Completions/Scrap page.
2. Enter the last operation on the operation list in the **Op Seq** (operation sequence) field if you want to complete all operations for the production ID and all of the operations are performed in-house.
3. Select **Update Prior Operations**, then select the first operation from the **Back Thru Operation** options.
4. Enter the number of completed end items in the **Completed Qty** (completed quantity) field.

You can record completions for the entire production quantity for the production ID or any portion of the quantity.
5. All other processes, such as entering scrap data and routing completed end items, remain the same as those used with completing production IDs at intermediate operations.

Note: Co-products can only be completed at the last operation.

Related Links

[Moving Completed End Items and Assigning Serial and Lot Numbers](#)

Record Completions/Scrap Page

Use the Record Completions/Scrap page (SF_COMPL_ID) to enter completions and scrap information for production IDs.

In addition, use this page to move end items for production IDs with a single output or multiple outputs.

Navigation:

Production Control > Process Production > Complete Production > Record Completions and Scrap > Record Completions/Scrap

When completing end items at the last operation, the **Route-To PID/Stor Locations** scroll area on the Record Completions/Scrap page becomes available. You can route the completed end items to a storage area, another production ID, or to a WIP location. Additionally, if the end item is lot- or serial-controlled, or if you're utilizing containers, you can assign serial numbers, lot IDs, or container IDs to the completed end items.

If a default putaway location is defined for the end item, you can route the completed end items to that location using the routing portion of the page.

Click **Apply Defaults** to indicate that you want to put away the end items to the default putaway location.

Note: The completions process puts away items in their standard UOMs.

Moving Completed End Items and Assigning Serial and Lot Numbers

To define default putaway locations, use the Default Putaway Locations (DEFAULT_LOCATION) component. Use the DEFAULT_LOCATION_CI to load data into the tables for this component.

Once you have recorded completions for the last operation sequence on the operation list, you can move the completed end items:

- To predefined stores locations within PeopleSoft Inventory.

Use this method when you want to put away completed end items to default stores locations defined in PeopleSoft Inventory. After completing the last operation, use the Completions/Scrap Update process. There is no need to use the **Route-To PID/Stor Locations** scroll area unless you need to identify serial numbers, lots, or containers.

- To other production areas to fulfill component requirements and relieve shortages out on the shop floor.

Use the **Route-To PID/Stor Locations** scroll area to move the completed end items.

- To a specific location where you want to stock the completed end item.

Use the **Route-To PID/Stor Locations** scroll area to specify the location.

- To a production ID, if the end item is a component on a higher-level end item using the Kit issue method.

This bypasses the putaway process into inventory. You can use the **Route-To PID/Stor Locations** scroll area to specify the production ID.

In addition, select the serial number for the appropriate assembly that is being completed and moved.

For serial genealogy production, you must enter the specific serial ID that is being completed. If the serial ID has not previously been associated, you are given the option to create the association.

If you're assigning a lot or serial number for teardown outputs that were based on an original production ID's components, the system compares the new lot or serial number to the original component serial or lot numbers and issues a warning if they are different.

Note: If the assembly is serial in production and you are tearing out a serial ID that has not been issued to this assembly, you receive this message: "Tearing out more than has been issued to the original assembly serial. Okay to continue?" Double-check the quantity and serial ID. Click **OK** to continue or **cancel** to change information. The edit check is only looking one level deep, not through all the nested subassemblies.

Route-To PID/Stor Locations

When you route to a production ID, the system checks that:

1. The item being completed is a component of the production ID parent item.
2. The issue method is Kit.
3. The production ID status is *Released* or *In Process*.
4. The shortage quantity is greater than zero.

When routing an end item to another production ID from a production ID, you needn't run any putaway processes. The system automatically updates the issue quantity for the component on the target production ID as well as the quantity completed for the source production ID.

However, if you're routing the end item to a production ID from a production schedule, you still need to run the Completions Update process to update the production information for the production schedule, either at save time or as a deferred process.

Note: You cannot route waste by-products. They are expensed in the same manner as scrapped end items.

Capacity Checking

You activate weight and volume capacity checking on the PeopleSoft Inventory Options page. You can define the capacity for each storage location on the Volume/Weight Capacity page, which you can access from the Material Storage Locations page.

If the item is designated as an isolate item on the Inventory-Shipping/Handling page in the Define Business Unit Item component, the item can only be put away or transferred to empty storage locations or to locations containing stock with the same item ID. The system prevents you from putting away an isolate item to a location with other items.

If you designate a storage location as storing only one item on the Volume/Weight Capacity page, the system only puts away material with that item ID in the location. If you do not specify an item ID for a single-item storage location, the first putaway transaction to the empty storage location defines the only item ID that the location can contain until the item quantity has been fully depleted.

Pages Used to Move Completed End Items and Assign Serial and Lot Numbers

<i>Page Name</i>	<i>Definition Name</i>	<i>Usage</i>
<u>Complete Production Page</u>	SF_COMPL_SELECTION	Select a production ID or production schedule.
Record Completions/Scrap page - Route-To PID/Stor Locations scroll area Page	SF_COMPL_ID	Move completed end items to a production ID or to a storage location. <u>Complete Production Page</u>
Shortages Page	SF_COMPL_SHORTAGE	Select a production ID to which you want to route a completed end item.

Prerequisites

Before you move the items to another WIP location, production ID, or inventory stores location:

- Assign serial and lot numbers to the completed end items if the completed end items are serial- or lot-controlled.
- (Optional) Identify a container to which you want to move the completed end items.
- Select the production ID to which the completed end items will be moved.

Record Completions/Scrap Page

Use the Route-To PID/Stor Locations scroll area on the Record Completions/Scrap page (SF_COMPL_ID) to move completed end items to a production ID or to a storage location.

Navigation:

Production Control > Process Production > Complete Production > Record Completions and Scrap > Record Completion/Scrap

Enter a completed quantity and the last operation sequence to access the **Route-To/PID Stor Locations** (route to production ID and storage locations) scroll area.

You can move the completed end items to a storage area, another production ID, or a WIP location. In addition, if the end item is lot- or serial-controlled or if you're using containers, you can assign serial numbers, a lot ID, or a container ID to the completed end items using this portion of the page.

Note: If you're completing operations at an operation sequence where a by-product is generated, the Route-to PID/Stor Locations scroll area appears. However, the operation sequence for all end items, *except by-products*, is unavailable.

Field or Control	Description
	Click the Shortages button on the Route-To PID/Stor Locations scroll area on the Record Completions/Scrap page. See Shortages Page .
Storage Areas	You can choose different storage areas by different levels such as Area, Lev 1, Lev 2, and Lev 3 .
	Click the Storage Location Search button and click the Storage Location Search link to select a different storage location.
Quantity	Enter the number of completed end items being routed.

Shortages Page

Use the Shortages page (SF_COMPL_SHORTAGE) to select a production ID to which you want to route a completed end item.

Navigation:

Production Control > Process Production > Complete Production > Record Completions and Scrap > Record Completion/Scrap

Click the **Shortages** button in the **Route to PID/Storage Locations** scroll area.

A component is considered short if the pending consumed quantity or the pending yield loss quantity is greater than zero. The production ID is *In Process* or *Pending Complete* if the issue quantity is less than the current scheduled quantity.

Route-To Production ID

Field or Control	Description
Selection	Select this option to use the completed end items on the production ID with shortages.
OK	Click this button to cause the production ID to appear in the To Prdn ID (to production ID) field in the Route-To PID/Stor Locations scroll area on the Record Completions/Scrap page.

Field or Control	Description
Routing to IDs and Storage Areas	You can apply the default storage location or production ID to the entire production quantity or to each output, or you can route multiple quantities to different locations or production IDs by adding rows. For each row, you can only select either a storage location or a production ID for the entered quantity. If a storage location is specified, you cannot route end items to a production ID. If you route to a production ID, you cannot route to a specific storage location.
Quantity	Enter the number of end items to be routed.
Orig Comp ID (original component ID)	Displays the original component ID if the end item is a substitute.
Save	Click to route completed end items.

Selecting Default Putaway Storage Locations

Access the Apply Defaults page (**Production Control > Process Production > Complete Production > Record Completions and Scrap > Record Completions/Scrap**. Click the Apply Defaults link).

Field or Control	Description
Deft Storage Loc (default storage location)	<p>Displays the default putaway location for the completed end items, if defined. When you accept the defaults in these fields, the completed end items are automatically moved to the default putaway location for the item when you run the PeopleSoft Inventory putaway process.</p> <p>If you are not going to move the completed end items to the default storage location, you can select a specific location or route them to another WIP location where they can be used on a higher-level end item.</p> <p>The system displays the number of storage levels, such as <i>Aisle</i>, <i>Level 1</i>, <i>Level 2</i>, <i>Level 3</i>, and <i>Level 4</i>, that have been defined for each storage area.</p> <hr/> <p>Note: The completions process puts away items in their standard UOMs.</p> <hr/>

<i>Field or Control</i>	<i>Description</i>
Directed Putaway	If you do not enter a storage location, you are not routing to a production ID, and you have activated Directed Putaway for the business unit, the system uses the Directed Putaway method to select a storage location. While running the Load Stage process, the system determines the location that best meets the predefined rules for Directed Putaway. You activate Directed Putaway and set up putaway rules on the Putaway Rules page in PeopleSoft Inventory.

Record Completions/Scrap Page

Use the Record Completions/Scrap page (SF_COMPL_ID) to move completed end items to a production ID or to a storage location.

Navigation:

Production Control > Process Production > Complete Production > Record Completions and Scrap > Record Completion/Scrap

Enter a completed quantity and the last operation sequence to access the **Route-To/PID Stor Locations** (route to production ID and storage locations) scroll area.

<i>Field or Control</i>	<i>Description</i>
Container ID	<p>Select a value in the Output Details scroll area if you want to complete to a container. The system assigns this container ID to all the end items that are indicated as completed on the Record Completions/Scrap page. You can select from existing containers, or you can create a new container ID.</p> <p>If the container ID is specified, you cannot route end items to a production ID, and the default To Prdn ID (to production ID) and Area fields are unavailable.</p>

Selecting a Lot ID

If an end item is lot-controlled, select the lot ID to which you're assigning the completed end items. The system assigns the specified lot ID to all the end items indicated as completed on the Record Completions/Scrap page. You can select from existing lots, or you can create a new lot ID.

Staging End Items for Putaway

To move completed end items to a stores or other inventory location, complete these tasks using PeopleSoft Inventory:

1. Run the Load Staged Items process.

The system suggests the location where the end item should be put away. If you have entered a location on the **Route-To PID/Stor Locations** scroll area, the system stocks the completed end items

in the specified location. If you select **Flag Items for Autoputaway**, you can bypass the Stockroom Feedback process and run the Putaway page. To streamline the process, you can run the multistep process using PeopleSoft Inventory Auto Putaway.

2. Run the Stockroom Feedback process.

This page enables you to change the location suggested by the load staged items process.

- If you're satisfied with the putaway location suggested by the system, you must first select the putaway check box, if it is not selected.

Then click **Putaway** to initiate the putaway process.

- If necessary, change the location, and then click **Putaway** to initiate the putaway process.
- If you selected **Flag Items for Autoputaway** on the Load Staged Items page, you do not need to run the Stockroom Feedback process.

3. Run the Putaway page.

This processing page updates the stock location with the quantity received from the WIP location.

Putaway at Receipt Save Time

Use this option to initiate the putaway process after you have recorded completions and saved the page. This method creates a schedule process that automatically initiates the putaway process.

Recording Completions and Scrap for Production IDs with Multiple Outputs

You use the Record Completions/Scrap component to record completions and scrap for production that generated multiple outputs: primary items, co-products, and recycle and waste by-products.

Pages Used to Record Completions and Scrap for Production IDs with Multiple Outputs

<i>Page Name</i>	<i>Definition Name</i>	<i>Usage</i>
<u>Complete Production Page</u>	SF_COMPL_SELECTION	Select a production ID with multiple outputs. You must define at least one production ID.

Page Name	Definition Name	Usage
Record Completions/Scrap - Output Details scroll area Page	SF_COMPL_ID	<p>Enter completions and scrap information for production IDs with multiple outputs.</p> <p>This scroll area on the Record Completions/Scrap page becomes available when you select a production ID with multiple outputs. Enter an operation sequence, and then press the Tab key.</p> <p><u>Record Completions/Scrap Page</u></p>

Related Links

“Understanding Receiving and Putaway Processing” (PeopleSoft Inventory)

Record Completions/Scrap - Output Details scroll area Page

Use the Record Completions/Scrap - Output Details scroll area page (SF_COMPL_ID) to enter completions and scrap information for production IDs with multiple outputs.

This scroll area on the Record Completions/Scrap page becomes available when you select a production ID with multiple outputs. Enter an operation sequence, and then press the Tab key.

Navigation:

Production Control > Process Production > Complete Production > Record Completions and Scrap > Record Completion/Scrap

This example illustrates the fields and controls on the Output Details scroll area on the Record Completions/Scrap page. You can find definitions for the fields and controls later on this page.



To enter batch completions quantities (for production IDs with multiple outputs):

1. Access the Record Completions/Scrap page.
2. Enter a completed quantity and select an operation sequence.

The **Output Details** scroll area becomes available.

Note: If you're recording completions at an intermediate operation, the system displays all by-products. If you're completing operations at the last operation, the system displays all outputs: primary, co-products, and by-products.

3. (Optional) Click **View All** to display all end items being completed.
4. Enter the completed quantity for each output.

The completed quantity for each end item is calculated based on the batch (BOM) quantity. You can, however, override the output quantity for each end item.

5. (Optional) Click **Add** to add by-products.
 - a. Select the output type; you can only add Recycle or Waste by-products.
 - b. Select the output item.
 - c. Select the operation sequence where the by-product is being generated.

The default operation sequence is zero, and if you do not change the default, the system treats it as the last operation.

- d. Enter the output quantity based on per end item or per order.
6. Click **Save** to process the multiple output completion.

Output Details

<i>Field or Control</i>	<i>Description</i>
Qty Compl to Date (quantity completed to date)	Displays the output production quantities completed prior to this transaction.
Output Schd Qty (output scheduled quantity)	Displays the total scheduled output production end quantity. This is the output quantity that you expect to produce for each output. This field is display-only for primary items and co-products.
Output Quantity	Displays the output production quantities based on per assembly or per order. You can adjust this field for by-products. You cannot change the output quantity for primary or co-products on this page.
Quantity Per	Indicates whether the quantity required is per assembly or per production order.

Field or Control	Description
Res % (resource allocation percentage)	Determines how much of the BOM batch quantity the primary items and co-product represent. It is used during completions to determine what percentage of the components should be consumed for the primary and co-product. The total resource allocation percentage should always equal 100 percent.

Example: Batch Calculation

If you entered a completed quantity of 5 on the Record Completions/Scrap page, the system calculated each output quantity based on this quantity of 5. However, you can change the completed quantity for any of the outputs in the **Output Detail** scroll area. Overriding the completed quantity at the output level for primary and co-products recalculates the batch completed quantity using the resource percentages defined on the BOM.

Over-Completing Production IDs

There may be situations when you need to over-complete expected production ID quantities. For example, perhaps the oranges that you used to make orange juice were a bit juicier than normal, and instead of producing 75 gallons of orange juice, you actually produced 80. If this is the case, you would enter *80* in the **Completed Qty** (completed quantity) field on the Record Completions/Scrap page. When you tab out of the field, you receive a message indicating that the output item's completed quantity is greater than the production quantity.

When you click **OK**, the system recalculates the completed quantity for all output items based on this new quantity.

Note: If you want to change the production quantities for the batch, which changes the primary and co-product quantities, change the production start quantity or production end quantity for the production ID on the Production ID Maintenance page.

Moving Completed End Items for Production IDs with Multiple Outputs

After recording completions for production IDs with multiple outputs, you can route each completed output to a storage area, another production ID, or a WIP location.

See [Record Completions/Scrap Page](#).

Edit/Issue Components Page

Use the Edit/Issue Components pages if you want to modify or view the components that will be consumed based on the quantity completed or scrapped, or if you need to select the serial or lot numbers for those components that were consumed when you recorded the completion.

See [Editing Component Lists](#).

Recording Completed and Scrapped End Items for Production Schedules

For production schedules, you can record partial production completions, or you can complete the entire schedule.

Use the Record Completions/Scrap component to:

- Record completed operations for all or part of the production quantity.
- Record completions and scrap for production schedules with multiple outputs.
- Scrap end items.
- Completely backflush the entire production run or order.
- Automatically consume components based on the quantity completed.
- Automatically complete end items based on the batch completed quantity.
- Manually substitute components where there is a shortage of an item or an item is out of stock.
- Assign serial numbers and lot numbers to completed end items before moving them out of the production area.
- Route completed end items, including primary items, co-products, and recycle by-products, to another production ID or WIP location to be used on subsequent end item production.
- Indicate that production has been completed for the production schedule.

If you have enabled PeopleSoft Workflow, when you record end item scrap, the system sends a notification by using the Assembly Prdn Schedule Scrap Notification workflow to selected roles defined by you. These roles could include a quality manager or a production control manager.

Using this component, you can record in-house operation or end item completions and scrap for production schedules with a status of:

- **Entered or Firmed:** The system automatically releases the production schedule, and creates the component list and operation list (if a routing exists).

The status is automatically changed to In Process.

- **Released:** The system changes the status to In Process.
- **In Process.**

If you're using production issue or production kit method for regular production, you still must issue material to the WIP locations using the Pick Plan and Material Release components. If you're using the production replenishment method, ensure that sufficient inventory exists in the WIP location.

Note: Quantities of an item that are stored in a nettable, available WIP location and reserved for production use are not available for other purposes.

You can record in-house operation or end item completions and scrap for production quantities that haven't been previously entered as scheduled quantities.

In this case, the system prompts you for the schedule quantity and the production schedule is automatically created with a status of *In Process*. You can then backflush a partial quantity or the entire production quantity and record any scrap.

- If you're using the production issue method, you still must issue material to the WIP locations to ensure that there is sufficient quantity on hand to satisfy the production schedule quantities.
- If you're using the production replenishment method, make sure that sufficient inventory exists in the WIP location.

This section lists common elements and discusses how to Record Completions and Scrap for Production Schedules

Pages Used to Record Completions and Scrap for Production Schedules

<i>Page Name</i>	<i>Definition Name</i>	<i>Usage</i>
<u>Production Selection Page</u>	SF_COMPL_SELECTION	Select a production schedule to record completions and scrap. You must define at least one production schedule. The production status should be Released or In Process.
<u>Schedule Selection Page</u>	SF_PA_SCH_PEG_SP	Peg completions to a specific production schedule row.
<u>Record Completions/Scrap Page</u>	SF_COMPL_ID	Enter completions and scrap information. In addition, use this page to move end items for production schedules with a single output or multiple outputs.
Production Scrap Details Page	SF_COMPL_SCRAP	Enter any scrap quantities.
Apply Defaults Page	SF_COMPL_DEFAULTS	Select the putaway locations for the completed end items.
<u>Rapid Serial Numbers Page</u>	MG_SERIALRG_PG_SBP	(Optional) Automatically generate serial numbers for production end items that are serial-controlled. You must define serial-controlled items in PeopleSoft Inventory.
Work Center Details Page	SF_WORK_CTR_SP	View work center-related information such as WIP locations.

Page Name	Definition Name	Usage
Lot/Serial Number Selection Page	SF_ED_CMP_SBP_GRD	(Optional) Select the serial numbers of the serial-controlled components to be consumed during the completions process. You must enter a pending quantity greater than zero before the Lot/Serial scroll area becomes available.
Lot/Serial Number Selection scroll area Page	SF_ED_CMP_SBP_GRD	(Optional) Identify the lots from which you want to consume lot-controlled components. Lots can be automatically assigned during backflush depending on your setting for the backflush lot selection rule. You must enter a pending quantity greater than zero before the Lot/Serial scroll area is available.
<u>Production History Page</u>	SF_TRANSHIST	View production transaction history for production schedules.
Transaction History Details inquiry Page	SF_TXN_HIST_SP	View completions details based on the selection criteria. <u>Production History Page</u>

Common Elements Used in This Section

Field or Control	Description
Prdn Start Date (production start date)	The date on which the production is due to begin.
Prdn Due Date (production due date)	The date on which the production is due to be completed.
Date Type	The date used as a sort option for the production schedule—either by production start or production due date.
Sch Method (scheduling method)	For production schedules, <i>Backward</i> always appears.



Production Selection Page

Use the Production Selection page (SF_COMPL_SELECTION) to select a production schedule to record completions and scrap.

You must define at least one production schedule.

Navigation:

Production Control > Process Production > Complete Production > Record Completions and Scrap > Production Selection

<i>Field or Control</i>	<i>Description</i>
Unit, Production Area, and Item ID	Enter values for the production schedule.
	Click the Item Search button to access the Item Search Criteria page to locate a different item.
Complete to a Specific Schedule	Click this link if you want to select a specific production schedule.
BOM/Rtg Code Effective Dates	<p>Because only one active BOM/routing combination is valid for an area at any one time, select the valid BOM/routing combination for accurate component consumption. By selecting an effective date in the BOM/Rtg Effdt (BOM/routing effective date) field, you determine the particular BOM/routing combination for which you want to complete. The BOM/routing effective date, which is the current date by default, determines which combination the system selects and displays in the BOM Code and Routing Code fields.</p> <p>For non-revision-controlled items, this BOM/routing date is used to decide which BOM/routing combination will be used and a second effective date that will be used for the components and outputs. If the item is revision-controlled, then both an item revision code and BOM/routing effective date must be selected.</p> <hr/> <p>Note: Because you can create multiple schedules per area with only one combination effective at any one time, production schedules for prior effective date ranges may not be consumed if the effective date range for the combination has passed. For example, if you have BOM code 1 and routing code 2 valid from January 1, 2001, but BOM code 2 and routing code 2 is valid from June 1, 2001 for the same production area, then you could create production schedules for the 1/2 combination prior to June 1, 2001 but completing them after this date. In this case, the system is unable to consume for them because the new BOM/routing combination has taken effect. In addition, you get an auto-add message when you attempt to complete because no schedules currently exist for the 2 /2 combination. However, if you change the BOM/routing effective date back to a date prior to June 1, 2001, the system accesses the correct combination.</p> <hr/>
	Click the Select BOM/Routing button to access the Select BOM/Routing page to select a different BOM/routing combination. This selection also displays the effective dates of the BOM/routing combinations.

Field or Control	Description
Revision	You can change the revision code if you're building to a different revision. If the item is not revision-controlled, the current date is displayed in the effective date BOM configuration used to create the component list.
Negative Completions	Select this check box if you are reversing a previous completions or scrap transaction. See Creating Reversing Entries to Correct Data Entry Errors .
Search	Click to retrieve the selected production schedule.

Schedule Selection Page

Use the Schedule Selection page (SF_PA_SCH_PEG_SP) to peg completions to a specific production schedule row.

Navigation:

Production Control > Process Production > Complete Production > Record Completions and Scrap > Production Selection

Enter the production area and item, and then click the Complete to a Specific Schedule link.



This example illustrates the fields and controls on the Schedule Selection - Summary page. You can find definitions for the fields and controls later on this page.

Schedule Selection [Help](#)



Business Unit US012 

Production Area SAUCEFG Bottled Sauce Area

Item ID 00000000000020036 Creamy Tomato Sauce Bottled, 2

From Date 01/10/2014  To 01/10/2014 

Date Type
 Prdn Start Prdn Due

List of Production Schedules Personalize | Find | View All |   First 1 of 1 Last

Sel	Prdn Due Date	Prdn Due Shift	Prdn Start Date	Prdn Start Shift	BOM Code	Routing Code	Rev	Prdn Start Qty
<input type="checkbox"/>								0.0000

You may want to complete for a specific production schedule because a substitution was made or a data entry error needs to be corrected. In addition, by pegging to a production schedule, you update the specific production schedule when you run the Completions Update process.

Field or Control	Description
Date Range	Enter the date range.
Date Type	Displays how you want to view the production schedules. Values are: <ul style="list-style-type: none"> • <i>Prdn Start</i> (production start) • <i>Prdn Due</i> (production due)
	Click to refresh the data if you made any changes to the date range or date type.
Sel (selection)	Select the specific production schedule that you want to record completions and scrap.
OK	Click this button to return to the Production Selection process page.

Adding a New Production Schedule During Completions

If the system indicates that no current outstanding production schedule quantities exist for this production area/item combination as of the BOM/routing effective date or effective date, you receive a warning message indicating that no outstanding production quantities exist for an area or item.

If you click **Yes**, the system creates a new production schedule. The system checks for any outstanding production schedules by comparing any unprocessed BCTP detailed transaction logs (BCT_DTLs) (*Completed* + *Scrapped*) quantities and netting them against those matching open production schedules (production end quantity > completed + scrapped quantity) in the system.

The default rate quantity per shift from the production area or item definition appears as **Production Rate Quantity**. Click **OK** to accept this quantity or change the quantity to the quantity that you're currently producing.

Recording Completions and Scrap for Production Schedules That Haven't Been Released

You can also record completions and scrap for production schedules that have not been released.

To release Entered production schedules, use the Prod Schedule Status Change page or the Production Status Change process (SFPARELS). This process looks for production schedules that match the date, shift, BOM code, routing code, and primary end item of the selection criteria. The system releases all the production schedules with a status of *Entered* that match the selection criteria. You can then record completions and scrap for the production schedules.

Firmed production schedules are automatically released during the completions process.

Record Completions/Scrap Page

Use the Record Completions/Scrap page (SF_COMPL_ID) to enter completions and scrap information.

In addition, use this page to move end items for production schedules with a single output or multiple outputs.

Navigation:

Production Control > Process Production > Complete Production > Record Completions and Scrap > Record Completions/Scrap

The process for recording completions and scrap for production schedules is similar to the process used for production IDs. However, there are a few differences:

- Completions and scrap are recorded at the *last* operation sequence only.
- You select one of these completions actions:

<i>Field or Control</i>	<i>Description</i>
Completions/Putaway on Save	Use this option to initiate the Completions Update process for the selected production schedule upon saving the page. The production end quantity completed and scrapped information is updated as well as the storage area quantity on hand. All completions processing is performed, including component updates.
Stage Compltns/Putaway on Save	Use this option to run the Completions Update process at a later time.

Record Completions/Scrap Page

Use the Record Completions/Scrap page (SF_COMPL_ID) to enter completions and scrap information.

In addition, use this page to move end items for production schedules with a single output or multiple outputs.

Navigation:

Production Control > Process Production > Complete Production > Record Completions and Scrap > Record Completions/Scrap

To record completions and scrap for production schedules with multiple outputs:

1. Enter the completed quantity that represents the batch (BOM) production end quantity.

This quantity doesn't represent completed quantities for each output in the **Output Details** area. You can enter a quantity here or optionally enter the quantity of each output. If you enter specific output completions, the system determines the quantity of the batch completed.
2. The **Op Seq** field is unavailable and the last operation step appears.

Note: Because you're completing a production schedule, the **Update Prior Operations** check box is unavailable, and the first operation step appears by default in the **Back Thru Operation** field. These fields are display-only and cannot be changed.

3. Click the Enter Scrap Data link to make corrections to the scrapped component quantities.
4. Access the Output Details scroll area on the Record Completions/Scrap page.
5. Enter the completed quantity for each output.

The system calculates the multiple output quantities based on the batch completed quantity from the Record Completions/Scrap page. For example, if you entered a completed quantity of 5 on the Record Completions/Scrap page, the system would calculate each output quantity based on this quantity of 5. However, you can change the completed quantity for any of the outputs on the Output Details scroll area.

Note: If you want to change the production quantities for the batch, which changes the primary and co-product quantities, change the production end quantity for the production schedule on the Production by Area Summary or Production by Area Details pages.

6. (Optional) Click **Add** to add recycle or waste by-products.
 - a. Select the output type and output item.
 - b. Select the operation sequence where the additional by-product is being generated.
 - c. Enter the completed quantity, which is the output quantity that you're currently completing.
 - d. Enter the output quantity.

This quantity represents the output production end quantity based on per end item or per order.

7. Click **Save** to record the completions and scrap.

Moving End Items for Production Schedules

With production schedules, you can only complete end items at the last operation. When you enter the completed quantity on the Record Completions/Scrap page, the Route-To PID/Stor Locations scroll area becomes available. You use the Route-To-PID/Stor Locations scroll area to route completed end items for production schedules with a single output or multiple outputs.

Editing Component Lists

At some point while recording operation completions and scrap, you may need to view or modify the component list or select the lot and or serial numbers for the consumed components. Using the Edit/Issue Components pages, you can:

- Add components to or delete components from the component list.
- Add substitute components to or delete substitute components from the component list.

- Change the scheduled quantity, quantity per order or per assembly, operation sequence, or component yield percentage.
- Change the pending issue or pending yield loss quantity.
- View or edit components even if you haven't reported any end item completions or scrap.
- Consume components that couldn't be consumed previously due to shortages in the WIP location.
- Select the serial numbers or lot numbers of the components to be consumed. For lot-controlled components that are not serial-controlled, you can view or change the lot numbers assigned during backflush, if you have selected the backflush lot selection rule of *Earliest Expiration Date* or *Earliest Available Date*.

See [Automatically Consuming Lot-Controlled Stock During a Backflush](#).

In addition to using this page to record the consumption of components in the process of recording completions or scrap, you can also use this page to:

- Record miscellaneous consumption of components, independent of backflushing.
- Consume pending component quantities that were created when you backflushed and a shortage existed in the WIP location.

If a shortage existed and you already recorded completions, you must first issue material to the WIP location and then use the Edit/Issue Components pages to consume those quantities.

Keep these in mind when editing component lists:

- For regular production, the system displays the components in effect for the end item at the due date for production or for the item revision, if one is specified.

If a component for the item is designated as a phantom on the production BOM, the phantom item's components—not the phantom item—is listed here. The operation sequence for the phantom is used for the phantom components.

- For production IDs using serial genealogy, and component's trace usage = serial or lot, the issue qty field is display-only.

Use the Component Association or the Maintain Serial Genealogy commands to associate and consume these components. To consume trace usage components that are not associated with a serial assembly enter quantity in the pending yield loss qty field.

- For rework production, the end item is the only component listed unless you're using a rework BOM or have previously maintained the component list and added those components necessary to rework the end item.
- For teardown production, the end item to be torn down is the only component listed, unless you have previously added additional components to the component list.
- You can change any component to a different item ID, or you can add a new component or substitute.

You cannot change the component ID or operation sequence it is associated with once the component has been issued. In addition, for rework production, you cannot change the end item that is being reworked and for teardown production, you cannot change the end item to be torn down.

- For all production types, when you add new components with an item status of *Discontinue*, you receive a warning message.

For regular production, you receive a warning message when you add a component with an item status of *Hold*. In both cases, receiving the warning message doesn't prevent you from performing the action. For rework and teardown, components with an item status of *Hold* are issued.

- When using the online mode of this component (PID Completion Option on the MFG BU Prdn Options page), if the backflush process has completed and then a field is changed that causes the pending quantities field to be recalculated, this causes a recalculation of backflush lot selection rule. Fields that trigger the recalculation of the pending quantities include:

- Completion Quantity
- Scrap Quantity
- Completion Op Sequence
- Back thru Op Sequence
- Component ID
- Component's Op Sequence
- Component's Qty Code
- Component's Qty Per
- Picking a substitute item

- For regular production, you cannot add the end item as a component.

On the other hand, for rework production, you cannot delete the reworked end item from its component list. Duplicate components can exist as long as the operation sequence is unique. You cannot add a configured item as a component unless the end item is a configured item.

- When deleting components, the system checks to see if:

- The issue quantity for the component is greater than zero.

In this case, you cannot delete the component. To delete the component, reverse the backflush, unconsume the component, or use the Kit Issue/Return page to return the component, and then delete it.

- The component's issue method is *Kit*, and a pick plan has been generated for this component.

Note: If you need to add a phantom component to the component list, you must enter all of the items that make up the phantom component. A substitute component cannot be a phantom or a component of a phantom. Where substitutes exist for a component, the component cannot be changed to a phantom.

Editing or Issuing Components for Production Schedules

You can also use the Edit/Issue process to consume existing pending quantities for a production schedule. After selecting the area or item and dates of the production schedule and clicking the **Search** button,

a message appears if there are any existing pending quantities for production schedules that match the selection criteria. If **Yes**, then the components with existing pending quantities appear.

Workflow Notification

If you have enabled PeopleSoft Workflow, you can use the Replenishment Notification workflow to notify the stockroom when the quantity on hand for components with a component issue method of Production Replenishment falls below its minimum stocking quantity in that location. This notification indicates that the location must be replenished.

Note: When you're editing or issuing components, the system doesn't allow you to modify component information for components whose issue method is *Kit*. Use the Kit Issue/Return Component to edit or issue these components. Additionally, you can view but cannot modify components whose source code is *Floor Stock*.

Issuing Components and Effects on Quantities

Action	Results to Quantities
Issuing components to production	Decreases the business unit's on-hand quantity.
Returning components to inventory	Increases the business unit's on-hand quantity.
Issuing material from a nettable, available WIP location	Decreases the business unit's reserved quantity.
Returning components to a nettable, available WIP location	Increases the business unit's reserved quantity.
For owned items, issuing components to production	Decreases the business unit's owned quantity.
Returning owned components to inventory	Increases the business unit's owned quantity.
Issuing components to production	Decreases the storage location's quantity.
Returning components to inventory	Increases the storage location's quantity.
Issuing lot-controlled components to production	Decreases the lot quantity on-hand.
Returning lot-controlled components to inventory	Increases the lot quantity on-hand.

Capacity Checking

You activate weight and volume capacity checking on the PeopleSoft Inventory Options page, and define the capacity for each storage location on the Volume/Weight Capacity page accessible from the Material Storage Locations page.

If the item is designated as an isolate item on the Inventory-Shipping/Handling page in the Define Business Unit Item component, it can only be put away or transferred to empty storage locations or to locations containing stock with the same item ID. The system prevents you from moving an isolate item to a WIP location with other items.

If you designate a WIP location as storing only one item on the Volume/Weight Capacity page that is accessible from the Material Storage Locations page, the system only issues material with that item ID to that location. If you do not specify an item ID for a single-item WIP location, the first issue transaction to the empty WIP location defines the only item ID that the location can contain until the item quantity has been fully depleted.

Pages Used to Edit or Issue Components

Page Name	Definition Name	Usage
<u>Production Selection Page</u>	SF_ED_COMPS_SELECT	Select the production ID or production schedule for which you want to edit or issue components. Components must have an issue method of Issue or Replenish to use this page.
<u>Edit/Issue Components Summary Page</u>	SF_EDIT_COMPS_EDIT	Edit or view components. In addition, use this page to edit or issue components during the Record Completions and Scrap process or after the Record Completions/Scrap process has been run.
<u>Edit/Issue Express Page</u>	SF_EDIT_COMPS_EXPR	(Optional) Select lot- or serial-controlled components that have pending issue or pending loss quantities. You can view or change lots assigned to lot-controlled components by the backflush lot selection rule.
<u>Lot/Serial Number Selection Page</u>	SF_ED_CMP_SBP_GRD	(Optional) Select the lot or serial numbers or both of the lot- or serial-controlled components to be consumed during the completions process. You must enter a pending quantity greater than zero for a serial-controlled or lot-controlled component before the Lot/Serial scroll area is available.
<u>Edit/Issue Components Detail Page</u>	SF_EDIT_COMPS_DET	View detailed information for each component for selected production.
<u>Production History Page</u>	SF_TRANSHIST	View production transaction history for components.

Page Name	Definition Name	Usage
Transaction History Details inquiry Page	SF_TXN_HIST_SP	View completions details based on the selection criteria. <u>Production History Page</u>

Production Selection Page

Use the Production Selection page (SF_ED_COMPS_SELECT) to select the production ID or production schedule for which you want to edit or issue components.

Components must have an issue method of Issue or Replenish to use this page.

Navigation:

Production Control > Process Production > Issue Materials > Edit/Issue Components > Production Selection

Field or Control	Description
Production ID	Enter a value to edit or issue components for a production ID.
Production Area and Item ID	Enter values to edit or issue components for a production schedule.
Revision	Displays if the item entered is revision-controlled. You can change the revision code if you're building to a different revision.
Eff Date (effective date)	Displays the current date if the item is not revision-controlled. The revision or effective date determines the BOM configuration used to create the component list.
BOM/Rtg Effdt	Select a value if you have predefined specific BOM and routing combinations with the Production Options maintenance pages.
	Click the Select BOM/Routing button next to the BOM/Rtg Effdt field to access the Select BOM/Routing page to select a different BOM and routing combination.
BOM Code and Routing Code	Displays valid codes for the BOM and routing code combination.
Search	Click the Search button to retrieve the information associated with the production ID or production schedule.

Related Links

[Understanding Production Options](#)

Edit/Issue Components Summary Page



Use the Edit/Issue Components Summary page (SF_EDIT_COMPS_EDIT) to edit or view components.

In addition, use this page to edit or issue components during the Record Completions and Scrap process or after the Record Completions/Scrap process has been run.

Navigation:

- **Production Control > Process Production > Complete Production > Record Completions and Scrap > Edit/Issue Components Summary** if you are editing or issuing components during the completions process
- **Production Control > Process Production > Issue Materials > Edit/Issue Components > Edit/Issue Components Summary** if you are editing or issuing components after you've recorded completions and scrap

This example illustrates the fields and controls on the Edit/Issue Components Summary page . You can find definitions for the fields and controls later on this page.

Field or Control	Description
Print at Save	Select this check box if you want to print production documents for a particular production ID at save time.
Setup Print Options	Click this link to access the Process/Output Options page to select different print criteria for the production documents.
	Click the Express Page button to access the Edit/Issue Express page to view or assign serial and lot numbers.
	Click the Detail button to access the Edit/Issue Component Detail page.
	Click the Item Search button to access the Item Search, Item Availability, or Item Substitution pages.

Field or Control	Description
<p>Op Seq (operation sequence)</p>	<p>Determines the WIP inventory location to which the components are issued and from which they are consumed. When you add a new component to the component list, the operation sequence defaults to zero. When recording end item completions and scrap, the system consumes a component with an operation sequence of zero at the first operation and decrements the component quantity on hand in the production area's default WIP location.</p> <p>You can change the operation sequence to any valid operation on the end item's operation list. When you select an operation sequence, the component must be issued to and is consumed from the WIP location associated with the operations work center.</p>
<p>Per</p>	<p>Indicates whether the quantity required is per assembly (<i>Asy</i>) or per order (<i>Ord</i>). Per assembly indicates the quantity required to complete one end item. Per order indicates the amount required, regardless of the end items that will be produced.</p> <ul style="list-style-type: none"> • If the component is per assembly, the system calculates the consumed quantity by multiplying the quantity per by the end item completion and scrapped quantity. • If the component is per order, and you're recording completions for a production ID, the system consumes the full order quantity during the first recorded backflush. <p>Once consumed, it will not be consumed again during any subsequent backflushes. If you're recording completions for a production schedule, the consumption of a per order quantity depends on the Manufacturing Options setting for Calc Per Order for Production Schedules.</p>

Field or Control	Description
<p>Pending Issue Qty (pending issue quantity)</p>	<p>The system calculates this value for those components whose operations have had end item completions or scrap reported.</p> <p>Enter a new pending issue quantity if you consumed more or less than the quantity calculated.</p> <p>The pending issue quantity is based on the quantity completed plus the quantity scrapped multiplied by the quantity per assembly. If the quantity on the component list is expressed in terms of quantity per order, the full quantity appears. This quantity is consumed only at the time of the first backflush for production ID. For production schedules, the Calc Per Order for Production Schedules option on the Manufacturing Business Unit Option page determines how the quantity is displayed.</p> <p>If you have enabled PeopleSoft Workflow, the system sends a notice to the production supervisor that there is a nonzero quantity for this component. PeopleSoft Manufacturing uses the Identify Production with Pending Quantities workflow for this notification.</p> <ul style="list-style-type: none"> • If the option is set to <i>Calc Per Order for Prdn Sched</i>, the system displays the per order quantity for every production schedule completion. <p>If you have already consumed the order quantity for the production run, you must zero out this amount.</p> <ul style="list-style-type: none"> • If the option is set to <i>do not Calc Per Ord on Prdn Sched</i>, the system doesn't display any per order quantity for any production schedule completion. <p>In this instance, you must enter the order quantity when the material is consumed for the production run.</p>
<p>Pending Yield Loss Qty</p>	<p>If the quantity of components lost is more or less than planned, indicate the new pending yield loss quantity here. If the item's yield loss is set to calculate the pending yield loss quantity, then the system calculates the pending yield loss for those components whose operations have had end item completions or scrap reported. You define whether or not you want the system to calculate pending yield loss quantity at the business unit or item level. If you do not want the system to calculate pending yield loss quantity, then you manually record the yield loss at the appropriate times.</p> <p>The system uses this formula to calculate the pending yield loss quantity:</p> $\text{(Quantity Completed + Quantity Scrapped)} \times \text{Expected Yield Loss Percentage}$ $\text{Expected Yield Loss Percentage} = (1 - \text{Component Yield} / 100)$

Adding or Substituting Components

Field or Control	Description
Component ID, Op Seq (operation sequence), Per Asy (assembly) or Ord (order), Pending Issue Qty (pending issue quantity), and Pending Yield Loss Qty (pending yield loss quantity)	Enter values for these fields if you're adding or substituting components. <hr/> Note: Pending issue and pending yield loss quantities are not calculated for expensed or floor stock items. In addition, you cannot enter values for components with an issue method of Kit. <hr/> To change or enter the quantity per, yield, or scheduled quantity, use the Edit/Issue Component Detail page. If you're substituting a component, zero out the pending issue and pending yield loss quantity for the original component.

Allowing Negative On Hand Inventory

If the PeopleSoft Inventory business unit parameter allows negative inventory balances and there is not enough material in the WIP location to cover the pending issue or pending yield loss quantity, the quantity on hand in the WIP location will become negative. Another business unit parameter determines when the system issues a warning message prior to driving quantity on hand negative. This message allows you to decide whether to continue with the completion transaction or to wait until the inventory is moved into the WIP location before continuing. If you do not allow the inventory to go negative, the quantity that couldn't be consumed remains in the pending issue or pending yield loss fields. These must be reconciled once the WIP location has sufficient quantity on hand.

Note: If the item that you're consuming is serial-controlled, you cannot drive the quantity on hand negative, regardless of the PeopleSoft Inventory business unit setting.

Edit/Issue Express Page

Use the Edit/Issue Express page (SF_EDIT_COMPS_EXPR) to (Optional) Select lot- or serial-controlled components that have pending issue or pending loss quantities.

You can view or change lots assigned to lot-controlled components by the backflush lot selection rule.

Navigation:

- **Production Control > Process Production > Issue Materials > Edit/Issue Components > Edit/Issue Express.** Click the Edit/Issue Express link.
- **Production Control > Process Production > Complete Production > Record Completions/Scrap > Edit/Issue Express.** Click the Edit/Issue Express link on the Edit/Issue Components Summary process page.

This example illustrates the fields and controls on the Edit/Issue Components - Edit/Issue Express page. You can find definitions for the fields and controls later on this page.

The screenshot shows the 'Edit/Issue Express' page with the following elements:

- Navigation tabs: Production Selection, Record Completions/Scrap, Edit/Issue Components Summary, **Edit/Issue Express**, Edit/Issue Components Detail.
- Form fields: Business Unit, Item ID, Serial in Prdn, Area, Prdn ID NEXT, Prdn Type Production, Sort Components by Op Seq.
- Component Details section: Find | View All, First 1 of 1 Last, *Component ID, Op Seq 0, Detail, Pending Issue Qty 0.0000, Pend Loss 0.0000.

Field or Control	Description
Component Details	<p>You can change any of this information on this page:</p> <ul style="list-style-type: none"> • Component ID • Pending issue quantity • Operation sequence • Pending loss

Lot/Serial Number Selection Page

Use the Lot/Serial Number Selection page (SF_ED_CMP_SBP_GRD) to (Optional) Select the lot or serial numbers or both of the lot- or serial-controlled components to be consumed during the completions process.

You must enter a pending quantity greater than zero for a serial-controlled or lot-controlled component before the Lot/Serial scroll area is available.

Navigation:

Production Control > Process Production > Complete Production > Record Completions and Scrap > Edit/Issue Express

Click the Select Lot/Serial link.

Field or Control	Description
Sel (select)	Select the serial-numbered components that you want to consume by selecting one or more check boxes.

Edit/Issue Express Page

Access the Lot/Serial scroll area on the Edit/Issue Express page (**Production Control > Process Production > Complete Production > Record Completions and Scrap > Edit/Issue Express**).

Field or Control	Description
Lot ID	Select a lot if you're editing or issuing lot-controlled components. You can view or change lots assigned by the backflush lot selection rule.
Qty Req (required quantity)	Specify the amount of components that you want to consume from each lot. This field can be automatically populated during backflush using the backflush lot selection rule.

Related Links

[Automatically Consuming Lot-Controlled Stock During a Backflush](#)

Edit/Issue Components Detail Page

Use the Edit/Issue Components Detail page (SF_EDIT_COMPS_DET) to view detailed information for each component for selected production.

Navigation:

- **Production Control > Process Production > Complete Production > Record Completions and Scrap > Edit/Issue Components Detail**
- **Production Control > Process Production > Issue Materials > Edit/Issue Components > Edit/Issue Components Summary.** Click the **Detail** button next to the component you want to edit or view.

This example illustrates the fields and controls on the Edit/Issue Components Detail page. You can find definitions for the fields and controls later on this page.

The screenshot displays the 'Edit/Issue Components Detail' page. At the top, there are navigation tabs: 'Production Selection', 'Record Completions/Scrap', 'Edit/Issue Components Summary', 'Edit/Issue Express', and 'Edit/Issue Components Detail'. Below the tabs, the page is divided into several sections:

- Business Unit:** Prdn ID NEXT, Status, Item ID.
- Area:** Prdn Type Production.
- Serial in Prdn:** A checkbox.
- Expected Yield %:** 100.0000.
- Sort Components by:** A dropdown menu set to 'Op Seq'.
- Component Details:** A section with a search bar and navigation buttons (Find, View All, First, 1 of 1, Last).
- *Component ID:** A text input field.
- Teardown:** A checkbox.
- Substitute:** A checkbox.
- Issue Method:** A dropdown menu.
- Source Code:** A text input field.
- Op Seq:** A text input field with the value '0'.
- Qty:** A text input field with the value '0.0000'.
- *Per:** A dropdown menu with the value 'Asy'.
- *Yield:** A text input field with the value '100.0000'.
- Sched Qty:** A text input field with the value '0.0000'.
- Orig Comp ID:** A text input field.
- Trace Usage:** A section with fields for Std UOM, Non-Owned, Pending Issue Qty (0.0000), Issue Qty (0.0000), Pending Loss (0.0000), and Yield Loss Qty (0.0000).

Component Details

Field or Control	Description
Component ID, Op Seq (operation sequence), Qty (quantity), quantity Per , Yield , and Sched Qty (scheduled quantity)	Enter or modify values for these fields.
Work Center Detail	Click this link to access work center-related information.
Qty (quantity)	The calculated quantity per is next to this field. The system calculates the quantity per by dividing the quantity per assembly by the bill of material's BOM quantity. You designate the level of precision for the calculated quantity per on the Manufacturing installation options page.
Pending Issue Qty (pending issue quantity) and Pending Yield Loss Qty (pending yield loss quantity)	<p>Although these values appear by default from the Edit/Issue Components Summary page, you can change them here.</p> <hr/> <p>Note: If you are not completing end items, a pending issue or pending yield loss quantity greater than zero indicates that the components couldn't be consumed from the appropriate WIP location from a previous completions or edit components transaction. This is due to a shortage of the component in the WIP location associated with the component's operation sequence.</p> <hr/>
Issue Qty (issue quantity)	<p>This field represents the quantity consumed that was issued from the WIP location for the component and was charged to WIP. For items using the Kit issue method, this is the quantity that was issued during Material Release of a production Pick Plan or issued using the Issue/Return Kit Components page.</p> <p>You cannot modify kitted components here. This field is used for production IDs only.</p>
Yield Loss Qty (yield loss quantity)	<p>This field represents the component quantity that was scrapped during end item completion and issued from the WIP location.</p> <p>This field is used for production IDs only.</p>
Issue Method	This field indicates the component replenishment issue method.

Note: Quantities of an item that are stored in a nettable, available WIP location and reserved for production use are not available for other purposes.

Identifying Material Shortages

An Application Engine process queries the production component table for any outstanding pending component quantities for production with a status of In Process or Pending Complete. If the system finds outstanding quantities, the system issues a worklist notification for each of the qualified production orders to relieve the component. When you work the worklist entry, you're transferred to the Edit/Issue Components Summary page. Once you consume material to relieve the shortages, the worklist entry is marked as completed.

Running the Completions Update COBOL/SQR Process (SFPDCDRV)

The Prdn Cmpl/Scrap (SFPDCDRV) process (Production Completions and Scrap process) updates completions transactions that are staged by other processes, such as Edit Components updates, production completions, or subcontracted completions recorded through electronic data collection. In addition, you run this process to update production quantities for production schedule completions and scrap. You run this process if you selected *Stage Compltns/Putaway on Save* as the completions action on the Record Completions/Scrap page.

Page Used to Run the Completions Update COBOL/SQR Process (SFPDCDRV)

<i>Page Name</i>	<i>Definition Name</i>	<i>Usage</i>
<u>Prdn Cmpl/Scrap Page</u>	BCT_MG_REQCOMP	Update completions transactions that are staged by other processes and for production schedules.

Prdn Cmpl/Scrap Page

Use the Prdn Cmpl/Scrap page (BCT_MG_REQCOMP) to update completions transactions that are staged by other processes and for production schedules.

Navigation:

- **Production Control > Process Production > Complete Production > Process Completions and Scrap**
- **SCM Integrations > Process Transactions > Manufacturing > Process WO Completions**

<i>Field or Control</i>	<i>Description</i>
Unit and Request ID	Enter values for this process.
Run	Click to run this request. Process Scheduler runs the Completions/Scrap Update process at user-defined intervals.

Creating Reversing Entries to Correct Data Entry Errors

Use the Record Completions/Scrap component to create reversing entries to correct data entry errors made when recording end item completions or scrap.

Enter a negative number to reverse the completion or scrap entry. For example, suppose that an entry was made to record a completion of 8 end items at operation 20, but only 6 end items were actually completed. You can enter a -2 in the Completed Qty (completed quantity) field to reverse the original entry of 8. This brings the completed quantity balance for that operation to 6.

This reversing entry:

- Rebalances the completions or scrap count.
- In the case of a production schedule, rolls back the reversing entry through all prior operations.
- In the case of a production ID, rolls back the reversing entry through the specified prior operation, or back to the previous count point.
- Automatically returns any components that were consumed at the current operation to the appropriate WIP location.
- Creates a reversing entry for earned labor, machine, and overhead costs.

Pages Used to Create Reversing Entries to Correct Data Entry Errors

<i>Page Name</i>	<i>Definition Name</i>	<i>Usage</i>
Production Selection Page	SF_COMPL_SELECTION	Select a production ID or production schedule to create reversing entries.
Record Completions/Scrap Page	SF_COMPL_ID	Enter reversing entries for selected production.
Production Scrap Details Page	SF_COMPL_SCRAP	Enter any reversing entries to scrapped quantities, if applicable.
Apply Defaults Page	SF_COMPL_DEFAULTS	Select the putaway locations for the reversing entries.
Lot/Serial Number Selection Page	SF_ED_CMP_SBP_GRD	(Optional) Select the serial numbers of the serial-controlled components to be returned.
Lot/Serial Number Selection scroll area Page	SF_ED_CMP_SBP_GRD	(Optional) Identify the lots from which you want to return lot-controlled components.

Identifying Production for Data Entry Error Corrections

<i>Field or Control</i>	<i>Description</i>
Negative Completions	Select this option to create reversing entries to correct data entry errors.
Unit and Production ID	Select values to reverse entries for a production ID.
Unit, Production Area, and Item	Select values to reverse entries for a production schedule.
BOM/Rtg Effdt	Enter an effective date to determine the particular BOM and routing combination for which you want to complete.
Peg Schedule	Click this link if you want to select a specific production schedule.
Search	Click this button to retrieve the selected production information.

Note: If you attempt to perform negative completions and you haven't recorded any positive completions, the system displays an error message. If you click **Yes** to continue, you are able to record positive completions. If you click **No**, the system returns you to the Production Selection process page.

If you attempt to perform negative completions and you cannot find the quantity in the location you expected, you may not have run the Completions Update process and the putaway process.

Record Completions/Scrap Page

Use the Record Completions/Scrap page (SF_COMPL_ID) to enter reversing entries for selected production.

Navigation:

Production Control > Process Production > Complete Production > Record Completions and Scrap > Record Completion/Scrap

This example illustrates the fields and controls on the Record Completions/Scrap page. You can find definitions for the fields and controls later on this page.

The screenshot shows the 'Record Completions/Scrap' page for production ID PRD00127. Key fields include 'Completed Qty' (0.0000), 'Scrap Qty' (0.0000), and 'Quality'. There are also checkboxes for 'Update Prior Operations' and 'Back Thru Operation'. A table titled 'Operations Data' lists three operations: 10 FI-ASSY (FORK), 20 PAINT01 (PAINT), and 30 FI-ASSY (FINAL).

Op Seq	Work Center	Task Code	Count Point	Assy Starts Qty	Quantity Issued to Operation	Qty Cpl/Th	Assembly Qty Scrapped at Op	Expcd Cmpl Qty	Op Yld %	Setup Earned	Post Prod	Sub Op
10	FI-ASSY	FORK	N	100.0000	0.0000	0.0000	0.0000	100.0000	100.0000	N	N	N
20	PAINT01	PAINT	N	100.0000	0.0000	0.0000	0.0000	100.0000	100.0000	N	N	N
30	FI-ASSY	FINAL	N	100.0000	0.0000	0.0000	0.0000	100.0000	100.0000	N	N	N

Field or Control	Description
Completed Qty (completed quantity)	<p>Enter a <i>negative</i> return quantity in this field.</p> <hr/> <p>Note: If you enter a negative quantity in the <i>Completed Qty</i> (completed quantity) field, and you didn't select the negative completion on the Record Completions/Scrap - Production Selection page, you receive a message asking if you're doing a negative transaction. If Yes, then the transaction automatically selects the <i>Negative Completions</i> option for you, and you do not have to return to the Production Selection page and select the Negative Completions check box.</p>
Enter Scrap Data	<p>Click this link to correct the scrapped component quantities.</p>
Quality	<p>Click the Quality link to initiate a data entry session and to transfer to either the Data Entry - Subgroup Method page or the Data Entry - Sample Method page in PeopleSoft Quality, depending on the data entry method that you specified when creating the quality control plan.</p> <hr/> <p>Note: The Quality link is available for each end item in the Output Details scroll area. You can transfer completions data to PeopleSoft Quality for each end item.</p>
Update Prior Operations and Back Thru Operation	<p>You can enter values for these fields if you're creating a reversing entry for production IDs.</p>
Lot ID	<p>Select a value if you're creating a reversing entry for lot-controlled end items.</p>

Field or Control	Description
Area	Specify the storage area and inventory locations from which you want to pull the completed end items.
Return Qty (return quantity)	Enter a <i>negative</i> number in this field.
Serial IDs	Click this link if you're correcting data entry errors for serial-controlled components. Select each serialized item that you want to move back into production by selecting one or more serial IDs.

Note: Reversing entries are processed when you save the Record Completions/Scrap page.

Creating a Reversing Entry for the First Operation, an Intermediate Operation, a Count Point, or for Scrap at Any Operation

If you're creating a reversing entry for the first operation, an intermediate operation, count point, or for scrap at any operation, the system reverses the earned production costs or the scrap costs for those end items at that operation and moves them back to the specified prior operation or count point. In addition, the system returns all consumed components to the WIP location.

Example: Negative Completions When Using Count Points

Count point operations: 30, 50

Production start quantity: 10

Step 1

Production start quantity completed: 10

Completing at operation sequence: 30

Back through operation sequence: 10

In this example, you're completing operations and scrap for a quantity of 10 at operation sequence 30, which is a production ID count point. You selected the **Update Prior Operations** check box on the Record Completions/Scrap page, and indicated that you wanted to update previous operations back to operation sequence 10. The system calculates the production completed at operation sequences 10, 20, and 30:

Operation Sequence	Quantity Issued	Quantity Completed Through	Quantity Scrapped
10	10	10	0
20	10	10	0

<i>Operation Sequence</i>	<i>Quantity Issued</i>	<i>Quantity Completed Through</i>	<i>Quantity Scrapped</i>
30 (count point)	10	10	0
40	10	0	0
50 (count point)	0	0	0

Step 2

Production start quantity issued or returned: -5

Reversing end item completions at operation sequence: 3

Update previous back through operation sequence: 10

In this example, you're returning a quantity of 5 at operation sequence 30, which is a count point. You selected the **Update Prior Operations** check box on the Record Completions/Scrap page, and indicated that you wanted to update previous operations back to operation sequence 10. The system recalculates and reverses the quantity issued to the operation at operation sequence 40:

<i>Operation Sequence</i>	<i>Quantity Issued</i>	<i>Quantity Completed Through</i>	<i>Quantity Scrapped</i>
10	5	5	0
20	5	5	0
30 (count point)	5	5	0
40	5	0	0
50 (count point)	0	0	0

Example: Negative Completions When Not Using Count Points

Production start quantity: 10

Step 1

Production start quantity completed: 10

Completing at operation sequence: 30

Back through operation sequence: 10

In this example, you're completing operations and scrap for a quantity of 10 at operation sequence 30. You selected the **Update Prior Operations** check box on the Record Completions/Scrap page, and indicated that you wanted to update previous operations back to operation sequence 10. The system recalculates and reverses the production completed at operation sequences 10, 20, and 30:

<i>Operation Sequence</i>	<i>Quantity Issued</i>	<i>Quantity Completed Through</i>	<i>Quantity Scrapped</i>
10	10	10	0
20	10	10	0
30	10	10	0
40	10	0	0
50	0	0	0

Creating a Reversing Entry at the Last Operation for Completed End Items

If you're creating a reversing entry for the last operation, the system reverses the earned production costs for those end items at the last operation.

To create a reversing entry for the last operation, you must specify the storage area or production area from which you're removing the previously completed end items. You also must complete these:

- For completed end items, select the inventory or WIP location from which you want to remove the items.
- Select which serial- or lot-controlled items need to be moved back into production, if the completed end items are serial-controlled or assigned to a lot.

Completing Production

For production IDs, use the Complete Production page to indicate that:

- Setup has been completed at the operation even though you are not recording any end item completions.

This enables you to earn the setup costs for the production run. Setup is automatically earned when the first end item completion or scrap is recorded.

- Post production work has been completed at the operation.
- Production for all operations has been completed.

Pages Used to Complete Production

Page Name	Definition Name	Usage
Production Selection Page	SF_COMPL_SELECTION	Select a production ID to record completions and scrap.
<u>Record Completions/Scrap - Output Details scroll area Page</u>	SF_COMPL_ID	Enter completions and scrap information for the production ID.
<u>Complete Production Page</u>	SF_COMPL_PRDN	Indicate that production at all operation sequences has been completed.

Complete Production Page

Use the Complete Production page (SF_COMPL_PRDN) to indicate that production at all operation sequences has been completed.

Navigation:

Production Control > Process Production > Complete Production > Record Completions and Scrap > Record Completion/Scrap

Click the Complete Production link.

Field or Control	Description
Update Set Up Costs	Select this check box if you want to indicate that setup work has been completed without recording the completion of any end items.
Update Post Production Costs	<p>Select this check box if the post production work is complete. Post production is not automatically earned even if all end items have been recorded as complete at the operation.</p> <p>By selecting either check box, you earn the setup and post production time, and the labor, machine, and overhead value are included as part of the WIP inventory value.</p> <p>You can earn setup and post-production costs only once. Also, you can earn setup costs automatically when the first completion is recorded at the operation. You cannot earn setup costs with any subsequent operation completions.</p> <p>To reverse any previously earned setup or post-production costs, select the check boxes again. This creates a reversing entry for any setup or post-production time previously earned.</p>
Production Completed	Select this check box to indicate that all production is complete at all operations and that no additional end item completions or scrap will be recorded. Selecting this option changes the status of the production ID to Pending Complete.

<i>Field or Control</i>	<i>Description</i>
Return	Click to return to the Record Completions/Scrap page.
Save	Click to run the Complete Production process.

Moving Excess Inventory Back to a Stores Location

When the last end item is completed or the production run is finished, move any excess WIP components with an issue method of issue or replenish back to their appropriate stores location. Once you've identified the excess WIP inventory, run a transfer transaction using PeopleSoft Inventory. The transfer process moves the excess WIP components from the WIP location back to the stores location.

Use Kit Issues/Return to return excess components whose issue method is Kit.

Viewing and Reporting Material Shortages

PeopleSoft Manufacturing provides a shortage report, which enables you to view, at a glance, the shortages for each production order or production run sorted by production ID or components. The system tells you where shortages exist, so you can move inventory to those areas to relieve production shortages.

Pages Used to View and Report Material Shortages

<i>Page Name</i>	<i>Definition Name</i>	<i>Usage</i>
Review Material Shortage - Selection Page	SF_MTL_SHORT_SEL	Select production to view material shortage information.
Shortages Page	SF_MTL_SHORT_GRD	View material shortage information.
Shortage Report Selection Page	RUN_SFS2001	Select production with shortages to generate a shortage report.
Production Selection Page	RUN_SFS2001B	Define additional shortage report criteria.

Viewing Scrap and Earned Conversion Cost Information

On a periodic basis, you want to monitor scrap and earned conversion costs associated with production. Viewing this information gives you a good idea of how the manufacturing floor is performing. PeopleSoft Manufacturing provides you with the ability to view scrap and earned conversion costs for production IDs and schedules in the production environment.

Pages Used to View Scrap and Earned Conversion Cost Information

Page Name	Definition Name	Usage
Review Scrap Costs Page	SF_SCRAP_INQUIRY	Select production with scrap costs for a particular production ID or production schedule.
Scrap List by Operation Page	SF_SCRAP_INQ_OP	View scrap information by operation sequence for a specific production ID or production schedule.
Scrap Cost Detail Page	SF_SCRAP_INQ	View detailed scrap costs for the production ID or schedule broken down by operation sequence.
Production Selection Page	SF_EARNCON_INQUIRY	Select a particular production ID or production schedule to view earned conversion costs.
Earned Conversion Cost by Operation Page	SF_EARNCON_INQ_OP	View conversion cost information by operation sequence for a specific production ID or production schedule.
Earned Conversion Cost Detail Page	SF_EARNCON_INQ	View earned conversion cost detail for production.

Recording and Viewing Actual Machine and Labor Hours

PeopleSoft Manufacturing provides you with the ability to record and view actual labor and machine hours incurred during the manufacturing process.

Pages Used to Record and View Actual Machine and Labor Hours

Page Name	Definition Name	Usage
Production Selection Page	SF_ACTHR_SELECTION	Select the production that you want to record actual machine and labor hours incurred during the production process. Record Actual Hours Page
Record Actual Hours Page	SF_ACTHRS_NEW	Enter labor and machine hours for the selected production.

Page Name	Definition Name	Usage
Review Actual Hours - Production Selection Page	SF_ACTHRS_INQUIRY	Select a specific production ID or production schedule to view actual labor and labor information. Record Actual Hours Page
Actual Hours by Operation Page	SF_ACTHRS_INQ_GRD	View actual labor and machine hours for a production ID or schedule by operation. Record Actual Hours Page
Actual Hours Detail Page	SF_ACTHRS_INQ	View detailed information on actual labor and machine hours for a production ID or schedule by operation. Record Actual Hours Page
Crew/Machine Resources Detail Page	SF_ACTHRS_INQ_SEC	View the resource details for the crew or machine. Record Actual Hours Page

Record Actual Hours Page

Use the Record Actual Hours page (SF_ACTHRS_NEW) to enter labor and machine hours for the selected production.

Navigation:

Production Control > Process Production > Complete Production > Record Actual Hours > Record Actual Hours

This example illustrates the fields and controls on the Record Actual Hours page. You can find definitions for the fields and controls later on this page.

Production Selection		Record Actual Hours	
Business Unit	US008	Production Type	Production
Production ID	PRD00223	In Process	Std UOM EA
Production Area	GEARS	Entry Date	
Item ID	SR2201	Gear Subassembly	
Work Center	<input type="text"/>	Resource	Descr
Op Seq	<input type="text" value="0"/>	Crew	<input type="text" value="0.00"/>
		Machine	<input type="text" value="0.00"/>
<input type="checkbox"/> Crew Reporting <input type="checkbox"/> Machine Reporting Shift Code <input type="text"/>		Labor Setup <input type="text" value="0.00"/> Labor Run <input type="text" value="0.00"/> Labor Fixed Run <input type="text" value="0.00"/> Labor Post Production <input type="text" value="0.00"/> Labor Scheduled Hours <input type="text" value="0.00"/>	Machine Setup <input type="text" value="0.00"/> Machine Run <input type="text" value="0.00"/> Machine Fixed Run <input type="text" value="0.00"/> Machine Post Production <input type="text" value="0.00"/> Machine Scheduled Hours <input type="text" value="0.00"/>

Field or Control	Description
Op Seq (operation sequence) and Work Center	<p>Select values for either field. If you select the operation sequence, the work center, crew, and machine information associated with the operation sequence appears on the page.</p> <p>You can, however, change these values.</p> <p>For production IDs, the operation sequences listed are from the production ID's operation list. The operation sequences for production schedules are the item's routing for the routing code specified for the area or item.</p> <p>If you select the work center, you can select from all available work centers to accommodate any changes that might have occurred on the routing during production. Once you select the work center, the default crew and machine information appears based on the work center information. You can accept or change these defaults.</p> <hr/> <p>Note: If you then enter an operation sequence, the work center information is changed to the work center associated with the operation sequence, if it is different.</p>
Crew Reporting	If you select this option, the system multiplies the actual labor hours that you record by the crew size to determine the total number of actual labor hours for performance reporting.
Machine Reporting	If you select this option, the system multiplies the actual machine hours that you record by the number of machines to determine the total number of actual machine hours for performance reporting.

Field or Control	Description
Labor Hours or Machine Hours	Enter the number of hours based on: <ul style="list-style-type: none"> • Setup • Run • Fixed run • Post production <hr/> Note: Enter negative hours in these fields to correct data entry errors.
Scheduled	Enter any number of scheduled hours when there is known downtime for the work center. Scheduled hours are used to calculate labor and machine utilization. If no scheduled hours are entered, the system calculates the available hours based on either the work center or production calendar.

Note: You can enter actual hours for any labor or machine time type even if the time type wasn't included for planning or costing purposes. For example, if no costing postproduction time was specified for the operation, but actual time was spent cleaning up the work center once production was completed, you can still enter those actual hours.

Recording Completions and Scrap Using Electronic Data Collection

Understanding the Process of Recording Completions and Scrap Using Electronic Data Collection

You can record completions and scrap for the production using electronic data collection.

You can access the electronic data collection transaction pages through the SCM Integrations navigation as well as processing them using electronic data collection hardware. When you save an electronic data collection transaction page, the page clears so that you can enter another transaction immediately. The transaction is saved in the transaction log until it is processed by background processes that can be set up to continually scan the transaction log.

The background processes validate all information before any updates are performed. However, when you enter the transactions through the data collection pages, the system verifies the data you have entered in selected fields.

PeopleSoft Manufacturing provides the Production Completions (PRODUCTION_ORDER_COMPLETION) EIP to enable you to import completions and scrap data for the production using electronic data collection.

Note: To correct errors, you must use the online completions pages to enter negative completions and reverse the completions transactions.

Capacity Checking

You activate weight and volume capacity checking on the PeopleSoft Inventory Options page, and define the capacity for each storage location on the Volume/Weight Capacity page, which you can access from the Material Storage Locations page.

If the item is designated as an isolate item on the Inventory-Shipping/Handling page in the Define Business Unit Item component, you can only put it away or transfer it to empty storage locations or to locations containing stock with the same item ID. The system prevents you from putting away an isolate item to a location with other items.

If you designate a storage location as storing only one item on the Volume/Weight Capacity page, the system only puts away material with that item ID in the location. If you do not specify an item ID for a single-item storage location, the first putaway transaction to the empty storage location defines the only item ID that the location can contain until the item quantity has been fully depleted.

Common Elements Used in Recording Completions and Scrap Using Electronic Data Collection

<i>Field or Control</i>	<i>Description</i>
Completed Qty (completed quantity)	Enter the number of completed end items in this field.
Scrap Qty (scrapped quantity) and Scrap Pct (scrapped percentage)	Enter values for these fields.
Reason Code	Enter a value. This field is required if you entered a scrap quantity.
Distrib. Type (distribution type)	(Optional) Select the account to which you want to charge the scrap.
Lot ID	Select a value if the end item is lot-controlled.
Load Serial Rows	If the end item is serial-controlled or being tracked by serial genealogy (serial in production), enter a completed quantity and click this button. The system then creates as many Serial ID fields as the completed quantity, and you can enter the serial IDs for each completed item. The quantity completed and quantity scrapped must be whole numbers for serial-controlled items.

Recording Completions Using Electronic Data Collection

This section discusses how to Record Completions Using Electronic Data Collection

Pages Used to Record Completions Using Electronic Data Collection

<i>Page Name</i>	<i>Definition Name</i>	<i>Usage</i>
<u>Production Completion/Scrap Page</u>	BCT_MG_CPL	Record completions and scrap for these transactions: <ul style="list-style-type: none"> • 0211 Prdn Sched Compl/Scrap Stock • 0212 Prdn ID Compl/Scrap to Stock • 0213 Prdn ID Operation Compl/Scrap

<i>Page Name</i>	<i>Definition Name</i>	<i>Usage</i>
<u>Multiple Out Completion/Scrap Page</u>	BCT_MG_MCPL	Record operation completions for production IDs with multiple outputs using electronic data collection: <ul style="list-style-type: none"> 0214 - Prdn Sched Multiple Completion 0215 - PrdnID Multiple Compl to Stock 0216 - Prdn ID Operation Mult Compl

Production Completion/Scrap Page

Use the Completion/Scrap page (BCT_MG_CPL) to record completions and scrap

Navigation:

SCM Integrations > Create Transactions > Manufacturing > Record WO Completion and Scrap

This example illustrates the fields and controls on the Production Completion/Scrap page (for production schedules). You can find definitions for the fields and controls later on this page.

Production Completions/Scrap

Business Unit: US008 Last Transaction Nbr: 3000000000000150000000001

Trans Code: 0211 Prdn Sched Compl/Scrap Stock

Area:

Item ID:

Revision: BOM/Rtg Effdt: 08/07/2009 BOM Code:

Compl Qty: Std UOM: Routing Code:

Scrap Qty: Scrap Pct:

Reason Code: Distrib. Type:

To Prdn ID: Op Seq: 0 Container ID:

Storage Loc: Lot ID:

Serial ID	Find First 1 of 1 Last
Serial ID: 1 <input style="width: 150px;" type="text"/>	

Note: To correct errors, you must use the online completions pages to enter negative completions and reverse completion transactions.

Field or Control	Description
Area, Item ID, and BOM/Rtg Effdt (BOM/routing effectivity date)	Enter values for these fields if you're recording completions for a production schedule using transaction 0211.
Production ID	<p>Select values for this field if you're recording completions to stock for a production ID using transaction 0212 or intermediate operations completions using transaction 0213.</p> <p>Item completions are not allowed if the end item (including co-products and recycle by-products) or a component of the end item is on hold.</p> <p>Completions are allowed for waste products with a hold status. Completions are also allowed for rework and teardown orders, but any output of teardown with a hold status prevents teardown completion.</p>

Multiple Out Completion/Scrap Page

Use the Multiple Out Completion/Scrap page (BCT_MG_MCPL) to record operation completions for production IDs with multiple outputs using electronic data collection.

Navigation:

SCM Integrations > Create Transactions > Manufacturing > Record Co-Product Completion

This example illustrates the fields and controls on the Multiple Out Completion/Scrap page (for production IDs). You can find definitions for the fields and controls later on this page.

Multiple Out Completion/Scrap

Business Unit: US012 Last Transaction Nbr: 3000000000001500000000001

Trans Code: 0215 PrdnID Multiple Compl to Stock

Area: Production ID: Serial in Production

Item ID: Spice Mix

Compl Qty: Std UOM: LBS BOM Code: 1

Op Seq: Scrap Qty: Routing Code: 1

Back Thru: Reason Code: Scrap Pct:

Dist Type:

Output & List Find | View All | First | 1 of 1 | Last

Output Item: Spice Mix +

Output Type: Cmpl Qty Output: LBS Std UOM: LBS

To Prdn ID: Op Seq: Op Seq:

Storage Loc: Load Serial Rows Container ID:

Lot ID:

Serial ID Find | First | 1 of 1 | Last

Serial ID: Scrapped

Note: You can also complete teardown production using multiple output completions transactions, and you can complete teardown outputs at intermediate operations, as well as at the last operation.

Field or Control	Description
Area and Item ID	Select values for these fields if you're recording multiple output completions for a production schedule using transaction 0214.
Production ID	Select a value if you're using transaction 0215 or 0216.
Op Seq (operation sequence)	Enter any intermediate operation if you're using transaction 0216.
Back Thru	Select the operation sequence where you want to record completions.
Scrap Qty (scrap quantity), Reason Code , and Scrap Pct (scrap percentage)	Enter values for these fields.
Distribution Type	(Optional) Use this field to create specific accounting entries for scrap.
Output Item	Select a value. You can enter output items from the outputs designated on the BOM, or you can enter unplanned outputs for recycle or waste by-products. The system includes the amount and type of output items indicated on the end item's BOM. For example, if there were one co-product and two by-products designated on the BOM, there would be four output rows for the co-product, two by-products, and one primary item.
Cmpl Qty Output (completed quantity output)	Enter the number of completed items. Based on the completed quantity of the primary item and the co-products, the system calculates the actual completed quantity.
Load Serial Rows	<p>If the end item is serial-controlled or being tracked using serial genealogy (serial in production), enter a completed quantity, which should include any <i>scrap</i> quantity, and then click this button. The system then creates as many Serial ID fields as the completed quantity and any scrap quantity, and you can enter the serial IDs for each completed item. The quantity completed and quantity scrapped must be whole numbers for serial-controlled items. You must enter either a completed quantity or scrapped quantity; both values cannot be zero.</p> <p>If the end item is not being tracked using serial genealogy, enter a completed quantity. The system then creates as many serial IDs for the completed quantity.</p>
Lot ID	Enter a value if the end item is lot-controlled.

Field or Control	Description
Serial ID	Enter the serial IDs for each completed output. If the item is being tracked using serial genealogy, then upon save, the system automatically associates the serial ID with the production ID.
Scrapped	(Optional) Select this check box to indicate that the serial ID is being scrapped.

Note: To correct errors, you must use the online completions pages to enter negative completions and reverse completion transactions.

Processing Electronic Data Collection Completions Transactions

If you're using an electronic data collection system, run the Completions/Scrap Update process to update the system with the completions data collected.

Electronic data collection background processes are set up to continuously scan the transaction log as long as there are transactions in the log with a status of *New* or *Reprocess*. If no transactions with a status of *New* or *Reprocess* are in the log when a process scans the log, the process shuts down. If the process shuts down, you can restart it by using the Process Scheduler. Because the background processes can be automatically restarted by the Process Scheduler at predefined intervals, transaction processing can occur continuously or at set periods throughout the day.

Processing Other Electronic Data Collection Transactions

To set up your system to generate bar code labels, use the Setup UCC/EAN Manufacturer ID (BCT_MFGID_SETUP) component.

After you've run the Completions/Scrap process to update the systems with completions data, create and generate completions labels.

Pages Used to Process Other Electronic Data Collection Transactions

Page Name	Definition Name	Usage
<u>Production Selection Page</u>	RUN_SFS7004	Select the production to create bar-coded labels for end item completions.
<u>Completion Labels Page</u>	RUN_SFS7004B	Enter the production quantity and number of labels that you want to create.

Production Selection Page

Use the Production Selection page (RUN_SFS7004) to select the production to create bar-coded labels for end item completions.

Navigation:

SCM Integrations > Barcode Labels > Completion Label > Production Select

<i>Field or Control</i>	<i>Description</i>
Production ID	Select a value if you're creating labels for a production ID.
Production Area, Item ID, and BOM/Rtg Effdt (BOM/routing effectivity date)	Select values for these fields if you're creating labels for a production schedule.
Search	Click to retrieve the selected operational information.

Note: PeopleSoft SCM applications do not support the printing of bar codes from processes running on OS390 servers. You should run your SQRs that print barcodes on a process scheduler server that is running on a non-OS390 operation system.

Completion Labels Page

Use the Completion Labels page (RUN_SFS7004B) to enter the production quantity and number of labels that you want to create.

Navigation:

SCM Integrations > Barcode Labels > Completion Label > Completion Labels

<i>Field or Control</i>	<i>Description</i>
Override File	Select this check box to designate the file to be overwritten. If you do not select this check box, the system generates a file name in the default directory and attaches the default prefix.
Format ID	Select a value. This field identifies a unique label design defined at the item's SetID level.

Editing or Issuing Components

This section provides overviews of the process of editing or issuing components using electronic data collection and the Production Order Issue EIP and discusses how to record production component issues and returns.

Page Used to Edit Components Using Electronic Data Collection

<i>Page Name</i>	<i>Definition Name</i>	<i>Navigation</i>	<i>Usage</i>
Component Issues/Returns	BCT_MG_CISS	SCM Integrations > Create Transactions > Manufacturing > Component Issues/Returns	<p>Use this page to perform the electronic issue or return transactions for production IDs. These EIP transactions are used to import edit or issue component information from third-party systems such as an MES.</p> <p>You can perform these transactions:</p> <ul style="list-style-type: none"> • 2301 - Production Component Issue • 2302 - Production Component Return • 2303 - Production Component Subs (substitutions)

Understanding the Process of Editing or Issuing Components Using Electronic Data Collection

You can use an electronic data collection system to issue, return, or substitute components for production IDs.

Note: You cannot use an electronic data collection system to issue, return, or substitute components for production schedules.

You can access the electronic data collection transaction pages through the SCM Integrations navigation. When you save an electronic data collection transaction page, the page clears so that you can enter another transaction immediately. The transaction is saved in the transaction log until it is processed by background processes that can be set up to continually scan the transaction log.

The background processes validate all information before any updates are performed. However, when you enter the transactions through the data collection pages, the system verifies the data you have entered in selected fields.

Understanding the Production Order Issue EIP

To support integrated implementations in which a third-party system such as an MES is used to edit or issue components for production IDs, PeopleSoft Manufacturing provides the Production Order Issue EIP, a batch subscribe, inbound, asynchronous message that provides PeopleSoft Manufacturing to import, edit, or issue component information from third-party systems or an MES.

You can use the Production Order Issue (PRODUCTION_ORDER_ISSUE) EIP to import edit or issue component information from third-party systems such as an MES. You can use this EIP for production

IDs that have a status of Released, In Process, Pending, or Pending Complete. This can be done before the manufacturing process begins, any time during the manufacturing process or at completions.

Consuming Lot-Controlled Components

If you have selected the backflush lot selection rule of *Earliest Expiration Date* or *Earliest Available Date*, then the incoming files (that is, data stored in the BCT tables) are not required to have a lot ID for consumed components. The lot ID is assigned during the Production Completions and Scrap process; therefore, the incoming files are not put in the error status for correction in the Transaction Maintenance component (SCM Integrations, Transaction Error Handling, Maintain Transactions, Transaction Maintenance). If the incoming file does contain some lot IDs for consumed components, then the Prdn Compl/Scrap process uses those entries rather than the backflush lot selection rule. In addition, the incoming files must contain the lot IDs for consumed components if you have selected the backflush lot selection rule of *Manual*.

Related Links

[Automatically Consuming Lot-Controlled Stock During a Backflush](#)

Component Issues/Returns Page

Use the Component Issues/Returns page (BCT_MG_CISS) to use this page to perform the electronic issue or return transactions for production IDs.

These EIP transactions are used to import edit or issue component information from third-party systems such as an MES. You can perform these transactions:

Navigation:

SCM Integrations > Create Transactions > Manufacturing > Component Issues/Returns

This example illustrates the fields and controls on the Component Issues/Returns page. You can find definitions for the fields and controls later on this page.

Component Issues/Returns

Business Unit: US008 Last Trans Nbr.: 30000000000001500000000001

Trans Code: 2301 Production Component Issue

Production ID: Production Area: FINAL BOM Code: 1 Routing Code: 1

Item ID: MT3000 Mountain Bike, Womans

Component ID: Bike Frame, Aluminium

Op Seq: Per:

Quantity: Yield Loss Qty: Std UOM: EA

Lot ID:

Serial ID Find First 1 of 1 Last

Serial ID: 1

Field or Control	Description
Component ID	Select the component that you're issuing, returning, or substituting.
Sub Item (substitute item)	If you're using transaction 2303, select a substitute to replace the original component.
Quantity	Enter a value.
Load Serial Rows	Click this button if the end item is serial-controlled or if the end item is being tracked using serial genealogy (serial in production). The system then creates as many rows as the quantity, and you can enter the serial IDs for each completed output. The quantity completed and the quantity scrapped must be whole numbers for serial-controlled items.
Quantity, Yield Loss Qty (yield loss quantity), and Per	Enter values for these fields. You must enter values for the quantity and yield loss quantity; both fields cannot be zero.

Recording Actual Machine and Labor Hours

You can use an electronic data collection system to enter labor and machine hours with a breakdown between setup, run, fixed run, and post production times. The system enables you to include single or crew reporting as well as single or multiple machine reporting. There are two transactions to record actual machine and labor hours, one for production IDs and one for production schedules.

You can access the electronic data collection transaction pages through the SCM Integrations navigation. When you save a transaction page, the page clears so that you can enter another transaction immediately. The transaction is saved in the transaction log until it is processed by background processes that can be set up to continually scan the transaction log.

The background processes validate all information before any updates are performed. However, when you enter the transactions through the data collection pages, selected pieces of information on the page have edits to verify the data that is being entered.

PeopleSoft Manufacturing provides the Actual Hours (PRODUCTION_ACTUAL_HOURS) EIP to import actual hours information captured by a third-party system such as an MES.

If you're using an electronic data collection system, run the Actual Hours Update process (SFPGACTH) to update the system with the completions data collected.

Electronic data collection background processes are set up to continuously scan the transaction log as long as there are transactions in the log with a status of *New* or *Reprocess*. If no transactions with a status of *New* or *Reprocess* are in the log when a process scans the log, the process will shut down. If the process shuts down, it can be restarted by the Process Scheduler. Because the background processes can be automatically restarted by the Process Scheduler at predefined intervals, transaction processing can occur continuously or at set periods throughout the day.

Pages Used to Record Actual Machine and Labor Hours

<i>Page Name</i>	<i>Definition Name</i>	<i>Usage</i>
<u>Actual Hours Page</u>	BCT_MG_ACT	Enter actual hours transactions for production IDs and production schedules. This process uses the Actual Hours EIP.
<u>Actual Hours process Page</u>	BCT_MG_REQACT	Run the Actual Hours Update process (SFPGACTH) to update the system with the completions data collected.

Actual Hours Page

Use the Actual Hours page (BCT_MG_ACT) to enter actual hours transactions for production IDs and production schedules.

This process uses the Actual Hours EIP.

Navigation:

SCM Integrations > Create Transactions > Manufacturing > Create Mfg Actual Hours

This example illustrates the fields and controls on the Actual Hours page (electronic data collection). You can find definitions for the fields and controls later on this page.

Actual Hours

Business Unit US008 Last Trans Nbr. 3000000000000142000000001

Trans Code 0241 Act Hours for Production ID

Area Production ID BOM Code 0 Routing Code 0

Item ID

BOM/Rtg Effdt

Entry Date 01/10/2014

Work Center

Op Seq 0

Crew Reporting Machine Reporting

Shift Code

Resource	Descr	# of Resources
Crew <input type="text"/>		<input type="text"/> 0.00
Machine <input type="text"/>		<input type="text"/> 0.00
	Labor Hrs	Machine Hrs
	Setup <input type="text"/> 0.00	<input type="text"/> 0.00
	Run <input type="text"/> 0.00	<input type="text"/> 0.00
	Fixed Run <input type="text"/> 0.00	<input type="text"/> 0.00
	Post Production <input type="text"/> 0.00	<input type="text"/> 0.00

Note: You cannot enter negative hours using the data collection pages. You must correct data entry errors using negative hours with the online Actual Hours pages.

<i>Field or Control</i>	<i>Description</i>
Production ID	Select a value if you're using transaction code 0241.

Field or Control	Description
Area, Item ID, and BOM/Rtg Effdt (BOM/routing effectivity date)	Select values for these fields if you're using transaction code 0242.
Entry Date, Work Center, and Op Seq (operation sequence)	Enter values for these fields. You must select an operation sequence or a work center. If you select the operation sequence, the work center, crew, and machine information associated with the operation sequence appears. You can, however, change the values for crews or machines.
# of Resources	Displays the number of resources for the crew and machine. You can update this information.
Work Center	You can optionally select this option rather than the operation sequence. Once you select this field, the crew and machine information is provided based on the work center information.
Crew Reporting	If you select this check box, then all labor hours reported are multiplied by the number of resources associated with that crew to calculate total labor hours.
Machine Reporting	If you select this check box, then all machine hours reported are multiplied by the number of resources associated with that machine to calculate total machine hours.
Labor Hrs or Machine Hrs	Record values for these fields based on: <ul style="list-style-type: none"> • Setup • Run • Fixed run • Post production

Actual Hours process Page

Use the Actual Hours process page (BCT_MG_REQACT) to run the Actual Hours Update process (SFPGACTH) to update the system with the completions data collected.

Navigation:

SCM Integrations > Process Transactions > Manufacturing > Process Mfg Actual Hours

<i>Field or Control</i>	<i>Description</i>
Process Frequency	Because the background processes for electronic data collection run continuously and you use the Process Scheduler to restart the background processes, the process frequency should be set to Always .
Unit and Request ID	Enter values.
Run	Click to run this request. Process Scheduler runs the Production Actual Hours process (SFPGACTH) at user-defined intervals.

Related Links

[Understanding Recording Completions and Scrap](#)

Subcontracting

Understanding Subcontracting Using PeopleSoft Manufacturing

In the shop floor environment, you may need to send components or end items to outside suppliers for end item processing, rework, inspection, or testing. PeopleSoft Manufacturing enables you to track production progress and outside processing supplier costs associated with subcontracting using production IDs.

Although managing production with subcontracted operations is similar to managing production for in-house production, there are some differences:

- Once production has been released or started, you select production IDs with subcontracted operations and send the information to PeopleSoft Purchasing where purchase orders are created.

You record operation completions for both in-house and, once the end items are received back from the supplier, subcontracted operations. Once the end items are complete at the final operation, they can be sent to stock or routed to another production area. If the completed end items are lot- or serial-controlled, you assign lot and serial numbers.

- You determine how much lead time you need to generate and process a purchase order for the subcontracted operation.

Using PeopleSoft Manufacturing, you can also optionally define a subcontracted item that is a non-inventory item that represents the outside processing services. When defining this subcontracted item you can specify the purchasing attributes for this item. You can then associate this subcontracted item to the subcontracted operation. The subcontracted purchase order will then be created with this subcontracted item. You can also define a purchasing contract, such as a blanket order, for the subcontracted item to utilize the PeopleSoft Purchasing contract functionality.

If you are using electronic data collection or enable the subcontract streamline option for purchasing receipts, the system automatically generates the subcontracted completions transactions.

Note: You cannot perform a production ID split if you have run the Select Subcontract Prdn for PO process.

Manage Production with Subcontracted Operations

To manage production with subcontracted operations:

1. Record completed operations and scrap for in-house production for operation sequences prior to the subcontracted operation.

See [Manage Production Using Discrete Orders](#).

2. Use the Record Completions/Scrap component to make data entry corrections if required.

3. Use the Select Subcontract Production page to generate the file for subcontracted operations to be used by the Create Purchase Orders process (PO_POCREATE).
4. Generate the purchase order for outside processing, and approve and dispatch the purchase order to the supplier.

If a subcontracted item is associated with a subcontracted operation, then the purchase order will be generated with the subcontracted item and its purchasing attributes and contract information (if available) during the creation of the purchase order.

Use the PO Stage Load, PO Calculations, PO Creation, Approve Amounts, Approve ChartFields, and Dispatch POs components in PeopleSoft Purchasing to process the subcontracted purchase order.

5. Send end items to outside suppliers for subcontracted processing.
6. Receive end items back from suppliers using the Receiving page in PeopleSoft Purchasing.
See “Processing Receipts” (PeopleSoft Purchasing).
7. Use the Subcontracted Receipt page to record completed subcontracted operations and scrap for the manufactured end item.
8. (Optional) Edit components.
9. Record completions and scrap for any additional in-house operations for the manufactured end item.

See [Understanding the Process of Recording Completions and Scrap Using Electronic Data Collection](#).

10. Move completed end items out of production.
11. Run the Completions Update process (SFPDCDRV).
12. Use the Complete Production page to indicate that production for all operations has been completed.
13. (Optional) Record actual labor and machine hours associated with the subcontracted operations.

Common Elements Used in Subcontracting

<i>Field or Control</i>	<i>Description</i>
Production ID	The production order identifier.
Production Area	The production area identifier where the manufacturing process occurs.
Item ID	The name and description of the item being manufactured. Note: Subcontracted items that are processed (manufactured) by an outside vendor will also be included.

Field or Control	Description
Prdn Type (production type)	The type of production: <i>Production, Rework, or Teardown</i> .
BOM Code	The BOM identifier used during the manufacturing process.
Routing Code	The routing identifier used during the manufacturing process.
Revision	The revision identifier if the item is revision-controlled.

Prerequisites

Prior to scheduling a subcontracted operation:

- Identify which tasks and operations are subcontracted.
You cannot subcontract operations for configured items.
- (Optional) Specify the supplier that will be performing the operation or task.
- (Optional) Define a subcontracted item that represents the task to be done on the manufacturing end item.

Note: If you define a subcontracted item, then you must specify the subcontracted item and supplier relationship using the Purchasing Attributes - Item Supplier page.

See “Defining Purchasing Item Attributes” (PeopleSoft Purchasing).

- (Optional) Define queue and in-transit planning times for subcontracting tasks and operations.
You can also define setup, run, fixed run, and post production planning and costing times. These options permit accurate scheduling and costing of the subcontracted operations.
- Designate components as subcontractor supplied on the BOM components page.
- Define nonowned components and locations.
- Define purchase order loader defaults within PeopleSoft Purchasing.
- Release material to the shop floor for end items with subcontracted components and operations.
- Create and release productions IDs for end items with subcontracted components and operations.
- Determine how much lead time you need to generate and process a purchase order for the subcontracted operation.

Selecting Subcontracted Operations for Purchase Order Creation

When part or all of the manufacturing process is done at an outside supplier, you need to generate purchase orders for production IDs with subcontracted operations. Use purchase orders to authorize a supplier to add labor or material or both to a partially completed end item.

Using the Select Subcontract Prdn for PO page in PeopleSoft Manufacturing, you select one or more production IDs, production areas, or item IDs for which to generate purchase orders for subcontracted operations. When you run the Select Subcontract Prdn for PO process (SFS5000), the system automatically transfers the subcontracted operations information for purchase order creation to PeopleSoft Purchasing, including production ID and subcontracted information (supplier name and manufactured item or subcontracted item) for which the outside processing must be done as well as the operation sequence associated with the outside operation. Once the subcontracted purchase order is generated, it is processed like any regular purchase order within PeopleSoft Purchasing.

To create purchase orders for subcontracted operations, verify that:

- The production ID has a status of Released or In Process.
- An operation list exists for the production ID.

Manually create an operation list if the production ID is for rework, you didn't specify a routing, or you choose not to copy the routing to the production ID.

Completing Operations and Scrap for Production Using Count Points

If you're using count points, then all subcontracted operations must be defined as count point.

Pages Used to Generate Subcontracted Purchase Orders

<i>Page Name</i>	<i>Definition Name</i>	<i>Usage</i>
Select Subcontract Production Page	RUN_SFS5000	Select production that requires purchase orders for subcontracted operations.
Subcontracted Purchase Order Report Page	RUN_SFS2008	View the status of purchase orders that you've requested for subcontracted production.
Subcontract Components Report Page	RUN_SFS5001	Displays the production IDs and the components associated with subcontracted operations.

Select Subcontract Production Page

Use the Select Subcontract Production page (RUN_SFS5000) to select production that requires purchase orders for subcontracted operations.

Navigation:

Production Control > Process Production > Subcontract Production > Subcontract Prdn for PO > Select Subcontract Production

<i>Field or Control</i>	<i>Description</i>
Selection Criteria	Select the options indicating the production to generate purchase orders for subcontracted operations. Options are: <ul style="list-style-type: none"> • Start Date • Prdn ID (production ID) • Prdn Area (production area) • Item ID
Run	Click to run this request. Process Scheduler runs the Select Subcontract PO for Prdn process (SFS5000) at user-defined intervals.
Extract to PO only when prior Op Seq is complete	Select this check box to ensure that the subcontract purchase order is created only after the prior operations are complete, thereby eliminating change orders.

Generating, Approving, and Dispatching Purchase Orders for Subcontracted Operations

Once you run the Select Subcontract Prdn for PO process, the purchase orders for the subcontracted services can be generated.

To generate, approve, and dispatch the subcontracted purchase order:

1. Run the PO Stage Load process (PO_POSTAGE).

This process is run with the PO Stage Load page (**Purchasing > Purchase Orders > Stage/Source Requests**). This process takes all the requests generated from requisitions, PeopleSoft Supply Planning, and PeopleSoft Manufacturing, and stages them for the actual purchase order creation.

2. Run the PO Calculations process (PO_POCALC).

This process is run with the PO Calculations - Run Controls page (**Purchasing > Purchase Orders > Stage/Source Requests**). This is an Application Engine process that does most of the processing to create a purchase order.

3. Run the Create Purchase Orders process (PO_POCREATE).

This process is run with the Create PO page (**Purchasing > Purchase Orders > Stage/Source Requests**). This is an Application Engine process that generates the purchase orders that will be staged for approval and dispatching.

If a recommended supplier was listed on the subcontracted task or operation, the purchase order is created with the supplier specified. If the supplier field was left blank on the routing or operation list for the production ID, the suggested supplier, as defined in PeopleSoft Purchasing, is selected.

The system-generated purchase order for the subcontracted service contains this data:

- Business unit and production ID associated with the production.
 - Task description if a task code is associated with the subcontracted operation. Otherwise, the end item description is used, along with the prefix of *SERVICE*.
 - If the subcontracted item ID is associated to the subcontracted operation: the subcontracted item ID and its description are used
 - Quantity and unit of measure.
 - Operation sequence associated with the subcontracted operation.
 - Purchase order due date based on the due date of the subcontracted operation.
 - Purchase order unit price based on the cost defined for the subcontracted operation if the subcontracted item ID is not associated to the subcontracted operation. Otherwise, the purchase order unit price is based on the subcontracted item's unit price from the valid contract or from the purchasing item and supplier relationship.
4. Once you've created the purchase orders, you must approve and dispatch them before you can send the purchase order to the supplier.

Use the Amount Approval, ChartField Approval, and Dispatch POs components to approve and dispatch the purchase orders for the subcontracted operations.

Related Links

[PeopleSoft Manufacturing Reports: A to Z](#)

Managing Purchase Order Changes

Sometimes you may need to change a purchase order to respond to production changes. If a purchase order for subcontracting production has been created and a production change requires a change to the purchase order, PeopleSoft Manufacturing sends a purchase order change request to PeopleSoft Purchasing. This request indicates that a purchase order change is required for the subcontracted purchase, and either a purchase order change request is processed or a new purchase order needs to be generated.

You may also need to change the purchase order when any end items have been returned from the supplier as scrap.

If a subcontracted operation has more than one purchase order, the system will not automatically create change requests. You will need to manually create the change requests.

A purchase order change may be necessary when there is a change to:

- The production quantity.

A quantity change can result from production maintenance as well as from scrapping end items when you're recording completions.

- The actual start date and time or actual due date and time for the production IDs or subcontracted operation.

The purchase order change request is processed by PeopleSoft Purchasing using the Change Load Application Engine process (PO_CHNGLOAD) and the Change Purchase Order Application Engine process (PO_POCHNG).

After you request a purchase order and run the PO Stage load process, the subcontracted operation has an In Process status, after PeopleSoft Purchasing has received and acknowledged the subcontracted operation information.

If you use the background reschedule process to reschedule production with subcontracted operations, and the purchase order date is no longer valid, the system cannot reschedule an In Process purchase order. When running the background reschedule process, you can request that the system check for any production that has an In Process purchase order for subcontracted operations. In this case, the system displays an error message for each instance, unless you decide to skip further in process messages. You can then contact the purchasing department to reschedule the purchase order.

If multiple subcontracted purchase orders exist for the same subcontracted operation, no change order requests will be created from PeopleSoft Manufacturing.

Canceling or Deleting a Subcontracted Purchase Order

If you cancel or delete the subcontracted PO, line, or schedule, the system resets the subcontracted purchase order status for the associated production ID or operation sequences associated with the purchase order, line, or schedule. Therefore, you need to rerun the process to generate a subcontracted purchase order.

Receiving End Items from Suppliers

Receiving the end items back from the supplier is a two-step process, but the process can be streamlined so that it is only one step. The process to receive the end items using the two-step process is:

1. Receiving records the receipt of the end items back from the supplier.
2. Production records the operations completions and scrap for the received end items.

If you setup subcontract streamlining in PeopleSoft Purchasing, then the process to receive end items is that the Receiving functionality records the receipt of the end items back from the supplier. Upon saving the receipt the system will perform the purchase order receipt and the production ID completion in one step by automatically generating electronic data collection transactions for the subcontracted completions data. To specify that you want to use subcontracting streamlining, select the Interface Receipt and Subcontract Streamline check boxes on the Maintain Receipts - Receiving page.

See “Managing Receipts” (PeopleSoft Purchasing).

Once the supplier has completed the subcontracted work, the end items are returned to Receiving. To receive end items back from the subcontractor, use the Maintain Receipts - Receiving page.

During the receiving process, the end items can be inspected and accepted or rejected from the supplier. Receiving assigns one of these indicators to the rejected quantity when recording the receipt:

Field or Control	Description
Return for Replacement	<p>Return the end item to the supplier with the expectation that it will be replaced. The return quantity is equal to the reject quantity with a reject action of <i>Return to Replacement</i>.</p> <p>The received rejected quantity for production is the received quantity and the received rejected quantity is zero.</p> <p>PeopleSoft Purchasing does not record the replacement quantity as either accepted or rejected.</p>
Return for Credit	<p>Return the end items back to the supplier for a credit. The credited amount is the subcontracted service charge.</p> <p>PeopleSoft Purchasing records the Reject quantity as scrap on the production Subcontracted Receipt page.</p>

This table summarizes the receiving reject actions and effects:

Action	Receiving Record	PS_RECV_SUBREC_MG	Purchase Order Line
Return for Replacement	No reject qty	No scrap	No update
Return for Credit	Scrap the qty	Scrap the qty	Update

Subcontracted receipts to stock are prevented if the end item or a component of the end item is *on hold* and the order is for regular production. Subcontracted receipts to intermediate operations are allowed for regular production.

The PeopleSoft Purchasing receipt process updates production to indicate that the end items have been received. You cannot record operation completions or scrap until the end items have been received.

In addition, you cannot close production until the quantity of end items sent to the supplier is equal to the quantity of scrapped and completed end items received back from the supplier and recorded complete in production.

PeopleSoft Purchasing can optionally receive end items using electronic data collection. Electronic data collection transactions for manufactured end items automatically record the subcontracted completions data. You do not need to record completions in the Subcontracted Receipt pages for these subcontracted end items. After the transactions are recorded and staged, run the Completions/Scrap Update process to update the production balances.

Recording Completed Operations and Scrap for Subcontracted Operations

Once you've processed the end items through receiving and inspection, you can record the operation as complete in PeopleSoft Manufacturing. If the subcontracted operation is the last operation on the routing, you can also indicate that production is completed.

When you record scrap for the end item, the system optionally sends a workflow notification to selected roles defined by you. These roles might include a quality manager or a production control manager.

If you are integrating with a Manufacturing Execution System (MES), you can receive subcontracted operation completions from the MES to the PeopleSoft system. The end items need to be received in PeopleSoft Purchasing before you can record the completion transaction in PeopleSoft Manufacturing. The MES sends the same information for a subcontracted completion as with completions for regular operations.

Note: If you have set up your environment to perform subcontract streamlining then the recording of subcontracted operations is unnecessary.

Pages Used to Record Completions and Scrap for Subcontracted Operations

<i>Page Name</i>	<i>Definition Name</i>	<i>Usage</i>
<u>Subcontracted Receipt Page</u>	SF_SUBREC	Record completed operations and scrap by subcontracted operation. You must receive the subcontracted end items through PeopleSoft Purchasing before using this page.
<u>Complete Production Page</u>	SF_COMPL_PRDN	Indicate that production is completed for production IDs with subcontracted operations.
<u>Receipt Information Page</u>	SF_RECEIPT_INFO	View receipt and completions information about the subcontracted operation.
<u>Record Completions/Scrap Page</u>	SF_COMPL_ID	(Optional) Enter completions and scrap information for production IDs. In addition, use this page to move end items for production IDs with a single output or multiple outputs.
Production Scrap Details Page	SF_COMPL_SCRAP	Enter scrap quantities, if applicable. <u>Record Completions/Scrap Page</u>
Apply Defaults Page	SF_COMPL_DEFAULTS	Select the default putaway or alternate storage locations for the completed end items.

Page Name	Definition Name	Usage
“Shipping/Issues - Rapid Serial Numbers Page” (PeopleSoft Inventory)	AUTO_SERIAL_WRK	(Optional) Automatically generate serial numbers for production end items that are serial-controlled. You must define serial-controlled items in PeopleSoft Inventory.
Lot/Serial Number Selection scroll area Page	SF_ED_CMP_SBP_GRD	(Optional) Identify the lots from which you want to consume lot-controlled components. You must enter a pending quantity greater than zero for a lot-controlled component before the Lot/Serial scroll area is available.
<u>Production History Page</u>	SF_TRANSIST	View production transaction history for production IDs.
Production History - Detail inquiry Page	SF_TXN_HIST_SP	View production transaction history details based on: <ul style="list-style-type: none"> • Completions detail • Component consumption • Operation detail <u>Production History Page</u>

Related Links

[Integrating PeopleSoft Manufacturing with a Third-Party System](#)

Subcontracted Receipt Page

Use the Subcontracted Receipt page (SF_SUBREC) to record completed operations and scrap by subcontracted operation.

Navigation:

Production Control > Process Production > Subcontract Production > Receive Subcontract Assembly > Subcontracted Receipt

This example illustrates the fields and controls on the Subcontracted Receipt page. You can find definitions for the fields and controls later on this page.

Subcontracted Receipt		Edit/Issue Components Summary	Edit/Issue Components Detail	Edit/Issue Express	Qs Xfer Pnl																																																				
Unit	US008	<input type="checkbox"/> Serial in Prdn	Prdn Type	Production	Process Monitor																																																				
Production ID	PRD00083	In Process	BOM Code	1	<input type="checkbox"/> Print at Save																																																				
Production Area	FINAL		Routing Code	1	Setup Print Options																																																				
Item ID	MT3000		UOM	EA																																																					
	Mountain Bike, Womans		Revision																																																						
Prdn Start Qty	100.0000	Completed Qty	100.0000	Putaway Action	Stage for Putaway at Save Time																																																				
Prdn End Qty	200.0000	Scrapped Qty	0.0000	Complete Production	Receipt Information																																																				
Prdn% Completed	100.00																																																								
Completed Qty	<input type="text" value="100.0000"/>	Op Seq	<input type="text" value="40"/>	Previous Operations																																																					
Scrap Qty	<input type="text" value="0.0000"/>	Enter Scrap Data	Quality	<input checked="" type="checkbox"/> Update Prior Operations <input type="text" value="0"/> Back Thru Operation																																																					
<table border="1"> <thead> <tr> <th colspan="13">Operations Data</th> </tr> <tr> <th>Op Seq</th> <th>Work Center</th> <th>Task Code</th> <th>Count Point</th> <th>Assy Starts Qty</th> <th>Quantity Issued to Operation</th> <th>Qty Cpl/Th</th> <th>Assembly Qty Scrapped at Op</th> <th>Expctd Cmpl Qty</th> <th>Op Yld %</th> <th>Setup Earned</th> <th>Post Prod</th> <th>Sub Op</th> </tr> </thead> <tbody> <tr> <td>10</td> <td>FI-ASSY</td> <td>FORK</td> <td>N</td> <td>100.0000</td> <td>200.0000</td> <td>200.0000</td> <td>0.0000</td> <td>200.0000</td> <td>100.0000</td> <td>Y</td> <td>N</td> <td>N</td> </tr> <tr> <td>20</td> <td>FI-ASSY</td> <td>FINAL</td> <td>N</td> <td>200.0000</td> <td>200.0000</td> <td>200.0000</td> <td>0.0000</td> <td>200.0000</td> <td>100.0000</td> <td>Y</td> <td>N</td> <td>N</td> </tr> </tbody> </table>						Operations Data													Op Seq	Work Center	Task Code	Count Point	Assy Starts Qty	Quantity Issued to Operation	Qty Cpl/Th	Assembly Qty Scrapped at Op	Expctd Cmpl Qty	Op Yld %	Setup Earned	Post Prod	Sub Op	10	FI-ASSY	FORK	N	100.0000	200.0000	200.0000	0.0000	200.0000	100.0000	Y	N	N	20	FI-ASSY	FINAL	N	200.0000	200.0000	200.0000	0.0000	200.0000	100.0000	Y	N	N
Operations Data																																																									
Op Seq	Work Center	Task Code	Count Point	Assy Starts Qty	Quantity Issued to Operation	Qty Cpl/Th	Assembly Qty Scrapped at Op	Expctd Cmpl Qty	Op Yld %	Setup Earned	Post Prod	Sub Op																																													
10	FI-ASSY	FORK	N	100.0000	200.0000	200.0000	0.0000	200.0000	100.0000	Y	N	N																																													
20	FI-ASSY	FINAL	N	200.0000	200.0000	200.0000	0.0000	200.0000	100.0000	Y	N	N																																													

Field or Control	Description
Print at Save	Select this check box if you want to print production documents at save time.
Setup Print Options	Click this link to access the Process/Output Options page to select different print criteria for the production documents.
Completed Qty (completed quantity)	Enter the number of end items being completed.
Quality	Click this link to initiate a data entry session and to access either the Data Entry - Subgroup Method page or the Data Entry - Sample Method page in PeopleSoft Quality, depending on the data entry method that you specified when creating the quality control plan.

Operations Data

View display-only production data such as assembly start quantities, number of assemblies scrapped, expected completed quantities, and yield percentages for each operation sequence.

Related Links

“Understanding the Quality Data Collection Process” (PeopleSoft Quality)

Receipt Information Page

Use the Receipt Information page (SF_RECEIPT_INFO) to view receipt and completions information about the subcontracted operation.

Navigation:

Production Control > Process Production > Subcontract Production > Receive Subcontract Assembly > Subcontracted Receipt > Receipt Information

<i>Field or Control</i>	<i>Description</i>
Recv Rejected Qty (received rejected quantity)	<p>Displays the quantity that Receiving rejected from the supplier and that was recorded in PeopleSoft Purchasing. Receiving assigns one of these indicators to the rejected quantity:</p> <ul style="list-style-type: none"> • <i>Return for Replacement</i> • <i>Return for Credit</i> <p>Only received quantities that have a status of <i>Return for Credit</i> appear in this field.</p>
Prdn Accepted Qty (production accepted quantity)	Displays the quantity that was actually recorded as a completion using the Subcontract Receipt page.
Prdn Rejected Qty (production rejected quantity)	Displays the quantity that was actually recorded as scrap using the Subcontract Receipt page.

Note: Use the Edit Components page if you want to modify or view the components that will be consumed based on the quantity completed or scrapped, or if you need to select the serial or lot numbers for those serial- or lot-controlled components that were consumed when you recorded the completion.

Moving Completed End Items

The process for moving completed end items for subcontracted operations is the same as for other production.

See [Moving Completed End Items and Assigning Serial and Lot Numbers](#).

Pages Used to Move Completed End Items

<i>Page Name</i>	<i>Definition Name</i>	<i>Usage</i>
Complete Production Page	SF_COMPL_SELECTION	Select a production ID or production schedule.
Record Completions/Scrap page - Route-To PID/Stor Locations (route to production ID and storage locations) scroll area Page	SF_COMPL_ID	Move completed end items to a production ID or to a storage location. Complete Production Page
Shortages Page	SF_COMPL_SHORTAGE	Select a production ID to which you want to route the completed end item.

Completing Production for Subcontracted Operations

The process for completing production for subcontracted operations is similar to the process for other production.

See [Running the Completions Update COBOL/SQR Process \(SFPDCDRV\)](#).

Pages Used to Complete Production for Subcontracted Operations

<i>Page Name</i>	<i>Definition Name</i>	<i>Usage</i>
Production Selection Page	SF_COMPL_SELECTION	Select a production ID to record completions and scrap.
Record Completions/Scrap - Output Details scroll area Page	SF_COMPL_ID	Enter completions and scrap information for the production ID.
Complete Production Page	SF_COMPL_PRDN	Indicate that production at all operation sequences has been completed.

Editing or Issuing Components for Subcontracted Operations

The process for editing or issuing components for subcontracted operations is similar to that of other production.

See [Editing Component Lists](#).

Pages Used to Edit or Issue Components for Subcontracted Operations

<i>Page Name</i>	<i>Definition Name</i>	<i>Navigation</i>	<i>Usage</i>
Edit/Issue Components Summary	SF_EDIT_COMPS_EDIT	Production Control > Process Production > Subcontract Production > Receive Subcontract Assembly > Edit/Issue Components Summary	Edit or view components.
Edit/Issue Express	SF_EDIT_COMPS_EXPR	Production Control > Process Production > Subcontract Production > Receive Subcontract Assembly > Edit/Issue Express	(Optional) Select lot- or serial-controlled components that have pending issue or pending loss quantities.

Page Name	Definition Name	Navigation	Usage
Lot/Serial Number Selection	SF_ED_CMP_SBP_GRD	<p>Production Control > Process Production > Subcontract Production > Receive Subcontract Assembly > Edit/Issue Express</p> <p>Click the Select Lot/Serial link.</p>	<p>(Optional) Select the lot or serial numbers (or both) of the lot- or serial-controlled components to be consumed during the completions process.</p> <p>You must enter a pending quantity greater than zero for a serial-controlled or lot-controlled component before the Lot/Serial scroll area is available.</p>
Edit/Issue Components Detail	SF_EDIT_COMPS_DET	<ul style="list-style-type: none"> • Production Control > Process Production > Subcontract Production > Receive Subcontract Assembly > Edit/Issue Components Detail • Production Control > Process Production > Subcontract Production > Receive Subcontract Assembly > Edit/Issue Components Summary <p>Click the Detail button next to the component you want to edit or view.</p>	View detailed information for each component for selected production.
Record Completions/Scrap - Production Selection	SF_COMPL_SELECTION	<p>Production Control > Process Production > Complete Production > Record Completions/Scrap > Production Selection</p>	<p>Return components issued during completions or to correct data entry errors. You can also return lot- or serial-controlled end items by using this page.</p> <p>Record completions for a production ID or a production schedule. To return lot- or serial-controlled end items, first record operations and scrap and put away production with lot- and serial-controlled components.</p>

Page Name	Definition Name	Navigation	Usage
Record Completions/Scrap	SF_COMPL_ID	Production Control > Process Production > Complete Production > Record Completions/Scrap	Return components issued during completions or to correct data entry errors. You can also return lot- or serial-controlled end items by using this page.
Production History	SF_TRANSHIST	Production Control > Define Production > Review Production Information > Production History	View production transaction history for components.
Transaction History Details inquiry	SF_TXN_HIST_SP	Production Control > Define Production > Review Production Information > Production History Click the Detail button.	View completions details based on the selection criteria.

Creating Reversing Entries

If a data entry error is made when recording end item completions or scrap for a subcontracted operation, input a negative number to reverse the completion or scrap entry. For example, an entry was made to record a completion of eight end items at operation 20, but only six end items were actually completed. Enter a -2 in the **Completed Qty** field to reverse the original entry of 8. This brings the completed quantity balance for that operation to 6.

This reversing entry:

- Rebalances the completions or scrap count.
- Rolls back the reversing entry only through the subcontracted operation.
- Automatically returns any components that were consumed at the current operation to the appropriate WIP location.
- Creates a reversing entry for earned labor, machine, and overhead costs.

Creating a Reversing Entry for Subcontracted Operations Using Count Points

If you are performing reversing entries for production IDs with subcontracted operations, you can reverse operations and scrap from one count point (or subcontracted operation) to the prior count point (or subcontracted operation).

Pages Used to Create Reversing Entries for Subcontracted Operations

Page Name	Definition Name	Usage
Complete Production Page	SF_COMPL_SELECTION	Select a production ID to create reversing entries.
Record Completions/Scrap Page	SF_COMPL_ID	Enter reversing entries for selected production.
Production Scrap Details Page	SF_COMPL_SCRAP	Enter any reversing entries to scrapped quantities, if applicable.
Apply Defaults Page	SF_COMPL_DEFAULTS	Select the putaway locations for the reversing entries.
Lot/Serial Number Selection Page	SF_ED_CMP_SBP_GRD	(Optional) Select the serial numbers of the serial-controlled components to be returned.
Lot/Serial Number Selection scroll area Page	SF_ED_CMP_SBP_GRD	(Optional) Identify the lots from which you want to return lot-controlled components.

Related Links

[Moving Completed End Items and Assigning Serial and Lot Numbers](#)

Recording and Viewing Actual Labor and Machine Hours

The process for recording actual labor and machine hours for subcontracted production is similar to that of other production.

See [Recording Actual Machine and Labor Hours](#).

Pages Used to Record and View Actual Labor and Machine Hours

Page Name	Definition Name	Usage
Production Selection Page	SF_ACTHR_SELECTION	Select the production that you want to record actual machine and labor hours incurred during the production process. Record Actual Hours Page
Record Actual Hours Page	SF_ACTHRS_NEW	Enter labor and machine hours for the selected production.

Page Name	Definition Name	Usage
Review Actual Hours - Production Selection Page	SF_ACTHRS_INQUIRY	Select a specific production ID or production schedule to view actual labor and labor information. Record Actual Hours Page
Actual Hours by Operation Page	SF_ACTHRS_INQ_GRD	View actual labor and machine hours for a production ID or schedule by operation. Record Actual Hours Page
Actual Hours Detail Page	SF_ACTHRS_INQ	View detailed information on actual labor and machine hours for a production ID or schedule by operation. Record Actual Hours Page
Crew/Machine Resources Detail Page	SF_ACTHRS_INQ_SEC	View resource details for the crew or machine. Record Actual Hours Page

Closing Production

Understanding the Production Close Process

After you've completed production, you will close production and calculate variances for postings to the general ledger. You will also analyze production costs and variances. The first step in the close process is to close production to any further material or labor transactions. During the close process, you may find that you need to reopen production to correct data entry errors, or reopen production that was closed prematurely.

Before a production ID or production schedule is closed for accounting, you can generate a Potential Production Variance report. This report lists the potential variances based on the current snapshot of production. In addition, the system can send the report to the appropriate individuals by using the Potential Prdn Variance Report workflow to notify them of the potential variances. When this report is run, no accounting close occurs and no variances are posted. Periodically, you can review this report to highlight the variances immediately so that you can correct potential production problems.

Note: Production must have a status of *In Process* or higher to generate potential production variance reports.

If you enable the Variance Drilldown feature at the business unit, you can review the production variance calculations. After a production ID or production schedule has been closed for accounting, use the Production Variance Drilldown component to view the calculations of each production variance. This data is retrieved from the Production Variance Detail record (SF_VARS_DETAIL) and the Configuration Variance Detail record (SF_CFGVAR_DET) that are populated during the Close Production process (SFS1100). In addition, after the Cost Accounting Creation process has been run, the Posted Variance Drilldown page (Cost Accounting, Inventory and Mfg Accounting, Analyze Production Costs, Posted Variance Drilldown) can be used to view the accounting lines related to the production variances. Links on both the Production Variance Drilldown – Review Variances page and the Posted Variance Drilldown page enable you to drill down into more detailed information or drill up into summary information.

Related Links

[Delivered Workflows for PeopleSoft Manufacturing](#)

Analyzing Potential Variances

After completing production, use the Potential Production Variance report to view potential variances that exist in production.

Pages Used to Generate a Potential Variance Report

Page Name	Definition Name	Usage
Production Selection Page	RUN_SFS1600	Use the Potential Production Variance report to view potential variances that exist in production before closing for accounting the production IDs and schedules.
Potential Variance Selection Page	RUN_SFS1600A	Select report criteria.

Initiating the Close Production Process

After you complete production for the day or for a production ID, you need to close production to any further material or labor transactions. The production status is changed to *Closed for Accounting* after all related transactions have been completed and potential variances have been analyzed. When the final close for production (the accounting close) occurs, PeopleSoft Manufacturing calculates variances and records them for later posting to the general ledger.

If you have enabled PeopleSoft Workflow, you can use the Production Ready to Close workflow that scans the production data files and notifies appropriate users of any production status that has changed to *Pending Complete*, *Completed*, or *Closed for Labor*.

If you are using production IDs, you can identify costs and variances by discrete order. If you're using production schedules, the system collects costs and variances by day and shift for the production area and item combination.

For standard cost items, the Close Production process (SFS1100) can populate the Production Variance Detail record (SF_VARS_DETAIL) and the Configuration Variance Detail record (SF_CFGVAR_DET) with detailed information about how each production variance was calculated. This information is displayed on the Production Variance Drilldown component and can be downloaded into a Microsoft Excel spreadsheet. In order to populate the Production Variance Detail record and the Configuration Variance Detail record, you must enable variance drilldown at the business unit level. Select the Enable Variance Drilldown check box on the MFG BU Prdn Options page to capture detailed production variance data.

PeopleSoft Manufacturing provides three options to close a production ID or production schedule:

Field or Control	Description
Complete	This first close prevents any material movement for the production ID or for production on the day or shift selected. This includes component consumption as well as any assembly completions at an operation, to stock, or to another production ID or production area.

Field or Control	Description
Closed for Labor	This second close prevents any additional actual labor or machine time recording.
Closed for Accounting	This final close completes the production cycle and closes the production ID or production for the shift for accounting purposes.

After it is closed for accounting purposes, PeopleSoft Manufacturing calculates these standard-cost variances:

- Component Yield
- Configuration
- Labor Lot Size
- Material Lot Size
- Mix
- Outside Processing PPV
- Process Routing
- Rework Expense
- Rework Labor Expense
- Teardown Conversion Expense
- Teardown Material Expense
- Usage
- Yield

Production schedules with a status of *In Process* are automatically set to *Pending Complete* when the order quantity equals the quantity completed. The system combines material lot size and configuration variances for production schedules.

Note: PeopleSoft Manufacturing reports but does not post Efficiency and Utilization variances.

For more details about the above variances, see the Analyzing Manufacturing topic of the PeopleSoft Cost Management Documentation.

Pages Used to Initiate the Production Close Process

Page Name	Definition Name	Usage
Production Selection Page	RUN_SFS1100	Change the production status to <i>Complete</i> , <i>Clsd/Labor</i> (closed for labor), or <i>Clsd/Acctg</i> (closed for accounting).
Close Status Selection Page	RUN_SFS1100A	Define the production close criteria.

Related Links

[“Understanding Production Analysis” \(PeopleSoft Cost Management\)](#)

[Delivered Workflows for PeopleSoft Manufacturing](#)

Production Selection Page

Use the Production Selection page (RUN_SFS1100) to change the production status to Complete, Clsd/Labor (closed for labor), or Clsd/Acctg (closed for accounting).

Navigation:

Production Control > Close and Analyze Production > Close Production

Field or Control	Description
Report Only Mode	You can run this process to view the production that may be closed as well as the variances that could be generated as a result of an accounting close.
Select Production IDs	Select this check box to close production IDs based on any of these options: <ul style="list-style-type: none"> • Production ID • Production area • Item ID
All or a Range	Narrow the production to close by combining any of these options. For example, you can close only those production IDs within a selected production area for a single item.
Select Production Schedules	Select this check box to close production schedules based on: <ul style="list-style-type: none"> • Production area • Item ID

Close Status Selection Page

Use the Close Status Selection page (RUN_SFS1100A) to define the production close criteria.

Navigation:

Production Control > Close and Analyze Production > Close Production > Close Status Selection

This example illustrates the fields and controls on the Close Status Selection page. You can find definitions for the fields and controls later on this page.

The screenshot shows the 'Close Status Selection' page with the following elements:

- Page tabs: **Close Production** and **Close Status Selection**.
- Run Control ID: **Close**
- Language: **English** (dropdown menu)
- Buttons: **Report Manager**, **Process Monitor**, and **Run**.
- Report Request Parameters** section:
 - Business Unit:** US010
 - Current Status:** Close Production For:
 - In Process
 - Complete
 - Clsd/Labor
 - Clsd/Acctg
 - Curr Prdn Due/Close Dates:** [] to []
 - Pend/Cmpl:**
 - Pend/Cmpl
 - Complete
 - Clsd/Labor
 - Clsd/Acctg
 - Complete:**
 - Complete
 - Clsd/Labor
 - Clsd/Acctg
 - Clsd/Labor:**
 - Clsd/Labor
 - Clsd/Acctg
 - Close with Component Shortages:**
 - Variance Distrib Type:** []
 - Close with Assemblies Remain:**
 - Tolerance %:** 0.00000000

Field or Control	Description
Current Status	Select one or more of these production statuses: <ul style="list-style-type: none"> • In Process • Pend Cmpl (pending complete) • Complete • Clsd/Labor (closed for labor)
Close Production For	Select the new production status. Values are: <ul style="list-style-type: none"> • Complete • Clsd/Labor (closed for labor) • Clsd/Acctg (closed for accounting)

Field or Control	Description
Curr Prdn Due/Close Dates (current production due and close dates)	<p>Enter the appropriate date ranges. If you are closing any In Process or Pending Complete production, the system closes any production IDs or production schedule quantities whose production due date falls within the date range specified.</p> <p>If you are closing any production IDs or production schedule quantities whose current status is <i>Complete</i> or <i>Closed for Labor</i>, the system closes any production whose close date falls within the range specified.</p>
Complete with Component Shortages	<p>Select this check box if you want to close production even if you haven't issued all the scheduled material for the production ID or production schedule. In this instance, the quantity issued to production is less than the current scheduled quantity for the component.</p>
Variance Distrib Type (variance distribution type)	<p>(Optional) Displays the variance distribution type, which can be used in conjunction with the transaction group for variances to define the accounting entries to post the variance to the general ledger. The default distribution type for the transaction group (if one was defined) appears, but you can override the distribution type for each accounting close. This field is used only when closing production for accounting.</p>
Close with Assemblies Remain (close with assemblies remaining)	<p>Select this check box if you want to close production even though the full production quantity hasn't been completed. Production can close with remaining assemblies only if the production quantity has not been started. Once any quantity is in process, you must complete the assemblies for production to close.</p>
Tolerance %	<p>You must indicate a tolerance percentage if you selected the Close with Assemblies Remain check box. Use this field to define what percentage of assemblies can remain uncompleted and still close production with remaining assemblies. For example, if you have a production ID with an order quantity of 100 but have completed only 92 units and enter a tolerance percentage of 5 percent, this production ID will not close because the quantity remaining to be completed is 8 percent of the order quantity. The default is 0 percent.</p> <p>The system closes any production in process, pending complete, complete, or closed for labor if the quantity of assemblies completed and scrapped at each operation equals the quantity started at each operation.</p>
Run	<p>Click to run this request. Process Scheduler runs the Close Production process at user-defined intervals.</p>

Note: If any of the production IDs are for production with one or more subcontracted operations, the system cannot close production if subcontracted purchase orders have not been fully received. To close those production IDs, the material must be received and the subcontracted operation must be recorded as complete.

Using the Close Production Request Report

This process generates the Close Production Request report. If you cannot close a production ID or a production schedule quantity that falls within the selection criteria, the production ID, area, item, and day shift information display as well as the reason why the production could not be closed. Possible reasons include:

- Outstanding pick plans.

In this instance, a pick plan has been generated for a production ID or production schedule, but not yet confirmed and released. The picking process must be completed before production can be closed.

- Outstanding consumed quantity.

In this instance, a component was consumed during a backflush, but there was not sufficient quantity on hand in the WIP storage area (and the inventory business unit does not allow inventory to go negative) to issue the component to the production ID or production schedule. You haven't decremented the quantity on hand in the WIP location and a nonzero pending issue or pending yield loss quantity exists.

- Outstanding component shortages.

If you elected not to complete production with shortages, the system excludes any production ID or production schedule due to be closed that has component shortages. A component is considered short when the issued quantity is less than the current scheduled quantity.

- Remaining assemblies in process.

If any assemblies are remaining at an operation (the quantity issued to the location is greater than the quantity completed plus scrapped), they must first be scrapped or completed before you can close production.

- Production quantity hasn't been completed.

If the full production quantity hasn't been completed and you haven't selected the Close with Assemblies Remain check box, you cannot close the production ID or production schedule. Additionally, if you've selected the option to close with assemblies remaining but the remaining assembly quantity exceeds the tolerance percentage, the production cannot be closed.

- Production quantity remaining uncompleted exceeds tolerance.

If you have selected the Close with Assemblies Remaining check box, but the remaining amount exceeds the tolerance percentage, the production ID or production schedule will not be closed. For example, if you have an order quantity of 100, 80 of which are completed, and you enter a tolerance of 5 percent, production will not be closed because at least 95 assemblies must be completed.

- Subcontracted purchase order quantity outstanding.

If the quantity of assemblies sent to the supplier is not equal to the quantity of scrapped and completed assemblies received back from the supplier, then you cannot close production. The outstanding assemblies must be reconciled before you can close production.

Important! Be aware that if you are closing a serial genealogy production ID with a status of *Complete*, you cannot close the production ID if there are outstanding serial IDs that have been associated but have not been completed or scrapped. All serial IDs that have been associated with the production ID must be accounted for; either they have been completed or scrapped.

After displaying the list of production that you cannot close, the report lists production that has been successfully closed. It also details the variances incurred, categorized by variance type.

If you are running this process in update mode (that is, you didn't select the Report Only Mode check box), the status is set to *Complete*, *Clsd/Labor* (closed for labor), or *Clsd/Acctg* (closed for accounting), depending on the **Close Production For** group box level selected. The close date and time is updated with the current date and time for those production IDs or production schedules that you could close.

PeopleSoft Manufacturing records variances for production IDs and production schedules that you've closed for accounting. The system also posts these variances to the general ledger during the accounting line generation and journal generator processes.

When production is closed and an operation has costing post production time that hasn't yet been earned, the closing process calculates the earned labor and machine post production costs and updates the Earned Conversion Cost record accordingly.

Related Links

“Understanding Production Analysis” (PeopleSoft Cost Management)

[PeopleSoft Manufacturing Reports: A to Z](#)

Reopening Production

Occasionally, additional completions, material consumption, or actual hours must be recorded for production that has been closed. To complete these transactions, production must be reopened. When closing production, you can skip any intermediate status and close for accounting any production ID or production schedule quantity that is still in process. However, when reopening production, you can only go backward one status at a time. For example, you can only reset production to *Closed for Labor* from *Closed for Accounting*, or reset production to *Complete* from *Closed for Labor*.

Reopening production closed for accounting has several ramifications. When you reopen production that you've closed for accounting, PeopleSoft Manufacturing automatically reverses previously recorded variance entries, and if it records a favorable variance, it records an unfavorable entry for the same. The net effect is to zero out any previously recorded amount. When you close production for accounting again, the system completely recalculates variances based on the new production information.

For standard cost items, the Reopen Production process (SFS1200) can reverse postings in the Production Variance Detail record (SF_VARS_DETAIL) and the Configuration Variance Detail record (SF_CFGVAR_DET). These tables are populated by the Close Production process (SFS1100) with detailed information about how each production variance was calculated.

Pages Used to Reopen Production

Page Name	Definition Name	Usage
Reopen Production Page	RUN_SFS1200	Select production to be reopened that was previously closed for accounting, closed for labor, or set to complete. Production must have a production status of <i>Pending Complete</i> or higher.
<u>Reopen Status Selection Page</u>	RUN_SFS1200A	Define additional reopen production criteria.

Reopen Status Selection Page

Use the Reopen Status Selection page (RUN_SFS1200A) to define additional reopen production criteria.

Navigation:

Production Control > Close and Analyze Production > Reopen Production > Reopen Status Selection

Field or Control	Description
Current Status	Select a current production status for the production that you want to reopen.
Curr Prdn Due/Close Dates (current production due and close dates)	Enter the appropriate dates. The system reopens any production that is currently closed for accounting, labor, or complete and whose accounting or labor close date or completed date falls within the date range specified. When reopening production in the <i>Pending Complete</i> status, production is set to <i>In Process</i> if the production due date falls within the date window specified.
Run	Click to run this request. Process Scheduler runs the Reopen Production process (SFS1200) at user-defined intervals. This process generates the Reopen Production Request report. The report details the before and after status of the production ID or production schedule once the process is complete. You can view the results of the variance postings and the reversal of the posting by running the Production Variance report.

Related Links

[PeopleSoft Manufacturing Reports: A to Z](#)

Reviewing Production Variance Details

For closed production IDs and production schedules, use the Production Variance Drilldown component to view the calculations of each production variance. This component displays production variances for standard-cost items only. The production variance calculation details are retrieved from the Production Variance Detail record (SF_VARS_DETAIL) and the Configuration Variance Detail record (SF_CFGVAR_DET) that are populated during the Close Production process (SFS1100) for production IDs and schedules with the status of Closed for Accounting. When applicable, the Reopen Production process (SFS1200) can reverse postings in the Production Variance Detail record and the Configuration Variance Detail record.

The information displayed on the Production Variance Drilldown component can be downloaded into a Microsoft Excel spreadsheet.

In order to populate the Production Variance Detail record and the Configuration Variance Detail record, you must enable variance drilldown at the business unit level. Select the Enable Variance Drilldown check box on the MFG BU Prdn Options page to capture detailed production variance data. To capture variance details for a production ID or schedule, you must enable variance drilldown at the business unit level before running the Close Production process.

In addition, after the Cost Accounting Creation process has been run, the Posted Variance Drilldown page (Cost Accounting, Inventory and Mfg Accounting, Analyze Production Costs, Posted Variance Drilldown) can be used to view the accounting lines related to the production variances. Links on both the Production Variance Drilldown page and the Posted Variance Drilldown page enable you to drill down into more detailed information or drill up into summary information.

There are 12 production variances that are calculated and can be viewed in the Production Variance Drilldown component, including:

- Component Yield Variance
- Configuration Variance
- Labor Lot Size Variance
- Material Lot Size Variance
- Mix Variance
- Outside Processing PPV
- Rework Expense
- Rework Labor Expense
- Teardown Conversion Expense
- Teardown Material Expense
- Usage Variance
- Yield Variance

The calculations for the configuration variance are stored in the Configuration Variance Detail record. All other variances are stored in the Production Variance Detail record.

For information on how these production variances are calculated, see the Analyzing Manufacturing topic of the PeopleSoft Cost Management Documentation.

Pages Used to Review Production Variance Details

Page Name	Definition Name	Usage
Production Variance Drilldown Page	CE_PRODVAR_INQUIRY	Analyze the calculation of production variances for a production ID or schedule (standard-cost items only). The production variance calculation details are retrieved from the Production Variance Detail record (SF_VARS_DETAIL) and the Configuration Variance Detail record (SF_CFGVAR_DET).

Searching for Production Variance Drilldown Information

Access the Search tab for the Production Variance Drilldown page (Production Control, Close and Analyze Production, Production Variance Drilldown).

This example illustrates the fields and controls on the Search Tab of the Production Variance Drilldown page. You can find definitions for the fields and controls later on this page.

The screenshot shows the 'Search' tab of the Production Variance Drilldown page. It contains the following fields and controls:

- Business Unit:** A text input field containing 'US008' with a magnifying glass icon.
- Production ID:** A text input field containing 'PRD00236' with a magnifying glass icon.
- Production Area:** A text input field.
- *Item ID:** A text input field with a magnifying glass icon.
- Prdn Due Date:** A text input field.
- Prdn Due Shift:** A text input field.
- Date Type:** A section with two radio buttons: 'Prdn Start' and 'Prdn Due'.
- Additional Search Criteria:** A section containing a dropdown menu for 'Variance Type'.
- Search:** An orange button at the bottom right.

Use the Search tab of the Production Variance Drilldown page to enter search criteria to retrieve the calculation details of the production variances produced for a production ID or schedule. The Production Variance Drilldown page displays only one production ID or schedule at a time.

Field or Control	Description
Business Unit	(required) Select the business unit of the production ID or schedule to be reviewed. To generate production variance details during the Close Production process, the variance drilldown feature must be enabled at the manufacturing business unit definition using the MFG BU Prdn Options page.
Production ID	Select the production ID to be reviewed. This field is required if you are viewing the production variance calculations of a production ID.
Production Area	Enter the production area where the end item is generated for the production schedule to be reviewed. This field is required if you are viewing the production variance calculations of a production schedule.
Item ID	Enter the end item ID being manufactured in the production schedule to be reviewed. This field is required if you are viewing the production variance calculations of a production schedule.
Date Type	Select Prdn Start or Prdn Due. The production schedule information is based on the start date of production or when production is due to be completed.
Prdn Start (production start) and Prdn Start Date (production start date)	Select Prdn Start (in the Date Type group box) to view a production schedule that was due to begin on a specific production start date. Enter the start date for the production schedule in the Prdn Start Date field.
Prdn Due (production due) and Prdn Due Date (production due date)	Select Prdn Due (in the Date Type group box) to view a production schedule based on production due dates. Enter the completion date for the production schedule in the Prdn Due Date field.
Prdn Due Shift (production due shift) or Prdn Start Shift (production start shift)	Select a valid shift for the production schedule based on either when the shift ends or when the shift begins.
Variance Type	Select a production variance to view only one variance produced for the production ID or schedule. Leave this field blank to view all production variances produced for the production ID or schedule. Once the production ID or production schedule data has been entered on this page, the variance types displayed in this drop down list are limited to the specific variances produced for the production ID or schedule.

Field or Control	Description
Search	Click the Search button to initiate a search for production variance details based on the search criteria entered. If no rows are found, you receive the message “No Matching Values Found”. This message could display because the Close Production process has not been run for the production ID or schedule.

Note: If multiple production schedules exist for the production area/item/date/shift, then a warning appears followed by a listing of the production schedules from which you can select one production schedule to view.

Reviewing Production Variance Drilldown Information

Access the Review Variances tab for the Production Variance Drilldown page (Production Control, Close and Analyze Production, Production Variance Drilldown. Enter search criteria and click the Search button).

This example illustrates the fields and controls on the Review Variances tab of the Production Variance Drilldown page. You can find definitions for the fields and controls later on this page.

The screenshot displays the 'Review Variances' tab. At the top, it shows search criteria: Production ID PRD00236, Unit US008, Production Type Production, Start Quantity 10.0000, End Quantity 10.0000, Item MG6500, BOM Code 1, and Routing Code 1. Below this is a 'Variance Details' table with columns for Production ID, Variance Type, and Variance Amount. The table lists several variance types: Configuration Variance (4.9560), Usage Variance (5.0000), Component Yield Variance (1.5000), Labor Lot Size Variance (-24.3187), and Process Routing Variance (0.0001). A 'Total Variance' of -12.8626 is shown at the bottom of this section. Below the total variance is a 'Usage Variance' section, which provides a detailed breakdown for component MG-B002 (MG-B002 Lamp Base). This detailed table includes columns for Component ID, Description, Std UOM, Cost Element, Issue Qty, This Level Cost, Lower Level Cost, Current Scheduled Qty, Component Yield, Variance Amount, and Variance Amount - 6 Dec Prec. The detailed usage variance for MG-B002 shows an issue quantity of 11.0000, a this level cost of 5.0000, and a variance amount of 5.0000.

Use the Review Variances tab of the Production Variance Drilldown page to review the calculation details of the production variances produced for a production ID or schedule. The Production Variance Drilldown page displays only one production ID or schedule at a time.

Note: In order to view variance data using the Production Variance Drilldown page, the production ID or schedule must be in the status of Closed for Accounting and you must first run the Close Production process to populate the Production Variance Detail record (SF_VARS_DETAIL) and the Configuration Variance Detail record (SF_CFGVAR_DET).

Production ID

The Production ID group box displays information about the production ID or schedule reviewed on this page.



Variance Details

The Variance Details group box displays the different variance types produced for this production ID or schedule by the Close Production process. The Production Detail tab displays information about the production ID or schedule.

Field or Control	Description
 (Download icon)	Click the Download icon to move the data in the displayed tab to a Microsoft Excel spreadsheet.
Variance Type	Displays the name of the variances calculated for this production ID or schedule. Click the variance type to display a group box at the bottom of this page that contains the numbers used to calculate this variance.
Show All	Click to display all of the variance type group boxes at the bottom of this page. For example, if there are four variance types shown in the Variance Details group box, then four separate group boxes are displayed at the bottom of this page to display the calculation details for these production variances.
Hide All	Click to conceal the variance type group boxes displayed at the bottom of the page.
Total Variance	Displays the total of all the production variances applied to this production ID or schedule and displayed in the Variance Details group box.

Variance Type Group Boxes

For each production variance produced for this production ID or schedule, you can display a group box for the specific variance. The title of the group box is the variance type name. All required information used to calculate the variance is included in the Variance Detail tab. The fields displayed are different based on the variance type. The Production Detail tab displays information about the production ID or schedule.

<i>Field or Control</i>	<i>Description</i>
 (Download icon)	Click the Download icon to move the data in the displayed tab to a Microsoft Excel spreadsheet.
 Embedded Help icon	Click the Embedded Help icon to display information about the production variance and how it is calculated.

Archiving and Purging Production Data

Understanding the Production Archive and Purge Process

PeopleSoft Manufacturing enables you to archive or purge production data contained in production tables to reduce storage needs and increase performance. You can move the production data into archive tables.

Before you archive production data, keep these points in mind:

- You can archive data for production IDs and production schedules.
- You can archive production data for configured orders (production IDs).

However, configured orders must meet these criteria:

- All lines on the related sales order must have a status of *Closed* or *Canceled*.
 - All lines on the direct production order must have a status of *Closed* or *Canceled*.
- You can archive data for teardown and rework production IDs.
 - All manufacturing costing must be completed before you can archive production data.

All components must be consumed or deleted before archiving or purging can occur.

- All manufacturing accounting lines must be posted to the general ledger before you can archive production data.

If this posting process is not completed, the production orders will be disqualified during the qualification process.

- You cannot archive serial genealogy production data.
- You cannot purge production IDs that have subcontracted purchase orders.
- You may break certain relationships, such as production ID splits and configured production orders.

Pages Used to Archive and Purge Production Data

Page Name	Definition Name	Usage
Archive Production Data Page	RUN_SF_PURGE	Select production data to be archived or purged.
Archive Parameters Page	RUN_SF_PURGE_PARM	Enter selection criteria for the production data to be archived or purged.

See the product documentation for *PeopleTools: Application Designer Developer's Guide*

Related Links

[Understanding the Ramifications of Archiving and Purging Production Data](#)

Archiving and Purging Production Data

Once you have completed production, determine if you want to move or purge production data.

Archive Production Data Page

Use the Archive Production Data page (RUN_SF_PURGE) to select production data to be archived or purged.

Navigation:

Production Control > Close and Analyze Production > Archive Production Data > Archive Production Data

This example illustrates the fields and controls on the Archive Production Data page. You can find definitions for the fields and controls later on this page.

Purge Process Option

Select one of these options:

- **Archive/Purge:** Move selected data into ARCH (archive) tables and also purge the data from the production tables.
- **Purge:** Delete selected data from the production tables.

Archive Parameters Page

Use the Archive Parameters page (RUN_SF_PURGE_PARM) to enter selection criteria for the production data to be archived or purged.

Navigation:

Production Control > Close and Analyze Production > Archive Production Data > Archive Parameters

<i>Field or Control</i>	<i>Description</i>
Date, Select Production IDs, and Select Production Schedules	Select values based on All or a Range for production dates, production IDs, production areas, or item IDs. Note: Using the Date option enables you to select data based on the production <i>due</i> date.

Warning! The purging function is powerful. Improper use might result in the unintentional loss of data. We recommend that you use the purging process only after you have been properly trained to use it.

Understanding the Ramifications of Archiving and Purging Production Data

Keep these points in mind when you determine which production data you want to archive or purge:

- For production ID splits, if you purge this data, you will not be able to see the split history.
- For configured production IDs, when a configured production order is purged, you will not be able to access the Production ID link from the Direct Production Order inquiry page.

This link enables you to access the Production ID Maintenance component. Therefore, you will not be able to view any transaction history associated with this configured order.

- For accounting line drilldowns, you must make sure that the accounting lines are posted to the journal entry before purging this data.

Once you have purged the production data, you will not be able to see the accounting line drilldowns (Cost Management Line Drill Down page).

Related Links

[Generating Production ID Splits](#)

“Understanding Transaction Costing and Accounting Entry Creation” (PeopleSoft Cost Management)

Understanding Scheduling Operations

Production Scheduling in PeopleSoft Manufacturing

In PeopleSoft Manufacturing, you can maintain the schedule for production using the PeopleSoft Manufacturing scheduling algorithms or PeopleSoft Supply Planning solvers. Although the PeopleSoft Supply Planning solvers use production data from PeopleSoft Manufacturing to create and maintain a production plan, the production plan derives the schedule based on slightly different factors and scheduling algorithms than those used in PeopleSoft Manufacturing. PeopleSoft Manufacturing schedules each production ID or production schedule quantity independently of other production IDs or production schedules. It does not consider demands put on resources by other production when scheduling the individual production ID or production schedule quantity.

However, PeopleSoft Supply Planning can consider resource requirements across multiple production IDs or production schedules. PeopleSoft Supply Planning schedules and reschedules production, so available capacity is not exceeded in any one day.

Although Oracle recommends that you use the PeopleSoft Supply Planning solvers to schedule or optimize production, times occur when you might need to add or change a production ID or production schedule without running it through the solvers. If capacity is a concern in the environment, the actual start and due dates and times that PeopleSoft Manufacturing determines should be used only as a guideline or estimate.

This topic describes the factors that are involved in the scheduling of production using PeopleSoft Manufacturing and PeopleSoft Supply Planning.

Factors Affecting Scheduling with PeopleSoft Manufacturing

If you are using PeopleSoft Manufacturing to schedule production, in addition to planned lead times, these factors affect the actual start date and time and the actual due date and time of each operation:

- Operation overlap, based on a percentage or send ahead quantity.
- Whether setup can occur during queue time or at any time after production begins.
- Whether setup time is included in scheduling the operation.
- Operation intensity.
- The work center calendar, if one exists.
- The production calendar, if one exists.
- The five-day workweek calendar.

Note: If PeopleSoft Supply Planning is installed, you cannot define queue planning lead times. Simultaneous setup and queue is not considered.

You define these factors for each business unit, item, work center, or routing. You can also define these factors when maintaining the operation list if the production is in the Firmmed or Released status when an operation list is created.

Maintaining Production Dates and Actual Dates

All production IDs and production schedules maintain production date and shift information as well as actual date and time information.

Production date and shift information is defined as the actual working day and shift (or manufacturing day and shift) during which component and production scheduling can be done. You define production dates and shifts through the production calendar or the work center calendars.

Actual date and time is defined as the actual date and time the production is scheduled to begin or end. In most cases, production dates and actual dates are the same. If you have production shifts that span two days, the actual date for production may be different from the production date. The system determines an actual date by the actual time that a production is scheduled to start or end within the production shift.

Defining Production Scheduling Methods

You define a production scheduling method when you create a new production ID. When you manually add a production ID, the system schedules it based on whether you know when you want to start production or when the item is due:

- If you decide to schedule the production ID based on the completion date and time or the due date and time, it is backward scheduled.

In this case, the system calculates the actual start date and time. The production start date and shift as well as the production due date and shift associated with both the actual start date and time and due date and time are determined.

- If you decide to schedule the production ID based on the actual start date and time, it is forward scheduled.

In this case, the system determines when the assemblies will be complete and calculates an actual due date and time. The production start date and shift as well as the production due date and shift associated with both the actual start date and time and due date and time are determined.

PeopleSoft Manufacturing *always* backward schedules production schedules. When adding a new production schedule, you enter a production due date and production due shift for the production quantity. The system then calculates the production start date and production start shift. The actual start date and time as well as the actual due date and time are also calculated.

When changing the status for a production ID or production schedule to Firmmed or Released, the system copies the item's routing and creates an operation list. As the system creates the operation list, it also determines the actual start date and time and actual due date and time for each operation. When the system creates the operations list, it reschedules each operation any time that it's modified.

Factors Affecting Scheduling with PeopleSoft Supply Planning

PeopleSoft Supply Planning considers several factors when determining the actual start and due date and time of production, teardown, or rework orders, as well as the actual start date and time and actual due date and time of each operation. These factors include:

- Planning constraints.
- Material availability.
- Planning labor or machine setup, run, and fixed run times or run rates defined for each operation.
- Operation overlap.
- Operation intensity.
- Work center calendars, if they exist for the work centers associated with each operation.
- The production calendar, if one exists.
- The five-day workweek calendar.

Note: Although you can maintain calendars in PeopleSoft Supply Planning, you must use the calendars maintained in PeopleSoft Manufacturing. The calendar data is sent to PeopleSoft Supply Planning with other production data when you are creating a PeopleSoft Supply Planning schedule.

You define these factors as you set up manufacturing data for each business unit, item, work center, or routing. You can also define these factors when maintaining the operation list if the production is in Firmed or Released status.

As PeopleSoft Supply Planning generates an optimized production plan, the system considers material and resource requirements across all production. Additionally, if an item's primary routing causes a constraint violation, the system considers an alternate routing. When the routing is selected, PeopleSoft Supply Planning schedules individual operations for new or existing production, again considering all constraints. The system then sends this information (in the form of planning messages) to PeopleSoft Manufacturing. These messages recommend that new production IDs or production schedules be added or existing production IDs and production schedules be rescheduled or canceled.

Related Links

[“PeopleSoft Supply Planning Overview” \(PeopleSoft Supply Planning\)](#)

Examples of Production Scheduling

The following examples illustrate how PeopleSoft Manufacturing creates and maintains operation schedules. These examples illustrate how the system calculates actual start and due dates and times for different operations using forward and backward scheduling.

Note: These examples assume that you are not using the PeopleSoft Supply Planning solvers to schedule production.

The examples use these types of shop floor operations:

- Example 1: Operations with no overlap; queue and setup are done sequentially.
- Example 2: Operations with no overlap; queue and setup are done concurrently; queue time is less than setup time.
- Example 3: Operations with no overlap, queue and setup are done concurrently; setup time is less than queue time.
- Example 4: Operations with no overlap; setup is not included.
- Example 5: Operation overlap; queue and setup are done sequentially.

These production times are used for all examples:

Op	Queue	Setup	Run	Intransit	Overlap
10	None	1 hour	5 hours (.5 hr/unit)	2 hours	None
20	1 hour	3 hours	10 hours (1 hr/unit)	1 hour	None

Note: Even though PeopleSoft Manufacturing calculates start and due dates and times to the minute, hours are used to make it easier to manually calculate these shop floor operation examples.

All examples assume a 24-hour day with an operation start quantity of 10 units. The start of the operation is when setup starts.

Example 1

This diagram shows an example of operations with no overlap and the queue and setup are done sequentially:

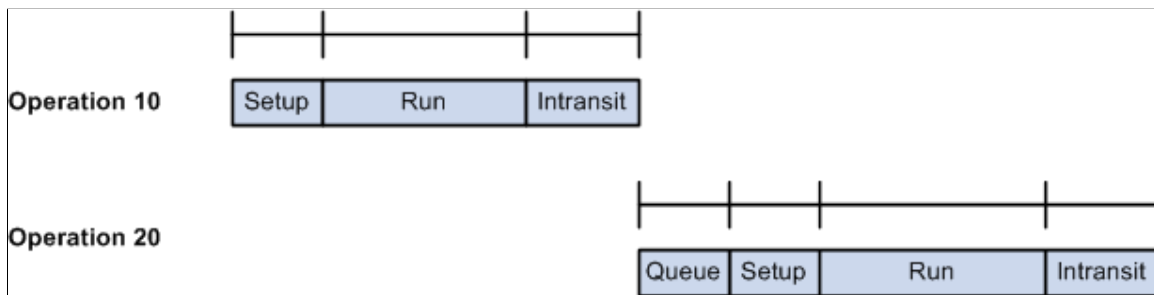

Operation	Operation Start	Run Start	Operation Due
10	Day 1, 8:00 a.m.	Day 1, 9:00 a.m.	Day 1, 2:00 p.m.
20	Day 1, 5:00 p.m.	Day 1, 8:00 p.m.	Day 2, 6:00 a.m.

Forward Scheduling Calculations

Production ID Start Date and Time = Day 1, 8:00 a.m.

This table lists the steps that you take to calculate the start and due date and times for the first operation (Operation 10):

Step	To Calculate	Use	Notes
1	Operation 10 start date and time.	Production ID's start date and time.	This calculation assumes that queue cannot occur at the first operation.
2	Operation 10 run start date and time.	Operation start date and time + setup time.	None.
3a or	Operation 10 run time (time and unit).	Operation start quantity \times run rate (converted to hours) + fixed run (converted to hours).	Use this calculation if the run rate is in terms of time per unit.
3b	Operation 10 run time (units/time).	Operation start quantity and run rate (converted to hours) + fixed run (converted to hours).	Use this calculation if the run rate is in terms of units per time unit.
4	Operation 10 due date and time.	Run start date and time + run time.	None.

This table lists the steps that you take to calculate start and due dates and times for the second operation (Operation 20):

Step	To Calculate	Use	Notes
1	Operation 20 start date and time.	Previous operation's (Operation 10) due date and time + previous operation's in transit time + current operation's queue time.	None.
2	Operation 20 run start date and time.	Current operation start date and time + setup time.	None.
3a, or	Operation 20 run time (time and unit).	Operation start quantity \times run rate (converted to hours) + fixed run (converted to hours).	Use this calculation if the run rate is in terms of time per unit.

Step	To Calculate	Use	Notes
3b	Operation 20 run time (units/time).	Operation start quantity and run rate (converted to hours) + fixed run (converted to hours).	Use this calculation if the run rate is in terms of units per time unit.
4	Operation 20 due date and time.	Current operation run start date and time + run time.	If you have a schedule with more than two operations, repeat steps 1 through 4 in this table until all subsequent operation due dates and times are calculated.

Backward Scheduling Calculations

Production ID Due Date and Time = Day 2, 6:00 a.m.

This table lists the steps that you take to calculate the start and due date and times for the last operation (Operation 20):

Step	To Calculate	Use	Notes
1	Operation 20 due date and time.	Production ID's due date and time – current operation's in transit time.	None.
2a, or	Operation 20 run time (time and unit).	Operation start quantity × run rate (converted to hours) + fixed run (converted to hours).	Use this calculation if the run rate is in terms of time per unit.
2b	Operation 20 run time (units/time).	Operation start quantity / run rate (converted to hours) + fixed run (converted to hours).	Use this calculation if the run rate is in terms of units per time unit.
3	Operation 20 run start date and time.	Current operation's due date and time – run time.	None.
4	Operation 20 start date and time.	Current operation's run start date and time – setup time.	None.

This table lists the steps that you take to calculate start and due dates and times for the prior operation (Operation 10):

Step	To calculate	Use	Notes
1	Operation 10 due date and time.	Subsequent operation's (Operation 20) start date and time – subsequent operation's queue time – current operation's in transit time.	None.
2a, or	Operation 10 run time (time/unit).	Operation start quantity × run rate (converted to hours) + fixed run (converted to hours).	Use this calculation if the run rate is in terms of time per unit.
2b	Operation 10 run time (units and time).	Operation start quantity / run rate (converted to hours) + fixed run (converted to hours).	Use this calculation if the run rate is in terms of units per time unit.
3	Operation 10 run start date and time.	Current operation's due date and time – run time.	None.
4	Operation 10 start date and time.	Current operation's run start date and time – setup time.	If you have a schedule with more than two operations, repeat steps 1 through 4 in this table until all previous operation due dates and times are calculated.

Example 2

This diagram shows an example of operations with no overlap and the queue and setup are done concurrently. The queue time is less than the setup time:

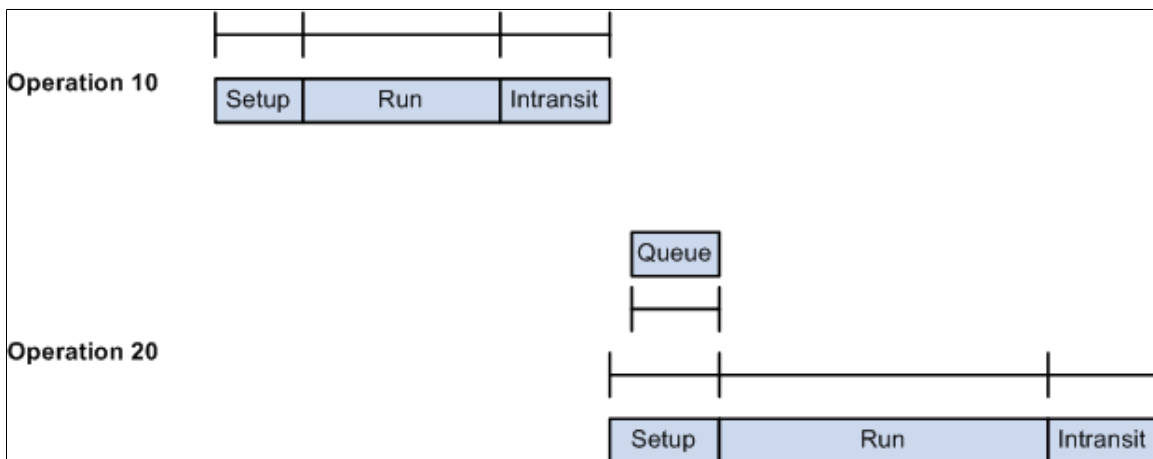

Operation	Operation Start	Run Start	Operation Due
10	Day 1, 8:00 a.m.	Day 1, 9:00 a.m.	Day 1, 2:00 p.m.
20	Day 1, 4:00 p.m.	Day 1, 7:00 p.m.	Day 2, 5:00 a.m.

Forward Scheduling Calculations

Production ID Start Date and Time = Day 1, 8:00 a.m.

This table lists the steps that you take to calculate the start and due date and times for the first operation (Operation 10):

Step	To Calculate	Use	Notes
1	Operation 10 start date and time.	Production ID's start date and time.	This calculation assumes that queue doesn't occur at the first operation.
2	Operation 10 run start date and time.	Operation start date and time + setup time.	None.
3a, or	Operation 10 run time (time/unit).	Operation start quantity × run rate (converted to hours) + fixed run (converted to hours).	Use this calculation if the run rate is in terms of time per unit.
3b	Operation 10 run time (units and time).	Operation start quantity / run rate (converted to hours) + fixed run (converted to hours).	Use this calculation if the run rate is in terms of units per time unit.
4	Operation 10 due date and time.	Run start date and time + run time.	None.

This table lists the steps that you take to calculate start and due dates and times for the second operation (Operation 20):

Step	To Calculate	Use	Notes
1	Operation 20 start date and time.	Previous operation's (Operation 10) due date and time + prior operation's in transit time.	This calculation assumes that queue time is less than setup time.

Step	To Calculate	Use	Notes
2	Operation 20 run start date and time.	Current operation start date and time + setup time.	None.
3a, or	Operation 20 run time (time/unit).	Operation start quantity \times run rate (converted to hours) + fixed run (converted to hours).	Use this calculation if the run rate is in terms of time per unit.
3b	Operation 20 run time (units and time).	Operation start quantity / run rate (converted to hours) + fixed run (converted to hours).	Use this calculation if the run rate is in terms of units per time unit.
4	Operation 20 due date and time.	Current operation run start date and time + run time.	If you have a schedule with more than two operations, repeat steps 1 through 4 in this table until all subsequent operation due dates and times are calculated.

Backward Scheduling Calculations

Production ID Due Date and Time = Day 2, 5:00 a.m.

This table lists the steps that you take to calculate the start and due date and times for the last operation (Operation 20):

Step	To Calculate	Use	Notes
1	Operation 20 due date and time.	Production ID's due date and time – current operation's in transit time.	None.
2a, or	Operation 20 run time (time/unit).	Operation start quantity \times run rate (converted to hours) + fixed run (converted to hours).	Use this calculation if the run rate is in terms of time per unit.
2b	Operation 20 run time (units and time).	Operation start quantity / run rate (converted to hours) + fixed run (converted to hours).	Use this calculation if the run rate is in terms of units per time unit.
3	Operation 20 run start date and time.	Current operation's due date and time – run time.	None.

Step	To Calculate	Use	Notes
4	Operation 20 start date and time.	Current operation's run start date and time – setup time.	None.

This table lists the steps that you take to calculate start and due dates and times for the prior operation (Operation 10):

Step	To Calculate	Use	Notes
1	Operation 10 due date and time.	Subsequent operation's (Operation 20) start date and time – current operation's in transit time.	This calculation assumes that queue time is less than setup time.
2a, or	Operation 10 run time (time/unit).	Operation start quantity × run rate (converted to hours) + fixed run (converted to hours).	Use this calculation if the run rate is in terms of time per unit.
2b	Operation 10 run time (units and time).	Operation start quantity / run rate (converted to hours) + fixed run (converted to hours).	Use this calculation if the run rate is in terms of units per time unit.
3	Operation 10 run start date and time.	Current operation's due date and time – run time.	None.
4	Operation 10 start date and time.	Current operation's run start date and time – setup time.	If you have a schedule with more than two operations, repeat steps 1 through 4 in this table until all previous operation due dates and times are calculated.

Example 3

This diagram shows an example of operations with no overlap, the queue and setup are done concurrently, and the setup time is less than the queue time:

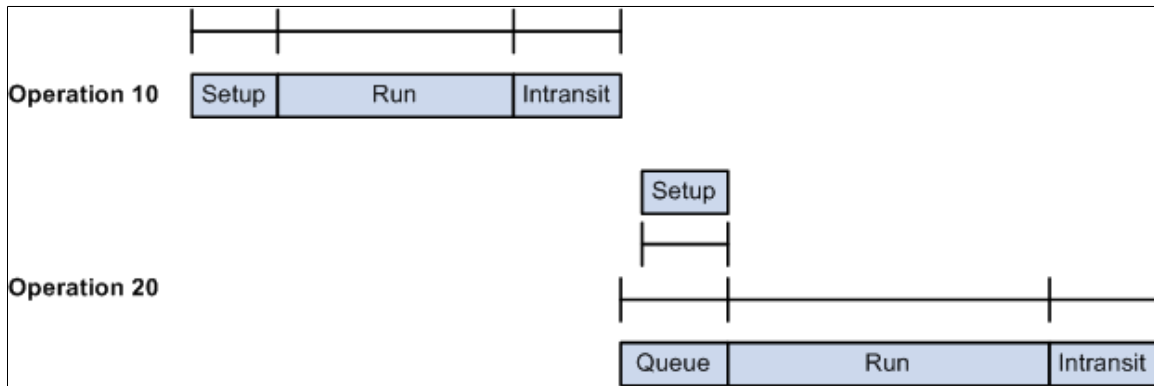

<i>Operation</i>	<i>Operation Start</i>	<i>Run Start</i>	<i>Operation Due</i>
10	Day 1, 8:00 a.m.	Day 1, 9:00 a.m.	Day 1, 2:00 p.m.
20	Day 1, 6:00 p.m.	Day 1, 7:00 p.m.	Day 2, 5:00 a.m.

Forward Scheduling Calculations

Production ID Start Date and Time = Day 1, 8:00 a.m.

This table lists the steps that you take to calculate the start and due date and times for the first operation (Operation 10):

<i>Step</i>	<i>To Calculate</i>	<i>Use</i>	<i>Notes</i>
1	Operation 10 start date and time.	Production ID's start date and time.	This calculation assumes that queue doesn't occur at the first operation.
2	Operation 10 run start date and time.	Operation start date and time + setup time.	None.
3a, or	Operation 10 run time (time/unit).	Operation start quantity × run rate (converted to hours) + fixed run (converted to hours).	Use this calculation if the run rate is in terms of time per unit.
3b	Operation 10 run time (units and time).	Operation start quantity / run rate (converted to hours) + fixed run (converted to hours).	Use this calculation if the run rate is in terms of units per time unit.

Step	To Calculate	Use	Notes
4	Operation 10 due date and time.	Run start date and time + run time.	None.

This table lists the steps that you take to calculate start and due dates and times for the second operation (Operation 20):

Step	To Calculate	Use	Notes
1	Operation 20 start date and time.	Prior operation's (Operation 10) due date and time + prior operation's in transit time + (queue – setup time of current operation).	This calculation assumes that setup time is less than queue time.
2	Operation 20 run start date and time.	Current operation start date and time + setup time.	None.
3a or	Operation 20 run time (time/unit).	Operation start quantity × run rate (converted to hours) + fixed run (converted to hours).	Use this calculation if the run rate is in terms of time per unit.
3b	Operation 20 run time (units and time).	Operation start quantity / run rate (converted to hours) + fixed run (converted to hours)	Use this calculation if the run rate is in terms of units per time unit.
4	Operation 20 due date and time.	Current operation run start date and time + run time.	If you have a schedule with more than two operations, repeat steps 1 through 4 in this table until all subsequent operation due dates and times are calculated.

Backward Scheduling Calculations

Production ID Due Date and Time = Day 2, 5:00 a.m.

This table lists the steps that you take to calculate the start and due date and times for the last operation (Operation 20):

Step	To Calculate	Use	Notes
1	Operation 20 due date and time	Production ID's due date and time – current operation's intransit time	None.
2a, or	Operation 20 run time (time/unit)	Operation start quantity × run rate (converted to hours) + fixed run (converted to hours)	Use this calculation if the run rate is in terms of time per unit.
2b	Operation 20 run time (units and time)	Operation start quantity / run rate (converted to hours) × fixed run (converted to hours)	Use this calculation if the run rate is in terms of units per time unit.
3	Operation 20 run start date and time	Current operation's due date and time – run time	None.
4	Operation 20 start date and time	Current operation's run start date and time – setup time	None.

This table lists the steps that you take to calculate start and due dates and times for the prior operation (Operation 10):

Step	To Calculate	Use	Notes
1	Operation 10 due date and time	Subsequent operation's (Operation 20) start date and time – (queue time - setup time of subsequent operation) - current operation's intransit time	This calculation assumes that setup time is less than queue time.
2a, or	Operation 10 run time (time/unit)	Operation start quantity x run rate (converted to hours) + fixed run (converted to hours)	Use this calculation if the run rate is in terms of time per unit.
2b	Operation 10 run time (units and time)	Operation start quantity/ run rate (converted to hours) + fixed run (converted to hours)	Use this calculation if the run rate is in terms of units per time unit.
3	Operation 10 run start date and time	Current operation's due date and time – run time	None.

Step	To Calculate	Use	Notes
4	Operation 10 start date and time	Current operation's run start date and time – setup time	If you have a schedule with more than two operations, repeat steps 1 through 4 in this table until all prior operation due dates and times are calculated.

Example 4

This diagram shows an example of operations with no overlap and the setup is not included:

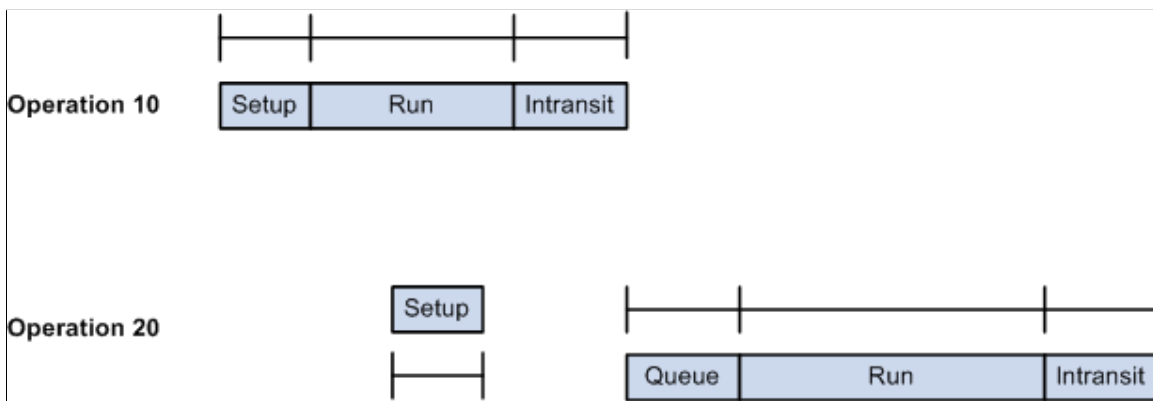

Operation	Operation Start	Run Start	Operation Due
10	Day 1, 8:00 a.m.	Day 1, 9:00 a.m.	Day 1, 2:00 p.m.
20	Day 1, 2:00 p.m.	Day 1, 5:00 p.m.	Day 2, 3:00 a.m.

Forward Scheduling Calculations

Production ID Start Date and Time = Day 1, 8:00 a.m.

This table lists the steps that you take to calculate the start and due date and times for the first operation (Operation 10):

Step	To Calculate	Use	Notes
1	Operation 10 start date and time	Production ID's start date and time	This calculation assumes that queue doesn't occur in the first operation.

Step	To Calculate	Use	Notes
2	Operation 10 run start date and time	Operation start date and time + setup time	Setup is always included at the first operation.
3a, or	Operation 10 run time (time/unit)	Operation start quantity x run rate (converted to hours) + fixed run (converted to hours)	Use this calculation if the run rate is in terms of time per unit.
3b	Operation 10 run time (units and time)	Operation start quantity / run rate (converted to hours) + fixed run (converted to hours)	Use this calculation if the run rate is in terms of units per time unit.
4	Operation 10 due date and time	Run start date and time + run time	None.

This table lists the steps that you take to calculate start and due dates and times for the second operation (Operation 20):

Step	To Calculate	Use	Notes
1	Operation 20 start date and time	Prior operation's (Operation 10) due date and time + prior operation's intransit time + current operation's queue time - current operation's setup time	This calculation assumes that setup can be completed any time after the first operation run has started. The start date and time represent the latest possible time that you should begin setup.
2	Operation 20 run start date and time	Current operation start date and time + setup time	None.
3a, or	Operation 20 run time (time and unit)	Operation start quantity x run rate (converted to hours) + fixed run (converted to hours)	Use this calculation if the run rate is in terms of time per unit.
3b	Operation 20 run time (units/time)	Operation start quantity and run rate (converted to hours) + fixed run (converted to hours)	Use this calculation if the run rate is in terms of units per time unit.

Step	To Calculate	Use	Notes
4	Operation 20 due date and time	Current operation run start date and time + run time	If you have a schedule with more than two operations, repeat steps 1 through 4 in this table until all subsequent operation due dates and times are calculated.

Backward Scheduling Calculations

Production ID Due Date and Time = Day 2, 3:00 a.m.

This table lists the steps that you take to calculate the start and due date and times for the last operation (Operation 20):

Step	To Calculate	Use	Notes
1	Operation 20 due date and time	Production ID's due date and time - current operation's intransit time	None.
2a, or	Operation 20 run time (time and unit)	Operation start quantity x run rate (converted to hours) + fixed run (converted to hours)	Use this calculation if the run rate is in terms of time per unit.
2b	Operation 20 run time (units/time)	Operation start quantity / run rate (converted to hours) + fixed run (converted to hours)	Use this calculation if the run rate is in terms of units per time unit.
3	Operation 20 run start date and time	Current operation's due date and time - run time	None.
4	Operation 20 start date and time	Current operation's run start date and time - setup time	This calculation assumes that setup can be completed any time after the first operation run has started. The start date and time represent the latest possible time that you should begin setup.

This table lists the steps that you take to calculate start and due dates and times for the prior operation (Operation 10):

Step	To Calculate	Use	Notes
1	Operation 10 due date and time	Subsequent operation's (Operation 20) start date and time - subsequent operation's queue time - current operation's intransit time	The run start date and time is used and setup is not included. The setup at Operation 20 can be completed at the same time the prior operation is being run.
2a, or	Operation 10 run time (time/unit)	Operation start quantity x run rate (converted to hours) + fixed run (converted to hours)	Use this calculation if the run rate is in terms of time per unit.
2b	Operation 10 run time (units and time)	Operation start quantity / run rate (converted to hours) + fixed run (converted to hours)	Use this calculation if the run rate is in terms of units per time unit.
3	Operation 10 run start date and time	Current operation's due date and time - run time	None.
4	Operation 10 start date and time	Current operation's run start date and time - setup time	If you have a schedule with more than two operations, repeat steps 1 through 4 in this table until all prior operation due dates and times are calculated.

Example 5

This diagram shows an example of operations overlap. The queue and setup are done sequentially. Assume that operations have overlap expressed as a percent (100% = total overlap, 0% = no overlap) or send ahead quantity. If overlap is expressed as a percentage, assume that all units are available for processing at the start of the run or soon after:

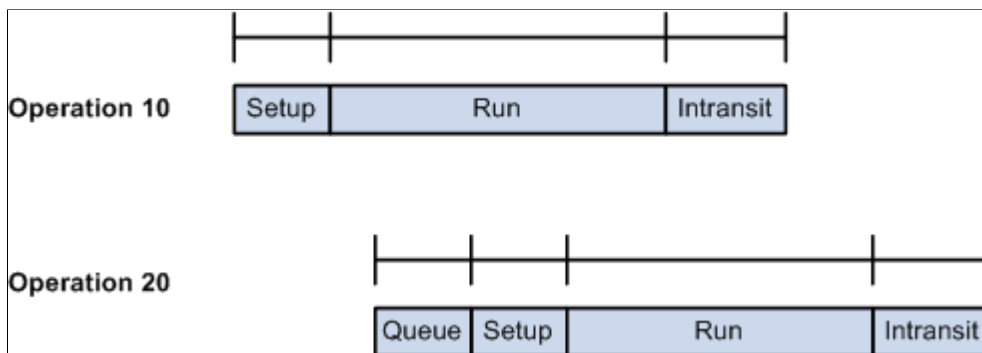

Operation	Operation Start	Run Start	Operation Due
10	Day 1, 8:00 a.m.	Day 1, 9:00 a.m.	Day 1, 2:00 p.m.
20	Day 1, 1:00 p.m.	Day 1, 4:00 p.m.	Day 2, 2:00 a.m.

Forward Scheduling Calculations

Production ID Start Date and Time = Day 1, 8:00 a.m.

This table lists the steps that you take to calculate the start and due date and times for the first operation (Operation 10):

Step	To Calculate	Use	Notes
1	Operation 10 start date and time	Production ID's start date and time	This calculation assumes that queue doesn't occur in the first operation.
2	Operation 10 run start date and time	Operation start date and time + setup time	None.
3a, or	Operation 10 run time (time/unit)	Operation start quantity x run rate (converted to hours) + fixed run (converted to hours)	Use this calculation if the run rate is in terms of time per unit.
3b	Operation 10 run time (units and time)	Operation start quantity / run rate (converted to hours) + fixed run (converted to hours)	Use this calculation if the run rate is in terms of units per time unit.
4	Operation 10 due date and time	Run start date and time + run time	None.

This table lists the steps that you take to calculate start and due dates and times for the second operation (Operation 20):

Step	To Calculate	Use	Notes
1a, or	Operation 20 start date and time; overlap expressed as a percentage	Prior operation's (Operation 10) start of run + [prior operation's total run time x (1 - overlap percent / 100)] + prior operation's intransit time + current operation's queue time	None.
1b	Operation 20 start date and time; overlap expressed as a send ahead quantity	Prior operation's (Operation 10) start of run + (prior operation's run rate x send ahead quantity, converted to hours) + prior operation's fixed run time + prior operation's intransit time + current operation's queue time	None.
2	Operation 20 run start date and time	Current operation start date and time + setup time	None.
3a, or	Operation 20 run time (time/unit)	Operation start quantity x run rate (converted to hours) + fixed run (converted to hours)	Use this calculation if the run rate is in terms of time per unit.
3b	Operation 20 run time (units/time)	Operation start quantity / run rate (converted to hours) + fixed run (converted to hours)	Use this calculation if the run rate is in terms of units per time unit.
4	Operation 20 due date and time	Current operation run start date and time + run time	If you have a schedule with more than two operations, repeat steps 1 through 4 in this table until all subsequent operation due dates and times are calculated.

Backward Scheduling Calculations

Production ID Due Date and Time = Day 2, 2:00 a.m.

This table lists the steps that you take to calculate the start and due date and times for the last operation (Operation 20):

Step	To Calculate	Use	Notes
1	Operation 20's due date and time	Production ID's due date and time - current operation's intransit time	None.
2a, or	Operation 20 run time (time/unit)	Operation start quantity x run rate (converted to hours) + fixed run (converted to hours)	Use this calculation if the run rate is in terms of time per unit.
2b	Operation 20 run time (units/time)	Operation start quantity/ run rate (converted to hours) + fixed run (converted to hours)	Use this calculation if the run rate is in terms of units per time unit.
3	Operation 20 run start date and time	Current operation's due date and time - run time	None.
4	Operation 20 start date and time	Current operation's run start date and time - setup time	None.

This table lists the steps that you take to calculate start and due dates and times for the prior operation (Operation 10), with an operation overlap expressed as a percentage:

Step	To Calculate	Use	Notes
1	Operation 10 due date and time, when operation overlap is expressed as a percentage	Subsequent operation's (Operation 20) start date and time - subsequent operation's queue time - current operation's intransit time + [current operation's total run time x (overlap percent / 100)]	None.
2a, or	Operation 10 run time (time/unit)	Operation start quantity x run rate (converted to hours) + fixed run (converted to hours)	Use this calculation if the run rate is in terms of time per unit.
2b	Operation 10 run time (units/time)	Operation start quantity / run rate (converted to hours) + fixed run (converted to hours)	Use this calculation if the run rate is in terms of units per time unit.
3	Operation 10 run start date and time	Current operation's due date and time - run time	None.

Step	To Calculate	Use	Notes
4	Operation 10 start date and time	Current operation's run start date and time - setup time	If you have a schedule with more than two operations, repeat steps 1 through 4 in this table until all prior operation due dates and times are calculated.

This table lists the steps that you take to calculate start and due dates and times for the prior operation (Operation 10), with an operation overlap expressed as a send ahead quantity:

Step	To Calculate	Use	Notes
1	Operation 10 due date and time, when operation overlap is expressed as a send ahead quantity	Subsequent operation's (Operation 20) start date and time - current operation's intransit time - subsequent operation's queue time + [current operation's run time x (Operation start quantity - send ahead quantity)]	None.
2a, or	Operation 10 run time (time and unit)	Operation start quantity x run rate (converted to hours) + fixed run (converted to hours)	Use this calculation if the run rate is in terms of time per unit.
2b	Operation 10 run time (units/time)	Operation start quantity / run rate (converted to hours) + fixed run (converted to hours)	Use this calculation if the run rate is in terms of units per time unit.
3	Operation 10 run start date and time	Current operation's due date and time - run time	None.
4	Operation 10 start date and time	Current operation's run start date and time - setup time	If you have a schedule with more than two operations, repeat steps 1 through 4 in this table until all prior operation due dates and times are calculated.

Delivered Workflows for PeopleSoft Manufacturing

Delivered Workflows for PeopleSoft Manufacturing

This section discusses PeopleSoft Manufacturing workflows. The workflows are listed alphabetically by workflow name.

Assembly Prdn Schedule Scrap Notification

This section discusses the Prdn Schedule Scrap Notification workflow.

Description

<i>Information Type</i>	<i>Description</i>
Event Description	Assembly scrap is recorded against a production schedule.
Action Description	Notifies the planner that assembly scrap has occurred on a production schedule.
Notification Method	Worklist

Workflow Objects

<i>Information Type</i>	<i>Description</i>
Event	Assy Sched Scrap Notification
Workflow Action	Assy Sched Scrap Notification
Role	Planner

Assembly PID Scrap Notification

This section discusses the Assembly PID Scrap Notification workflow.

Description

<i>Information Type</i>	<i>Description</i>
Event Description	Assembly scrap is recorded against a production ID.
Action Description	Notifies the planner that assembly scrap has occurred on a production ID.
Notification Method	Worklist

Workflow Objects

<i>Information Type</i>	<i>Description</i>
Event	Assy PID Scrap Notification
Workflow Action	Assy PID Scrap Notification
Role	Planner

BOM Change

This section discusses the BOM Change workflow.

Description

<i>Information Type</i>	<i>Description</i>
Event Description	A BOM is changed in PeopleSoft Manufacturing.
Action Description	Notifies the manufacturing engineer that a BOM has changed.
Notification Method	Worklist

Workflow Objects

<i>Information Type</i>	<i>Description</i>
Event	BOM Change Notification

<i>Information Type</i>	<i>Description</i>
Workflow Action	BOM Change Notification
Role	Manufacturing Engineer

Identify Production with Pending Quantities

This section discusses the Identify Production with Pending Quantities workflow.

Description

<i>Information Type</i>	<i>Description</i>
Event Description	Runs the PeopleSoft Application Engine SF_WFPRDCMP process.
Action Description	Notifies the production supervisor that there is nonzero quantity in the pending issue quantity or pending loss quantity fields of a component.
Notification Method	Worklist

Workflow Objects

<i>Information Type</i>	<i>Description</i>
Event	SF_PRDN_PENDQTYS
Workflow Action	SF Prdn Comp Pending Qty
Role	Production Supervisor

Potential Prdn Variance Report

This section discusses the Potential Prdn Variance Report workflow.

Description

<i>Information Type</i>	<i>Description</i>
Event Description	Run the PeopleSoft Application Engine SF_VARJB process to generate a Potential Production Variance Report.
Action Description	Runs the Production Variance Report and emails the variance report to the production supervisor for review.
Notification Method	Email

Workflow Objects

<i>Information Type</i>	<i>Description</i>
Event	POTENTIAL_PRDN_VARIANCE
Workflow Action	Potential Prdn Variance Report
Role	Production Supervisor

Production Calendar Change

This section discusses the Production Calendar Change workflow.

Description

<i>Information Type</i>	<i>Description</i>
Event Description	A production calendar is changed.
Action Description	When the production calendar is changed, a worklist notification is dispatched to the planner. Calendar changes include adding, changing, or deleting shifts. The planner may need to reschedule production.
Notification Method	Worklist.

Workflow Objects

<i>Information Type</i>	<i>Description</i>
Event	Calendar Notification
Workflow Action	Prdn Calendar
Role	Planner

Production ID Change

This section discusses the Production ID Change workflow.

Description

<i>Information Type</i>	<i>Description</i>
Event Description	A production ID is changed in the Maintain PIDs component.
Action Description	Notifies the planner that a production ID was changed.
Notification Method	Worklist

Workflow Objects

<i>Information Type</i>	<i>Description</i>
Event	Production Change Notification
Workflow Action	Production Change Notification
Role	Planner

Production Ready to Close

This section discusses the Production Ready to Close workflow.

Description

<i>Information Type</i>	<i>Description</i>
Event Description	Runs the PeopleSoft Application Engine SF_WFPNDPDN process.
Action Description	Notifies the production supervisor that production has a status of Pending Complete.
Notification Method	Worklist

Workflow Objects

<i>Information Type</i>	<i>Description</i>
Event	PRDN_PENDING
Workflow Action	Notify Pending Production
Role	Production Supervisor

Replenishment Notification

This section discusses the Replenishment Notification workflow.

Description

<i>Information Type</i>	<i>Description</i>
Event Description	Inventory reaches a minimum quantity during backflush, completions, or editing and issuing components.
Action Description	Notifies the inventory clerk that a WIP location item's quantity has fallen below the reorder point and initiates a material stock request.
Notification Method	Worklist

Workflow Objects

<i>Information Type</i>	<i>Description</i>
Event	Replenishment Notification
Workflow Action	Replenishment Notification
Role	Inventory Clerk

Routing Change

This section discusses the Routing Change workflow.

Description

<i>Information Type</i>	<i>Description</i>
Event Description	A routing is changed in the Maintain Routings component.
Action Description	When a routing is changed, a notification is sent to the manufacturing engineer.
Notification Method	Worklist

Workflow Objects

<i>Information Type</i>	<i>Description</i>
Event	Routing Change Notification
Workflow Action	Routing Change Notification
Role	Manufacturing Engineer

Task Change

This section discusses the Task Change workflow.

Description

<i>Information Type</i>	<i>Description</i>
Event Description	A task is changed in the Maintain Tasks component.
Action Description	When a task is changed, a notification is sent to the manufacturing engineer.
Notification Method	Worklist

Workflow Objects

<i>Information Type</i>	<i>Description</i>
Event	Task Change Notification
Workflow Action	Task Change Notification
Role	Manufacturing Engineer

Work Center Calendar Code Change

This section discusses the Work Center Calendar Code Change workflow.

Description

<i>Information Type</i>	<i>Description</i>
Event Description	Changes data for a work center calendar.
Action Description	When adding, changing, or deleting shifts on a calendar code associated with a work center, a notification is sent to the planner. The planner may want to reschedule production.
Notification Method	Worklist

Workflow Objects

<i>Information Type</i>	<i>Description</i>
Event	Calendar Code Notification
Workflow Action	Calendar Code Changed
Role	Planner

Workcenter Change

This section discusses the Workcenter Change workflow.

Description

<i>Information Type</i>	<i>Description</i>
Event Description	A work center is changed in the Maintain Work Centers component.
Action Description	When information associated with a work center is changed, a notification is sent to the manufacturing engineer.
Notification Method	Worklist

Workflow Objects

<i>Information Type</i>	<i>Description</i>
Event	WC Change Notification
Workflow Action	WC Change
Role	Manufacturing Engineer

PeopleSoft Manufacturing Report Descriptions

PeopleSoft Manufacturing Reports: General Description

This table lists the PeopleSoft Manufacturing reports. All the reports that are listed are SQR reports. If you need more information about these reports, refer to the report details at the end of this section.

<i>Report ID and Report Name</i>	<i>Description</i>	<i>Navigation</i>	<i>Run Control Page</i>
ENS1000 BOM Report	Lists the components on either manufacturing or engineering BOMs.	<ul style="list-style-type: none"> • Manufacturing Definitions > BOMs and Revisions > Reports > Create a Bill of Material • Engineering > BOMs and Revisions > Reports > Bills of Material > EBOM Report 	EN_BOM_REPORT
ENS1001 Routing Report	Lists the routing information for manufacturing or engineering routings.	<ul style="list-style-type: none"> • Manufacturing Definitions > Resources and Routings > Routings > Routing Report • Engineering > Routings > Engineering Routing Report > Routing Report 	RUN_ENS1001

Report ID and Report Name	Description	Navigation	Run Control Page
ENS1002 Compare Routings Report	Lists the differences between two manufacturing routings, two engineering routings, or one manufacturing routing and one engineering routing. Comparisons can also be based on the same item with different routing codes.	<ul style="list-style-type: none"> • Manufacturing Definitions > Resources and Routings > Routing Comparison Report > Routing Compare Report • Engineering > Routings > Eng Routing Comparison Report > Routing Compare Report 	RUN_ENS1002
ENS1003 Master Routing Where Used Report	Lists all items that reference another item as its master routing along with production data. This report is used in both Manufacturing and Engineering.	<ul style="list-style-type: none"> • Manufacturing Definitions > Resources and Routings > Master Rtg Where Used Report • Engineering > Routings > Eng Master Routing Where Used > Master Rtg Where Used Report 	RUN_ENS1003
ENS1004 Resources Where Used Report	Lists where resources are used on work centers, tasks, routings, and in production.	Manufacturing Definitions > Resources and Routings > Resources Where Used Report	RUN_ENS1004
ENS1005 Compare BOMs Report	Lists the differences between a manufacturing and an engineering BOM, or two engineering BOMs.	<ul style="list-style-type: none"> • Manufacturing Definitions > BOMs and Revisions > Reports > BOM Comparison Report > BOM Compare Report • Engineering > BOMs and Revisions > Reports > EBOM Comparison > EBOM Compare Report 	EN_BOM_COMP_REPORT
ENS1006 Work Centers Where Used Report	Lists the tasks, routings, and production associated with either a selected work center or a range of work centers within a particular business unit.	Manufacturing Definitions > Tasks and Work Centers > Work Centers Where Used Report	RUN_ENS1006

Report ID and Report Name	Description	Navigation	Run Control Page
ENS1007 Tasks Where Used Report	Lists the routings and production associated with either a selected task or a range of tasks within a particular business unit.	Manufacturing Definitions > Tasks and Work Centers > Tasks Where Used Report	RUN_ENS1006B
ENS1010 BOM Cost Report	Lists the component costs on either manufacturing or engineering BOMs.	<ul style="list-style-type: none"> • Manufacturing Definitions > BOMs and Revisions > Reports > Generate Costed BOM Report > BOM Costed Report • Engineering > BOMs and Revisions > Reports > EBOM Costed Report 	EN_BOM_COST_REPORT
ENS2000 Item Where Used Report	Lists all the BOMs on which an item appears either as a component or a substitute for a component. You'll find this information useful when you want to analyze the impact component changes can have on all existing BOMs.	<ul style="list-style-type: none"> • Manufacturing Definitions > BOMs and Revisions > Reports > Item Where Used • Engineering > BOMs and Revisions > Reports > Item Where Used 	EN_WHEREUSED_RPT
SF_MATRDY Material Readiness Report	<p>Determines the material readiness of a production run by checking the available quantity of component materials.</p> <p>See Running the Material Readiness Report.</p>	Production Control > Process Production > Release Production > Material Readiness Report	RUN_SF_MTLRDY RUN_SF_MTLRDY_SD

Report ID and Report Name	Description	Navigation	Run Control Page
<p>SFS1100 Production Close Process Report</p>	<p>Lists closed production schedules or production IDs, and details the variances incurred. Combine sort options to narrow down the production close information that is reported. For example, close only those production IDs within a selected production area for a single item. Use the Report Only Mode to view the production that can and can't be closed as well as the variances that can be generated as a result of an accounting close.</p>	<p>Production Control > Close and Analyze Production > Close Production</p>	<p>RUN_SFS1100</p>
<p>SFS1200 Production Reopen Process Report</p>	<p>Lists the before and after status of the production ID or area/item that needs to be reopened. Combining numerous sort options assists in narrowing down the production reopen information that is reported. For example, reopen production only for those production IDs within a selected production area for a single item. Use the Report Only Mode to provide a preview of the financial impact of reopening production without creating reversing entries.</p>	<p>Production Control > Close and Analyze Production > Reopen Production</p>	<p>RUN_SFS1200</p>
<p>SFS1500 Production Variance Report</p>	<p>Lists variances for production IDs or production schedules for a specified production due date/shift and above a minimum monetary amount. Variances include configuration, usage, component yield, lot size, routing process, rework, teardown, production mix variance, and outside processing.</p>	<p>Production Control > Close and Analyze Production > Production Variance Report</p>	<p>RUN_SFS1500</p>

Report ID and Report Name	Description	Navigation	Run Control Page
SFS1600 Potential Production Variance Report	Lists potential production variances that exist in production above a monetary amount, prior to closing for accounting production IDs and schedules. The report can be generated when in a production status of in process, pending complete, complete, and closed for labor. Variances include configuration, usage, component yield, lot size, routing process, rework, teardown, production mix variance, and outside processing.	Production Control > Close and Analyze Production > Potential Prdn Variance Report	RUN_SFS1600
SFS2001 Material Shortage Report	Lists production shortages as well as surplus inventory. Report options include a summary report or a report that ignores surplus quantities.	Production Control > Close and Analyze Production > Shortage Report	RUN_SFS2001
SFS2002 Dispatch List	Lists production ID or production schedule information, including operation and task details for each work center or range of work centers. Use this document to review the type and quantity of production that will be occurring at a particular work center or range of work centers for a specified date or range of dates. Selects production information by production start date or due date, or lists production that is past due. Additional report information includes component information for each work center/operation, operation start and due dates/times, subcontracted operation information, and production and operation level text.	Production Control > Process Production > Release Production > Print Dispatch List	RUN_SFS2002

Report ID and Report Name	Description	Navigation	Run Control Page
<p>SFS2003 Production Documents</p>	<p>Lists the component list, operation list, and work center, resource, and schedule information for a particular production ID. Print production documents for production IDs with a production document status of Ready to Print, reprint production documents, or print production documents for the specified production IDs regardless of the production document print status.</p>	<p>Production Control > Process Production > Release Production > Print Production Documents</p>	<p>RUN_SFS2003</p>
<p>SFS2004 Production Report</p>	<p>Lists all scheduled production for a specified range of actual start dates, production statuses, and production IDs and production schedules. Sort by actual due date, item ID, production area, production due date, or production start date.</p>	<p>Production Control > Define Production > Reports > Production Report</p>	<p>RUN_SFS2004</p>
<p>SFS2005 Efficiency and Utilization Report</p>	<p>Lists variances and utilization by operation, work center, production ID, and production area/item for both labor and machine. Report earned and actual labor by work center with or without the production ID or production schedule detail.</p>	<p>Production Control > Close and Analyze Production > Efficiency and Util Rpt</p>	<p>RUN_SFS2005</p>
<p>SFS2006 Component Where Used in Prdn Report</p>	<p>Lists the production IDs or production schedules where specified components are used in production. This report can be sorted by item ID, production due shift, production start date, or production ID. Also lists substitute information for the component, and can include production with a status of Firmed, Released, In Process, Pending Complete, Complete, Closed for Labor, and Closed to Accounting.</p>	<p>Production Control > Define Production > Reports > Component Where Used Report</p>	<p>RUN_SFS2006</p>

Report ID and Report Name	Description	Navigation	Run Control Page
SFS2007 Production Schedule by Area Report	Lists total production quantities by item for each calendar day within a 14-day period for each business unit and production area. Includes number of items scheduled for completion for each day. Sort by inventory item and production due date.	Production Control > Define Production > Reports > Schedule by Area Report	RUN_SFS2007
SFS2008 Subcontracted PO Report	Lists purchase orders and PO numbers for subcontracted production IDs with the statuses of Firmed, Released, In Process, Pending/Complete and Complete. Sort by production start date of the subcontracted production ID, by the purchase order due date, production area, production item, purchase order number, or purchase order due date.	Production Control > Process Production > Subcontract Production > Subcontracted PO Report	RUN_SFS2008
SFS5001 Subcontract Components Report	Lists the production IDs and the components associated with subcontracted operations.	Production Control > Process Production > Subcontract Production > Subcontract Components Report	RUN_SFS5001
SFS6000 Material Picking Plan	Generates picking plan instructions for stockroom processing. Lists all items to be picked by location, component, or production ID and production schedule for a specified production start date range. Picking plan options include the PUSH or PULL method.	Production Control > Process Production > Issue Materials > Create Picking Plan	RUN_SFS6000
SFS8000 Genealogy Exception Report	Generate a report that lists those serial production IDs that have genealogy inconsistencies.	Production Control > Process Production > Production Genealogy > Genealogy Exception Report	RUN_SF_TRC001

PeopleSoft Manufacturing Reports: A to Z

This section contains detailed information pertaining to many reports.

ENS1000 - BOM Report

<i>Field or Control</i>	<i>Description</i>
<p>Print Options</p>	<p>These options denote detailed information you may want to appear on the hardcopy report. You can select All attributes of the BOM or Selected attributes. Attributes include:</p> <ul style="list-style-type: none"> • Substitutes: Substitute items for the BOM components, if any exist. • Lower Level Outputs: Primary, co- and by-product items at lower levels of the BOM. • Component Dimensions: Actual dimensions of the component such as height, length, width, and weight. • Reference Designators: The alphanumeric code you can use to determine where a component is placed in an assembly. • Component Text: Any text associated with the BOM components. • Component Attachments: The names of any associated assembly attachments. • Component Documents: The names of any associated assembly documents. <hr/> <p>Note: The names of Component Documents print only if PeopleSoft Engineering is installed.</p> <hr/> <ul style="list-style-type: none"> • Assembly Text: Any text associated with the assembly. • Assembly Attachments: Names of any attachments (files) such as CAD drawings or product specifications. • Assembly Documents: Names of any associated documents used during assembly such as CAD drawings or product specifications. <hr/> <p>Note: The names of any Assembly Documents will print only if PeopleSoft Engineering is installed.</p> <hr/>

ENS1001 - Routing Report

<i>Field or Control</i>	<i>Description</i>
Print Options	<p>These options denote detailed information you may want to appear on the report. You can choose either All or Selected attributes to print such as:</p> <ul style="list-style-type: none"> • Header Documents: Any text associated with the routing header information. • Header Attachments: Any attachments (files) associated with the routing header information. • Operation Resources: Resources that are being used at the operation step. • Operation Time: The times necessary to complete this operation. This may include tasks and run rates such as fixed run, post production, run, and setup times. • Conversion Code: Cost codes that determine the labor, machine, outside processing, and overhead cost of the operation. • Operation Documents: Lists the names of any documents associated with the operation such as CAD drawings or product specifications. • Operation Attachments: Lists the names of routing operation attachments.

ENS1002 - Compare Routings Report

This report includes baseline routing and target routing.

Baseline Routing (RTG1):

Select a **Routing State:** *Engineering* or *Manufacturing*.

Select an **Item ID** range and a valid **Routing Code**.

Target Routing (RTG2):

The **Routing State** defaults to *Engineering*; it is a display-only field.

Select an **Item ID** and a valid **Routing Code**.

To compare one routing code to another (for example, the primary routing to one of the item's alternates), enter the primary routing code (1) as the From and To routing for the **Baseline Routing (RTG1)**. Then enter as the **Target Routing (RTG2)** the alternate routing code to which you'd like to compare the primary.

To see if any of an item's routings are comparable to another item's routing, enter the Baseline routing codes (1 to 99 to compare the primary and all alternates) and the Target's routing code to which all routings will be compared.

<i>Field or Control</i>	<i>Description</i>
<p>Print Options</p>	<p>These options denote detailed information you may want to appear on the report. You can select All of the listed attributes or Selected attributes. Attributes include:</p> <ul style="list-style-type: none"> • Header Detail: Information such as routing type, routing code, and routing state is printed on the report. • Header Documents: Any documents associated with the routing header information. • Header Attachments: Any attachments (files) associated with the routing header information. • Ops Sequence (operation sequence): The operation step that components or tasks may be added. • Subcontractor Detail: If the operation step is a subcontracted operation, the supplier information will be printed on the report. • Operation Text: Any text associated with the operation step. • Conversion Code: Cost codes that determine the labor, machine, outside processing, and overhead cost of the operation. • Operation Resources: Resources that are being used at the operation step. • Operation Time: The times necessary to complete this operation. This may include tasks and run rates such as fixed run, postproduction, run, and setup times. • Operation Documents: Lists the names of any documents associated with the operation such as CAD drawings or product specifications. <hr/> <p>Note: The Operation Documents print option is available only if you have PeopleSoft Engineering installed.</p> <hr/> <ul style="list-style-type: none"> • Operation Attachments: Lists the names of routing operation attachments.

ENS1003 - Master Routing Where Used Report

<i>Field or Control</i>	<i>Description</i>
<p>Print Production Details</p>	<p>Select this check box if you want to print production information for All dates or a Range of dates. The report will include all production whose start date falls within the criteria selected.</p>

<i>Field or Control</i>	<i>Description</i>
Status Selection	<p>You can include production by selecting any of these statuses:</p> <ul style="list-style-type: none"> • Entered • Firmed • Released • In Process • Pend Complete (pending complete) • Complete • Clsd Labor (closed to labor) • Clsd Acctg (closed to accounting) • Canceled

ENS1004 - Resources Where Used Report

<i>Field or Control</i>	<i>Description</i>
Report Request Parameters	<p>You can select All, None, or a Range for these resources:</p> <ul style="list-style-type: none"> • Crew Name • Machine Code • Tool ID

Select **Print All Usages** or **Print Selected Usages** and one of these check boxes:

<i>Field or Control</i>	<i>Description</i>
Work Centers	Lists all work centers where the selected crew, machine, or tool is specified as a primary or alternate resource.
Tasks	Lists all tasks that use selected crew, machine, or tool resources.
Routings	Lists all routings that use selected crews, machines, or tool specified as a primary or alternate resource. However, differences might occur when changes have been made to the specific item's routing.
Production	Lists all production IDs or production schedules that use selected crew, machine, or tool resources.

ENS1005 - BOM Compare Report

Use the BOM Compare Report to compare any two engineering BOMs or a manufacturing BOM and an engineering BOM within the same business unit. Using this report, you can compare one or more baseline BOMs to one target BOM. In the **Baseline BOM (BOM1)** group box, specify the Item ID BOM that will serve as the basis for comparison. The baseline BOM may have an Engineering or Manufacturing BOM state. The Item ID you specify in the **Target BOM (BOM2)** group box is the BOM you are comparing with the Baseline BOM (BOM1). The Target BOM has an Engineering BOM State.

Field or Control	Description
Differences	<p>This field behaves the same way for all pages in this group. It displays the differences between the two BOMs.</p> <ul style="list-style-type: none"> • <i>Added:</i> The Component ID has been added to the compare BOM (BOM2). • <i>Deleted:</i> The component has been deleted from the compare BOM (BOM2). <p>The system determines whether a component has been deleted, by comparing the component IDs, operation sequences, and effectivity dates: this is what makes a component unique within a BOM.</p> <ul style="list-style-type: none"> • <i>Chg BOM1:</i> If you have made a component change, you will see the components listed. <p>The system lists a change when any information other than Component ID, Op Seq (operation sequence), or Eff Date (effective date) has changed.</p> <ul style="list-style-type: none"> • <i>Chg BOM2:</i> If you have made a component change, you will see the components listed. <p>The system lists a change when any information other than Component ID, Op Seq (operation sequence), or Eff Date (effective date) has changed.</p>

The report includes component and assembly differences between the two BOMs so that you can use it to track changes.

Baseline BOM (BOM1):

Select the **BOM State:** *Engineering* or *Manufacturing*.

Select an **Item ID** and a valid **BOM Code** from the available options.

If you want to use the BOM with a code of *1*, select *1* in both fields. You can also compare all the existing BOMs for the item to the target routing by selecting the appropriate BOM codes.

Select the **All Dates/Revs** check box if you want to compare all effective dates and revisions for the baseline BOM(s). If you want to compare a BOM with a specific effective date, don't select the **All Dates/Revs** check box, and enter the specific **Eff Date** (effective date).

Target BOM (BOM2):

The **BOM State** field defaults to *Engineering*; it is display-only.

Select an **Item ID** and a valid **BOM Code** for the target BOM.

Select the **All Dates/Revs** check box if you want to compare all effective dates and revisions for the BOM. If you want to compare a BOM with a specific effective date, enter the specific **Eff Date** (effective date).

Field or Control	Description
Print Options	<p>These options denote detailed information you may want to appear on the hardcopy report. You can select All attributes of the BOM or Selected attributes. Attributes include:</p> <ul style="list-style-type: none"> • Component Documents: The names of any associated assembly documents. <hr/> <p>Note: The names of Component Documents will print only if PeopleSoft Engineering is installed.</p> <hr/> <ul style="list-style-type: none"> • Component Attachments: The names of any associated assembly attachments. • Component Text: Any text associated with the BOM components. • Reference Designators: The alphanumeric code you can use to determine where a component is placed in an assembly. • Substitutes: Substitute items for the BOM components, if any exist. • Component Dimensions: Actual dimensions of the component such as height, length, width, and weight. • Top Level Outputs: Parent assembly items only. • Assembly Header: Any text associated with the assembly. • Assembly Documents: Names of any associated documents used during assembly such as CAD drawings or product specifications. <hr/> <p>Note: The names of any Assembly Documents will print only if PeopleSoft Engineering is installed.</p> <hr/> <ul style="list-style-type: none"> • Assembly Attachments: Names of any attachments (files) such as CAD drawings or product specifications.

ENS1006 - Work Centers Where Used Report

Select **All** or a **Range** of work centers to be included in the report.

Print Options denote the detailed work center where-used information that you might want to appear on the hard-copy report. You can select any of these print options: **Tasks**, **Routings**, and **Production**.

ENS1007 - Tasks Where Used Report

Print Options denote detailed task where-used information that you might want to print on the hard-copy report. You can select any of these print options:

<i>Field or Control</i>	<i>Description</i>
Routings	Lists all routings that use selected crews, machines, or tools that are specified as a primary or alternate resource. However, differences might occur when changes have been made to the specific item's routing.
Production	Lists all production IDs or production schedules that use selected crew, machine, or tool resources.

ENS1010 - BOM Cost Report

Report request parameters include:

<i>Field or Control</i>	<i>Description</i>
Item ID	Select All or Range to specify which item IDs to include.
Cost Type and Cost Version	The cost version you select must be valid for the cost type. You need to have rolled up costs using the particular combination of cost type and version in order to display the selected BOMs.
BOM Code and Routing Code	All items selected are costed using this BOM code and routing code combination. You can select any BOM code, but the system always calculates lower levels using the primary BOM code (1).
Cost as Batch	Select if the BOM has multiple outputs.
Print Lower Level Outputs	Select this check box if you want the hard-copy report to include the costs of multiple output items for components that are themselves end items.
Eff Date and Depth	Enter these values for the BOM you want to display. <hr/> Note: It's best to select the maximum depth for revision-controlled bills of material. <hr/>
Print Lower Level Outputs	If you want the hardcopy report to include the costs of multiple output items for components that are themselves end items, select this check box.

ENS2000 - Item Where Used Report

<i>Field or Control</i>	<i>Description</i>
Item ID Range	<p>Select the radio buttons to determine which items to search for. Options are:</p> <ul style="list-style-type: none"> • <i>Components</i>: Searches to see if the items are specified as a component on a BOM. • <i>Substitutes</i>: Searches to see if the items are substitute items on a BOM. • <i>Outputs</i>: Searches to see if the items are substitute items on a BOM. • <i>All</i>: Searches to see whether items are components or substitutes. • <i>Range</i>: Searches for a particular range of item IDs.
Levels Up	<p>Set to <i>1</i> to see just the component's parent assembly. The larger the number, the higher the level; for example, Level 3 is three levels higher in the bill of material structure than the component.</p>

SF_MATRDY- Material Readiness Report

Run the material readiness report to determine if the production ID or production schedule is ready to release by viewing the quantities and readiness status of the components. To view complete information about the material readiness report, see the "Releasing Production and Changing Production Statuses" topic.

Related Links

[Running the Material Readiness Report](#)

SFS1100 - Production Close Report

The Close Production page includes:

<i>Field or Control</i>	<i>Description</i>
Report Only Mode	<p>Select this check box if you want to run this process the production that can and can't be closed as well as the variances that could be generated as a result of an accounting close.</p> <hr/> <p>Note: This option enables you to view the production that can and cannot be closed as well as the reasons why production can't be closed. It also provides a preview of variances for those production IDs or production schedules that can be closed.</p>

<i>Field or Control</i>	<i>Description</i>
Select Production IDs	<p>Select this check box to close production IDs based any of these values:</p> <ul style="list-style-type: none"> • Prdn ID (production ID) • Prdn Area (production area) • Item ID
All or a Range	<p>Narrow down the production to close by combining any of these options. For example, you can close only those production IDs within a selected production area for a single item.</p>
Select Production Schedules	<p>Select this check box to close production schedules.</p> <p>Close production schedules based on:</p> <ul style="list-style-type: none"> • Prdn Area (production area) • Item ID

The Close Status Selection page includes:

<i>Field or Control</i>	<i>Description</i>
Current Status	<p>Select one or more of these production statuses:</p> <ul style="list-style-type: none"> • Pend Cmpl (pending complete) • In Process • Complete • Clsd/Labor (closed for labor)
Close Production For	<p>Values are:</p> <ul style="list-style-type: none"> • Complete • Clsd/Labor (closed for labor) • Clsd/Acctg (closed for accounting)

Field or Control	Description
Curr Prdn Due/Close Dates (current production due/close dates)	<p>Enter the appropriate date ranges.</p> <p>If you're closing any In Process or Pending Complete production, the system closes any production IDs or production schedule quantities whose production due date falls within the date range specified.</p> <p>If you are closing any production IDs or production schedule quantities whose current status is Complete or Closed for Labor, the system closes any production whose close date falls within the range specified.</p>
Complete with Component Shortages	Select this check box if you want to close production even if you haven't issued all material for the production ID or production schedule quantity. In this instance, the quantity issued to production is less than the current scheduled quantity for the component.
Close with Assemblies Remain (close with assemblies remaining)	Select this check box if you want to close production even though the full production quantity hasn't been completed.
Tolerance %	You must indicate a tolerance percentage is you selected the Close with Assemblies Remain check box. Use this field to define what percentage of assemblies can remain uncompleted and still close production with remaining assemblies. For example, if you have a production ID with an order quantity of 100 but have completed only 92 units and enter a tolerance percent of 5, this production ID won't close because the quantity remaining to be completed is 8 percent of the order quantity. The default is 0 percent. The system closes any production in process, pending complete, complete, or closed for labor only if the quantity of assemblies completed and scrapped at each operation equals the quantity started at each operation.
Variance Distrib Type (variance distribution type)	Can be used in conjunction with the transaction group for variances to define the accounting entries to post the variance to the general ledger. The default distribution type for the transaction group (if one was defined) displays, but you can override the distribution type for each accounting close. This field is optional and used only when closing production for accounting.

Note: If any of the production IDs are for production with one or more subcontracted operations, the system can't close production if the subcontracted purchase order(s) haven't been fully received. To close those production IDs, the material must be received and the subcontracted operation must be recorded as complete.

Warning! The close production process generates several .DAT files and writes them to the C:\TEMP directory. If you are trying to create a Production Close report or run the production close process, and an error message displays indicating permission is denied, you don't have write access to the C:\TEMP directory. See your system administrator to provide write access before running this process again.

SFS1200 - Production Reopen Process Report

<i>Field or Control</i>	<i>Description</i>
Current Status	Select a current production status for the you'd like to reopen.
Curr Prdn Due/Close Dates (current production due/close dates)	<p>Enter the appropriate dates. The system reopens any production IDs or schedules that are currently closed for accounting, labor, or complete and whose accounting or labor close date or completed date falls within the date range specified. When reopening production in the pending complete status, production will be set to In Process if the production due date falls within the date window specified.</p> <p>This process generates the Reopen Production Request report. The report details the before and after status of the production ID or production schedule once the process is complete. You can view the results of the variance postings and the reversal of the posting by running the Production Variance Report.</p>

SFS1500 - Production Variance Report

<i>Field or Control</i>	<i>Description</i>
Variance Posting Date	The dates production was closed for accounting.
Prdn Due Date/Shift	Enter a beginning and end production due date and shift. The Shift field must be between 1 and 3.
Variance Tolerance Amount	Enter the minimum monetary amount on which you want to display report results. By specifying a minimum monetary amount, you can focus in on those production IDs or production areas with significant variances. Enter 0.00 to report all variances for the production selected.

SFS1600 - Potential Production Variance Report

This report includes production selection and potential variance selection.

Production selection includes:

<i>Field or Control</i>	<i>Description</i>
Report Request Parameters	You can either report on production IDs or production schedules by selecting the appropriate check boxes.

<i>Field or Control</i>	<i>Description</i>
Select Production IDs	Select All or a Range of one of these values: <ul style="list-style-type: none"> • Prdn ID (production ID) • Prdn Area (production area) • Item ID
Select Production Schedules	Select All or a Range of one of these values: <ul style="list-style-type: none"> • Prdn Area (production area) • Item ID

Potential variance selection includes these options:

<i>Field or Control</i>	<i>Description</i>
Current Production Status	Select any of these statuses: <ul style="list-style-type: none"> • Pend/Cmpl (pending complete) • Complete • In Process • Clsd/Labor (closed for labor)
Report Variances Above Amount	Enter the lower limit for variances that you want to print on the report. For example, if you enter 100.00 here, only those production IDs and schedules with a variance over 100.00 will be reported. To see variances on all production, enter 0.00. A favorable or unfavorable variance above the specified amount will be reported.

Note: Once the selection criteria has been made and saved, you should schedule the job to run periodically using Process Scheduler. Once the process has completed, an email notification will be sent to the designated role. The email notification will include an attached report, detailing those production IDs and schedules in violation of the specified variance amount.

Note: If you choose not to run this process periodically, you can still submit this process manually.

SFS2001 - Shortage Report

You have the option of creating a shortage report that displays one or both:

- **Pending Shortages** exist when the pending consumed quantity and/or the pending yield loss quantity is greater than 0. This condition indicates that the component wasn't found in the WIP location or

stores location if kitting, or insufficient quantity on hand was found and the full quantity couldn't be issued.

- **Production Shortages** exist if any of these occurs:

- **Type 1 Shortage:** A quantity of the component is required for the production but hasn't yet been issued from stock. This type of shortage is only reported if the order or operation start date falls within a user-defined date range. They are shown for Kit or Issue production.

If component issue method = Kit or (component issue method = Issue and quantity Per = Order), then the shortage quantity = current scheduled quantity - issue quantity - minimum (yield quantity, current schedule quantity * (1 - Yield % / 100)).

If component issue method = Issue and quantity per = assembly, then the shortage quantity = (order production quantity - operation completion quantity - operation & previous operation scrap quantity) * Qty Per * 100/Yield %.

- **Type 2 Shortage:** you have tried to consume or issue more components from the WIP or stores location than were available. The system always reports Type 2 Shortages.

Shortage quantity = Pending Consumed Qty + Pending Loss Qty.

Note: If both a Type 1 and a Type 2 shortage exist for the same component/operation and the issue method is Kit or the quantity per is Order, the quantity short shown on the report is the greater of the two. If both a Type 1 and a Type 2 shortage exist for the same component/operation and the issue method is *Issue* and the quantity per is assembly, the quantity short shown on the report is the sum of the two.

- **Type 3 Shortage:** the quantity in the WIP location is negative. This could be the result of Issue or Replenish production.

Shortage quantity = WIP Location Qty On Hand (absolute value).

Note: Type 3 shortages aren't currently shown on the Shortage Report.

SFS2002 - Dispatch List

The Dispatch List details production ID or production schedule information, including operation and task details for each work center or range of work centers. Use this document when you want to see the type and quantity of production that occurs at all work centers or at a particular work center for a particular date or range of dates. In addition, you can generate a dispatch list by production start date and due date, or generate a report that lists production that is past due. You can create your own reports that include this types of information:

- Component information for each work center/operation or a range of work centers.
- Operation start and due dates and times.
- Production operations that are past due.
- Subcontracted operation information.
- Comments at the production and operation level.

- Item substitution information.

Dispatch List Selection:

Field or Control	Description
Print Bar Code	If you select this check box, the system prints bar codes for bar coded fields on the dispatch list.
Print Bar Coded Control Flags	<p>Select to attach an item's control flags to the bar code printed on each line of the dispatch list. These control flags enable the electronic data collection system to prompt for the lot ID, serial ID, staged date, or shipping serial ID immediately after the user scans the bar-coded line number field. For cases that do not require control flags, you might prefer not to select this check box.</p> <p>The format for the bar code printed for each detail line is LSDAH:99999, where:</p> <ul style="list-style-type: none"> • L = Lot ID Control Flag • S = Serial ID Control Flag • D = Staged Date Control Flag • A = Actual Cost Control Flag • H = Shipping Serial ID Control Flag • : = Constant • 99999 = Line Number <hr/> <p>Note: PeopleSoft delivers printer settings for all SQR output to a generic line printer. However, when printing bar coded information on reports on a PCL printer (HP Laser Jet), you must first define the printer type accordingly. You may do this by changing the printer type settings delivered in SETENV. SQC from LINEPRINTER to HPLASERJET.</p>
Work Center Range	<p>Select All if you want to generate a Dispatch List for all work centers.</p> <p>If you're specifying a Range of work centers, select a particular work center in From WC (work center) and To WC (work center).</p>

Field or Control	Description
Dispatch List Date Options	<p>Select one of these values:</p> <ul style="list-style-type: none"> • <i>Start Date</i>: Indicates the start date of the production. All production IDs and schedules whose start date falls within the date range specified will be included in the report. • <i>Due Date</i>: Indicates the date in which the production is due. All production IDs and production schedules whose due date falls within the date range specified will be included in the report. • <i>Past Due Report</i>: Indicates production that is past due as of the date of the report is run.
From Date and To Date	Enter the date ranges for the dispatch list.
Dispatch List Report Options	<p>Indicates the detailed production information that can be printed on the report. You can select any of these report options:</p> <ul style="list-style-type: none"> • Print Components • Print Op Time Info (operation time information) • Print Subcontracted Ops (subcontracted operations) • Print Comments • Print Original Components - will display where substitutions have been made. <p>However, bar codes will not be printed for the original component ID.</p>

Production Selection:

Field or Control	Description
Select Production IDs and Select Production Schedules	Select one or both check boxes to generate a production report for production IDs, production schedules, or a combination of both.
All, Range, Prdn ID (production ID), Prdn Area (production area), or Item IDs	Select values for production IDs.
All, Range, Prdn Area (production areas), or Item IDs	Select values for production schedules.

SFS2003 - Production Documents

Note: Production documents are applicable for production IDs only.

The PID print status options include:

Field or Control	Description
Ready to Print	Print production documents for production IDs with a production document status of <i>Ready for Printing</i> . The Prdn Doc Status displays on the Production ID Maintenance page.
Ready to Print + Reprints	Print production documents for production IDs within the range, with a document status of <i>Ready for Printing</i> and <i>Printed</i> .
Reprints Only	Print production documents for every production ID within the range with a production document status of <i>Printed</i> .
Selection Criteria	Select one or more of these options: <ul style="list-style-type: none"> • Start Date (actual start date for production ID) • Prdn ID (production ID) • Prdn Area (production area) • Item ID
	Click the Item Search button to access the Item Search page to locate a different item.

The report options include:

Field or Control	Description
Sort Option	You can generate the report by: <ul style="list-style-type: none"> • <i>Item</i> • <i>Prdn Area</i> (production area) • <i>Prdn ID</i> (production ID)
Print Attachments or Print Text	Select if you want to print a list of attachments or text for the production ID.
Print Original Components	Select this check box to print the original component ID and description where substitutions have been made. Bar codes, however, won't be printed for the original component ID.

<i>Field or Control</i>	<i>Description</i>
Print Config Detail (print configuration code details)	If you are using PeopleSoft Product Configurator, you can select this check box to include information on configured production.
Print Bar Code	Select this check box to print bar codes for bar coded fields. Note: PeopleSoft SCM applications do not support the printing of bar codes from processes running on OS390 servers. You should run your SQRs that print barcodes on a process scheduler server that is running on a non-OS390 operation system.
Print Bar Coded Control Flags	Select to attach an item's control flags to the bar code printed on each line of the production document. These control flags enable the electronic data collection system to prompt for the lot ID, serial ID, staged date, or shipping serial ID immediately after the user scans the bar-coded line number field. For cases that do not require control flags, you might prefer not to select this check box. The format for the bar code printed for each detail line is LSDAH:99999, where: <ul style="list-style-type: none"> • L = Lot ID Control Flag • S = Serial ID Control Flag • D = Staged Date Control Flag • A = Actual Cost Control Flag • H = Shipping Serial ID Control Flag • : = Constant • 99999 = Line Number Note: PeopleSoft delivers printer settings for all SQR output to a generic line printer. However, when printing bar coded information on reports on a PCL printer (HP Laser Jet), you must first define the printer type accordingly. You may do this by changing the printer type settings delivered in SETENV. SQC from LINEPRINTER to HPLASERJET.

SFS2004 - Production Report

The Production Report Selection page includes:

<i>Field or Control</i>	<i>Description</i>
Start Date Range	Indicate whether you want to print a production report for All or a Range of dates.

Field or Control	Description
Sort Options	<p>Select one of these values:</p> <ul style="list-style-type: none"> • <i>Due Date</i> • <i>Item</i> • <i>Prdn Area</i> (production area) • <i>Prdn Due Date</i> (production due date) • <i>Prdn Start Date</i> (production start date) • <i>Start Date</i>
Print Text	Select this check box if you want to include production text for the specified production IDs and production schedules.
Print Output	Select this check box if you want to include production output information for the specified production IDs or production schedules that have multiple outputs.
Select Production Status	<p>You must select at least one status to run the Production Report, and the system selects all statuses as a default. Statuses are:</p> <ul style="list-style-type: none"> • <i>Entered</i> • <i>Firmed</i> • <i>Released</i> • <i>In Process</i> • <i>Pend Complete</i> (pending complete) • <i>Complete</i> • <i>Cancelled</i> • <i>Clsd/Labor</i> (closed for labor) • <i>Clsd/Acctg</i> (closed to accounting)

The Production Selection page includes:

Field or Control	Description
Select Production IDs and Select Production Schedules	Select one or both check boxes to generate a production report for production IDs, production schedules, or a combination of both.
All, Range, Prdn ID (production ID), Prdn Area (production area), or Item IDs	Select values for production IDs.

<i>Field or Control</i>	<i>Description</i>
All, Range, Prdn Area (production areas), or Item IDs	Select values for production schedules.

SFS2006 - Component Where Used in Production Report

The Component Selection page includes:

<i>Field or Control</i>	<i>Description</i>
All or Range	Select values for the component.
Date Type	Select one of the options: <ul style="list-style-type: none"> • <i>Prdn Start</i> (production start). Select production based on start dates. • <i>Prdn Due</i> (production due). Select production based on due dates.
All dates or Range of dates	Select an option and enter dates in the fields.
Sort Option	Select an option: <ul style="list-style-type: none"> • <i>Item</i> • <i>Prdn Area</i> (production area) • <i>Prdn ID</i> (production ID)
Substitutes	Select this check box if you want component substitutes to be printed on the report.
Status Selection	Indicates the production status of the component. Select All Status or Select Range Status . Select one or more of these production statuses: <ul style="list-style-type: none"> • <i>Firmed</i> • <i>Released</i> • <i>In Process</i> • <i>Pend Complete</i> (pending complete) • <i>Complete</i> • <i>Clsd Labor</i> (closed for labor) • <i>Clsd Acctg</i> (closed for accounting)

The Production Selection page includes:

Field or Control	Description
Select Production IDs and Select Production Schedules	Select one or both check boxes to generate a production report for production IDs, production schedules, or a combination of both.
All, Range, Prdn ID (production IDs), Prdn Area (production area), or Item IDs	Select values for production IDs.
All, Range, Prdn Area (production areas), or Item IDs	Select values for production schedules.

SFS2007 - Production Schedule by Area Report

The Production Schedule by Area Report page includes:

Field or Control	Description
Unit and Production Area	Select values.
From	Enter the Start Date Range in this field for the production area that you'd like to review.

SFS2008 - Subcontracted Purchase Order Report

The Subcontracted Purchase Order Report page includes:

Field or Control	Description
All or Range	<p>Select either option for one of these values:</p> <ul style="list-style-type: none"> • Op Start Dt (operation start dates) • Prdn ID (production IDs) • Prdn Area (production areas) • Item ID <p>Enter values for the ranges. If you select a range of operation start dates, all purchase orders with production IDs whose subcontracted operations start within the date range specified will be included.</p>

Field or Control	Description
Sort Option	Values are: <ul style="list-style-type: none"> • <i>Item ID</i> • <i>Op St Date</i> (operation start date) • <i>Prdn Area</i> (production area) • <i>Prdn ID</i> (production ID)
Print Text	Select this check box if you want to print the associated text with the Sort Option.
Production Status	Select any of these values: <ul style="list-style-type: none"> • <i>Firmed</i> • <i>Released</i> • <i>In Process</i> • <i>Pend Complete</i> (pending complete) • <i>Complete</i>

SFS5001 - Subcontract Components Report

This report displays the production IDs and the components associated with subcontracted operations.

The Subcontract Components Report page includes:

Selection Criteria

Field or Control	Description
Unit	Select a specific PeopleSoft Manufacturing business unit. This is a required field.

Select any of these optional fields. If you leave the fields blank, the system retrieves all applicable information:

<i>Field or Control</i>	<i>Description</i>
All or Range	<p>Select either option for one of these fields:</p> <ul style="list-style-type: none"> • Op Start Dt (operation start dates) • Prdn ID (production IDs) • Operation Sequence: Select the specific subcontracted operation for the component or leave the field blank to retrieve all subcontracted operation sequences associated with the production ID. • Prdn Area (production area) • Item ID • Supplier ID: Select the specific subcontracted supplier or leave the field blank to return all appropriate production IDs and associated subcontracted operations based on other selection criteria.

Issue Method Selection

Select the issue method for the subcontracted components. Values are:

- **Kit**
- **Issue**
- **Replenishment**

SFS6000 - Material Picking Plan

The Material Picking Plan page includes:

<i>Field or Control</i>	<i>Description</i>
Production Area Information	<p>The production selection options available on this page depend on the material issue method you chose on the picking options page.</p> <p>For example, if you select the Kit method on the picking options page, the WIP Location Range for Issues group box items won't be available.</p>
Prdn Areas (production areas)	<p>You can select one of these options when generating picking plans for components using the Issue or Kit method:</p> <p>All: If you select this option and the issue method you selected is Issue, you can additionally enter a range of WIP locations.</p> <p>Range: If you select this option, the system looks at all WIP locations for the production selected.</p>

Field or Control	Description
Options for Kits	<p>You can select one of these options when generating picking plans for components using the Kit method:</p> <ul style="list-style-type: none"> • All • Range • Prdn ID: You can also indicate either All or a Range. • Item ID : You can also indicate either All or a Range.
WIP Location Range for Issues	<p>Select All or Range if all production areas use the Issue method. Within the range of storage area, you can further define the selection by any of the 4 location levels set up in the inventory. If you selected a range of production areas, you can't select a range of WIP locations.</p> <hr/> <p>Note: If you're selecting consigned kit issue components, including lot- and serial-controlled components, the system picks from <i>both</i> owned and non-owned WIP storage locations.</p>
Run	<p>Click to run this request. Process Scheduler runs the Pick Plan process and report (SFS6000) at user-defined intervals.</p>

Note: PeopleSoft SCM applications do not support the printing of bar codes from processes running on OS390 servers. You should run your SQRs that print barcodes on a process scheduler server that is running on a non-OS390 operation system.

SFS8000 - Genealogy Exception Report

The Genealogy Exception Report page includes:

Report Request Parameters

Field or Control	Description
Prdn ID (production ID), Prdn Area (production area), Item ID	Select All or enter a Range of values.
Prdn Status	<p>Select one or more of these production statuses:</p> <ul style="list-style-type: none"> • In Process • Pend Cmpl (pending complete) • Complete • Clsd/Labor (closed for labor) • Clsd/Acctg (closed for accounting)

Field or Control	Description
Display Prdn if Serial ID is not Associated with Assembly Scrap	Select this check box if you want this information printed on the report.
Sort Option	Select one of these sort options: <ul style="list-style-type: none"> • <i>Item ID</i> • <i>Prdn Area</i> (production area) • <i>Prdn ID</i> (production ID)

These are exception messages that you may encounter when you generate a Genealogy Exception Report.

Field or Control	Description
<i>Assembly Exceptions Serial IDs not associated with Assembly Scrap</i>	There is assembly scrap that does not have a serial ID associated with it. If you want to associate serial IDs to the scrap, you will need to reverse the scrap and then rescrap.
<i>Serial IDs associated > Completed + Scrap</i>	There are serial IDs associated with the production ID that have not been completed or scrapped. You should verify that the serial IDs are still in production
<i>Component serial/lot association rows do not exist</i>	There are completed serial assemblies that do not have any serial or lot components associated. You may need to enter the component association transactions.
<i>Component Exceptions Component Issue <> Trace Usage</i>	You have consumed more serial IDs than have been associated with an assembly. You should verify the correct component associations have been recorded.
<i>Component serial/lot association rows do not exist</i>	You have consumed quantity but no component association rows have been recorded. You should verify the correct component associations have been recorded.
<i>Comp List qty per <> Sum of Trace Issue Qty</i>	You have associated more or less quantity than what is scheduled. You should verify the correct component associations have been recorded.

Viewing Standard Financial Reports

See “Application Fundamentals Reports: General Description” (Application Fundamentals).

