PeopleSoft FSCM 9.2: PeopleSoft Purchasing

July 2024

PeopleSoft FSCM 9.2: PeopleSoft Purchasing
Copyright © 1988, 2024, Oracle and/or its affiliates.

This software and related documentation are provided under a license agreement containing restrictions on use and disclosure and are protected by intellectual property laws. Except as expressly permitted in your license agreement or allowed by law, you may not use, copy, reproduce, translate, broadcast, modify, license, transmit, distribute, exhibit, perform, publish, or display any part, in any form, or by any means. Reverse engineering, disassembly, or decompilation of this software, unless required by law for interoperability, is prohibited.

The information contained herein is subject to change without notice and is not warranted to be error-free. If you find any errors, please report them to us in writing.

If this is software, software documentation, data (as defined in the Federal Acquisition Regulation), or related documentation that is delivered to the U.S. Government or anyone licensing it on behalf of the U.S. Government, then the following notice is applicable:

U.S. GOVERNMENT END USERS: Oracle programs (including any operating system, integrated software, any programs embedded, installed, or activated on delivered hardware, and modifications of such programs) and Oracle computer documentation or other Oracle data delivered to or accessed by U.S. Government end users are "commercial computer software," "commercial computer software documentation," or "limited rights data" pursuant to the applicable Federal Acquisition Regulation and agency-specific supplemental regulations. As such, the use, reproduction, duplication, release, display, disclosure, modification, preparation of derivative works, and/or adaptation of i) Oracle programs (including any operating system, integrated software, any programs embedded, installed, or activated on delivered hardware, and modifications of such programs), ii) Oracle computer documentation and/or iii) other Oracle data, is subject to the rights and limitations specified in the license contained in the applicable contract. The terms governing the U.S. Government's use of Oracle cloud services are defined by the applicable contract for such services. No other rights are granted to the U.S. Government.

This software or hardware is developed for general use in a variety of information management applications. It is not developed or intended for use in any inherently dangerous applications, including applications that may create a risk of personal injury. If you use this software or hardware in dangerous applications, then you shall be responsible to take all appropriate fail-safe, backup, redundancy, and other measures to ensure its safe use. Oracle Corporation and its affiliates disclaim any liability for any damages caused by use of this software or hardware in dangerous applications.

Oracle®, Java, MySQL, and NetSuite are registered trademarks of Oracle and/or its affiliates. Other names may be trademarks of their respective owners.

Intel and Intel Inside are trademarks or registered trademarks of Intel Corporation. All SPARC trademarks are used under license and are trademarks or registered trademarks of SPARC International, Inc. AMD, Epyc, and the AMD logo are trademarks or registered trademarks of Advanced Micro Devices. UNIX is a registered trademark of The Open Group.

This software or hardware and documentation may provide access to or information about content, products, and services from third parties. Oracle Corporation and its affiliates are not responsible for and expressly disclaim all warranties of any kind with respect to third-party content, products, and services unless otherwise set forth in an applicable agreement between you and Oracle. Oracle Corporation and its affiliates will not be responsible for any loss, costs, or damages incurred due to your access to or use of third-party content, products, or services, except as set forth in an applicable agreement between you and Oracle.

Documentation Accessibility

For information about Oracle's commitment to accessibility, visit the Oracle Accessibility Program website at <https://docs.oracle.com/pls/topic/lookup?ctx=acc&id=docacc>.

Access to Oracle Support

Oracle customers that have purchased support have access to electronic support through My Oracle Support. For information, visit <https://docs.oracle.com/pls/topic/lookup?ctx=acc&id=info> or visit <https://docs.oracle.com/pls/topic/lookup?ctx=acc&id=trs> if you are hearing impaired.

Contents

- Preface: Preface.....xxxi**
- Understanding the PeopleSoft Online Help and PeopleBooks..... xxxi
- Hosted PeopleSoft Online Help..... xxxi
- Locally Installed PeopleSoft Online Help..... xxxi
- Downloadable PeopleBook PDF Files..... xxxi
- Common Help Documentation..... xxxi
- Field and Control Definitions..... xxxii
- Typographical Conventions..... xxxii
- ISO Country and Currency Codes..... xxxiii
- Region and Industry Identifiers..... xxxiii
- Translations and Embedded Help..... xxxiv
- Using and Managing the PeopleSoft Online Help..... xxxiv
- PeopleSoft FSCM Related Links..... xxxiv
- Contact Us..... xxxiv
- Follow Us..... xxxv
- Chapter 1: Getting Started With PeopleSoft Purchasing.....37**
- PeopleSoft Purchasing Business Processes..... 37
- Common Elements Used in Purchasing..... 37
- PeopleSoft Purchasing Integrations..... 39
- PeopleSoft Purchasing Implementation..... 43
- Related Product Documentation..... 46
- Chapter 2: Using User-Definable Fields.....47**
- Understanding User-Definable Fields.....47
- Setting Up User-Definable Fields.....52
- Chapter 3: Defining PeopleSoft Purchasing Business Units and Processing Options.....53**
- Understanding Business Units in PeopleSoft Purchasing..... 53
- Establishing PeopleSoft Purchasing Business Units..... 54
- Pages Used to Establish PeopleSoft Purchasing Business Units..... 55
- Purchasing Definition - Business Unit Definition Page..... 56
- RFQ Required Rule Page..... 60
- Standard Comments Page..... 61
- Matching Options Page..... 61
- Define Dispatch Options Page..... 62
- Copy VAT Defaults From (copy value added tax defaults from) Page..... 65
- Copy VAT Defaults From (copy value added tax defaults from) Page..... 67
- Purchasing Definition - Business Unit Options Page..... 67
- Purchasing Definition - Document Numbering Page..... 82
- Establishing Change Options and Approval Rules..... 83
- Pages Used to Establish Change Options and Approval Rules..... 83
- PO Change Options (purchase order change options) Page..... 83
- Req Change Options (requisition change options) Page..... 90
- Establishing Purchasing Processing Options..... 93
- Pages Used to Establish Purchasing Processing Options..... 94
- Purchasing Options Page..... 94
- Dispatch Method Page..... 101
- Freight Option Page..... 103

POA Settings (purchase order acknowledgements settings) Page.....	103
Service VAT Treatment Defaults Setup (service value-added tax treatment defaults setup) Page.....	105
Procurement Change Reason Codes Page.....	106
Preparing PeopleSoft Purchasing VAT Environments.....	107
Chapter 4: Understanding Search Framework in PeopleSoft Purchasing.....	111
Understanding Search in PeopleSoft Purchasing.....	111
Real Time Indexing Switch.....	114
Chapter 5: Defining Purchasing Item Information.....	115
Understanding Purchasing Item Information.....	115
Common Elements Used in Purchasing Item Information.....	115
Setting Up Item Catalogs.....	117
Working with Market Codes.....	119
Defining Purchasing Item Categories.....	121
Pages Used to Define Purchasing Item Categories.....	121
Understanding Item Categories.....	122
Item Categories - Category Definition Page.....	123
Update Catalog Tree Page.....	125
Item Categories - Category Definition 2 Page.....	126
Supplier Sourcing Priorities Page.....	128
Defining Purchasing Item Attributes.....	128
Pages Used to Define Purchasing Item Attributes.....	129
Understanding Order Multiple Rounding Rules.....	131
Purchasing Attributes Page.....	132
Item Specifications Page.....	137
Purchasing Attributes - Purchasing Controls Page.....	138
Purchasing Business Unit Attributes Page.....	143
Purchasing Attributes -Item Supplier (ITM_VENDOR)Page.....	144
Item Supplier Location Substitute Items Page.....	150
Supplier's UOM and Pricing Information (Supplier's unit of measure and pricing information) Page.....	152
Effective Dated UOM (effective-dated unit of measure) Page.....	156
Update Purchase Order Page.....	157
Updating Item Supplier Unit-of-Measure Conversion Rates.....	160
Page Used to Update Item Supplier Unit-of-Measure Conversion Rates.....	160
Update Item Supplier UOM (update item Supplier unit of measure) Page.....	160
Capturing Item Miscellaneous Charges.....	161
Pages Used to Capture Item Miscellaneous Charges.....	161
Miscellaneous Charges Selection Page.....	161
Setting Up Item Supplier Price Adjustment Rules.....	163
Pages Used to Set Up Item Supplier Price Adjustment Rules.....	164
Understanding Item Supplier Price Adjustments.....	164
Price Adjustment Page.....	164
Price Adjustment Details Page.....	166
Updating Standard Prices and Business Unit Standard Prices.....	167
Pages Used to Update Standard Prices and Business Unit Standard Prices.....	167
Understanding Price Updates.....	168
Understanding the Price Update Process.....	169
Using Standard Price and Business Unit Standard Price Updating Online.....	169
Using Standard Price and Business Unit Price Batch Updating.....	170
Update PO Price Page.....	171

Selecting Suppliers Based on Item Ship To and Item Supplier Locations.....	172
Pages Used to Select Suppliers Based on Item Ship To and Item Supplier Locations.....	173
Item Ship To Locations Page.....	173
Creating Purchasing Kits.....	175
Page Used to Create Purchasing Kits.....	175
Understanding Purchasing Kits.....	175
Working With Substitute Items in Procurement.....	176
Understanding Item Substitution in Procurement.....	176
Setting Up Substitute Items in Procurement.....	182
Chapter 6: Defining Miscellaneous Charges and Landed Costs.....	187
Understanding Miscellaneous Charges.....	187
Defining Miscellaneous Charge Defaults.....	188
Chapter 7: Using Workflow.....	191
Understanding PeopleSoft Purchasing Workflow.....	191
Setting Up the Approval Framework for PeopleSoft Purchasing.....	191
Pages Used to Set Up Approval Framework in PeopleSoft Purchasing.....	192
Understanding the Approval Framework Setup Steps.....	194
Setting Up the Approval Framework for PeopleSoft Purchasing.....	195
Setting Up Email Approvals for PeopleSoft Purchasing.....	201
Using the Data Migration Workbench for PeopleSoft Change Templates.....	203
Setting Up PeopleTools Workflow Technology for PeopleSoft Purchasing.....	203
Understanding PeopleTools Workflow Technology Setup for PeopleSoft Purchasing.....	204
Setting Up Approvals in PeopleTools Workflow Technology.....	205
Setting Up EDX Exception Workflow.....	208
Setting Up Notification in PeopleTools Workflow Technology.....	209
Issuing Requisition Sourcing Workflow Notifications.....	210
Page Used To Issue Requisition Sourcing Workflow Notifications.....	210
Issuing Purchase Order Cancellation Workflow Notifications.....	211
Page Used to Issue Purchase Order Cancellation Workflow Notifications.....	211
Issuing Contract Expiration and Exceeding Maximum Workflow Notifications.....	211
Page Used to Issue Contract Expiration and Exceed Maximum Workflow Notifications.....	211
Using Purchase Order Acknowledgement Alert Workflow Notifications.....	211
Pages Used to Use Purchase Order Acknowledgement Alert Workflow Notifications.....	212
Using Item Loader Exception Workflow Notifications.....	213
Pages Used to Use Item Loader Exception Workflow Notifications.....	215
Exception Summary Page.....	215
Using Rebate Manager Workflow Notification.....	216
Pages Use to Use Rebate Manager Workflow Notifications.....	216
Prerequisites.....	216
Using Receipt Quantity Change Workflow Notifications.....	217
Pages Use to Use Receipt Quantity Change Workflow Notifications.....	217
Prerequisites.....	217
Using Settlement Manager Workflow Notifications.....	218
Pages Use to Use Settlement Manager Workflow Notifications.....	218
Prerequisites.....	219
Chapter 8: Using Default Hierarchies.....	221
Understanding the PeopleSoft Purchasing Default Hierarchy.....	221
Purchasing Transaction Default Hierarchy.....	221
Requisition Default Hierarchy.....	225
Purchase Order Default Hierarchy.....	226
Purchasing Item Default Hierarchy.....	227

Purchasing ChartField Default Hierarchy.....	231
Understanding the UOM Conversion Hierarchy.....	232
UOM Defaulting.....	233
UOM Conversion Rate Defaults.....	234
Understanding the Matching Default Hierarchy.....	235
Understanding the Supplier Location Hierarchy and Multicurrency Pricing.....	237
High-Level Controls Implementation: Item Ship To Supplier Location and Item Region	
Supplier Location Overview.....	239
Item Ship To Supplier Location Setup.....	239
Item Region Supplier Location Setup.....	240
Mid-Level Control Implementation: Ship To Supplier Location and Region Supplier	
Location Supplier Order Location Overview.....	241
Ship To Supplier Location Supplier Order Location Setup.....	241
Region Supplier Location Supplier Order Location Setup.....	242
Low-Level Control Implementation: Defining Item-Supplier Relationships Overview.....	243
Zero-Level Control Implementation Overview.....	243
Understanding Multicurrency Conversions.....	244
Understanding VAT Drivers, VAT Driver Keys, and the Defaulting Hierarchy for VAT Defaults....	246
Chapter 9: Using Commitment Control.....	249
Understanding Commitment Control in PeopleSoft Purchasing.....	249
Delivered Source Transaction Types for Purchasing.....	250
Commitment Control Budget Processor Process in PeopleSoft Purchasing.....	252
Open Period.....	253
Liquidation Method.....	253
Document Tolerances.....	254
Budget Pre-Check.....	254
Budget Exceptions.....	255
Budget Overrides.....	256
Effects of Changes to Budget-Checked Transactions.....	256
Commitment Control and PeopleSoft Purchasing Close Processes.....	258
Budget Checking Receipt Accruals.....	259
Common Elements Used in Commitment Control and PeopleSoft Purchasing Close Processes.....	259
Using Partial and Final Liquidation.....	262
Reversing Partial or Final Liquidation.....	264
Budget Checking After Partial or Final Liquidation.....	264
Running Entry Events After Partial or Final Liquidation.....	265
Budget Checking Requisitions.....	265
Pages Used to Budget Check Requisitions.....	265
Req Budget Check (requisition budget check) Page.....	265
Budget Checking Requisitions Using Online Pages.....	266
Budget Checking Purchase Orders.....	267
Pages Used to Budget Check Purchase Orders.....	267
Budget Check Request Page.....	267
Budget Checking Purchase Orders Using Online Pages.....	268
Budget Checking Procurement Cards.....	269
Pages Used to Budget Check Procurement Cards.....	269
Load Statement Page.....	270
Reconcile Statement - Procurement Card Transactions Page.....	271
Running Budget Period-End Processes.....	271
Pages Used to Run Budget Period-End Processes.....	271
Understanding Budget Period-End Processing.....	272

Rolling Over Purchase Orders at Budget Period-End.....	273
Pages Used to Rollover Purchase Orders.....	273
Understanding the Purchase Order Rollover Process.....	273
PO Rollover View Page.....	274
PO Rollover (purchase order rollover) Page.....	279
Purchase Order Details Page.....	282
PO Rollover1 Page.....	283
PO Rollover2 Page.....	284
Roll Open Encum (roll open encumbrance) Page.....	285
Run Roll Exception Page.....	285
Establishing Purchasing ChartField Security.....	286
Chapter 10: Running Document Tolerances.....	289
Understanding Document Tolerances.....	289
Setting Up Document Tolerances.....	289
Running Document Tolerances With Budget Checking.....	289
Page Used to Run Document Tolerances With Budget Checking.....	290
Maintain Purchase Order - Purchase Order Page.....	290
Running Document Tolerances Without Budget Checking.....	291
Page Used to Run Document Tolerances Without Budget Checking.....	291
Reviewing Document Tolerance Exceptions and Overrides.....	291
Pages Used to Review Document Tolerance Exceptions and Overrides.....	291
Document Tolerance Exceptions - Doc Tol Exception Page.....	292
Document Tolerance Override - Override Log Page.....	293
Chapter 11: Using Entry Events.....	295
Understanding Entry Events in PeopleSoft Purchasing.....	295
Setting Up PeopleSoft Purchasing Entry Events.....	298
Pages Used to Set Up PeopleSoft Purchasing Entry Events.....	298
Entry Event Page.....	298
Entry Event Defaults Page.....	299
Generating PeopleSoft Purchasing Entry Events.....	299
Page Used to Generate PeopleSoft Purchasing Entry Events.....	300
Entry Event Run Request Page.....	300
Entry Event Log Inquiry Page.....	301
Drilling Down to the General Ledger to View Entry Event Journal Entries.....	302
Pages Used to Drill Down to the General Ledger to View Entry Event Journal Entries.....	302
Chapter 12: Creating Procurement Group Data.....	303
Understanding Procurement Groups in PeopleSoft.....	303
Example of Procurement Group Transactions.....	305
Setting Up Procurement Groups.....	308
Page Used to Set Up Procurement Groups.....	308
Procurement Groups Page.....	308
Chapter 13: Managing Procurement Cards.....	311
Understanding the Procurement Card Business Process.....	311
Common Elements Used in Procurement Card.....	312
Setting Up Procurement Card Installation Options.....	316
Page Used to Set Up Procurement Card Installation Options.....	316
Establishing Procurement Card Security.....	316
Pages Used to Establish Procurement Card Security.....	316
Understanding Procurement Card Security.....	317
User Profiles - Roles Page.....	318
Register Procurement Card Roles Page.....	318

Procurement Card Access Rights Page.....	318
Assign Proxies Page.....	321
SpeedChart Page.....	323
Define Accounting Tag.....	323
Assign SpeedCharts Page.....	323
Assign Accounting Tags page.....	324
Defining Cardholder Profile.....	325
Pages Used to Define Cardholder Profile.....	326
Understanding the Personal Employee EIP.....	327
Personal Data Page.....	327
Card Data Page.....	328
Suppliers Page.....	330
Assign Proxies Page.....	331
Default Accounting Distribution Page.....	332
Restricted Purchase Page.....	334
Defining Card Issuers.....	335
Pages Used to Define Card Issuers.....	335
Card Issuer Page.....	335
Defining Preferred Suppliers.....	341
Pages Used to Define Preferred Suppliers.....	341
List of Merchants Page.....	342
Preferred Suppliers Page.....	342
Defining Preferred UOM.....	343
Pages Used to Define Preferred UOM.....	343
List of Merchant UOM (list of merchant unit of measure) Page.....	343
Preferred UOM Page.....	344
Defining MCC Blocked.....	344
Pages Used to Define MCC Blocked.....	344
Defining Visa Transaction Type Codes.....	344
Page Used to Define Visa Transaction Type Code.....	345
Defining Procurement Card Mapping.....	345
Pages Used to Define Procurement Card Mapping.....	345
Setting Up Procurement Card Load Statement Options.....	345
Page Used to Define Procurement Card Load Statement Options.....	346
Load Statement Options Page.....	346
Staging Procurement Card Statements Using PeopleSoft Integration Broker.....	349
Staging Procurement Card Statements in a Flat File Format.....	350
Using the Credit Card Data EIP.....	350
Understanding the Credit Card Data EIP.....	350
Setting Up the Credit Card Data EIP.....	350
Using the Procurement Card Load EIP.....	351
Pages Used to Use the Procurement Card Load EIP.....	351
Understanding the Procurement Card Load EIP.....	352
Using the Procurement Card Load EIP.....	352
Staging Standard Delivered Bank Format Statements.....	352
Page Used to Stage Standard Delivered Bank Format Statements.....	353
ProCard Stage Page.....	353
Handling Statement Staging Errors.....	355
Page Used to Handle Statement Staging Errors.....	355
Correct Errors Page.....	355
Loading Procurement Card Statements to Application Tables.....	356

Page Used to Load Procurement Card Statements to Application Tables.....	356
Understanding the ProCard Load Statement Process.....	356
Load Statement Page.....	359
Running the Bank Statement Workflow Application Engine Process (PO_CCSTMT_WF).....	360
Page Used to Run the Bank Statement Workflow Application Engine Process.....	360
Reconciling Procurement Card Transactions Manually.....	360
Pages Used to Reconcile Procurement Card Transactions Manually.....	361
Reconcile Statement -Search Page.....	363
Reconcile Statement - Procurement Card Transactions Page.....	366
Reconcile Statement - Account Distribution Page.....	371
Reconcile Statement - Purchase Details Page.....	373
Sales/Use Tax Page.....	375
Reconcile Statement - Split Transaction Page.....	376
Reconcile Statement - Distribution Template Page.....	377
Credit Card Transaction Line VAT Page.....	378
Running the Grace Period Has Expired Application Engine Process (PO_CCEXP_WF).....	386
Page Used to Run the Grace Period Has Expired Application Engine Process.....	386
Resolving Disputed Transactions.....	386
Pages Used to Resolve Disputed Transactions.....	387
Review Disputes Search Page.....	387
Viewing the Statement Summary.....	388
Page Used to View the Statement Summary.....	388
Statement Summary Page.....	388
Staging Procurement Card Transactions for Voucher Processing.....	389
Page Used to Stage Procurement Card Transactions for Voucher Processing.....	389
Voucher Stage Page.....	389
Analyzing Procurement Card Information.....	391
Pages Used to Analyze Procurement Card Information.....	391
Managing Procurement Card Expiration.....	392
Pages Used to Manage ProCard Expiration.....	392
Manage ProCard Expiration Page.....	393
Chapter 14: Understanding Vendor Rebates.....	395
Understanding Vendor Rebates.....	395
Chapter 15: Defining Vendor Rebate Agreements.....	399
Understanding Vendor Rebate Agreement Statuses.....	399
Understanding Vendor Rebate Rule Types.....	401
Prerequisites.....	405
Defining Vendor Rebate Agreements.....	406
Pages Used to Define Vendor Rebate Agreements.....	406
Rebate Agreement - Rebate Agreement Page.....	408
Rebate Agreement - Rebate Options Page.....	413
Rebate Agreement - Rebate Agreement Value Added Tax Page.....	417
Rebate Agreement - Rebate Rules Page.....	425
Dispatching Vendor Rebate Agreements.....	431
Page Used to Dispatch Vendor Rebate Agreements.....	431
Understanding Vendor Rebate Agreement Dispatch.....	431
Vendor Rebate Agreement Dispatch Page.....	431
Chapter 16: Generating Rebate Accruals.....	435
Understanding the Rebate Accrual Process.....	435
Generating Rebate Accruals.....	448
Page Used to Generate Rebate Accruals.....	448

Rebate Accrual Page.....	448
Chapter 17: Maintaining Vendor Rebate Agreement Association with Purchase Orders.....	449
Understanding the Backdate Vendor Rebates Component Processes.....	449
Associating to, Dissociating from, and Modifying Associated Vendor Rebate Agreements Line by Line to Purchase Orders Manually.....	450
Pages Used to Manually Associate to, Dissociate from, and Modify Associated Vendor Rebate Agreements Line by Line to Purchase Orders Manually.....	450
Backdate Vendor Rebates Page.....	450
Chapter 18: Managing Vendor Rebate Claims.....	455
Understanding the Claims Management Business Process for Vendor Rebates.....	455
Prerequisites.....	461
Generating Vendor Rebate Claims.....	461
Page Used to Generate Vendor Rebate Claims.....	462
Generate Claims Page.....	462
Printing a Vendor Rebate Claim.....	462
Page Used to Print a Vendor Rebate Claim.....	462
Notifying Rebate Managers of Claims.....	463
Page Used to Notify Rebate Managers of Claims.....	463
Notify Rebate Manager Page.....	463
Using the Claims Management Workbench.....	464
Pages Used to Use the Claims Management Workbench.....	464
Understanding the Claims Management Workbench.....	464
Claims Management Workbench - Rebate Claims Page.....	465
Reconciling Payments for Vendor Rebates.....	472
Page Used to Reconcile Payments for Vendor Rebates.....	472
Incoming Payment Reconcile Page.....	472
Maintaining Claims.....	473
Pages Used to Maintain Claims.....	473
Understanding Change Processing for Claim Amounts.....	474
Claim - Details Page.....	475
Claim - Distributions Page.....	479
Reconciling Claims.....	480
Pages Used to Reconcile Claims.....	480
Understanding Exception Processing.....	480
Claim Reconciliation - Claim Details Page.....	481
Claim Reconciliation - Incoming Payments Page.....	484
Notifying Settlement Managers.....	484
Page Used to Notify Settlement Managers.....	485
Notify Settle Mgr (Notify Settlement Manager) Page.....	485
Viewing Claim Settlement Information.....	485
Page Used to View Claim Settlement Information.....	485
Claim Settlement Page.....	486
Entering Claim Payments Manually.....	486
Page Used to Enter Claim Payments Manually.....	486
Understanding the Manual Entry of Claim Payments.....	487
Claim Incoming Payment Page.....	487
Chapter 19: Analyzing Vendor Rebates.....	489
Understanding the Vendor Rebate Analysis Workbench.....	489
Defining Sales Organizations.....	490
Page Used to Define Sales Organizations.....	491
Sales Organization Setup Page.....	491

Establishing Vendor Rebate Allocations.....	491
Page Used to Establish Vendor Rebate Allocations.....	492
Prerequisites.....	492
Vendor Rebate Allocation Page.....	492
Analyzing Vendor Rebates.....	494
Pages Used to Analyze Vendor Rebates.....	495
Vendor Rebate Analysis Workbench - Workbench Filter Options Page.....	496
Vendor Rebate Analysis Workbench Page.....	497
Vendor Rebate Analysis Workbench - Accrued Rebate Details Page.....	501
Vendor Rebate Analysis Workbench - Rebate Threshold Analysis Page.....	504
Vendor Rebate Analysis Workbench - PO Not Received Analysis Page.....	507
Vendor Rebate Analysis Workbench - Flat File Extraction on Rebate Transactions Page.....	508
Chapter 20: Approving Supplier User Registration Using the PeopleSoft Fluid User Interface.....	513
Approving Supplier User Registration Using the PeopleSoft Fluid User Interface.....	513
Pages Used to Approve Supplier User Registrations in the PeopleSoft Fluid User Interface.....	513
Understanding Supplier User Registration Approval Using the Fluid User Interface.....	513
Understanding Fluid Approval Set Up.....	515
Pending Approvals - User Registration Page.....	516
User Registration - Approval Header Detail Page.....	517
Associated Roles Page.....	518
Associated Permission Lists Page.....	519
Chapter 21: Understanding Requisitions.....	521
Configuring Requisition Defaults.....	521
Canceling Requisitions and Requisition Lines.....	521
Sourcing Requisitions Automatically.....	522
Deleting Requisitions.....	523
Placing a Requisition On Hold.....	524
Using Procurement Cards on Requisitions.....	525
Using PeopleSoft Maintenance Management Work Orders on Requisitions.....	526
Chapter 22: Creating Requisitions Online.....	529
Understanding the Requisition Business Process.....	529
Understanding How to Apply Procurement Contract Prices to Transactions.....	530
Applying Contracts to Requisitions.....	531
Contract Pricing for Requisitions and Purchase Orders.....	532
Creating Requisition Header Information.....	538
Pages Used to Create Requisition Header Information.....	538
Maintain Requisitions - Requisition Page.....	541
Requisition Defaults Page.....	552
Supplier Search Page.....	557
Address Page.....	558
Req One Time Address Default (requisition one time address default) Page.....	558
Retrofit field changes to all existing requisition lines/schedule/distributions Page.....	559
Header Comments Page.....	560
Standard Comments Page.....	562
Currency Information Page.....	563
Enter Kit Items Page.....	565
Order By Catalog Page.....	565
Item Details Page.....	566
Item Supplier Priority Page.....	566
Set Item Alias Page.....	567
Requester Favorite Items Page.....	568

Creating Requisition Lines.....	568
Pages Used to Create Requisition Lines.....	568
Maintain Requisitions - Requisition Page.....	570
Item Search Criteria Page.....	587
Defaults for Line Page.....	588
Retrofit field changes to all the distributions on the requisition line Page.....	589
Maintain Requisition - Details for Line Page.....	590
Item Description Page.....	597
View Category Hierarchy Page.....	597
Buyer Telephone Information Page.....	598
Line Comments Page.....	598
Include Item Specifications Page.....	598
Category Search Page.....	599
Creating Requisition Schedules.....	600
Pages Used to Create Requisition Schedules.....	600
Maintain Requisitions - Schedule Page.....	601
VAT Information for a Schedule Page.....	606
Additional Details Page.....	614
Requisition Ship To Address Page.....	615
Using Pegging with Requisitions in PeopleSoft Purchasing.....	616
Pages Used to Peg Requisitions.....	616
Understanding Using Pegging With Requisitions in PeopleSoft Purchasing.....	616
Prerequisites.....	617
Pegging Workbench Page.....	617
Pegging Inquiry Page.....	619
Entering Distribution Information.....	620
Pages Used to Enter Distribution Information.....	620
Maintain Requisitions - Distribution Page.....	621
VAT Details for Distribution Page.....	630
Copying an Existing Requisition to a New Requisition.....	632
Pages Used to Copy an Existing Requisition to a New Requisition.....	632
Copy Requisition Page.....	632
Printing Requisition Templates.....	633
Page Used to Print Requisition Templates.....	633
Understanding the Requisition Template SQR Report (PORQ011).....	633
Previewing and Printing Requisitions.....	633
Pages Used to Preview and Print Requisitions.....	633
Maintain Requisitions - Requisition Page.....	634
Requisition Print Page.....	634
Updating Supplier History Dates and Amounts for Cumulative Sourcing.....	635
Page Used to Update Supplier History Dates and Amounts for Cumulative Sourcing.....	635
Understanding the Cumulative Sourcing Update Application Engine Process.....	635
Cumulative Sourcing Page.....	636
Working with Large Requisitions.....	637
Page Used to Work with Large Requisitions.....	638
Chapter 23: Using the Requisition Loader.....	641
Understanding the Purchasing Requisition Loader Application Engine Process (PO_REQLOAD).....	641
Defining Purchasing Requisition Loader System Sources.....	642
Loading Requisitions.....	645
Page Used to Load Requisitions.....	645

Requisition Loader Page.....	645
Using the Purchase Order Requisition EIP.....	649
Pages Used to Use the Purchase Order Requisition EIP.....	649
Understanding the Purchase Order Requisition EIP.....	650
Using the Purchase Order Requisition EIP.....	650
Correcting Purchasing Requisition Loader Process Errors.....	650
Pages Used to Correct Purchasing Requisition Loader Process Errors.....	651
Understanding the Purchasing Requisition Loader Error Processing.....	652
Requisition Loader Request Page.....	652
Comments Page.....	654
Override Address Page.....	655
Updating Direct Shipment Information.....	655
Page Used to Update Direct Shipment Information.....	656
Understanding the Direct Shipments Update Application Engine Process (PO_REQDROP)....	656
Update Direct Ship Page.....	657
Purging Requisition Load Requests.....	657
Page Used to Purge Requisition Load Requests.....	657
Understanding the Purge Requisition Load Request Application Engine Process (PO_RLRQPRG).....	658
Purge Reqload Requests (purge requisition load requests) Page.....	658
Chapter 24: Approving Requisitions.....	661
Understanding Requisition Approvals.....	661
Approving Requisitions With the Approval Framework.....	661
Pages Used to Approve Requisitions With Approval Framework.....	667
Manage Requisition Approvals Page.....	668
Requisition Approval Page.....	670
Requisition Line Details Page.....	675
Approving Requisitions With PeopleTools Workflow Technology.....	676
Pages Used to Approve Requisitions With PeopleTools Workflow Technology.....	676
Understanding Requisition Approvals With PeopleTools Workflow Technology.....	677
Requisition Amount Approval Page.....	680
Requisition ChartField Approval Page.....	682
Chapter 25: Tracking Requisition Changes.....	685
Understanding Requisition Change Tracking.....	685
Pages Used to Track Requisition Changes.....	685
Maintain Requisitions - Requisitions Page.....	685
Reviewing Requisition Change History.....	686
Pages Used to Review Requisition Change History.....	686
Chapter 26: Using the Requester's Workbench.....	687
Understanding the Requester's Workbench.....	687
Prerequisites.....	687
Using the Requester's Workbench.....	687
Pages Used to Use the Requester's Workbench.....	688
Requester's Workbench - Filter Options Page.....	688
Requester's Workbench Page.....	691
Requester's Workbench - Requisition Lines Page.....	696
Requester's Workbench - Requisition Schedules Page.....	697
Requester's Workbench - Processing Results Page.....	697
Chapter 27: Closing Requisitions.....	701
Understanding the Close Requisitions Process.....	701
Describing Requisition Close Criteria.....	702

Describing Close Requisition Changes to Requisition Statuses.....	704
Closing Requisitions.....	706
Page Used to Close Requisitions.....	706
Close Page.....	706
Reopening Requisitions.....	707
Page Used to Reopen Requisitions.....	707
Understanding the Requisition Reopen Process.....	707
Reopen Requisitions Page.....	709
Chapter 28: Reviewing Requisition Information.....	713
Using Requisition Inquiries.....	713
Pages Used to Use Requisition Inquiries.....	713
Requisitions Inquiry Search Page.....	715
Requisitions Inquiry Page.....	716
Requisition Details Page.....	718
Schedule Details Page.....	722
Distribution Information Page.....	723
Requisition to Purchase Order List Page.....	723
Requisition Receipts List Page.....	724
Requisition to MSR List (requisition to material stock request list) Page.....	724
Using the Requisition Workbench.....	725
Pages Used to Use the Requisition Workbench.....	725
Requisition Workbench selection criteria Page.....	727
Workbench Page.....	731
Reviewing Requisition Accounting Line Entries.....	733
Pages Used to Review Requisition Accounting Line Entries.....	733
Selection Criteria (for requisition accounting line entries) Page.....	733
Requisition Accounting Entries Page.....	734
Reviewing Requisition Entry Event Journal Entries.....	736
Page Used to View Requisition Entry Event Journal Entries.....	736
Chapter 29: Managing Requests for Quotes.....	737
Understanding RFQs in PeopleSoft Purchasing.....	737
Establishing Supplier Quote Groups.....	738
Pages Used to Establish Supplier Quote Groups.....	739
Creating RFQs.....	739
Pages Used to Create RFQs.....	739
Request Quotes Page.....	741
RFQ Header Details Page.....	744
Enter Copy Criteria Page.....	745
Item Supply Supplier List Page.....	748
RFQ Dispatch Supplier List Page.....	748
Dispatch Options Page.....	750
RFQ Dispatch History Page.....	751
Email Message Page.....	751
Dispatching RFQs.....	752
Page Used to Dispatch RFQs.....	752
Understanding the RFQ Dispatch and Print Process.....	753
Dispatch Quote Forms Page.....	754
Loading RFQ EDX Responses.....	755
Page Used to Load RFQ EDX Responses.....	755
Understanding the Load RFQ EDX Responses Process.....	755
Using the RFQ EIP.....	755

Pages Used to Use the RFQ EIP.....	755
Understanding the RFQ EIP.....	756
Setting Up the RFQ EIP.....	756
RFQ Message Selection Criteria Page.....	756
Using the RFQ Response EIP.....	757
Pages Used to Use the RFQ Response EIP.....	757
Understanding the RFQ Response EIP.....	758
Using the RFQ Response EIP.....	758
Resolving Supplier Response Load Errors.....	759
Pages Used to Resolve Supplier Response Load Errors.....	759
Response Errors Page.....	759
Maintaining RFQ Responses.....	760
Pages Used to Maintain RFQ Responses.....	761
Maintain Responses Page.....	762
Response Header Details Page.....	764
Awarding RFQs to Suppliers.....	764
Pages Used to Analyze and Award RFQs to Suppliers.....	765
Analyze Quote Page.....	765
Creating Purchase Orders or Contracts from RFQs.....	766
Pages Used to Create Purchase Orders or Contracts from RFQs.....	766
Create PO/Contract (create purchase order/contract) Page.....	767
RFQ PO Distribution (request for quote purchase order distribution) Page.....	770
Closing RFQs.....	771
Page Used to Close RFQs.....	771
Request Quotes Page.....	771
Inquiring and Reporting on RFQs and Supplier Responses.....	771
Pages Used to Inquire and Report on RFQs and Supplier Responses.....	772
Response Information Page.....	773
Chapter 30: Understanding Purchase Orders.....	775
Purchase Order Defaults.....	775
Purchase Order Header Status Values.....	776
SUT Processing on the Purchase Order.....	777
VAT Processing on the Purchase Order.....	778
Vendor Rebate Processing on the Purchase Order.....	779
Procurement Card Processing on the Purchase Order.....	782
PeopleSoft Maintenance Management Work Order Processing on the Purchase Order.....	782
Purchase Order Consolidation.....	784
Purchase Order Cancellation.....	785
Purchase Order Deletion.....	790
Purchase Order Hold Processing.....	791
Chapter 31: Creating Purchase Orders Online.....	795
Understanding the Purchase Order Business Process.....	795
Understanding Global Location Numbers and Global Trading Item Numbers.....	800
Global Location Numbers (GLN).....	800
Global Trading Item Numbers (GTIN).....	801
Common Elements Used in Global Location Numbers and Global Trading Item Numbers.....	802
Using Purchase Order Reservations.....	807
Page Used to Reserve Purchase Orders.....	807
Understanding How the System Assigns Purchase Order IDs When Reserving Purchase Orders.....	807
Purchase Order Reservations Page.....	810

Setting Up Procurement Groups for Asset Consolidation.....	811
Procurement Groups Page.....	812
Purchasing Options Page.....	813
Procurement Group Inquiry Page.....	815
Creating Purchase Order Headers.....	817
Pages Used to Create Purchase Order Headers.....	817
Maintain Purchase Order - Purchase Order Page.....	821
Federal Award Data page.....	840
Supplier Details Page.....	841
PO Header Details Page.....	842
PO Header Comments Page.....	847
Purchase Order Defaults Page.....	850
Retrofit field changes to all existing PO lines/schedule/distributions Page.....	857
Maintain Purchase Order - Procurement Card Information Page.....	858
PO Header - VAT Information Page.....	858
Dispatch Options Page.....	859
PO Dispatched History Page.....	861
PO Matching Page.....	862
Change Reason Page.....	863
Creating Purchase Order Lines.....	863
Pages Used to Create Purchase Order Lines.....	864
Maintain Purchase Order - Purchase Order Page.....	865
Details for Line Page.....	880
Contract Search Page.....	894
Contract Adjustment Page.....	897
Contract Price Information Page.....	898
Header Misc. Charges (header miscellaneous charges) Page.....	898
Header - Miscellaneous Charges Page.....	900
Creating Purchase Order Schedules.....	900
Pages Used to Create Purchase Order Schedules.....	900
Maintain Purchase Order - Schedules Page.....	902
PO ShipTo Address Page.....	914
Sales/Use Tax Information for Schedule Page.....	915
VAT Information for a Schedule Page.....	917
Details for Schedule Page.....	926
Price Adjustments for Schedule Page.....	931
Miscellaneous Charges for Schedule Page.....	934
Schedule - 3rd Party Supplier Page.....	935
Creating Purchase Order Distributions.....	936
Pages Used to Create Purchase Order Distributions.....	936
Maintain Purchase Order - Distributions for Schedule Page.....	937
PO Distribution Worksheet Page.....	947
Sales/Use Tax Details for Distribution Page.....	948
VAT Details for Distribution Page.....	949
Maintain Distributions Page.....	951
Canceling a Purchase Order Online.....	952
Pages Used to Cancel a Purchase Order Online.....	952
Maintain Purchase Order - Purchase Order Page.....	953
Maintain Purchase Order - Cancel Purchase Order Page.....	955
Maintain Purchase Order - Cancel Purchase Order Page.....	956
Maintain Purchase Order - Cancel Purchase Order Page.....	957

Using Express Purchase Orders.....	959
Pages Used to Enter Express Purchase Orders.....	959
Express Purchase Order - Purchase Order Page.....	959
Using Purchase Order Acknowledgements.....	961
Pages Used to Use Purchase Order Acknowledgements.....	961
Understanding the POA Business Process.....	962
Understanding the Electronic Date Exchange POA Business Process.....	963
Manage PO Acknowledgements Page.....	964
Manage PO Acknowledgements - Header Page.....	965
Acknowledgement Header Details Page.....	967
Acknowledgement Line Details Page.....	968
Manage PO Acknowledgements - Schedule Page.....	968
Acknowledgement Schedule Details Page.....	969
Reviewing Purchase Order Acknowledgements Using the PeopleSoft Fluid User Interface.....	969
Pages Used to Review POAs in the PeopleSoft Fluid User Interface.....	969
PO Acknowledgements Page.....	969
Purchase Order Acknowledgements – Details Page.....	970
POA History page.....	975
Creating and Viewing Purchase Order Backorders.....	975
Pages Used to Create and View Purchase Order Backorders.....	977
Create Backorder Page.....	977
Updating Purchase Orders With New Item Supplier UOM Conversion Rates.....	979
Page Used to Update Purchase Orders With New Item Supplier UOM Conversion Rates.....	979
Accessing Purchase Order Related Content.....	979
Pages Used to Access Purchase Order Related Information.....	979
Understanding Related Content.....	980
Spend by Supplier Page.....	982
Recent PO's Page.....	983
Overdue PO's Page.....	983
Vendor Returns Page.....	984
Working with Large Purchase Orders.....	985
Maintain Purchase Order — Advanced Line Search Page.....	986
Chapter 32: Using Purchase Order Sourcing.....	991
Understanding the Purchase Order Sourcing Business Process.....	991
Primary Sourcing Staging Tables.....	993
Stage Statuses.....	994
Qualifying Criteria for Requisition Selection.....	996
Common Elements Used in Purchase Order Sourcing.....	997
Manually Selecting Requisitions for Sourcing.....	999
Pages Used to Manually Select Requisitions for Sourcing.....	999
Understanding the Manual Requisition Selection Process.....	1000
Requisition Selection - Sourcing Page.....	1001
Requisition Selection - Procurement Card Information Page.....	1011
Override Selected Requisition Supplier Page.....	1012
Requisition Selection - Staging Information Page.....	1013
PO Item Staging Page.....	1016
PO Header Staging Page.....	1016
Automatically Selecting Requisitions for Sourcing.....	1017
Page Used to Automatically Select Requisitions for Sourcing.....	1018
Understanding the AutoSelect Requisitions Process.....	1018
Auto Requisition Selection Page.....	1019

Sourcing by Region.....	1021
Pages Used to Source by Region.....	1021
Understanding Regional Sourcing.....	1021
Region Codes Page.....	1022
Ship To Locations Page.....	1022
Item Supplier by Region Page.....	1022
Reviewing Regional Level Sourcing Methods.....	1024
Loading Staged Purchase Order Requests from PeopleSoft Supply Planning and Manufacturing..	1024
Page Used to Load Staged Purchase Order Requests from PeopleSoft Supply Planning and Manufacturing.....	1024
Understanding the PO Stage Load Process.....	1024
Reviewing, Approving, and Applying Planning Messages.....	1025
PO Stage Load Page.....	1025
Building Inventory Demand Transactions.....	1026
Page Used to Build Inventory Demand Transactions.....	1027
Understanding the Build Inventory Demand Process.....	1027
Running the PO Calculations Process.....	1031
Page Used to Run the PO Calculations Process.....	1031
Understanding the PO Calculations Process.....	1031
Understanding Sourcing Methods.....	1037
Understanding How Contracts are Assigned on Purchase Orders.....	1042
PO Calculations Page.....	1042
Using the Sourcing Workbench.....	1046
Pages Used to Use the Sourcing Workbench.....	1046
Understanding the Sourcing Workbench.....	1047
Common Elements Used in the Sourcing Workbench.....	1049
Sourcing Workbench - Sourcing Page.....	1051
Sourcing Workbench - Sourcing Details Page.....	1054
Eligible Suppliers Page.....	1059
Sourcing Workbench - Pricing Information Page.....	1060
Sales/Use Tax Page.....	1062
Sourcing Workbench - Value Adjustments Page.....	1063
VAT (value added tax) Page.....	1065
Flexible Sourcing Page.....	1067
Sourcing Workbench - PO Information (purchase order information) Page.....	1069
Creating Purchase Orders Using the Create Purchase Orders Process.....	1072
Page Used to Create Purchase Orders Using the Create Purchase Orders Process.....	1072
Understanding the Create Purchase Orders Process.....	1072
Create Purchase Orders Page.....	1073
Using the Automatic Purchasing Sourcing Process.....	1073
Pages Used to Run the Automatic Purchasing Sourcing Process.....	1074
Understanding the Automatic Purchasing Sourcing Process.....	1074
PO Auto Sourcing - Objectives Page.....	1075
PO Auto Sourcing - Options Page.....	1077
Processes Page.....	1077
Purging Purchasing Staging Tables.....	1079
Page Used to Purge Purchasing Staging Tables.....	1079
Understanding the Purge Stage Tables Process.....	1079
Purge Stage Tables Page.....	1080
Manually Constructing the Purchasing Staging Tables.....	1081
Sourcing Error Messages.....	1093

Chapter 33: Approving Purchase Orders..... 1101

- Understanding Purchase Order Approvals..... 1101
- Approving Purchase Orders With Approval Framework..... 1102
 - Pages Used to Approve Purchase Orders With Approval Framework..... 1102
 - Understanding Approval Task on Purchase Order..... 1102
 - Approve Purchase Orders page..... 1103
 - Purchase Order Approval Page..... 1109
- Approving Purchase Orders With Mobile Approval Framework..... 1114
 - Mobile Approval Framework for Purchasing..... 1114
 - Mobile Approval Options..... 1114
- Approving Purchase Orders With PeopleTools Workflow Technology..... 1115
 - Pages Used to Approve Purchase Orders With PeopleTools Workflow Technology..... 1116
 - Understanding Approving Purchase Orders With PeopleTools Workflow Technology..... 1116
 - Purchase Order Amount Approval Page..... 1120
 - Purchase Order ChartField Approval Page..... 1122
- Approving Purchase Order Using PeopleSoft Fluid User Interface..... 1124
 - Pages Used to Approve Purchase Order in the PeopleSoft Fluid User Interface..... 1124
 - Pending Approvals - Purchase Order Page..... 1125
 - Purchase Order - Approval Header Detail Page..... 1126
 - Approval Line Detail Page..... 1129
 - PO Distribution Information Page..... 1130
 - Approvals History - Purchase Order (List) page..... 1131
 - Approvals History - Purchase Order Page..... 1132

Chapter 34: Dispatching and Printing Purchase Orders..... 1133

- Understanding Purchase Order Dispatch..... 1133
- Dispatching Purchase Orders..... 1137
 - Pages Used to Dispatch Purchase Orders..... 1137
 - Dispatch POs Page..... 1138
 - Select Purchase Order Page..... 1144
- Using the Purchase Order Dispatch/Purchase Order Change Request EIP..... 1144
 - Pages Used to Use the Purchase Order Dispatch/Purchase Order Change Request EIP..... 1145
 - Understanding the Purchase Order Dispatch/Purchase Order Change Request EIP..... 1145
 - Setting Up the Purchase Order Dispatch/Purchase Order Change Request EIP..... 1145
 - PO Dispatch Message Selection Criteria Page..... 1146

Chapter 35: Creating Purchase Order Change Orders..... 1147

- Understanding the Purchase Order Change Order Business Process..... 1147
 - Common Elements Used in Purchase Order Change Order Business Process..... 1152
 - Defining Change Order and Sequence Numbers..... 1153
- Setting Up Purchase Order Change Templates..... 1155
- Identifying Purchase Order Change Order Fields..... 1155
- Reviewing Processing Rules for the Change Purchase Order Process..... 1164
- Generating Purchase Order Change Orders Online..... 1167
- Loading Change Orders Received Using EDXs or Supplier-Facing Online Acknowledgements (PeopleSoft eSupplier Connection)..... 1168
 - Page Used to Load Change Orders Received Using EDXs or Supplier-Facing Online Acknowledgements (PeopleSoft eSupplier Connection)..... 1168
 - Change Load Page..... 1168
- Using the Purchase Order and Purchase Order Change Order Acknowledgement EIP..... 1169
 - Pages Used to Use the Purchase Order and Purchase Order Change Order Acknowledgement EIP..... 1169

Understanding the Purchase Order and Purchase Order Change Order Acknowledgement EIP.....	1170
Using the Purchase Order and Purchase Order Change Order Acknowledgement EIP.....	1170
Using the Purchase Order Close Short Workbench.....	1171
Pages Used with the Purchase Order Close Short Workbench.....	1171
Understanding the Close Short Job.....	1171
Create PO Close Short Default Rules Page.....	1172
Using the PO Close Short Workbench.....	1178
PO Close Short Workbench - Purchase Orders Page.....	1179
Process Request Options Page.....	1185
Reviewing and Approving Change Order Requests.....	1186
Pages Used to Review and Approve Change Order Requests.....	1186
Understanding the Change Request Tables.....	1186
Approve Change Requests - Selection Criteria Page.....	1187
Approve Change Requests Page.....	1188
Change Requests Page.....	1191
Creating Change Orders from Approved Change Requests.....	1195
Page Used to Create Change Orders from Approved Change Requests.....	1195
Change Purchase Orders Page.....	1195
Purging Change Request Tables.....	1196
Page Used to Purge Change Request Tables.....	1197
Understanding the Purge Change Request Process.....	1197
Purge Change Requests Page.....	1197
Viewing Purchase Order Change History.....	1197
Pages Used to View Change Order History.....	1198
Performing Mass Buyer Changes.....	1199
Pages Use to Perform Mass Buyer Changes.....	1199
Entering Buyer Search Criteria.....	1199
Replacing a Buyer on Multiple Purchase Orders.....	1200
Chapter 36: Using the Buyer Workcenter and Dashboard.....	1203
Understanding the Buyer WorkCenter and Dashboard.....	1203
Buyer WorkCenter Home Page.....	1204
Understanding Dashboards and Pagelets.....	1205
Setting Up the Buyer WorkCenter Dashboard.....	1205
Using the BuyerWorkCenter - My Work.....	1205
Edit Filters Page.....	1209
Purchase Orders on Hold Page.....	1210
Using the Buyer WorkCenter - Links.....	1211
Sample Buyer WorkCenter - Add/Update POs Link.....	1211
Using the Buyer WorkCenter - Queries, Reports, and Processes.....	1213
Sample Buyer WorkCenter - Past Due Receipts Query.....	1213
Chapter 37: Using the Buyer's Workbench.....	1217
Understanding the Buyer's Workbench.....	1217
Managing Purchase Orders Using the Buyer's Workbench.....	1217
Pages Used to Manage Purchase Orders Using the Buyer's Workbench.....	1218
Buyer's Workbench - Filter Options Page.....	1218
Buyer's Workbench Page.....	1222
Buyer's Workbench - Purchase Order Lines Page.....	1227
Buyer's Workbench - Purchase Order Schedules Page.....	1229
Buyer's Workbench - Processing Results Page.....	1230
Using the Fluid User Interface for Buyer.....	1231

Pages used to view Buyer pages using the Fluid User Interface..... 1231

Buyer Tile..... 1232

Buyer page..... 1232

Chapter 38: Closing Purchase Orders..... 1235

 Understanding the Close Purchase Orders Process..... 1235

 Purchase Order Close Criteria..... 1236

 Describing Close Purchase Order Changes to Purchase Order Statuses..... 1241

 Purchase Order Closure and the Fully Received Status..... 1243

 Purchase Order Closure and the Complete Status..... 1243

 Closing Purchase Orders..... 1244

 Page Used to Close Purchase Orders..... 1244

 Close Purchase Orders Page..... 1244

 Reopening Purchase Orders..... 1246

 Page Used to Reopen Purchase Orders..... 1246

 Understanding the Purchase Order Reopen Process..... 1246

 Reopen POs Page..... 1248

Chapter 39: Reviewing Purchase Order Information..... 1253

 Inquiring About Purchase Orders..... 1253

 Pages Used to Inquire About Purchase Orders..... 1253

 Purchase Order Inquiry Page..... 1255

 Purchase Order Inquiry - Distributions for Schedule Page..... 1256

 Viewing Purchase Order Activity Summaries..... 1259

 Pages Used to View Purchase Order Activity Summaries..... 1259

 Activity Summary Page..... 1259

 Viewing Purchase Order Document Tolerance Information..... 1260

 Pages Used to View Purchase Order Document Tolerance Information..... 1260

 Reviewing Purchase Order Accounting Line Entries..... 1260

 Pages Used to Review Purchase Order Accounting Line Entries..... 1261

 Selection Criteria (for purchase order accounting line entries) Page..... 1261

 Po Acctg Ln Lookup (purchase order accounting line lookup) Page..... 1262

 Inquiring about Procurement Groups..... 1264

 Page Used to Inquire About Procurement Groups..... 1264

 Procurement Group Inquiry Page..... 1264

Chapter 40: Using Stockless Items..... 1267

 Understanding Stockless Items in PeopleSoft Purchasing..... 1267

Chapter 41: Receiving Shipments..... 1269

 Understanding the Receiving Business Process..... 1269

 Defining Receipt Statuses..... 1271

 Using Quantity Tolerances..... 1271

 Using Shipment Date Edits..... 1272

 Using Partial Receipt Edits..... 1272

 Using Directed Putaway..... 1272

 Prerequisites..... 1273

 Common Elements Used in Receiving Shipments..... 1273

 Receiving Purchase Order Items..... 1275

 Receiving Non-Purchase Order Items..... 1275

 Receiving Items by Amount..... 1276

 Managing Receipts..... 1276

 Pages Used to Manage Receipts..... 1277

 Select Purchase Order Page..... 1279

 Maintain Receipts - Receiving Page..... 1283

Maintain Receipts - Header Details Page.....	1299
Maintain Receipts - Receipt Line Details for Line Page.....	1302
Asset Management Information for Line Page.....	1311
Inventory Putaway Information for Line Page.....	1322
Inventory Item Information Page.....	1328
Storage Location Search Page.....	1328
Maintain Receipts - Receipt Distributions for Line Page.....	1329
Maintain Receipts - Manufacturing Information for Line Page.....	1333
Maintain Receipts - PRO Numbers Page.....	1335
PO Comments Page.....	1336
RTV Information Page.....	1336
Accrue Receipt Page.....	1337
Purge ASN History.....	1338
Modifying Receipt ChartFields.....	1339
Page Used to Modify Receipt ChartFields.....	1340
ChartFields Page.....	1340
Tracking Receipt Activity.....	1340
Pages Used to Track Receipt Activity.....	1341
Using ASRs.....	1341
Pages Used to Use ASRs.....	1341
Common Elements Used in ASR Information.....	1342
ASR Review Page.....	1343
Header Details Page.....	1345
Shipment Header Page.....	1345
Address Page.....	1346
Lot/Serial Page.....	1347
Receiving Items Using EDC.....	1347
Pages Used to Receive Items Using Electronic Data Collection.....	1348
Understanding Entering Receipts Using EDC.....	1348
Common Elements Used in Entering Receipts Using EDC.....	1348
Purchasing Receiving - Receiving Page.....	1349
Updating ASRs Using EDC.....	1349
Receiving an Entire Purchase Order Using EDC.....	1350
Receiving a Purchase Order Line Using EDC.....	1350
Receiving a Purchase Order Schedule Using EDC.....	1350
Ending an EDC Receiving Transaction.....	1350
Using the ASR EIP.....	1350
Pages Used to Use the ASR EIP.....	1350
Understanding the ASR EIP.....	1351
Using the ASR EIP.....	1351
Using the Purchase Order Receipt EIP.....	1352
Pages Used to Use the Purchase Order Receipt EIP.....	1352
Understanding the Purchase Order Receipt EIP.....	1352
Using the Purchase Order Receipt EIP.....	1352
Using the Purchase Order Expected Receipts EIP.....	1353
Pages Used to Use the Purchase Order Expected Receipts EIP.....	1353
Understanding the Purchase Order Expected Receipts EIP.....	1353
Setting Up the Purchase Order Expected Receipt EIP.....	1354
PO Expected Receipts Selection Criteria Page.....	1355
Using the Purchase Order Receipt Notification EIP.....	1355
Page Used to Use the Purchase Order Receipt Notification EIP.....	1355

Understanding the Purchase Order Receipt Notification EIP.....	1355
Setting Up the Purchase Order Receipt Notification EIP.....	1356
Processing the Purchase Order Receipt Notification EIP.....	1356
Loading Receipts Received Using EIPs and EDC.....	1356
Pages Used to Load Receipts Received by EIPs and EDC.....	1357
Understanding the Receive Load Process.....	1357
Receiver Load Page.....	1358
Loading EDC Transactions Using the Receive Load Process.....	1359
Loading ASR Transactions Using the Receive Load Process.....	1359
Processing Receipts.....	1359
Page Used to Process Receipts.....	1360
Understanding the Receipt Processes.....	1360
Using the Receiver Interface Push Application Engine Process (PO_RECVPUSH).....	1360
Using the Receipt to Inventory & AM Multiprocess Job (RECV_03).....	1361
Using the Receipt + INV + MFG + AM Multiprocess Job (RECV_07).....	1363
Using Additional Receipt Processes.....	1364
Process Receipts Page.....	1364
Running the Close Short Process.....	1365
Page Used to Run the Close Short Process.....	1365
Close Short Page.....	1365
Working with Landed Costs on Receipts.....	1366
Pages Used to Work with Landed Costs on Receipts.....	1366
Understanding Landed Costs.....	1366
LC Manual Close (landed cost manual close) Page.....	1367
Voucher Details Page.....	1368
Closing Receipts.....	1369
Page Used to Close Receipts.....	1369
Understanding the Close Receipts Process.....	1369
Generating Receiving Labels.....	1370
Page Used to Generate Receiving Labels.....	1370
Understanding Barcode Label Generation.....	1370
Chapter 42: Using the Receiver's Workbench.....	1371
Understanding the Receiver Workbench.....	1371
Managing Receipts Using the Receiver Workbench.....	1371
Pages Used to Manage Receipts in Receiver Workbench.....	1371
Receiver Workbench – Search Page.....	1372
Receiver Workbench – Process Request Options.....	1375
Receiver Workbench – Processing Results Page.....	1376
Receiver Workbench – Workbench Log Page.....	1378
Chapter 43: Working with Delivery Information.....	1379
Understanding Delivery Information.....	1379
Accessing Delivery Information.....	1379
Pages Used to Access Delivery Information.....	1379
Maintain Delivery Information - Delivery Location Page.....	1380
Delivery Detail Page.....	1381
Life Cycle Inquiry Page.....	1383
Chapter 44: Inspecting Received Items.....	1385
Understanding Inspections.....	1385
Using Separate Inspections.....	1385
Performing Inspections.....	1387
Pages Used to Perform Inspections.....	1387

Inspection Page.....	1388
Maintain Receipt Asset Details Page.....	1392
Select Receipt (search criteria) Page.....	1393
Inspect Instructions Page.....	1393
Inspection & Putaway Information Page.....	1394
Line Details Page.....	1397
RTV Setup Page.....	1398
Chapter 45: Managing Vendor Returns.....	1401
Understanding the RTV Business Process.....	1401
Item Rejection Versus Item Returns.....	1402
Return Actions Review for RTV Transactions.....	1403
RTV Data Change Review.....	1405
Inventory Return Records.....	1407
Return to Vendor Streamline Processing.....	1408
Asset Return Records.....	1412
Common Elements Used in Vendor Returns.....	1413
Setting Up RTV Processing Options.....	1414
Creating RTV Transactions Without Purchase Orders.....	1415
Creating RTV Transactions Against Closed Purchase Orders.....	1415
Selecting RTV Source Details.....	1416
Entering RTV Transactions.....	1416
Pages Used to Enter RTV Transactions.....	1417
Return To Vendor Page.....	1419
Select Receipt Page.....	1431
Receipt Details Page.....	1433
Return To Vendor Defaults Page.....	1434
Override Supplier Address Page.....	1436
Select Purchase Order Page.....	1437
Select Receipt Distribution Page.....	1438
Select Receipt Assets Page.....	1438
Distribution Details Page.....	1439
Storage Location Search Page.....	1444
Return to Vendor Fees Page.....	1444
Return to Vendor Header Details Page.....	1446
Return To Vendor Pro Numbers Page.....	1446
Dispatching and Printing RTV Transactions.....	1447
Page Used to Dispatch and Print RTV Transactions.....	1447
Understanding the RTV Dispatch/Print Process.....	1447
Dispatch RTVs Page.....	1448
Using the RTV EIP.....	1450
Pages Used to Use the RTV EIP.....	1450
Understanding the RTV EIP.....	1451
Setting Up the RTV EIP.....	1451
Return to Vendor Message Selection Criteria Page.....	1452
Reconciling RTV Transactions.....	1452
Page Used to Reconcile RTV Transactions.....	1452
Understanding the RTV Reconciliation Process.....	1452
Inquiring About RTVs.....	1453
Pages Used to Inquire About RTVs.....	1453
Chapter 46: Using Receipt Accrual.....	1455
Understanding Receipt Accrual.....	1455

Receipt Accrual Criteria Description.....	1457
Receipt Accrual Setup.....	1459
Receipt Accrual Implementation.....	1460
Accruing Receipts.....	1461
Pages Used to Accrue Receipts.....	1461
Accrue Receipts Page.....	1461
Performing Budget-Checking for Receipt Accruals.....	1463
Page Used to Perform Budget-Checking for Receipt Accruals.....	1463
Budget Check Page.....	1463
Viewing Receipt Accrual Accounting Line Entries.....	1465
Pages Used to View Receipt Accrual Accounting Line Entries.....	1465
Accrual Accounting Entry Page.....	1466
Viewing Receipt Accrual Journal Entries.....	1467
Page Used to View Receipt Accrual Journal Entries.....	1467
Journal Drill Down Page.....	1467
Chapter 47: Reviewing Receipt Information.....	1469
Inquiring About Receipts.....	1469
Pages Used to Inquire About Receipts.....	1469
Chapter 48: Inquiring About Document Status.....	1471
Understanding Document Status Inquiries.....	1471
Common Elements Used in Document Status Inquiries.....	1472
Viewing Document Status.....	1474
Pages Used to View Document Status.....	1475
Document Status Page - Requisitions.....	1475
Document Status Page - Request for Quote.....	1476
Document Status Page - Purchase Order.....	1477
Document Status Page - Receipts.....	1478
Document Status Page - Return to Vendor.....	1478
Document Status Page - Procurement Contract.....	1479
Chapter 49: Analyzing Purchasing Using PeopleSoft Insights.....	1481
Understanding PeopleSoft Insights for Purchasing.....	1481
Setting up Insights Dashboards for Purchasing.....	1481
Adding Purchasing Tiles for Insights Dashboards.....	1483
Analyzing Purchasing Using PeopleSoft Insights.....	1487
Pages Used to Analyze Purchasing using PeopleSoft Insights.....	1487
Procurement Contracts Dashboard.....	1488
Purchasing Effectiveness Dashboard.....	1490
Purchasing Operations Dashboard.....	1492
Supplier Activity Analytics Insights.....	1494
Chapter 50: Analyzing Procurement History.....	1499
Understanding Procurement History Analysis.....	1499
Configuring Procurement Analysis Inquiries.....	1500
Pages Used to Configure Procurement Analysis Inquiries.....	1500
Define Procurement Controls Page.....	1500
Field Candidate Setup Page.....	1503
View Candidate Setup Page.....	1504
Inquiry Profile Setup Page.....	1505
Setup Procurement Users Page.....	1506
Generating Procurement History.....	1507
Page Used to Generate Procurement History.....	1507

Understanding the Procurement History Update Application Engine Process (FS_PRCRUPD).....	1507
Update Procurement History Page.....	1507
Generating Spend History.....	1508
Page Used to Generate Spend History.....	1509
Understanding the Spend History Application Engine Process (PO_SPND_HIST).....	1509
Update Spend History Page.....	1509
Generating Procurement Statistics.....	1510
Page Used to Generate Procurement Statistics.....	1511
Understanding the Procurement Statistics Process.....	1511
Update Procurement Statistics Page.....	1511
Reviewing Supplier Performance.....	1513
Page Used to Review Supplier Performance.....	1513
View Supplier Shipment Performance Page.....	1513
Viewing Procurement Analysis Data.....	1515
Pages Used to View Procurement Analysis Data.....	1515
Understanding Procurement History Inquiries.....	1517
Common Elements Used in Procurement History Inquiries.....	1518
Purchase Order List Page.....	1519
Receipt List Page.....	1520
Voucher List Page.....	1520
Requisition Inquiry selection criteria Page.....	1521
Viewing Procurement Statistics.....	1521
Page Used to View Procurement Statistics.....	1522
Procurement Statistics inquiry Page.....	1522
Setting Up and Using PeopleSoft Fluid User Interface for Financials and Supply Chain Management.....	1525
Common Elements Used with PeopleSoft Fluid User Interface.....	1526
Understanding PeopleSoft Fluid User Interface with Procurement Operations Pages.....	1526
Pages Used to Set Up the PeopleSoft Fluid User Interface for Procurement Operations.....	1527
Configuring Thresholds and Events for Procurement Operations.....	1528
Page Used to Supplier Watch List Event Page.....	1528
Supplier Watch List Event Page.....	1528
Define Event Threshold Page.....	1528
Page Used to Define Event Threshold Page.....	1529
Define Event Threshold Page.....	1529
Setting Up Your Procurement Operations Using PeopleSoft Fluid Pages.....	1530
Procurement User Preferences.....	1532
Common Elements Used in Procurement User Preferences.....	1532
Procurement User Preferences – Contract Expiration Page.....	1533
Procurement User Preferences – PO Approval Cycle Time Page.....	1535
Procurement User Preferences – Procurement Spend Analysis Page.....	1536
Procurement User Preferences – Supplier Watch List Page.....	1537
Procurement User Preferences - View Event Threshold Page.....	1538
Page Used to View the Procurement User Preferences - View Event Threshold Page.....	1538
Procurement User Preferences - PO Acknowledgement Page.....	1539
Procurement Operations Home Page with Reporting Entity not assigned to User.....	1540
Procurement User Preferences – Sourcing Events Page.....	1541
Working with the Procurement Operations Home Page.....	1544
Using Procurement Spend Analysis with the PeopleSoft Fluid User Interface.....	1546
Pages Used to Analyze Procurement Spend.....	1546

Procurement Spend Analysis Page.....	1546
Monitoring Expiring Contracts with the PeopleSoft Fluid User Interface.....	1547
Page Used to Monitor Expiring Contracts.....	1547
Expiring Contracts Page.....	1547
Monitoring Cycle Times Using the PeopleSoft Fluid User Interface.....	1548
Pages Used to Monitor Cycle Times.....	1548
Understanding Cycle Time Tiles.....	1549
PO Approval Cycle Time Page.....	1549
Req Approval Cycle Time Page.....	1550
Req to PO Cycle Times.....	1551
Managing Sourcing Events with the PeopleSoft Fluid User Interface.....	1551
Page Used to Manage Sourcing Events.....	1551
My Sourcing Events Page.....	1552
Using the Supplier Watch List With the PeopleSoft Fluid User Interface.....	1554
Pages Used in the Supplier Watch List.....	1554
Supplier Watch List Page.....	1555
Analyzing Payment Spend with the PeopleSoft Fluid User Interface.....	1569
Page Used to Analyze Payment Spend.....	1569
Payment Spend Analysis Page.....	1570
Chapter 51: Using Group Purchasing Organizations.....	1573
Understanding GPO Contracts.....	1573
Common Elements Used in GPO Contracts.....	1573
Defining GPO Contracts.....	1574
Pages Used to Define GPO Contracts.....	1574
Understanding the GPO Contract Definition Process.....	1575
Define GPO Manufacturer (define group purchasing organization manufacturer) Page.....	1576
GPO Distributor (define group purchasing distributor) Page.....	1577
Loading GPO Contracts.....	1578
Pages Used to Load GPO Contracts.....	1578
Understanding the Load GPO Contracts Process.....	1579
Understanding Health Care Unit-of-Measure Conversion.....	1582
Loading GPO Data Using PeopleSoft Integration Broker.....	1587
GPO Item Load Errors (group purchasing organization item load errors) Page.....	1588
GPO Item Selection (group purchasing organization item selection) Page.....	1588
GPO Load Manufacturer Price (group purchasing organization load manufacturer price) Page.....	1592
Item Mfg GPO Errors (item manufacturing group purchasing organization errors) Page.....	1593
Item Manufacturer GPO (item manufacturer group purchasing organization) Page.....	1594
Calculating Distributor Prices.....	1594
Pages Used to Calculate Distributor Prices.....	1594
Understanding Calculating Distributor Prices.....	1595
GPO Load Distributor Price (group purchasing organization load distributor price) Page.....	1596
Chapter 52: (USF) Using Federal Spending Regions.....	1599
Understanding Federal Spending Regions.....	1599
Defining Federal Spending Regions.....	1599
Page Used to Define Federal Spending Regions.....	1599
Spending Region Install Option Page.....	1599
Using Spending Regions.....	1601
Pages Used to Use Spending Regions.....	1601
Spending Region Definition Page.....	1601
Chapter 53: (USF) U.S. Federal G-Invoicing.....	1603

Understanding U.S. Federal G-Invoicing Processing.....	1603
PeopleSoft G-Invoicing Business Processes.....	1605
Configuring and Using PeopleSoft G-Invoicing.....	1607
Pages Used to Configure and Manage G-Invoicing.....	1607
Federal Processing Options Page.....	1608
G-Invoicing Definition Page.....	1609
General Terms and Conditions Page.....	1611
G-Invoicing Pull GTCs Page.....	1612
Orders Page.....	1613
G-Invoicing Pull Orders Page.....	1615
Performance Transactions Page.....	1616
G-Invoicing Pull Performance Page.....	1619
G-Invoicing Push Performance Page.....	1621
Creating G-Invoicing Purchase Order Transactions.....	1622
Creating Advance Shipping Notifications for G-Invoicing Performance Transactions.....	1623
Pushing Receipts to G-Invoicing.....	1624
Chapter 54: Processing Taxes for India.....	1627
Processing Custom Duty, Excise Duty, and Sales Tax/VAT in the Sourcing Business Process.....	1627
Pages Used to Process Custom Duty, Excise Duty, and Sales Tax/VAT in the Sourcing Business Process.....	1627
Run Controls Page.....	1628
PO Stage Excise/Sales Tax/VAT Details Page.....	1628
Create PO Page.....	1633
Purge Stage Page.....	1634
Processing Excise Duty and Sales Tax/VAT for Online Purchase Orders.....	1634
Pages Used to Process Excise Duty and Sales Tax/VAT for Online Purchase Orders.....	1634
Maintain Purchase Order - Purchase Order page Page.....	1636
Excise Duty/Sales Tax/VAT Details for Schedule Page.....	1637
Processing Customs Duty on Online Purchase Orders.....	1645
Pages Used to Process Customs Duty on Online Purchase Orders.....	1645
Understanding Purchase Order Customs Duty Processing.....	1646
Maintain Purchase Order - Purchase Order Page.....	1646
Maintain Purchase Order - Schedules Page.....	1647
Excise Duty/Sales Tax/VAT Details for Schedule Page.....	1648
Express Purchase Order - Purchase Order Page.....	1652
Dispatching and Printing Excise Duty and Sales Tax/VAT Information on Purchase Orders.....	1654
Page Used to Dispatch and Print Excise Duty and Sales Tax/VAT Information on Purchase Orders.....	1655
Processing Custom Duty, Excise Duty, and Sales Tax/VAT in Purchase Order Change Orders.....	1655
Page Used to Process Custom Duty, Excise Duty, and Sales Tax/VAT in Purchase Order Change Orders.....	1656
Processing Excise Duty and Sales Tax/VAT in the PO Receipt Push Process.....	1656
Page Used to Process Excise Duty and Sales Tax/VAT in the PO Receipt Push Process.....	1657
Using the Return-To-Vendor (RTV) Excise Adjustment Business Process.....	1657
Using a BOE.....	1657
Pages Used to Use a BOE.....	1658
Understanding BOE.....	1658
Understanding BOE Processing Rules.....	1659
Understanding BOE Statuses.....	1660
Understanding BOE Customs Duty Determination and Calculation.....	1661
Maintain Bill of Entry IND Page.....	1661

Select Lines Page.....	1667
Header Details Page.....	1671
Bill of Entry Worksheet Page.....	1674
Bill of Entry Page.....	1675
Receiving Against a BOE.....	1676
Pages Used to Receive Against BOE.....	1676
Understanding the BOE Receipts.....	1676
Select Purchase Order - Search Criteria Page.....	1676
Maintain Receipts - Receiving Page.....	1678
Running the Receiver Interface Push Process with Customs Duty.....	1680
Creating Internal Supplier Excise Invoices Against a BOE.....	1681
Pages Used to Create Internal Supplier Excise Invoices Against a BOE.....	1681
Internal Supplier Excise Invoice Search Page.....	1681
Creating Internal Supplier Excise Invoices for BOE Transactions.....	1682
Viewing India Localization Reports.....	1685
Chapter 55: Delivered Workflows for PeopleSoft Purchasing.....	1687
Delivered Workflows for PeopleSoft Purchasing.....	1687
Bank Statement Arrived.....	1687
Contract Expiration Alert.....	1688
Online Purchase Order Acknowledgement Notifications.....	1688
Procurement Card Grace Period Expired.....	1689
Purchase Order Acknowledgement Alert Notification.....	1690
Purchase Order Approval - ChartField Approval, Supervisor.....	1691
Purchase Order Approval - ChartField Approval, Reviewer.....	1691
Purchase Order Approval - ChartField Approval, Denied.....	1692
Purchase Order Approval - Amount Approval, Supervisor.....	1693
Purchase Order Approval - Amount Approval, Reviewer.....	1693
Purchase Order Approval - Amount Approval, Denied.....	1694
Purchase Order Canceled.....	1695
Rebate Manager Notification.....	1695
Receipt Quantity Change Notification.....	1696
Request for Quote (RFQ) Notification.....	1696
Requisition Approval - ChartField Approval.....	1697
Requisition Approval - ChartField Approval.....	1698
Requisition Approval - ChartField Approval.....	1698
Requisition Approval - Amount Approval.....	1699
Requisition Approval - Amount Approval.....	1700
Requisition Approval - Amount Approval.....	1700
Settlement Manager Notification.....	1701
Chapter 56: PeopleSoft Purchasing Reports.....	1703
PeopleSoft Purchasing Reports: General Description.....	1703
PeopleSoft Purchasing Reports.....	1703
PeopleSoft Purchasing Cost Reports.....	1716
PeopleSoft Purchasing Report Details.....	1717
Common Elements Used in PeopleSoft Purchasing Reports.....	1717
POLGSPND - Line Group Spend.....	1718
POPO005 - PO Dispatch/Print.....	1718
POPO008 - Close Purchase Order.....	1719
POPO009 - PO Activity.....	1720
POPO010 - PO Acknowledgement.....	1720
PO_POROLLEXP - PO Rollover Exception List Sort by PO.....	1721

PORC100 - Advanced Shipment Receipt (ASR).....1721

PORC200 - Planned Receipt.....1722

PORC700 - Receipt Accrual.....1722

PORC920 - Receipt Item Usage Labels.....1723

PORC930 - Device Tracking Receipts.....1724

POROL001 - Open Purchase Order.....1725

POROL002 - PO Rollover.....1725

POROLLEXP_PO - PO Rollover Exception List Sort by Type.....1725

PORQ010 - Requisition Print SQR.....1726

PORT001 - RTV Dispatch/Print.....1727

POS8001 - Procurement Budgetary Activity.....1727

POS8002 - Requisition Budgetary Activity.....1729

PO Dispatch.....1731

POXMLP - Print.....1731

POX4006 - Expediting Report by Buyer.....1731

POX4007 - Expediting Report by Supplier.....1731

POX4008 - Expediting Report by Due Date.....1731

POX4030 - PO Detail Listing By PO Date1731

POX4031 - PO Detail Listing By Supplier1732

POX4032 - PO Detail Listing By Buyer.....1732

POX4100 - PO To Requisition XREF.....1732

POX5001 - Receiver Summary.....1732

POX5010 - Receiver Ship to Detail1732

POX5020 - Receiver Account Detail1732

POX5030 - Receipt Delivery Detail.....1732

POX1100 - Requisition to PO XREF.....1733

POX3031 - Contract Activities.....1733

POX5001 - Receiver Summary.....1733

POX5020 - Receiver Account Detail.....1734

POX5030 - Receipt Delivery Detail.....1734

- Shop Floor Receipt Delivery.....1735

POX5050 - Return To Vendor Detail.....1735

Preface

Understanding the PeopleSoft Online Help and PeopleBooks

The PeopleSoft Online Help is a website that enables you to view all help content for PeopleSoft applications and PeopleTools. The help provides standard navigation and full-text searching, as well as context-sensitive online help for PeopleSoft users.

Hosted PeopleSoft Online Help

You can access the hosted PeopleSoft Online Help on the [Oracle Help Center](#). The hosted PeopleSoft Online Help is updated on a regular schedule, ensuring that you have access to the most current documentation. This reduces the need to view separate documentation posts for application maintenance on My Oracle Support. The hosted PeopleSoft Online Help is available in English only.

To configure the context-sensitive help for your PeopleSoft applications to use the Oracle Help Center, see [Configuring Context-Sensitive Help Using the Hosted Online Help Website](#).

Locally Installed PeopleSoft Online Help

If you're setting up an on-premises PeopleSoft environment, and your organization has firewall restrictions that prevent you from using the hosted PeopleSoft Online Help, you can install the online help locally. Installable PeopleSoft Online Help is made available with selected PeopleSoft Update Images and with PeopleTools releases for on-premises installations, through the [Oracle Software Delivery Cloud](#).

Your installation documentation includes a chapter with instructions for how to install the online help for your business environment, and the documentation zip file may contain a README.txt file with additional installation instructions. See *PeopleSoft 9.2 Application Installation* for your database platform, "Installing PeopleSoft Online Help."

To configure the context-sensitive help for your PeopleSoft applications to use a locally installed online help website, see [Configuring Context-Sensitive Help Using a Locally Installed Online Help Website](#).

Downloadable PeopleBook PDF Files

You can access downloadable PDF versions of the help content in the traditional PeopleBook format on the [Oracle Help Center](#). The content in the PeopleBook PDFs is the same as the content in the PeopleSoft Online Help, but it has a different structure and it does not include the interactive navigation features that are available in the online help.

Common Help Documentation

Common help documentation contains information that applies to multiple applications. The two main types of common help are:

- Application Fundamentals

- Using PeopleSoft Applications

Most product families provide a set of application fundamentals help topics that discuss essential information about the setup and design of your system. This information applies to many or all applications in the PeopleSoft product family. Whether you are implementing a single application, some combination of applications within the product family, or the entire product family, you should be familiar with the contents of the appropriate application fundamentals help. They provide the starting points for fundamental implementation tasks.

In addition, the *PeopleTools: Applications User's Guide* introduces you to the various elements of the PeopleSoft Pure Internet Architecture. It also explains how to use the navigational hierarchy, components, and pages to perform basic functions as you navigate through the system. While your application or implementation may differ, the topics in this user's guide provide general information about using PeopleSoft applications.

Field and Control Definitions

PeopleSoft documentation includes definitions for most fields and controls that appear on application pages. These definitions describe how to use a field or control, where populated values come from, the effects of selecting certain values, and so on. If a field or control is not defined, then it either requires no additional explanation or is documented in a common elements section earlier in the documentation. For example, the Date field rarely requires additional explanation and may not be defined in the documentation for some pages.

Typographical Conventions

The following table describes the typographical conventions that are used in the online help.

<i>Typographical Convention</i>	<i>Description</i>
Key+Key	Indicates a key combination action. For example, a plus sign (+) between keys means that you must hold down the first key while you press the second key. For Alt+W , hold down the Alt key while you press the W key.
... (ellipses)	Indicate that the preceding item or series can be repeated any number of times in PeopleCode syntax.
{ } (curly braces)	Indicate a choice between two options in PeopleCode syntax. Options are separated by a pipe ().
[] (square brackets)	Indicate optional items in PeopleCode syntax.
& (ampersand)	When placed before a parameter in PeopleCode syntax, an ampersand indicates that the parameter is an already instantiated object. Ampersands also precede all PeopleCode variables.

Typographical Convention	Description
⇒	This continuation character has been inserted at the end of a line of code that has been wrapped at the page margin. The code should be viewed or entered as a single, continuous line of code without the continuation character.

ISO Country and Currency Codes

PeopleSoft Online Help topics use International Organization for Standardization (ISO) country and currency codes to identify country-specific information and monetary amounts.

ISO country codes may appear as country identifiers, and ISO currency codes may appear as currency identifiers in your PeopleSoft documentation. Reference to an ISO country code in your documentation does not imply that your application includes every ISO country code. The following example is a country-specific heading: "(FRA) Hiring an Employee."

The PeopleSoft Currency Code table (CURRENCY_CD_TBL) contains sample currency code data. The Currency Code table is based on ISO Standard 4217, "Codes for the representation of currencies," and also relies on ISO country codes in the Country table (COUNTRY_TBL). The navigation to the pages where you maintain currency code and country information depends on which PeopleSoft applications you are using. To access the pages for maintaining the Currency Code and Country tables, consult the online help for your applications for more information.

Region and Industry Identifiers

Information that applies only to a specific region or industry is preceded by a standard identifier in parentheses. This identifier typically appears at the beginning of a section heading, but it may also appear at the beginning of a note or other text.

Example of a region-specific heading: "(Latin America) Setting Up Depreciation"

Region Identifiers

Regions are identified by the region name. The following region identifiers may appear in the PeopleSoft Online Help:

- Asia Pacific
- Europe
- Latin America
- North America

Industry Identifiers

Industries are identified by the industry name or by an abbreviation for that industry. The following industry identifiers may appear in the PeopleSoft Online Help:

- USF (U.S. Federal)

- E&G (Education and Government)

Translations and Embedded Help

PeopleSoft 9.2 software applications include translated embedded help. With the 9.2 release, PeopleSoft aligns with the other Oracle applications by focusing our translation efforts on embedded help. We are not planning to translate our traditional online help and PeopleBooks documentation. Instead we offer very direct translated help at crucial spots within our application through our embedded help widgets. Additionally, we have a one-to-one mapping of application and help translations, meaning that the software and embedded help translation footprint is identical—something we were never able to accomplish in the past.

Using and Managing the PeopleSoft Online Help

Select About This Help in the left navigation panel on any page in the PeopleSoft Online Help to see information on the following topics:

- Using the PeopleSoft Online Help.
- Managing hosted Online Help.
- Managing locally installed PeopleSoft Online Help.

PeopleSoft FSCM Related Links

[Oracle Help Center](#)

[Hosted Online Help](#)

[PeopleSoft Information Portal](#)

[My Oracle Support](#)

Financial and Supply Chain Management information for Search Framework search engine can be found in PeopleSoft Application Fundamentals documentation. For application specific information, see the “Understanding Keyword Search within Components” (Application Fundamentals) topic.

[PeopleSoft Training from Oracle University](#)

[PeopleSoft Video Feature Overviews on YouTube](#)

[PeopleSoft Business Process Maps \(Microsoft Visio format\)](#)

[PeopleSoft Spotlight Series](#)

Contact Us

Send your suggestions to psoft-infodev_us@oracle.com.

Please include the applications update image or PeopleTools release that you're using.

Follow Us

<i>Icon</i>	<i>Link</i>
	Watch PeopleSoft on YouTube
	Follow @PeopleSoft_Info on X.
	Read PeopleSoft Blogs
	Connect with PeopleSoft on LinkedIn

Chapter 1

Getting Started With PeopleSoft Purchasing

PeopleSoft Purchasing Business Processes

The PeopleSoft Purchasing business processes include:

- Requests for quotes
- Procurement cards
- Procurement contracts
- Vendor rebates
- Online and batch requisition creation
- Requisition change orders
- Requisition reconciliation
- Online and batch purchase order creation
- Purchase order change orders
- Purchase order reconciliation
- Receiving
- Inspections
- Returns to suppliers
- Procurement analysis

We cover these business processes in the business process topic in this documentation.

Common Elements Used in Purchasing

<i>Field or Control</i>	<i>Description</i>
Description	Free-flow text up to 30 characters.

Field or Control	Description
Effective Date	Date on which a table row becomes effective; the date that an action begins. For example, if you want to close out a ledger on June 30, the effective date for the ledger closing would be July 1. This date also determines when you can view and change the information. Pages or panels and batch processes that use the information use the current row.
Language or Language Code	The language in which you want the field labels and report headings of your reports to print. The field values appear as you enter them. Language also refers to the language spoken by an employee, applicant, or non employee.
Process Frequency (group box)	Designates the appropriate frequency in the Process Frequency group box: <i>Once</i> executes the request the next time the batch process runs. After the batch process runs, the process frequency is automatically set to <i>Don't Run</i> . <i>Always</i> executes the request every time the batch process runs. <i>Don't Run</i> ignores the request when the batch process runs.
Process Monitor	This link takes you to the Process List page, where you can view the status of submitted process requests.
Report ID	The report identifier.
Report Manager	This link takes you to the Report List page, where you can view report content, check the status of a report, and see content detail messages (which show you a description of the report and the distribution list).
Recipient's	Select to have a report print in the language defined for the recipient of the report.
Request ID	A request identification that represents a set of selection criteria for a report or process.
Run	This button takes you to the Process Scheduler request page, where you can specify the location where a process or job runs and the process output format.

Field or Control	Description
Run Control ID	Each run control you create receives a unique run control ID. When you select a process from a menu, a search dialog box appears, asking for a run control ID. If you're in Add mode, enter a new ID for the run control you are about to define. If you're in Update/Display mode, enter an existing run control ID or click the Search button and select from the list of available run control IDs.
Short Description	Free-flow text up to 15 characters.
Specified	Select to have a report print in the language that you specify in the Language field.
Status	Your options in this field are <i>Active</i> or <i>Inactive</i> . By linking status and effective date, you can retain historical information and plan future implementation. For auditing purposes, PeopleSoft encourages inactivating data that is no longer in use instead of deleting it.
User ID	The system identifier for the individual who generates a transaction.

PeopleSoft Purchasing Integrations

PeopleSoft Purchasing integrates with the following PeopleSoft applications:

- PeopleSoft Asset Management
- PeopleSoft eProcurement
- PeopleSoft eSupplier Connection
- PeopleSoft Supply Planning Multisite Material Planner, Supply Planning Advanced Multisite Planner, and Manufacturing
- PeopleSoft General Ledger
- PeopleSoft Inventory
- PeopleSoft Mobile Inventory Management
- PeopleSoft Maintenance Management
- PeopleSoft Order Management
- PeopleSoft Payables
- PeopleSoft Project Costing

- PeopleSoft Quality
- PeopleSoft Receivables
- PeopleSoft Strategic Sourcing
- PeopleSoft Supplier Contract Management

We cover integration considerations in the implementation topic in this Documentation.

Supplemental information about third-party application integrations is located on the My Oracle Support website.

PeopleSoft Asset Management

A direct link with PeopleSoft Asset Management streamlines the entry of asset information. Seamless interaction between PeopleSoft Purchasing, PeopleSoft Asset Management, and PeopleSoft Payables enables you to pass asset information from both Purchasing and Payables using a common process, capitalization of assets at point of receipt, and process modifications to existing assets.

PeopleSoft eProcurement

Close integration between PeopleSoft eProcurement and PeopleSoft Purchasing enables you to share common control data, such as item definitions for both PeopleSoft eProcurement and PeopleSoft Purchasing. It enables you to create requisitions, purchase orders, receipts, and other transactions that will be stored in shared tables. The combination offers a complete solution for direct, indirect, service, and project purchases in an integrated environment.

PeopleSoft eSupplier Connection

Self-service Web transactions enable you to give your suppliers access to address and contact information, saving your employees time and effort. With PeopleSoft eSupplier Connection, you can also give suppliers view access for review purposes to account balances, invoices, orders, payments, receipts, schedule information, and kanban requests. Security features make it easy for suppliers to grant appropriate access to their own employees, removing the administrative burden from your employees. At the same time, your employees retain the power to maintain supplier employees, if necessary. Of course, you always control which suppliers have access to your PeopleSoft site and which data they can view and change.

PeopleSoft Supply Planning Multisite Material Planner, Supply Planning Advanced Multisite Planner, and Manufacturing

PeopleSoft Supply Planning Multisite Material Planner, Supply Planning Advanced Multisite Planner, and Manufacturing send purchase orders and change orders directly to the PeopleSoft Purchasing database tables. Orders for subcontracted services from your shop floor, planned orders, and requisitioned items can be processed identically, and yet you can still distinguish them and set up separate processing rules for each type.

PeopleSoft General Ledger

Commitment Control, a subsystem of PeopleSoft General Ledger, is an optional feature for PeopleSoft Purchasing that enables you to control commitments and expenditures by checking them against predefined, authorized budgets. This feature can be activated for specific products and business units.

Commitment Control can be used to automatically check pre-encumbrances, encumbrances, and expenditures against control budgets. It can detect and notify you of pending budget exceptions, and also freeze the affected transactions. It can also take into consideration the budget tolerances and revenue types that you want the system to use to increase expenditure limits.

PeopleSoft Purchasing and General Ledger also support period-end, on-demand receipt accrual, also known as flow-through receipt accrual. When you use the PeopleSoft Payables Matching module, this process backs out previous transactions before new transactions can be generated. The original transactions for which reversals have just been created are flagged as canceled. Then the process generates new transactions for receipts that qualify for accrual and creates new transactions in the staging record for each receipt line. Finally, encumbrance transactions are generated for the current period and reversal transactions are generated for the next period. When you run the Receipt Accrual process at the end of each accounting period, the process accrues unbilled receipt amounts in a receipt accrual liability account and debits identical amounts from the designated expense accounts. PeopleSoft Purchasing supports period-end receipt accrual for expensed items where you have received the goods from the supplier, but the supplier has not yet invoiced your company. It also supports receipt accrual for expensed items, where a non-purchase order receipt has been entered. You can control whether the system accrues for one of the scenarios, both scenarios, or not at all.

PeopleSoft Inventory

The close integration between PeopleSoft Purchasing and PeopleSoft Inventory enables you to share common item definitions and set up items from one menu for both PeopleSoft Purchasing and PeopleSoft Inventory. It enables you to create replenishment requests based on defined inventory levels; create material stock requests to fill purchase requests; update inventory upon receipt of goods; and include the miscellaneous charges (such as freight, duty, and tax) for a purchase in the item's inventory cost calculations. PeopleSoft's extensive consignment inventory feature enables you to implement this strategy across your enterprise. Inventory receipts can be recorded, holding the recognition of ownership until after the goods are consumed from your inventory.

Integration with PeopleSoft Inventory means that you can include the landed cost charges in the item's cost. Landed cost charges can include expenses such as freight, insurance, duty, and handling. You can create cost templates that specify which cost charges to attach to any combination of item, item category, supplier, supplier location, ship-to ID, and purchasing business unit. In PeopleSoft Purchasing, you can also directly associate cost templates and individual charges with a purchase order header or purchase order schedule.

Using the Pegging workbench, you can optionally tie item demand to supply provided by a specific requisition or purchase order. Multiple demand lines can be satisfied by a single schedule or, alternatively, multiple schedules may be used to satisfy a single demand. The pegging workbench can also be accessed from within the Requisition and Purchase Order maintenance pages. Once the tie between the specific purchase order or requisition is made, notifications are sent to the appropriate owners whenever changes to either the supply or the demand are made.

PeopleSoft Mobile Inventory Management

PeopleSoft Purchasing integrates with PeopleSoft Mobile Inventory Management to create receipts and purchase order deliveries using mobile devices, such as hand held devices, phones or bar code readers. The Mobile Inventory Management application provides tools to integrate mobile devices to the PeopleSoft Supply Chain Management system.

Purchasing information collected using mobile devices is transmitted to and recorded in the Purchasing system. Using mobile devices, you can receive inventory or non-inventory items, with or without

associated purchase orders. Receipts with a purchase order can be for items that will be stocked in inventory or for items that will go directly to par locations or go directly to various departments. A receipt without a purchase order (ad hoc receipt) can be interfaced to the same products as a purchase order receipt.

After receiving the stock, you can use the Mobile Delivery task flow in Mobile Inventory Management to record the final destination for delivered items, view location and ship to information relevant to the delivery of the items, and to whom the items were delivered. Delivery information exists at the receipt distribution level and originates from either a requisition or purchase order.

PeopleSoft Maintenance Management

PeopleSoft Purchasing integrates with PeopleSoft Maintenance Management to acquire parts and services needed for the maintenance and repair of assets.

Requisitions and purchase orders can be created to acquire parts and services for a work order that is created in PeopleSoft Maintenance Management. The work order link to the requisition or purchase order is maintained throughout the procurement life cycle. As parts are received notification is sent to the appropriate maintenance personnel. In addition, once work is complete on the work order, excess parts can be returned to the supplier.

PeopleSoft Order Management

Through the requisition loader process, PeopleSoft Order Management sends direct ship orders, and changes to those orders, to PeopleSoft Purchasing.

Within Sales Order entry, users will also have the option of sourcing the demand directly from PeopleSoft Purchasing. When demand for an item on a sales order is created, the Customer Service Representative will have the option of tying the demand to existing supply from a requisition or purchase order or to create a new purchase order to fulfil the demand. When a new PO is created, the CSR may optionally preselect the supplier. Once this link is made, the purchased items can either be drop shipped directly to the customer site or received into inventory and shipped at a later time. When changes to either the demand or the supply are made, notifications are sent so the appropriate documents can be updated.

PeopleSoft Payables

The interaction of PeopleSoft Purchasing and PeopleSoft Payables data and processing enables you to match vouchers with all purchase order and receiver details, and to generate payments without waiting for invoices, using the Evaluated Receipt Settlement matching process. In addition, the PeopleSoft Payables voucher build process automatically generates invoices from Return To Vendor transactions and Procurement Card statements created in PeopleSoft Purchasing to streamline and centralize voucher creation. With instant access to all related current and historical procurement data, the procurement analysis tools enable you to view trends or track one item across all of procurement.

PeopleSoft Purchasing purchase order contracts and PeopleSoft Payables vouchers components are combined in one place within the system, providing full contract functionality through a single user interface.

In addition, vendor rebate claims are sent to PeopleSoft Payables for settlement (to net the supplier balance in the next pay-cycle) or for rebate and VAT accounting entries posting depending on the rebate agreement settlement method. Vendor rebate claims are sent to PeopleSoft Payables as an adjustment voucher using the Process Claims Driver process. The Process Claims Driver process then initiates the Claim Settlement Process for AP process (claim settlement process for account payables process). Then

when an adjustment voucher is created PeopleSoft Payables sends that information back to PeopleSoft Purchasing.

Plus, prepayment vouchers can be sent from PeopleSoft Purchasing to the voucher staging tables when loading procurement card statements if you so choose. These prepayment vouchers include the procurement card transactions associated with a purchase order.

PeopleSoft Project Costing

PeopleSoft Purchasing creates requisitions based on project activity requests in PeopleSoft Project Costing and returns ordered materials transactions to Project Costing as committed costs.

PeopleSoft Quality

Direct integration with PeopleSoft Quality enables you to maintain detailed quality data, such as defect descriptions, required measurements, and cause/action information. Suppliers, items, lot numbers, and serial numbers are passed to PeopleSoft Quality. By using the integration between PeopleSoft Purchasing and Quality, you can do extensive statistical and graphical analyses on receiving inspection data, including Pareto diagrams, control charting, and distribution analysis.

PeopleSoft Receivables

Vendor rebate claims with a settlement method of check, credit memo, direct debit, draft, or electronic funds transfer are sent to PeopleSoft Receivables for expected payment as a pending item using the Process Claims Driver process. The Process Claims Driver process then initiates the Claim Settlement Process for AR process (claim settlement process for account receivables process). Then when payment is received for these pending items PeopleSoft Receivables sends that payment information back to PeopleSoft Purchasing.

PeopleSoft Strategic Sourcing

With PeopleSoft Strategic Sourcing, requisitions created from PeopleSoft Purchasing can be converted into sourcing events to gather competitive pricing, analyze bids, and award to the most qualified bidders. Once an event is awarded, either Purchase Orders or supplier Contracts can be automatically created in PeopleSoft Purchasing to leverage the pricing arrangements and terms negotiated during the execution of the event.

PeopleSoft Supplier Contract Management

Using PeopleSoft Supplier Contract Management with Purchasing, contract specialists can create authored contract documents that can be associated to transaction information contained in purchase orders or requisitions. When using Supplier Contract Management with procurement contracts the system can also track contract compliance using contract agreement capability as well as spend notifications at the header, line, and category levels.

PeopleSoft Purchasing Implementation

PeopleSoft Setup Manager enables you to review a list of setup tasks for your organization for the products that you are implementing. The setup tasks include the components that you must set up, listed

in the order in which you must enter data into the component tables, and links to the corresponding Product documentation.

PeopleSoft Purchasing also provides component interfaces to help you load data from your existing system into PeopleSoft Purchasing tables. Use the Excel to Component Interface utility with the component interfaces to populate the tables.

This table lists all of the components that have component interfaces:

Component	Component Interface	Reference
ITM_MFG_UPN	ITM_MFG_UPN_CI	See “Using Universal Item Identifiers” (PeopleSoft Managing Items).
ITM_SHIPTO_VNDR	ITM_SHIPTO_VNDR_CI	See Selecting Suppliers Based on Item Ship To and Item Supplier Locations .
LOCATION_TBL	LOCATION_TBL_CI	See “Defining Ship To Locations” (PeopleSoft Source to Settle Common Information).
PURCH_ITEM_ATTR	PURCH_ITEM_ATTR_CI	See Defining Purchasing Item Attributes .
REQUESTOR_TBL	REQUESTOR_TBL_CI	See “Defining Requesters” (PeopleSoft Source to Settle Common Information).

Other Sources of Information

In the planning phase of your implementation, take advantage of all PeopleSoft sources of information, including the installation guides, table-loading sequences, data models, and business process maps. A complete list of these resources appears in the preface in the PeopleSoft Application Fundamentals Documentation, with information about where to find the most current version of each.

PeopleSoft Events and Notifications Framework

As your organization processes the continuous stream of transactions within your PeopleSoft system, the events and notifications framework enables you to monitor the transaction flow and alert your organization to any errors, changes, and stalled transactions. The messages generated by the events and notifications framework can notify you of the problem, give you a detailed description of the issue, and provide a link to the PeopleSoft page where you can resolve it.

One of the ways to use the events and notifications framework is to create PeopleSoft Queries on one or more PeopleSoft tables, add the alert using the Alert Setup component, and then complete the alert setup steps. This method enables you to monitor data within a PeopleSoft table; for example, searching for stalled transactions, instead of looking at the results of a PeopleSoft process. When the Alerts process (EOEN_ALERT) is run, the PeopleSoft table is queried and the alert messages can be generated. These messages can be routed to the appropriate person (PeopleSoft user or non-PeopleSoft user) using an email, a PeopleSoft worklist entry, an XML message, or the PeopleSoft Notification Dashboard.

For the PeopleSoft Purchasing application, sample data includes the following PeopleSoft notifications that have been setup to work with the events and notifications framework. These notifications may require

minor modifications to work in your environment. You can also copy and alter these notifications to create new alert messages.

Process Name	Process Category	Description
PO_SHIPTO_MULT	NOTIFY_BUYER	Notify Buyer of PO retains multiple Ship To's
PO_RQSRCD_NOTIFY	NOTIFY_REQUESTOR	Notify requestor that Requisition has been sourced to a PO
PO_CHNG_NOTIFY	NOTIFY_REQUESTER	Notify requester of PO reject
PO_PEGGING	BREAK	Pegged PO break
PO_PEGGING	CANCEL	Pegged PO cancel
PO_PEGGING	CLOSE	Pegged PO close
PO_PEGGING	DTE_RESCH_IN	Pegged PO data reschedule in
PO_PEGGING	DTE_RESCH_OUT	Pegged PO data reschedule out
PO_PEGGING	HARD_PEG_QTY_CHANGE	Hard Peg quantity change
PO_PEGGING	QTY_DECREASE	Pegged PO quantity decrease
PO_PEGGING	QTY_INCREASE	Pegged PO quantity increase
PO_RTV_NOTIFY	NOTIFY_INV_MGR_ADJ	Notify RTV Inventory Adjustment
PO_RTV_NOTIFY	NOTIFY_INV_MGR_ISSUE	Notify RTV Express Issue
PO_RTV_NOTIFY	NOTIFY_INV_MGR_MSR	Notify RTV Inventory Fulfill
PO_VRBT_NOTIFY	NOTIFY_CLAIMS_MGR	Claims notification
PO_VRBT_NOTIFY	NOTIFY_REBATE_MGR	Rebate Manager Notify
PO_VRBT_NOTIFY	NOTIFY_SETTLEMENT_MGR	Settlement Manager Notify

For more information on Notification Framework, see “PeopleSoft Events and Notifications Framework Overview” (Events and Notifications Framework).

Related Product Documentation

The *PeopleSoft Purchasing Product Documentation* provides you with implementation and processing information for Oracle's PeopleSoft Purchasing system. However, additional, essential information describing the setup and design of the system resides in companion documentation. The companion documentation consists of important topics that apply to many or all of Oracle's PeopleSoft applications across the Financials, Enterprise Service Automation, and Supply Chain Management product lines. You should be familiar with the contents of these Product Documentation.

The following companion Product Documentation contain information that applies specifically to Oracle's PeopleSoft Purchasing:

- *PeopleSoft Application Fundamentals Documentation*
- *PeopleSoft Managing Items Documentation*
- *PeopleSoft Mobile Inventory Management Documentation*
- *PeopleSoft Global Options and Reports Documentation*
- *PeopleSoft Commitment Control Documentation*
- *PeopleSoft Source-To-Settle Common Information Documentation*
- *PeopleSoft Working With Third-Party Applications Documentation*
- *PeopleSoft Supply Chain Management Integrations Documentation*
- *PeopleSoft SCM Electronic Data Interchange Messaging Documentation*

Chapter 2

Using User-Definable Fields

Understanding User-Definable Fields

PeopleSoft Purchasing enables you to define fields that can be attached to purchasing documents and passed through the system without affecting PeopleSoft Purchasing functions. You can populate user-defined fields using the PeopleSoft Application Designer or add them to browser pages for the end users. Because the structural design is provided, you do not need to extensively modify the system to take advantage of this feature.

System defined subrecords are available at header, line, schedule, and distribution levels in PeopleSoft. You can also add fields that you create to the subrecords Purchasing. The Header, Line, Distribution, Receiving and RTV subrecords are delivered with two 1-character fields, one date field, and four 100-character fields. The Schedule subrecord is delivered with two 1-character fields, two date fields, and three 100-character fields. Using PeopleSoft Application Designer, you can edit the field labels in the subrecords to suit your needs. You can also add fields that you create to the subrecords and pages.

The data from each level of a document's subrecord flows to downstream documents. For example, if you source a requisition to a purchase order, the subrecord for each level on the requisition carries over to the purchase order accordingly.

Note: A header subrecord may not copy from one document to another if the target document can be sourced from multiple documents. For example, you may copy a new purchase order from existing requisitions. Because you can copy lines from multiple requisitions to a single purchase order, the system does not copy the header subrecord from the requisition.

The user defined fields are available on the procurement transactions when you check the Enable Custom Fields check box on the Purchasing Installation Options page. See “Installation Options - Purchasing Page” (Application Fundamentals) .

Custom fields will appear on the following pages:

Page Name	Definition	Navigation
PO Header Details	PO_HDR_DTL	Purchasing > Purchase Orders > Add/Update POs click on Header Details – Custom Fields section Purchasing > Purchase Orders > Add/Update Express POs click on Header Details – Custom Fields section

Page Name	Definition	Navigation
Details for Line	PO_LINE_DTLS	<p>Purchasing > Purchase Orders > Add/Update POs on the line grid, click on Line Details icon – Custom Fields section</p> <p>Purchasing > Purchase Orders > Add/Update Express POs on the line grid, click on Line Details icon – Custom Fields section</p>
Details for Schedule	PO_SCHED_DTLS	<p>Purchasing > Purchase Orders > Add/Update POs on the line grid, drill in Schedule icon. On the schedule, drill into the Schedule Details icon – Custom Fields section</p> <p>Purchasing > Purchase Orders > Add/Update Express POs in the line grid, expand line, on the schedule, drill in the Schedule Details icon – Custom Fields section</p>
Custom Fields for Distribution Line	PO_CUSTOMDST	<p>Purchasing > Purchase Orders > Add/Update POs on the line grid, drill in Schedule icon. On the schedule, drill in the Distributions / Chartfield icon, click on Details/Tax tab, click on Custom Field link</p> <p>Purchasing > Purchase Orders > Add/Update Express POs in the line grid, expand line, expand schedule, on the Distributions grid click on the Details/Tax - Custom Fields section</p>
PO Header Details (Inquiry)	PO_HDR_DTL_INQ	<p>Purchasing > Purchase Orders > Review PO Information > Purchase Orders click on Header Details – Custom Fields section</p>
Details for Line	PO_LINE_DTLS_INQ	<p>Purchasing > Purchase Orders > Review PO Information > Purchase Orders on the line grid, click on Line Details icon – Custom Fields section</p>
Details for Schedule	PO_SCHED_DTLS_INQ	<p>Purchasing > Purchase Orders > Review PO Information > Purchase Orders on the line grid, drill in Schedule Details icon. Click on Schedule Details icon – Custom Fields section</p>

Page Name	Definition	Navigation
Distribution for Schedule	PO_CUSTOMPOD_INQ	Purchasing > Purchase Orders > Review PO Information > Purchase Order son the line grid, drill in Schedule icon. Click on Distribution / Chartfields icon, click on the Details / Tax tab, then click on Custom Fields link.
Custom Fields for Requisition Header	PO_CUSTOMHDR_REQ	Purchasing > Requisitions click on Custom Fields link.
Requisition Line Details	REQ_LINE_DETAILS	Purchasing > Requisitions > Add/ Update Requisition son the line grid, drill down on the Line Details icon - Custom Fields section
Requisition Schedule Details	REQ_SCHED_DTL2	Purchasing > Requisitions > Add/ Update Requisition son the line grid, drill down on the Schedule icon. On the schedule grid, drill into the Schedule Details icon - Custom Fields section
Custom Fields for Distribution Line	PO_CUSTOMDST_REQ	Purchasing, Requisitions Add/Update Requisition son the line grid, drill down on the Schedule icon. On the schedule grid, drill on the Distribution / Chartfields icon, click on Custom Fields link.
Custom Fields for Requisition Header (Inquiry)	PO_CUSTOMREQ_INQ	Purchasing > Review Requisition Information > Requisition On the Details Tab, click on Custom Fields link.
Custom Fields for Line	PO_CUSTOMRQL_INQ	Purchasing > Review Requisition Information > Requisition On the Details Tab, drill in on the requisition number. On the Requisition Details – Details Tab, click on the Custom Fields link.
Custom Fields for Schedule	PO_CUSTOMRQS_INQ	On the Requisition Details, Details Tab, drill on the Schedules Detail icon, click on the Custom Fields link.
Custom Fields for Distribution Line	PO_CUSTOMRQD_INQ	On the Requisition Details, Details Tab, drill on the Schedules Detail icon. On the schedule grid, drill into the Distribution Details icon. On the Distribution grid, Details Tab, click on the Custom Fields link.

Page Name	Definition	Navigation
Receipt Header Details	RECV_WPO_HDR	Purchasing > Receipts > Add / Update Receipts click on Header Details link
Custom Fields for Line and Schedule	PO_CUSTOMSHP_RCV	Purchasing > Receipts > Add / Update Receipts on the Receipt Line grid, click on the Optional Input Tab, click on the Custom Fields Link.
Custom Fields for Distribution Line	PO_CUSTOMDST_RCV	Purchasing > Receipts > ,Add / Update Receipts on the Receipt Line grid, click on the Links and Status Tab, drill into the Distribution icon. On the Details Tab, click on the Custom Fields Link.
Custom Fields for Asset Line	PO_CUSTOMRV	Purchasing > Receipts > Add / Update Receipts on the Receipt Line grid, drill into the AM Status link. On the More Details Tab of the Asset Details grid, click on the Custom Fields Link.
Receipt Header Details (Inquiry)	RECV_INQ_HDR	Purchasing > Receipts > Review Receipt Information > View Receipt Information . Click on Header Details link – Custom fields section
Line Details (Line and Shipment custom fields)	RECV_INQ_LN_DTL	Purchasing > Receipts > Review Receipt Information > View Receipt Information . Click on Line Details link – Line Related Custom Fields and Shipment Related Custom Fields sections.
Custom Fields for Distribution Line	PO_CUSTOMRCD_INQ	Purchasing > Receipts > Review Receipt Information > View Receipt Information . Click on Distribution link, click on More Distribution Details Tab, click on the Custom Fields link
Custom Fields for Sequence (Assets level)	PO_CUSTOMRV_INQ	Purchasing > Receipts > Review Receipt Information > View Receipt Information . Click on Asset Information link. Click on More Details Tab, click on the Custom Fields link
Return to Vendor / Supplier Header Details	RTV_HDR_DTLS	Purchasing > Return to Vendor / Supplier > Add/Update RTV ,click on Header Details

Page Name	Definition	Navigation
Custom Fields for Line & Schedule	PO_CUSTOMSHP_RTV	On the line, click on the optional tab, click on Custom Fields link
Custom Fields for Distribution Line	PO_CUSTOMDST_RTV	On the line, drill down on the distribution icon, click on the Dist Detail Tab, click on the Custom Fields link
Custom Fields for Sequence	PO_CUSTOMPRO_RTV	On the line, drill down on the RTV Pro icon, click on the Custom Fields link
Review RTVs - Return to Vendor / Supplier Header Details	RTV_HDR_DTLS_INQ	Purchasing > Return to Vendor / Supplier > Review RTVs – click on Header Details
Custom Fields for Line & Schedule	PO_CUSTOMRVS_INQ	On the line, click on the optional tab, click on Custom Fields link
Custom Fields for Distribution Line	PO_CUSTOMRVD_INQ	On the line, drill down on the distribution icon, click on the Dist Detail Tab, click on the Custom Fields link
Custom Fields for Sequence	PO_CUSTOMRVP_INQ	Purchasing, Return to Vendor / Supplier > Review RTVs On the line, drill down on the RTV Pro icon Click on the Custom Fields link
Custom Fields for Contract Header	PO_CUSTOMHDR_CNT	Procurement Contracts > Add / Update Contracts – in Header Section, click on Custom Fields
Detail for Line	CNTRCT_PRC_UOM_SEC	Procurement Contracts > Add / Update Contracts drill into the Line Details icon

Note: Custom fields are not available when using Request for Quotes.

There are six subrecords for adding user-definable fields to purchasing transactions:

Subrecord Type	Subrecord Name
Header Subrecord	PUR_USR_HDR_SBR
Line Subrecord	PUR_USR_LIN_SBR

Subrecord Type	Subrecord Name
Schedule Subrecord	PUR_USR_SHP_SBR
Distribution Subrecord	PUR_USR_DST_SBR
Receiving Subrecord	PUR_USR_RV_SBR
RTV Subrecord (Return To Vendor subrecord)	PUR_USR_RTV_SBR

See the product documentation for *PeopleTools: Application Designer Developer's Guide*

To compile a listing of all of the PeopleSoft records that include these subrecords, you can use this sample SQL to query the PeopleSoft database:

```
SELECT A.RECNAME, A.FIELDNAME, B.RECTYPE, B.OBJECTOWNERID
FROM PSRECFIELD A, PSRECDEFN B
WHERE A.RECNAME = B.RECNAME
AND A.FIELDNAME IN ('PUR_USR_HDR_SBR', 'PUR_USR_LIN_SBR', 'PUR_USR_SHP_SBR', 'PUR_USR_
R_DST_SBR', 'PUR_USR_RV_SBR', 'PUR_USR_RTV_SBR')
```

Setting Up User-Definable Fields

Use PeopleSoft Application Designer to use the delivered fields, as well as to modify them or add new fields to the delivered subrecords.

You can add the fields to the pages and display them in the PeopleSoft Purchasing browser pages, or use them only behind the scenes. You can also populate the fields behind the scenes and then display them on the browser pages.

Note: If you choose to insert new fields into any of the subrecords, you must alter the tables to avoid losing application data that already exists in the tables.

Only those with technical knowledge of PeopleSoft Application Designer and PeopleCode should modify or add to the delivered subrecords.

To compile a list of tables that must be altered by a data base administrator, you can use this sample SQL statement, altering the criteria "A.FIELDNAME =" to reference the subrecord modified. This SQL lists the tables and views for the Header subrecord, PUR_USR_HDR_SBR:

```
SELECT A.RECNAME, A.FIELDNAME, B.RECTYPE, B.OBJECTOWNERID
FROM PSRECFIELD A, PSRECDEFN B
WHERE A.RECNAME = B.RECNAME
AND A.FIELDNAME = 'PUR_USR_HDR_SBR'
AND B.RECTYPE IN (0, 1, 7)
ORDER BY B.RECTYPE, A.RECNAME
```

See the product documentation for *PeopleTools: PeopleCode Developer's Guide*

Defining PeopleSoft Purchasing Business Units and Processing Options

Understanding Business Units in PeopleSoft Purchasing

A business unit is an operational subset of an organization that tracks and maintains its own set of requisitions and purchase orders. Each business unit has its own way of storing information and its own processing guidelines. PeopleSoft Purchasing business units share supplier, purchase order, and receiving information with PeopleSoft Payables business units in the same SetID.

After you determine how many business units that you need and how to organize them, define them in the PeopleSoft Purchasing system.

Note: The information in this section, which describes some of the essential traits of business units as applied to PeopleSoft Purchasing, can help you determine the best way to define business units for the PeopleSoft Purchasing implementation. PeopleSoft implementation personnel can also help you define the appropriate business unit structure.

Some purchasing transactions use business units as key identifiers. For example, you cannot create a single purchase order that includes items that have different business unit requests. Each business unit that is requesting items generates a separate purchase order.

Define business units in this order:

1. Define generic PeopleSoft business units.
2. Define PeopleSoft General Ledger business units.
3. Link PeopleSoft business units to PeopleSoft Purchasing.
4. Specify requisition-processing and purchase order-processing information for PeopleSoft Purchasing business units.
5. Link PeopleSoft General Ledger business units to PeopleSoft Purchasing for general ledger distribution needs.

Specifying Responsibility

You can establish separate business units to specify areas of responsibility. For example, a department may be responsible for purchasing a particular type of item. You can establish a business unit specifically for this department. Using strategically created business units enables you to group purchases for analysis. The business unit configuration can also help you maintain the required level of accounting control.

Interunit Accounting

PeopleSoft Purchasing interunit accounting enables you to track interunit purchases among PeopleSoft General Ledger business units. If you require this, designate each of the organizational entities as a PeopleSoft General Ledger business unit. If you've centralized the procurement practices, you can define one PeopleSoft Purchasing business unit that can generate charges to each PeopleSoft General Ledger business unit.

PeopleSoft General Ledger Considerations

A PeopleSoft Purchasing business unit must be associated with a PeopleSoft General Ledger business unit, although this does not have to be a one-to-one relationship. You can place multiple PeopleSoft Purchasing business units under one PeopleSoft General Ledger business unit, or you can charge multiple PeopleSoft General Ledger business units from one PeopleSoft Purchasing business unit. Often, the PeopleSoft Purchasing business units will be the same as the PeopleSoft General Ledger business units.

PeopleSoft Payables Considerations

To pass accounting information from PeopleSoft Purchasing to PeopleSoft Payables and through to PeopleSoft General Ledger, you must install PeopleSoft Payables and PeopleSoft Purchasing in the same database. This requirement also applies if you want to use the matching functionality that PeopleSoft software provides.

You do not need a one-to-one relationship between a PeopleSoft Purchasing business unit and a PeopleSoft Payables business unit. One PeopleSoft Payables business unit can process data for many PeopleSoft Purchasing business units, and multiple PeopleSoft Payables business units can create vouchers for one PeopleSoft Purchasing business unit. However, you must configure these business units to share the same set of suppliers.

Suppliers

A business unit can be a subset of the organization, but from purchasing and accounts payable perspectives, a business unit can also represent a group of suppliers.

If you have multiple companies or subsidiaries with unique sets of supplier requirements, consider establishing separate business units for each set of requirements. You can share a set of suppliers across business units, but you cannot share subsets of suppliers. Within a PeopleSoft Purchasing business unit, you can access all of the suppliers in the set that is assigned to that business unit, but you can't exclude subsets of suppliers in that set.

Related Links

[“Understanding PeopleSoft Interunit and Intraunit Functionality” \(Application Fundamentals\)](#)

[“Understanding the Matching Process” \(PeopleSoft Payables\)](#)

Establishing PeopleSoft Purchasing Business Units

To define the PeopleSoft Purchasing business units, use the Purchasing Business Unit component (BUS_UNIT_PM).

This section discusses how to Establish PeopleSoft Purchasing Business Units.

Pages Used to Establish PeopleSoft Purchasing Business Units

Page Name	Definition Name	Usage
<u>Purchasing Definition - Business Unit Definition Page</u>	BUS_UNIT_TBL_PM	Create PeopleSoft Purchasing business units or update existing ones.
<u>RFQ Required Rule Page</u>	RFQ_REQUIRED_RULE	Define and view details about the RFQ required rule.
<u>Standard Comments Page</u>	BUS_UNIT_PM_COMNT	Define standard comments to print on dispatched purchase orders.
<u>Matching Options Page</u>	BUS_UNIT_PM_MATCH	Define matching rules.
<u>Define Dispatch Options Page</u>	BUS_UNIT_PM_IMAGE	Define file directory locations for images that you want to print on purchase orders.
Entry Event Defaults Page	BUS_UNIT_PM_EE	Select default entry events at the business unit level. You can access this page if entry events are enabled.
VAT Defaults Setup Page(value added tax defaults setup)	VAT_DEFAULTS_DTL	Enter VAT defaults for the requisition, purchase orders, RFQs, and procurement cards. If you access this page by clicking the VAT Default link on the Purchasing Definition - Business Unit Definition page, the VAT driver and VAT driver keys are inherited from the PO Business Unit Definition (purchase order business unit definition) component and cannot be changed. If you access this page by using the standard menu navigation, you can specify the VAT driver and any VAT driver keys as applicable.
<u>Copy VAT Defaults From (copy value added tax defaults from) Page</u>	VAT_DFLT_SRCH_COPY	Copy VAT defaults from one business unit to another.
Mobile Receiving Page	BU_OPT_MOBILE_REC	Establish Mobile Receiving Ad Hoc default values.
<u>Purchasing Definition - Business Unit Options Page</u>	BUS_UNIT_TBL_PM2	Create business unit options or update existing ones.

Page Name	Definition Name	Usage
<u>Purchasing Definition - Document Numbering Page</u>	BUS_UNIT_TBL_PM3	Define transaction document autonumbering options.

Purchasing Definition - Business Unit Definition Page

Use the Purchasing Definition - Business Unit Definition page (BUS_UNIT_TBL_PM) to create PeopleSoft Purchasing business units or update existing ones.

Navigation:

Set Up Financials/Supply Chain > Business Unit Related > Purchasing > Purchasing Definition > Business Unit Definition

This example illustrates the fields and controls on the Business Unit Definition. You can find definitions for the fields and controls later on this page.

When you access this page in Add mode, you can enter only the unit description, default SetID, and short description. Enter this information and click the **Create BU** (create business unit) button, which appears only in Add mode, to create the business unit. If you access the page in Update/Display mode, the remaining fields on the page become available for entry.

Field or Control	Description
Process Option	Select the processing option ID for this business unit to be used throughout the procurement cycle. Values are defined on the Purchasing Options - Purchasing Options page. This defines options such as freight terms and payment terms for the business unit.
Location	Select the location code for the physical location of this business unit. The system uses this code to derive the organization address that prints on dispatched transactions. Define values on the Location - Location Definition page.

Field or Control	Description
Billing Location	Select the code for the location where invoices are sent for this business unit. Define values on the Location - Location Definition page. By default, this information appears on transactions that are created for this business unit.
Close Days and Cancel Days	<p>Enter the number of days that a requisition or purchase order, or a canceled requisition or purchase order, must remain open after its last update activity before it is eligible for closure.</p> <p>Cancel and close days enable you to delay the closure of requisitions and purchase orders after they are canceled or entirely received. If you are using PeopleSoft Payables, you can also use cancel and close days to delay closure after requisitions or purchase orders are invoiced.</p> <hr/> <p>Note: The close days value that you define for the business unit is for purchase order reconciliation and has no relationship to the close days value on the Close Short Run control pages.</p> <hr/>
PS/GL (PeopleSoft/general ledger)	Select to enable transactions for this business unit to be posted to the general ledger and to link this business unit to a VAT entity. The GL Unit (general ledger unit) field becomes available for entry.
GL Unit (general ledger unit)	<p>Select a PeopleSoft General Ledger business unit. By default, this business unit appears on transaction distribution lines for this PeopleSoft Purchasing business unit.</p> <p>If you are linking this PeopleSoft Purchasing business unit to a VAT entity, enter the applicable PeopleSoft General Ledger business unit. You can access this link using the PeopleSoft General Ledger business unit. You cannot directly link a PeopleSoft Purchasing business unit to a VAT entity.</p>
AM Unit (asset management unit)	Select the default PeopleSoft Asset Management business unit for the transactions that this PeopleSoft Purchasing business unit creates. When you create a purchasing transaction, the PeopleSoft Asset Management business unit appears by default if the item is an asset. You can override this information at the transaction level.
Capitalize	Select if most of the asset purchases are capital items.
AP Unit (accounts payable unit)	Select the PeopleSoft Payables business unit that is to be used on evaluated receipt settlement (ERS) purchases.
Accrue SUT for ERS orders (accrue sales and use tax for evaluated receipt settlement orders)	Select if sales and use tax (SUT) should accrue for any ERS orders that this business unit creates.

Field or Control	Description
SS Unit (strategic sourcing unit)	<p>Select the default PeopleSoft Strategic Sourcing (SS) business unit that is to be used for this PeopleSoft Purchasing business unit.</p> <hr/> <p>Note: When you enter the same PeopleSoft Strategic Sourcing business unit for multiple PeopleSoft Purchasing business units, PeopleSoft Strategic Sourcing copies requisitions from multiple PeopleSoft Purchasing business units into an event.</p>
Rate Type	<p>Select the rate type to be used for currency conversion. By default, the currency code and rate type apply to all purchasing transactions for this business unit.</p>
Tax supplier	<p>Select to integrate with a third-party tax supplier for tax processing. The system calculates tax from the third-party tax supplier (Vertex or Taxware) when it creates purchase orders online or when sourcing to a purchase order.</p> <p>When you select this check box, depending on the tax supplier that you select, certain fields appear in the group box below this check box.</p> <hr/> <p>Note: This check box is available only if you select a tax supplier (Vertex or Taxware) on the Installation Options - Overall page.</p>

Taxware Group Box

This group box is available only if third-party Taxware or Vertex software is installed, and if the **Tax supplier** check box is selected.

Field or Control	Description
Company	<p>Enter the tax supplier company code. This field appears for these third-party tax products: Vertex Q Series, Vertex O Series, and Taxware Sales and Use Tax.</p> <p>The company code that you enter in this field passes information to the third-party Taxware or Vertex software as input parameters.</p>
Organization	<p>Enter the organization. This field appears instead of the Company field for the Taxware Enterprise third-party tax product.</p>

Field or Control	Description
Division	<p>Enter the tax supplier division code. This field appears for these third-party tax products: Vertex Q Series, Vertex O Series, and Taxware Sales and Use Tax.</p> <p>The division code passes information to the third-party Taxware or Vertex software as input parameters.</p>
Department	<p>Enter the tax supplier department. This field appears only for the Vertex O Series third-party tax product.</p> <p>The department code passes information to the third-party Taxware or Vertex software as input parameters.</p>
Use Freight Product Code	<p>Select this option to associate the freight with the tax supplier product code and to indicate applicable tax rates.</p> <hr/> <p>Note: This field is available only for Taxware.</p> <hr/>

RFQ Required Rule

Use this group box to define a threshold line amount and RFQ required rule that, when the amount is exceeded or the rule is met, requires a requisition item to go through the RFQ cycle before it is included on a purchase order.

Field or Control	Description
Line Amount Threshold	<p>Enter a threshold amount. The threshold amount is the line amount limit that triggers that an RFQ is required to source the requisition. When a user exceeds the threshold amount for a requisition line, the system resets the RFQ Required check box to be selected for that line on the requisition.</p> <p>For example, if you are buying something and it costs more than 1000 USD, the system requires that you get a couple of bids before it will source it to the recommended or specified supplier.</p>
RFQ Required Rule (request for quote required rule)	Select an RFQ rule from the rules defined in the RFQ Required Rules component.
	Click the Go To RFQ Required Rule button to access the RFQ Required Rule page, where you can define and view details about the RFQ required rule.

Field or Control	Description
Mobile Receiving	Use this link to access the Mobile Receiving page. See “Mobile Receiving Page ” (PeopleSoft Mobile Inventory Management).

Related Links

[Purchasing Options Page](#)

[Preparing PeopleSoft Purchasing VAT Environments](#)

RFQ Required Rule Page

Use the Request For Quote (RFQ) Required Rule page (RFQ_REQUIRED_RULE) to define and view details about the RFQ required rule.

Navigation:

Click the **Go To RFQ Required Rule** button on the Purchasing Definition - Business Unit Definition page.

This example illustrates the fields and controls on the RFQ Required Rule. You can find definitions for the fields and controls later on this page.

Use this page to define ChartField values that will set the **RFQ Required** option to *Yes* for requisitions created online or through the Requisition Loader process. You can also define the RFQ Required option in the Purchasing Item Attributes or Item Category component when an RFQ is required any time that the item or category is specified on a requisition.

Some organizations require RFQ processing whenever a specific ChartField value is referenced on a requisition. For example, whenever a specified project is entered on a requisition, the funding requirements of the project require that the request go out for bid. The RFQ Required Rule page enables you to define the RFQ Required flag based on that ChartField value. When a requisition is created, the system checks the ChartField values that you define on this page and sets the **RFQ Required** option accordingly.

Field or Control	Description
Set "RFQ Required Flag" to "No" if Contract exists	Select to bypass the RFQ cycle if a contract exists. <hr/> Note: The system ignores the Default Contract on Req check box setting when the system applies the RFQ rule and you select this check box. <hr/>
Default the found Contract ID to Requisition line	Select to supply by default the contract ID to the requisition line.

Related Links

[Understanding RFQs in PeopleSoft Purchasing](#)

Standard Comments Page

Use the Standard Comments page (BUS_UNIT_PM_COMNT) to define standard comments to print on dispatched purchase orders.

Navigation:

Click the **Edit Comments** link on the Purchasing Definition - Business Unit Definition page.

The comments that you enter on this page are printed on dispatched purchase orders if you select the **Print BU Comments** (print business unit comments) check box on the Dispatch Purchase Orders page. You can set up these comments to contain the terms and conditions for purchase orders for this business unit.

Related Links

“Setting Up Standard Comments” (PeopleSoft Source to Settle Common Information)

[Understanding Purchase Order Dispatch](#)

Matching Options Page

Use the Matching Options page (BUS_UNIT_PM_MATCH) to define matching rules.

Navigation:

Click the **Matching** link on the Purchasing Definition - Business Unit Definition page.

Select the default matching rules for this business unit. If matching rules are defined at the supplier level, those rules will override business unit-level matching rules. You can override both the business unit and supplier level matching rules on the purchase order.

Related Links

“Establishing Matching and Document Association Options” (PeopleSoft Source to Settle Common Information)

Define Dispatch Options Page

Use the Define Dispatch Options page (BUS_UNIT_PM_IMAGE) to define file directory locations for images that you want to print on purchase orders.

Navigation:

Click the **Define Dispatch Options** link on the Purchasing Definition - Business Unit Definition page.

This example illustrates the fields and controls on the Define Dispatch Options. You can find definitions for the fields and controls later on this page.

Define Dispatch Options
✕

[Help](#)

Print Image on Purchase Order

PO Dispatch Image Location:

Print Signature on PO

PO Dispatch Signature Location:

Template ID

Default Sender Email:

<i>Field or Control</i>	<i>Description</i>
Print Image on Purchase Order and PO Dispatch Image Location	Select to print an image (logo) on purchase orders, and enter the directory location of the image file.
Print Signature on PO and PO Dispatch Signature Location	Select to print a signature on purchase orders, and enter the directory location of the signature file.

Field or Control	Description
Template ID	<p>Select the report template to use with this business unit to dispatch a purchase order. You use the report template to identify a BI Publisher report layout. The template provides a common report layout when dispatching purchase orders for both PeopleSoft eProcurement and Purchasing.</p> <p>If the Template ID field on this page is blank, then the system uses the default template on the BI Publisher Report Definition page (Reporting Tools > BI Publisher > Report Definition > Template).</p> <p>This field appears only if you have selected the Enable XML Publisher check box on the Purchasing page of the Installation Options component. This check box selects the Oracle BI Publisher to format and print purchase orders during the dispatch process for both PeopleSoft Purchasing and PeopleSoft eProcurement. You use Oracle BI Publisher for reporting. It is a Java-based product within the Oracle Fusion Middleware family.</p>
Default Sender Email	<p>For PO dispatch email notification, select a sender email id.</p> <ul style="list-style-type: none"> • Blank: If the blank option is selected, the default sender email is considered from the “Installation Options - Purchasing Page” (Application Fundamentals). • Buyer: Select to send the PO dispatch email from the buyer's email address. • Specific: Select to enter an email id to send the PO dispatch email from that specific id. <hr/> <p>Note: If <i>Buyer</i> or <i>Specific</i> is selected, it overrides the <i>Default Sender Email</i> configuration on the “Installation Options - Purchasing Page” (Application Fundamentals).</p> <hr/>

Image Locations

Consider these points when working with images and their locations:

- For Structured Query Report (SQR) processes to work as designed, you must store associated images in external files.
- The folder in which you store external image files must be shared.
- For Microsoft Windows NT environments, define the directory locations using the universal naming convention (for example, \\server_name\folder_name\...).

When you run the PO Dispatch/Print (purchase order dispatch and print) process (POPO005), the image file to print on the purchase order is determined by the output format that you select on the Process Scheduler Request page. The PO Dispatch/Print process takes the image file name that you enter here and parses out the file extension information. The process uses this file extension to determine the image type that the PRINT-IMAGE command uses.

This table describes file extension values and their compatible image types to be used in the PRINT-IMAGE command:

File Extension	Image Type
No extension	BMP-FILE
.BMP	BMP-FILE
.JPG	JPEG-FILE
.GIF	GIF-FILE
.EPS	EPS-FILE
Others	HPGL-FILE

The next two tables describe output type options that are available for the PO Dispatch/Print process on the Process Scheduler Request page, along with their compatible output formats, output file extensions, and image types.

This first table represents output types for web, file, and email:

Output Format	Output File Extension	Image Type That Works
CSV	.CSV	None
HP	.LIS	HPGL-FILE
HTM	.HTM	JPEG-FILE, GIF-FILE, BMP-FILE
LP	.LIS	None
OTHER	.LIS	None
PDF	.PDF	JPEG-FILE
PS	.LIS	EPS-FILE
SPF	.SPF	BMP-FILE

This table represents output types for a printer:

Output Format	Output File Extension	Image Type That Works
HP	None	HPGL-FILE
LP	None	None
OTHER	None	None
PS	None	EPS-FILE

Note: The HPGL image type works with HP LaserJet printers.

Printing Images

To print an image:

1. Check the PSSQR.INI file to verify that the SQRDIR is set to the path where the SQR executables are stored.
2. Ensure that the drive that is storing the image has the correct permissions set.
3. Verify that the image is not corrupt.
4. In a UNIX environment, you can print only EPS-FILE image types.

See the product documentation for *PeopleTools: BI Publisher for PeopleSoft*.

Related Links

“Preparing to Dispatch by Fax and Email” (PeopleSoft Source to Settle Common Information)

Copy VAT Defaults From (copy value added tax defaults from) Page

Use the Copy VAT Defaults From (copy value added tax defaults from) page (VAT_DFLT_SRCH_COPY) to copy VAT defaults from one business unit to another.

Navigation:

- Click the **VAT Default** link on the Purchasing Definition - Business Unit Definition page.
- **Set Up Financials/Supply Chain > Common Definitions > VAT and Intrastat > Value Added Tax > VAT Defaults**

You can insert rows for any or all of the VAT driver keys, as well as the VAT country or state. You can also delete any existing rows.

Field or Control	Description
Copy Values to New Rows	If you are inserting a row for a VAT driver key, select this check box to copy all the VAT defaults from the previous row to the new row. Otherwise, all VAT default fields for the new row will be blank.
Copy Defaults From	Click to access the VAT Defaults Copy From page, which you can use to copy VAT default specifications from another key combination for the same VAT driver.
Return to VAT Defaults Sub-Search (return to value-added tax defaults sub-search)	Click to return to the Purchasing Definition component.
VAT Reporting Country (value-added tax reporting country)	Select the country or countries for which you are defining VAT defaults. For regular defaults, defaults are obtained for the VAT reporting country. For service VAT treatment defaults, defaults are obtained for the supplier's location country.
Defaulting State	As applicable, select the state for which you want to define VAT default values.
Default Details	Enter the effective date, status and, if applicable, the VAT SetID.
VAT Apportionment Control (value-added tax apportionment control)	<p>When you create purchase orders for a PeopleSoft Purchasing business unit, the system selects a default business unit for VAT recovery and rebate calculations based on this value. Business units have different VAT recovery and rebate percentages based on their locations. Values are:</p> <p><i>Dist GL BU</i> (distribution general ledger business unit): Selects the PeopleSoft General Ledger business on the purchase order distribution line.</p> <p><i>Txn BU</i> (transaction business unit): Selects the business unit on the purchase order header.</p> <p><i>Txn GL BU</i> (transaction general ledger business unit): Selects the PeopleSoft General Ledger business unit on the purchase order header.</p>

Note: The remaining fields on the page vary based on the combination of VAT driver and VAT driver keys. See the section on VAT fields for details about the fields and VAT drivers that appear.

Related Links

“Understanding VAT” (PeopleSoft Global Options and Reports)

Copy VAT Defaults From (copy value added tax defaults from) Page

Use the Copy VAT Defaults From (copy value added tax defaults from) page (VAT_DFLT_SRCH_COPY) to copy VAT defaults from one business unit to another.

Navigation:

Click the **Copy Defaults From** link on the VAT Defaults Setup page.

<i>Field or Control</i>	<i>Description</i>
Search Criteria	Enter the criteria by which you want to search.
Search	Click to retrieve the results based on the criteria entered.
Copy From	<p>Select a link for any of the results returned to view the details of the VAT setup on the Copy VAT Defaults Setup page. When you have viewed the details, you can click Copy to copy the VAT setup. The system returns you to the VAT Defaults Setup page with the copied fields.</p> <p>Or you can select the appropriate option for any of the results returned and click Copy to copy from that row. The system returns you to the VAT Defaults Setup page with the copied fields.</p>

Purchasing Definition - Business Unit Options Page

Use the Purchasing Definition - Business Unit Options page (BUS_UNIT_TBL_PM) to create PeopleSoft Purchasing business units or update existing ones.

Navigation:

Set Up Financials/Supply Chain > Business Unit Related > Purchasing > Purchasing Definition > Business Unit Options

This example illustrates the fields and controls on the Purchasing Definition - Business Unit Options page (1 of 2). You can find definitions for the fields and controls later on this page.

The screenshot displays the 'Business Unit Options' page for Unit US001 (US001 NEW YORK OPERATIONS). The page is divided into several sections:

- Business Unit Definition:** Unit US001, US001 NEW YORK OPERATIONS. *PO Item Supp Security Option: No Edit Required. DUNS Number: 12345. *PO Price Edit: Warning. Tax Exempt ID: (empty).
- Origin:** ONL. Tax Exempt.
- Checkboxes:**
 - Allow Business Item Attributes
 - Error on Min/Max Quantity
 - Allow Requisition Deletion
 - Allow Multicurrency Reqs
 - Default Contract On Req
 - Calculate VAT On Req
 - Allow GLN Display
 - Split PO by Ship To
 - Allow PO Deletion
 - Allow Multicurrency PO
 - Default Contract on PO
- *PO Close Contract Option:** Error
- Sourcing Controls:** % Unit Price Tolerance Over: 25.00, Tolerance Under: 25.00.
- When Contract is Specified on Requisition:**
 - Allow Req Consolidation
 - Allow Source to Inventory
- Liquidate Method:** Allow Liquidate by Quantity when Distribute by Quantity. *Default Liquidate Method: Amount.
- Item Substitution Controls:**
 - Enable Item Substitution
 - Allow Item Substitute Online Search:**
 - Requisition
 - Requisition Selection and Purchase Order
 - Allow Auto Item Substitution:**
 - Requisition
 - Requisition Selection
 - PO Sourcing and Purchase Order

This example illustrates the fields and controls on the Purchasing Definition - Business Unit Options page (2 of 2). You can find definitions for the fields and controls later on this page.

The screenshot displays the continuation of the 'Business Unit Options' page, focusing on the following sections:

- PO Close Short Controls:** PO Close Short Rule ID: STANDARD. Close Short Set Override.
- Receiving Controls:**
 - Receipt Date Adjustment: 10. *Receipt Allocation Type: First In First Out.
 - Receipt Date Exchange Rate: PO Date. *Delivery Signature Required: Default to Installation value.
 - Separate Inspection
 - Accrue PO Receipts
 - Accrue Federal Inventory Receipt
 - Allow Receipt Load Cascade
 - Accrue Non/PO Receipts
 - Allow Curr UOM Conv Rate
 - Receipt Close Delay Days: (empty)
- Return To Vendor Controls:**
 - RTV Inventory Ship Option: Manual. RTV Inventory Destroy Option: Manual.
 - RTV Dispatch Option: Manual.
 - RTV Adjust Source
 - RTV Reopen PO
 - RTV Adjust Fees
 - Notify Inventory Manager
- Procurement Card Controls:** Receipt Required. Threshold Amount: 300,000 USD.

Buttons at the bottom: Save, Return to Search, Notify, Add, Update/Display.

Field or Control	Description
PO Item Supplier Security Option (purchase order item supplier security option)	<p>Select a value to indicate how the system handles edits to item and supplier combinations on purchase order lines:</p> <p><i>Edit Required Must Use Item ID:</i> A valid item ID with an established item and supplier relationship is required for each purchase order line. You can't order an item by description and must use an item that is defined in the Item supplier tables.</p> <p><i>Edit Required When Use Item ID:</i> An item ID isn't required on the purchase order line, and you can order an item by description. However, if you order by item ID, the item must exist in an Item supplier table. The difference between this and the <i>No Edit Required</i> value is that you are restricted to items that have an active purchase order supplier established.</p> <p><i>No Edit Required:</i> An item ID isn't required on the purchase order line, and you can order an item by description. If you order by item ID, you can order any item that is established in the Item tables for PeopleSoft Purchasing, even if no item and supplier relationship is established.</p>
Origin	<p>Select the origin code to be used on ERS invoices so that you can process ERS matching by origin in PeopleSoft Payables. PeopleSoft Purchasing can also use this code for reporting to identify transaction origins.</p>
Receipt Date Adjustment	<p>Enter a number of days by which receiving dates can be adjusted. If you do not specify a value, receiving dates by default become the current system date and cannot be changed.</p> <p>For example, entering 7 enables you to enter a receipt date that is plus or minus seven days from the current date. This is useful when an item is received and you do not have time to enter the receipt on the same business day. Without a receipt date adjustment value, you must enter the receipt using the next business day's date. Consequently, the entry could show a late delivery in the records when the delivery was actually on time.</p>
DUNS Number (Dun and Bradstreet number)	Enter a DUNs number.

Field or Control	Description
Receipt Allocation Type	<p>Select the method to allocate the receipt amount across the distributions for the schedule for the received items. Values are:</p> <p><i>FIFO</i> (first-in-first-out): Purchase order quantities are fulfilled based on the sequence in which they are added to the purchase order schedule. This is the default receipt allocation type.</p> <p><i>Prorate</i>: Purchase order quantities are fulfilled by calculating the percentage of received quantity to the total purchase order line quantity. The received quantity is then allocated to each distribution line using that percentage. This is for noninventory items only.</p> <p>For example, if the schedule quantity is 300 and the schedule has three distribution lines, each distribution has a quantity of 100. If you receive a quantity of 75, each distribution is allocated a received quantity of 25.</p> <p><i>Specify</i>: Allocations are fulfilled by the user manually entering the receipt quantity or amount at the distribution level when receiving purchase order schedules with multiple distributions. This enables the specific allocation of the receipt quantity or amount by open purchase order distribution quantity or amount.</p> <p><i>Split Distributions</i>: The receipt quantity is allocated to the distributions in the same manner as the prorated type and the resulting receipt asset lines are all assigned to the same asset. For serialized items, each individual unit is split across all the distributions and grouped together under a separate asset.</p> <hr/> <p>Note: The receipt allocation type that you select here appears as the default when you create a receipt for this PeopleSoft Purchasing business unit.</p> <hr/> <hr/> <p>Note: The Prorate and Split Distributions allocation types are hidden when the item is designated for inventory.</p> <hr/>
Receipt Date Exchange Rate	<p>Select the date on which to base the receipt date exchange rate for purchase order receipts and receipts that are not purchase order receipts.</p> <p>Values are:</p> <p><i>PO Date</i> (purchase order date): Select to base the exchange rate on the purchase order header date.</p> <p><i>Receipt Date</i>: Select to base the exchange rate on the receipt date.</p>

Field or Control	Description
<p>Accrue Federal Inventory Receipt</p>	<p>Select this check box to perform the following actions:</p> <ul style="list-style-type: none"> • Allow receipt accruals for inventory related receipts to be processed. • The Purchasing receipt budget checking process will not budget check receipt accruals for inventory. • The Accrue Receipts process will mark proprietary accounting entries and reversals for receipt accruals to not be sent to the GL. The proprietary entries can be used by the Entry Event processor to generate budgetary accounting entries and journal generate to GL. However, if the check box is not selected, the Accrue Receipts will not process inventory receipt accruals. <hr/> <p>Note: The Accrue Federal Inventory Receipt check box will be made available, upon selecting the Accrue PO Receipts or Accrue Non/PO Receipt, and also if the Purchasing Entry Event is “Required” or “Optional” on the Installation Options - Entry Event Page .</p>
<p>PO Price Edit</p>	<p>Select the purchase price edit: Values are:</p> <ul style="list-style-type: none"> • <i>Error</i> • <i>None</i> • <i>Warning</i>
<p>RTV Dispatch Option (return to vendor dispatch option)RTV dispatch option</p>	<p>Select the dispatch method to use as this business unit's default value for the return to vendor (RTV) functionality. This functionality determines the default value for the return to vendor function on how the RTV will be dispatched to the supplier. The system uses the dispatch options that you define for the business unit as default values when user preferences are set by default to the business unit RTV dispatch option. When you save information on this page, the settings you define become effective.</p> <p>RTV dispatch option values for a business unit are:</p> <p><i>Dispatch When Shipped:</i> Select to submit the RTV Dispatch process automatically when all lines on the RTV have been shipped.</p> <p><i>Manual:</i> Select to indicate that the RTV transaction requires collaboration between groups and that you must submit the RTV Dispatch/Print process by using the Process Scheduler. This is the default value for the field.</p> <p>See Entering RTV Transactions.</p> <p>See Inventory Return Records, Inventory Return Records.</p>

Field or Control	Description
<p>RTV Inventory Ship Option (return to vendor inventory ship option) return to vendor inventory ship option</p>	<p>Select the return to vendor ship option that you want to use as this business unit's default value for the Inventory Process field on the RTV line.</p> <p>RTV Inventory ship option values are:</p> <p><i>Express:</i> Select to use the RTV express option to process purchasing and inventory data collection transactions at the same time. This means that you can perform inventory issue (automatic issue) or adjustment (automatic adjustment) actions from within the Purchasing RTV component.</p> <hr/> <p>Note: The <i>Express</i> value will be automatically overridden on the RTV line if the associated Inventory business unit is defined as a Warehouse Management System (WMS) type. You define the warehouse setting using the Use External Warehouse Control check box on the Business Unit Options page for Inventory.</p> <hr/> <p><i>Fulfillment:</i> Select to set the user's preference to perform Inventory fulfillment processing for RTV transactions. This enables the user to create an Inventory material stock request transaction and to process it through Inventory fulfillment processing. The <i>Fulfillment</i> value is valid only for RTV processing when RTV line disposition is Ship.</p> <p><i>Manual:</i> Select to indicate that the RTV ship transaction must be completed manually. This option requires that you perform the Inventory Express manually to remove the items from inventory.</p>
<p>RTV Inventory Destroy Option (return to vendor inventory destroy option) return to vendor inventory destroy option</p>	<p>Select the return to the vendor destroy option that you want to use for this business unit's default value for the Inventory Process field on the RTV line.</p> <p>RTV Inventory destroy option values are:</p> <p><i>Express:</i> Select to use the RTV express option for the RTV lines that have a disposition of Destroy. This means that the user can perform Inventory adjustment (automatic adjustment) actions from within the Purchasing RTV component.</p> <p><i>Manual:</i> Select to indicate that the RTV transaction must be manually adjusted within inventory. When you use the <i>Manual</i> option, the system does not perform the RTV adjustment function. You must use the Inventory Adjustment component to adjust balances for inventory returns that are to be destroyed.</p>
<p>PO Close Short Rule ID</p>	<p>Select the PO Close Short Rule ID from a prompt list of available Rule IDs. The Rule ID is needed for the close short process to determine a rule to close short the PO. The close short will not be processed if the ID is blank.</p>

Field or Control	Description
Delivery Signature Required	<p>Select an option that indicates that a signature is required from the individual receiving a Mobile Inventory delivery for this receiving business unit. Options include:</p> <ul style="list-style-type: none"> • <i>Default to Installation value:</i> Select to indicate that this business unit should use the option selected on the Installation Options - Mobile Inventory page. • <i>No:</i> Select to indicate that this business unit does not require delivery signatures. • <i>Yes:</i> Select to indicate that this business unit requires delivery signatures. <p>See smin, Using Mobile Delivery, Processing Deliveries Using Mobile Devices, Adding a Signature to a Delivery</p>
Receipt Close Delay Days	Indicates the minimum number of days that must pass since a receipt was last updated to make it eligible for closing.
Receipt Required	Select the Receipt Required check box to indicate that any transaction line amount greater than the threshold amount will require attachments.
Threshold Amount	<p>Enter the amount limit for a requisition line.</p> <hr/> <p>Note: This field becomes editable if you select the Receipt Required check box.</p> <hr/>

Additional Business Unit Options

Field or Control	Description
Allow Multicurrency Reqs (allow multicurrency requisitions)	Select to enable requisition lines with different currencies. Item-supplier pricing may be in a currency other than the business unit currency. The supplier currency is automatically converted to the business unit currency for requisition approval purposes. When the requisition lines are sourced to a purchase order, the system uses the requisition currency (if sourced using Requisition Selection with Define PO = 'Y'); otherwise, the supplier currency is used.
Calculate VAT On Req (calculate value-added tax on requisitions)	Select to enable VAT to process and calculate onto requisitions and to pass the VAT information from the requisition to other transactions in the procurement process.

Field or Control	Description
<p>Allow Multicurrency PO (allow multicurrency purchase order)</p>	<p>Select to enable purchase orders to be entered in the supplier currency, even if the supplier currency differs from the business unit currency. If you do not select this check box, and requisitions are entered in a currency different from the business unit currency, the system creates purchase orders in the business unit currency. The system converts requisition prices and amounts to the business unit currency of the purchase order.</p>
<p>Default Contract on Req (default contract on requisition)</p>	<p>Select to automatically supply a contract to a requisition. The system searches for and ensures that the correct contract is selected for use with the requisition. Along with selecting this check box, the system verifies that the Auto Default check box is selected on the Contract page. This makes the contract available to automatically default onto requisition and purchase order transactions.</p> <p>You can override contracts that have been selected by the system. This enables you to receive contract prices for requisition items and to more accurately track budgets and pre-encumbrance balances.</p> <p>See Contract Pricing for Requisitions and Purchase Orders.</p>
<p>Allow Business Item Attributes</p>	<p>Select to enable attributes to be established for any item in this business unit. The business unit item attributes override those that you establish for the item in the Item Definition - Purchasing Attributes component.</p> <hr/> <p>Note: Selecting the Allow Business Item Attributes check box is useful if you must maintain item-specific attributes by business unit as well as by SetID. For example, suppose that several of the business units normally purchase the same item, but each business unit has a different lead time for this item. If you enable business unit item attributes, the lead time that the business unit sets overrides the default lead time, and each business unit can set a different lead time for the same item.</p> <hr/>

Field or Control	Description
<p>Default Contract on PO(default contract onto purchase order)</p>	<p>Select to indicate that the system should automatically search for appropriate contracts for purchase order lines. The check box applies only to manually created purchase orders, and not orders created using a batch process. This automates the process of selecting the most appropriate contract for use with manually created purchase orders. The default value for the field is deselected.</p> <p>If you select to search for contracts, the system begins its search for contracts with process types of Purchase Order, General, or Release-To-Single PO Only and that are in a current version with an Approved status. If the check box is deselected, the system does not search for a contract. If multiple contracts exist, the system selects the contract where the status is Approved, the version is current, and with the most recent (but not future) contract begin date.</p> <p>After validating the contract and using it on the transaction, the system:</p> <ul style="list-style-type: none"> • Updates released amounts and quantities. • Creates a contract event. • Updates the transaction with contract information. <p>This option does not apply to PeopleSoft Services Procurement project roles on the contract. Services Procurement searches for an applicable contract on the work order, and uses it on a purchase order regardless of the Default Contract Flag check box value. This option also does not apply to blanket purchase orders.</p> <p>See Contract Pricing for Requisitions and Purchase Orders.</p>

Field or Control	Description
<p>Allow Receipt Load Cascade</p>	<p>Select to enable this business unit to receive quantities for a purchase order line and cascade that quantity over multiple schedules. For example, assume that you have one purchase order line for 150 items and three schedules for 50 items, each to be delivered a month apart. When the first shipment arrives for receiving, a quantity of 75 items exists. Rather than returning 25 of the items and waiting for the next shipment, you can receive 50 on the first schedule and cascade 25 to the second schedule. In effect, you receive these 25 items early and deduct them from the second schedule. When the next shipment arrives, you receive the remaining 25 items. You can cascade line quantities until an entire order is filled.</p> <hr/> <p>Note: The Allow Receipt Load Cascade check box is applicable only when you are using the Receiver Load Application Engine process (PO_RECVLOAD) to build receivers from loaded data. This check box is typically used to load bar code transactional data into the system, which builds the data into receivers and cascades the quantities down to the purchase order lines and schedules appropriately.</p>
<p>Accrue PO Receipts</p>	<p>Select to enable this business unit to accrue receipts for expensed items without invoices. When you run the Receipt Accrual process (PO_REVACCR), receipts for which you have not yet received an invoice are included in the process.</p>
<p>Accrue Non/PO Receipts (accrue non/purchase order receipts)</p>	<p>Select to enable this business unit to accrue receipts for noninventory items without a purchase order.</p>
<p>Separate Inspection</p>	<p>Select to require that inspection information be entered apart from receiving information. Inspections can be performed on the receiving dock or in the inspection location to which the inventory item is routed.</p>
<p>Notify Inventory Manager</p>	<p>Select to include inventory workflow notifications for return to vendor processing. The system notifies users defined in the INV MGR role that goods are ready to be shipped back to the supplier. The system generates an email notification when the return disposition is Ship or Destroy for Inventory RTVs. You can override the value for individual vendors using the Return to Vendor Defaults page in PeopleSoft Purchasing.</p> <p>See Return To Vendor Defaults Page.</p>

Field or Control	Description
Tax Exempt	Select to enable purchasing documents that are created in this business unit to be exempt from sales and use tax.
ID	Enter the tax exempt identifier. The ID field becomes available when you select the Tax Exempt check box.
RTV Adjust Source (return to vendor adjust source)	Select to enable the adjustment of source documents when items are returned to the supplier for replacement. If you select this check box, the net receipt quantity is adjusted down by the return to vendor (RTV) quantity using this formula: (Net Receipt Quantity) = (Net Receipt Quantity) – (RTV Qty)
Allow Curr UOM Conv Rate (allow current unit of measure conversion rate)	Select to calculate the purchase order standard quantity using the current conversion rate at receiving or time of purchase order change. If you do not select this check box, or if you do not select the option at receiving or purchase order change, the system uses the purchase order conversion rate. Note: This check box is available only when PeopleSoft Inventory is installed. If PeopleSoft Inventory is not installed, receiving always uses the current conversion rate and won't update the purchase order distribution. Purchase order change uses the current conversion rate and updates the purchase order distributions.
RTV Adjust Fees (return to vendor adjust fees)	Select to include adjustment fees when items are returned to the supplier. These fees could include restocking fees or other fees that are imposed on the transaction.
Allow PO Deletion (allow purchase order deletion)	Select to enable authorized users to delete purchase orders in the selected business unit.
RTV Reopen PO (return to vendor reopen purchase order)	Select to change the purchase order schedule status to <i>Open</i> when items are returned to the supplier for replacement. When the items are reshipped, this check box enables you to receive the items against the original schedule. Note: If you are using commitment control, you can't reopen closed purchase orders, and you will not be able to select this check box. This functionality is not available when you are using commitment control.

Field or Control	Description
Allow Requisition Deletion	Select to enable authorized users to delete requisitions in the selected business unit.
Close Short Override	Select to enable the Close Short Set Option for overriding on the Close Short Workbench.
Allow GLN Display	Select this check box to display the GLN fields on the online purchase order and requisition. The GLN fields will be hidden in case the Allow GLN Display check box is deselected.
Split PO by Ship To	<p>Select to direct the sourcing programs to create separate purchase orders for each unique Ship To location. Selecting this check box also restricts purchase orders created online to a single Ship To location although this can be overridden on the supplier or on an individual PO.</p> <hr/> <p>Note: One-time use addresses and addresses associated with direct shipments or direct receipts will not be segregated by the sourcing programs. Furthermore, PO's or Requisitions containing any of these will never be restricted to a single Ship To Location.</p> <hr/> <p>Note: If user wants to create Purchase order of same Ship To that belong to same state then it is recommended to select "Split PO by Ship To" check box for GST enabled Purchasing Business Unit. See “Understanding the India Goods and Services Tax (GST)” (PeopleSoft Global Options and Reports)</p>

Field or Control	Description
<p>PO Close Contract Option</p>	<p>Displays the values <i>Error</i>, <i>None</i>, and <i>Warning</i>. When you are trying to close purchase orders with remaining contract amount or quantity, the system issues an error or a warning message on the Buyer's WorkBench based on the selected value.</p> <p><i>Error</i>: If the selected PO Close Contract Option is <i>Error</i>, then the check box in the Not Qualified Section on the Buyer's Workbench – Processing Results page is disabled. The log displays the exception. As the check box is disabled, you cannot override the exception. This way you can avoid closing such POs. Instead, you can use the PO Close Short process to release the amounts and quantities to the contract.</p> <p>For more information on PO Close Short process, see Running the Close Short Process.</p> <p><i>Warning</i>: : If the selected PO Close Contract Option is <i>Warning</i>, then the check box in the Not Qualified Section on the Buyer's Workbench – Processing Results page is enabled. When you select the check box, a warning message is displayed indicating that the PO line has remaining amounts or quantities to be released back to the contract. You can either perform the PO Close Short process as suggested in the message or ignore it. The exception is displayed in the log. You can override the exception and close the PO.</p> <p><i>None</i>: If the PO Close Contract Option is <i>None</i>, then the check box in the Not Qualified Section on the Buyer's Workbench – Processing Results page is enabled. Selecting the PO does not display any message. The exception is displayed in the log. You can override the exception and close the PO.</p> <hr/> <p>Note: The purchase order reconciliation process identifies the PO lines with remaining quantity or amount, which have a contract and generates the exception mentioned above. The Buyer's WorkBench works based on the BU setup and the exception logged into the exception table.</p> <hr/> <p>The exception is not applicable for those PO lines which are:</p> <ul style="list-style-type: none"> • Fully received and does not have a voucher for the PO line. • Fully received and vouchered. <p>Displays the exception for the PO Lines - without matching enabled:</p> <ul style="list-style-type: none"> • Partially received and vouchered the receipt fully.

<i>Field or Control</i>	<i>Description</i>
	<ul style="list-style-type: none"> • Partially received and vouchered the receipt partially. • Fully received and partially vouchered. • Not received/receiving not required but partially vouchered. • Not Received/receiving not required and not vouchered. <p>Displays the exception for the PO Lines - matching enabled:</p> <ul style="list-style-type: none"> • Partially received and vouchered the receipt fully. • Partially received and vouchered the receipt partially. • Fully received and partially vouchered. • Not received/receiving not required but partially vouchered. • Not Received/receiving not required and not vouchered.

Sourcing Controls

<i>Field or Control</i>	<i>Description</i>
% Unit Price Tolerance/Tolerance Over (percent unit price tolerance/tolerance over) and % Unit Price Tolerance/Tolerance Under (percent unit price tolerance/tolerance under)	Enter the percentage over and under by which the purchase order price can vary from the requisition price. By default, these values appear on requisitions that are created for this business unit.

When Contract is Specified on Requisition

<i>Field or Control</i>	<i>Description</i>
Allow Req Consolidation	Select to allow requisition consolidation when a contract ID is present on the requisition line.
Allow Source to Inventory	Select to allow inventory sourcing when a contract ID is present on the requisition line.

Item Substitution Controls

<i>Field or Control</i>	<i>Description</i>
Enable Item Substitution	<p>Select this check box to enable item substitution for this Purchasing business unit. If you enable item substitution, you must also select at least one check box in the Allow Item Substitute Online Search or Allow Auto Item Substitution group boxes.</p> <hr/> <p>Note: Upon selecting the Enable Item Substitution check box, all the Item Substitute fields will be enabled for entry on the Requisition, Req Selection/Req Expediter, Sourcing Workbench, Purchase Order, and Receipt pages, and on other applicable components for this business unit.</p>
Allow Item Substitute Online Search	The options in this section allows item user to access online search for item substitutions on the Requisition and/or during Requisition Selection and on the Purchase Order.
Allow Auto Item Substitution	Select to enable automatic item substitution on the Requisition, during Requisition Selection, and/or during PO Sourcing and on the Purchase Order.

Liquidate Method

<i>Field or Control</i>	<i>Description</i>
Allow Liquidate by Quantity when Distribute by Quantity	Select to indicate that the purchase order business unit is liquidated by quantity when distributed by quantity. If you do not select this check box, the Comm. Cntrl. Budget Processor process automatically liquidates pre-encumbrance and encumbrance balances by amount only.

Note: The installation must include commitment control to use this option.

<i>Field or Control</i>	<i>Description</i>
Default Liquidate Method	Select a default liquidate method for the purchase order business unit. You can liquidate by quantity or amount.

Note: You must select the **Allow Liquidate by Quantity when Distribute by Quantity** check box to define a quantity default liquidate method.

Related Links

[Understanding Requisition Change Tracking](#)

[Understanding Inspections](#)

[Understanding the Purchase Order Sourcing Business Process](#)

[Understanding Receipt Accrual](#)

“Creating Change Templates” (PeopleSoft Source to Settle Common Information)

“Creating Change Templates” (PeopleSoft Source to Settle Common Information)

“Defining Origin Codes” (PeopleSoft Source to Settle Common Information)

“Understanding Online POAs” (PeopleSoft eSupplier Connection)

[Maintain Receipts - Receipt Distributions for Line Page](#)

Purchasing Definition - Document Numbering Page

Use the Purchasing Definition - Document Numbering page (BUS_UNIT_TBL_PM3) to define transaction document autonumbering options.

Navigation:

Set Up Financials/Supply Chain > Business Unit Related > Purchasing > Purchasing Definition > Document Numbering

Select **Requisitions**, **Purchase Orders**, **Receivers**, **Requests For Quotes**, and **Return to Vendors** to enable autonumbering for the associated transaction. The last number that was assigned for each transaction appears.

This example illustrates the fields and controls on the Document Numbering. You can find definitions for the fields and controls later on this page.

Business Unit Definition				Business Unit Options				PO Change Options				Req Change Options				Document Numbering			
Unit		US001		US001 NEW YORK OPERATIONS															
Enable Auto Numbering				Beginning Sequence				Last Number Issued											
<input checked="" type="checkbox"/> Requisitions				REO <input type="text"/>				000000148											
<input checked="" type="checkbox"/> Purchase Orders				<input type="text"/>				000000252											
<input checked="" type="checkbox"/> Receivers				<input type="text"/>				000000053											
<input checked="" type="checkbox"/> Return To Vendor (Supplier)s				<input type="text"/>				000000003											
<input checked="" type="checkbox"/> Request For Quotes				Not Applicable				000000008											

<i>Field or Control</i>	<i>Description</i>
Beginning Sequence	<p>To enter the beginning sequence number for the Purchase order, users have to create a valid auto numbering entry.</p> <p>If the Beginning Sequence is blank the Last Number field in the PO Business Unit will be used in the Auto Numbering routines. If the value has been entered in the Beginning Sequence field, the standard Auto Numbering will be used for the Purchase Orders.</p> <hr/> <p>Note: When using the standard Auto Numbering, the default sequence is ignored since the Beginning Sequence value here serves as the default.</p> <hr/>
Last Number Issued	<p>Displays the Last Number value stored in the Purchasing Business Unit if the Beginning Sequence is blank. If the Beginning Sequence is entered, the value displayed will be from the Auto Numbering Table</p>

Establishing Change Options and Approval Rules

This section discusses how to establish change options and approval rules.

Pages Used to Establish Change Options and Approval Rules

<i>Page Name</i>	<i>Definition Name</i>	<i>Usage</i>
<u>PO Change Options (purchase order change options) Page</u>	BUS_UNIT_PO_APPR	Define purchase order change options and approval requirements for each business unit.
<u>Req Change Options (requisition change options) Page</u>	BUS_UNIT_REQ_APPR	Define requisition change options and approval requirements for each business unit.

Related Links

[Understanding Purchase Order Approvals](#)

[Understanding Requisition Approvals](#)

PO Change Options (purchase order change options) Page

Use the PO Change Options (purchase order change options) page (BUS_UNIT_PO_APPR) to define purchase order change options and approval requirements for each business unit.

Navigation:

Set Up Financials/Supply Chain > Business Unit Related > Purchasing > Purchasing Definition > PO Change Options

This example illustrates the fields and controls on the PO Change Options page (1 of 2). You can find definitions for the fields and controls later on this page.

Business Unit Definition | Business Unit Options | **PO Change Options** | Req Change Options | Document Numbering

Unit US001 US001 NEW YORK OPERATIONS *Change Template STANDARD

Approval Framework has been initialized. *Change Order Map Template EDX

Approval Framework Control

PO Workflow Approval Required

Resubmit Workflow for Quantity or Price Decrease

Automatically Approve Change Requests

Buyer Accepted POA Sources

All Other Sources

Workflow Approval Not Required

PO Create Exceptions Personalize | Find | View All | First 1-6 of 10 Last

Not Required	Description
<input type="checkbox"/>	Contract Releases
<input type="checkbox"/>	PAR Location Replenishment
<input type="checkbox"/>	Manual / Expedite Requisitions
<input type="checkbox"/>	Order Management Referenced
<input type="checkbox"/>	Planning System
<input type="checkbox"/>	Request for Quotation

This example illustrates the fields and controls on the PO Change Options page (2 of 2). You can find definitions for the fields and controls later on this page.

PO Change Request Exceptions Personalize | Find | View All | First 1-4 of 7 Last

Not Required	Description
<input type="checkbox"/>	Contract Release to Single PO
<input type="checkbox"/>	PAR Replenish/Close Backorders
<input type="checkbox"/>	Order Management Referenced
<input type="checkbox"/>	PO Acknowledgments

Virtual Approver Control

PO Amount Approval Needed

PO ChartField Approval Needed

PO Approval Business Process: Purchase Order Approvals

PO Amount Approval Rule: PO Amount Approval

PO ChartField Approval Rule: PO ChartField Approval

PO Create Exceptions Find | View All | First 1 of 1 Last

PO Process	Amount Approval Needed	ChartField Approval Needed
<input style="width: 100%;" type="text"/>	<input type="checkbox"/>	<input type="checkbox"/>

Save Return to Search Notify Add Update/Display

Business Unit Definition | Business Unit Options | **PO Change Options** | Req Change Options | Document Numbering

Field or Control	Description
Change Template	<p>Select a change template for purchase orders within this business unit. A purchase order change template identifies which field changes on a purchase order cause the system to generate the following actions:</p> <ul style="list-style-type: none"> • Create a change order if the fields are changed after a purchase order is dispatched. • Record change tracking. • Require re-approval of the purchase order or purchase order line using the approval workflow framework. <p>To create a change template for purchase orders, use the change template type of <i>Purchase Order</i>.</p> <p>See “Creating Change Templates” (PeopleSoft Source to Settle Common Information).</p>
Change Order Map Template	<p>Select the change order map template. The Purchase Order Acknowledgements process uses this template to determine the fields that can be changed by the supplier on the purchase order acknowledgements pages using the EDX process.</p> <hr/> <p>Note: These fields must already exist on the online purchase order acknowledgement pages.</p> <hr/>

Approval Framework Control

Use the Approval Framework Control group box to enable the Approval Workflow Framework for approving purchase orders at the header level, line level, or both. For the approval of purchase orders in PeopleSoft Purchasing, you can choose between two workflow methods; the approval framework or the PeopleTools Workflow Technology.

Note: The system displays a message that indicates whether the workflow approval framework is in use by PeopleSoft Purchasing.

If approvals are not required for either the Approval Framework or Virtual Approver, the system automatically approves stockless purchase orders. The orders are approved even if the **Create POs in Approved Status** option is deselected on the run control. The system ignores the buyer's purchase order creation status in the sourcing programs and only applies the run control value.

If approvals are required, the system goes through the stockless item approvals the same as it does for any other type of item where it checks the exception codes to bypass approvals.

Field or Control	Description
<p>PO Workflow Approval Required (purchase order workflow approval required)</p>	<p>Select to indicate that you want to use the approval framework for purchase order approvals. When you select this check box, you initiate PeopleSoft Approval Framework and end the use of PeopleTools Virtual Approver (part of PeopleTools workflow technology). Any current pending purchase order transactions will finish the approval process using the Virtual Approver. From this action forward, the system uses the approval workflow framework for new purchase orders.</p> <hr/> <p>Warning! After initiating the approval framework, you cannot activate Virtual Approver again.</p> <hr/> <p>When you select this check box, the system displays an additional group box on this page with the title Workflow Approval Not Required. This group box enables you to determine what sources of purchase orders do not require approval; for example, purchase orders created by a contract release may not need approval since a contract is in place. Both new purchase orders and changes to existing purchase orders are included in this group box.</p>
<p>Resubmit Workflow for Quantity or Price Decrease</p>	<p>Select to indicate that purchase orders require re-approval after the quantity or price has been decreased.</p>

See *PeopleSoft FSCM 9.2 Approval Framework*.

Automatically Approve Change Requests

Field or Control	Description
<p>Buyer Accepted POA Source (buyer accepted purchase order acknowledgements source)</p>	<p>Select to automatically approve change order requests that are generated by online purchase order acknowledgements (POAs) that a supplier enters directly into the system. This check box is selected by default.</p> <hr/> <p>Note: To use this option, the installation must include PeopleSoft eSupplier Connection.</p>
<p>All Other Sources</p>	<p>Select to automatically approve change order requests that are generated by other change order sources such as the Close Backorders process, PeopleSoft Supply Planning, PeopleSoft Order Management (direct shipment), PeopleSoft eProcurement (change requests), and PeopleSoft Manufacturing.</p>

Workflow Approval Not Required

This group box only displays if you choose to use the approval workflow framework for purchase order approvals. Define the purchase order input sources that do not require approval by selecting the **Not Required** check box on the row. Purchase orders created from these source are set at the approved status unless you then change a field value defined on the purchase order change template.

Field or Control	Description
PO Create Exceptions	<p>For newly created purchase orders, select the input sources that do not require approval. The sources are:</p> <ul style="list-style-type: none"> • <i>Contract Releases</i>: includes contract referenced purchase orders (CON) and contract releases. • <i>PAR Location Replenishment</i>: (CRT) • <i>Manual and Expedite Requisitions</i> • <i>Order Management Referenced</i>: includes batch and online sourcing (OMR). • <i>Planning System</i>: (PLL) • <i>Request for Quotation</i>: (RFQ) • <i>Production/Shop Floor</i>: from PeopleSoft Manufacturing (SFL) • <i>Services Work Order</i>: work orders from PeopleSoft Services Procurement (SPO) • <i>AutoSelect / Quick Source</i>: purchase orders sourced from approved requisitions (SRC) and PeopleSoft eProcurement requisitions (EPO). • <i>Work Order Management</i>: work orders from PeopleSoft Maintenance Management (WKM)

Field or Control	Description
PO Change Request Exceptions	<p>For changes to an existing purchase order, select the input sources that do not require approval. The sources are:</p> <ul style="list-style-type: none"> • <i>Contract Release to Single PO:</i> (BPA) • <i>PAR Replenishment/Close Backorders:</i>(CRT) • <i>Order Management Referenced:</i> includes batch and online sourcing (DRP). • <i>PO Acknowledgements:</i> (EDX) • <i>Planning System:</i> (PLN) • <i>Production/Shop Floor:</i> from PeopleSoft Manufacturing (PRD) • <i>eProcurement Change Request:</i> (REQ)

Virtual Approver Control

Use the Virtual Approver Control group box to determine your settings for approving purchase orders using the Virtual Approver feature. The Virtual Approver feature is part of the PeopleTools Workflow Technology. For the approval of purchase orders in PeopleSoft Purchasing, you can choose between two workflow methods; PeopleSoft Approval Framework or the PeopleTools Workflow Technology. The Virtual Approver enables you to approve the purchase order at the header level. You can route a purchase order for approval based on the amount, the ChartFields used, or both. To implement workflow approvals, define the roles, rules, and routings using the PeopleSoft Application Designer, PeopleCode, and Workflow Administrator. Your system is delivered with basic approval rules already established.

Note: The fields in this group box are unavailable for entry if you have selected the **PO Workflow Approval Required** check box on this page. You can only choose one workflow approval method for purchase orders.

Field or Control	Description
PO Approval Business Process (purchase order approval business process)	Select the business process for which you are establishing approval rules. This business process corresponds to the approval rule set. Define approval rule sets in PeopleSoft Workflow Administrator.
PO Amount Approval Needed (purchase order amount approval needed)	Select to indicate that the purchase order amount should be approved.
PO Amount Approval Rule Set (purchase order amount approval rule set)	Select the approval rule set to be used to apply purchase order amount approvals.

Field or Control	Description
PO ChartField Approval Needed (purchase order ChartField approval needed)	Select to indicate that the purchase order ChartField should be approved.
PO ChartField Approval Rule (purchase order ChartField approval rule)	Select the approval rule set to be used to apply purchase order ChartField approvals.

When you select either the **PO Amount Approval Needed** (purchase order amount approval needed) or **PO ChartField Approval Needed** (purchase order ChartField approval needed) check box, the system forces purchase order transactions to flow through the approval process before continuing through the purchasing life cycle.

If you do not select either of these check boxes, the purchasing authorizations that are defined on the User Preferences - Procurement: Purchase Order Authorizations page determine approval statuses. In this case, an authorized user can change a transaction approval status from *Open* to *Approved*. Although you define approval processes through PeopleSoft Workflow, you do not have to implement worklist routings to approve purchase orders. You can use designated online pages for purchase order approvals if you do not use the worklist routing option in PeopleSoft Workflow.

When a purchase order is created for a buyer whose default purchase order status is *Open* on the Buyer Table page, the purchase order default status is set to *Open*. To approve the purchase order, an authorized buyer must set the purchase order status to *Pending Approval* or *Approved*. At this point, if neither amount nor ChartField approvals are required, the purchase order status changes to *Approved*.

If at least one type of approval is required, the purchase order status starts at *Pending Approval* and remains in this status until all applicable approvals are complete. After receiving the required approvals, the purchase order status changes to *Approved*.

When a purchase order is created for a buyer whose default purchase order status is *Pending Approval/ Approved*, the purchase order default status is set to either *Approved* (if neither type of approval is needed) or *Pending Approval* (if one or both types of approval are needed).

PO Create Exceptions

Use the PO Create Exceptions (purchase order create exceptions) fields to define exceptions for groups of purchase orders created in batch. These exceptions are grouped based on the sourcing process where the purchase order originated. When you select a sourcing process for approval exception, the system overwrites the approval options that you define on this page. If you want one of the approval options to remain in effect, select the appropriate check box.

These settings can force only the exception of an approval that is required for a purchase order. It can't force an approval that isn't required. If a purchase order is modified online after a selected exempt process creates it, the purchase order is subject to the general approval rules that you select on this page.

Field or Control	Description
PO Process (purchase order process)	Select the sourcing process that you want to be exempt from the approval options. Values are <i>Auto Select</i> , <i>Contract PO's</i> (contract purchase orders), <i>Online Source</i> , <i>PAR Location Replenishment</i> , <i>Planning Load</i> , <i>Production Load</i> , and <i>Request for Quotation</i> .
Amt Appr Needed (amount approval needed)	Select to continue amount approval for this process.
ChrtFld Appr Needed (ChartField approval needed)	Select to continue ChartField approval for this process.

If you use requisitions to designate the authority to purchase, you may want to create purchase orders automatically in *Approved* status when the purchase orders are sourced from approved requisitions. In this case, insert exception rows for *AutoSelect* and *Online Source* and clear the **Amt Appr Needed** and **ChrtFld Appr Needed** check boxes. Purchase orders that are created from these sources are now exempt from workflow approval requirements and are automatically created with a status of *Approved*.

When purchase orders are created from contracts, amounts are already approved. However, if the business unit rule says that ChartFields on the purchase orders must be approved, the purchase order must go through the same approval process as online purchase orders.

Suppose that you create a purchase order using the *AutoSelect Requisitions* process (PO_REQSORC). If you define amount and ChartField approval exceptions for this process, the purchase order is created with a status of *Approved*. If a buyer changes a price on the purchase order online and thereby changes the amount of the purchase order, the purchase order status changes to *Pending Approval*. At this point, the business unit approval rules apply to the modified purchase order. Once a purchase order is modified, these rules apply regardless of the purchase order source and exceptions that are defined.

See the product documentation for *PeopleTools: Workflow Technology*.

Related Links

[Understanding the Purchase Order Sourcing Business Process](#)

[Understanding PeopleSoft Purchasing Workflow](#)

Req Change Options (requisition change options) Page

Use the Req Change Options (requisition change options) page (BUS_UNIT_REQ_APPR) to define requisition change options and approval requirements for each business unit.

Navigation:

Set Up Financials/Supply Chain > Business Unit Related > Purchasing > Purchasing Definition > Req Change Options

This example illustrates the fields and controls on the Requisition Change Options page. You can find definitions for the fields and controls later on this page.

Field or Control	Description
<p>Change Order Option (requisition change order option)</p>	<p>Select a specific category of requisitions that are eligible for change order tracking.</p> <p>Values are:</p> <p><i>A</i>: (Approved Requisitions)</p> <p><i>N</i>: (No Change Orders)</p> <p><i>S</i>: (Sourced)</p> <p><i>V</i>: (Valid Budget Checked)</p> <hr/> <p>Note: The <i>Valid Budget Checked</i> change order option enables you to use requisition change order templates to track changes based on approval, budget, or sourcing statuses. PeopleSoft Purchasing provides three options to determine when a requisition change order should be tracked depending on an organization's business controls. For example, changes to the requisition affect only the buying organization after the requisition has been sourced to a purchase order; however, departmental controls may require that you track changes after requisition approval has occurred.</p>

Field or Control	Description
<p>Change Template (requisition change order template)</p>	<p>Select a change template for requisitions within this business unit. A requisition change template identifies which field changes on a requisition cause the system to generate the following actions:</p> <ul style="list-style-type: none"> • Create a change request if the fields are changed after a requisition has been sourced to a purchase order. • Record change tracking. • Require re-approval of the requisition or requisition line using the approval workflow framework. <p>To create a change template for requisitions, use the change template type of <i>Requisition</i>.</p> <p>See “Creating Change Templates” (PeopleSoft Source to Settle Common Information).</p>

Approval Framework Control

Use the Approval Framework Control group box to enable the approval framework for approving requisitions at the header level, line level, or both. For the approval of requisitions in PeopleSoft Purchasing, you can choose between two workflow methods; the approval framework or the PeopleTools Workflow Technology.

Note: The system displays a message that indicates whether the approval framework is in use by Purchasing.

Field or Control	Description
<p>Workflow Approval Required (workflow approval required)</p>	<p>Select to indicate that you want to use the approval workflow framework for requisition approvals. When you select this check box, you initiate the approval workflow framework and end the use of PeopleTools Virtual Approver (part of PeopleTools workflow technology). Any current pending requisition transactions will finish the approval process using the Virtual Approver. From this action forward, the system uses the approval workflow framework for new requisitions.</p> <hr/> <p>Warning! After initiating the approval workflow framework, you cannot activate Virtual Approver again.</p> <hr/>
<p>Resubmit Workflow for Quantity or Price Decrease</p>	<p>Select to indicate that requisitions require re-approval after the quantity or price has been decreased.</p>

Virtual Approver Control

Use the Virtual Approver Control group box to determine your settings for approving requisitions using the Virtual Approver feature. The Virtual Approver feature is part of the PeopleTools Workflow Technology. For the approval of requisitions in PeopleSoft Purchasing, you can choose between two workflow methods; the Approval Framework or the PeopleTools Workflow Technology. The Virtual Approver enables you to approve the requisition at the header level. You can route a requisition for approval based on the amount, the ChartFields used, or both. To implement workflow approvals, define the roles, rules, and routings using the PeopleSoft Application Designer, PeopleCode, and Workflow Administrator. Your system is delivered with basic approval rules already established.

Field or Control	Description
Req Approval Business Process (requisition approval business process)	Select the business process for which you are establishing approval rules. This business process corresponds to the approval rule set. Define approval rule sets in PeopleSoft Workflow Administrator.
Req Amount Approval Rule (requisition amount approval rule)	Select the approval rule set to be used to apply requisition amount approvals.
Req ChartField Approval Rule (requisition ChartField approval rule)	Select the approval rule set to be used to apply requisition ChartField approvals.

Selecting the **Req Amount Approval Needed** or **Req ChartField Approval Needed** check box forces requisition transactions to flow through the approval process before continuing through the purchasing life cycle.

If you do not select one of these check boxes, the purchasing authorizations that are defined on the User Preferences - Procurement: Requisition Authorizations page determine approval statuses. In this case, an authorized user can change a transaction approval status from *Open* to *Approved*. Although you define approval processes through PeopleSoft Workflow, you do not have to implement worklist routings to approve requisitions. You can use designated online pages for requisition approvals if you do not use the worklist routing option in PeopleSoft Workflow.

See the product documentation for *PeopleTools: Workflow Technology*

Related Links

[Understanding PeopleSoft Purchasing Workflow](#)

Establishing Purchasing Processing Options

To define purchasing processing options, use the Purchasing Processing Options component (BUS_UNIT_OPT_PM).

This section discusses how to Establish Purchasing Processing Options

Pages Used to Establish Purchasing Processing Options

<i>Page Name</i>	<i>Definition Name</i>	<i>Usage</i>
<u>Purchasing Options Page</u>	BUS_UNIT_OPT_PM	Define purchasing options and transaction processing criteria for each PeopleSoft Purchasing business unit. You can override these options during transaction processing.
<u>Dispatch Method Page</u>	BU_OPT_PM_DISP	Define transaction dispatch methods for purchase orders, RFQs, RTVs, contracts, and replenishment requests.
<u>Freight Option Page</u>	BU_OPT_PM_FREIGHT	Define freight options, rule codes, and charge methods.
<u>POA Settings (purchase order acknowledgements settings) Page</u>	POA_DEF_BU_SP	Define POA requirements and tolerance settings.
VAT Defaults Setup Page(value-added tax defaults setup)	VAT_DEFAULTS_DTL	Define VAT default options for all transactions in a business unit.
<u>Service VAT Treatment Defaults Setup (service value-added tax treatment defaults setup) Page</u>	VAT_DEFAULTS_DTL	Define service-related VAT default options for service transactions in a business unit.
<u>Procurement Change Reason Codes Page</u>	BUS_OPT_PM_REASON	Define settings for reason codes used when creating change requests and change orders in PeopleSoft Purchasing, eProcurement, and Services Procurement. These settings enable you to define default reason codes and determine if reason codes or comments should be required when creating or approving these transactions.

Purchasing Options Page

Use the Purchasing Options page (BUS_UNIT_OPT_PM) to define purchasing options and transaction processing criteria for each PeopleSoft Purchasing business unit.

You can override these options during transaction processing.

Navigation:

Set Up Financials/Supply Chain > Business Unit Related > Purchasing > Purchasing Options

This example illustrates the fields and controls on the Purchasing Options page. You can find definitions for the fields and controls later on this page.

You can establish multiple processing options for a given SetID. To create distinct groups of processing options, give each new group a distinct processing option ID. Processing-options groups with different IDs can have the same effective date, which enables you to choose among these groups for varying situations. You can also effective-date processing options within a processing option ID. Within each processing-options group, you can add a new set of effective-dated purchasing options.

Effective-dating processing options enables you to activate or inactivate processing options within a processing option ID. This functionality is useful for making date-sensitive changes to a group of processing options (payment terms, for example) while keeping the other options identical.

Field or Control	Description
Accounting Template	Select the accounting template for this SetID, which is used to determine ChartField values that offset one-sided transactions in PeopleSoft Purchasing.

Field or Control	Description
Accounting Date Indicator	<p>Enter <i>C</i> (current) to use the current system date as the accounting date. Enter <i>S</i> (specific) to use the specific accounting date that you provide here. This value is useful if you do not want multiple journal entries created from a subsystem. Enter <i>S</i> and enter an accounting date for all transactions. When the Journal Generator runs, it finds one date for the entire period and creates one journal entry. Alternatively, the system would create separate entries for each accounting date that the Journal Generator found.</p> <hr/> <p>Note: If you select <i>S</i>, you must return to this definition each month and update the accounting date for the next period.</p> <hr/>
Edit Combinations	<p>Select for any PeopleSoft Purchasing business units that require ChartField combination edits.</p>
Chartfield Edit Option	<p>Select the action that you want the system to take when it encounters errors if you choose to verify ChartFields for this SetID:</p> <p><i>Default:</i> Uses the default value from the Journal Options General Ledger Definition page.</p> <p><i>None:</i> Deselects the ChartField edit option. No action is taken when errors occur.</p> <p><i>Recycle:</i> Enables you to save the transaction, but you can't post until you correct the error.</p> <p><i>Reject:</i> Rejects the transaction and does not enable you to save until you correct the error.</p> <p><i>Use Suspen</i> (use suspense): Posts the transaction to a suspense account. You should coordinate with the PeopleSoft General Ledger implementation team to determine whether you should select this option. If you do select this option, the PeopleSoft General Ledger team must create journal entries to move the amounts out of the suspense account and into the appropriate distribution accounts.</p> <p><i>Warning:</i> Issues a warning and enables you to save.</p>

Field or Control	Description
Automatic UOM Round Option (automatic unit of measure round option)	<p>Select the method by which you want to be notified of automatic rounding of item quantities. (When you are converting between units of measure, item quantities on purchasing documents are automatically rounded according to the rules that are set up on the Units of Measure page.) Values are:</p> <p><i>Error:</i> Stops the conversion if automatic rounding changes the quantity.</p> <p><i>No Warning:</i> Automatic rounding occurs without notification that conversion will change the UOM value.</p> <p><i>Warning:</i> Automatic rounding occurs with a notification of any unit-of-measure value change.</p>
Payment Terms ID	<p>Select a payment term ID for this SetID. By default, this value appears on the purchase order unless you override it at the supplier level. Define payment terms IDs on the Single Pay Terms and Multiple Pay Terms pages.</p>
Payment Terms Basis Date Type	<p>Select the basis date type for the selected payment terms ID. The system calculates the payment due date from this date. Values are: <i>Accounting Date</i>, <i>Constructive Doc Receipt Date</i>, <i>Invoice Date</i>, <i>Receipt Date</i>, <i>Ship Date</i>, and <i>User Specified Date</i>.</p>
Ship Via Code	<p>Select the ship via code for the SetID. Define values on the Ship Via Codes page.</p>
Freight Terms Code	<p>Select the freight terms code for the SetID. Define values on the Freight Terms page.</p>
Physical Nature	<p>Select to indicate whether the object is a physical good or service.</p>

Field or Control	Description
<p>Where Performed</p>	<p>Select to indicate the location where the service is most often performed. Values are:</p> <p><i>Buyer's</i>: Select if the service was physically performed at the buyer location.</p> <p><i>Ship From</i>: Select if the service was physically performed at the bill from location.</p> <p><i>Ship To</i>: Select if the service was physically performed at the bill to location.</p> <p><i>Supplier's</i>: Select if the service was physically performed at the supplier location.</p> <hr/> <p>Note: The Physical Nature and Where Performed fields are used as part of the purchasing defaulting hierarchy. The Where Performed field is available when the value in the Physical Nature field is <i>Service</i>. These fields are supplied by default onto requisition, purchase order, contract, and RFQ lines. These fields also affect the VAT treatment determination.</p>
<p>Open Period</p>	<p>Select how the system is to handle open period in transactions if you are using commitment control. Values include:</p> <p><i>Error</i>: The system issues an error and does not permit you to complete the transaction because the budget date isn't within the valid open period date range. This is the default value if commitment control is enabled.</p> <p><i>None</i>: The system does not check for open period. This is the default value if commitment control is not selected.</p> <p><i>Warning</i>: The system issues a warning but does not prevent you from completing the transaction even though the budget date isn't within the valid open period date range.</p>
<p>Default Amount Only PO to "Do Not Receive" (default amount only purchase order to "do not receive</p>	<p>This check box appears deselected by default. When you create an amount-only purchase order online or through the sourcing process, if this check box is selected, the purchase order lines Receiving Required field will appear as <i>Do Not Receive</i>.</p> <p>If this check box is deselected, the system uses the other defaulting hierarchy to determine the Receiving Required field value for the purchase order line. The system checks first at the item and then the item category to determine the receiving requirement.</p>

Field or Control	Description
Purchasing Group Option	<p>Select this check box in order to provide the means to group various items across a single or multiple transactions together. If this check box is selected, then the Procurement Group ID, Primary Unit, Unit Allocation Quantity, and Unit Allocation Amount fields are displayed on the requisition, purchase order, and receipt transaction pages.</p> <p>See Understanding Procurement Groups in PeopleSoft.</p>
Allocate Purchasing Group	<p>Select this check box to enable functionality for procurement groups to be allocated to PeopleSoft Asset Management. This check box is only available for selection when you have selected the Purchasing Group Option check box above. If you select the Allocate Purchasing Group check box, receipts populate procurement group asset data on the Receipt Line Asset and Asset Management Interface tables to be picked up by PeopleSoft Asset Management.</p>
Allow PCard PO to Close	<p>Select this check box to allow the system to close purchase orders that use ProCards.</p>

Inventory Sourcing Options

Field or Control	Description
Check Inventory Available Qty (check inventory available quantity)	<p>Select to have the system check available inventory when creating inventory demand. If this check box is selected, the system creates inventory demand for the first eligible warehouse in priority order that has sufficient quantity to meet the demand. If this check box is deselected, inventory demand is created for the first eligible warehouse in priority order (unless it is the requesting warehouse), regardless of whether that warehouse has sufficient quantity.</p> <hr/> <p>Note: The distribution network determines the priority order for eligible warehouses. If no distribution network is designated for a ship-to location, the Build Inventory Demand process (PO_REQINVS) resets the Inventory Source option to <i>N</i> (no) for sourcing by the PO Calculations process (PO_POCALC).</p> <hr/>

Field or Control	Description
<p>Partial Qtys Can Ship (partial quantities can ship)</p>	<p>Select to have the Build Inventory Demand process enable an order to be partially sourced from one or more PeopleSoft Inventory business units, with any remaining quantity being sourced to a purchase order.</p> <p>If you do not select this check box and a quantity cannot be fully sourced from one PeopleSoft Inventory business unit, the process sets the inventory source setting on the staging table to <i>N</i> (no), and the entire quantity is sourced to a purchase order.</p>
<p>Item Not Stocked at IN Unit (item not stocked at inventory business unit)</p>	<p>Select to have the Build Inventory Demand process source requests differently when no PeopleSoft Inventory business unit is found to stock this item. Values include:</p> <p><i>Error out:</i> The Build Inventory Demand process errors out when no PeopleSoft Inventory business unit is found to stock the requested item. If you select this value, the process sets the stage statuses to <i>Error</i> in the purchase order staging tables.</p> <p><i>Source to PO</i> (source to purchase order): The Build Inventory Demand process sources the request to a purchase order when no PeopleSoft Inventory business unit is found to stock the requested item. If you select this value, the process sets the inventory source status for the request to <i>N</i> (no) so that the PO Calculation process can source it to a purchase order.</p> <hr/> <p>Note: This and the Check Inventory Available Qty and Partial Qtys Can Ship check boxes work together to help the Build Inventory Demand process determine the method by which requested demand is sourced, as well as which distribution network warehouses are eligible for sourcing.</p> <hr/>
<p>Dispatch Method</p>	<p>Click to access the Dispatch Method page. Use the Dispatch Method page to define the dispatch methods for purchase orders, request for quotes, return to vendors, and contracts.</p>
<p>Freight Option</p>	<p>Click to access the Freight Option page. Use the Freight Option page to define freight options for the business units.</p>
<p>VAT Default (value-added tax default)</p>	<p>Click this link to access the VAT Defaults Setup page.</p> <p>The VAT Defaults Setup page is a common page that you can use to set up VAT defaulting for all PeopleSoft applications that process VAT transactions. Using this page, you can define PeopleSoft Purchasing defaults, as applicable.</p>

Field or Control	Description
VAT Service Treatment Setup (value-added tax service treatment setup)	<p>Click to access the Service VAT Treatment Defaults Setup page.</p> <p>The Service VAT Treatment Defaults Setup page is a common page that you can use to set up VAT defaulting for all PeopleSoft applications that process VAT transactions. On this page, you can define service-related defaults for PeopleSoft Purchasing, as applicable.</p>
POA Setting (purchase order acknowledgement setting)	<p>Click to access the POA Setting page. Use this page to define whether purchase order acknowledgements will be required from suppliers.</p>
Change Reason Codes	<p>Click to access the Procurement Change Reason Codes page where you can define settings for reason codes used when creating change requests and change orders in PeopleSoft Purchasing, eProcurement, and Services Procurement.</p> <p>These setting enable you to define default reason codes and determine if reason codes or comments should be required when creating or approving these transactions.</p>

Related Links

[Building Inventory Demand Transactions](#)

[Open Period](#)

“Defining Additional Common Information” (Application Fundamentals)

“Payment Terms - Single Payment Page” (PeopleSoft Source to Settle Common Information)

“Payment Terms - Multi Payment Page” (PeopleSoft Source to Settle Common Information)

“Understanding VAT” (PeopleSoft Global Options and Reports)

Dispatch Method Page

Use the Dispatch Method page (BU_OPT_PM_DISP) to define transaction dispatch methods for purchase orders, RFQs, RTVs, contracts, and replenishment requests.

Navigation:

Click the **Dispatch Method** link on the Purchasing Options page.

Note: Suppliers can define their own dispatch method settings on the Procurement Options page.

Field or Control	Description
Purchase Order, Request For Quote, and Return to Vendor	Select the dispatch method for transactions that this business creates. Values are <i>EDX</i> (electronic data exchange), <i>Email</i> , <i>Fax</i> , <i>Phone</i> , and <i>Print</i> .
Contract	Select the dispatch method for transactions that this business creates. Values are <i>Email</i> , <i>Fax</i> , <i>Phone</i> , and <i>Print</i> .
ProCard Dispatch Option (procurement card dispatch option)	<p>Select this option if you are using the procurement card functionality on purchase orders. The option that you select will affect the printed text that appears on the PO/Dispatch Print report. Options are:</p> <ul style="list-style-type: none"> • <i>Charge to Card on File</i>: Select to have "Charge to credit card" print in the header portion of the PO Dispatch/Print SQR report (POPO005). • <i>Contact Buyer</i>: Select to have the buyer's name and phone number print in the header portion of the PO Dispatch/Print report, for example, "*Please contact John Smith 925-694-3863 for payment information." • <i>Contact Cardholder</i>: Select to have the card holder's name and phone number print in the header portion of the PO Dispatch/Print report, for example, "*Please contact John Smith 925-694-3863 for payment information." • <i>Include Masked Card Info</i> (include masked card information): Select to have the masked card number, card type, and expiration date appear in the header portion of the PO Dispatch/Print report. • <i>No Reference</i>: Select to have no procurement card information print on the PO Dispatch/Print report.
Transmit Change Orders	<p>Select to enable the PO Dispatch/Print process to transmit change orders to vendors for this business unit. If you do not select this check box, the system may not generate the output file at all. Either way, after the PO Dispatch/Print process runs successfully, the status of the changed purchase order is set to <i>D</i> (dispatched).</p> <p>You can override this value for individual supplier locations on the Procurement Options page.</p> <hr/> <p>Note: This check box applies only to change orders. Initial dispatches of purchase orders are unaffected by this value.</p> <hr/>

Related Links

[Understanding Purchase Order Dispatch](#)

[Dispatch Quote Forms Page](#)

[Dispatch RTVs Page](#)

“Stage Contract POs Page” (PeopleSoft Source to Settle Common Information)

Freight Option Page

Use the Freight Option page (BU_OPT_PM_FREIGHT) to define freight options, rule codes, and charge methods.

Navigation:

Click the **Freight Option** link on the Purchasing Options page.

<i>Field or Control</i>	<i>Description</i>
Arbitration Plan ID	Select the freight and transportation arbitration plan for this business unit.
Freight Charge Method	Select the freight charge method for this business unit. Although the method applies to the entire purchase order, it is calculated on a line-by-line basis.

Related Links

“Understanding Internal Freight Calculations” (PeopleSoft Order Management)

POA Settings (purchase order acknowledgements settings) Page

Use the POA Settings (purchase order acknowledgements settings) page (POA_DEF_BU_SP) to define POA requirements and tolerance settings.

Navigation:

Click the **POA Settings** link on the Purchasing Options page.

This example illustrates the fields and controls on the POA Settings page. You can find definitions for the fields and controls later on this page.

POA Settings

<i>Field or Control</i>	<i>Description</i>
POA Required	Select this check box if a POA is required by a supplier after a purchase order is dispatched. When you select this check box the Alert worklist if no POA received fields become available.
Receive POA Past Due Notifications	Enter the number of days or hours after purchase order dispatch or number of days before purchase order delivery to send a notification to the buyer's worklist if no POA is received by the supplier for a purchase order in those time frames. Note: Enter 999 in these fields if you do not want to generate a worklist entry for the buyer.
POA required with change order (purchase order acknowledgement required with change order)	Select this check box if a POA is required when a change order is created.

POA Tolerance Settings

<i>Field or Control</i>	<i>Description</i>
Auto-Approve POA if changes against PO do not exceed (auto-approve purchase order acknowledgement if changes against the purchase order do not exceed)	Enter the tolerance settings for the system to be able to automatically approve a POA for the buyer.
days before Schedule Due Date and days after Schedule Due Date	Enter the number of days early or late to enable auto-approving a POA for the purchase order schedule. If the supplier changes a date that falls outside the schedule-days-early or schedule-days-late tolerances, then the buyer is required to review the change.
percent under Schedule Quantity and percent over Schedule Quantity	Enter the percentage under or over the purchase order schedule quantity to enable autoapproving a POA for a purchase order. If the supplier changes the quantity for any schedule above or below this percentage then the buyer will be required to review the change.
percent below PO Unit Price (percent below purchase order unit price)and percent above PO Unit Price (percent below purchase order unit price)	Enter the percentage below or above the purchase order unit price to enable autoapproving a POA for a purchase order.

Note: Enter 999 in these tolerance setting fields if you do not want the system to be able to automatically approve a POA within the tolerance settings.

POA Settings Hierarchy

You can define POA settings at the purchasing business unit level and at the supplier and location level. You define the purchasing business unit POA settings using the POA Settings page in the Processing Options component. You define the supplier and location POA settings using the Procurement Options page in the supplier component. You can override the purchasing business unit POA settings by defining supplier and location POA settings.

During the processing of a POA, the system first retrieves the POA settings at the supplier and location level that are associated with the purchase order. If the POA settings are not defined at that level, then the system retrieves the POA settings at the purchasing business unit level.

See “Defining Supplier Locations” (PeopleSoft Source to Settle Common Information).

Service VAT Treatment Defaults Setup (service value-added tax treatment defaults setup) Page

Use the Service VAT Treatment Defaults Setup (service value-added tax treatment defaults setup) page (VAT_DEFAULTS_DTL) to define service-related VAT default options for service transactions in a business unit.

Navigation:

Click the **VAT Service Treatment Setup** link on the Purchasing Options page.

You can insert rows for the supplier's location country or state. You can also delete any existing rows.

Field or Control	Description
Return to Purchasing Options	Click to return to the Purchasing Options component.
Copy Values to New Rows	If you are inserting a row for a VAT driver key, select this check box to copy all the VAT defaults from the previous row to the new row. Otherwise, all VAT default fields for the new row will be blank.
Copy Defaults From	Click to access the Copy Service VAT Treatment Defaults From page, which you can use to copy the VAT defaults from another key combination for the same VAT driver.
Seller Location Country	Select the supplier's location country.
Seller Location State	As applicable, enter the supplier's location state.

Field or Control	Description
VAT Service Type (value-added service type)	Set the type of service for the applicable VAT drivers. Values are: <i>Freight Transport</i> <i>Other</i>
VAT Place of Supply (value-added tax place of supply)	For the applicable VAT drivers, select the usual place of supply (the place where VAT liability occurs). Values are: <i>Buyer's Countries</i> <i>Supplier's Countries</i> <i>Where Physically Performed</i>

Related Links

“Understanding VAT” (PeopleSoft Global Options and Reports)

Procurement Change Reason Codes Page

Use the Procurement Change Reason Codes page (BUS_OPT_PM_REASON) to define settings for reason codes used when creating change requests and change orders in PeopleSoft Purchasing, eProcurement, and Services Procurement.

These settings enable you to define default reason codes and determine if reason codes or comments should be required when creating or approving these transactions.

Navigation:

Click the **Change Reason Codes** link on the Purchasing Options page.

This example illustrates the fields and controls on the Procurement Change Reason Codes. You can find definitions for the fields and controls later on this page.

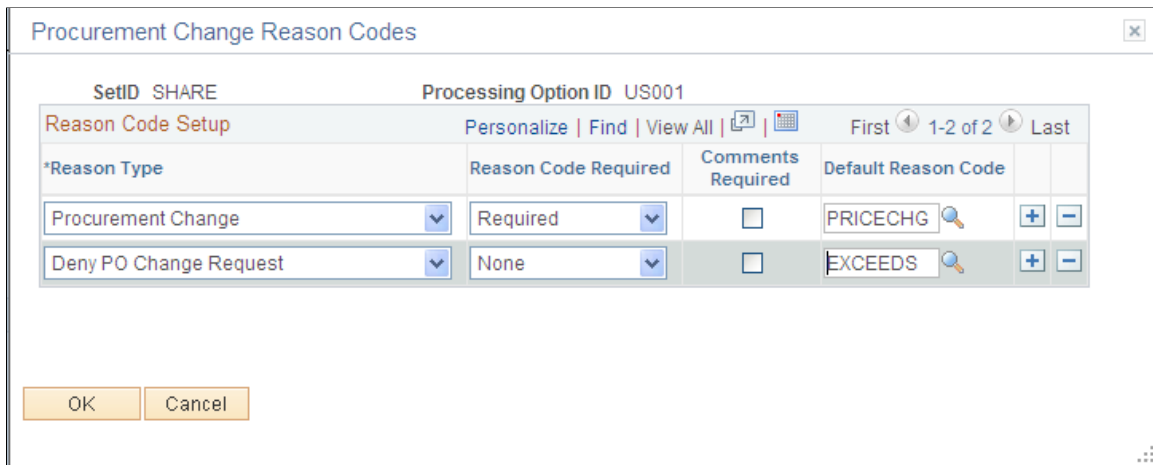

Field or Control	Description
Reason Type	Select the reason type for your default reason code. Your selection is limited to the following reason types: <ul style="list-style-type: none"> • <i>Procurement Change</i>: This reason type enables you to select the default reason code for users entering a change request or change order. • <i>Deny PO Change Request</i>: This reason type enables you to select the default reason code for buyers rejecting a change order during the approval process.
Reason Code Required	Select to require that a user enter a reason code when creating a change request, change order, or rejecting a change. Reason codes help identify why a user made a change or why a buyer rejected the change.
Comments Required	Select to require that a user enter a comment when creating a change request, change order, or rejecting a change. Comments enable the user to give a detailed explanation of their action.
Default Reason Code	Enter the reason code that should default to the transaction. The available reason codes are limited by the reason type on this row. Only one default reason code can be entered per reason type.

Preparing PeopleSoft Purchasing VAT Environments

To prepare the PeopleSoft Purchasing VAT environment:

1. Link the PeopleSoft Purchasing business unit to a VAT entity using the PeopleSoft General Ledger business unit.

This enables the PeopleSoft Purchasing business unit to record VAT information on purchase orders.

2. Define VAT defaults and other VAT-related information for all VAT drivers in the PeopleSoft Purchasing defaulting hierarchy, as required.

To link a PeopleSoft Purchasing business unit to a VAT entity:

1. Access the Purchasing Definition - Business Unit Definition page.
2. Select the **PS/GL** (PeopleSoft General Ledger) check box.
3. Select the PeopleSoft General Ledger business unit in the **GL Unit** (general ledger unit) field.

The connection between PeopleSoft Purchasing business units and VAT entities is indirect. You must link the PeopleSoft Purchasing business unit to a PeopleSoft General Ledger business unit that is already linked to a VAT entity. Define links between PeopleSoft General Ledger business units and VAT entities on the VAT Entity - Identification page.

After linking PeopleSoft Purchasing business units to PeopleSoft General Ledger units, set the VAT processing options for those business units. VAT processing options are defined by SetID, and the options are applied to all business units within the SetID.

To define VAT defaults, VAT service treatment defaults, and other VAT-related information for the PeopleSoft Purchasing options VAT driver:

1. Access the Purchasing Options page (Set Up Financials/Supply Chain, Business Unit Related, Purchasing, Purchasing Options).
2. Specify a value for physical nature.
3. Click the **VAT Defaults** link to access the VAT Defaults Setup page for the purchase order options VAT driver.

See [Understanding the Requisition Business Process](#).

4. Click the **VAT Service Treatment Setup** link to access the Service VAT Treatment Default setup page for the purchase order options VAT driver.

To define VAT defaults and other VAT-related information for the PeopleSoft Purchasing (business unit) definition VAT driver:

1. Access the Purchasing Definition - Business Unit Options page.
2. Select the **Calculate VAT on Req** (calculate value-added tax on requisitions) check box if you want to process and calculate VAT on requisitions and pass the requisition VAT information to other procurement transactions further along the supply chain.
3. Access the Purchasing Definition - Business Unit Definition page.
4. Click the **VAT Defaults** link to access the VAT Defaults Setup page for the PeopleSoft Purchasing business unit VAT driver.

To define VAT defaults, service VAT treatment defaults, and other VAT-related information for the supplier and supplier location VAT drivers:

1. Access the supplier Identifying Information page.

Select: **Suppliers > supplier Information > Add Update > Identifying Information**.

2. Select the **VAT Registration** check box and access the VAT Registration Details page.

Create a row, entering the VAT registration number, if available, for all VAT countries in which this supplier conducts business and all countries for which the supplier reports VAT.

3. Click the **VAT Defaults** link to access the VAT Defaults Setup page, where you can define VAT defaults, such as VAT codes, transaction types, declaration points, rounding rule, and VAT use type for vendors.
4. Click the **VAT Service Treatment Setup** link to access the Service VAT Treatment Defaults Setup page, where you can define service-related VAT defaults for vendors.
5. Access the Location page.

For each location, expand the VAT section to define the usual physical nature of items purchased from this location (the location where services provided by this supplier location are usually performed) and to specify whether this supplier has been selected for suspension of VAT on purchases.

6. For each location, click the **VAT Defaults** link to access the VAT Defaults Setup page, where you can define VAT defaults (such as VAT codes, transaction types, declaration points, rounding rule, and VAT use type) for supplier locations.
7. For each location, click the **VAT Service Treatment Setup** link to access the Service VAT Treatment Defaults Setup page, where you can define service-related VAT defaults for supplier locations.

To define VAT defaults at the PeopleSoft Purchasing item level:

1. Access the Purchasing Attributes page.

Select: **Items > Define Items and Attributes > Purchasing Attributes.**

2. Click the **VAT Default** link to access the VAT Defaults Setup page.
3. Click the **VAT Service Treatment Setup** link to access the Service VAT Treatment Defaults setup page.

To define a default VAT use type for the VAT driver for item business units in PeopleSoft Purchasing:

1. Access the Purchasing Business Unit Attributes page.

Select: **Items > Define Items and Attributes > Purchasing Attributes.**

2. Click the **VAT Default** link to access the VAT Defaults Setup page.

You can also define VAT defaults and service VAT treatment defaults for all VAT drivers in the PeopleSoft Purchasing hierarchy by navigating directly to the VAT Defaults and Service VAT Treatment Defaults components.

Related Links

[Establishing PeopleSoft Purchasing Business Units](#)

[Service VAT Treatment Defaults Setup \(service value-added tax treatment defaults setup\) Page](#)

“Buyer Setup Page” (PeopleSoft Source to Settle Common Information)

Chapter 4

Understanding Search Framework in PeopleSoft Purchasing

Understanding Search in PeopleSoft Purchasing

PeopleSoft Purchasing allows you to search on a keyword when viewing Purchase Orders and other transactions within the Purchasing/Procurement process.

This topic provides information related to PeopleSoft Purchasing for:

- Components
- Search Definitions, Global Search categories
- Connected Queries and Queries
- Faceted fields

Components

These components use PeopleSoft keyword search:

- PO Contracts (CNTRCT_ENTRY)
- Purchase Orders (PURCHASE_ORDER)
- Receipts (RECV_PO)
- Requisitions (REQUISITIONS)
- Purchase Order Documents and Purchasing Contract Documents (CONTRACT_MGMT)

Global Search Category

The Search Category is the highest-level object in the Search framework. It is comprised of one or more Search Definitions. All the searches in the application are performed against Search Categories. For global search it is necessary to set up search categories as Search Groups.

The search category used in Purchasing for global searches is EP_PROCUREMENT.

This example illustrates the fields and controls on the Search Category page.

General Settings

General
Advanced Search Fields
Facets
Custom Search Page
Display Fields

Search Category Name EP_PROCUREMENT

***Description**

Duplicates **Search Group**

Object Owner ID

|< < 1-6 of 6 > >|

*Search Definition	Description		
<input type="text" value="EP_CS_DOC_CONTRA"/>	Purchasing Contract Documents	<input type="button" value="+"/>	<input type="button" value="-"/>
<input type="text" value="EP_CS_DOC_PURCHC"/>	Purchase Order Documents	<input type="button" value="+"/>	<input type="button" value="-"/>
<input type="text" value="EP_PO_CONTRACTS"/>	PO Contracts	<input type="button" value="+"/>	<input type="button" value="-"/>
<input type="text" value="EP_PO_PURCHASE_O"/>	Purchase Orders	<input type="button" value="+"/>	<input type="button" value="-"/>
<input type="text" value="EP_PO_RECEIPTS"/>	Receipts	<input type="button" value="+"/>	<input type="button" value="-"/>
<input type="text" value="EP_PO_REQUISITION"/>	Requisitions	<input type="button" value="+"/>	<input type="button" value="-"/>

The Purchasing/Procurement search category is exposed to global searches. All available items in the Search Framework repository are displayed in the search result for global search. However, related action and item detail are only available for the items for which the requester has access, based on the security setup.

Search Definitions

Search Definitions are the main structure of a search index. A search definition contains everything needed to create a search index, which includes facets, security, attachments, pre- and post-processing, and component mapping.

Six search definitions are linked to the Purchasing/Procurement search category EP_PROCUREMENT. They are:

- EP_CS_DOC_CONTRACTS (Purchasing Contract Documents)
- EP_CS_DOC_PURCHORDRS (Purchase Order Documents)

- EP_PO_CONTRACTS (PO Contracts)
- EP_PO_PURCHASE_ORDERS (Purchase Orders)
- EP_PO_RECEIPTS (Receipts)
- EP_PO_REQUISITIONS (Requisitions)

Note: EP_PO_PURCHASE_ORDERS, EP_PO_RECEIPTS, and EP_PO_REQUISITIONS are certified for Real Time Indexing (RTI). See “Understanding Real Time Indexing in FSCM” (Application Fundamentals).

To know more about the Real Time Indexing (RTI) of EP_PO_REQUISITIONS, see “Real Time Indexing Switch” (PeopleSoft eProcurement).

Some indexes are not used for Global Search and are instead used to provide analytical data. In Purchasing these indexes include:

- EP_PO_CONTRACT_KIB (Procurement Contracts)
- EP_PO_RECEIPTS_KIB (Purchasing Effectiveness)

Connected Queries and Queries

In Purchasing every search definition is attached to a Connected Query. A connected query is a hierarchical ordering of the existing queries. For example:

- Search Definition - EP_CS_DOC_CONTRACTS, Connected Query - CS_DOC_CONTRACTS
- Search Definition - EP_CS_DOC_PURCHORDRS, Connected Query - CS_DOC_PURCHORDRS
- Search Definition - EP_PO_CONTRACTS, Connected Query - PO_SRCH_CONTRACTS_CQ
- Search Definition - EP_PO_PURCHASE_ORDERS, Connected Query - PO_SRCH_PO_CQ1
- Search Definition - EP_PO_RECEIPTS, Connected Query - PO_SRCH_RECEIPTS_CQ
- Search Definition - EP_PO_REQUISITIONS, Connected Query - PO_SRCH_REQ_CQ
- Search Definition - EP_PO_CONTRACT_KIB, Connected Query - EP_PO_CNTRCT_KIBANA_CQ
- Search Definition - EP_PO_RECEIPTS_KIB, Connected Query - EP_PO_RECV_KIBANA_ANALYTICS_CQ

The parent query is the most important as it is the driver for data extraction. Every row found for the parent becomes a document in the Search Framework repository. All other queries provide additional data that could be present or missing in the repository. Multiple rows at lower level, results in repeating attributes that will be indexed.

Faceted Fields

A facet is a field that is relevant to the search and that allows you to browse or refine search results.

These fields are predefined as faceted fields for PeopleSoft Purchasing:

- SES_YEAR_H (Document Date Hierarchy)

- NAME1_FSCM_NAME1 (Supplier Name)

Real Time Indexing Switch

RTI allows you to set a threshold that is referenced by a set of delivered batch programs. When a batch program is enabled and the set threshold is exceeded, RTI is disabled until the next incremental build.

To set the threshold for your organization, access the Configure Real Time Indexing page and enter a value beyond which RTI will be temporarily disabled. This page will also allow you to see which batch programs are delivered by Purchasing for the RTI Switch.

For more information, see *PeopleTools: PeopleSoft Search Technology, Administering Real Time Indexing*.

Note: When the threshold is reached and RTI is disabled, run incremental indexing for the related search definition after the batch job is complete and RTI will be automatically restored.

RTI Switch is coded for the following search definition and batch program combinations. If a batch job is not listed below, then it has not been coded to use RTI Switch due to lower volume/usage.

Search Definition	Batch Programs
EP_PO_PURCHASE_ORDERS	<ul style="list-style-type: none"> • PO_AUTO_SRC • PO_POCHNG • PO_POCREATE • PO_POROLL1 • PO_POROLLOPN • PV_AUTO_SRC
EP_PO_RECEIPTS	PO_RECVLOAD

Real Time Indexing for Insights Dashboards

Real Time Indexing is available for Procurement Contracts (EP_PO_CONTRACT_KIB) and Purchasing Effectiveness (EP_PO_RECEIPTS_KIB) dashboards.

To configure these dashboards, refer [Setting up Insights Dashboards for Purchasing](#).

Chapter 5

Defining Purchasing Item Information

Understanding Purchasing Item Information

Defining values on the purchasing item information pages provides item-related processing information and default values that minimize errors and maximize productivity when you create purchasing transactions.

This section provides a list of common elements and discusses how to:

- Set up item catalogs.
- Work with market codes.

Common Elements Used in Purchasing Item Information

Field or Control	Description
Days Late, Early Ship Rjet Days (days late, early shipment rejection days)	Enter the acceptable number of days before or after a shipment date during which you will still receive the goods.
Ext Price Tolerance /% Ext Price Tolerance (extended price tolerance/percentage extended price tolerance)	Enter the matching tolerance amount and percentage for the extended price (amount multiplied by quantity) of the item. The extended price tolerance is the tolerance for the entire order, not just an individual item.
Inspect ID (inspection ID)	Displays the inspection IDs, which are established on the Inspection Routing page.
Inspection Required	Select to require inspection and to make the other inspection fields available for entry.
Inspection UOM (inspection unit of measure)	Select from these values: <i>Standard:</i> Select to perform inspections in the standard unit of measure (UOM) setup on the Item Definition - General: Common link page. <i>Supplier:</i> Select to perform inspections in the UOM used on the purchase order to the supplier.

Field or Control	Description
<p>Lead Time Factor %, Ship to Priority Factor %, Price Factor %, supplier Priority Factor % (lead time factor percent, ship to priority factor percent, price factor percent, supplier priority factor percent)</p>	<p>If you select the <i>Flexible</i> sourcing method, enter the percentage weight that you want to give to lead time, price, ship to, and supplier priority. The higher the percentage that you give to one of the criteria, the more weight that criterion has. For example, if you want to select the supplier based only on lead time, you can give lead time a percentage weight of 100 percent and the supplier with the best lead time (regardless of price, ship to, or supplier priority) is selected.</p>
<p>Partial Qty (partial quantity)</p>	<p>Indicate the action that you want to take if you receive less than the quantity specified on the purchase order schedule. Select from:</p> <p><i>Open</i>: Select to receive the partial quantity, leave the receipt line status as <i>Open</i>, and enable the receipt to be saved.</p> <p><i>Open/Error</i>: Reject the partial quantity, leave the receipt line status as <i>Open</i>, and generate an error message.</p> <p><i>Open/Warn</i> (open, but with a warning): Receive the partial quantity, leave the receipt line in <i>Open</i> status, and generate a warning message.</p> <p><i>Recvd</i> (received): Receive the partial quantity and change the receipt line status to <i>Recvd</i>.</p> <p><i>Recvd/Warn</i> (received with a warning): Receive the partial quantity and change the receipt line status to <i>Recvd</i>, but also generate a warning about the partial quantity.</p>
<p>Receiving Required</p>	<p>Select the receiving requirement for the item. Values are:</p> <ul style="list-style-type: none"> • <i>Do Not</i>: Do not receive; accounts payable matching and receipt accrual are not applicable. • <i>Optional</i>: Receiving is optional; accounts payable will not match receipt lines and the system will not accrue the receipt. • <i>Required</i>: Receiving is required; accounts payable will match receipt lines and the system will accrue the receipt.
<p>Reject Qty Over Tolerance (reject quantity over the tolerance limit)</p>	<p>Select to reject a quantity that surpasses the tolerance limits that you set.</p>
<p>Sourcing Method</p>	<p>Select from <i>Basic</i>, <i>Cumulative Split</i>, <i>Flexible</i>, and <i>Sched Split</i> (split schedule). This value appears by default from the category assigned to the item.</p>
<p>Tolerance Over, Tolerance Under</p>	<p>Select the amount or percentage over or under the tolerance selected that still enables a voucher match.</p>

<i>Field or Control</i>	<i>Description</i>
Unit Price Tolerance/% Unit Price Tolerance (unit price tolerance/percent unit price tolerance)	Displays the matching tolerance amount and percentage for the price of an individual item.

Setting Up Item Catalogs

With PeopleSoft Purchasing, you can define any number of item catalogs. These item catalogs can be tailored for individual, department, or corporate-wide use and can greatly reduce the repetitive tasks associated with service and material purchases, such as rent, supplies, and standing inventory.

With PeopleSoft catalog functionality, you can:

- Assign default item catalogs tailored specifically to individual requesters.
- Transfer item catalog information in electronic format into PeopleSoft catalogs.

PeopleSoft Purchasing enables you to load and maintain items from various applications, including a process that loads and updates item information from a third party or supplier to PeopleSoft Purchasing and an Item Loader process that synchronizes item information between systems.

These are the main steps involved in creating an item catalog:

1. Create the category that will serve as the first node in the catalog tree.
2. Create a catalog tree.
3. Assign catalogs to the requesters.
4. Associate an inventory item with a default category.

To create the category that will serve as the first node in the catalog tree:

1. Access the Item Categories - Category Definition page in Add mode.

In the access requirements for the page, enter the SetID and the category code that you want to use as the first node for the new catalog tree.

2. On the Item Categories - Category Definition page, enter required information, including account, description, short description, and currency code.
3. Save the category.

You may see warning messages about tolerances that have been left as zero (0.00000). For our current task, this is acceptable. Click the **OK** button to acknowledge the warning.

4. When the system asks whether you want to update item catalogs with the category changes, click the **No** button because you have not yet created the target catalog tree.

In the future, when the catalog tree has been established, click the **Yes** button, and select the catalog to which you want to assign a new category.

To create a catalog tree:

1. Access the Tree Manager component.
2. Choose to create a new tree definition and enter a tree name.
3. On the Tree Definition and Properties page, enter the basic information: tree name, structure ID, effective date, description, category, use of levels, audit options, and performance options.

Click the **OK** button to accept the settings and close the Tree Definition and Properties page. When you do, the Enter Root Node for Tree page appears.

4. On the Enter Root Node for Tree page, create a tree level for the new tree.

If no existing level is listed, click the **Add Level** button to access the Tree Levels page, where you can define the level to be used by the entire tree you are creating. If an existing level exists, you can choose to select it.

5. Enter a level name on the Tree Levels page.

The level name that you define here can be any generic name, for example, *LEVEL 1*.

If the level does not already exist in the system, you are transferred to the Tree Level Setup page.

6. On the Tree Level Setup page, enter further information about the level.

This includes information such as effective date, status, description, and short description.

Click the **Apply** button to save the settings. Click the **OK** button to return to the Enter Root Node for Tree page.

7. On the Enter Root Node for Tree page, create the first node by defining a value in the **Root Node** field.

This should be the name of the first node.

Click the **OK** button to accept and create the first node. When you do, the Tree Manager page appears.

8. On the Tree Manager page, click the **Insert Detail** button to create the detail node.

The Detail Value Range page appears.

9. On the Detail Value Range page, select the **Dynamic Flag** check box and click the **Add** button.

The system returns you to the Tree Manager page.

10. Save the new tree definition.

You have now successfully created an item catalog tree.

11. Click the *Yes* button when prompted to update item catalogs with the category changes.

12. Assign the new category to the new catalog.

13. Launch Tree Manager to verify that the nodes have been created correctly for the catalog.

To assign catalogs to the requesters:

1. Use the Requester Setup page, and enter the requester name in the access requirements.
2. Select the **Use Only Assigned Catalogs** check box.
3. In the **Catalog Information** scroll area, assign catalogs to the selected requester.
4. Select the **Default** check box for the catalog that a requester will use as a default catalog.

see the product documentation for *PeopleTools: Tree Manager*

Related Links

[Defining Purchasing Item Categories](#)

“Requester Setup Page” (PeopleSoft Source to Settle Common Information)

Working with Market Codes

If you are an existing PeopleSoft Purchasing customer, the conventional category codes are considered to be user-defined and the market codes for these codes are set to *User Def* (user-defined) (01) in the Item Categories component after you run the upgrade script. You can maintain the same coding scheme, as well as migrate to the new industry standard coding scheme, the Universal Standard Products and Services Classifications (UNSPSC). PeopleSoft eProcurement provides you with the Import CUP File process (PV_CP_LOAD) to load UNSPSC and their corresponding MarketSite items through a batch process.

Use the UNSPSC to classify products and services at 2-digit, 4-digit, 6-digit and 8-digit levels, depending on your specific needs. Each subsequent level of detail describes a subset of all codes and descriptions preceding it in the code's hierarchy.

For example, ballpoint pens at the 8-digit level are a subset of writing instruments at the 6-digit level, which is a subset of office supplies at the 4-digit level. These descriptions are varying degrees of office equipment, accessories, and supplies at the 2-digit level. You can add ninth and tenth digits to indicate the business relationship to the supplier, such as rental/lease, wholesale, retail, or original equipment manufacturer. Each UNSPSC is unique and enables unambiguous translation of the commodity's description into any language.

This table explains the UNSPSC coding hierarchy. In this example, leased addressing machines are assigned UNSPSC number 4410210510. They are classified as office equipment, accessories and supplies – one of 55 existing segments at the top level of the UNSPSC hierarchy.

Level	UNSPSC	UNSPSC Description
Segment	44	Office equipment, accessories, and supplies.
Family	44 10	Office machines and their supplies and accessories.
Class	44 10 21	Mail machines.
Commodity	44 10 21 05	Addressing machines.

Level	UNSPSC	UNSPSC Description
Business function identifier	44 10 21 05 10	Addressing machines, leased.

When you add a new category code using the Item Categories component, the system checks to determine whether the code consists of only numbers and has an even number of digits. If so, the system then assigns *UN/SPSC* (02) as the market code. If the category code does not meet these criteria, the system assigns *User Def.* (01) as the market code. You cannot modify the market code after you add the category code.

If the market code for the new category is set to *UN/SPSC*, the system looks at the code and determines whether its ancestor codes must be created and creates them accordingly. The length of the ancestor codes that are automatically generated is based on the length of the category code that you just entered. For example, when you enter the category code *4410210510* and no ancestor codes exist, the system generates the following ancestor codes:

4400000000

4410000000

4410210000

4410210500

Upon saving the Item Categories component, the system asks whether you want the item catalogs updated. If the answer is no, the catalog tree is not updated. If the answer is yes, the Update Catalog Tree page appears. If you are updating an existing code, the page displays the existing catalog information.

The relationship between *CATEGORY_CD* (category code) and *CATEGORY_ID* (a system-assigned sequential number) is one-to-one in the *PS_ITM_CAT_TBL* table. The relationship between an item (*PS_MASTER_ITEM_TBL*) and a default category (*PS_ITM_CAT_TBL*) is many-to-one.

Note: You may be able to associate an item with more than one category. However, only the PeopleSoft eProcurement product supports the one item and multiple categories association feature.

For example, the following scenario is not supported in PeopleSoft Purchasing: In SetID *SHARE*, item 10002 is mapped to category code *CYCLING* (*CATEGORY_ID* = 00009). This means that for catalog *ALL_PURCHASE_ITEMS*, item 10002 belongs to the tree node *CYCLING* (due to dynamic range).

You might be able to create an item static range from 10001 to 10003 under another tree node, *FISHING*. This range violates the relationship previously described because, in this case, item 10002 is mapped to two categories, *CYCLING* and *FISHING*. Avoiding this scenario is a good practice because it may create unpredictable results when you use the Order by Catalog function.

Related Links

[Defining Purchasing Item Categories](#)

[Update Catalog Tree Page](#)

[Order By Catalog Page](#)

Defining Purchasing Item Categories

To define purchasing item categories, use the Item Categories component (ITEM_CATEGORIES).

This section provides an overview of item categories.

Pages Used to Define Purchasing Item Categories

Page Name	Definition Name	Usage
<u>Item Categories - Category Definition Page</u>	CATEGORY_TBL	Define item categories.
<u>Update Catalog Tree Page</u>	CAT_PNLS_CATLG_SEC	Select the catalog tree to update with new category code information.
BU Specific Attributes Page(business unit specific attributes)	ITM_CAT_BU_SEC	Assign a buyer to this category for each business unit. You may want to do this if you order by description and want a default buyer for this category by business unit. This setup is optional. The system uses the values set for the buyer at the item category level for all business units that are not specified here.
View Catalog Hierarchy Page	CAT_PARENTAGE_SEC	View information about where a category resides in the entire catalog tree hierarchy.
VAT Defaults Setup Page(value-added tax defaults setup)	VAT_DEFAULTS_DTL	Define value-added tax (VAT) defaults.
Service VAT Treatment Defaults Setup Page(service value-added tax treatment defaults setup)	VAT_DEFAULTS_DTL	Define service VAT treatment defaults.

Page Name	Definition Name	Usage
<u>Item Categories - Category Definition 2 Page</u>	CATEGORY_TBL2	<p>Define the matching and receiving controls, sourcing controls, and miscellaneous controls and options for the category.</p> <p>Also use to set price tolerance defaults for items to trigger workflow exception notifications.</p> <p>PeopleSoft Purchasing and PeopleSoft Payables use matching controls to match receipts, purchase orders, and vouchers.</p> <p>Receiving controls specify how receiving users process items assigned to this category.</p> <p>These values become a part of the item default hierarchy and can be supplied by default to purchase order lines where this category is specified.</p>
<u>Supplier Sourcing Priorities Page</u>	ITM_CAT_VND_PR_SEC	Set the supplier priority and split sourcing allocation percentage for vendors for this category

Understanding Item Categories

If your installation includes PeopleSoft Purchasing, you must create categories for the items. You will be required to assign new items to a category on the Define Item - General: Common link. Category information helps reduce redundant data entry during both item setup and requisition and purchase order processing. The purchasing attributes of an item category are assigned as defaults to any item in that category.

Item categories can provide transaction information for requisitions, requests for quotes, contracts, and purchase orders. Item categories also serve as the organizational unit for item catalogs. In fact, item catalogs are a collection of item categories. Each item added to a category is automatically added to each catalog that contains that category.

For each category that you create, you can define purchasing attributes, such as general ledger account, primary buyer, lead time, price tolerances, and so forth. For example, you might create a category for outdoor equipment with a set of default purchasing attributes that apply to most of the outdoor equipment purchases. During item definition, every item that you assign to the outdoor equipment category receives the attributes of that category.

Note: If you don't order by item ID, category attributes will be supplied by default to the item lines of requisitions, contracts, and purchase orders on which you specify the category codes. If you do order by item ID, the attributes are supplied by default from the Item tables rather than the Category tables.

Item Categories - Category Definition Page

Use the Item Categories - Category Definition page (CATEGORY_TBL) to define the matching and receiving controls, sourcing controls, and miscellaneous controls and options for the category.

Navigation:

Items > Define Controls > Item Categories > Category Definition

This example illustrates the fields and controls on the Category Definition page. You can find definitions for the fields and controls later on this page.

Field or Control	Description
Market Code	Select the coding scheme that a category code is using. Values are <i>UN/SPSC</i> (Universal Standard Products and Services Classification) (02) and <i>User Def.</i> (user-defined) (01).
Effective Date	Select a date for which you want to make the purchasing item category effective for use.
Status	Select a category status. Changing a category status from <i>Active</i> to <i>Inactive</i> means that you can no longer assign items to the category. This status change does not affect the existing and future PeopleSoft Purchasing transactions involving items in the inactivated category. For example, setting a category status to <i>Inactive</i> has no effect on orders that you have in progress that contain items tied to the newly inactivated category. You can also continue to add these items to the PeopleSoft Purchasing transactions using the usual methods, such as entering an item ID directly on the online page or using the Order By Catalog page or Item Search Criteria page.

Field or Control	Description
Lead Time Days	Enter the number of lead-time days required for items in this category. This value is used in calculating the due dates for purchase order lines when the category you're defining is specified for a line on which no item ID is specified, the purchase order has no default due date, or no due date is specified on the line schedules.
Account	Select a valid account number to identify the general ledger account to be associated with the items in this category. This account number is used on transactions when no item ID is specified at the line level of a PeopleSoft Purchasing purchase order and no default account is specified for the transaction.
Alt Acct (alternate account)	Select an alternate account number to identify the general ledger account to be associated with the items in this category. This field is available if you enable the Alternate Account option for the organization and for the general ledger business unit.
Asset Profile ID	Select an asset profile ID for the category. Asset profile IDs are transferred to PeopleSoft Asset Management when PeopleSoft Purchasing receives an item that specifies both an asset profile and a PeopleSoft Asset Management business unit. When you define a purchase order or requisition line using an asset category without specifying an item, the asset profile of that category becomes the default. Asset profile IDs are set up on the Asset Profile page.
Usage Code	<p>Enter an ultimate use code to be supplied by default on purchasing transactions whenever this category is referenced on an ad hoc (order by description) line.</p> <p>In most cases, sales tax is computed as a use tax based on the tax code that is applicable to the ship to or usage destination. However, how merchandise is ultimately used may also result in a different tax rate within the same ship to or usage destination.</p>
Physical Nature	Indicate whether the object is a physical good or service. Values are <i>Goods</i> and <i>Services</i> .

Field or Control	Description
Where Performed	<p>Select the location where the service is most often performed:</p> <p><i>Buyer's</i>: Select if the service is physically performed at the buyer location.</p> <p><i>Ship From</i>: Select if the service is physically performed at the ship from location.</p> <p><i>Ship To</i>: Select if the service is physically performed at the ship to location</p> <p><i>Supplier's</i>: Select if the service is physically performed at the supplier location.</p> <hr/> <p>Note: This option is available only when the physical nature is service.</p> <hr/>

Related Links

[Working with Market Codes](#)

[Order By Catalog Page](#)

[Creating Requisition Schedules](#)

[Category Search Page](#)

“Understanding PeopleSoft ChartFields” (Application Fundamentals)

Update Catalog Tree Page

Use the Update Catalog Tree page (CAT_PNLS_CATLG_SEC) to select the catalog tree to update with new category code information.

Navigation:

Change item categories or add a new item category on the Item Categories - Category Definition page and save.

Click the **Yes** button when asked if you want to update catalogs with the category changes.

Field or Control	Description
Parent Category	<p>When the market code for the category is <i>UN/SPSC (02)</i>, the Parent Category field is unavailable for entry because the system generates and maintains UNSPSC ancestor nodes automatically. You can select multiple catalog trees for updating.</p> <p>When the market code is <i>User Def. (01)</i>, you must select a Parent Category value. Then click the Catalog Refresh button to retrieve the catalog trees to which the parent category belongs. You can select only one catalog tree for updating.</p> <hr/> <p>Note: The category being modified is not available as a parent category when you are updating the catalog tree.</p>

Item Categories - Category Definition 2 Page

Use the Item Categories - Category Definition 2 page (CATEGORY_TBL2) to define the matching and receiving controls, sourcing controls, and miscellaneous controls and options for the category.

Navigation:

Items > Define Controls > Item Categories > Category Definition 2

Sourcing Controls

Field or Control	Description
Accumulate Level	<p>If you select <i>Cumulative Split</i> in the Sourcing Method field, this field becomes available for entry. Select <i>Run</i> to accumulate the percentage for the supplier based on each run of the PO Calculations process (PO_POCALC), or select <i>Schedule</i> to accumulate based on each schedule.</p>

Cumulative Sourcing

In the **Cumulative Sourcing** group box, set the options for the cumulative sourcing method. The fields in this group box become available if you select *Cumulative* in the **Sourcing Method** field.

Field or Control	Description
Year to Start	<p>Designates the year in which you want to start maintaining supplier history. You cannot specify a year in the future. Cumulative sourcing must be based on history and cannot occur in the future.</p>

Field or Control	Description
Month to Start	Enter the number of the month in which you want to start maintaining supplier history. Changing the value in this field triggers recalculation of historical quantities and amounts. History is always maintained from the first day of the start month to the first day of the end month.
Number of Months	Enter the number of months for which you want to keep supplier history. Changing the value in this field triggers recalculation of historical quantities and amounts.
Start Date	Displays the start day, which is calculated based on the values that you define for the Year to Start , Month to Start , and Number of Months fields. History is always maintained from the first day of the start month to the first day of the end month.
End Date	Displays the date on which supplier history is to be refreshed. This date is calculated based on the values defined for the Year to Start and Month to Start fields, plus the value in the Number of Months field. So if Month to Start is 1 and Number of Months is 3, the end date will be 04/01. History is refreshed by the first run of the Cumulative Sourcing Update process (PO_POHISTUD) as soon as the current date is greater than or equal to the end date.
Total Category Amount	Displays the total merchandise amount for all vendors for this category for the historical period, in the category currency.

Misc. Controls and Options

Field or Control	Description
Close PO Under Percent Tol (close purchase order under percent tolerance)	Enter an acceptable percentage of the total quantity or amount that can be outstanding while still enabling the purchase order to be closed. If the quantity or amount not yet received is less than or equal to the value entered here, the Close Purchase Orders process (PO_PORECON) will treat the purchase order as fully received.
RFQ Required (request for quote required)	Select if the item must go through the RFQ cycle before it can be included on a requisition or purchase order.

Related Links

[Close Purchase Orders Page](#)

[Running the PO Calculations Process](#)

[Updating Supplier History Dates and Amounts for Cumulative Sourcing](#)

Supplier Sourcing Priorities Page

Use the Supplier Sourcing Priorities page (ITM_CAT_VND_PR_SEC) to .

Navigation:

Click the **Priorities** link on the Item Categories - Category Definition 2 page.

<i>Field or Control</i>	<i>Description</i>
Priority	Enter a priority rank for the supplier. When the PO Calculations process selects a supplier for the item, it uses the priority ranking with the lowest number (<i>1</i>) as the first choice. When you add another supplier, the next priority ranking is automatically assigned.
Allocation Percentage	If you selected <i>Sched Split</i> or <i>Cumulative Split</i> in the Sourcing Method field on the Item Categories - Category Definition 2 page, enter the allocation percentage for the selected supplier.
Merchandise Amt (merchandise amount)	Displays the total merchandise amount for this supplier for this category for the historical period, along with the category currency.

Related Links

[Running the PO Calculations Process](#)

[Defining Purchasing Item Categories](#)

Defining Purchasing Item Attributes

To define purchasing item attributes, use the Purchasing Attributes component (PURCH_ITEM_ATTR). Use the PURCH_ITEM_ATTR_CI component interface to load data into the tables for this component.

If you have PeopleSoft Purchasing installed, you can use the Purchasing Attributes component to specify purchasing information for the items.

This section discusses and provides an overview of order multiple rounding rules.

Pages Used to Define Purchasing Item Attributes

Page Name	Definition Name	Usage
<u>Purchasing Attributes Page</u>	ITM_TBL_PUR	Enter basic purchasing information for an item.
<u>Item Specifications Page</u>	ITEM_SPEX_PUR	Record standard details about the item. These specifications can be sent to the supplier using the purchase order.
Packing Details Page	ITM_PKG_PUR_SEC, ITM_VUOM_PKG_SEC	Enter packing volume and weight information for the item. When accessed from the supplier's UOM and Pricing Information page, the Packing Details page also enables you to define item package dimensions, which can be useful if item package dimensions vary by supplier.
VAT Defaults Setup Page(value-added tax defaults setup)	VAT_DEFAULTS_DTL	Enter VAT defaults for this item into the VAT hierarchy tables with a VAT driver of item.
Service VAT Treatment Defaults Setup Page(service value-added tax treatment defaults setup)	VAT_DEFAULTS_DTL	Enter service-related VAT defaults for this item into the VAT hierarchy tables with a VAT driver of item.
<u>Purchasing Attributes - Purchasing Controls Page</u>	ITM_TBL_PUR2	Specify matching and receiving defaults for the item. Define sourcing controls and miscellaneous controls and options for the item. Set price tolerance defaults for purchased items. These tolerances are supplied by default from the item's category; you can override them during online item setup. Use these tolerances in conjunction with the price change exception rule. Item Load processes compare new item/supplier prices in the Item Loader staging table to the previous item/supplier price. If the new price exceeds tolerances, the system generates an exception.

Page Name	Definition Name	Usage
<u>Purchasing Business Unit Attributes Page</u>	ITM_BU_PUR	<p>Define item attributes by business unit.</p> <p>If you do not specify tolerance values for the business unit, the system uses tolerance values defined for the item's purchasing attributes.</p> <p>When you access this page to specify business-unit specific attributes, tolerance values are supplied by default from the item's purchasing attributes. To define zero tolerances on this page, you must clear the tolerance fields manually.</p> <p>If you access this page and enter a business unit but do not enter any values, and you click OK to exit the page, the system records default tolerance values from the purchasing attributes to create business-unit specific values. Click Cancel instead to avoid this situation.</p> <p>The fields on this page match those on the Purchasing Attributes page and on the Purchasing Definition - Business Unit Options page.</p> <p>This page is not available unless at least one of the PeopleSoft Purchasing business units has the Allow Business Item Attributes option selected on the Purchasing Definition - Business Unit Options page.</p>
<u>Purchasing Attributes -Item Supplier (ITM_VENDOR)Page</u>	ITM_VNDR	Establish and update prioritized item-supplier combinations.
Supplier Lookup Page	VENDOR_LOOKUP_SEC	Search for suppliers.
<u>Item Supplier Location Substitute Items Page</u>	ITM_VNDR_SUB	Specify substitute items at the Item Supplier Location level
<u>Supplier's UOM and Pricing Information (Supplier's unit of measure and pricing information) Page</u>	ITM_VNDR_UOM	Establish valid units of measure to use when ordering the item from the supplier and to establish the pricing information for each valid UOM.
<u>Effective Dated UOM (effective-dated unit of measure) Page</u>	ITM_VNDR_UOMCHG	Enter effective-dated conversion rate changes along with the packing detail information.

Page Name	Definition Name	Usage
<u>Update Purchase Order Page</u>	PO_EDUOM_UPDPO_SEC	Update existing purchase order schedules with the new effective-dated UOM conversion rate changes.
Maintain Purchase Order - Purchase Order Page	PO_LINE	Maintain the purchase order and all of its details.
Supplier's Manufacturer Info Page (supplier's manufacturer information)	ITM_supplier_MFG	Record the authorized manufacturers for an item-supplier combination.
Supplier Item Return Fees Page	ITM_VND_RTV_FEE	Add fees charged by the supplier for returning this item.
Item Supplier Contracts Page	ITM_VNDR_CNTRCT	View all contracts for any specified item/supplier combination.

Understanding Order Multiple Rounding Rules

In several industries, such as consumer goods and wholesale and distribution, for various economic and packaging reasons suppliers ship only certain items in multiples of a specific quantity. They can define the smallest quantity they are willing to ship for the item. Then when you create purchase orders to these suppliers you want a system that can use this information and calculate the rounding of the suggested order quantities to reflect the supplier's specification to these suppliers.

PeopleSoft Purchasing enables you to specify whether to have the system check for order multiples when you are ordering an item from a particular supplier and location on a purchase order.

Note: Order multiples are available only on the online purchase order. Batch sourcing and requisitions do not use the order multiples functionality.

In addition, you can also specify the rounding rule that you want the system to use when its is calculating the correct order quantity multiple for this item on the purchase order. The two available rounding rules that you can choose are natural round and round up. The following examples illustrate the different types of rounding rules and their outcomes.

Rounding Rule Examples

Refer to the following table for quantity calculation examples using the different rounding rules:

Item	Supplier	Location	Unit of Measure/ Order Multiple	Round Rule	Order Quantity	Suggested Order Quantity
10005	SCM0000001	Main	EA / 5 IP / 10 CS / 2 PT / 1	Natural Round	14 EA	15 EA
10005	SCM0000001	Main	EA / 5 IP / 10 CS / 2 PT / 1	Natural Round	12 EA	10 EA
10005	SCM0000001	Main	EA / 5 IP / 10 CS / 2 PT / 1	Round Up	14 EA	15 EA
10005	SCM0000001	Main	EA / 5 IP / 10 CS / 2 PT / 1	Round Up	12 EA	15 EA

Purchasing Attributes Page

Use the Purchasing Attributes page (ITM_TBL_PUR) to enter basic purchasing information for an item.

Navigation:

Items > Define Items and Attributes > Purchasing Attributes

This example illustrates the fields and controls on the Purchasing Attributes page. You can find definitions for the fields and controls later on this page.

Field or Control	Description
<p>PO Available Date, (purchase order available date)Unavailable, andUnavailable</p>	<p>Indicate the dates within which the item can be added to a purchasing transaction. You can add an item between these two dates only.</p>
<p>Use as Substitute Item Only</p>	<p>Select to designate this item for use as a substitute item only, to be used exclusively in the Manual and Automatic Item Substitution process. Items selected for substitution only will be filtered out and cannot be selected in any Item ID prompt fields in the Procurement system.</p> <hr/> <p>Note: The advantage of the ‘Substitute Item Only’ check box is to prevent the Requester or Buyer from choosing this Item from the Item ID prompt while creating a Procurement transaction in scenarios where the Item Substitution feature has been used for this item. Hence, the item will not end up in a Requisition or PO as the Original Item due to integration with IN, OM. In case the item is put away into Inventory, the user can deselect the ‘Substitute Item Only’ check box to allow a Requester or Buyer to order it directly if the user has surplus in Inventory.</p>
<p>Standard Price</p>	<p>Enter the standard price for the item purchased in its standard UOM. A standard price is required for each item and becomes the default price in transactions for which another price, such as a supplier price or a contract price, is not defined for the item. An item's standard UOM is defined on the Item Definition - General: Common link.</p>

Field or Control	Description
Standard Unit of Measure	Displays the standard UOM used for pricing. The pricing UOM may be different from the stocking UOM.
Last PO Price (last purchase order price)	Displays the last price that was used on a purchase order for this item. When an item is initially set up, the standard price is also the last price value. This field is updated by the Receiver Interface Push process (PO_RECVPUSH) and is used by the return-to-vendor transaction to cost the return and enable items to be returned to a supplier other than the original supplier of the order.
Currency	Select the currency of the standard price.
Lead Time Days	The value appears by default from the Item Categories - Category Definition page. You can override the default value for individual items.
Item Descr (item description)	Enter a long description of the item up to 30 characters long. Enter a short description of the item up to 10 characters long. These descriptions can be used with PeopleSoft reporting and query tools instead of the standard 254-character description to distinguish the purchasing descriptions from the internally used item description established in the Item Definition component. These purchasing descriptions then also appear in the Description text box at the bottom of the page, where you can expand the descriptions to 254 characters. Whereas the long and short descriptions defined here are for internal use only, the description in the lower text box is used in all purchasing transactions and becomes available by selecting the description button or menu item on the PeopleSoft Purchasing pages.
Asset Profile ID	Displays the default from the Item Categories - Category Definition page. An asset profile ID on a purchase order, in conjunction with a PeopleSoft Asset Management business unit, indicates that PeopleSoft Asset Management is to be notified of the purchase of this item when it is received.
Ultimate Use Code	Select an ultimate use code to override the default tax rate for a location. In most cases, sales tax is computed as a use tax based on the tax code applicable to the ship to or usage destination. However, how merchandise is ultimately used may also result in a different tax rate within the same ship to or usage destination.
Physical Nature	Indicates whether an object is a physical good or service.

Field or Control	Description
Where Performed	<p>Select to indicate the location where the service is most often performed:</p> <p><i>Buyer's</i>: Select if the service is physically performed at the buyer location.</p> <p><i>Ship From</i>: Select if the service is physically performed at the ship from location.</p> <p><i>Ship To</i>: Select if the service is physically performed at the ship to location.</p> <p><i>Supplier's</i>: Select if the service is physically performed at the supplier's location.</p> <hr/> <p>Note: This field is available only when you select a physical nature of <i>Service</i>.</p>
Primary Buyer	<p>Displays the default from the Item Categories - Category Definition page in the Define Item Control Data component. You can override the information for individual items. The primary buyer value is used as the default buyer when the item is added to a requisition.</p>
Account	<p>Select an account number to identify the general ledger account to be associated with this item. This account number is used on transactions when an item ID is not specified at the line level of a PeopleSoft Purchasing purchase order and a default account is not specified for the transaction.</p>
Alt Account (alternate account)	<p>Select an alternate account number to identify the general ledger account to be associated with this item. This field is available if you enable the Alternate Account option for the organization and for the general ledger business unit.</p>
Product	<p>Select a product that the system should assign for this purchasing item when a product is not specified at the line level of a purchase order.</p>

Associated Picture

The fields in this group box are used to attach image files or other documents to the item descriptions. You can attach any type of file that you have defined on the File Locations page. The file that you want to attach must reside in the file directory defined for the file type on the File Location page.

Field or Control	Description
File Name	Enter the name of the file that you want to attach.

Field or Control	Description
File Extension	Enter the file extension, such as .bmp or .jpg.
	Click the Image Doc Launcher button to launch an attached file. This button is available only if you entered a file name and extension in the fields in the Associated Picture group box.
Multi Image	<p>Click to open the Multi Image Setup page where you can specify details for the multi dimensional item images. The multi images defined on the Multi Image Setup page will share the same file extension that is already defined by the user.</p> <hr/> <p>Note: This link appears only if the Multi Image check box is selected on the eProcurement Installation Options page.</p>

Multi Image Setup

This example illustrates the fields and controls on the Multi Image Setup page. You can find definitions for the fields and controls later on this page.

Multi Image Setup

Share the same file extension defined in previous page.

Input Guide

Sequence From Sequence To Connector

Name Prefix Number Start Number Step

Large Image Ends Medium Image Ends Small Image Ends Generate Line

Associate Picture Personalize | Find | View All | | First 1-3 of 5 Last

Sequence Number	Large Image Name	Medium Image Name	Small Image Name		
1	<input type="text" value="1l"/>	<input type="text" value="1m"/>	<input type="text" value="1s"/>		
2	<input type="text" value="2l"/>	<input type="text" value="2m"/>	<input type="text" value="2s"/>		
3	<input type="text" value="3l"/>	<input type="text" value="3m"/>	<input type="text" value="3s"/>		

Field or Control	Description
Sequence From	Enter the sequence number indicating from where to start the associate image naming. By default the value will be 1.
Sequence To	Enter the sequence number that indicates the number of lines to end the associate image naming. By default the value will be 5.

Field or Control	Description
Connector	Enter the connector that will link the field values of Name Prefix, Number, and Image Ends. Usually “_” is set as the connector, for example Share/AM001_1_m
Name Prefix	Enter suitable name to prefix before all the image names, for example if the prefix name is Share then image names will appear as Share/AM001_2_m, Share/AM002_3_m.
Number Start	Enter the base number to calculate the image sequence, for example Share/AM001_1_m, Share/AM002_2_m.
Number Step	Enter suitable value to increase the base number for each line.
Large Image Ends	Enter text to append at the ends of large image names.
Medium Image Ends	Enter text to append at the ends of medium image names.
Small Image Ends	Enter text to append at the ends of small image names.
Generate Line	Click to generate multiple image lines based on the details given.

Related Links

[Supplier's UOM and Pricing Information \(Supplier's unit of measure and pricing information\) Page](#)
[Defining Purchasing Item Categories](#)
[Item Categories - Category Definition Page](#)

Item Specifications Page

Use the Item Specifications page (ITEM_SPEX_PUR) to record standard details about the item.

These specifications can be sent to the supplier using the purchase order.

Navigation:

Click the **Item Specifications** link on the Purchasing Attributes page.

Item specifications that you enter on this page are not automatically carried to requisitions and purchase orders for the associated item unless you specify this by selecting the **Copy to Transactions** check box. If this check box is not selected, you must access the Include Item Specifications page to copy specifications on requisitions and purchase orders. Use the Include Item Specifications page to copy these specifications to the line comments for a transaction.

If you have selected **Send to Supplier** here, the **Send to supplier** option on the Line Comments page for the transaction is automatically selected.

<i>Field or Control</i>	<i>Description</i>
Comments	Enter the specifications for the item using up to 2,000 characters.
Copy to Transactions	Select this check box to automatically copy the item specifications comments into the line comments when this item is referenced on a requisition or purchase order transaction.
Send to supplier	Select to make this specification information available to be sent to the supplier as part of the purchase order.

Purchasing Attributes - Purchasing Controls Page

Use the Purchasing Attributes - Purchasing Controls page (ITM_TBL_PUR2) to specify matching and receiving defaults for the item.

Define sourcing controls and miscellaneous controls and options for the item. Set price tolerance defaults for purchased items. These tolerances are supplied by default from the item's category; you can override them during online item setup. Use these tolerances in conjunction with the price change exception rule. Item Load processes compare new item/supplier prices in the Item Loader staging table to the previous item/supplier price. If the new price exceeds tolerances, the system generates an exception.

Navigation:

Items > Define Items and Attributes > Purchasing Attributes > Purchasing Controls

This example illustrates the fields and controls on the Purchasing Controls page (1 of 2). You can find definitions for the fields and controls later on this page.

Purchasing Attributes	Purchasing Controls	Item Supplier
SetID SHARE Item ID 10000 Standard Unit of Measure EA		
Description Long Sleeve Biking Jersey, Men's		
Expand All Collapse All		
Matching Controls		
	Tolerance Over	Tolerance Under
Unit Price Tolerance	<input type="text" value="0.00000"/>	<input type="text" value="0.00000"/>
% Unit Price Tolerance	<input type="text" value="5.00"/>	<input type="text" value="90.00"/>
Ext Price Tolerance	<input type="text" value="0.00000"/>	<input type="text" value="0.00000"/>
% Ext Price Tolerance	<input type="text" value="5.00"/>	<input type="text" value="90.00"/>
Receiving Controls		
*Receiving Required	<input type="text" value="Required"/>	<input checked="" type="checkbox"/> Inspection Required
<input type="checkbox"/> Reject Qty Over Tolerance		Inspect Sample Percent <input type="text" value="0.00"/>
<input type="checkbox"/> Include Past Due Kanban POs		*Inspection UOM <input type="text" value="Standard"/>
Qty Rcvd Tolerance %	<input type="text" value="50.00"/>	Inspect ID <input type="text" value="BIKE"/>
*Partial Qty	<input type="text" value="Rcvd"/>	
Early Ship Reject Days	<input type="text" value="10"/>	

This example illustrates the fields and controls on the Purchasing Controls page (2 of 2). You can find definitions for the fields and controls later on this page.

Sourcing Controls	
<input type="checkbox"/> Use Category Sourcing Controls	*Sourcing Method <input type="text" value="B"/> Basic
Lead Time Factor % <input type="text" value="0.00"/>	Ship to Priority Factor % <input type="text" value="0.00"/>
Price Factor % <input type="text" value="0.00"/>	Supplier Priority Factor % <input type="text" value="0.00"/>
Misc. Controls and Options	
<input checked="" type="checkbox"/> Auto Select	<input type="checkbox"/> Contract Required
<input checked="" type="checkbox"/> Accept Any Supplier	<input type="checkbox"/> RFQ Required
<input checked="" type="checkbox"/> Accept Any Ship To	<input type="checkbox"/> Stockless Item
<input type="checkbox"/> Available in All Regions	<input checked="" type="checkbox"/> Taxable
Close PO Under Percent Tol <input type="text"/>	<input checked="" type="checkbox"/> Include in Planning
Ship Via <input type="text"/>	
WorkFlow Notification Controls	
Unit Price Tolerance <input type="text" value="99999999.00000"/>	Tolerance Over <input type="text" value="99999999.00000"/>
% Unit Price Tolerance <input type="text" value="999.00"/>	Tolerance Under <input type="text" value="999.00"/>
BU Attributes	

Matching Controls

If you do not specify tolerance values for the business unit, the system uses tolerance values defined for the item's purchasing attributes.

The fields on this tab match those on the Purchasing Business Unit Attributes page and the Purchasing Definition - Business Unit Options page.

Specify default price tolerances for the PeopleSoft Payables Matching process (AP_MATCH) that matches purchase orders, receipts, and vouchers to verify supplier charges. When you use matching with PeopleSoft Purchasing and PeopleSoft Payables to verify supplier charges, the system uses four price tolerances to determine whether the purchase order price and voucher price are within the tolerances and thus whether the purchase order and purchase order voucher match. These fields appear by default from the Item Categories - Category Definition 2 page. If you leave any of the tolerance fields set to 0 or blank, the system assumes a zero tolerance. If you don't want to use the tolerance fields, set the amount fields that you don't want to use to 99999999.99999 and the percentage fields that you don't want to use to 100.

Receiving Controls

Define tolerances to be used in receiving this item. These become the default values for purchase order lines when this item is selected. The values appear by default from the Item Categories - Category Definition 2 page.

If you do not specify tolerance values for the business unit, the system uses tolerance values defined for the item's purchasing attributes.

The fields on this tab match those on the Purchasing Business Unit Attributes page and the Purchasing Definition - Business Unit Options page.

Field or Control	Description
<p>Include Past Due Kanban POs (include past due Kanban purchase orders)</p>	<p>This field is available if you are using PeopleSoft Manufacturing, thus enabling you to receive by Kanban ID.</p> <p>Select this check box to include past-due Kanban purchase order quantities when the Receiver Load process searches for purchase orders to match up with Kanban IDs for receipt creation.</p> <p>If you select this check box, the Receiver Load process can receive a schedule for which the due date has passed, but which still contains a quantity to be received.</p> <p>If you do not select this check box, the Receiver Load process searches for purchase orders based on the due date of the schedule.</p> <p>When using supplier replenishment with PeopleSoft Flow Production, select the Include Past Due Kanban POs check box to help ensure that the receipts and purchase orders have the opportunity to match up. Because supplier replenishment occurs frequently, if you set the Early Ship Reject Days value too low, the Kanban receiving process may not permit you to receive the material because it arrived too early.</p>
<p>Inspect Sample Percent</p>	<p>Enter the percentage of received units to inspect. This value is calculated using the Inspection UOM (inspection unit of measure) value.</p>

Sourcing Controls

Field or Control	Description
<p>Use Category Sourcing Controls</p>	<p>Select to use the sourcing controls set on the Item Categories - Category Definition 2 page.</p> <p>If you have set up vendors at the category level and select this check box for items using this category, then the vendors that you entered for the category must also be entered in the purchasing attributes.</p>

Field or Control	Description
Sourcing Method	<p>Select the sourcing method to use with this item. Methods include:</p> <p><i>B</i> (Basic)</p> <p><i>F</i>(Flexible): When you select this method, the system makes the remaining fields in this section available.</p> <p><i>Sched Split</i> (schedule split)</p> <p>See Understanding Sourcing Methods.</p>

Misc. Controls and Options

Field or Control	Description
Auto Select	<p>Select if you want the AutoSelect Requisitions process (PO_REQSORC) to pick up the item when it sources requisition lines. If this check box is selected, the AutoSelect Requisitions process will include the item. If this condition is not met, the AutoSelect Requisitions process will not include the item.</p>

Field or Control	Description
Contract Required	<p>Select this check box if you need a contract to order the item on a requisition or purchase order. If this check box is selected, you must specify a valid contract for the item on the purchase order when you use the item, or you must release the item from an active contract.</p>
Accept Any supplier	<p>Select this check box if you can order an item without setting up vendors for the item. If you do not select this check box, you must establish an item-supplier relationship for the item on the Purchasing Attributes - Item Supplier page before you can include it on a purchase order.</p>
RFQ Required (request for quote required)	<p>Select this check box if the item must go through the RFQ cycle before it can be included on a purchase order. If you do not select this check box, you can order the item directly.</p>

Field or Control	Description
Accept Any Ship To	<p>Select this check box if you can order an item without setting up a ship to address for it.</p> <hr/> <p>Note: This check box does not override the corresponding field set up for the item on the Purchasing Attributes - Item Supplier page. If you do not select the check box on either page, you must establish an item-supplier ship to relationship on the Item Ship To Locations page.</p> <hr/>
Stockless Item	<p>Select this check box if an agreement has been set up with the supplier to supply this item for par inventory replenishment.</p>
Available in All Regions	<p>Select this check box to remove regional security during the sourcing process. The purchase order sourcing business process creates purchase orders from item requests loaded to the PeopleSoft Purchasing staging tables from various sources.</p> <p>Select this check box to make the item available in all regions and bypass regional security. If the item is available in all regions, then all vendors from ITM_supplier table are displayed.</p> <p>Clear this check box if you want regional security applied. In this case, the item is not available in all regions. When entering a request, the value in the SHIPTO_ID field is examined to determine the REGION_CD field value. Using this information, vendors are displayed from ITM_REGION_VNDR table, in priority order. A message is issued if rows exist in the ITM_SHIPTO_VNDR table show a different priority. If the user changes the shipto and thereby changes the region, then the allowable vendors are revised.</p> <p>For more information about regional security applied during the purchase order sourcing business process, see the PeopleSoft Purchasing "Using Purchase Order Sourcing" topic, "Understanding Regional Sourcing" section.</p> <p>See Understanding Regional Sourcing.</p>
Taxable	<p>Select to indicate that the item is taxable using system tax calculations.</p>

Field or Control	Description
Close PO Under Percent Tol (close purchase order under percent tolerance)	Enter an acceptable percentage of the total quantity or amount that can be outstanding while still enabling the purchase order to be closed. If the quantity or amount not yet received is less than or equal to the value entered, the Close Purchase Orders process will treat the purchase order as fully received.
Include in Planning	<p>Select to enable purchase options to be created in PeopleSoft Supply Planning for the PeopleSoft Inventory business unit related to this item. The purchase option then enables the creation of new purchase orders through PeopleSoft Supply Planning for the PeopleSoft Inventory business unit.</p> <p>PeopleSoft Supply Planning uses sourcing templates that contain a sequenced list of purchasing sourcing options based on the item attributes that you define in PeopleSoft Purchasing. You can let the system load the options automatically, or you can set up sourcing templates manually and maintain the options. These templates are needed when multiple sourcing options exist for an item. When you assign multiple sourcing options to a single item, you create a more flexible planning situation by providing more information to source demand.</p>
Ship Via	Select a shipping method if you always want this item to be shipped using the method selected here.

Related Links

[Selecting Suppliers Based on Item Ship To and Item Supplier Locations](#)

[Purchasing Attributes -Item Supplier \(ITM_VENDOR\)Page](#)

[Understanding the Close Purchase Orders Process](#)

Purchasing Business Unit Attributes Page

Use the Purchasing Business Unit Attributes page (ITM_BU_PUR) to define item attributes by business unit

If you do not specify tolerance values for the business unit, the system uses tolerance values defined for the item's purchasing attributes.

When you access this page to specify business-unit specific attributes, tolerance values appear by default from the item's purchasing attributes. To define zero tolerances on this page, you must manually clear the tolerance fields.

If you access this page but do not enter any values, and you click **OK** to exit the page, the system records default tolerance values from the purchasing attributes to create business-unit specific values. Click **Cancel** instead to avoid this situation.

Navigation:

Click the **BU Attributes** (business unit attributes) link on the Purchasing Attributes - Purchasing Controls page.

The fields on this page match those on the Purchasing Attributes - Purchasing Controls page and the Purchasing Definition - Business Unit Options page.

Purchasing Attributes -Item Supplier (ITM_VENDOR)Page

Use the Purchasing Attributes -Item Supplier (ITM_VENDOR)page to establish and update prioritized item-supplier combinations.

Navigation:

Items > Define Items and Attributes > Purchasing Attributes > Item Supplier

This example illustrates the fields and controls on the Purchase Items Attributes page. You can find definitions for the fields and controls later on this page.

Purchase Items Attributes

Purchasing Attributes | Purchasing Controls | **Item Supplier**

SetID SHARE Item ID 10000 Standard Unit of Measure EA

Description Long Sleeve Biking Jersey, Men's

Supplier Priorities

Item Supplier Find | View All First 1 of 4 Last

*Supplier SetID SHARE Supplier Lookup *Status Active

*Supplier ID SCM0000001 Bike Shopper *Priority 1

Allocation % 0 Include in Planning

Supplier's Catalog

Supplier Item ID

Item Extension

Description

254 characters remaining

Associated Picture

File Name Jersey File Extension PNG

File Path

URLID Open URL Multi Image

Supplier Attributes Find | View All First 1 of 2 Last

*Price Loc MAIN Accept Any UOM

*Price Date PO Accept Any Ship To

*Price Qty Line Quantity Stockless Item

Origin Country Price Can Be Changed on Order

Region of Origin Use Item Standard Lead Time

Lead Time Days

Order Multiples

Check Order Multiples

Rounding Rule

Natural Round

Round Up

Item Supplier UOM Supplier Item MFG Substitute Items

RTV (Supplier) Fees Item Supplier Contracts

Supplier Priorities

Field or Control	Description
Priority Loc (priority location)	<p>Select the ordering location for the item and supplier. The supplier default location appears by default.</p> <p>Several processes in PeopleSoft Purchasing use this field:</p> <ul style="list-style-type: none"> • Purchase order sourcing uses the item supplier priority for orders if no item and ship to priority supplier has been defined. • The Sourcing Load process used by PeopleSoft Supply Planning uses the item supplier priority if no item and ship to priority supplier has been defined. • The Requisition Loader process uses the first item supplier priority location if no location is specified.

Item Supplier

Field or Control	Description
Supplier SetID	Select a Supplier SetID. The value determines the values available for the supplier ID.
Supplier Lookup	Click to access the Supplier Search page, where you can define search criteria to locate suppliers.
Status	<p>Select a value that describes the status of the supplier. Values include:</p> <p><i>Active.</i></p> <p><i>Discontued</i> (discontinued).</p> <p><i>Hold.</i></p> <p><i>Inactive.</i></p> <p><i>To Be Del</i> (to be deleted).</p>
Supplier ID	Select the Supplier ID. Only values for the selected Supplier SetID are available.

Field or Control	Description
Priority	Enter a priority rank for the supplier. When the PO Calculations process selects a supplier for the item, it uses the priority ranking with the lowest number (1) as the first choice. When you add another supplier, the next priority ranking is automatically assigned.
Allocation %	If you selected <i>Sched Split</i> or <i>Cumulative Split</i> in the Sourcing Method field on the Item Categories - Category Definition 2 page, enter the allocation percentage for the selected supplier.
Include in Planning	Select to include purchase options in PeopleSoft Supply Planning. Deselect this check box to not include purchase options in PeopleSoft Supply Planning.
Supplier Catalog	Enter a supplier catalog assigned to the selected item-supplier combination. The system uses the value as a default value on the Purchase Order Line Details page.
Supplier Item ID	Enter an item ID.
Item Extension	Enter an item extension. The system uses this value to further define an item.
Description	Enter an item description for this supplier associated with the item. This field is informational only and is not used anywhere else in PeopleSoft Purchasing.

Associated Picture

Use this section to access or define a picture for use with this item supplier.

Field or Control	Description
File Name	Enter the name of the file that contains the picture.
File Extension	Enter the type of file.
File Path	Enter a path to where the file is located.
URL	Enter an URL address at which the file is stored.

Field or Control	Description
Open URL	Click to access the picture file.
Multi Image	<p>Click to open the Supplier Multi Image Setup page where you can specify details for the multi dimensional item images.</p> <p>The multi images defined on the Supplier Multi Image Setup page will share the same file extension that is already defined by the user. If the fields in the Associated Picture section are not defined then multi images defined at the purchasing level will be used.</p> <hr/> <p>Note: This link appears only if the Multi Image check box is selected on the eProcurement Installation Options page.</p> <hr/>

For better performance it is recommended to create separate folder for the image files based on SetID/Item Catalog/Item Category. Recommended image size is as follows:

- Large - 500*500 (120k)
- Medium - 200*200 (25k)
- Small - 40*40 (2k)

Supplier Attributes

Field or Control	Description
Price Loc (price location)	Select a supplier location. Supplier locations are set up on the supplier Information - Location page. Location codes provide the flexibility to set up different pricing information for the same item-supplier combination, depending on which supplier location you identify as the pricing location.
Price Date	<p>Select the date used for effective-dated price adjustments:</p> <p><i>Due:</i> Price adjustments based on the date that the order was due to be received.</p> <p><i>PO</i> (purchase order date): Price adjustments based on the date that the order was placed.</p>
Price Qty (price quantity)	Select a price quantity. Based on the selection, the system uses the <i>Line</i> or <i>Schedule</i> quantity to determine any applicable price breaks.

Field or Control	Description
<p>Origin Country</p>	<p>Select the country in which the item was originally manufactured. This information is generally required for the Intrastat Arrivals report; however, the PeopleSoft Intrastat Transaction Loader uses the field for return-to-vendor transactions (RTVs).</p> <p>If you leave the field blank, the transaction loader uses the country code of the shipping PeopleSoft Inventory business unit as the default value for RTVs.</p>
<p>Region of Origin</p>	<p>Select the region or department from which the item was initially shipped for return to vendor. This information is generally required for the Intrastat Dispatches report.</p> <p>If the initial shipping region or department for return to vendor is different from the one defined for the PeopleSoft Inventory business unit, enter a specific state code. The state code should belong to the country of the PeopleSoft Inventory business unit.</p> <p>If you leave the field blank, the Intrastat Transaction Loader uses the state code of the shipping PeopleSoft Inventory business unit as the default region of origin. This default value is also used if a state code does not belong to the country defined for the PeopleSoft Inventory business unit.</p>
<p>Accept Any UOM (accept any unit of measure)</p>	<p>Select this check box if this item can be ordered in any UOM from this supplier. If you do not select this check box, you must set up an item-supplier UOM relationship for each UOM in which the item can be purchased from the supplier.</p> <hr/> <p>Note: This check box does not affect requisition processing. The system does not use this check box when displaying the available UOMs for an item on a requisition. The available UOMs for a requisition item are item supplier UOMs and item ordering UOMs.</p> <hr/>

Field or Control	Description
Accept Any Ship To	<p>Select this check box if you want to receive the item from the supplier at any of the ship to locations. If you do not select this check box, you must establish an item-supplier ship to relationship on the Item Ship To Locations page.</p> <hr/> <p>Note: This check box overrides the corresponding field set up for the item on the Purchasing Attributes - Purchasing Control page. If you do not select the Accept Any Ship To check box on either page, you must establish an item-supplier ship to relationship on the Item Ship To Locations page.</p> <hr/>
Stockless Item	<p>Select this check box if an agreement has been set up with the supplier to supply this item for par inventory replenishment.</p> <hr/> <p>Note: If the Stockless Item check box was not selected for the item on the Purchasing Attributes - Purchasing Controls page, it won't be available at the item-supplier level on this page.</p> <hr/>
Lead Time Days	<p>If you do not select the Use Item Standard Lead Time check box, this field is available for you to enter supplier-specific lead-time values.</p>
Check Order Multiples	<p>Select this check box if you want to use order multiples for this item supplier and location. The system will check for order multiples for all the associated UOMs for this item supplier and location.</p>
Rounding Rule	<p>When using order multiples, specify the rounding rule for the system to use so that calculations involving the item quantity that you order result in whole numbers. Options are:</p> <ul style="list-style-type: none"> • <i>Natural Round:</i> Decimal values greater than or equal to 0.5 are rounded up to the nearest whole number, and decimal values less than 0.5 are rounded down to the nearest whole number. For example, 1.223 rounds down to 1.0000, while 1.678 rounds up to 2.0000. • <i>Round Up:</i> All decimal values are rounded up to the nearest whole number. So both 1.223 and 1.678 round up to 2.0000. <p>See Understanding Order Multiple Rounding Rules.</p>

Field or Control	Description
Substitute Items	Click this link to specify substitute items at the Item Supplier Location level on the Item Supplier Location Substitute Items page.

Supplier Multi Image Setup

This example illustrates the fields and controls on the Supplier Multi Image Setup page. You can find definitions for the fields and controls later on this page.

Field or Control	Description
URL Prefix	Enter text to prefix before all the URL addresses, for example http://slc05gjm.us.oracle.com/SHARE/AM1002 .
Generate Name	Click to generate names for the fields based on the details given.
Generate URL	Click to generate URLs based on the details given.

Related Links

- [Selecting Suppliers Based on Item Ship To and Item Supplier Locations](#)
- [Purchasing Attributes -Item Supplier \(ITM_VENDOR\)Page](#)
- [Running the PO Calculations Process](#)

Item Supplier Location Substitute Items Page

Use the Item Supplier Location Substitute Items page (ITM_VNDR_SUB) to specify substitute items at the Item Supplier Location level.

Navigation:

Items > Define Items and Attributes > Purchasing Attributes > Item Supplier

Click the Substitute Items link on the Item Supplier page.

This example illustrates the fields and controls on the Item Supplier Location Substitute Items page. You can find definitions for the fields and controls later on this page.

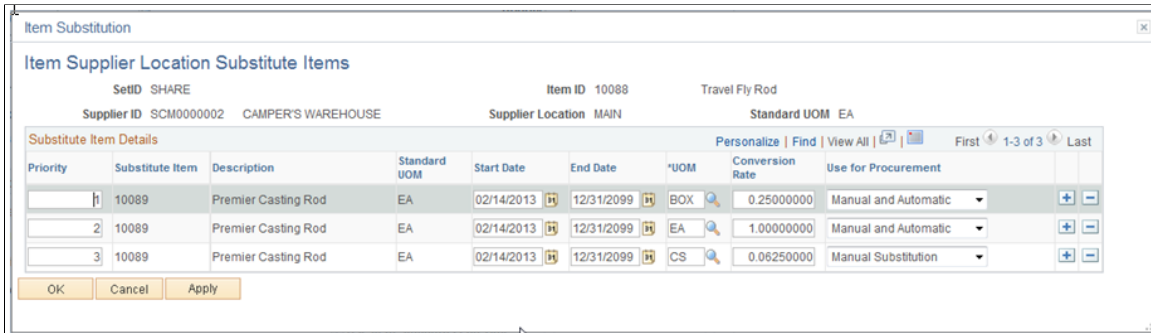

Substitute Item Details

Field or Control	Description
Priority	Enter a priority rank for the supplier location
Substitute Item	Choose Item ID from the list of items in Purchasing Attributes. The list displays all Item IDs defined in Purchasing Attributes for the specific SetID. This includes the Item ID and the Item Category Note: Only Item Ids that are defined in Purchasing Attributes can be used in the Purchasing/ePro system
Description	Displays the Substitute Item Description of the selected Item ID
Standard UOM	Displays the Substitute Item Standard UOM used for item
Start Date and End Date	Indicates the start and end date
UOM	Select Substitute item UOM that will be used on the transaction. If the Substitute item does not have an existing Item Supplier relationship, or does have one and Accept Any UOM is ON, the Substitute item UOM prompt field will display all 'Ordering' UOMs for the Item ID. If Substitute Item has an item Supplier relationship and Accept Any UOM is OFF, then Substitute Item UOM prompt field will display only Item Supplier Location UOMs.

Field or Control	Description
Conversion Rate	<p>Display the quantity of the substitute item that is required to replace the original item. The default value displayed is 1.</p> <p>However, you can modify the value as necessary. Conversion Rates are calculated by using the Substitute Item UOM listed and the Standard UOM of the Original Substituted Item. For example: The standard UOM is 1 EA for an item, 4 EA in a box, 16 EA in a case. The conversion rate of 0.25 represents 1 unit in a box and 0.0625 represents 1 unit in a case.</p>
Use for Procurement	<p>Defines whether the substitute item will be available for use in Procurement to perform Automatic Item Substitution and/or Manual Item Substitution. Choose from these options:</p> <ul style="list-style-type: none"> • Automatic Substitution: This Substitute Item will be eligible for use in Procurement when performing Automatic Item Substitution. Automatic Substitution includes automatic selection in the Requisition component (core and ePro), Requisition Selection, Requisition Expediter and the Purchase Order component, and during the PO Sourcing batch process • Do Not Use: This Substitute Item will not be eligible for use in the Procurement applications. This is the default value. • Manual Substitution: This Substitute Item will be eligible for use in Procurement when performing Manual Item Substitution. Manual Substitution includes manual selection in Requisition (core and ePro), Requisition Selection, Requisition Expediter and Purchase Order components. • Manual and Automatic: This Substitute Item will be eligible for use in Procurement when performing Manual and Automatic Item Substitution.

Supplier's UOM and Pricing Information (Supplier's unit of measure and pricing information) Page

Use the Supplier's UOM and Pricing Information (supplier's unit of measure and pricing information) page (ITM_SUPPLIER_UOM) to establish valid units of measure to use when ordering the item from the supplier and to establish the pricing information for each valid UOM.

Navigation:

Click the **Item supplier UOM** (item supplier unit of measure) link on the Purchasing Attributes - Item supplier page.

This example illustrates the fields and controls on the Supplier's UOM and Pricing Information. You can find definitions for the fields and controls later on this page.

Supplier's UOM and Pricing Information

SetID SHARE		Item ID 10088	Travel Fly Rod
Supplier SCM000002	CAMPER'S WAREHOUSE	Location MAIN	

Unit Of Measure
Find | View All First 1 of 1 Last

*UOM <input type="text" value="EA"/> Each <input type="checkbox"/> Default	Packing Details
Minimum Quantity <input type="text" value="1.0000"/>	Effective Dated UOM
Maximum Quantity <input type="text" value="0.0000"/>	Update PO
Order Quantity Multiple <input type="text" value="1"/>	

Conversion to Item Base UOM

*Rate Type <input type="text" value="Standard"/>	*Qty Precision <input type="text" value="Decimal"/>	Rounding Rule
Std UOM Rate	<input type="button" value="Get Std Rate"/>	<input checked="" type="radio"/> Natural Round <input type="radio"/> Round Up

UOM Price Attributes
Find | View All First 1 of 1 Last

*Effective Date <input type="text" value="05/30/2000"/> <small>BY</small>	*Currency Code <input type="text" value="USD"/>
*Status <input type="text" value="Active"/>	Supplier Price <input type="text" value="70.00000"/>
*Minimum Quantity <input type="text" value="1.0000"/>	Standard Price Update Status <input type="text"/>
Qty Rcvd Tolerance % <input type="text" value="0.00"/>	BU Price Update Status <input type="text"/>

Matching Controls

Unit Of Measure

<i>Field or Control</i>	<i>Description</i>
Default	Select to have the PO Calculations process use this UOM on the purchase order when this supplier is chosen to source this item to. When multiple UOMs are established for the item-supplier combination, users can select which UOM to use as the default.
Min Qty (minimum quantity) and Max Qty (maximum quantity)	<p>Enter the quantity limits for orders in the selected UOM.</p> <p>If you enter a requisition that does not fall within these quantities, you receive a warning. You do not receive an error message because consolidation may bring the request within the defined limits. If the limits are not met when the request is processed by the PO Calculations process, you receive an error message.</p> <p>If the Min Qty is not met, the system takes the previous effective dated price, whereas if the Min Qty is met, the system takes the current effective dated price.</p> <p>If you enter a purchase order that does not fall within these quantities, you receive an error message and the system uses the standard UOM and item standard price.</p>

Field or Control	Description
Order Quantity Multiple	<p>Enter the order quantity multiple for each item supplier and UOM. This field is used if you are using the order multiples functionality.</p> <p>A quantity of <i>1</i> appears by default.</p> <hr/> <p>Note: The order multiple for the UOM is applicable if the Qty Precision field value is <i>Whole Nbr</i> (whole number) only.</p> <hr/>
Packing Details	<p>Click to access the Packing Details page. Use this page to enter packing volume and weight information for the item along with item package dimensions by supplier.</p>
Effective Dated UOM (effective dated unit of measure)	<p>Click to access the Effective Dated UOM page. Use this page to enter effective-dated conversion rate changes along with packing detail information.</p>
Update PO (update purchase order)	<p>Click to access the Update Purchase Order page. Use this page to update existing purchase orders with the new effective-dated UOM conversion rate changes.</p>

Conversion to Item Base UOM

If the supplier ordering UOM for the item is different from the item's standard UOM, specify how to convert the supplier UOM.

Field or Control	Description
Rate Type	<p>Select from these values:</p> <p><i>Override:</i> Select if the standard conversion rate does not apply for this item-supplier combination. Enter a conversion rate in the field that appears. The value that you enter in this field represents the conversion rate between the supplier UOM and one unit in the standard UOM.</p> <p><i>Standard:</i> Select to use the standard conversion rate.</p> <p>For example, suppose that the standard UOM for the item is <i>EA</i> (each) and the supplier UOM is <i>BOX</i>. The standard conversion between <i>EA</i> and <i>BOX</i> is 12 to 1, that is, 12 each per box. However, this supplier has 24 eaches per box. Select the <i>Override</i> field value to specify a new conversion rate of 24 to 1.</p>

Field or Control	Description
Std UOM Rate (standard unit of measure rate)	Displays the standard conversion rate between the supplier UOM and the item's standard UOM that was established on the Units of Measure page.
Qty Precision (quantity precision)	Select the quantity precision to be used in UOM conversions: <i>Decimal:</i> Round to four decimal places. <i>Whole Nbr</i> (whole number): Round to a whole number and enable only a whole number to be entered.
Get Std Rate (get standard rate)	Click to display the standard UOM rate.

UOM Price Attributes

Field or Control	Description
Qty Rcvd Tolerance % (quantity received tolerance percentage)	Enter the quantity received tolerance percentage to be used in the receiving transactions for this item-supplier UOM combination. This field appears by default from the Purchasing Attributes - Purchasing Controls page.
Standard Price Update Status and BU Price Update Status (business unit price update status)	Select from these options for updating standard prices, business unit standard prices, or both: <i>No Update:</i> Do not update prices. <i>To Be Upd</i> (to be updated): Price is updated on the date in the <i>Eff Date</i> (effective date) field. <hr/> Note: If duplicate rows exist, the system uses these rules: If the effective dates are the same, the system checks the supplier priority. If multiple records are entered for the same supplier with the same effective date, the system selects the record with the standard UOM. <hr/> <i>Updated:</i> Price has been applied.

Matching Controls

<i>Field or Control</i>	<i>Description</i>
Use Item Standard Tolerances	Select this check box if you want to use the price tolerances established in the item's purchasing attributes. If not, specify the price tolerances in the tolerance fields provided.

Effective Dated UOM (effective-dated unit of measure) Page

Use the Effective Dated UOM (effective-dated unit of measure) page (ITM_VND_UOMCHG) to enter effective-dated conversion rate changes along with the packing detail information.

Navigation:

Click the **Effective Dated UOM** link on the Supplier's UOM and Pricing Information page.

This example illustrates the fields and controls on the Effective Dated UOM. You can find definitions for the fields and controls later on this page.

Unit Of Measure

<i>Field or Control</i>	<i>Description</i>
Effective Date	Select the date when the new conversion rate becomes effective. The current date appears by default.
Conversion Rate to Base UOM (conversion rate to base unit of measure)	Enter the new conversion rate based on the base UOM.

<i>Field or Control</i>	<i>Description</i>
Update PO (update purchase order)	Click to access the Update Purchase Order page. Use this page to update the existing purchase orders with the conversion rate change.

Packing Details

Use all the fields in this section to specify the packing details for this effective date.

Use the Packing Details page (ITM_PKG_PUR_SEC, ITM_VUOM_PKG_SEC) to enter packing volume and weight information for the item.

When accessed from the supplier's UOM and Pricing Information page, the Packing Details page also enables you to define item package dimensions, which can be useful if item package dimensions vary by supplier.

Navigation:

Click the **Packing Details** link on the Purchasing Attributes page or the supplier's UOM and Pricing Information page.

Other Information

<i>Field or Control</i>	<i>Description</i>
OK	<p>When you click this button, a message appears asking whether you want to update the item supplier UOM with these changes. You can update the information or you can choose not to update the information.</p> <hr/> <p>Note: When you are updating from this page, the Item supplier UOM is updated with the most current effective-dated UOM regardless of which effective date row is shown on this page.</p> <hr/>

Update Purchase Order Page

Use the Update Purchase Order page (PO_EDUOM_UPDPO_SEC) to update existing purchase order schedules with the new effective-dated UOM conversion rate changes

Navigation:

Click the **Update PO** link on the supplier's UOM and Pricing Information page or the Effective Dated UOM page.

This example illustrates the fields and controls on the Update Purchase Order. You can find definitions for the fields and controls later on this page.

Search Criteria

You can access this page in a few different ways. If you access this page from the supplier's UOM and Pricing Information page, most of the fields in the search criteria section of this page appear by default from that page. If you access this page from the Effective Dated UOM page, most of the fields in the search criteria section of this page appear by default from that page.

Field or Control	Description
Effective Date	<p>Select an effective date. The current date appears by default when you access this page from the supplier's UOM and Pricing Information page.</p> <p>The effective date from the Effective Dated UOM page appears by default when you access this page from the Effective Dated UOM page.</p>

Field or Control	Description
<p>PO Date Type (purchase order date type)</p>	<p>Select the date type for the system to use to retrieve the purchase orders for update. The system compares the effective date to the purchase order date type. Options are:</p> <ul style="list-style-type: none"> • <i>PO Date (purchase order date)</i>: All purchase order schedules within the purchase order lines that meet the search criteria and for which the PO date is greater than or equal to the effective date appear in the Retrieved Rows group box. • <i>Due Date</i>: All purchase order schedules within the purchase order lines that meet the search criteria and for which the due date on the schedule is greater than or equal to the effective date appear in the Retrieved Rows group box. • Price Date Type: The system first determines the price date type (PO date or due date) from the purchase order line. Then the system retrieves the information based on the two preceding scenarios. <hr/> <p>Note: Because price date type is defined at the purchase-order line level, each line is retrieved based on its price date type (PO date or due date).</p> <hr/>
<p>Search</p>	<p>Click to have the system display in the Retrieved Rows group box all the purchase order schedules that match the search criteria entered.</p>

Retrieved Rows - PO Schedules

Field or Control	Description
<p>Sel (select)</p>	<p>Click this check box next to each purchase order schedule that you want to update with the new conversion rate change.</p> <p>Click the Select All link to select all the purchase order schedules. Click the Clear All link to clear all the purchase order schedules that you previously selected.</p>
<p>PO ID (purchase order ID)</p>	<p>Click to access the Maintain Purchase Order - Purchase Order page. Use this page to view and maintain the purchase order.</p>

Retrieved Rows - Detail

<i>Field or Control</i>	<i>Description</i>
PO Conversion Rate (purchase order conversion rate)	Displays the existing purchase order conversion rate.
New Conversion Rate	Displays the new conversion rate that the system will use to update the purchase order schedules that you select.

Other Buttons

<i>Field or Control</i>	<i>Description</i>
Update Selected Rows	Click to have the system recalculate the expected standard quantity and store the new conversion rate for all the selected purchase order schedules. The new conversion rate that is used is from the most recent effective-dated row that appears on the Effective Dated UOM page compared against the effective date that you select in the search criteria.

Updating Item Supplier Unit-of-Measure Conversion Rates

This section discusses how to update item Supplier unit-of-measure conversion rates.

Page Used to Update Item Supplier Unit-of-Measure Conversion Rates

<i>Page Name</i>	<i>Definition Name</i>	<i>Usage</i>
<u>Update Item Supplier UOM (update item Supplier unit of measure) Page</u>	PO_RUN_UPDIVUOM	Initiate the Update Item Supplier UOM Application Engine process (PO_UPDIVUOM), which updates current and future item Supplier unit-of-measure conversion rate changes.

Update Item Supplier UOM (update item Supplier unit of measure) Page

Use the Update Item Supplier UOM (update item Supplier unit of measure) page (PO_RUN_UPDIVUOM) to initiate the Update Item Supplier UOM Application Engine process (PO_UPDIVUOM), which updates current and future item supplier unit-of-measure conversion rate changes.

Navigation:

Items > Define Items and Attributes > Update Item Supplier UOM

<i>Field or Control</i>	<i>Description</i>
Effective Date	<p>Select the effective date from which to update the item Supplier UOM conversion rate changes.</p> <p>The item Supplier UOM is updated with the most recent effective-dated UOM changes using the effective date that you select on this page as the reference. The effective date that you select on this page can be in the past, present, or future.</p> <hr/> <p>Note: The timing for running this process is important. If the process runs after midnight, set the future conversion rate date to the date that the rate actually becomes effective. If it runs before midnight, enter the future conversion rate date as one day earlier. Alternatively, you can modify the selection criteria to select those conversion rate changes for which the effective date is tomorrow.</p> <p>Also, to ensure that the future-dated conversion rate gets updated correctly on weekends and holidays, we suggest that you run this process every day, including weekends and holidays. Plus, we suggest that you run the process the first thing in the morning, before the start of each workday.</p> <hr/>

Capturing Item Miscellaneous Charges

To define miscellaneous charges for item and category suppliers, use the Item and Category supplier Miscellaneous Charges component (ITM_CAT_VNDR_MC).

This section discusses how to assign miscellaneous charges and templates to items and categories.

Pages Used to Capture Item Miscellaneous Charges

<i>Page Name</i>	<i>Definition Name</i>	<i>Usage</i>
<u>Miscellaneous Charges Selection Page</u>	ITM_CAT_MC_CRITERA	Enter the criteria for the miscellaneous charges that will appear on the Miscellaneous Charges - Miscellaneous page.
Miscellaneous Charges - Miscellaneous Page	ITM_CAT_VNDR_MC	Assign miscellaneous charges and miscellaneous charge templates to different item and category combinations. <u>Miscellaneous Charges Selection Page</u>

Miscellaneous Charges Selection Page

Use the Miscellaneous Charges Selection page (ITM_CAT_MC_CRITERA) to enter the criteria for the miscellaneous charges that will appear on the Miscellaneous Charges - Miscellaneous page.

Navigation:

- **Items > Define Items and Attributes > Item/Category Misc. Charges > Miscellaneous Charges Selection**
- Click the **Selection Criteria** link on the Miscellaneous Charges - Miscellaneous page.

This example illustrates the fields and controls on the Miscellaneous Charges - Miscellaneous page. You can find definitions for the fields and controls later on this page.

Field or Control	Description
Category	Select a value to associate these miscellaneous charges with a category-supplier business unit ship-to location, category supplier business unit, category supplier combination, or category. Otherwise, leave the field blank.
Item	Select a value to associate these miscellaneous charges with an item-supplier business unit ship-to location, item supplier business unit, item supplier combination, or item. Otherwise, leave the field blank.
Supplier, Location, Ship To, Unit	If you want to associate these miscellaneous charges with a combination that includes any of these fields, select a value for the field.
Template ID	To apply a template of miscellaneous charges, select the template ID. Miscellaneous charge templates are defined on the Misc Chg/Landed Cost Template (miscellaneous charge/ landed cost template) page.

Field or Control	Description
Calc Method (calculation method)	<p>Select the method to use to calculate this charge:</p> <p><i>FL</i> (flat amount): A flat amount that you enter in the Amount field.</p> <p><i>FR</i> (free): No charge is applied.</p> <p><i>UNT</i> (per unit amount): Calculates the charge based on the number of items on the purchase order line.</p> <p><i>VAL</i> (percent of value): Calculates the charge based on a percentage of the material value.</p> <p><i>VOL</i> (rate based on volume): Calculates the charge based on the total volume for the purchase order line.</p> <p><i>WT</i> (rate based on weight): Calculates the charge based on the total weight for the purchase order line.</p>
Alloc Method (allocation method)	<p>Select the method to use to allocate the miscellaneous charge: <i>None</i>, <i>Quantity</i>, <i>Volume</i>, <i>Weight</i>, or <i>Matl Value</i> (material value). Charges are allocated based on the value of the items on each selected line.</p>
Merch Supplier (merchandise supplier)	<p>This check box setting appears by default from the miscellaneous charge's purchasing attributes on the Misc Charge/Landed Cost Defn page. If you select this check box, charges are paid to the purchase order supplier. If you do not select this check box, you can use the Supplier and Supplier Location fields to designate a third-party supplier.</p>

Related Links

“Defining Miscellaneous Charges and Landed Costs” (PeopleSoft Source to Settle Common Information)

Setting Up Item Supplier Price Adjustment Rules

To set up Supplier price adjustments, use the Price Adjustment component (PRICE_ADJUSTMENT).

This section provides an overview of item supplier price adjustments and discusses how to Set Up Item Supplier Price Adjustment Rules

Pages Used to Set Up Item Supplier Price Adjustment Rules

<i>Page Name</i>	<i>Definition Name</i>	<i>Usage</i>
Price Adjustment Page	PRICE_ADJUSTMENT	Define the rules for the system should follow when calculating the supplier adjusted price from the supplier's base price. You can define effective-dated adjustment rule sequences for each item-supplier combination.
Price Adjustment Details Page	PRICE_ADJUST_DTLS	Define the quantities and adjustment methods for each of the price adjustment rules.

Understanding Item Supplier Price Adjustments

With PeopleSoft Purchasing item Supplier price adjustment features, you can define Supplier price adjustments based on specific purchase order conditions, such as item quantity and ship to locations. The pricing schemes are ultimately used on purchase orders, where you can view the details of how a particular price was calculated.

You set up supplier price adjustments for items that have item-supplier relationships already established on the Purchasing Attributes - Item Supplier page. You can define as simple or complex a pricing scheme as you need for each of the items. You can also define contract price adjustments on the PO Line Price Adjustment (purchase order line price adjustment) page and combine them with the supplier price adjustments to define specific contract pricing terms.

Related Links

[Defining Purchasing Item Attributes](#)

“Price Adjustments for Item Line Page” (PeopleSoft Source to Settle Common Information)

Price Adjustment Page

Use the Price Adjustment page (PRICE_ADJUSTMENT) to define the rules for the system should follow when calculating the supplier adjusted price from the supplier's base price.

You can define effective-dated adjustment rule sequences for each item-Supplier combination.

Navigation:

Items > Define Items and Attributes > Price Adjustments > Price Adjustment

Field or Control	Description
Calc Type (calculation type)	<p>For each adjustment rule, select one type of method by which to calculate adjustments. Choose from:</p> <p><i>Increment Adjustments:</i> Each valid adjustment is made against the current (base or adjusted) price. For example, if you have a base price of 100 and two percentage adjustments of –10 percent each, then the first adjustment is deducted from the base price of 100, for a current adjusted price of 90. The second adjustment of –10 percent is deducted from 90 for a final adjustment price of 81.</p> <p><i>Sum All Adjustments:</i> Adjustments are summed and made against the original base price. For example, if you have a base price of 100 and two percentage adjustments of –10 percent each, the system takes the total adjustment of –20 and deducts it from the base price of 100 for a final adjusted price of 80.</p>
Seq (sequence)	Enter the sequence number for each rule. Price adjustment rules are applied in ascending order.
Dflt UOM (default unit of measure)	Select to use the default UOM for the item established on the supplier's UOM and Pricing Information page. The system makes a default UOM adjustment when the UOM on the transaction is the same as the supplier default UOM or when the UOM on the transaction is not established for the item-supplier combination.
UOM Match (unit of measure match)	Select to define an adjustment rule based on a specific UOM established for the item-supplier combination.
UOM (unit of measure)	If you selected the UOM Match check box, select the UOM that you want to use for adjustments. The item-supplier UOMs must first be established on the supplier's UOM and Pricing Information page.
Match Ship	Select to define an adjustment rule based on a specific ship to location code (SetID/ship to) established for the item-supplier combination.
SetID, Ship To	Select the values if you selected the Match Ship check box.
Hard	Select to indicate a hard price adjustment. This is an adjustment that the system uses to the exclusion of all other adjustments, even those with earlier sequence numbers.
Stop Price	Select to indicate a final price adjustment. No further adjustments can be made after the system applies this adjustment.

Field or Control	Description
Ignore Flg (ignore flag)	<p>Select to create a price adjustment scenario in which this price adjustment is ignored if the order qualifies for another adjustment. If no other adjustment applies, this adjustment applies even if the Ignore Flg check box is selected.</p> <p>Suppose that you have the following price adjustment conditions for an item:</p> <p>Apply a hard 10 percent discount if the UOM matches.</p> <p>Apply a 100 USD discount, but ignore this if another adjustment applies. The Ignore Flg is selected for this adjustment.</p> <p>If you order the item in the matching UOM, the 10 percent discount is applied and the 100 USD discount is ignored, according to the selected Ignore Flg option.</p> <p>If you order the item in a nonmatching UOM, you qualify only for the 100 USD discount. Because this is the only adjustment that applies, the adjustment can be applied.</p>

Related Links

[Defining Purchasing Item Attributes](#)

“Defining Supplier Locations” (PeopleSoft Source to Settle Common Information)

Price Adjustment Details Page

Use the Price Adjustment Details page (PRICE_ADJUST_DTLS) to define the quantities and adjustment methods for each of the price adjustment rules.

Navigation:

Items > Define Items and Attributes > Price Adjustments > Price Adjustment Details

Field or Control	Description
Copy Price Adj. Qty (copy price adjustment quantity)	<p>Click to define the same price break quantities for multiple adjustment details. Define the quantities for a location on the Price Adjustment Details page, then access the Price Adjustment page and insert a new row in the Adjustment by UOM scroll area. Return to the Price Adjustment Details page, access the newly inserted detail row, and click this link to copy the adjustment quantities from the previous definition to the new definition.</p>
Min Qty/Max Qty (minimum quantity/maximum quantity)	<p>Enter the minimum purchase order quantity allowed for this price. When you insert a new range, the minimum quantity for the new range is supplied by default to the maximum quantity of the old range plus one.</p>

<i>Field or Control</i>	<i>Description</i>
Adjusted Price	<p>Enter the adjusted price that you want. The adjustment amount or percent is automatically calculated and appears.</p> <hr/> <p>Note: This column is provided for informational purposes only. If you have multiple adjustments for a particular transaction, the final adjusted price will not equal any of the adjusted prices calculated for the adjustment rules. The adjusted price provides an idea of what would happen if only the single adjustment were applied.</p> <hr/>

Updating Standard Prices and Business Unit Standard Prices

This section provides overviews of price updates and the Price Update process

You can also update future effective-dated prices by running an application engine process.

Note: You can use Item Catalog Maintenance to update item data for multiple items at one time by extracting them from the production tables into the item staging tables, where you can then alter the data.

Pages Used to Update Standard Prices and Business Unit Standard Prices

<i>Page Name</i>	<i>Definition Name</i>	<i>Usage</i>
Supplier's UOM and Pricing Information (supplier's unit of measure and pricing information)	ITM_VENDOR_UOM	Update item/supplier prices and choose to apply the price changes to the item's standard price and PeopleSoft Purchasing business unit standard prices.
Purchasing Business Unit Attributes	ITM_BU_PUR	Mark items for standard price updating at the business unit level. This is a mandatory step for updating at the business unit level.
Item Loader	RUN_IN_ITMLOAD	Mark items for standard price updating and business unit standard price updating when item/supplier UOM price records are entered in batch. The Item Loader process (IN_ITMLOAD) is run to update the PeopleSoft application tables with the item data in the Item Loader staging tables.

Page Name	Definition Name	Usage
<u>Update PO Price Page</u>	RUN_PO_PRICE_UPD	Run the Price Update application engine process (PO_PRICE_UPD) to scan the Item/supplier UOM tables to locate item/supplier prices that have become effective and calculate the item's new standard price or business unit standard price based on the item/supplier UOM price.

Related Links

“Understanding Item Catalog Maintenance” (PeopleSoft Managing Items)

Understanding Price Updates

Your PeopleSoft system may have multiple prices for an item, including the item's standard price, item and supplier price, and standard price by business unit. In addition, if a contract is in place for an item, contract pricing may override other prices. At times you may need to update prices in multiple places to keep information current when prices change and to prevent errors during the PO Build process.

The price update feature enables you to implement price changes by:

- Automatically updating an item's standard price whenever an item/supplier price with a current effective date is updated using the Supplier's UOM and Pricing Information page.
- Updating the item's standard price based on an item/supplier price that was entered in the past for an upcoming effective date.

After the future effective-dated prices are entered, and the Price Update process is run on or after the date that the item/supplier price becomes effective, the item's standard price is updated to reflect the new item/supplier pricing.

- Automatically updating an item's business unit standard price whenever an item/supplier price is updated using the Supplier's UOM and Pricing Information page.
- Updating the item's business unit standard price based on an item/Supplier price that was future effective-dated at the time that it was entered.

After the future effective-dated prices are entered, and the Price Update process is run on or after the date the price becomes effective, the item's standard price is updated to reflect the new item/Supplier pricing.

- Updating standard prices with the current effective item/Supplier prices and business unit standard prices that are loaded through the Item Loader.

Note: Changing an item's contract price does not automatically trigger changes to item/Supplier pricing or item standard prices. Contract pricing is a special pricing for purchases meeting specific criteria. Not all purchases may qualify for contract pricing; therefore, the contract price does not exist on the item definition. The system automatically assigns a contract to a purchase order when the criteria are met.

Related Links

“Understanding Item Loading” (PeopleSoft Managing Items)

Understanding the Price Update Process

The Price Update process scans the Item/Supplier tables for dates that have become effective and calculates the new standard price or business unit standard price based on the price entered for that effective date on the Supplier's UOM and Pricing Information page. It also scans for prices that have been loaded into the system with the Item Loader.

You must run the Price Update process to pick up any future effective-dated prices that have become effective and to calculate the new prices. You can also use this page to update a price that is currently effective or to update a price that is effective within a range of dates.

You must choose to use either the current date or date range. If you select the **Date Range** option, you must select a range of dates. The process compares the effective date of the Item/supplier Price record to the current date or the date range to determine whether the price is in effect. The process applies updates in the order of effective date, applying the most current effective date as the end result.

You will probably want to schedule the Price Update process to run regularly if the system includes many price changes.

Using Standard Price and Business Unit Standard Price Updating Online

To update standard prices and business unit standard prices online:

1. Use the Supplier's UOM and Pricing Information page for the item and supplier that must be updated.
2. Change the pricing on the current row in the **UOM Attributes** group box or insert a new row with a new price.

Note: For the system to prompt the automatic price change feature, the row selected for the price change cannot have a status of *Inactive*. If the row is inactive, an error message appears when the changes are saved.

3. Select *To Be Upd* (to be updated) in the **Standard Price Update Status** field to apply the price change to the item's standard price on the Purchasing Attributes - Purchasing Attributes page.
4. Select *To Be Upd* (to be updated) in the **BU Price Update Status** field to apply the price change to the standard prices by PeopleSoft Purchasing business unit.

You must also select the **Update Business Unit Price** check box on the Purchasing Business Unit Attributes page because the business unit is not specified on the Supplier's UOM and Pricing Information page.

Note: To use the price as a reference or use another supplier price, for example, you can select *No Update* instead of *To Be Upd*.

5. Verify that you have selected only one item/supplier price to update the item's standard prices.

If multiple item/supplier prices are selected when you save the item changes, the system will prompts you to proceed with the new selected item/supplier price or keep the previous selected price.

6. Click the **OK** button on the Supplier's UOM and Pricing Information page.
7. Save the Purchasing Attributes - Item Supplier page.

The system updates the standard prices as in the following way:

- If you selected *To Be Upd* (to be updated) in the **Standard Price Update Status** field and the new price is effective currently, the new price appears in the **Standard Price** field of the Purchasing Attributes - Purchasing Attributes page.
 - When the price is updated, the value in the **Standard Price Update Status** field on the Supplier's UOM and Pricing Information page is changed to *Updated* by default.
 - If necessary, the UOM and currency of the item/supplier price are converted from the Supplier UOM and currency code to the standard UOM and currency code located on the Purchasing Attributes - Purchasing Attributes page.
- If you selected *To Be Upd* (to be updated) in the **BU Price Update Status** field and the price is effective currently, all business units that match the SetID/item combination and that have the **Business Unit Update Price** check box selected on the Purchasing Business Unit Attributes page will have the new price applied.
 - When the price is updated, the value in the **BU Price Update Status** field on the Supplier's UOM and Pricing Information page becomes *Updated* by default.
 - If necessary, the UOM and currency of the item/supplier price are converted from the Supplier UOM and currency code to the standard UOM and currency code located on the Purchasing Attributes - Purchasing Attributes page.
- Any future effective-dated prices will take effect when the Price Update process has run on or after the effective date.

Note: To convert the item/supplier UOM to the item's standard UOM, the system uses the supplier override conversion factor (if one exists). When no supplier override exists, the conversion factor for the Inventory Item UOM setup process is used (INV_ITEM_UOM). If that conversion rate does not exist, the Units of Measure page is used to determine the conversion factor. If no row is on the Units of Measure page that coincides with the item/supplier UOM (from UOM) and the item standard UOM (to UOM), an error message appears.

Note: To convert the item/supplier currency to the item's standard currency, the system uses the CUR_RT_TBL record to determine the conversion factor. If no row on this record coincides with the item/supplier currency code (from currency code) and the item standard currency code (to currency code), an error message appears.

Using Standard Price and Business Unit Price Batch Updating

To update standard prices with data entered using the Item Loader:

1. Select the items that you want to update in the Item Loader.
 - a. Use the Item Loader page.

- b. In the **Item Load Type** field, select *Item Pricelist*.

This processes item data that is staged with the Item Price List EIP, ITEM_PRICELIST_LOAD.

2. Select **Update Standard Price** to update the item standard price when a currently effective item/supplier UOM price record is loaded and set the **Standard Price Update Status** field to *To Be Upd* for the future effective-dated records.
3. Select **Update Business Unit Price** to update business unit standard prices when a currently effective item/supplier UOM price record is loaded, and set the BU Price Update status to *To Be Upd* for the future effective-dated records.

To update business unit prices, you must also select the **Update Business Unit Price** check box for all items on the Purchasing Business Unit Attributes page.

4. Mark items on the Purchasing Business Unit Attributes page for standard price updating at the business unit level.

Select the **Update Business Unit Price** check box and click the **OK** button to save the changes.

When you are updating with prices loaded using the Item Loader, this step enables business units that match the SetID/item combination to have the new price applied.

5. For any future effective-dated prices, run the Price Update process on or after the effective dates.
 - a. Access the Price Update page.
 - b. Use the page controls to select criteria for the price updates.

The Price Update process scans the Item/supplier tables for dates that have become effective and calculates the new standard price based on the price entered for that effective date on the item/supplier UOM price entered with the Item Loader.

Related Links

“Understanding Item Loading” (PeopleSoft Managing Items)

Update PO Price Page

Use the Update PO Price page (RUN_PO_PRICE_UPD) to run the Price Update application engine process (PO_PRICE_UPD) to scan the Item/supplier UOM tables to locate item/supplier prices that have become effective and calculate the item's new standard price or business unit standard price based on the item/supplier UOM price.

Navigation:

Items > Define Items and Attributes > Update PO Price

This example illustrates the fields and controls on the Update PO Price page. You can find definitions for the fields and controls later on this page.

You can use the filter controls on this page to limit the prices to be updated.

Date Range

<i>Field or Control</i>	<i>Description</i>
As of Date	Select to process prices that are currently effective.
Date Range	Select to process prices that are in effect within the range that you specify in the Date From/Date To fields.

Selecting Suppliers Based on Item Ship To and Item Supplier Locations

To define item ship to locations, use the Item ShipTo Locations component (ITM_SHIPTO_VNDR). Use the ITM_SHIPTO_VNDR_CI component interface to load data into the staging tables for this component.

This section discusses how to define priority vendors for specific item and ship to location combinations. For more information about defining priority vendors for specific item and supplier location combinations, see the "Using Purchase Order Sourcing" topic. The pages are similar.

See [Sourcing by Region](#).

Note: The PO Calculations process selects a supplier for an item/ship to location combination based on the definition on this page (if the **Override Suggested supplier** option is selected on the Sourcing Controls page).

Pages Used to Select Suppliers Based on Item Ship To and Item Supplier Locations

<i>Page Name</i>	<i>Definition Name</i>	<i>Usage</i>
<u>Item Ship To Locations Page</u>	ITM_SHIPTO_VNDR	Set up a prioritized list of supplier and supplier locations for a particular item and ship to location combination.
Item Supplier by Region Page	ITM_REGION_VNDR	Define supplier priority and supplier location by region. <u>Item Ship To Locations Page</u>

Item Ship To Locations Page

Use the Item Ship To Locations page (ITM_SHIPTO_VND) to set up a prioritized list of vendors and Supplier locations for a particular item and ship to location combination.

Navigation:

Items > Define Items and Attributes > Item Ship To Locations

<i>Field or Control</i>	<i>Description</i>
SetID and Ship To	Select each shipping location that you're defining for the item. Ship to location codes are established on the Ship To Locations page.
Region Code	Select a region code to associate to this ship to location.
Include in Planning	Select to enable purchase options to be created in PeopleSoft Supply Planning for the PeopleSoft Inventory business unit related to this ship to location. The purchase option then enables the creation of new purchase orders through PeopleSoft Supply Planning for this PeopleSoft Inventory business unit. If this check box is not selected at the item and ship to level, it will not be available at the item ship to supplier level in the List of supplier grid box.

List of Supplier

Field or Control	Description
Supplier SetID	Select a Supplier SetID. You cannot select a SetID value and supplier that already exists in another row when the record definition does not allow duplicate entries.
Priority	Displays the priority value for the Supplier SetID and supplier combination with 1 being the highest priority.
Supplier	Select a Supplier. Available supplier are those for which item supplier relationships have been established on the Purchasing Attributes - Item Supplier page.
Location	Select the Supplier location.
Ship Via	Select the shipping method for this item supplier.
Lead Time	<p>Enter the lead time for shipping to the item ship to location.</p> <p>This lead time accommodates multiple sites receiving goods from the same supplier location where each location requires its own lead time. The lead time defined at this level with the lead time option of <i>Use</i> will be the first level default value. If a value is not specified at this level, the system checks the item supplier by region.</p>
Lead Time Option	<p>Select the lead time option that you want to use at this item/ship to level. When suppliers are assigned to requisitions in purchasing, the purchasing system checks a hierarchy to find the highest priority suppliers. First, it checks for supplier priorities based on the item/ship to location. Next, it checks supplier priorities based on the item/region. And, finally it checks supplier priorities based on the item. PeopleSoft Supply Planning uses this feature, for example, if a purchase option does not have adequate lead time, the Supply Planning can go to the next prioritized option to determine whether it can use that option to meet the demand.</p> <p>Select <i>Default</i> to use the next level lead time (item/region). Select <i>Use</i> to use the lead time defined at this level. If you do not specify a value for use at the first two levels, the system checks the item supplier followed by the purchase item.</p>

Field or Control	Description
Include in Planning	<p>Select to enable purchase options to be created in PeopleSoft Supply Planning for the PeopleSoft Inventory business unit related to this ship to location.</p> <p>The purchase option then enables the creation of new purchase orders through PeopleSoft Supply Planning for this PeopleSoft Inventory business unit. If this check box is not selected at the item/ship to level, it will not be available at the item ship to supplier level in the List of suppliers grid box.</p>

Related Links

“Defining Supplier Locations” (PeopleSoft Source to Settle Common Information)
[Defining Purchasing Item Attributes](#)

Creating Purchasing Kits

To define purchasing kits, use the Purchasing Kit component (ITM_CONFIG_TBL).

This section provides an overview of purchasing kits and lists the page used to create purchasing kits.

Page Used to Create Purchasing Kits

Page Name	Definition Name	Usage
Purchasing Kit Definition Page	PURCH_KIT_TBL	Define purchasing kits.

Understanding Purchasing Kits

A purchasing kit is a set of components that comprise two or more items. Purchasing kits contain items and quantities that are often ordered together.

When you enter a requisition or purchase order, you can order by purchasing kit ID to capture all items and quantities in the kit instead of entering each item and quantity separately.

When you enter a purchasing kit ID on a transaction line, the system creates a separate line for each of the kit's component items. The quantity of each line item is by default the quantity of that item per kit multiplied by the number of kits that you order. For example, if a kit includes one CD-ROM drive and two speakers and you order two kits, the system generates a line for the CD-ROM drive with a quantity of two and a line for the speakers with a quantity of four.

The account and alternate account that you define on the purchasing kit definition appears on the requisition distribution line when you associate a purchasing kit with a requisition.

Working With Substitute Items in Procurement

This topic provides an overview of Item Substitution in Procurement and discusses how to set up substitute items in Procurement.

Understanding Item Substitution in Procurement

Suppliers periodically backorder certain items and offer a substitute item that can replace the original item, thus avoiding shipping delays and partial orders. PeopleSoft Purchasing offers requestors in organizations or companies a way to track which items, according to the supplier, were back ordered and to procure automatically the supplier's substitute item. After the buyer enables item substitutions, the system records current or future item substitutions at the time of requisition and updates the purchase order automatically. The system supports both manual and automatic selection of item substitutes based on the item SetID in order to dispatch an updated purchase order to the supplier, thus resolving matching issues between the purchase order and received items.

Item substitution is enabled in Procurement transactions when Item Substitution is enabled for the Purchasing Business Unit. You can specify whether items will be substituted manually or automatically in the requisition, in online Requisition Selection, in purchase order components, in a requisition, and during PO Batch Sourcing. You can also indicate whether a requester has the ability to accept or reject a substitute item in the requisition and whether a procured item will be visible to the end user.

Item substitution can be set up at the Item Supplier Location and Item levels. At each of these levels, you can control whether the item will be available for manual or automatic substitution or not available. The system will automatically search at the Item Supplier Location level for valid item substitutions using the item, supplier, and supplier location, and then it will select a substitute item whose Use for Procurement value is set for Automatic or Automatic and Manual substitution. If any substitutions are found, the system will select the substitute item with the highest priority and for which the transaction date is within the begin date and end date ranges. If no item substitution is found at the Item Supplier Location, then the system will search the Item Substitution level for valid items to substitute. If a substitute item is found, the user will be prompted to accept or reject the substitute item. If the user accepts it, then the substitute item will replace the item and the system will store the originally entered item in the Original Item Substituted field, convert the transaction unit of measure (UOM) to the substitute item's UOM, and select the substitute item's pricing into the transaction. Item substitution selection will be based on the original item substituted. Visual indicators will appear in procurement transactions to indicate whether an item was substituted. You can also use the **Item Substitution Search** icon to select item substitutions manually for your Procurement transactions.

Manual Item Substitution

Use the Manual Substitute Items search page to view all Substitute Items at both the Item Supplier Location level (if a Supplier ID/Location is available) and the Item SetID level if the Substitute Item is marked for Manual Substitution or for Manual and Automatic substitution.

You can access the Substitute Item search page from the Requisition line, the Requisition Selection line, or the Purchase Order line when you click the **Item Substitution Search** icon.

This example illustrates the fields and controls on the Substitute Items search page. You can find definitions for the fields and controls later following this example.

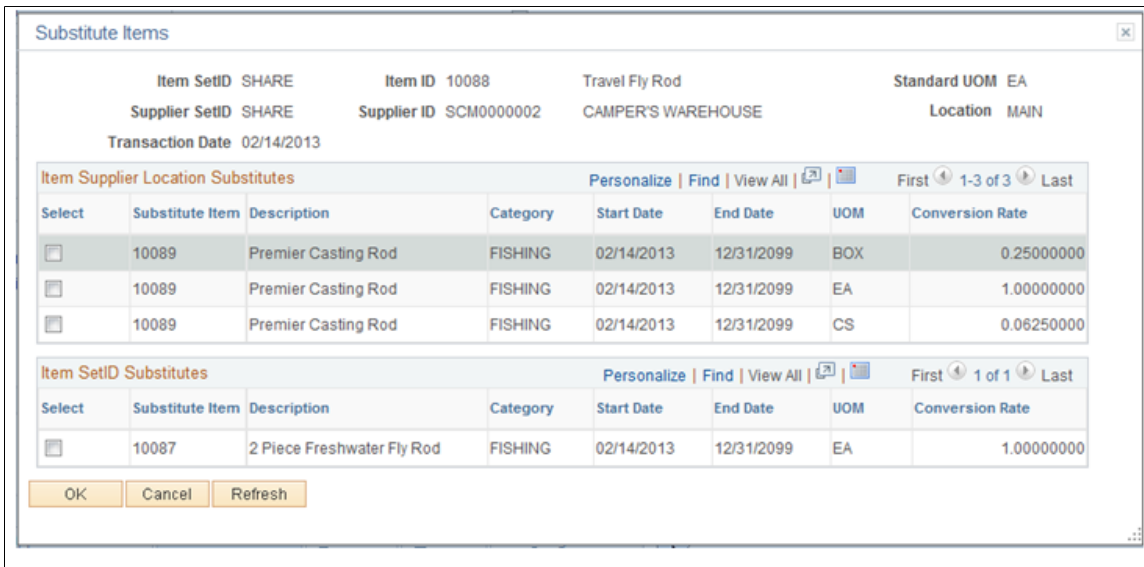

Field or Control	Description
Description	Displays the Substitute Item description for the selected Item ID.
Category	Displays the Substitute Item Standard UOM used for the item.
Start Date and End Date	Indicates the start and end dates.
UOM	Select the UOM (unit of measure) of the Substitute item that will be used in the transaction. If the Substitute Item does not have an Item Supplier relationship or if it does but Accept Any UOM is turned on, then the Substitute item UOM prompt field will display all Ordering UOMs for the Item ID. If the Substitute Item has an Item Supplier relationship and Accept Any UOM is turned off, then the Substitute Item UOM prompt field will display only Item Supplier Location UOMs.
Conversion Rate	Displays the quantity of the substitute item that is required to replace the original item. The default value is 1, however, you can modify the value as necessary. Conversion Rates are calculated by using the Substitute Item UOM listed and the Standard UOM of the Original Substituted Item.

The search page displays all Substitute Items at both the Item Supplier Location level (if a Supplier ID/Location is available) and Item SetID level where the substitute item is configured as Manual Substitution or Manual and Automatic substitution. It also displays substitute items that are available on the Transaction Date that appears in the header of the Substitute Items search page.

- If the PO Item Supplier Security option for the transaction's PO business unit is *Edit Required Must Use Item ID* or *Edit Required When Use Item ID*, then the search page displays only substitute items that have an Item Supplier relationship established for the current supplier, which appears in the search page.
- This page will not display Items that have the Accept Any Supplier check box deselected and that do not have an existing Item Supplier relationship.
- The search page displays the Substitute Items that are in a Catalog assigned to the requester.
- The search page will display the substituted items if the Original Substituted Item field on the transaction line has a value. If the Original Substituted Item field does not have a value, then the Item ID on the transaction line will appear in the search page.

Automatic Item Substitution

When auto item substitution is enabled for the Purchasing business unit, the system will automatically find substitute items if they are available when a purchase order or requisition is created or changed. If item substitutes exist for an ordered item, the following message will prompt the user to accept the suggested item substitute:

“A Substitute Item has been found. Do you want the Substitute Item to replace the current Item ID at this time? (Yes or No)”

- If you select No, the system will not replace the current Item ID with the substitute item, and item substitution will not occur. The Automatic Item Sub check box will be deselected automatically in the Requisition line.
- If you select Yes, the system will replace the current Item ID with the substitute item, all Item Substitution fields will be updated correctly, and UOM Conversion will be performed.

When a change is made to an existing Requisition or PO line, the following actions should occur:

- If the **Item ID** field is changed and the **Original Substituted Item** field is populated, then the **Original Substituted Item** and **Original Substituted Item** description fields will be cleared and the **Substitute Item in Use** indicator will be disabled or hidden.
- If the Qty or UOM is changed and the **Original Substituted Item** field is populated, then the Automatic Item Substitution steps repeat to check for substitute items for the original substituted item (not Item ID) as the current substitute item may no longer be valid after the change or a more appropriate substitute item may be available for the original substituted item.
- If the Supplier ID is changed in a Requisition line or Purchase Order header and the Requester or Buyer selects Yes in the Warning message to continue, then the **Original Substituted Item** field is cleared and moved back to the **Item ID** field. The Automatic Item Substitution steps repeat to check for substitute items for the Item ID and the new supplier.
- If a requisition or purchase order is pegged to a source transaction and you substitute the item, then the pegged relationship will be broken.
- If a requisition line is either partially or fully sourced, then item substitutes will not be considered.
- If a purchase order line was previously dispatched or the Item ID is grayed out for any reason, then Item Substitution will not be considered.

When an Item ID is entered in a Requisition line by any of the following methods, the Automatic Item Substitution steps occur for each new line:

- Purchasing Kit
- Item Search
- Catalog
- Requester Items
- ePro Favorites
- Personal Templates

When a requisition is saved and the Requester Items and ePro Favorites are updated, if the **Original Substituted Item** field is populated, then a user can save this Item, rather than the substitute item, as a Favorite. This capability ensures that an item marked as a Substitute Item Only is not saved as a Requester Item or a Favorite and then selected in a subsequent requisition.

When an Item ID is entered in a Purchase Order line by any of the following methods, the Automatic Item Substitution steps occur for each new line:

- Purchasing Kit
- Item Search
- Catalog

When using the Copy From feature to copy a requisition into a new requisition or a purchase order into a new purchase order, the **Original Substituted Item** field for each transaction line is cleared and the value is moved back to the **Item ID** field. The Automatic Item Substitution steps repeat to check for current substitute items.

When a requisition is copied to a purchase order, if the **Original Substituted Item** value is populated in the Requisition line, then a user can perform the Automatic Item Substitution steps to check for substitute items of the Original Substituted Item (not Item ID), as the current substitute item may no longer be valid or a more appropriate substitute item may be available for the Original Substituted Item. If the **Original Substituted Item** field is not populated, users can perform the Automatic Item Substitution steps to check for substitute items for the Item ID.

When a contract is copied into a purchase order, no Automatic Item Substitution occurs. This is because the Contract line cannot be tied to a purchase order line when the Item IDs do not match. The contract can be updated before it is copied to a purchase order.

Automatic Item Substitution during PO Sourcing will occur based on the following:

If Automatic Item Substitution is selected at the Business Unit level, the **Auto Item Substitution** field is selected, and the **Original Substitute Item** field on the staging record is populated, then the Sourcing process will use this Item ID when searching for substitute items. However, if the **Original Substituted Item** field on the staging record is not populated, then it will use the Item ID value when searching for substitute items.

The Sourcing process uses the Item Substitute Usage Rules to search for substitute items, and it determines the most appropriate substitute item to use for the Original Substituted Item value.

If a Substitute Item was specified in the Requisition and PO Sourcing found a different item substitute (perhaps one with a different date), then PO Sourcing uses the most valid Substitute Item for the purchase order. PO Sourcing will update the Original Substituted Item and Description values if it finds a valid substitute. The system does not check for substitutes of substitutes.

PO Sourcing bypasses Item Substitution if a Procurement Group is associated with the line and the item is the Primary Unit for the Procurement Group or the **Allocate Purchasing Group** option is enabled in the Business Unit Options table.

PO Sourcing follows the same UOM Conversion and Pricing logic that is used for online requisitions.

Example: Item 10012 is selected in a requisition. An applicable item substitute item does exist for this item. Because the Business Unit level option indicates that a requester's item can be substituted, the item in the requisition is changed to 10012A. PO Sourcing will determine whether a valid substitute exists for item 10012, the original item in the requisition. If item 10012B is now the most valid item substitute, then this item will be used in the requisition.

Item Substitute Usage Rules

Substitute items are established in the Item Supplier Location Substitution Items page and Item Substitution page. The system evaluates whether to use a substitute item from the Item Supplier Location Substitution Items page first. If none is found, the system evaluates whether a valid substitute item exists at the Item Substitution level. If the Business Unit Security option is *Edit Required Must Use Item ID* or *Edit Required When Use Item ID*, then you must establish an item supplier relationship for the substitute item.

A valid substitute item will be selected from the Item Supplier Location Substitution Item level if the Use for Procurement value is *Automatic* or *Automatic and Manual*. If the date of the transaction is within the Begin Date and End Date of the substitute item, then the rows with the highest priority will be considered first. If the Purchasing Attribute Option - Accept Any UOM is turned off, then an item substitution UOM must be set up as a valid Item Supplier UOM.

A valid substitute item will be selected from the Item Substitution level if none has been found from the Item Supplier Location Substitution Item level. If the Use for Procurement value is *Automatic* or *Automatic and Manual* and the date of the transaction is within the Begin Date and End Date of the substitute item, then the rows with the highest priority will be considered first. If the Purchasing Attribute Option - Accept Any UOM is turned off, then an item substitution UOM must be set up as a valid Item Supplier UOM.

Item Substitution UOM Conversion Logic

If the Original Item on the transaction is in the Standard UOM, then the Substitute Item Conversion Rate between the two Items defined on the Substitute Item setup pages is used to determine the unit of measure (UOM) conversion. If the Original Item on the transaction is *not* in the Standard UOM, then the conversion between the Original Item Standard UOM and the Transaction UOM is determined first, followed by the Substitute Item Conversion between the two Items defined in the Substitute Item setup pages. While performing the Item Substitute UOM Conversion, if the Quantity Precision associated with the resulting Item Supplier UOM record is available and if Quantity Precision is the value Whole Number, then the Quantity is rounded according to the Rounding Rule.

After the UOM Conversion has occurred on the transaction line, Pricing is determined using the available Item Supplier UOM or the Standard UOM Price multiplied by the Item UOM conversion rate.

A breakdown of the UOM Conversion and Pricing logic, along with examples, follows:

Step 1: Convert Transaction UOM of the Original Item to Standard UOM of the Original Item.

This step is applicable only if the Transaction UOM is *not* the Standard UOM for the Original Item.

Example:

The Transaction UOM is BOX, and the Standard UOM is EA. One BOX contains 4 EA. The Transaction Qty is 10 BOX. The converted Qty and UOM is 40 EA.

Transaction Qty	Transaction UOM	Multiplied By	Conversion Rate Between Standard UOM and Transaction UOM	Equals	Converted Qty	Converted UOM
10	BOX	*	4	=	40	EA

Step 2: Convert Original Item Standard UOM to Substitute Item UOM.**Example:**

Original Item Standard UOM is EA. Substitute Item UOM is CS. One CS contains 16 EA, so the UOM Conversion between EA and CS is 0.0625. The order Qty of the Substitute Item is 2.5 CS.

Converted Qty	Converted UOM	Multiplied By	Conversion Rate Between Item Std UOM and Sub Item UOM	Equals	Order Qty	Order UOM
40	EA	*	.0625	=	2.5	CS

Note: If Quantity Precision is defined as Whole Number on the Supplier's UOM and Pricing page, then the Qty of 2.5 is rounded according to the Rounding Rule.

Step 3: Find the Price for the Substitute Item UOM.

The Price is obtained from the Supplier's UOM and Pricing in the Purchasing Attributes if the UOM is defined on this page. If it is not, then the Price is derived from the Substitute Item Standard UOM Price.

Example:

The Substitute Item UOM of CS is *not* defined in the Supplier's UOM and Pricing in the Purchasing Attributes. The Substitute Item Standard UOM of EA has a Price of 10 USD. The Conversion Rate between the Standard UOM of EA and the Ordering UOM of CS is 16. The Price for the Substitute Item UOM is calculated as 160 USD per CS.

<i>UOM Defined in Supplier's UOM & Pricing Page</i>	<i>Substitute Item Standard UOM Price</i>	<i>Multiplied By</i>	<i>Conversion Rate Between Standard UOM and Order UOM</i>	<i>Equals</i>	<i>Order Price</i>
N	10 USD	*	16	=	160 USD

Setting Up Substitute Items in Procurement

To allow Item Substitution in Procurement, you must enable Item Substitution at the business unit level in order to activate the item substitution functionality. You can then determine the item substitution options that work best for your organization or company. This section discusses how to:

- Set up item substitution at the Purchasing business unit level.
- Define item substitution priorities at the supplier level.
- Define item substitution priorities at the item level.
- Designate items for substitution only.
- Override auto item substitution.

Setting Up Item Substitution at the Purchasing Business Unit Level

Use the Business Unit Options page to set up Item Substitution for a Purchasing Business Unit.

Navigation:

Set Up Financials/Supply Chain > Business Unit Related > Purchasing > Purchasing Definition > Business Unit Options

This example illustrates the fields and controls on the Purchasing — Business Unit Options page. The fields and controls that appear in this page are discussed following the examples.

The screenshot shows the 'Business Unit Options' page with the following sections:

- Business Unit Definition:** Unit US001 US001 NEW YORK OPERATIONS
- *PO Item Supp Security Option:** No Edit Required
- Origin:** ONL
- DUNS Number:** 12345
- *PO Price Edit:** Warning
- Tax Exempt ID:** (Empty field)
- *PO Close Contract Option:** Error
- Sourcing Controls:**
 - % Unit Price Tolerance Over: 25.00
 - Tolerance Under: 25.00
- When Contract is Specified on Requisition:**
 - Allow Req Consolidation
 - Allow Source to Inventory
- Liquidate Method:**
 - Allow Liquidate by Quantity when Distribute by Quantity
 - *Default Liquidate Method: Amount
- Item Substitution Controls:**
 - Enable Item Substitution
 - Allow Item Substitute Online Search:
 - Requisition
 - Requisition Selection and Purchase Order
 - Allow Auto Item Substitution:
 - Requisition
 - Requisition Selection
 - PO Sourcing and Purchase Order

This example illustrates the fields and controls on the Purchasing — Business Unit Options page (2 of 2). The fields and controls that appear on this page are discussed following the examples.

The screenshot shows the following sections in detail:

- Item Substitution Controls:**
 - Enable Item Substitution
 - Allow Item Substitute Online Search:
 - Requisition
 - Requisition Selection and Purchase Order
 - Allow Auto Item Substitution:
 - Requisition
 - Requisition Selection
 - PO Sourcing and Purchase Order
- PO Close Short Controls:**
 - PO Close Short Rule ID: (Searchable field)
 - Close Short Set Override
- Receiving Controls:**
 - Receipt Date Adjustment: 10
 - Receipt Date Exchange Rate: PO Date
 - Receipt Close Delay Days: (Empty field)
 - *Receipt Allocation Type: Split Distributions
 - *Delivery Signature Required: Default to Installation value
 - Separate Inspection
 - Accrue PO Receipts
 - Accrue Federal Inventory Receipt
 - Allow Receipt Load Cascade
 - Accrue Non/PO Receipts
 - Allow Curr UOM Conv Rate
- Return To Vendor Controls:**
 - RTV Inventory Ship Option: Manual
 - RTV Inventory Destroy Option: Manual
 - RTV Dispatch Option: Manual
 - RTV Adjust Source
 - RTV Reopen PO
 - RTV Adjust Fees
 - Notify Inventory Manager

The **Business Unit** level option controls whether Item Substitution is turned on for the Purchasing business unit. When you select the **Enable Item Substitution** check box at the Business Unit Options level, the Allow Manual Item Substitution and Allow Auto Item Substitution sections will become available for selection.

If you select check box, all **Item Substitute** fields will be enabled on the Requisition, the Requisition Selection/Requisition Expediter, the Sourcing Workbench, the purchase order, the receipt, and other applicable components, as needed.

The Requisition check box under the Allow Item Substitution section allows you to enable manual item substitution on the Requisition (core and ePro). The Requisition Selection and check box allows you to enable manual item substitution during Requisition Selection and on the Purchase Order.

The **Requisition** check box under the Allow Auto Item Substitution section allows you to enable manual automatic item substitution on the Requisition (core and ePro). The **Requisition Selection and PO Sourcing and Purchase Order** check boxes allow you to enable manual item substitution during Requisition Selection, PO Sourcing, and on the Purchase Order.

Note: While setting up the item substitution controls, you must ensure that you have selected at least one check box in the Allow Item Substitute Online Search and Allow Auto Item Substitution sections.

See [Establishing PeopleSoft Purchasing Business Units](#).

Defining Item Substitution Priorities at the Supplier Level

Item substitutes defined at the Item Supplier Location level will apply only to a specific supplier. However, if the Purchase Order Item Supplier Security option for the transaction's business unit is *Edit Required Must Use Item ID* or *Edit Required When Use Item ID*, then the substitute items without an item-supplier relationship will not be available for manual item substitution selection and they will not be provided by default.

See [Defining Purchasing Item Categories Selecting Suppliers Based on Item Ship To and Item Supplier Locations](#)

Defining Item Substitution Priorities at the Item level

Item substitutes defined at the Item level will apply to all suppliers.

See [Defining Purchasing Item Categories](#).

Designating Items for Substitution Only

You can filter substitute items during item searches in Procurement transactions if you designate the item for substitutions only. In this case, the substitute item will not be available in any Item ID prompt fields throughout the Procurement system. Instead, the Item ID is considered a substitute item for exclusive use as part of the Manual and Automatic Item Substitution process within the Procurement process.

See [Defining Purchasing Item Attributes](#).

Overriding Auto Item Substitution

The **Override Auto Item Substitute** field on the Requester Setup page enables you to deselect the **Auto Item Substitution** check box on a Requisition Line when you want to retain the current Item ID and do not want it automatically substituted during PO sourcing. Additionally, you will be able to reject a Substitute Item found by Auto Item Substitution in the online Requisition.

If you select the **Override Auto Item Substitute** check box on the Requestor Setup page, the **Auto Item Substitute** check box in the requisition line will be ungrayed and it will be selected. You can also deselect

this check box if you want to prevent Automatic Item Substitution from occurring for a Requisition line during the Sourcing process.

Selecting this check box also means that if Auto Item Substitution occurs for a Requisition line and a Substitute Item is found, then the Requester can answer No to prevent the Sub Item from overriding the requested item.

If you do not select the check box, then the **Auto Item Substitution** check box on the Requisition line will be grayed out and selected, and the Requester cannot deselect it. (The Buyer will still have the option to deselect this flag in Requisition Selection.)

See“Defining Requesters” (PeopleSoft Source to Settle Common Information).

Defining Miscellaneous Charges and Landed Costs

Understanding Miscellaneous Charges

You can add miscellaneous charges to a purchase order in addition to sales and use taxes and value-added taxes (VAT). Miscellaneous charges can include freight, set up, insurance, and a variety of other costs incurred to deliver purchased goods to a location. Designating the charge as a "landed cost component" also enables you to incorporate the additional cost into the item's inventory value.

If you have PeopleSoft Inventory and PeopleSoft Cost Management installed, the landed cost charges may be defined as additional costs, beyond the merchandise value of the item. Depending on the costing method defined for the inventory item, the values associated with the additional costs are used to value inventory transactions or treated as variances against the item's standard cost. Comparisons of estimated and actual landed costs are provided through PeopleSoft Cost Management reports.

If you do not have PeopleSoft Cost Management installed, you can still define and use miscellaneous charges that are added to the purchase orders. You can set up PeopleSoft Purchasing to automatically calculate miscellaneous charges based on items, item and supplier combinations, and other criteria. A calculation method is assigned to each miscellaneous charge, and an allocation method is assigned to each component. Alternatively, you can manually add miscellaneous charges on the purchase order.

To use miscellaneous charges and landed costs in PeopleSoft Purchasing, set up miscellaneous charges on the Misc Charge/Landed Cost Defn page.

Optionally, you can use the Misc Chrg/Landed Cost Template page to define templates that group several miscellaneous charges. These templates can be associated with an item, category, purchase order, or purchase order schedule. Receipt lines are assigned the estimated costs of their associated purchase order schedule.

Once you have created miscellaneous charges and miscellaneous charge templates, you can assign them to purchase orders on the Header - Miscellaneous Charges page. You can also assign miscellaneous charges and templates to items and categories using the Miscellaneous Charges - Miscellaneous page.

Related Links

[Header Misc. Charges \(header miscellaneous charges\) Page](#)

[Capturing Item Miscellaneous Charges](#)

[Miscellaneous Charges Selection Page](#)

“PeopleSoft Cost Management Reports: A to Z” (PeopleSoft Cost Management)

“Defining Miscellaneous Charges and Landed Costs” (PeopleSoft Source to Settle Common Information)

“Defining Miscellaneous Charge and Landed Cost Templates” (PeopleSoft Source to Settle Common Information)

Defining Miscellaneous Charge Defaults

To populate the purchase orders with the correct miscellaneous charge codes or landed cost templates, you must design a series of parameter combinations. When you enter a purchase order that matches the combination of parameters that you defined, the assigned charge code or template is used.

You can set up default miscellaneous charges that are automatically calculated based on the following combinations, where level one overrides level two, and so on:

Level	Miscellaneous Charge Hierarchy Criteria
1	Item, supplier, business unit, and ship to location. (INV_ITEM_ID, Supplier_ID, BUSINESS_UNIT, and SHIPTO_ID)
2	Item, supplier, and business unit. (INV_ITEM_ID, Supplier_ID, and BUSINESS_UNIT; and no SHIPTO_ID)
3	Item and Supplier. (INV_ITEM_ID and Supplier_ID; and no BUSINESS_UNIT nor SHIPTO_ID)
4	Item. (INV_ITEM_ID; and no Supplier_ID, BUSINESS_UNIT, nor SHIPTO_ID)
5	Category, supplier, business unit, and ship to location. (CATEGORY_ID, Supplier_ID, BUSINESS_UNIT, and SHIPTO_ID; and no INV_ITEM_ID)
6	Category, supplier, and business unit. (CATEGORY_ID, Supplier_ID, and BUSINESS_UNIT; and no INV_ITEM_ID nor SHIPTO_ID)
7	Category and supplier. (CATEGORY_ID and Supplier_ID; and no INV_ITEM_ID, SHIPTO_ID, nor BUSINESS_UNIT)
8	Category. (CATEGORY_ID; and no INV_ITEM_ID, Supplier_ID, BUSINESS_UNIT, nor SHIPTO_ID)

For example, you can set up miscellaneous charges that are automatically calculated on the purchase order when a certain item is ordered from a particular supplier, for a particular business unit, and a specific ship to location of the business unit. You can also set up a miscellaneous charge that is automatically calculated for a particular item.

Only one Miscellaneous Charges - Miscellaneous page combination is used. The higher level overrides the lower level. For example, suppose that you defined miscellaneous charges for an item (level 4), and also for the category (level 8) to which the item belongs, only the miscellaneous charges that you defined for the item are used. The miscellaneous charges that you defined for the category are only used for items that do not have miscellaneous charges specifically defined.

Chapter 7

Using Workflow

Understanding PeopleSoft Purchasing Workflow

Many daily tasks are part of a larger process that involves several steps and people working together. The term *workflow* refers to this process, which could encompass, for example; approving a purchase order or notifying a manager of an exception. To facilitate this type of multiuser process, PeopleSoft can automatically trigger workflow notifications to inform the next person in the process of work awaiting them.

Use PeopleSoft workflows to:

- Automate the information flow.
- Enforce business process rules.
- Combine the tasks of several users into a business process.

PeopleSoft offers two types of workflow:

1. PeopleTools Workflow Technology documented in the *PeopleTools : Workflow Technology*. This method is used to approve transactions and generate workflow notifications of various events. To setup this workflow, users must possess technical skills in PeopleSoft PeopleTools to create and maintain workflow using PeopleSoft Application Designer, PeopleCode, and Workflow Administrator.
2. PeopleSoft Approval Framework documented in the *PeopleSoft FSCM 9.2 : Approval Framework*. This method is used to approve transactions. The approval framework requires less technical skills than the PeopleTools workflow technology. For example, all of the steps in approval framework are defined by means of PeopleSoft pages rather than the underlying PeopleSoft PeopleCode, so functional users can design and maintain workflow using these online PeopleSoft pages without technical developers having to create workflow rules. In addition, the approval framework enables you to approve transactions at the line level and use several additional approval features.

Within PeopleSoft Purchasing, the PeopleTools workflow technology is used for all workflow notifications. Purchase orders and requisitions can be approved using the approval process within the PeopleTools workflow technology or the approval framework. This choice of workflow method is made at the business unit level. PeopleSoft eProcurement uses the approval framework to approve requisitions and purchase orders.

Setting Up the Approval Framework for PeopleSoft Purchasing

Set up the Approval Framework in PeopleSoft Purchasing.

Set up Email Approvals for PeopleSoft Purchasing.

Pages Used to Set Up Approval Framework in PeopleSoft Purchasing

Page Name	Definition Name	Usage
User Profiles - Roles Page	USER_ROLES	Attach workflow roles to users. "Defining Users for Approval," <i>PeopleSoft FSCM 9.2 : Approval Framework.</i>
User Profiles - Workflow Page	USER_WORKFLOW	Define supervisors. "Defining Users for Approval," <i>PeopleSoft FSCM 9.2 : Approval Framework.</i>
User List Definition Page	PTAF_USER_LIST	Define user-list definitions. "Defining User Lists," <i>PeopleSoft FSCM 9.2 : Approval Framework.</i>
Requester Setup Page	REQUESTOR_TBL	Establish default information for requesters.
User Preferences: Procurement - Requisition Authorizations Page	OPR_REQ_AUTH	Authorize users to initiate and update requisitions for applicable requesters. Enable users to approve requisitions. Define a user's requisition processing authority in relation to applicable requesters.
Buyer Setup Page	BUYER_TBL	Establish default information for buyers.
User Preferences: Procurement - Purchase Order Authorizations Page	OPR_PO_AUTH	Authorize users to initiate and update purchase orders for applicable buyers. Enable users to approve purchase orders. Define a user's purchase order processing authority.
Change Template Page	CHNG_ORD_TEMPLATE	Identify the fields on a requisition, purchase order, or contract that can initiate the following actions when the field is changed. For a requisition identify the field changes that create change tracked records, require approval by the approval framework, and creation of a change request. For a purchase order identify the field changes that create change tracked records and require approval by the approval framework.
Purchasing Definition-PO Change Options Page	BUS_UNIT_PO_APPR	Define purchase order approval requirements for each business unit.

Page Name	Definition Name	Usage
Purchasing Definition-Req Change Options Page	BUS_UNIT_REQ_APPR	Define requisition approval requirements for each business unit.
Register Transactions Page	EOAW_TXN	Register an application with the approval framework.
Configure Transactions Page	EOAW_TXN_NOTIFY	Use the Configuration Transactions page to configure how the system uses the particular implementation of approval triggers.
Setup Process Definitions Page	EOAW_PRCES_MAIN	Define workflow approval process stages.
Approval Authorization Page	EOAW_AUTH	Authorize roles and approvers for dynamic paths.
Approval Monitor Configuration Page	EOAW_MONDIS_CONFIG	Configure the approval monitor.
Monitor Approvals Page	EOAW_ADM_MON_SRC	View into all approvals to which you have access, as well as take necessary actions on pending approvals.
Generic Template Definition Page	WL_TEMPLATE_GEN	Use the Generic Template Definition page to establish a common format for all ad hoc notifications.
Event Types Page	EOAW_NEM_EVENTS	Associate events to a server.
Setup Event Page	EOAW_NEM_SETUP	Set up an escalation event and define the evaluation and action details.
Event Status Page	EOAW_NEM_STATUS	Check status of notification.
Schedule Job Set Definitions Page	SCHDLDEFN	Set up a NEM to define the job to run, and how often you want it to run.

Page Name	Definition Name	Usage
Installation Options- Purchasing Page	INSTALLATION_PO	<p>Set up PeopleSoft Purchasing installation options including the maximum number of lines to be displayed at one time in the Review/Edit Approvers section of the workflow approval components.</p> <p>Use the PO Approval Monitor Max Rows field to define the maximum number of purchase order lines.</p> <p>Use the Req Approval Monitor Max Rows field to define the maximum number of requisition lines.</p>

Understanding the Approval Framework Setup Steps

Within PeopleSoft Purchasing, the approval of requisitions and purchase orders can be handled by the approval framework. Most of the work has already been done for you and is delivered with your PeopleSoft system. You need to activate the workflow and adjust the approval setup to identify your individual users, templates, and servers. This topic discusses the setup of requisition and purchase order approval within PeopleSoft Purchasing.

After a requisition or purchase order is created, the system routes the transaction to an approver. The approver can view and take action in two ways: using their worklist or navigating directly to an approvals page. The approver can preview, in a graphical format, the path that the transaction approval will take, view who has already approved the transaction, and see any comments that previous approvers have entered.

While the system awaits approval action, the approval framework maintains the overall state of the requisition or purchase order, invokes routings, and interacts with the application classes.

The approval framework enables you to perform a number of approval tasks, including:

- Approving a transaction (requisition or purchase order) at the header or line-level. You can approve the entire transaction at the header level or approve individual lines at the line level.
- Performing mass approvals. Using the Manage Requisition Approvals page or the Approve Purchase Orders page, you can select multiple transactions to be approved or denied at one time. Use the Mark All icons to perform mass approval.
- Denying a transaction. Once a transaction is denied, the workflow stops.
- Hold a transaction or transaction line. The hold action enables an approver to stop the approval process and research an issue. When hold is used, the system automatically adds the person who created the transaction as an ad hoc reviewer so that a comment can be sent. Once the transaction is placed on hold, it cannot move to the next approval step until the approver removes the hold.
- Pushing back a transaction or transaction line. A pushback returns the transaction to the previous approval step. The meaning of *push back* is that the approver is questioning the prior step's approval and is requesting clarification.

- Adding or removing ad hoc approvers or reviewers. During the approval process, approvers can add other approvers or reviewers to the current or a later stage of the approval process. For example, if a buyer wants input from an inventory analyst, she can add the analyst as an approver. This action is called ad hoc approval, and it applies only to the approval instance in which the addition occurs and does not affect the underlying process definition used for other requests.
- Reviewing an online transaction that shows the layout of the printed version. The transaction opens up as a second window and can be printed. The Oracle BI Publisher is used to generate this report, and you can customize it.
- Making comments to be viewed by other approvers or reviewers.
- Approving a transaction that has been changed. When a transaction is changed during or after the approval process, the approval framework can require re-approval of the changes using the same approval component as the original transaction.
- Approving or denying a transaction using email rather than PeopleSoft pages.
- Self approval of transactions. This feature can be restricted or turned off.

Note: Users with the system administrator role can self approve transactions, regardless of the transaction amount.

- Alternate approvers who are assigned to receive emails and Worklist notifications for the primary approver when the primary approver is not available.

For a complete list of approval features, see the Understanding Approval Features section of the Understanding the Approval Framework topic of the *PeopleSoft FSCM 9.2: Approval Framework*.

During the approval process these actions take place:

- The system notifies approvers and reviewers that there is a pending transaction (requisition or purchase order) that needs their attention.
- Approvers and reviewers access the transaction details, provide comments, and take action (approve, deny, or push back) for the requisition or purchase order. In addition, approvers and reviewers can be granted the authority to add additional ad hoc approvers or reviewers to the workflow for a pending transaction.
- The system checks for additional routings in the same routing path.

If all steps have been completed for the stage, then the next step is started in the next stage. If there are multiple routing paths, the system routes them in parallel.

- Once all approvers of a transaction have approved it, the approval framework notifies the PeopleSoft Purchasing application. The requisition or purchase order is then ready for the next step.

See *PeopleSoft FSCM 9.2 : Approval Framework*.

Setting Up the Approval Framework for PeopleSoft Purchasing

Complete information about the setup and use of the approval framework is located in the *PeopleSoft FSCM 9.2 : Approval Framework*.

Use the following steps to set up the requisition and purchase order approval process within PeopleSoft Purchasing:

Set Up the User Profile Component

For the users with PeopleSoft Purchasing:

- Use the User Profile-Workflow page to identify the supervisor who should approve the user's new requisitions or purchase orders.
- Use the User Profile-Roles page to enter the roles of the user. A role is a class of users who perform the same type of work, such as a requestor, buyer, or manager. A role describes how people fit into workflow. Roles are defined under PeopleTools, Security, Permissions & Roles, Roles.

See "Defining Users for Approval Framework," *PeopleSoft FSCM 9.2 : Approval Framework*.

Define User Lists

Use the User List Definition page to define lists of users who can approve transactions. These lists are used with steps in the approval process. The PeopleSoft product delivers a set of default user list roles corresponding to the roles within an organization. For PeopleSoft Purchasing, default user lists include buyers, buyers for hardware, buyers for Software, line level approvers, department managers, and project managers.

See "Defining User List," *PeopleSoft FSCM 9.2: Approval Framework*.

Grant eProcurement Role Actions to the Appropriate User Roles

If your environment includes PeopleSoft eProcurement as well as PeopleSoft Purchasing and the approval framework is used in PeopleSoft Purchasing, then the following eProcurement role actions enable approval features for requisitions in PeopleSoft Purchasing:

- *ALLOWHOLD*: Displays the Hold button on requisition approval pages.
- *ALLOW_ADHOC_ONSUBMIT* : Allows for adding or removing ad hoc approvers after you submit the requisition.
- *ALLOW_ADHOC_ONPREVW* : Enables users to add or remove ad hoc approvers on requisition preview.
- *CANCHANGEALL*: Enables a requester to change any field on the requisition without restarting the approval process while the requisition is in a pending approved status.
- *CANCHANGEDISTRIB*: Enables the requester to change any field on the requisition distribution without restarting the approval process while the requisition is in a pending approved status.
- *CANCHANGEHEADER*: Enables the requester to change any field on the requisition header without restarting the approval process while the requisition is in a pending approved status.
- *CANCHANGELINE*: Enables the requester to change any field on the requisition line, with the exception of quantity and price, without restarting the approval process while the requisition is in a pending approved status.
- *CANCHANGESCHEDULE*: Enables the requester to change any field on the requisition schedule without restarting the approval process while the requisition is in a pending approved status.

- *MASS_APPROVER*: Enables a requester to approve multiple requisitions at one time. The Approve Requisitions component is where the actions are enabled.
- *WF_EXPAND_APPROVER*: Enables users to always see the **Review/Edit Approvers** section in the eProcurement Approval page when it is expanded.

If PeopleSoft eProcurement is not installed in your environment, then the eProcurement role actions do not need to be setup.

See “Maintaining System Users and Roles” (PeopleSoft eProcurement)

Establish the Requisition Status at Save

Use the Requester Setup page to establish the status of a requisition when it is saved. The requisition status of Pending is immediately submitted to workflow when the new requisition is saved, however, the status of Open is not submitted to workflow. An open requisition cannot be viewed on the approver's worklist, in the Manage Requisition Approvals page or the Requisition Approval page.

In addition, you must authorize the user to approve requisitions by selecting the Approval check box in the Allowed Requisition Actions group box of the User Preferences: Procurement - Requisition Authorizations page.

Establish the Purchase Order Status at Save

Use the Buyer Setup page to establish the status of a purchase order when it is saved. The purchase order status of Pending is immediately submitted to workflow when the new PO is saved, however, the status of Open is not submitted to workflow. An open purchase order cannot be viewed on the approver's worklist or in the Approve Purchase Orders page.

In addition, you must authorize the user to approve purchase orders by selecting the Approval check box in the Allowed Purchase Order Actions group box of the User Preferences: Procurement - Purchase Orders Authorizations page.

Create Change Templates

Define change templates for requisitions and purchase orders to identify when a field change should initiate the re-approval of the transaction by the approval framework.

To create a change template for requisitions, use the change template type of Requisition. When you first create the change template, the system defaults the re-approval workflow trigger for the following fields in both the REQ_LINE and REQ_LINE_SHIP records:

1. MERCHANDISE_AMT
2. PRICE_REQ
3. QTY_REQ

Once you have created the change template for requisitions, attach the template to the Purchasing business unit using the Purchasing Definition-Req Change Options page. The change template entered in this page are shared by the same business unit across the PeopleSoft Purchasing, eProcurement, and Services Procurement applications. If no requisition change template is defined for the business unit, then any field changes start the re-approval of the requisition line using the approval framework feature.

To create a change template for purchase orders, use the change template type of Purchase Order. When you first create the change template, the system defaults the re-approval workflow trigger for the following fields in the PO_LINE_SHIP record:

1. MERCHANDISE_AMT
2. PRICE_PO
3. QTY_PO

After you create the change template for purchase orders, attach the template to the Purchasing business unit using the Purchasing Definition-PO Change Options page. The change template entered in this page are shared by the same business unit across the PeopleSoft Purchasing, eProcurement, and Services Procurement applications.

See “Creating Change Templates” (PeopleSoft Source to Settle Common Information).

See [Establishing Change Options and Approval Rules](#).

Review the Approval Transaction Registry

The approval transaction registry is the interface application used to register an application with the approval framework. You use the Register Transactions page to link the components, event handler, records, and classes that you created into the approval process for an application transaction, such as a requisition or purchase order. The main records and components that make up the transaction are registered, along with the approval transaction on which to base the approval process definition.

Any PeopleSoft delivered approvals already have the Approval Transaction Registry populated. No additional configuration is typically needed. This includes the transaction registry for requisition approval (process ID Requisition) and for purchase order approval (process ID PurchaseOrder).

The transaction registry with the process ID of Requisition uses the cross-reference table PV_REQ_AW and the default approval component of PV_REQ_APPROVAL. Keep in mind that a changed requisition uses the same workflow setup as the original requisition; it is a re-approval of the requisition. PeopleSoft Purchasing and PeopleSoft eProcurement share the same setup data, even though the objects begin with PV.

The transaction registry with the process ID of Purchase Order uses the cross-reference table PO_AW and the default approval component of PO_APPROVAL.

See "Defining the Approval Transaction Registry," *PeopleSoft FSCM 9.2: Approval Framework*.

Configure the Approval Transactions

Use the Configure Transactions page to select and define elements that determine what triggers a notification, who receives the notification, and the content of the notification. Notifications are mapped to work with the approval transaction registry and include menus and components and SQL definitions.

For the process ID of Requisition, use the approval component of PV_REQ_APPROVAL.

For the process ID of Purchase Order, use the approval component of PO_APPROVAL.

“Configure Transactions Page” (Approval Framework)

Set Up Reminder Approvals for PeopleSoft Purchasing

Configure the Request Information event to send Ad-hoc header and line level reminder approvals from the Buyer's Workbench or Requester's Workbench by adding a row in the Notifications with Participant of "User List", User List of 'PO_Req Approval Reminder', Email and Worklist check boxes enabled. Use the Template Name of "PO Approval Reminder" if using Header Level reminders or "PO Approval Reminder Line" if using Line level reminders from the Buyer's Workbench. Use the Template Name of "Req Approval Reminder" if using Header Level reminders or "Req Approval Reminder Line" if using Line level reminders from the Requester's Workbench.

Set Up Process Definitions

Use the Setup Process Definition component to define an approval definition process. This definition is made up of the stages, paths, steps, and criteria that build a workflow.

See "Setup Process Definitions Page" (Approval Framework)

Authorize Approvers and Roles for Dynamic Approval

PeopleSoft applications use workflow to configure approval paths in two manners. The first configuration is to define every approval in step-by-step fashion. The second manner is to create dynamic approvals. Use the Approval Authorization component to authorize roles and approvers for dynamic paths.

See "Defining and Mapping EMC Forms" (Approval Framework)

Set Up the Approval User Monitor

The approval monitor gives administrators a view into all approvals to which they have access, as well as the ability to take necessary actions on pending approvals. Each process ID can be configured using the Approval Monitor Configuration page (Enterprise Components, Approvals, Approvals, Monitor Configuration).

Once configured, the Monitor Approvals page can be accessed from Enterprise Components, Approvals, Approvals, Monitor Approvals.

See "Using the Approval Monitor," *PeopleSoft FSCM 9.2: Approval Framework*.

See "Setting Up Event Notifications and Escalations" (PeopleSoft eProcurement).

Define Ad Hoc Notification Templates

Use the Generic Template Definition page to establish a common format for all ad hoc notifications. This provides functionality similar to the Approval Monitor but not limited to the administrators. Add templates for:

- PO Approval
- PO Approved
- PO Cancelled
- PO Denied
- PO Escalation

- PO Information Added
- PO Information Requested
- PO Line Approval
- PO Line Approved
- PO Line Information Added
- PO Line Information Requested
- PO Line Pushback
- PO Line Reviewed
- PO Pushback
- PO Review
- PO Approval Reminder
- PO Approval Reminder Line

Similar templates exist for requisitions.

See “Defining Notification Templates for Approval Framework” (Approval Framework)

Set Up Reminder Approvals for PeopleSoft Purchasing

Configure the Request Information event to send Ad-hoc header and line level reminder approvals from the Buyer’s Workbench by adding a row in the Notifications with Participant of “User List”, User List of ‘PO_Req Approval Reminder’, Email and Worklist check box enabled, and Template Name of ‘PO Approval Reminder’ if using Header Level reminders or “PO Approval Reminder Line” if using Line level reminders.

Set Up the Notification and Escalation Manager

The Notification and Escalation Manager (NEM) is a mechanism used to process notifications and escalations on a specified interval. For example, escalations are used when an approver has not responded within a specified time period to a transaction that is pending approval. You can specify the time period (timeout) and you can specify alternate approvers to whom to notify and escalate the approval for further action. Timeout options are defined on the Approval Path Definition page.

To set up the NEM, use the following pages: Event Types, Setup Event, Event Status, and Schedule JobSet Definitions.

See "Using the Notification and Escalation Manager," *PeopleSoft FSCM 9.2: Approval Framework*.

Determining the Maximum Rows for the Approval Monitor and Other Pages

On the Installation Options- Purchasing page, enter the maximum number of lines to be displayed at one time in the Review/Edit Approvers section of the workflow approval components. Additional lines can be accessed by using the chunking options at the top of the section, including; using the Next Item button, Last Item button, or entering a range of lines and clicking the Retrieve button. Use the PO Approval

Monitor field to define the maximum number of purchase order lines. Use the Requisition Approval Monitor field to define the maximum number of requisition lines. The default value for these fields is 5.

See “Installation Options - Purchasing Page” (Application Fundamentals).

Activate Workflow

Activate the approval framework for requisitions and purchase orders by using the:

- Purchasing Definition-PO Change Options page. Use the Purchasing business unit to activate the approval framework for purchase orders in PeopleSoft Purchasing. Select the **PO Workflow Approval Required** check box to enable purchase order approval within the business unit. Select this check box to replace the PeopleTools workflow technology (virtual approver) in PeopleSoft Purchasing with the approval framework. If you enable the approval framework for the Purchasing business unit, then it is enabled for eProcurement also. Once you have selected the **PO Workflow Approval Required** check box, use the PO Create Exceptions group box and PO Change Request Exceptions group box to identify sources that do not require approval. The **Change Template** entered on this page is used by PeopleSoft Purchasing, eProcurement, and Services Procurement to determine which field changes to the original purchase order will launch the approval framework for PO re-approval. Select the **Resubmit Workflow for Quantity and Price Decrease** check box to require approval of a PO changes with a decrease in item quantity or price.
- Purchasing Definition-Req Change Options page. Use the Purchasing business unit to turn on the approval framework for requisitions in both PeopleSoft Purchasing and PeopleSoft eProcurement. Select the **Workflow Approval Required** check box to enable requisition approval within the business unit. By selecting this check box the PeopleTools workflow technology (virtual approver) in PeopleSoft Purchasing is replaced by the approval framework. If you enable the approval framework for the Purchasing business unit, then it is enabled for eProcurement also. The **Change Template** entered on this page is used by PeopleSoft Purchasing, eProcurement, and Services Procurement to determine which field changes to the original requisition will launch the approval framework for requisition re-approval. Select the **Resubmit Workflow for Quantity and Price Decrease** check box to require approval of a requisition changes with a decrease in item quantity or price.

See [Establishing Change Options and Approval Rules](#).

Setting Up Email Approvals for PeopleSoft Purchasing

The email collaboration framework allows applications to send, receive, and process emails with interactive content. It can be used to send email approvals for requisitions or purchase orders. You can send an HTML form to a user, and they do not need to log into their system to perform tasks.

These steps describe the flow of email collaboration:

1. A system event triggers PeopleSoft PeopleCode, which creates a collaborative email and sends it to a user.
2. The user who receives the email takes appropriate action and clicks Submit.
3. The user's submission is sent to an email account that is designated for holding responses.
4. An application engine program runs on a configured interval, polling the repository for new emails. It processes the emails and publishes them as service operation messages.

- The service operation runs, allowing the implementing application to process the data in a known and supported format.

To set up email approvals:

- On the Register Transactions page, complete the Notification Options section to include email notifications. Be sure to select the Use Email Approvals check box. Update the Register Transactions page for the process IDs of *Requisition* and *PurchaseOrder*.

See "Defining the Approval Transaction Registry," *PeopleSoft FSCM 9.2: Approval Framework*.

- On the Configure Transactions page, complete the Notification Options section. Select the Sent Email Approvals to All check box or add a user list in the **Email Approval User List** field. Update the Configure Transactions page for the process IDs of *Requisition* and *PurchaseOrder*.

See "Configuring Approval Transactions," *PeopleSoft FSCM 9.2: Approval Framework*.

- Design the format of the email to be sent using the Form Element Designer page, Form Layout Designer page, and Field Mapping page within the Email Collaboration menu (Enterprise Components, Approvals, Email Collaboration). For directions, see the Using Email Collaboration topic of the *Enterprise Components: PeopleSoft Approval Framework 9.2*.

See "Using Email Collaboration," *PeopleSoft FSCM 9.2: Approval Framework*.

- Use the Node Properties page to modify the PT_EMG_GETMAIL node to enable email collaboration. For directions, see the Using Email Collaboration topic of the *Enterprise Components: PeopleSoft Approval Framework 9.2*.

- Set up the PO_EMAIL_PO_APPROVAL and PV_EMAIL_REQ_APPROVAL service operations within PeopleSoft Integration Broker and Enterprise Components. The Purchase Order Approval (PO_EMAIL_PO_APPROVAL) service operation is used for collaborative emails for purchase orders and the Requisition Approval (PV_EMAIL_REQ_APPROVAL) service operation is used for collaborative emails for requisitions. For directions in activating a service operation, see the Implementing Integrations topic of the *PeopleSoft Supply Chain Management Integration 9.2*.

- Schedule the PeopleSoft Application Engine program EOAWEMC to run on a regular basis. For directions, see the Using Email Collaboration topic of the *Enterprise Components: PeopleSoft Approval Framework 9.2*.

PeopleSoft delivers service operations in PeopleSoft Integration Broker with a default status of *Inactive*. You must activate each service operation before attempting to send or receive data from a third-party source. Use the information in this table and refer to the setup instructions in the PeopleSoft Supply Chain Management Integrations 9.2, "Implementing Integrations" topic, Setting Up Service Operations section.

Service Operation	Direction and Type	Handlers	Chunking Available?	Integrates With
PO_EMAIL_PO_APPROVAL	Inbound Asynchronous	EmailSubscription	No	External XML

Service Operation	Direction and Type	Handlers	Chunking Available?	Integrates With
PV_EMAIL_REQ_APPROVAL	Inbound Asynchronous	EmailSubscription	No	External XML

See the product documentation for *PeopleTools: Integration Broker Administration*

Related Links

“Setting Up Service Operations” (PeopleSoft Supply Chain Management Integration)

Using the Data Migration Workbench for PeopleSoft Change Templates

PeopleSoft Change Templates contain records and fields used to track changes made against a procurement transaction. They are also used to highlight changes on printed documents or view audit history online. As quite a number of fields and records may be involved, it is advantageous to use Application Data Sets (ADS) as its underlying transport technology to migrate this data between development environments, test environments, and ultimately to a production environment.

Delivered ADS to Support PeopleSoft Change Templates	Application Data Set (ADS) Usage
PO_CHANGE_TEMPLATE	<p>Select this data set on the Data Migration Workbench to move Change Template tables from one database to another. This data set includes the following records used by Change Templates:</p> <ul style="list-style-type: none"> • CHNG_TMPLT_TBL • CHNG_TMPLT_REC • CHNG_TMPLT_FLD

PeopleTools: Security Administration.

Setting Up PeopleTools Workflow Technology for PeopleSoft Purchasing

This section discusses how to:

- Set up approvals in PeopleTools Workflow Technology.
- Set up EDX exception workflow.

- Set up notification in PeopleTools Workflow Technology.

Understanding PeopleTools Workflow Technology Setup for PeopleSoft Purchasing

Use PeopleSoft Application Designer and PeopleSoft Workflow Administrator to use the workflow processes that are delivered with PeopleSoft Purchasing. You can also use PeopleSoft Application Designer to design and build your own business processes, including workflow rules. You use PeopleSoft Workflow Administrator to access, monitor, analyze, and control workflow in your organization.

PeopleTools Workflow Technology can be used to:

- Approve transactions. For example, PeopleTools Workflow Technology can route requisitions or purchase orders through the approval process to ensure that the transactions are approved before moving forward in the business process.
- Send workflow notifications to managers, buyers, requesters, and other users about events and actions that are relevant to them. For example, PeopleTools Workflow Technology can notify the appropriate buyer when a POA is received that requires buyer approval before being processed.

Use PeopleSoft Application Designer to build the workflow business process for PeopleTools Workflow Technology. The workflow process is based on rules, roles, and routings.

Rule Set Up

Rules determine which activities are required to process your business data. For example, you might implement a rule that says department managers must approve all requests for external classes.

You implement rules through workflow events, such as PeopleCode that evaluates a condition and triggers a notification (a routing) when appropriate.

Role and User Set Up

Users are the people who participate in one or more workflow processes. Users can be PeopleSoft users, as well as people and groups who don't have direct access to PeopleSoft applications, but rather send or receive data using workflow. For example, if your workflow delivers electronic order forms to suppliers, your suppliers are users.

When you build a workflow, you identify the users who perform each activity according to their roles in the organization and in the workflow. The process of approving a purchase order transaction, for example, may involve the roles of buyer, purchasing analyst, and manager. When the system routes a work item to the next activity in a business process, it forwards the item to the users who fill the role that is assigned to that activity. In some cases, you may define multiple users who fill the role. In most cases, the system runs a query to find out who the appropriate users are for a given work item. You define users' roles when you assign user IDs.

Note: The content of this section is only part of what you need to know to map your business processes. Other information that is common to many applications is located in the PeopleSoft Application Fundamentals 9.2 .

Route Controls Set Up

Route controls further specify which users that belong to a specific role are to receive a workflow item. For instance, you may have a role of manager, but not every manager in the system should receive every purchase order for approval. A particular manager may be responsible for a certain purchase order business unit. Establish the business unit as a route control and assign specific business unit values to specific users. By doing this, you limit the routing of purchase orders from a particular business unit to those managers who should be reviewing those purchase orders.

See the product documentation for *PeopleTools: Security Administration*

Related Links

“Understanding PeopleSoft Application Security” (Application Fundamentals)

Setting Up Approvals in PeopleTools Workflow Technology

You can use PeopleSoft Workflow to automate the approval process for requisitions and purchase orders. Depending on the configuration of the business unit, amount and ChartField approvals may be needed before the system changes the status of a requisition or purchase order from *Pending Approval* to *Approved*. While these approvals are independent of each other, they are set up similarly.

Changing the status on the requisition or purchase order approval table to *In Process* triggers the workflow approval process. Workflow searches for requisitions or purchase orders that require approval and moves those requests to the appropriate users for approval.

You can use either of the following methods to send requisitions and purchase orders into workflow:

- Use the PeopleSoft Application Engine processes.

PeopleSoft Application Engine processes use queries to determine which requisitions and purchase orders are eligible for workflow routings and approvals. To be eligible, a requisition or purchase order must have a status of *Pending Approval* and the approval status on the requisition or purchase order approval table must be *Initial*. The requisition or purchase order approval table tracks the approval status.

For eligible requisitions and purchase orders, the PeopleSoft Application Engine processes sets statuses on the approval table to *In Process*, and the first worklist entries are created for the requisition and purchase order. The requisition or purchase order is now in workflow. The status remains as *Pending Approval*, until the requisition or purchase order completes its workflow cycle and the status changes to *Approved*.

- Perform manual steps on the requisition and purchase order approval pages.

If the requisition or purchase order requires workflow approval, setting the requisition or purchase order status to *Approved* on these pages changes the status on the requisition or purchase order approval table to *In Process*, which triggers workflow approval.

This requisition or purchase-order-in-process is an activity in the workflow process that must be approved before it can move to the next event in the process. After the requisition or purchase order is submitted, workflow verifies that you have the authority to approve the activity. If you don't have the authority, workflow notifies the approver at the next higher level that the activity needs approval and adds the activity to that approver's worklist or sends email notification. The status of the requisition or purchase

order remains as *In Process*. Workflow moves the activity up the hierarchy of approvers until the person with the proper authority approves the activity.

This diagram illustrates the use of workflow objects to define the approval workflow for purchase orders:

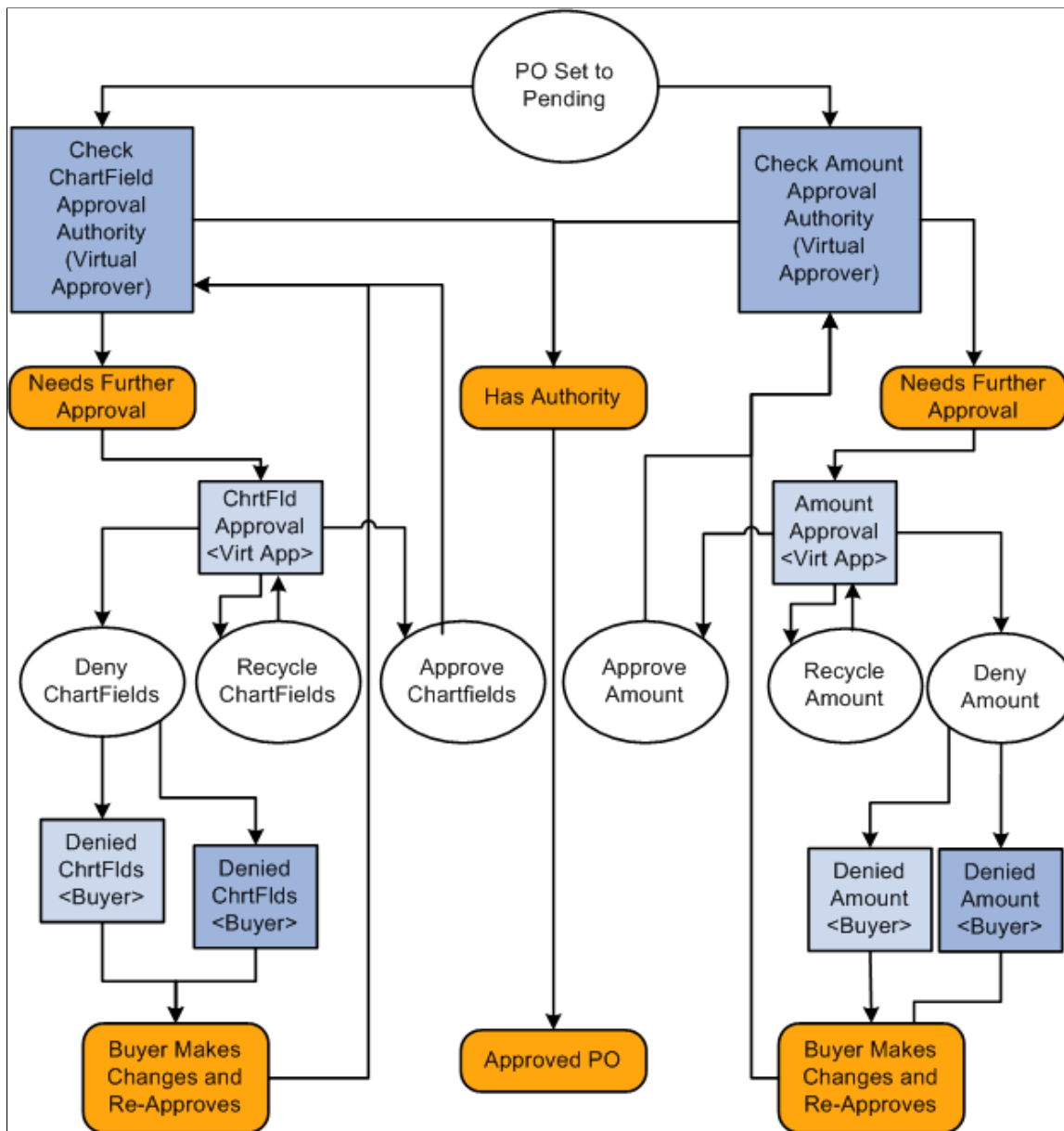

Virtual Approver

PeopleSoft Purchasing uses a workflow model that is called Virtual Approver to handle the requisition and purchase order approval processes. Using the Virtual Approver model, you define approval rules in PeopleSoft Application Designer and routings in PeopleSoft Workflow Administrator, instead of writing lines of PeopleCode.

When you define an approval process, the Virtual Approver determines transactions that need further approval and routes them to the appropriate approval user. Users enter transactions, as they always have, through a PeopleSoft application page. When an user saves the page, the Virtual Approver checks the

approval rules that are defined through the Approval Rule Set to determine what kind of approval is necessary.

On purchase orders and requisitions, the approval transactions are the amount and ChartField approval transactions. If the current user has the authority to approve the transaction, the Virtual Approver sets the transaction status to *Approved* and doesn't route it using workflow.

Note: Even if you do not implement PeopleSoft Workflow at this time, the approval function is still defined within the Workflow component. If workflow isn't being used, the approver manually accesses the approval pages and the approval rules are invoked when he or she saves the page.

The purchase order approval process workflow diagram illustrates a typical example of how you might use the Virtual Approver model to define approval processes. In the example, the system checks both the purchase order amount and the ChartField authorization.

If the system finds that the person who set the purchase order status to *Pending Approval* has authorization for both of those approval transactions, the purchase order is approved.

However, if the purchase order needs further approval, the system adds a transaction to the worklists or sends an email to the appropriate users, based on the rules that are set up in PeopleSoft Workflow Administrator. The purchase order status changes to *In Process* until all approval actions are complete. The next user selects the worklist entry on the Worklist page to access the approval pages and recycles, approves, or denies the purchase order. If the user denies the purchase order, the system generates an email message and a worklist entry to notify the buyer that appears on the purchase order.

Setting Up Requisition Approvals

When you use the PeopleTools Workflow Technology, requisitions are approved using workflow roles, rules, and routings. To implement workflow approvals, define the roles, rules, and routings using the Workflow component. Your system is delivered with basic approval rules already established.

To set up requisition approvals:

1. Access the User Preferences - Procurement: Requisition Authorizations page.

To authorize a user to approve requisitions, select the **Approval** check box in the Allowed Requisition Actions group box.

2. Access the Purchasing Definition - Req Approval Options page.
 - a. If you want to use automatic approvals for the selected business unit, do not define any approval requirements on this page.
 - b. If you want to use workflow approvals for the selected business unit, define your amount and ChartField approval options.
3. Access the Requester Setup page.

In the **Requisition Status** group box, select either *Open* or *Pending* to determine the default status of requisitions once the selected requester saves them.

Setting Up Purchase Order Approvals

When you use the PeopleTools Workflow Technology, the system approves purchase orders by using workflow roles, rules, and routings. To implement workflow approvals, define the roles, rules, and routings by using the Workflow component. PeopleSoft delivers a system that includes basic approval rules.

To set up purchase order approvals:

1. Access the User Preferences - Procurement: Purchase Order Authorizations page.

To authorize a user to approve purchase orders, select the **Approval** check box in the **Allowed Purchase Order Actions** group box.

2. Access the Purchasing Definition - PO Approval Options page.

- a. To use automatic approvals for the selected business unit, do not define any approval requirements on this page.

By leaving these options blank, you have chosen to use automatic approvals.

- b. To use workflow approvals for the selected business unit, define the amount and ChartField approval options.

3. Access the Buyer Setup - Buyer Setup page.

In the **Default PO Status** group box, select either **Open** or **Pending Approval/Approved** to determine the default status of purchase orders once the selected buyer saves them.

See the product documentation for *PeopleTools: Workflow Technology*

Related Links

[PO Change Options \(purchase order change options\) Page](#)

[Req Change Options \(requisition change options\) Page](#)

“User Preferences – Requisition Authorizations Page” (Application Fundamentals)

“Requester Setup Page” (PeopleSoft Source to Settle Common Information)

Setting Up EDX Exception Workflow

When using inbound electronic data exchange (EDX) messages, it may be desirable for exception conditions to be noted and brought to the attention of various people within the purchasing and inventory management organizations. These require processes to notify the procurement and inventory management organizations and ensure that appropriate measures are taken to react to these conditions.

When loading Item Catalog EDX messages, possible exceptions include price changes outside of expected tolerances, unknown items, and other exceptions. Receiving these exceptions should trigger notification to personnel in the buying and inventory management organizations to review and approve the changes. This ensures supplier compliance with buying arrangements and identification of errors before transactions are processed.

When loading Purchase Order Acknowledgement EDX messages, exceptions such as rejecting the purchase order or changing it must be addressed by the buyer to determine whether the changes are acceptable or require any additional follow up.

When you receive inbound Purchase Order Acknowledgment (X.12 855) and Item Catalog (X.12 832) EDX messages that have exceptions, the system provides exception notifications to resources in the buying organization.

Related Links

[Using Item Loader Exception Workflow Notifications](#)

[Using Purchase Order Acknowledgement Alert Workflow Notifications](#)

Setting Up Notification in PeopleTools Workflow Technology

In addition to requisition and PO approvals, you can use PeopleTools Workflow Technology to automate requester and buyer notification processes for requisitions and purchase orders. These notifications let the requesters and buyers know about the statuses of requisitions and purchase orders at key points in the purchasing business process.

Other processes in PeopleSoft Purchasing that use workflow notification include procurement card, RFQ, and contract processes. These notifications alert users about situations that they need to address. You can also receive notifications when the matching process fails.

You enable PeopleTools Workflow Technology notifications using PeopleSoft Application Designer by setting the status for each business event to active in the selected workflow business processes. This table lists workflow notification events that you can use in PeopleSoft Purchasing:

Workflow Notification Event	Workflow Notification Type	Business Process Name
Notify the requester when a requisition line is sourced to a purchase order line through the Create PO process.	Email	REQ_SOURCED Note: You must run this workflow manually from an online page. See Issuing Requisition Sourcing Workflow Notifications .
Notify the requester when the purchase order for the requisition is canceled.	Email	PO_CANCELED Note: You must run this workflow manually from an online page. See Issuing Purchase Order Cancellation Workflow Notifications .
Notify appropriate users that a procurement card statement has arrived and is ready for reconciliation.	Email	PROCARD_BANK_SMENT_ARRIVED
Notify appropriate users that the reconciliation of a procurement card bank statement was not finished within the preset time frame.	Email	PROCARD_GRACE_PERIOD_EXPIRED

Workflow Notification Event	Workflow Notification Type	Business Process Name
Notify the buyer when a requisition line requires an RFQ.	Worklist	RFQ_NOTIFICATION
Notify the buyer when a contract expires or reaches the maximum monetary amount. Also, notify the buyer when a contract is nearing its renewal date.	Worklist	CONTRACT_EXPIRY_ALERT <hr/> Note: You must run this workflow manually from an online page. <hr/> See Issuing Contract Expiration and Exceeding Maximum Workflow Notifications .
Notify the buyer when a POA is received that requires approval by the buyer before being processed. (POA can be either an EDX or Online POA.)	Worklist	PO_ACKNOWLEDGEMENT <hr/> Note: Within the activity tied to this business process, the EDI PO Acknowledgement and the Online PO Acknowledgement worklist definitions are the ones being used for this realtime notification.

See the product documentation for *PeopleTools: Application Designer Developer's Guide*

Issuing Requisition Sourcing Workflow Notifications

This section lists the page that you use to issue requisition sourcing worklist and/or e-mail notifications using Enterprise Components Notification Framework.

The PO_RQSRCD_WF process notifies requesters when their requisition lines have been sourced to purchase order lines.

Page Used To Issue Requisition Sourcing Workflow Notifications

Page Name	Definition Name	Usage
Requisition Sourced Workflow - Req Sred Pres Wf Page (requisition sourced process workflow)	REQ_SRCD_PRCS_WF	Run the PO_RQSRCD_WF process, which notifies requesters when their requisition lines have been sourced to purchase order lines by the Create Purchase Orders process (PO_POCREATE).

Issuing Purchase Order Cancellation Workflow Notifications

This section lists the page that you use to issue purchase order cancellation workflow notifications using PeopleTools Workflow Technology.

Page Used to Issue Purchase Order Cancellation Workflow Notifications

<i>Page Name</i>	<i>Definition Name</i>	<i>Usage</i>
Canceled Sourced POs Workflow - Cancel Sourced POs Workflow Page (canceled sourced purchase order workflow)	PO_POCNCL_PRCs	Run the PO_POCNCL_WF process, which notifies requesters when purchase orders that are sourced from their requisitions have been canceled.

Issuing Contract Expiration and Exceeding Maximum Workflow Notifications

This section lists the page that you use to issue contract expiration and exceed maximum workflow notifications using PeopleTools Workflow Technology.

Page Used to Issue Contract Expiration and Exceed Maximum Workflow Notifications

<i>Page Name</i>	<i>Definition Name</i>	<i>Usage</i>
Contract Alert Workflow Page	CNTRCT_ALERT_WF	Run the PO_CNTRCT_WF process, which notifies buyers when their contracts have expired or reached their maximum monetary amounts. In addition, this process will update the work list entries for the buyer when the expiration date, release amount, or any thresholds have been modified for a contract and that contract still exceeds the thresholds.

Using Purchase Order Acknowledgement Alert Workflow Notifications

This section discusses how to use the purchase order acknowledgement alert workflow notification within the PeopleTools Workflow Technology.

The purchase order acknowledgement alert workflow provides buyers with notifications for every purchase order where the purchase order is violating the defined rules for when a purchase order acknowledgement should be received by.

To generate the purchase order acknowledgement alert notification:

1. Define purchase order acknowledgement settings.
2. Run the POA_ALERTS Application Engine process to create worklist entries for the purchase orders that are violating the defined rules for when a purchase order acknowledgement should be received.
3. The system routes the worklist entry to the specified user ID based on the buyer ID on the purchase order header.
4. Click the worklist entry.

The system transfers you to the purchase order on the Maintain Purchase Order - Purchase Order page where the buyer can acknowledge on behalf of the supplier or get the necessary information to contact the supplier.

Pages Used to Use Purchase Order Acknowledgement Alert Workflow Notifications

<i>Page Name</i>	<i>Definition Name</i>	<i>Usage</i>
POA Settings (purchase order acknowledgements settings) Page	POA_DEF_BU_SP	Define the purchase order acknowledgement alert settings for the purchasing business unit.
“Procurement Options Page” (PeopleSoft Source to Settle Common Information)	VNDR_PROC_OPT_SEC	Define the purchase order acknowledgement alert settings for a supplier and location. The system will first use the POA settings defined for the supplier location on a purchase order, and if not defined there, will then use the POA settings for the purchasing business unit on the purchase order.
POA Alerts Page	PO_POA_ALERTS	Initiate the Purchase Order Acknowledgement Alerts Application Engine process (POA_ALERTS) which will generate worklist entries for the buyer. Buyers will receive a worklist entry for each purchase order that is violating the defined POA settings for when a POA should be received by the supplier.

Related Links

[POA Settings \(purchase order acknowledgements settings\) Page](#)

[Using Purchase Order Acknowledgements](#)

[“Defining Supplier Locations” \(PeopleSoft Source to Settle Common Information\)](#)

Using Item Loader Exception Workflow Notifications

This section discusses how to use the Item Loader EDX exception workflow notification within the PeopleTools Workflow Technology.

With the Item Loader EDX message, you can receive item data that is published by third-party sources by subscribing to XML-based messages or uploading a flat file.

The following conditions should trigger an exception notification:

- Price change exceeds tolerance.

Notify when the new price on the item price change is greater than or equal to the old item price multiplied by the item price tolerance.

- New item added.

Notify when a supplier provides a new item on the catalog. This enables you to set up defaults accordingly.

- Unit of measure (UOM) does not exist.

New UOM is supplied for this item. Notify when the Supplier item UOM does not exist on the UOM tables.

- UOM changed.

Notify when the conversion rate has changed.

- Error encountered.

Notify when an error (other than the exceptions identified above) is encountered when loading items. For example, a UOM code is not convertible.

To generate the Item Loader exception notification, follow these steps:

1. Define workflow rules using the Workflow Rule Assignment page.
2. Optionally, if you want the system to send out notifications when price tolerances are exceeded, define price tolerances.
3. Run the Item Loader Workflow process (IN_ITMEXP_WF) to create worklist entries for item loader messages that meet the exception criteria.

Use the process to identify the errors and exceptions generated from the Item Loader process and then route them to the appropriate role user. The process either generates a worklist or emails, depending on how you define setup on the Workflow Rule Assignment page. You can run this process separately or with the Item Loader process.

4. The system routes the worklist entry to the specified user ID.
5. When you click the worklist entry, the system transfers you to the Approve Item Exceptions component, where you can view and approve item exceptions.

Defining Price Tolerances

You define price tolerances to use in conjunction with the price change exception rule. The item load processes compare the new item or supplier price on the Item Loader Staging table to the previous item or supplier price; if the new price exceeds the tolerances, the system generates an exception.

Tolerances may be defined by item category or by item. You can define price tolerances by a percentage increase or decrease, or by a higher or lower amount.

Field or Control	Description
Over Percentage Tolerance	Defines the minimum percent price increase that generates an exception. The default value is unlimited tolerance.
Over Amount Tolerance	Defines the minimum amount price increase that causes an exception to be generated. The default value is unlimited tolerance.
Under Percentage Tolerance	Defines the minimum percent price decrease that causes an exception to be generated. The default value is unlimited tolerance.
Under Amount Tolerance	Defines the minimum amount price decrease that causes an exception to be generated. The default value is unlimited tolerance.

Viewing and Approving Item Exceptions

After you find exceptions, you can use the Item Exception Approvals component to:

- Approve the change and process as is (for price change, item does not exist or UOM change only).
- Change the item attributes (for any exception).
- Cancel the Item Load record completely.

This does not delete the item from the master database, but prevents any updates from being processed.

- Change the exception approval status to *Approved*.

Pages Used to Use Item Loader Exception Workflow Notifications

<i>Page Name</i>	<i>Definition Name</i>	<i>Usage</i>
Workflow Rule Assignment	PV_WF_SETID_ASGN	Assign workflow rules by SetID, including whether you should notify using workflow or email. You can also check for exceptions and write the exceptions into the error log without generating workflow or email.
Item Categories	CATEGORY_TBL2	Set price tolerance defaults for items.
Purchasing Controls	ITM_TBL_PUR2	Set price tolerance defaults for purchased items. These tolerances appear by default from the item category and can be overridden during online item setup.
Item Loader Workflow	RUN_IN_ITMLOADWF	Run the Item Loader Workflow process to process errors and exceptions for Item Loader messages.
Select Exceptions	IN_ITMEXP_SEL	Select exceptions by SetID, supplier, item, category, exception rule ID, status, or enterprise integration point control ID.
<u>Exception Summary Page</u>	IN_ITMEXP_SUM	Display the records matching the selection criteria from the Select Exceptions page.
Exception Detail	IN_ITMEXP_DTL	Display the exception detail for each exception.
Item Master EIP Maintenance	IN_EIP_ITEM_MAINT	View or correct the item data.

Exception Summary Page

Use the Exception Summary page (IN_ITMEXP_SUM) to display the records matching the selection criteria from the Select Exceptions page.

Navigation:

SCM Integrations > Transaction Error Handling > Approve Item Exceptions > Exception Summary

The system displays the status of the exception. Use the **Change Status To** field to select the status to which you want to change the exception. After making a selection in the **Change Status To** field, click the **Apply All** button to change the status for all errors and exceptions that appear. The exception is then available for reprocessing.

Click the **Data Correction** button on the Exception Detail page to access the appropriate component to correct the exception condition.

Using Rebate Manager Workflow Notification

This section discusses how to use the rebate manager workflow notification within the PeopleTools Workflow Technology.

The rebate manager workflow provides rebate managers with notifications of claims generated against vendor rebate agreements that they are responsible for.

To generate the rebate manager notification:

1. Run the Rebate Accrual process to generate rebate accrual transactions.
2. Run the Generate Claims process to generate vendor rebate claims.
3. Run the Notify Rebate Manager process to create worklist or email entries to notify the rebate managers that claims have been generated for the vendor rebate agreements they are responsible for.
4. Review the worklist entry or the email sent for the rebate manager notification.

The rebate manager will use either the Message Dashboard or the Worklist page to review and acknowledge the notifications that were sent by the workflow process to the worklist.

Pages Use to Use Rebate Manager Workflow Notifications

<i>Page Name</i>	<i>Definition Name</i>	<i>Usage</i>
Notify Rebate Manager Page	VRBT_NTFY_RM_RC	Initiate the Notify Rebate Manager process to notify the rebate managers of claims generated against their vendor rebate agreements.
Message Dashboard Page	SAC_EWN_DSH_SRCH	Manage rebate manager notifications.
Worklist Page	WORKLIST	Manage rebate manager notifications.

Related Links

[Understanding Vendor Rebate Rule Types](#)

[Understanding Vendor Rebates](#)

Prerequisites

Before the rebate manager workflow notification process can be executed successfully you must have:

- Defined a vendor rebate agreement with the Notify Rebate Manager check box selected on the Rebate Agreement - Rebate Options page.

- Performed purchasing transactions on which to base vendor rebate claims.

Using Receipt Quantity Change Workflow Notifications

This section discusses how to use the receipt quantity change workflow notification within the PeopleTools Workflow Technology.

The receipt quantity change workflow provides the rebate managers with notifications when a receipt associated with vendor rebate agreements that has accruals already included on a claim has been changed.

To generate the receipt quantity change workflow notification:

1. Change the quantity on a receipt associated with a vendor rebate agreement that already has accruals included on a claim using the Maintain Receipts - Receiving page.

Upon changing the quantity the system will automatically generate the notification.

2. Review the worklist entry or the email sent for the receipt quantity change notification.

The rebate manager will use either the Message Dashboard or the Worklist page to review and acknowledge the notifications that were sent by the workflow process to the worklist.

Pages Use to Use Receipt Quantity Change Workflow Notifications

Page Name	Definition Name	Usage
<u>Maintain Receipts - Receiving Page</u>	RECV_WPO	Change the quantity on a receipt that is associated with a vendor rebate agreement that has accruals already included on a claim.
Message Dashboard Page	SAC_EWN_DSH_SRCH	Manage receipt quantity change notifications.
Worklist Page	WORKLIST	Manage receipt quantity change notifications.

Related Links

[Understanding the Receiving Business Process](#)

[Understanding Vendor Rebate Rule Types](#)

[Understanding Vendor Rebates](#)

[Understanding the Supplier Location Hierarchy and Multicurrency Pricing](#)

Prerequisites

Before the receipt quantity change workflow notification process can be executed successfully you must have previously received a quantity on a receipt that was associated with a vendor rebate agreement that has accruals on a claim.

Using Settlement Manager Workflow Notifications

This section discusses how to use the settlement manager workflow notification within the PeopleTools Workflow Technology.

The settlement manager workflow provides settlement managers with notifications of claims settlement activity that has occurred against vendor rebate claims that they are responsible for.

To generate the settlement manager notification:

1. Run the Rebate Accrual process to generate rebate accrual transactions.
2. Run the Generate Claims process to generate vendor rebate claims.
3. Run the Claim Settlement process to send claims to PeopleSoft Payables and PeopleSoft Receivables to be processed.
4. Run the Notify Settlement Manager process to create worklist or email entries to notify the settlement managers that claims settlement activity has occurred for the vendor rebate agreements they are responsible for.
5. Review the worklist entry or the email sent for the claims settlement notification.

The settlement manager will use either the Message Dashboard or the Worklist page to review and acknowledge the notifications that were sent by the workflow process to the worklist.

Pages Use to Use Settlement Manager Workflow Notifications

<i>Page Name</i>	<i>Definition Name</i>	<i>Usage</i>
Notify Settle Mgr (Notify Settlement Manager) Page	VRBT_NTFY_SM_RC	Initiate the Notify Settlement Manager process to notify the settlement managers of claims settlement activity that occurred against their rebate claims.
Message Dashboard Page	SAC_EWN_DSH_SRCH	Manage settlement manager notifications.
Worklist Page	WORKLIST	Manage settlement manager notifications.

Related Links

[Understanding the Rebate Accrual Process](#)

[Understanding Vendor Rebates](#)

[Understanding Vendor Rebate Rule Types](#)

Prerequisites

Before the settlement manager workflow notification process can be executed successfully you must have:

- Defined a vendor rebate agreement with the Notify Settlement Manager check box selected on the Rebate Agreement - Rebate Options page.
- Performed purchasing transactions on which to base vendor rebate claims.

Chapter 8

Using Default Hierarchies

Understanding the PeopleSoft Purchasing Default Hierarchy

For each business unit that you define in PeopleSoft Purchasing, you establish default information used in all transaction processing. Depending on the fields that you define, you can specify default information at each applicable level in the hierarchy or have default fields obtain their values from default values designated at less-specific levels in the hierarchy.

PeopleSoft Purchasing provides default capability for those values that are relatively static in nature (values that remain the same in everyday operations and would become repetitive to enter for every transaction). For example, if you set up the ChartField defaults with the most appropriate values for the items, categories, and requesters, theoretically, you have little need to navigate to the requisition's distribution level to enter any values. The ChartField values at that level are set by default.

PeopleSoft defaults operate in two parallel areas: transactions and items.

- Transaction defaults begin at the more-specific buyer level in the hierarchy and end with the most-general user level.
- Item defaults begin at the most-specific ship to level and end at the most-general item category level.

Purchasing Transaction Default Hierarchy

This list illustrates an overview of the PeopleSoft Purchasing transaction default hierarchy, where each level represents a factor in the procurement process that can provide a transaction default value:

- Level One: Buyer.
- Level Two: Requester.
- Level Three: Supplier.
- Level Four: Purchase Order Origin.
- Level Five: Business Unit.
- Level Six: User.

The first level, represents the buyer level, one of the most specific default levels. Level six, the last level, represents the user level, which is one of the least-specific default levels. When determining which value to use on a purchase order, the system references the highest default level for a value. If it cannot find one there, it moves down level by level, searching for a defined value.

This table details the levels in the transaction default hierarchy from which the selected transaction values can appear by default. The possible default hierarchy levels listed for each transaction field value begin with the more-specific default and end with the less-specific default.

For example, when determining the accounting template to use for a purchase order, the system first determines whether a supplier has defined an accounting template. If so, the system uses the supplier's accounting template. If a template is not defined at the supplier level, the system uses the accounting template defined at the business unit level.

<i>Transaction Field Value</i>	<i>Default Hierarchy</i>
Accounting Template	Supplier, Business Unit
AM Capitalize Flag	Business Unit
AM Unit	Business Unit
AP Accrue Flag	Business Unit
AP Unit	Business Unit
ASN Flag	Supplier
Billing Location	Business Unit
BU Comments (business unit comments)	Business Unit
Business Unit	User
Buyer	Supplier, User
Catalog ID	Requester
Contract Authority	User
Contract Dispatch Method	Supplier, Business Unit
Contract Status	User
Country	Supplier, User
Currency	Requester
Currency Code/Rate Type	Supplier, Business Unit
Days + / - Today	User

<i>Transaction Field Value</i>	<i>Default Hierarchy</i>
Department	Buyer, Requester, Purchase Order Origin, User
Fax	Requester
Freight Terms	Supplier, Business Unit
GL Unit (general ledger unit)	Business Unit
Location Code	Buyer, Requester, Business Unit, User
Match Option/Match Type	Supplier, Business Unit
Order Location	Supplier
Origin	Buyer, Requester, Business Unit, User
Override Supplier	Buyer
Payment Terms	Supplier, Business Unit
Payment Terms Basis Date	Supplier
Phone	Buyer, Requester
PO Authority	User
PO Dispatch	Supplier, Business Unit
PO Status	Buyer, User
Pricing Location	Supplier
Receiving Authority	User
Receiving BU	User
Replenishment Dispatch Method	Supplier
Report Template	Business Unit

<i>Transaction Field Value</i>	<i>Default Hierarchy</i>
Requester Name	User
Requisition Authority	Requester, User
Requisition Status	Requester, User
Returning Location	Supplier
RFQ Authority (request for quotation authority)	User
RFQ Dispatch Method	Supplier, Business Unit
RFQ Status	User
RTV Debit Memo (return-to-vendor debit memo)	Supplier
RTV Dispatch Method	Supplier, Business Unit
RTV Fees	Supplier
RTV Notification Method	Supplier
RTV Replace Invoice	Supplier
Sales Tax Tolerance	Supplier
Sales/Use Tax Information	Supplier
SetID	User
Ship To	Buyer, Requester, User
Ship Via	Supplier, Business Unit
Sourcing % Unit Price Tolerance (sourcing percentage unit price tolerance)	Business Unit
Supplier Authority	User
Tax Exempt Flag/Tax Exempt ID	Business Unit

<i>Transaction Field Value</i>	<i>Default Hierarchy</i>
Use VAT Suspension (use value-added tax suspension)	Business Unit
Use One Ship To	Supplier, Business Unit
VAT Calculation Type	Business Unit
VAT Declaration Point	Business Unit
VAT Home	Business Unit
VAT Options	Supplier, Business Unit
VAT Registration ID	Business Unit
VAT Rounding Rule	Business Unit
VAT Tolerance Check Indicator	Business Unit
VAT Transaction Code	Business Unit

Requisition Default Hierarchy

PeopleSoft Purchasing enables you to create requisitions using requisition loader batch processing or the requisition online entry pages.

The Purchasing Requisition Loader Application Engine process (PO_REQLOAD) derives its most specific default values from the data sources of this batch process. At a less specific level, you can use the Requisition Loader Defaults page to set the default values for the Purchasing Requisition Loader process. These default values populate empty requisition ChartFields when you run the process. Use the Requisition Loader Defaults - Overrides and Options page to set override options for the Purchasing Requisition Loader process. These values replace source requisition ChartField values when you run the process.

After you create requisitions from the online entry pages, use the Maintain Requisitions - Requisition Defaults page to set defaults for requisitions at the individual transaction level. This page gives you the option to do the following for all future requisition lines:

- Specify default values.

The application references the default values specified in the existing hierarchy to populate fields on future lines. If no values are found, it uses the values defined on this page as defaults.

- Specify overriding values.

The application references the values that you defined on this page to populate fields on the requisition for future lines.

If you have pre-existing defaults on the Requisitions - Header or Line Defaults pages and you change any of these values, PeopleSoft Purchasing enables you to retrofit these changes to existing requisition lines and distributions.

Related Links

[Retrofit field changes to all existing requisition lines/schedule/distributions Page](#)

[Requisition Defaults Page](#)

[Understanding the Purchasing Requisition Loader Application Engine Process \(PO_REQLOAD\)](#)

“Using Requisition Loader Defaults and Overrides” (PeopleSoft Source to Settle Common Information)

Purchase Order Default Hierarchy

PeopleSoft Purchasing enables you to create purchase orders using purchase order staging batch processing or the purchase order online entry pages.

The PO Stage Load Application Engine process (PO_POSTAGE) derives its more specific default values from the data sources of this batch process. At a less-specific level, you can use the PO Loader Defaults page to set the default values for the PO Stage Load process. These default values populate empty purchase order ChartFields when you run the process. You can also use the PO Loader Defaults - Overrides and Options page to set override options for the Create Purchase Orders Application Engine process (PO_POCREATE). These values replace existing purchase order ChartField values when you run the process.

Once you create purchase orders from either online or batch processes, use the Purchase Order Defaults page to set defaults for purchase orders at the individual transaction level. The page gives you the option to do the following for all future purchase order lines:

- Specify default values.

The application references default values specified in the existing hierarchy to populate fields on future lines. If no values are found, it uses the values defined on this page as defaults.

- Specify overriding values.

The application references the values that you defined on this page to populate fields on the purchase order for future lines.

If you have pre-existing defaults on the PO Header Defaults pages and you change any of these values, PeopleSoft Purchasing enables you to retrofit these changes to existing purchase order lines and distributions.

Related Links

[Retrofit field changes to all existing PO lines/schedule/distributions Page](#)

[Purchase Order Defaults Page](#)

[Loading Staged Purchase Order Requests from PeopleSoft Supply Planning and Manufacturing](#)

“Using Purchase Order Loader Defaults and Overrides” (PeopleSoft Source to Settle Common Information)

Purchasing Item Default Hierarchy

This list illustrates an overview of the PeopleSoft Purchasing item default hierarchy, where each level represents a factor in the procurement process that can provide an item default value:

- Level One: Ship To Location
- Level Two: Regions
- Level Three: Kit Item
- Level Four: Item/Supplier Attributes
- Level Five: Item BU Attributes
- Level Six: Item Purchasing Attributes
- Level Seven: Item
- Level Eight: Item Category BU Attributes
- Level Nine: Item Category

The first level is the ship to location level, which is one of the most-specific default levels. Level nine, the last level, represents the item category level. Level nine is one of the least-specific default levels. When determining which value to use for an item, the system first references the highest default level for a value. If it cannot find one there, it moves down the relevant levels, searching for a defined value to use.

This table details the levels in the item default hierarchy from which the selected transaction values can appear by default. The possible default hierarchy levels listed for each item-related field value begin with the more-specific default and end with the most-general level default.

For example, when determining the asset profile ID for an item, the system first references the item purchasing attributes to determine whether an ID is defined. If so, the system uses that asset profile ID. If an ID is not defined, the system uses the asset profile ID defined at item category level.

Text in boldface indicates a grouping of default fields, rather than just a single field, for example, matching controls and sourcing controls.

<i>Transaction Field Value</i>	<i>Default Hierarchy</i>
Asset Profile ID	Item Purchasing Attributes, Item Category
Buyer	Item BU Attributes, Item Purchasing Attributes, Item Category-BU Attributes, Item Category
Currency Code	Item/Supplier Attributes, Item BU Attributes, Item Purchasing Attributes, Item Category
Origin Country	Item/Supplier Attributes
Description	Item Purchasing Attributes, Item

<i>Transaction Field Value</i>	<i>Default Hierarchy</i>
Delivery Instructions	Ship To Location
Distribution Network	Ship To Location
Inventory BU	Ship To Location
Item/Item Category	Ship To Location
Item Specifications	Item Purchasing Attributes
Lead Time Days	Item/Supplier Attributes, Item BU Attributes, Item Purchasing Attributes, Item Category
Long Description	Item Purchasing Attributes, Item
Lot Item	Item
Manufacturer ID	Item/Supplier Attributes, Item
Manufacturer Item ID	Item/Supplier Attributes, Item
Matching Controls: Unit Price Tolerance Over, Unit Price Tolerance Under, % Unit Price Tolerance Over, % Unit Price Tolerance Under, Ext. Price Tolerance Over, Ext. Price Tolerance Under, % Ext. Price Tolerance Over, % Ext. Price Tolerance Under	Item/Supplier Attributes, Item BU Attributes, Item Purchasing Attributes, Item Category
Miscellaneous Controls and Options	Item/Supplier Attributes, Item BU Attributes, Item Purchasing Attributes, Item Category
Accept Any Ship To	Item/Supplier Attributes, Item BU Attributes, Item Purchasing Attributes
Accept Any UOM	Item/Supplier Attributes
Accept Any Supplier	Item BU Attributes, Item Purchasing Attributes
Auto Select	Item BU Attributes, Item Purchasing Attributes
Close PO Under Percent Tolerance	Item BU Attributes, Item Purchasing Attributes, Item Category
Contract Required	Item BU Attributes, Item Purchasing Attributes

Transaction Field Value	Default Hierarchy
RFQ Required	Item/Supplier Attributes, Item BU Attributes, Item Purchasing Attributes
Stockless Item	Item/Supplier Attributes, Item BU Attributes, Item Purchasing Attributes
Taxable	Ship To Location, Item/Supplier Attributes, Item BU Attributes, Item Purchasing Attributes
Tax Exempt Information	Ship To Location
Ultimate Use Code	Item BU Attributes, Item Purchasing Attributes, Item Category
Order Location	Ship To Location, Region
Packing Weight	Item/Supplier Attributes, Item BU Attributes, Item Purchasing Attributes
Packing Weight UOM	Item/Supplier Attributes, Item BU Attributes, Item Purchasing Attributes
Packing Volume	Item/Supplier Attributes, Item BU Attributes, Item Purchasing Attributes
Packing Volume UOM	Item/Supplier Attributes, Item BU Attributes, Item Purchasing Attributes
Price (Supplier)	Item/Supplier Attributes
Price (standard)	Item BU Attributes, Item Purchasing Attributes
Price Can Be Changed On Order	Item/Supplier Attributes
Receiving BU	Ship To Location
Receiving Controls	Item BU Attributes, Item Purchasing Attributes, Item Category
Early Ship Reject Days	Item BU Attributes, Item Purchasing Attributes, Item Category
Inspection ID	Item BU Attributes, Item Purchasing Attributes, Item Category
Inspection Required	Item BU Attributes, Item Purchasing Attributes, Item Category

Transaction Field Value	Default Hierarchy
Inspect Sample %	Item BU Attributes, Item Purchasing Attributes
Inspection UOM	Item BU Attributes, Item Purchasing Attributes, Item Category
Partial Quantity	Item BU Attributes, Item Purchasing Attributes, Item Category
Quantity Received Tolerance %	Supplier's UOM and Pricing Information page, Purchasing Business Unit Attributes page, Purchasing Attributes - Purchasing Controls page, Item Categories-Category Definition 2 page
Receiving Required Flag	Item BU Attributes, Item Purchasing Attributes, Item Category
Reject Quantity Over Tolerance	Item BU Attributes, Item Purchasing Attributes, Item Category
Region of Origin	Item/Supplier Attributes
Sales/Use Tax Information	Ship To Location
Serial Item	Item
Ship Via	Item BU Attributes, Item Purchasing Attributes, Item
Standard or Supplier UOM	Item/Supplier Attributes
Standard UOM	Item
Rounding Tolerance	Item/Supplier Attributes
RTV Information: RTV Miscellaneous Charge, RTV Action, RTV Percent, RTV Reason	Item/Supplier Attributes
Sourcing Controls	Item Purchasing Attributes, Item Category
Use Category Sourcing Controls	Item Purchasing Attributes
Supplier Sourcing Priorities	Item Category
Sourcing Method	Item Purchasing Attributes, Item Category
Accumulate Level	Item Category

Transaction Field Value	Default Hierarchy
Lead Time Factor %	Item Purchasing Attributes, Item Category
Price Factor %	Item Purchasing Attributes, Item Category
Ship To Priority Factor %	Item Purchasing Attributes, Item Category
Supplier Priority Factor %	Item Purchasing Attributes, Item Category
Cumulative Sourcing: Year to Start, Month to Start, Number of Months, Start Date, End Date	Item Category
Supplier Sourcing Priorities	Item Category
Priority	Ship to Location, Region, Item/Supplier Attributes, Item Category
Supplier ID	Ship to Location, Region, Item/Supplier Attributes, Item Category
Allocation Percentage	Item/Supplier Attributes, Item Category
Use Item Standard Lead Time	Item/Supplier Attributes
Use Standard Item Tolerance	Item/Supplier Attributes
Supplier History: Number of Months, Month to Start	Item Category

Purchasing ChartField Default Hierarchy

This list illustrates an overview of the PeopleSoft Purchasing ChartField default hierarchy, where each level represents a factor that can provide a ChartField default value.

- Level One: Purchasing Kit Items.
- Level Two: Item BU Attributes.
- Level Three: Item Purchasing Attributes.
- Level Four: Item Category.
- Level Five: Requester.

The first level represents the purchasing kit item setup, one of the most-specific default levels. Level five represents the requester level, one of the least-specific default levels. When determining which ChartField

value to use, the system first references the highest default level for a value. If it cannot find one there, it moves down the relevant levels, searching for a defined value.

Understanding the UOM Conversion Hierarchy

All of the PeopleSoft applications use UOMs to quantify resources. In PeopleSoft Purchasing, the various UOMs that are available for the transactions enable you to quantify and track the items that you have purchased.

You must first define the UOM codes to be used in the system on the Units of Measure page. Use this page to define standard conversion rates between any combination of UOMs necessary. These codes are stored in the Units table.

These are the UOMs commonly used by PeopleSoft Purchasing transactions:

- General UOM

The general UOM and its conversion rates are defined on the Units of Measure page. This information is stored in the Units table.

- Inventory item UOM

The inventory item UOM is the UOM defined for the item on the Item Definition - Units of Measure page. The inventory item UOM rate of conversion to the item standard UOM is also defined on the Item Definition - Units of Measure page. The inventory item UOM information represents the UOM in which the item is tracked in the business process. This information is stored in the Inventory Item table.

Define an item standard UOM when you first enter an item definition into the system on the Item Definition - General: Common page. This applies only if you have the Inventory module installed.

The item standard UOM serves as the smallest common denominator for UOM conversion, and should be selected accordingly. The standard UOM should be the smallest unit in which the item is transacted and should be selected, so that any conversions performed for the item are converted from the standard UOM.

For example, do not assign a standard UOM of *CASE* to an item that you regularly order in the smaller UOM of *BOX* or *EACH*.

- Item Supplier UOM

The item-Supplier UOM is defined for an item-supplier combination on the Supplier's UOM & Pricing Info page. The item-Supplier UOM rate of conversion to the item standard UOM is also defined on this page. The item-Supplier UOM information represents the UOM in which the item is purchased from a specific supplier. This information is stored in the Item Supplier table.

Related Links

[Defining Purchasing Item Attributes](#)

“Associating an Item with a UOM” (PeopleSoft Managing Items)

“Units of Measure Page” (PeopleSoft Managing Items)

UOM Defaulting

The PeopleSoft Purchasing UOM default hierarchy is based in part on the type of transaction that you create (RFQ, requisition, purchase order, contract, or procurement card). If a supplier is involved in the transaction, the setting of the **Accept Any UOM** check box for the supplier on the Purchasing Attributes - Item Supplier page is also a factor in the UOM default hierarchy.

This diagram illustrates the UOM default hierarchy:

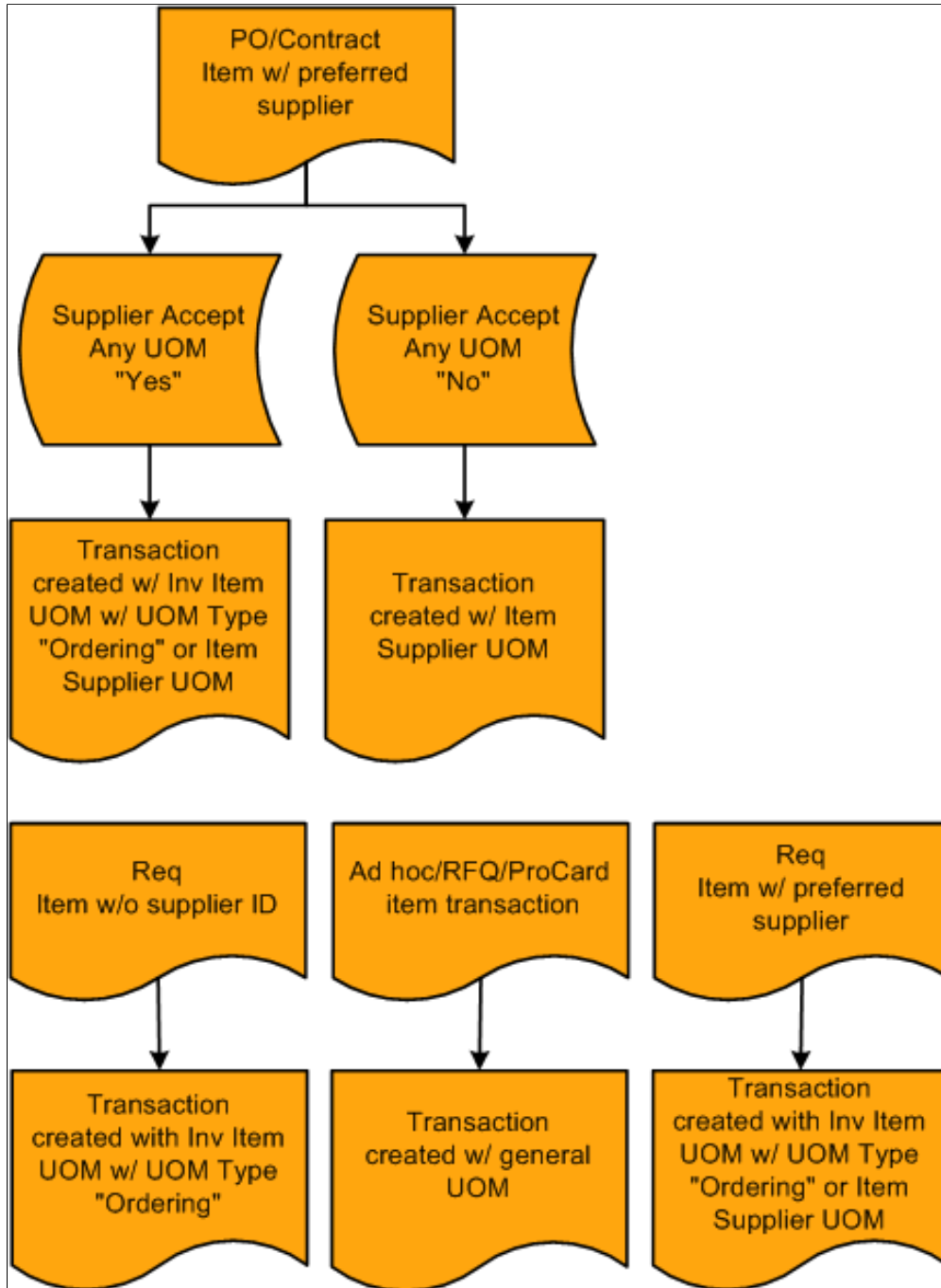

When you enter a requisition with a specified item ID, the system searches for a preferred supplier for the item. If a preferred supplier exists, the preferred supplier default UOM appears on the requisition.

If the item ID that you add to a requisition has no Supplier ID, the UOM appears by default in the item standard UOM defined for the item.

If you are creating an ad hoc, RFQ, or procurement card transaction, the system creates the transaction with the general UOM that you specify on the transaction.

Related Links

[Purchasing Attributes -Item Supplier \(ITM_VENDOR\)Page](#)

UOM Conversion Rate Defaults

When you convert one transaction type to another, the UOM on the originating transaction may need to be converted to the UOM that is required for the new transaction. This kind of UOM conversion may be performed when you source a requisition to a purchase order, or award an RFQ and create a purchase order for it.

For example, suppose that you have a requisition with no supplier for a quantity of 10 boxes of an item in the inventory item UOM. When you source the requisition to a purchase order, and the supplier assigned to the purchase order does not accept any UOM, the item supplier UOM overrides the inventory item UOM. If the supplier has a preferred UOM of cases, the requisition quantity of 10 boxes in the inventory item UOM must be converted to the item supplier UOM of cases.

To accomplish this, the system uses the UOM conversion rate between boxes and the standard UOM defined on the Inventory Item table. It then accesses the UOM conversion rate between cases and the standard UOM defined on the Item supplier table. If none exists, the system uses the conversion rate defined on the Inventory Item table. The system then reconciles the quantities in the standard UOM to derive the quantity to be ordered in the preferred item supplier UOM of cases.

If the chosen supplier accepts any UOM, you can create the purchase order from the requisition with the inventory item UOM, and no conversion is necessary.

When you source an ad hoc item transaction to a purchase order, the general UOM on the originating transaction is carried to the purchase order and no conversion is performed.

This diagram illustrates the process:

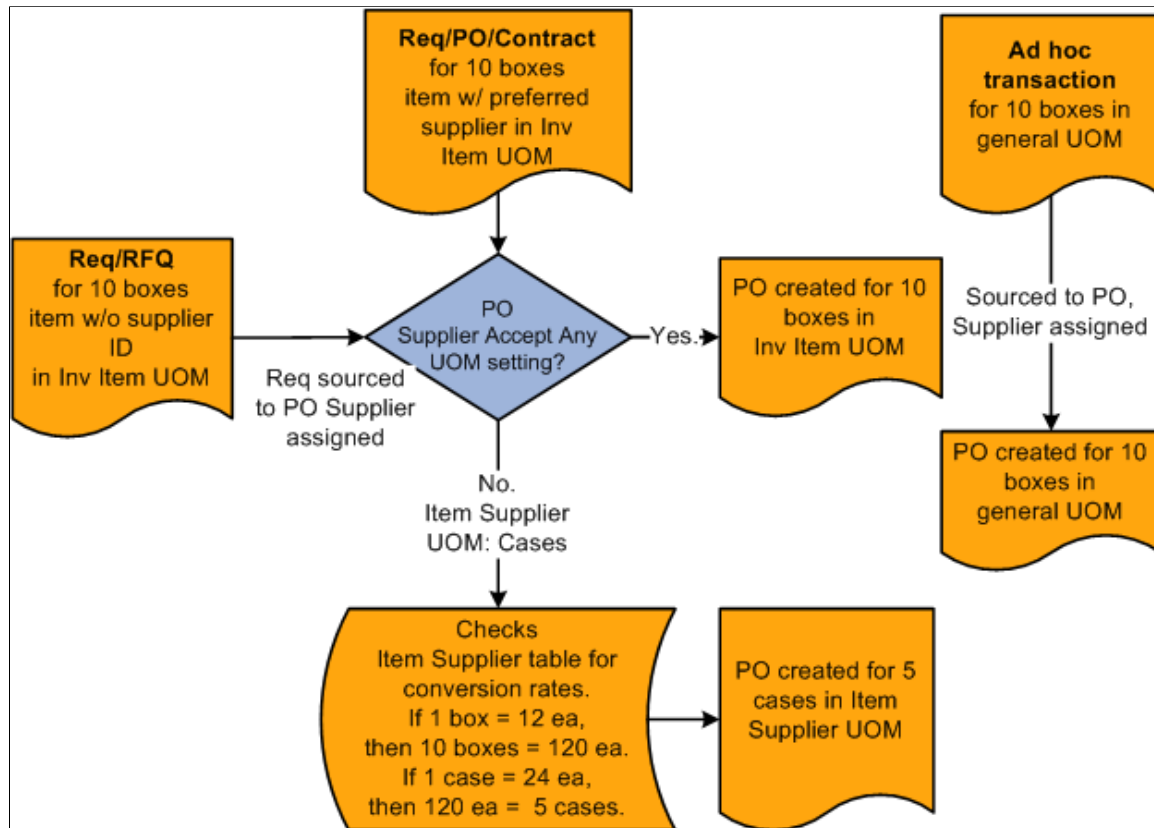

Understanding the Matching Default Hierarchy

This section outlines the way in which matching and Evaluated Receipt Settlement (ERS) statuses appear by default onto vouchers, purchase orders, and receipts. Status flags determine the application of match rules to a purchase order, receipt, or voucher rather than the type of match control ID. The status flag settings are derived from the supplier location options and options at the PeopleSoft Payables business unit level or PeopleSoft Purchasing business unit level. ERS processing is further controlled by options at the PeopleSoft General Ledger business unit level (procurement accounting controls). Matching includes receipt-only matching (voucher to non-purchase order receipts).

This table illustrates the matching default hierarchy used in PeopleSoft Purchasing:

Match Option	General Criteria						Purchase Order				Receipt			Voucher				
	Vend Loc Reapt Only: match	Vend Loc ERB Rag	Cntrl ID	BU_A_P ERB Opt Dnt	BU Intrl ERB Opt	PO?	Match_ Status PO	Match Action	ERB Action	Cntrl ID	Match_ Status Reev	ERB_ Rag	ERS_ Inv_ Dt_ Opt	Match_ Cntrl_ D	Match_ Status Vchr	Match_ Action	Rept Only: Match	ERS_ Inv_ Dt_ Opt
Yes	N/A	No	Value	N/A		Yes	T	Y	N	Value	T	N	N	Value	T	Y	N	
No	N/A	No				Yes	N	N	N	N	N	N	N	N	N	N	N	
Yes	N/A	Yes	Value	No		Yes	T	Y	N	Value	T	N	N	Value	T	Y	N	
Yes	N/A	Yes	Value	Yes	No	Yes	T	Y	Y	Value	T	Y	R or F	Value	T	E	N	R or F
Yes	N/A	Yes	Value	Default	No	Yes	T	Y	N	Value	T	N	N	Value	T	Y	N	
Yes	N/A	Yes	Value	Default	Yes	Yes	T	Y	Y	Value	T	Y	R or F	Value	T	E	N	R or F
Yes	No	No	Value	N/A	N/A	No				N	N	N	N	N	N	N	N	
No	No	No		N/A	N/A	No				N	N	N	N	N	N	N	N	
Yes	Yes	No	Value	No	N/A	No				T	N	N	N	Value	T	Y	Y	
Yes	No	Yes	Value	No	N/A	No				N	N	N	N	N	N	N	N	
Yes	No	Yes	Value	Yes	N/A	No				T	Y	R or F	Value	T	E	N	R or F	
Yes	No	Yes	Value	Default	No	No				N	N	N	N	N	N	N	N	
Yes	No	Yes	Value	Default	Yes	No				T	Y	R or F	Value	T	N	N	R or F	
Yes	Yes	Yes	Value	No	N/A	No				T	N	N	N	Value	T	Y	Y	
Yes	Yes	Yes	Value	Default	No	No				T	N	N	N	Value	T	Y	Y	

Purchase Order Key

Field or Control	Description
MATCH_STATUS_PO	T (to match) N (not required)

Receipt Key

Field or Control	Description
MATCH_STATUS_RECV	T (to match) N (not required)
ERS_INV_DT_OPT	F (freight terms) R (receipt date) N (none)

Voucher Key

Field or Control	Description
MATCH_STATUS_VCHR	T (to be matched) N (not applicable)

Field or Control	Description
MATCH_ACTION	<p>Y (yes)</p> <p>N (no)</p> <p>E (evaluated receipt settlement)</p>

Related Links

“Understanding the Matching Process” (PeopleSoft Payables)

Understanding the Supplier Location Hierarchy and Multicurrency Pricing

PeopleSoft Purchasing uses the supplier location hierarchies to determine suppliers and various supplier locations for online requisitions. These hierarchies are also used by the PO Calculations Application Engine process (PO_POCALC) to determine the supplier necessary to create a purchase order and determines how pricing is ultimately derived based on this hierarchy.

This section also discusses how involvement of multicurrencies affects which pricing locations the system obtains. Depending on the setting of the multicurrency flags and which currencies have been set up for the purchasing business unit, requester, supplier location, and pricing locations, PeopleSoft Purchasing performs multicurrency conversions when required.

Here is the setup hierarchy for supplier location and pricing:

Field or Control	Description
Level 1	When defined, the system uses <i>Item Ship To Supplier Locations</i> to determine the priority supplier and the supplier location specified for the item and ship to location. Based on the supplier and supplier location, the pricing location is derived from the Maintain supplier setup. If not defined, it uses level 2 defaulting.
Level 2	When defined, the system uses the <i>Item Region Supplier Locations</i> to determine the priority supplier and the supplier order location specified for the item and region. Based on the supplier and supplier location selected for the region, pricing location is derived based on the supplier and supplier location selected for the region by accessing the location details from the Maintain supplier setup. If not defined, it uses level 3 defaulting.

Field or Control	Description
Level 3	The system selects the supplier based on the Item Supplier setup. When defined, the system uses the <i>Ship To supplier Location</i> to get the supplier order locations to derive the pricing location from the Maintain supplier setup. Ordering locations can be different from the default locations. If not defined, it uses level 4 defaulting.
Level 4	The system selects the supplier based on the Item Supplier setup. When defined, the system uses the <i>Region supplier Location</i> to get the supplier order locations to derive the pricing location from the Maintain supplier setup. Ordering locations can be different from the default locations. If not defined, it uses level 5 defaulting.
Level 5	When defined, the system uses the supplier priorities established in the <i>Item supplier</i> setup to derive the pricing location from the Maintain supplier setup. If the Item supplier setup is the only one defined, the pricing location is always derived from the supplier default location. If not defined, there is no control hierarchy defined.

You can define various locations for a supplier on the supplier Information - Location page accessed from the Maintain suppliers menu. Each location that you define points to an ordering location and a pricing location.

The Item Ship To Supplier Location that you define on the Item Ship To Locations page is a setup based on the combination of the item and ship to location. This setup prioritizes the suppliers from which the item can be purchased for a ship to location and determines the specific supplier location from which to get a pricing location.

The Item Region Supplier Location that you define on the Item Region Locations page is a setup based on the combination of the item and region. This setup prioritizes the suppliers from which the item can be purchased for a region and determines the specific supplier location from which to get a pricing location. The region is derived from the ship to location on the requisition or staged purchase order's schedule.

The Ship To Supplier Location that you defined on the Ship To Locations page defines all of the suppliers that can ship an order to a particular ship to location and is not item-specific. Each supplier and the appropriate supplier order location appears. When determining the supplier ordering location, the system first references the Item supplier for the priority 1 supplier and then references the Ship To Location page to determine the order location.

The Region Supplier Location that you defined on the Region Locations page defines all of the suppliers that can ship an order to a particular region and is not item-specific. Each supplier and the appropriate supplier order location appears. When determining the supplier ordering location, the system first references the Item supplier for the priority 1 supplier and then references the Region Location page to determine the order location.

The Item supplier setup dictates only supplier priorities, and establishes supplier UOM pricing for their pricing locations. This setup does not dictate supplier order locations for the item. Supplier ordering locations default from one of the hierarchies discussed previously or, if no higher level defaults are found, from the default location defined on the Maintain supplier - Location page. The item supplier relationship

that you defined on the Purchasing Attributes - Item Supplier page defines the pricing location for the supplier's default location.

Regardless of the setup that you implement, the pricing location the system uses is ultimately derived from the supplier ordering location. In addition, you can override anything that appears by default on the requisition. To ensure the override is carried to the purchase order, make sure that the **Override Suggested supplier** check box is clear on the Maintain Requisition - Requisition page and the **Let PO Calc Override supplier** check box is clear on the Selected Item Details page accessed from the Sourcing Workbench.

By selecting this check box on the requisition, you enable the purchase order to be created using the same hierarchy and ignore all of the overriding information that the user enters on the requisition. Once the purchase order is created, the buyer can still override this information prior to dispatching.

For example, suppose that the user changes the supplier or supplier location that appear by default on the requisition, and the override suggested supplier check boxes are selected, the purchase order is created following the hierarchy. This overrides the user suggested supplier or supplier location on the requisition.

The purpose of defining the areas described here is to enable more control and automation in the system, thereby reducing the level of repetitive effort by the user. If you want a more automated system, a greater effort is required for the initial setup. This setup is a one-time effort that can increase the utilization of time-saving batch processing capabilities by the system. These setups require occasional updating as supplier changes occur.

Note: These setup scenarios are based on normal day-to-day practices. Exceptions are handled through manual intervention at the requisition, sourcing, or the purchase order level.

Related Links

[Selecting Suppliers Based on Item Ship To and Item Supplier Locations](#)

[Defining Purchasing Item Attributes](#)

“Defining Ship To Locations” (PeopleSoft Source to Settle Common Information)

“Defining Supplier Locations” (PeopleSoft Source to Settle Common Information)

High-Level Controls Implementation: Item Ship To Supplier Location and Item Region Supplier Location Overview

Establishing Item supplier relationships associated with a ship to location or region provides the highest degree of control. These relationships are specific to the item and the ship to location or region, and enable definition of the supplier priority and supplier order location at a more granular level.

The ship to location is the most specific designation, which overrides both the Item Region Supplier Location and the Item supplier priorities and location. Grouping ship to locations into regions provides the ability to override the Item supplier prioritization and default supplier order location at the intermediate Item Region Supplier Location level. Both of these options, add flexibility to the default supplier selection hierarchy.

Item Ship To Supplier Location Setup

Defining item ship to vendor locations provides the highest degree of control. This location-pricing relationship is specific to the item and ship to location. You can specify a multitude of ship to locations

for one item and define different supplier priorities for the same item based on ship to locations. Indeed, this can require a large effort depending on the quantity of items and ship to locations that you have. However, time spent on this one-time setup saves time and repetitive effort in the future.

When you create the online requisition or when you source an existing requisition, the system references the item and ship to location of the requisition and accesses the item ship to location to get the priority 1 supplier and its supplier location. The system derives the pricing location that you defined for the Supplier location. It then looks to the item-supplier relationship to access the pricing for the derived pricing location.

This diagram illustrates this default hierarchy:

This diagram illustrates this default hierarchy:

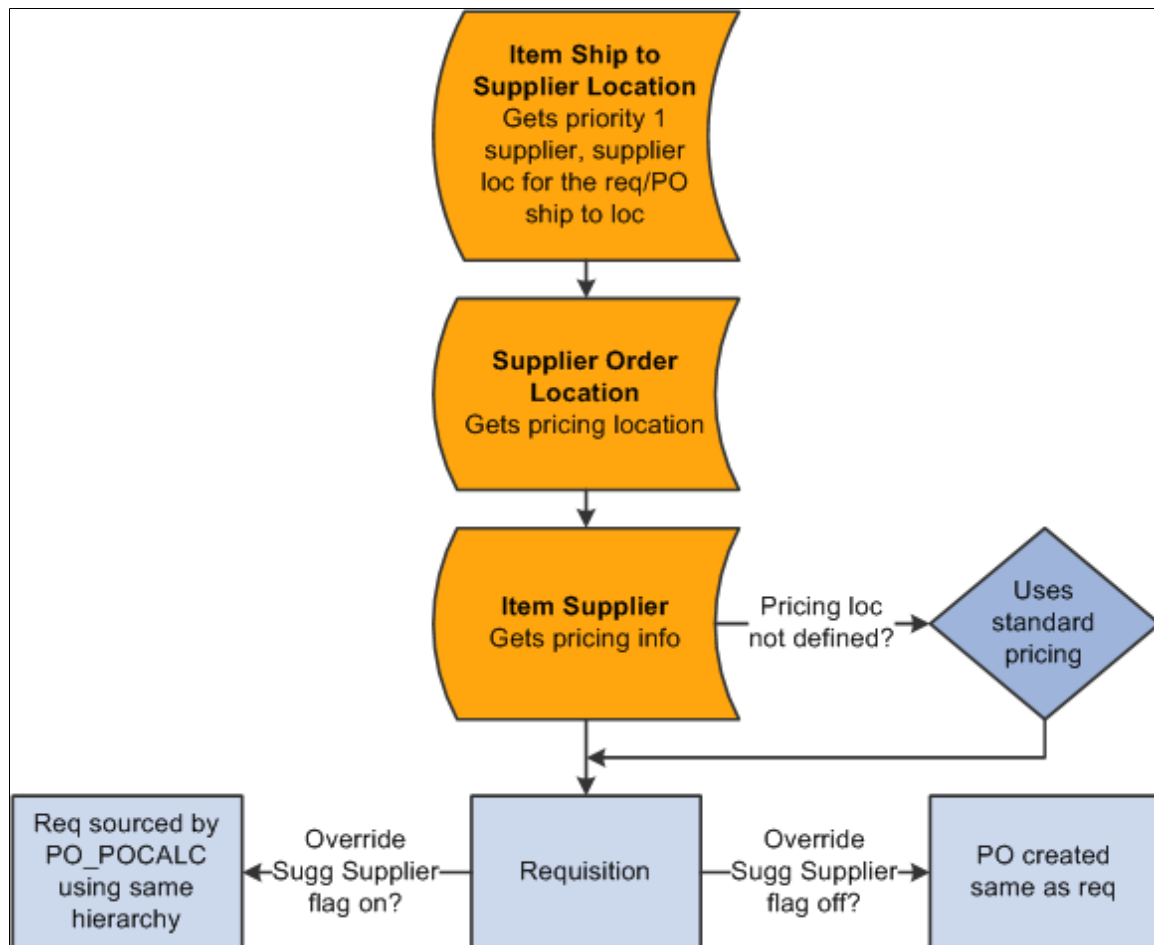

Item Region Supplier Location Setup

A Ship to location can be associated to a region, allowing for management of similar ship to locations at the region level. Item region supplier locations provide a location-pricing relationship that is specific to the item and region. You can associate many regions to an item and define different supplier priorities for the same item based on region. This level of flexibility in supplier prioritization ensures the right suppliers are assigned to the purchase orders, without driving all of the maintenance down to the item ship to location.

When you create the online requisition or when you source an existing requisition, the system references the ship to location to determine the appropriate region. If the ship to location is assigned to a region and a lower level override for the Item Ship To Location does not exist, the system will access the item region supplier location to get the priority 1 supplier and its supplier location. The system derives the pricing location that you defined for the supplier location. It then looks to the item-supplier relationship to access the pricing for the derived pricing location.

Mid-Level Control Implementation: Ship To Supplier Location and Region Supplier Location Supplier Order Location Overview

Establishing a supplier order location relationship with a ship to location or region provides an intermediate level of control (less control) in the supplier hierarchy. These relationships associate either a ship to location or a region to a supplier order location to override the supplier's default order location.

With these additional levels of the hierarchy, the priority supplier is determined from the Item supplier definition. Once the Supplier ID is identified, the determination of the supplier order location begins with the ship to supplier location, then looks to the region supplier location and finally the supplier default location, as defined on the Maintain suppliers component.

Ship To Supplier Location Supplier Order Location Setup

The next level of control is provided by defining the supplier order location for each ship to location. The ship to location is based on the requester and buyer setups that include ship to location defaults for the requisition and purchase order.

One supplier ordering location for each supplier is defined for each ship to location. You can have more than one supplier for each ship to location but only one order location per supplier. This default system is not item-specific, but rather ship to location specific. This setup can require a large effort depending on the quantity of suppliers and ship to locations that you have.

As you create an online requisition or when you source an existing requisition, the system references the item-supplier relationship to get the priority 1 supplier. The system then accesses the ship to location to determine the order location for the priority 1 supplier and uses the order location to derive the pricing location. The system then retrieves the pricing for the derived pricing location from the Item Supplier setup.

This diagram illustrates the default hierarchy for defining the ship to supplier order location for each ship to location:

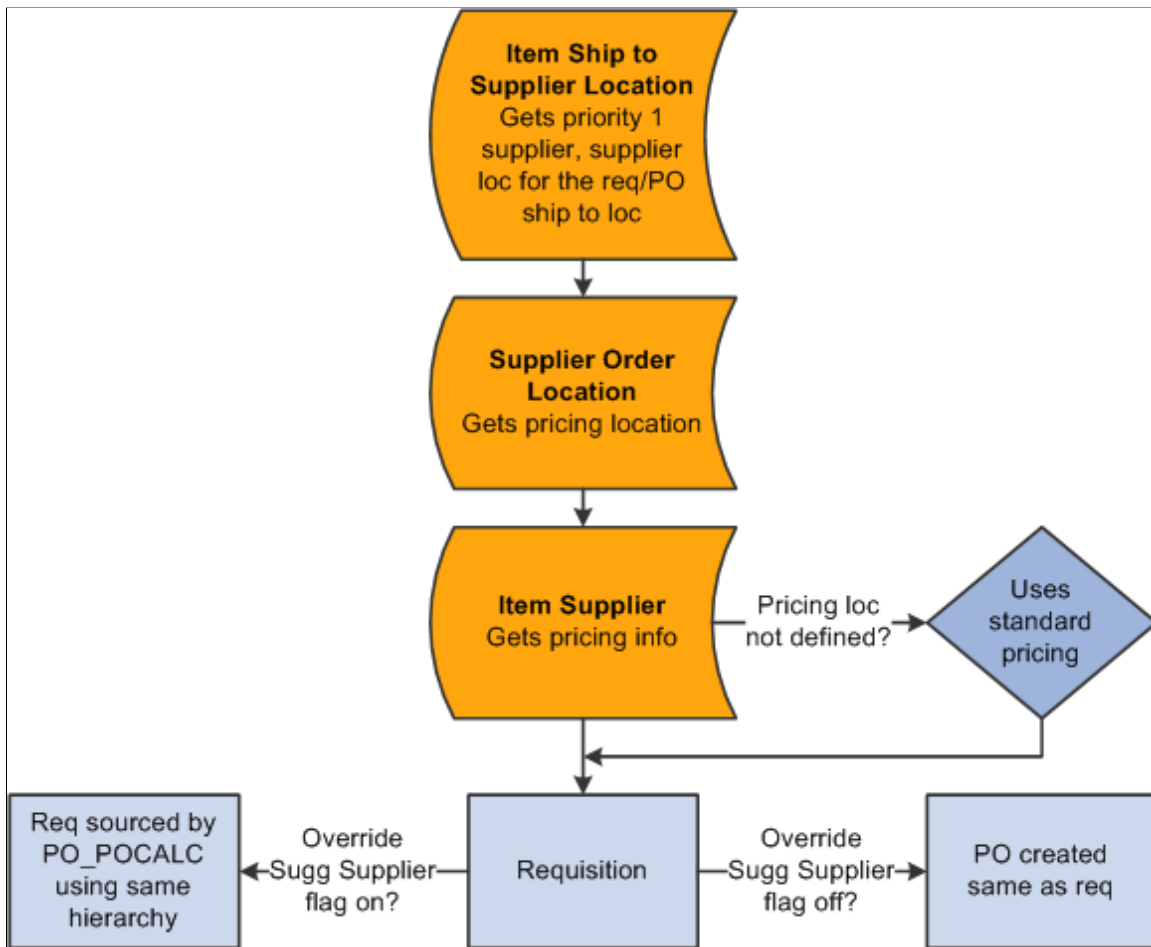

Region Supplier Location Supplier Order Location Setup

Using the procurement region enables you to group ship to locations for additional defaulting purposes. By defining the Supplier order location for each region, you can override the default supplier order location for additional control, without maintaining these overrides for every ship to location in the buying organization.

One supplier ordering location for each supplier can be defined for each region. You can have more than one supplier for each region but only one order location per supplier. This default system is not item-specific, but rather region specific.

As you create an online requisition or when you source an existing requisition, the system references the item-supplier relationship to get the priority 1 supplier. Once the system determines the ship to location's region, it accesses the region supplier location definition to determine the order location for the priority 1 supplier and uses the order location to derive the pricing location. The system then retrieves the pricing for the derived pricing location from the Item supplier setup.

Low-Level Control Implementation: Defining Item-Supplier Relationships Overview

The least amount of control and setup effort occurs in the item-Supplier setup scenario. In this case, you only define supplier priorities and Supplier UOM pricing for the pricing locations of each established supplier. If neither item ship to location nor ship to location is defined, the system uses the priority 1 supplier default location to derive its pricing location. Any other supplier locations and pricing locations, if defined, are not considered. It then goes back to the item-supplier relationship to reference the pricing for the derived pricing location. This hierarchy applies to purchase orders created online.

This diagram illustrates the default hierarchy for defining item-Supplier relationships:

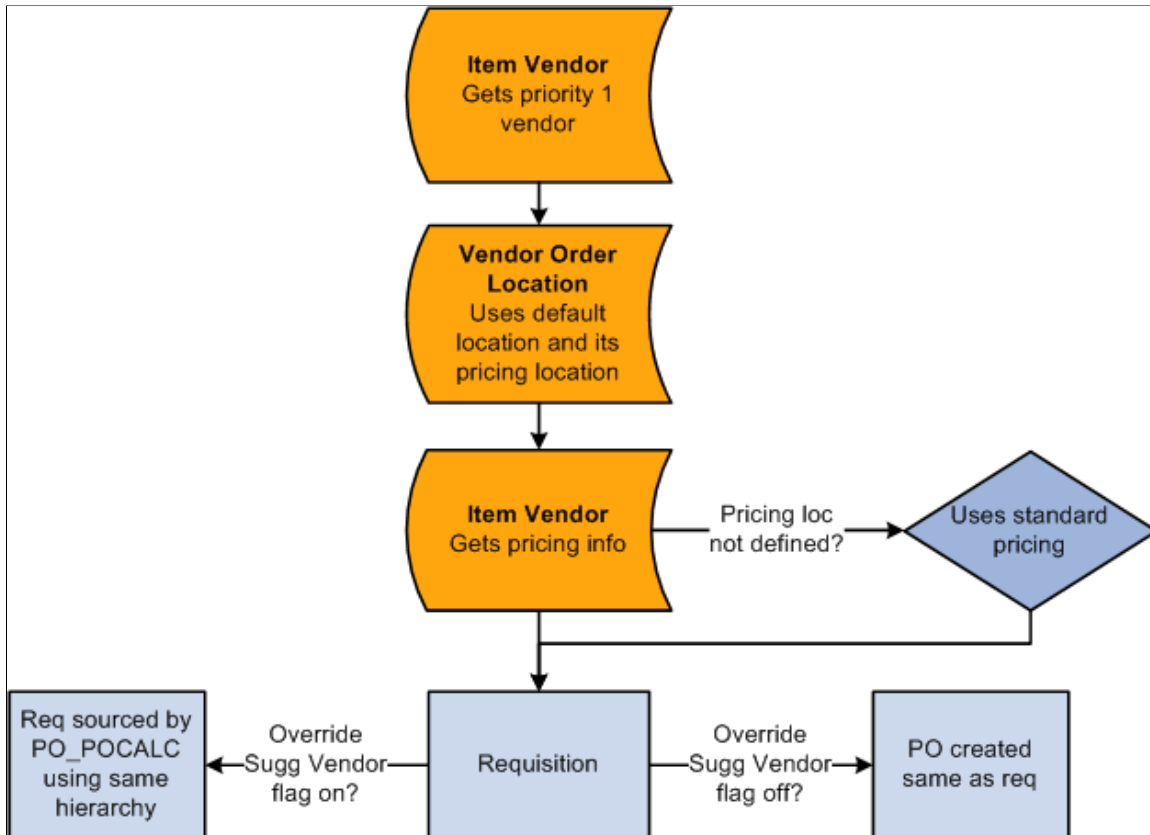

Zero-Level Control Implementation Overview

A zero-level of control results from not defining any of these setups, including no item-supplier relationships. In this scenario, no supplier automatically appears on the requisition, so the standard price is used. You can enter a suggested supplier, but the standard price remains. During the requisition selection process, you can select a supplier if the field is blank or change the supplier that the requester suggested. Because none of the setups were defined, the purchase order is built with the same pricing as the requisition or any buyer pricing updates are performed through requisition selection. Failure to establish item-supplier relationships prevents the creation of contracts. In the same scenario, purchase orders created online use the standard price as well.

Understanding Multicurrency Conversions

You can define multiple currencies and UOMs for a pricing location. When multicurrencies are involved, the system creates the requisition and purchase order provided that there is a currency and UOM match. If there is no match, the system uses an additional hierarchical path to determine the price and currency to use when creating the requisition and purchase order. When required, the system also performs multicurrency conversions.

This diagram illustrates the multicurrency conversion hierarchy:

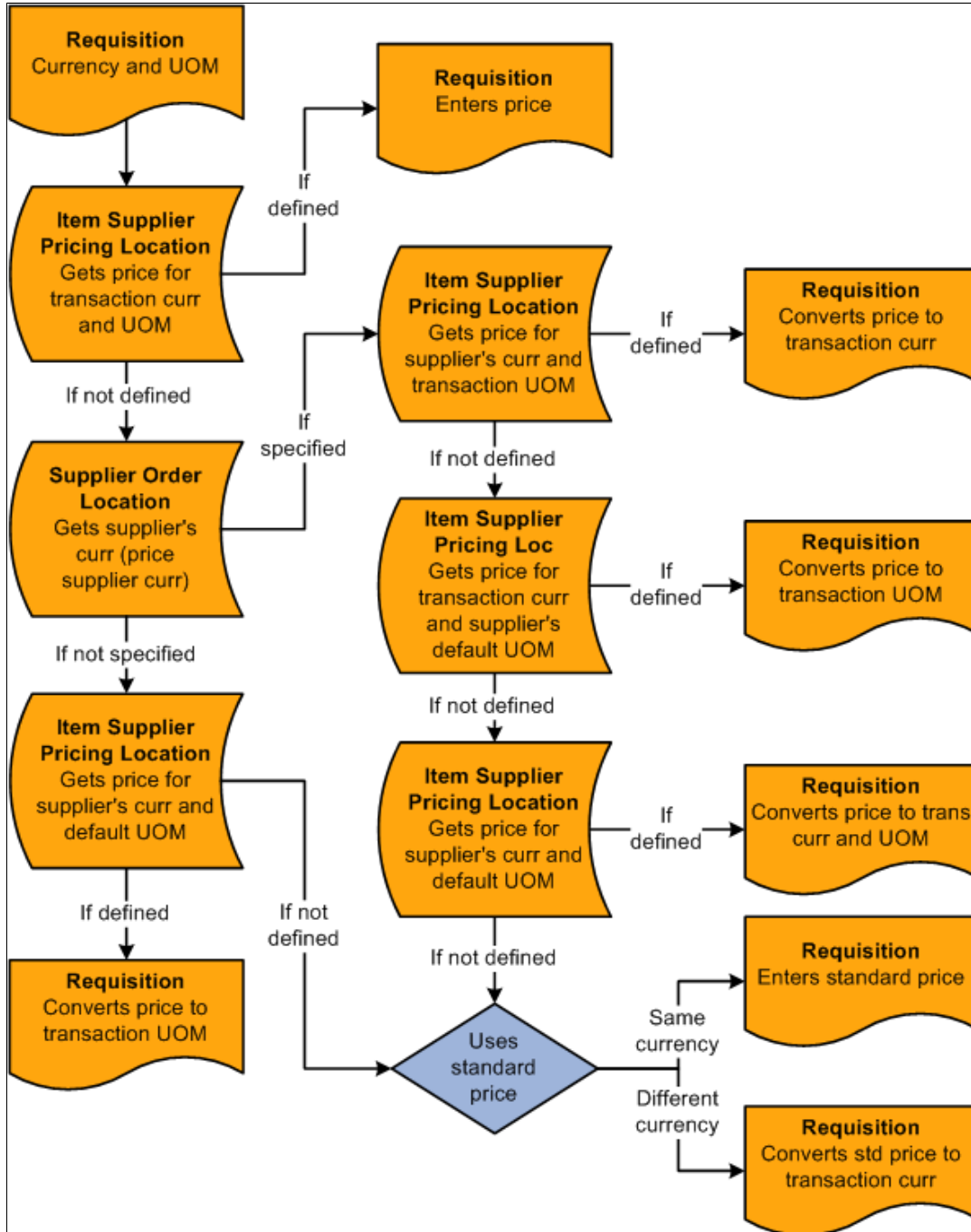

Requisitions are created in the PeopleSoft Purchasing business unit currency when the **Allow Multicurrency Reqs** (allow multicurrency requisitions) check box is clear on the Purchasing Definition - Business Unit Options page. If the check box is selected, the requisition is created in the requester's currency.

When the system determines the pricing location and the pricing location is defined in the Item Supplier setup, the following text describes the steps that the system uses to determine what price to use based on the requisition (transaction) currency.

Use these steps to determine the requisition multicurrency price:

1. If the pricing location has a price defined in the requisition currency and UOM, this is the price that is used.
2. If there is no match in step 1, the system looks at the currency defined for the supplier order location.
3. If the supplier location currency (price supplier location) is not specified, the system moves on to step 4.

If the supplier location currency (price supplier currency) is specified, the system accesses the item-supplier pricing location to obtain the price for the supplier location currency (price supplier currency) and transaction UOM. If there is a match, the system takes that price and converts it to the transaction currency.

4. If there is no match in Step 3, the system uses the transaction currency and supplier default UOM to find a match in the pricing location.

If it finds a match, this price is used on the requisition. When there is no match and if the supplier location currency is not defined, the system skips step 5 and moves on to step 6.

5. If there is no match in step 4, the system uses the price supplier currency derived in step 2 and the default UOM when checking the pricing location.

If there is a match, it converts it to the transaction currency.

6. If there is no match in step 5, the system uses the standard price.

If the currency is different, it converts that price to the transaction currency.

The requisition base price is derived from the transaction price. If the transaction price is in a different currency, the system converts it into the base price currency.

If the **Allow Multicurrency POs** check box is selected on the Purchasing Definition - Business Unit Options page, purchase orders are always built in the supplier order location currency (price supplier currency). If the supplier location currency is not defined, or if the **Allow Multicurrency POs** check box is clear, the purchase order is built in the currency for the PeopleSoft Purchasing business unit.

When the **Override Suggested supplier** check box is clear, the purchase order is built from the requisition, and if currencies are different, the system converts the requisition transaction price or currency to the purchase order currency. If the **Override Suggested Supplier** check box is selected, the system follows the same Supplier location hierarchies described previously.

If the purchase order is built from a requisition and the **Define PO** option was selected during requisition selection, the purchase order is built in the supplier currency, or the modified currency, if it was modified during Define PO.

Related Links

[Purchasing Definition - Business Unit Definition Page](#)

Understanding VAT Drivers, VAT Driver Keys, and the Defaulting Hierarchy for VAT Defaults

The following table lists the PeopleSoft Purchasing VAT drivers and associated VAT driver keys for the VAT Defaults component. The table also indicates which drivers control defaults for the Services VAT Treatment:

VAT Driver	VAT Driver Keys	PeopleSoft Application	Country	State	Applicable to Regular VAT Defaults	Applicable to Services VAT Treatment Defaults
Item BU	Item SetID Item ID Business Unit	Purchasing	Optional	Optional	Yes	No
Item	Item SetID Item ID	Purchasing, Payables	Optional	Optional	Yes	Yes
Item Category	Item SetID Category Code	Purchasing	Optional	Optional	Yes	Yes
Supplier Location	Supplier SetID Supplier ID Supplier Location	Purchasing, Payables	Optional	Optional	Yes	Yes
Supplier	Supplier SetID Supplier ID	Purchasing, Payables	Optional	Optional	Yes	Yes
PO Business Unit	Business Unit	Purchasing	Optional	Optional	Yes	No
PO Options	SetID Process Option ID	Purchasing	Optional	Optional	Yes	Yes

VAT Driver	VAT Driver Keys	PeopleSoft Application	Country	State	Applicable to Regular VAT Defaults	Applicable to Services VAT Treatment Defaults
VAT Entity Registration	VAT Entity Country	All	Required	Optional	Yes	No
VAT Country	Country	All	Not applicable	Optional	Yes	No
Credit Card Provider	Supplier SetID Credit Card Supplier	Purchasing	Optional	Optional	Yes	No

Related Links

“PeopleSoft Global Options and Reports Overview” (PeopleSoft Global Options and Reports)

Using Commitment Control

Understanding Commitment Control in PeopleSoft Purchasing

In PeopleSoft Purchasing, commitment control enables you to track or control commitments, obligations, or expenditures. You can track for encumbrance accounting, as well as check validation against predefined, authorized budgets. Commitment control enables you to automate large portions of the accounting control process.

When you set up your budgets, you designate amounts for those budgets and associate them with the appropriate PeopleSoft General Ledger business unit. After budgets are established, you can track and control all transactions in the procurement life cycle against the overall budget.

From a budgetary perspective, the procurement life cycle includes pre-encumbrances, encumbrances, and expenditures, all of which are tracked against a designated budget. When you use commitment control, the system deducts each type of financial obligation from the budget and tracks it according to obligation type; this enables you to determine how many dollars you have committed in pre-encumbrances, encumbrances, and expenditures. You can liquidate your pre-encumbrance and encumbrance balances by amount or quantity. Depending on the liquidate method that you specify on a document, the budget processor uses that method scheme to calculate the remaining spending authority accordingly.

Here is a high-level overview of the procurement life cycle in commitment control:

1. When you generate a requisition, a pre-encumbrance is created in your budget records by the budget-checking process.
2. When a requisition is sourced to a purchase order, commitment control liquidates the pre-encumbrance from the requisition and establishes an encumbrance for the purchase order.
3. When the purchased goods or services are delivered and the purchase order references a voucher, commitment control liquidates the encumbrance and records an expenditure.

You can set up commitment control to act on transactions that exceed your budget limit. Transactions and future obligations that exceed the budget are exceptions. You can specify the degree of control and corrective action that you want to enable individual users to exercise over exceptions. Commitment control warns you of exceptions if transactions and future obligations exceed your budgeted amounts. You can set this feature to prevent transactions that exceed a designated budget or to warn you about transactions that exceed a budget, and therefore, require corrective action.

Here are some examples of corrective actions:

- Increasing approved budgetary amounts.
- Requesting competitive bids from alternate suppliers.
- Denying requisitions or canceling purchase orders.

- Overriding exceptions by authorized users.

Commitment control enables you to receive warnings about activities that may send your budgets over their approved amounts. For example, a transaction that exceeds the budget can trigger a workflow warning to personnel at a higher level, while still going through the system as if the necessary budget existed. The transaction can also be rejected and stopped without approval from a higher authority. In either scenario, you can define options in PeopleSoft General Ledger that provide you with control over how your system handles exceptions for individual budgets and business units.

Commitment control also enables you to determine a budget date default scheme to use when setting up your system for the first time. Use the Installations Options page to define your preferred budget date defaults. You can either automatically change the accounting date to the document's accounting date, or you can copy the budget date from the predecessor document.

You can view summarized budget checking information for affected transactions on the PeopleSoft Purchasing requisition and purchase order inquiry pages.

Related Links

“Understanding PeopleSoft Commitment Control” (PeopleSoft Commitment Control)

“Understanding Basic Commitment Control Setup” (PeopleSoft Commitment Control)

Delivered Source Transaction Types for Purchasing

PeopleSoft Purchasing delivers seven source transaction types for use in PeopleSoft Purchasing. This table illustrates the delivered source transactions types along with their selection criteria (header record field name and field value) that the system uses for selecting source transactions for budget-checking.

Note: You can modify the selection criteria for these source transaction types but special care should be taken when performing the modifications. These modifications are best done by programmers with extensive experience in PeopleSoft application code.

Source Transaction Types

This table illustrates the delivered source transaction types for use with PeopleSoft Purchasing:

Source Transaction Type	Selection Criteria (Field Name and Field Value Pertaining to Header Record)	Interpretation of Selection Criteria
REQ_PREENC (requisition pre-encumbrance)	REQ_STATUS = A (approved) REQ_STATUS = C (closed) REQ_STATUS = X (canceled) REQ_STATUS = LA (line approved) HOLD_STATUS = N POST_DOC = Y	<p>Requisitions that meet this criteria will be budget checked: requisitions that are not on hold, requisitions with valid ChartField combinations, and those requisitions with a status of approved, closed, canceled, and line approved.</p> <hr/> <p>Note: The line approved status is only applicable if you are using the PeopleSoft eProcurement application.</p> <hr/> <p>If you do not require approval before budget checking, then you could modify the selection criteria and enter a REQ_STATUS = PA (pending approval), and perhaps O (open).</p>
REQ_PRECNP (requisition - non-prorated)	REQ_STATUS = A (approved) REQ_STATUS = C (closed) REQ_STATUS = X (canceled) REQ_STATUS = LA (line approved) HOLD_STATUS = N POST_DOC = Y BUDGET_STATUS = V (valid)	<p>Non-prorated value adjustments (REQ_PRECNP) selection criteria should be the same as requisition pre-encumbrance (REQ_PREENC) selection criteria.</p> <p>If you modify the selection criteria for one source transaction type you should also modify the selection criteria for the other source transaction type.</p>
PO_POENC (purchase order - encumbrance)	PO_STATUS = A (approved) PO_STATUS = C (closed) PO_STATUS = X (canceled) PO_STATUS = D (dispatched) PO_STATUS = PX (pending cancel) HOLD_STATUS = N POST_DOC = Y (ChartField combinations are valid)	<p>Purchase orders that meet this criteria will be budget checked: purchase orders that are not on hold, purchase orders with valid ChartField combinations, and those purchase orders with a status of approved, closed, canceled, dispatched, and pending cancel.</p> <p>If you do not require approval before budget checking, then you could modify the selection criteria and enter a PO_STATUS = PA (pending approval), and perhaps O (open).</p>

Source Transaction Type	Selection Criteria (Field Name and Field Value Pertaining to Header Record)	Interpretation of Selection Criteria
PO_POENCNP (purchase order encumbrance - non-prorate item)	PO_STATUS = A (approved) PO_STATUS = C (closed) PO_STATUS = X (canceled) PO_STATUS = D (dispatched) PO_STATUS = PX (pending cancel) HOLD_STATUS = N POST_DOC = Y	Non-prorated value adjustments (PO_POENCNP) selection criteria should be the same as purchase order encumbrance (PO_POENC) selection criteria. If you modify the selection criteria for one source transaction type you should also modify the selection criteria for the other source transaction type.

Warning! You should not modify the selection criteria for these source transaction types:

- PO_PROCARD (procurement card)
- PO_RAENC (receipt accruals - encumbrance)
- PO_RAEXP (receipt accruals - expense)

Commitment Control Budget Processor Process in PeopleSoft Purchasing

The Commitment Control Budget Processor Application Engine process (FS_BP) enables you to budget check your transactions independent of the online budget checking feature or the batch transaction creation processes. You can select process parameters that capture exactly the group of transactions that you want for budget checking. You access this process from the menu for requisitions, purchase orders, and procurement cards.

The Commitment Control Budget Processor process operates the same whether it is initiated in batch mode using the Process Scheduler or when it is initiated from the purchase order and online entry pages. The batch mode affects a group of transactions whereas the online entry pages affect one transaction. The process compares the total amounts on each transaction (distribution) line to the available amounts in the referenced budget. If any line has an amount that exceeds the available budget, allowing for acceptable tolerances, that line fails budget checking and the system generates an exception message.

After you run the process, the transaction statuses and exception messages are on a batch log, which you can view by clicking the **Message Log** link on the Process Details page.

All lines on a transaction must pass budget checking for the transaction to receive a *Valid* budget status. Transactions with an *Error* budget status have one or more budget exceptions, which is a transaction or a transaction line that has failed budget checking. Transactions in *Error* status must be corrected.

The budget processor records liquidations in the commitment control ledger (LEDGER_KK) as taking place in the fiscal year and accounting period in which the liquidation takes place. For example, when a voucher liquidates a purchase order, the liquidation is recorded using the fiscal year and accounting period of the voucher.

Note: Commitment control is not automatically invoked for requisitions and purchase orders built from batch processes. These transactions must be approved and budget checked using separate processes. If you are using commitment control, a requisition cannot qualify for online sourcing until it has been budget checked and has a *Valid* budget status.

Related Links

[Budget Exceptions](#)

“Understanding Commitment Control Security” (PeopleSoft Commitment Control)

[Understanding the Purchase Order Sourcing Business Process](#)

“Understanding the Budget Checking of Source Transactions” (PeopleSoft Commitment Control)

Open Period

Open period for receipt accrual transactions is the allowable open date range for accounting entry creation and for budget checking transactions if you are using commitment control. If the accounting date falls within the open period date range, the system posts the accounting entry to the actuals ledger. If the transaction budget date falls before or after the open period date range, the system provides an error or warning message to prevent or warn you from running budget checking.

Open period for requisition or purchase order transactions is the allowable open date range for budget checking transactions when you are using commitment control. If the transaction accounting date falls before or after the open period date range, the system provides an error or warning message to prevent or warn you from running budget checking.

When running budget checking, the system translates the accounting date to a fiscal year and accounting period in the budget ledger.

If you are using commitment control, the system sets open period checking to issue errors as a default. You can activate or override open period checking for PeopleSoft Purchasing on the Purchasing Options page. You enter the open period date range according to general ledger business unit on the Update Open Period page.

The system validates the open period for requisitions, purchase orders, procurement cards, requisition and Buyer's Workbench (for cancel and close), batch reconciliation processes, and receipt accrual transactions.

Related Links

“Defining and Updating Open Periods and Adjustment Periods” (Application Fundamentals)

Liquidation Method

Liquidate method is a document schedule control option that instructs the Commitment Control Budget Processor process how to accurately calculate and relieve outstanding pre-encumbrance and encumbrance balances from the budget ledger. You can selectively determine how to liquidate an encumbrance or pre-encumbrance at the document schedule level. To enable this functionality, configure your system to liquidate by quantity. Otherwise, all transactions liquidate by amount. Use the Purchasing Definitions - Business Unit Options page to determine whether a purchase order business unit liquidates by quantity and determine the default liquidate method. You can then modify the liquidate method on the requisition or purchase order, and change it to the desired liquidation method. If you choose to distribute by amount, you can not liquidate by quantity.

When liquidating your balances by quantity, the budget processor must adhere to the following rules:

- Calculate the unit price by using the amount of the preceding document.
- Calculate the liquidate amount by using the predecessors unit price and multiplying it by the standard quantity of the current document.
- Use the newly derived amount to relieve the pre-encumbrance and encumbrance of the preceding document.

Related Links

“Understanding PeopleSoft Application Security” (Application Fundamentals)

[Understanding the Purchase Order Business Process](#)

Document Tolerances

For information on document tolerances see the discussion on the topic.

See [Understanding Document Tolerances](#).

Budget Pre-Check

When running a budget check only (budget pre-check), the budget processor performs the budget checking and edits that it normally does when a budget or transaction is posted, but it does so without committing changes (postings) to the general ledger records such as the Ledger_KK record. The check only feature is specifically intended to check one document, but does not update the Commitment Control tables (ledger and activity log).

To enable budget pre-checking for Purchasing, select **Set Up Financials/Supply Chain > Install > Installation Options > Commitment Control**. Then, select the **Purchasing** check box in the Enable Budget Pre-check section. You must also ensure that if the **Purchasing** check box is selected in the Enable Commitment Control section on the Installation Options - Products page

The **Budget Pre-Check** button is available for use on these PeopleSoft Purchasing pages:

- Requisition
- Requester's Workbench
- Purchase Order
- Express Purchase Order
- Buyer's Workbench

When you perform budget pre-check only processing, the statuses of *Provisionally Valid* or *Error* on the transaction pages indicate whether a budget is available. If you click the **Budget Pre-Check** button and if the budget check is valid, then the system sets the budget header status for the requisition to *Prov Valid*. If the budget check is not valid, then the system sets the budget header status to *Error* with a link to the Exception page.

Related Links

“Checking Budget Journals and Transactions Without Posting” (PeopleSoft Commitment Control)

Budget Exceptions

When using commitment control with PeopleSoft Purchasing, you track all requisition, purchase order and non-prorated purchase order transactions, procurement cards, and receipt accrual transactions that you submit, even if they cause you to go over budget. If you have a transaction that causes you to go over budget, you can adjust either your transaction or your budget to handle the exception.

Inevitably, some transactions do not pass the budget-checking process and the system identifies them as exceptions. Some of the circumstances that generate errors include:

- Insufficient funds for a particular transaction.
- Inconsistent ChartField combinations.
- Transaction has an offset account.
- Budget date for a transaction is out of bounds.

Depending on the configuration of your control budgets, the exact reason that a budget has insufficient funds varies from budget to budget. The budget may be on hold, closed, or simply out of funds. Additionally, you may have set up some budgets to approve transactions even if they go over budget amounts. Because of this, exceptions fall into two categories: warnings and errors.

Error Correction

You can correct errors for transactions by taking one or more of the following actions:

- Change the amount on the transaction lines to conform to budget limits.
- Change the budget amounts to enable more transactions to pass budget check.
- Override the budget for a particular transaction.
- Override the entire transaction for all affected budgets.

Only a user with proper authorities can perform this type of correction.

Transactions fail budget checking if they have at least one line that fails budget checking for at least one budget. These transactions are candidates for overrides on either a budget basis or a transaction basis. You are notified of exceptions in two ways: online and through workflow notification.

In an online situation, you receive a message regarding a transaction status when the budget-checking process is complete. The message indicates the type of exception the transaction created and enables you to access the Transaction Exception page, where you can either view the warnings generated or override the errors.

In a batch budget-checking situation, users are notified of exceptions through workflow, based on their individual security profiles in the system. The system generates an appropriate worklist for each user. Your users have access to a list of budgets that caused exceptions or a list of transactions with exceptions. These two options are available through the PeopleSoft menus or through the worklist.

There are a few different methods to access and override exceptions. You can:

- Choose a particular budget from a worklist and access the Budget Exceptions page to view a list of all transactions that have failed for that budget.
- Choose a particular transaction on a worklist and access the Transaction Exception page to view a list of all budgets that have caused exceptions on that transaction.
- Click the Budget Status link on the document that has an error. When you click this link you access the Transaction Exceptions page.

On a document with errors, the budget status field will become a link.

The worklist contains a complete list of exceptions, stating the exact cause of the error or warning. These methods enable you to inquire about exceptions and to set overrides. Once the transaction is overridden, the system sends a warning notification.

Related Links

[Understanding PeopleSoft Purchasing Workflow](#)

“Setting Up and Running Exception Notification” (PeopleSoft Commitment Control)

“Understanding Viewing and Handling of Budget Transaction Exceptions” (PeopleSoft Commitment Control)

“Viewing and Handling Budget Transaction Exceptions” (PeopleSoft Commitment Control)

Budget Overrides

Various override attributes can affect a budget-checked transaction:

- Only authorized users can perform transaction and budget overrides.
- Multiple super users can override different budgets for the same transaction.
- A super user need only override a budget for a particular transaction once, unless that transaction changes after the override.
- A user can perform an online remote call to the Commitment Control Budget Processor process.

This process budget checks the transactions that the user selected. Transaction lines with overridden budgets receive a warning for every budget that was exceeded. The system refreshes the budget and transaction exception pages to reflect these changes.

The actual process of overriding a budget just requires selecting a check box on the appropriate page. A super user can access either the Budget Exceptions page or the Transaction Exception page to override specific budgets or transactions.

Related Links

“Viewing and Handling Budget Transaction Exceptions” (PeopleSoft Commitment Control)

“Understanding Commitment Control Security” (PeopleSoft Commitment Control)

Effects of Changes to Budget-Checked Transactions

Altering a transaction that has been through budget checking results in the deletion of all existing exception rows for the transaction. The Commitment Control Budget Processor process deletes the

exception rows when the altered transaction is budget checked again. This includes the deletion of override marks for any budgets that appear on the altered transactions. A message to this effect appears when the budget is identified for override and you save the page.

Altering a transaction after it has been budget checked forces the Commitment Control Budget Processor process to treat the transaction as if it were new when budget checking is performed again. All previous exceptions are deleted, and any new ones are recorded as the transaction moves through the Commitment Control Budget Processor process.

Similarly, altering budgets can affect active transactions. The Commitment Control Budget Processor process reacts to the most current budget data. Consequently, if you alter your budgets and run a budget check, errors on active transactions can change.

Note: If your transaction fails the Commitment Control Budget Processor process, you must override the budget information using the Budget Exceptions page. Otherwise budget changes can be made by increasing the budget by editing the budget entry.

To make changes to transactions that have been budget checked:

1. Open the source transactions and make the changes to specific transactions.
2. Save your changes.
3. Run the Commitment Control Budget Processor process again to check the budget.

The Commitment Control Budget Processor process removes the original commitment control journal and creates a new one with the changed transactions.

This table lists examples of transaction changes and their resulting effects:

<i>Transaction Change</i>	<i>Effect</i>
Change requisition quantities and requisition item prices.	Changes final pre-encumbrance amount generated during budget checking.
Change purchase order quantities and item prices.	Changes final encumbrance amounts generated during budget checking.
Modify ChartFields.	Sets the budget status to <i>Not Checked</i> . Requires another run of the budget processor.
Cancel, delete, or insert a requisition line.	Sets budget-header status to <i>Not Checked</i> . Requires another run of the budget processor to release the pre-encumbrance.

This table lists examples of budget changes and their resulting effects:

Budget Change	Effect
Change arrangement of budgets. Move a detail budget under a new summary budget. Technically, you would be changing the tree or the node level within the same tree that the system uses to translate the relationship between a detail budget and a summary budget. You may be moving a node to a new tree.	If this change results in a transaction that is no longer controlled by the original budget, you must change all relevant transactions to reference the budget in its new location or to reference a new detail budget.
Increase or decrease budget amounts.	Generates different exceptions for all affected transactions. Increasing your budget decreases exceptions and decreases your budget increases exceptions.
Adjust tolerances for a particular budget.	Increasing tolerances generally enables more transactions to pass budget checking within tolerance. Decreasing tolerances generally enables fewer transactions to pass. Although this alteration does not change the total number of exceptions, it does change the proportion of errors and warnings generated for a particular transaction or budget. You receive more warnings and fewer errors.
Alter the status of a budget.	There are three possible statuses for budgets: <i>Open</i> , <i>Hold</i> , and <i>Closed</i> . If you change the status of a budget, that action affects all referencing transactions captured in the next budget check.

Related Links

“Viewing and Handling Budget Transaction Exceptions” (PeopleSoft Commitment Control)

Commitment Control and PeopleSoft Purchasing Close Processes

If you have commitment control enabled, the Close Requisitions (PO_REQRCON) and Close Purchase Orders (PO_PORECON) Application Engine processes consider this functionality.

After you have selected your process parameters and run a close process, the process verifies whether you have enabled commitment control. If it is enabled, the process updates the budget distribution lines and the budget header on all requisitions (for PO_REQRCON) or purchase orders (for PO_PORECON) that meet the close criteria. The status on the distribution line and the header changes from *V* (valid) to *N* (not checked).

The close processes set the budget status to *Not Checked* and the fully liquidated flag to *Yes*. Run the budget processor to relieve the remaining encumbrance.

For example, you have a purchase order for 100.00 USD, but after discounts, the supplier only invoices you for 98.00 USD. Before running the Close Purchase Orders process, the remaining 2.00 USD still exists as an encumbrance. When you close the purchase order, you must liquidate the remaining encumbrance for 2.00 USD. For this reason, the Close Purchase Orders process set the budget status to *Not Checked* and fully liquidated flag to *Yes*. You then run the budget processor to relieve the remaining encumbrance. The running of the budget processor is not an automated step in the close processes.

The commitment control process creates separate closing entries in the PeopleSoft Commitment Control activity log for purchase orders and requisitions. The activity log retains and displays the complete budgetary life cycle of purchase orders and requisitions.

Related Links

[“Viewing the Activity Log” \(PeopleSoft Commitment Control\)](#)

[Understanding the Close Purchase Orders Process](#)

[Understanding the Close Requisitions Process](#)

Budget Checking Receipt Accruals

This process is used to budget check the expense and encumbrance reclassification transactions. You can budget check either type.

Related Links

[Performing Budget-Checking for Receipt Accruals](#)

Common Elements Used in Commitment Control and PeopleSoft Purchasing Close Processes

<i>Field or Control</i>	<i>Description</i>
Activity ID	Activity ID assigned to the individual tasks or events that you want to update in a project.
Advanced Budget Criteria	Select to access the Budget Exceptions - Refine Inquiry Criteria page.
Budget Date	Budget date of the transaction line. You define which field the system uses for the budget date for the transaction in the source transaction definition.
Budget Period	Period to which the budget transaction posts.
Exception Type	Select to limit the exception rows retrieved to transactions with either an <i>Error</i> or <i>Warning</i> exception. This is a required field.
Foreign Amount	The amount of the line in the entry currency.
Line Status	Use to limit the rows to lines with either <i>Error</i> or <i>Warning</i> exceptions.
Maximum Rows	Select the maximum number of rows that are to appear in the scroll area.
Monetary Amount	The amount in the base currency of the primary ledger.

Field or Control	Description
More Budgets Exist	If selected, the transaction has more exceptions than the number that you entered in the Maximum Rows field.
More Lines Exist	If selected, the transaction has more transaction line exceptions than the number that you entered in the Maximum Rows field.
Override Budget	<p>Select to update the control budget although the transaction exceeds the budget. This option is available only if the budget transaction fails budget checking and you have super-user authority. It is not available if the source transaction type does not enable overrides and the budget header status is <i>Not Checked</i>. The budget header status appears as <i>Not Checked</i> if you changed the source transaction after the Commitment Control Budget Processor process issued the exceptions and you have not run the process again.</p> <p>After you override a budget with exceptions, adjust the budget available amount, or adjust the source transaction amount; the transaction passes budget checking.</p>
Override Transaction	Select to enable the entire transaction to update the control budget, even if error exceptions exist. This option is available only for super users. This option is not available if the transaction passes budget checking with only warning exceptions. You can select it prior to budget checking or after you run the Commitment Control Budget Processor process and it returns errors.
PC Business Unit (PeopleSoft project costing business unit)	Business unit assigned to the project in PeopleSoft Project Costing.
Resource Type	Resource category, such as labor, associated with a given cost. This is used in conjunction with resource categories, resource subcategories, and resource groups.
Tran Type (transaction type)	<p>Select the type of transaction that you want to budget check. Values are:</p> <p><i>REQ_PREENC</i>: Requisition pre-encumbrance.</p> <p><i>REQ_PRECNP</i>: Non-Prorated requisition pre-encumbrance.</p> <p><i>PO_POENC</i>: Prorated purchase order encumbrance.</p> <p><i>PO_POENCNP</i>: Non-prorated purchase order encumbrance.</p> <p><i>PO_PROCARD</i>: Procurement card transaction.</p> <p><i>PO_RAENC</i>: Receipt accrual encumbrance.</p> <p><i>PO_RAEXP</i>: Receipt accrual expenses.</p>

Field or Control	Description
Type	Displays the related accounting entry type.
Budget Override Available Info	Click the Budget Override Available Info button to determine the reason why you cannot override a single budget entry.
Budget Check	Click to run the remote call budget processor again once you override the transaction or a budget. You should also run the process again if you change the requisition, purchase order, or procurement card transaction.
Tran Override Available Info (transaction override available information)	Click the Tran Override Available Info button to determine the reason why you cannot override the transaction.
Budget Override	Select the Budget Override tab to access a page that enables you to access the Budget Exceptions page or Budget Details page. You must have authority to inquire about the budget to access these pages.
View Exception Details	Click the View Exception Details button at the exception header level to access the Exception Details page for transaction headers to view the budgets with error or warning exceptions, budget ChartFields, and any overrides.
Run Control ID	Create a unique run control ID for each type of source transaction that you want to budget check independently of other source transactions. If you use the same run control ID for purchase orders and requisitions, the budget processor will process both purchase orders and requisitions existing at the time the run control ID is used to initiate the budget checking process. For example, this occurs if you have created a run control ID of BPO1 for both purchase orders and requisitions. However, if you create a different run control ID for purchase orders and requisitions, the different source transactions are processed independently of each other. For example, creating BPPO1 for purchase orders and BPRQ1 for requisitions enables you to budget check the two source transactions independently of one another.

Related Links

[Commitment Control Budget Processor Process in PeopleSoft Purchasing](#)

“Understanding PeopleSoft ChartFields” (Application Fundamentals)

“Setting Up Application-Specific Installation Options” (Application Fundamentals)

“Viewing Budget Details and Transaction Activity” (PeopleSoft Commitment Control)

“Viewing and Handling Budget Transaction Exceptions” (PeopleSoft Commitment Control)

“Understanding the Budget Checking of Source Transactions” (PeopleSoft Commitment Control)

Using Partial and Final Liquidation

If you are using commitment control, you can specify partial or final liquidation of a requisition when it is sourced to a purchase order. When you create or modify a purchase order, you can designate that the purchase order is final, prompting the system to liquidate the preceding requisition. You can make your purchase order the final document to be affected by the preceding requisition, for less money than you originally authorized. You can also reverse the finalization of the document.

In PeopleSoft Purchasing, you can perform partial or final liquidations where the successor transaction references and liquidates its predecessor, including:

- Requisition to purchase order.
- Purchase order to payment voucher.

The system fully liquidates document lines automatically upon completion of the subsequent transaction when you designate the transaction as final. The system then creates the appropriate accounting entries to relieve outstanding pre-encumbrances and encumbrances, performing the reversing entry according to the document type and entry event of the referenced transaction.

Using partial and final liquidation, you can:

- Liquidate requisition or purchase order lines and relieve the outstanding pre-encumbrance and encumbrance from the budget ledger.
- Create the appropriate accounting transactions in the budget to relieve outstanding pre-encumbrances and encumbrances as applicable.
- Perform the correct accounting and available (open) amount calculations for modifications and cancellations of predecessor or successor transactions.
- Process final liquidations at the schedule line level of transactions, that is, orders can have some lines open while others are closed.

The corresponding voucher lines that reference (liquidate) the lines determine this.

At times, multiple transactions reference the same predecessor. If two payment vouchers for two invoices of 500.00 USD each are associated to the same 1000.00 USD purchase order, only the second payment voucher is considered final. The first 500.00 USD payment voucher is considered partial, because an additional 500.00 USD encumbrance remains outstanding. If the first 500.00 USD actually represents the last expected action against the order, you can designate the voucher as *final for less* and relieve the entire 1000.00 USD encumbrance.

Partial and Final Liquidation Example

For example, suppose that you create a requisition for 200.00 USD and run budget checking. The system shows an increase of 200.00 USD to the existing pre-encumbrance amount of 40.00 USD.

Ledger	Amount
Budget	5,000,000.00 USD

<i>Ledger</i>	<i>Amount</i>
Expense	0.00 USD
Encumbrance	1000.00 USD
Pre-encumbrance	240.00 USD

Then create a purchase order that references this requisition for 165.00 USD. When you run budget checking, the pre-encumbrance decreases and the encumbrance increases by 165.00 USD.

<i>Ledger</i>	<i>Amount</i>
Budget	5,000,000.00 USD
Expense	0.00 USD
Encumbrance	1165.00 USD
Pre-encumbrance	75.00 USD

Create another purchase order that references this requisition for 25.00 USD, finalize the purchase order and run budget checking. The total for all purchase orders is 190.00 USD, but the pre-encumbrance is liquidated with the full requisition amount of 200.00 USD. The pre-encumbrance decreases and the encumbrance increases by 25.00 USD.

<i>Ledger</i>	<i>Amount</i>
Budget	5,000,000.00 USD
Expense	0.00 USD
Encumbrance	1250.00 USD
Pre-encumbrance	40.00 USD

To liquidate a requisition for an amount lower than the original:

1. Reduce the quantity or price total on the purchase order to the correct amount
2. Click the **Finalize Document** button.
3. Save the purchase order.

4. After approving the revised purchase order, run budget checking to confirm the correction.

Reversing Partial or Final Liquidation

You can also reverse finalization of a purchase order or voucher. The system then restores the original budgetary amount to the preceding documents that had previously been liquidated. If you do not declare a document final (for less), no additional liquidation takes place. The system replicates the partial or final status of a document down to all the document distribution lines associated with the given document schedule, adjusting all ledgers accordingly.

For example, you can process a requisition for 1000.00 USD, then create a purchase order for only 700.00 USD, without expecting to spend the remaining 300.00 USD that the requisition authorizes. You can declare the purchase order final (for less), thereby liquidating the pre-encumbered 300.00 USD from the requisition and freeing that money for other purposes.

If you find later that you need to spend another 250.00 USD on the purchase order from the original requisition, you should either click the **Undo Finalize Line** button or the **Undo Finalize Entire Document** button and save the purchase order. Then, select to budget check the revised purchase order document again. You can declare the purchase order partial, thus liquidating the requisition and freeing the last 50.00 USD for other purposes.

When you finalize the purchase order document on the affected requisition and then perform a budget check on the purchase order again, the **Final** field is selected and the **Budget Line Status** value on the Statuses tab is set to *Valid on PO Distribution*. Also, the **Commitment Control Close Flag** check box is selected on the Details tab on the Maintain Requisitions – Distribution page.

When you undo finalize on the purchase order document on the affected requisition and then budget check the purchase order again, the **Final** field is cleared, and the **Budget Line Status** field value on the Statuses tab is set to *Valid on PO Distribution*. In this case, the **Commitment Control Close** check box is deselected on the Details tab on the Maintain Requisitions – Distribution page.

To reverse a reduction:

1. Clear the final check box for the affected line or lines, or click the **Undo Finalize Entire Document** button.
2. Save the purchase order.
3. Run budget checking to confirm the correct amount.

Budget Checking After Partial or Final Liquidation

You must budget check each purchase order after you declare it either final (for less) or partial. During budget checking, the system treats a finalized purchase order as a direct encumbrance, still subject to pre-encumbrance tolerance checking.

Note: If two or more purchase orders are linked to one requisition, none of those purchase orders can be finalized until all of those purchase orders have passed budget checking.

Note: You cannot change a purchase order's liquidation status while its budget-checking status is in *Error* or once the distribution has been canceled.

Note: You can only indicate that a purchase order is partial after it has successfully completed budget checking.

Running Entry Events After Partial or Final Liquidation

If you're using entry events, you must run them after budget checking. This generates your pro forma accounting entries, adjusted for finalization or partialization.

Related Links

[Understanding Commitment Control in PeopleSoft Purchasing](#)

[Understanding Entry Events in PeopleSoft Purchasing](#)

Budget Checking Requisitions

This section discusses how to budget check requisitions:

Pages Used to Budget Check Requisitions

<i>Page Name</i>	<i>Definition Name</i>	<i>Usage</i>
Req Budget Check (requisition budget check) Page	REQ_KK_CHECK_REQ	Run the Comm. Ctrl. Budget Processor process for requisitions. Commitment control must be enabled for PeopleSoft Purchasing.
Budget Checking Requisitions Using Online Pages	REQ_FORM	Create requisitions online.
Requisition Exceptions Page	KK_XCP_HDR_PO2	View budget check exceptions for requisitions. Users with appropriate authority can override the budget exceptions on this page.
Requisition Line Drill Down Page	KK_DRL_PO2_SEC	View line details for requisitions with budget exceptions.
Line Exceptions Page	KK_XCP_LN_PO2	View requisition lines on a requisition with budget check exceptions. Users with appropriate authority can override the budget exceptions on this page.

Req Budget Check (requisition budget check) Page

Use the Req Budget Check (requisition budget check) page (REQ_KK_CHECK_REQ) to run the Comm.

Ctrl. Budget Processor process for requisitions. Commitment control must be enabled for PeopleSoft Purchasing.

Navigation:

Purchasing > Requisitions > Budget Check Requisition

REQ_PREENC process runs once budget check is, selected

Process Options

<i>Field or Control</i>	<i>Description</i>
Req ID (requisition ID)	<p>Values are:</p> <p><i>All:</i> Select to budget check all requisitions.</p> <p><i>Some:</i> Select to display the From and To fields. Budget checks all requisitions that match the range specified in the From and To fields.</p> <p><i>Value:</i> Select to display the Req ID field. Budget checks the requisition that matches the ID specified in the Req ID field.</p>
Req Date (requisition date)	<p>Values are:</p> <p><i>All:</i> Select to budget check all requisitions.</p> <p><i>Some:</i> Displays the From and To fields. Budget checks all requisitions for which creation dates fall within the dates specified in the From and To fields.</p> <p><i>Value:</i> Displays the Req Date field. Budget checks requisitions for which creation dates match the date specified in the Req Date field.</p>

Budget Checking Requisitions Using Online Pages

When you create online requisitions, you can budget check them in realtime by clicking the **Budget Check** button on the Maintain Requisitions - Requisition page. This invokes the Commitment Control Budget Processor process by remote call.

Related Links

[Commitment Control Budget Processor Process in PeopleSoft Purchasing](#)
[Creating Requisition Header Information](#)

Budget Checking Purchase Orders

This section discusses how to Budget Check purchase orders

Pages Used to Budget Check Purchase Orders

<i>Page Name</i>	<i>Definition Name</i>	<i>Usage</i>
<u>Budget Check Request Page</u>	PO_KK_CHECK_REQ	Run the Comm. Ctrl. Budget Processor process for purchase orders. You must enable commitment control for PeopleSoft Purchasing.
<u>Maintain Purchase Order - Purchase Order Page</u>	PO_LINE	Enter or change purchase order information online.
Purchase Order Exceptions Page	KK_XCP_HDR_PO1	View budget check exceptions for purchase orders. Users with appropriate authority can override the budget exceptions on this page.
Purchase Order Line Drill Down Page	KK_DRL_PO1_SEC	View line details for purchase orders with budget exceptions.
Line Exceptions Page	KK_XCP_LN_PO1	View lines on a purchase order with budget check exceptions. Users with appropriate authority can override the budget exceptions on this page.
Purchase Order (NP) Exceptions Page (purchase order non-prorated exceptions)	KK_XCP_HDR_PO1N	View budget check exceptions for non-prorated purchase orders. Users with appropriate authority can override the budget exceptions on this page.
NonProrated Purchase Order Line Drill Down Page	KK_DRL_PO1N_SEC	View line details for non-prorated purchase orders with budget exceptions.
Line Exceptions Page	KK_XCP_LN_PO1N	View lines on a non-prorated purchase order with budget check exceptions. Users with appropriate authority can override the budget exceptions on this page.

Budget Check Request Page

Use the Budget Check Request page (PO_KK_CHECK_REQ) to run the Comm.

Ctrl. Budget Processor process for purchase orders. You must enable commitment control for PeopleSoft Purchasing.

Navigation:

Purchasing > Purchase Orders > Budget Check Purchase Order > PO Budget Check Request

PO_POENC and *PO_POENCNP* processes when the budget check is executed for both the prorated and non prorated purchase orders .

Process Options

<i>Field or Control</i>	<i>Description</i>
PO ID (purchase order ID)	<p>Values are:</p> <p><i>All:</i> Budget checks all purchase orders.</p> <p><i>Some:</i> Select to display the From and To fields. Budget checks all purchase orders that match the range specified in the From and To fields.</p> <p><i>Value:</i> Select to display the PO ID field. Budget checks the purchase order that matches the ID specified in the PO ID field.</p>
PO Date (purchase order date)	<p>Values are:</p> <p><i>All:</i> Select to budget check all purchase orders.</p> <p><i>Some:</i> Displays the From and To fields. Budget checks all purchase orders for which creation dates fall within the dates specified in the From and To fields.</p> <p><i>Value:</i> Displays the PO Date field. Budget checks purchase orders for which creation dates match the date specified in the PO Date field.</p>

Budget Checking Purchase Orders Using Online Pages

When you create online purchase orders, you can budget check them in realtime by clicking the **Budget Check** button on the Maintain Purchase Order - Purchase Order page. This invokes the Commitment Control Budget Processor process by remote call.

Related Links

[Commitment Control Budget Processor Process in PeopleSoft Purchasing](#)
[Creating Purchase Order Headers](#)

Budget Checking Procurement Cards

You can now perform budget check and ChartField edit validations for your procurement card transactions during the Statement Load process and online processing. Use the budget processor to invoke budget check and ChartField edits after staged data is loaded into the Statement Load process and when users use the Reconcile Statement component.

You can use the budget check or the ChartField Edit validation process during:

- The Statement Load process.

If you enable commitment control for procurement cards, the system validates the budget rows. If rows are not budget checked, the budget status is *N* (not checked). If a row fails the budget check, the budget status is *E* (error). If rows pass the budget check, the budget status is *V* (valid).

If you selected edit combination options on the Purchasing Options page, the system performs ChartField edit combinations based on the ChartField Editing template. The system indicates a status of *V* (valid for passing rows) or *R* (recycle for rows that fail).

- Online processing.

If you enable commitment control for procurement cards, the system performs ChartField edits and budget-check validations after users modify the distribution information and click the **Save** button on the Reconcile Statement page.

The system also validates for ChartField combinations on the Distribution Templates page. Once a user modifies and saves information on this page, the system automatically uses the budget processor to check for valid ChartFields.

Note: To budget check procurement cards, first select the procurement card option on the Installation Options page.

Users can access the Budget Check Exceptions page to fix all rows that did not pass budget check. All failed rows must be fixed before they can successfully pass budget check.

This section discusses how to Budget Check Procurement Cards:

Pages Used to Budget Check Procurement Cards

<i>Page Name</i>	<i>Definition Name</i>	<i>Usage</i>
<u>Load Statement Page</u>	RUN_CC_LOADTRANS	Run the ProCard Load Statement Application Engine process (PO_CCLOADLD) to load the statement lines from the staging table into the statement tables and to perform auto-reconciliation using the settings that you defined on the Procurement Card Load Statement Options page.

Page Name	Definition Name	Usage
Reconcile Statement - Procurement Card Transactions Page	CC_RECON_WB	Review, manage, and approve procurement card transactions loaded by the ProCard Load Statement process. You can view all of the procurement card transactions that you have been granted authority to access on the Card Data page.
Budget ChartField Validation Page	CC_KK_CHECK_REQ	Run the Comm. Cntrl Budget Processor process for the procurement cards in batch mode.
Budget Check Exceptions Page	KK_XCP_HDR_PO3	Review procurement card transactions that failed the budget check process.
“Source Transactions - Definition Page” (PeopleSoft Commitment Control)	KK_SOURCE_TRAN1	Define source transactions for commitment control. Select <i>Planned</i> as the value for the Commitment Control Amount Type field.
Budget Definitions - Control Budget Options Page	KK_BUDG1	Establish budgetary controls. If you select Entries Must Balance on the Control Budget Options page, enter a default account value for at least one SetID for budget entry offsets. You must also enter a source transaction offset account for each source transaction type that affects this budget definition.

Related Links

“Setting Up Cross-Application Installation Options” (Application Fundamentals)

Load Statement Page

Use the Load Statement page (RUN_CC_LOADTRANS) to run the ProCard Load Statement Application Engine process (PO_CCLOADLD) to load the statement lines from the staging table into the statement tables and to perform auto-reconciliation using the settings that you defined on the Procurement Card Load Statement Options page.

Navigation:

Purchasing > Procurement Cards > Process Statements > Load PCard Statement

Related Links

[Loading Procurement Card Statements to Application Tables](#)

Reconcile Statement - Procurement Card Transactions Page

Use the Reconcile Statement - Procurement Card Transactions page (CC_RECON_WB) to review, manage, and approve procurement card transactions loaded by the ProCard Load Statement process.

You can view all of the procurement card transactions that you have been granted authority to access on the Card Data page.

Navigation:

Purchasing > Procurement Cards > Reconcile > Reconcile PCard Statement

When you create or modify procurement cards using the Reconcile Statement - Procurement Card Transactions page, you can budget check them in real time when you save the page. Saving the page invokes the Commitment Control Budget Processor process by remote call.

Running Budget Period-End Processes

This section provides an overview of budget period-end processing and discusses how to run budget period-end processes.

Pages Used to Run Budget Period-End Processes

Page Name	Definition Name	Usage
Close Requisitions Page	RUN_REQRECON	Run the Close Requisitions process and produce the Close Requisition SQR report (PORQ009).
Close PO Page	RUN_PORECON	Run the Close Purchase Order process and produce the Close Purchase Order SQR report (POPO008).
PO Rollover Page	PO_ROLLOVER	Select purchase orders to rollover and change their statuses to <i>Pending</i> before running the PO Rollover1 process. Check the roll status of the purchase orders.
Purchase Order Selection Page	PO_ROLLOVER_SEARCH	Use the filters to choose purchase orders for consideration for rollover.
Purchase Order Details Page	PO_ROLLOVER_LN	View additional details for purchase orders listed on the Purchase Order Selection page.
PO Rollover1 Page	RUN_POROLL1	Run the PO Rollover1 process.

Page Name	Definition Name	Usage
Budget Check Request Page	PO_KK_CHECK_REQ	Run the Commitment Control Budget Processor process.
PO Rollover2 Page	RUN_POROLL2	Run the PO Rollover2 process.

Understanding Budget Period-End Processing

Because a budget period can span a calendar or fiscal year, PeopleSoft uses the term *period-end* universally and applies it to the end of a budget period, the end of a fiscal year, or the end of a calendar year.

The budget period-end processes enable you to continue budgets across budget periods or fiscal years. You may have budgets that stay in force for more than one fiscal period. You may have project budgets that span more than one calendar year. Consequently, you may want to keep budgets in force across these time frames. The commitment control feature in PeopleSoft Purchasing provides you with two options.

You can keep a budget active beyond the end of a fiscal period, allowing purchasing transactions to reference that budget and to remain unaffected by fiscal period-end accounting procedures. This option is useful for project-related budgets that are finite in scope.

You can also close a budget at the end of a budget period and reestablish it in the next period while keeping all outstanding transactions active into the next budget period. This option is useful for ongoing accounts and budgets that you want to infuse with additional funds at regular intervals. You can end one period and start the next one with new amounts in selected budgets. You do not lose your outstanding transactions from the previous budget period, which saves you from having to enter them all over again in the new budget period. PeopleSoft Purchasing enables you to roll these transactions over into the new budget period automatically by using these budget period-end business processes.

Budget period-end processes differ from fiscal period-end processes. Your fiscal period-end closing entries have no effect on the commitment control ledgers. Therefore, fiscal period-end closing entries do not invoke the Commitment Control Budget Processor process for budget checking.

- The first period-end business processes are the close processes for requisitions and purchase orders that remove outstanding requisitions and purchase orders from your budget.
- The other aspect of these processes involves use of the PO Rollover1 (PO_POROLL1) and PO Rollover2 (PO_POROLL2) Application Engine processes.

These processes enable you to budget check distribution lines against budgets with expiring periods and then roll funds over to new periods.

Related Links

[Loading Procurement Card Statements to Application Tables](#)

[Understanding the Close Purchase Orders Process](#)

[Understanding the Close Requisitions Process](#)

Rolling Over Purchase Orders at Budget Period-End

This section provides an overview of purchase order rollover process and discusses how to Rollover Purchase Orders.

Pages Used to Rollover Purchase Orders

Page Name	Definition Name	Usage
<u>PO Rollover View Page</u>	RUN_POROLLVW	Create a data set for retrieval by the purchase order rollover workbench by initiating the Rollover View (PO_POROLLVW) Application Engine process.
<u>PO Rollover (purchase order rollover) Page</u>	PO_ROLLOVER	Select purchase orders to rollover and change their status to <i>Pending</i> before running the PO Rollover1 process. Check the roll status of purchase orders.
<u>Purchase Order Details Page</u>	PO_ROLLOVER_LN	View additional details for purchase orders listed on the PO Rollover page.
POs Not Budget Checked	PO_ROLL_REQ_FIN	View details about purchase orders that have yet to reach a budget check status of <i>Valid</i> , thus enabling requisition finalization.
<u>PO Rollover1 Page</u>	RUN_POROLL1	Run the PO Rollover1 process.
Budget Check Request	PO_KK_CHECK_REQ	Run the Commitment Control Budget Processor process.
<u>PO Rollover2 Page</u>	RUN_POROLL2	Run the PO Rollover2 process.
<u>Roll Open Encum (roll open encumbrance) Page</u>	RUN_POROLLO	Run the PO Roll Open Encum process.
<u>Run Roll Exception Page</u>	RUN_ROLL_EXCEPTION	Run the Non Qualified PO Listing process.

Understanding the Purchase Order Rollover Process

If you are using commitment control, you can use purchase order rollover to budget check distribution lines against budgets with expiring budget periods and then roll funds over to new budget periods. PeopleSoft Purchasing enables you to select specific purchase orders to rollover.

Purchase orders that are canceled, fully vouchered, on hold, in process, or have not been successfully budget checked are not qualified for rollover. In addition, distribution lines that are canceled, closed or fully liquidated (that is, the commitment control close flag (KK_CLOSE_FLAG) is set to Y) do not qualify for rollover.

The system places strict requirements on purchase orders and their interdependence with accounts payable, receiving, and commitment control before it makes the purchase orders eligible for rollover. To assist you in reviewing details about why the purchase order is not qualified for rollover and provide you a way to manage exceptions across a large data set, the system provides two options for working with rollover exceptions.

First, you can use the PO Rollover View page to define specific fields that create data sets that you can use to review purchase order rollover information. A search ID value is used to define a data set. As an example of creating a data set, you might want to include only those purchase orders where the Project ChartField is within a range or you might want to exclude purchase orders where the Project ChartField is populated.

When you run the PO_POROLLVW process, the system creates the search ID that you define. You can then use the PO Rollover Workbench to retrieve the search ID with the corresponding rollover details. You can also use the workbench to identify purchase orders that you do not want to rollover. The system filters these purchase orders out for future iterations of the POROLLVW process.

During PO Rollover process if the search criteria match the PO distribution, the distribution line gets created for the matching distribution with the budget date of the new period. However, in case of non-matching PO distribution, the distribution lines remain unchanged.

The next rollover exception option enables you to view which purchase orders are not qualified for rollover. To view the purchase orders, you run the POROLLEXP process to create the PO Rollover Exceptions report. You can run the report from within the PO Rollover Workbench, the PO Rollover View page, or the PO Rollover page, or you can use the Non Qualified PO Listing menu option. The report displays the non-qualified purchase orders and their associated documents. To populate the tables to produce the PO Rollover Exceptions report, run the PO Rollover view process to select the disqualified orders.

Note: When a purchase order is over expensed and an associated voucher has been deleted, then the rollover process sets the PO distribution status to Complete.

Related Links

[Understanding the Purchase Order Business Process](#)

PO Rollover View Page

Use the PO Rollover View page (RUN_POROLLVW) to create a data set for retrieval by the purchase order rollover workbench by initiating the Rollover View (PO_POROLLVW) Application Engine process.

Navigation:

Purchasing > Purchase Orders > Budget Year End Processing > Request PO Roll View > PO Rollover View

This example illustrates the fields and controls on the Request PO Roll View (1 of 2). You can find definitions for the fields and controls later on this page.

This example illustrates the fields and controls on the Request PO Roll View (2 of 2). You can find definitions for the fields and controls later on this page.

Note: It is recommended that you create data sets that are no greater than 1000 rows. Any larger and the processing times on the purchase order rollover workbench can be substantial.

The PO Rollover View page enables you to limit the information contained in a data set. You use the page to define selection criteria for the PO_POROLLVW process. Along with limiting basic information, such as a business unit, a buyer, or a purchase order, you can limit the data set to ChartField values. For example, you can limit the data set to a specific ChartField or a range of ChartFields.

In addition, you can limit information in data sets using logic operands against a ChartField. These operands include, for example, *Begins with*, *Equal*, and *Less than*. So if you want to include ChartFields for a specific fund affiliate, you would use the *In* operand. The system displays a **General Ledger Business Unit** field that you use to select a fund affiliate to include in the data set.

Note: The qualifier “Is not empty” is added for the following fields: GL Business Unit, Account, Alternate Account, Department, Operating Unit, Product, Fund, Class, Program, Budget Reference and Affiliate, PC Business Unit, Project, Activity, Resource type, Category and Sub Category. Selecting “is not empty” hides the adjacent text box.

The applicable qualifiers added for the ‘Budget date’ fields

=	Should fetch those purchase order distributions whose budget date is matching with this date
<>	Should fetch those purchase order distributions whose budget date doesn't match with this date
<	Should fetch those purchase order distributions whose budget date is less than this date
<=	Should fetch those purchase order distributions whose budget date is less or equal to this date
>	Should fetch those purchase order distributions whose budget date is greater than this date
>=	Should fetch those purchase order distributions whose budget date is greater than or equal to this date
BETWEEN	Should fetch those purchase order distributions whose budget date is in between the from and the to date mentioned here. When this qualifier is chosen, 2 edit boxes should be opened to enable a range of date to be entered

Field or Control	Description
Search ID	<p>Enter a search ID for this data set. The search ID is used to retrieve the data set on the PO Rollover page.</p> <hr/> <p>Note: If the search ID is reused for different search criteria, the previously selected data will be overwritten. PeopleSoft recommends a unique search ID for each different set of search criteria.</p> <hr/>

Roll Status

The following rules apply to purchase order selection:

When you select *Rolled* and *None* and a purchase order has both statuses, the line becomes available for selection. All distributions with these statuses appear with the appropriate roll error on the **More Details** tab on the Purchase Order Details page. The rolled distributions are not included in the rollover processes:

- When you select *None* and a purchase order has distributions that have previously been rolled, only the distributions that have not been rolled appear. The lines are available for selection on the PO Rollover page.
- When you select *Rolled*, any rolled distributions appear on the PO Rollover page, but they are not available for selection there.
- Once you select a purchase order and it is in *Pending* or *Mid Roll* status, it does not appear again unless you select those specific statuses. You cannot select lines that are in *Mid Roll* status on the PO Rollover page.

Important! When you select and stage a line for rolling, it is removed from staging if it reappears on the PO Rollover page, is available for selection, and is not selected for staging again. Therefore, successive applications of the filters on this page should be more restrictive.

Field or Control	Description
None	Select this check box to find purchase orders that have no other roll status, because they have not yet been selected for rolling, or they have been selected and then removed from the selection process.
Pending	Select this check box to find purchase orders that have been selected for rolling.
Mid Roll	Select this check box to find purchase orders on which you have run the PO Rollover1 process. Purchase orders with this header status are protected from all actions except budget checking and rollover. Purchase orders with this status cannot be copied into vouchers.
Rolled	Select this check box to find purchase orders that have been rolled.
Disqualified	Select this check box to find purchase orders that have been identified during the PO Rollover1 process as being in error and, therefore, are not eligible to continue the Rollover process. When you want to include disqualified purchase orders, the program does not delete them from the processing results. Selecting this check box is useful for customers who want to see the documents that may require additional work before the year-end roll.

<i>Field or Control</i>	<i>Description</i>
Hold from Rollover	Select to hold the selected purchase orders from rolling over when you know that there is additional work to be done on the order. For purchase orders to be eligible to set to Hold from Rollover, they should be in a roll status of None or Pending. When purchase orders are in a Hold status they are not qualified for PO Rollover 1 (PO_POROLL1) or PO Rollover 2 (PO_POROLL2) rollover processing.

Exception Report

Use this grid box to indicate that you want to run the PO Rollover Exceptions report and to define the sort method for the report.

<i>Field or Control</i>	<i>Description</i>
Run Exception Report	Select to also run the PO Roll Exceptions report when you run the PO Roll View process. Exception types are made up of the rollover error and information associated with the error. For each rollover error type, the report displays the error title and information. Examples of exception types include "Invalid budget status on PO" and "Invalid budget status on PO and voucher."
Exception Type	Select to sort the PO Rollover Exceptions report by exception type. The system sorts the report first by Search ID and business unit, then by exception type, and finally by purchase order keys.
Purchase Order	Select to sort the PO Rollover Exceptions report by purchase order ID. The system first sorts the report by Search ID and business unit, then by purchase order ID, and finally by exception type.

Other Information

<i>Field or Control</i>	<i>Description</i>
Run	Click this button to initiate the PO_POROLLVW process that creates the data set that you can select on the PO Rollover page.

Related Links

[PO Rollover \(purchase order rollover\) Page](#)

[PO Rollover1 Page](#)

[PO Rollover2 Page](#)

“Understanding PeopleSoft ChartFields” (Application Fundamentals)

PO Rollover (purchase order rollover) Page

Use the PO Rollover (purchase order rollover) page (PO_ROLLOVER) to select purchase orders to rollover and change their status to Pending before running the PO Rollover1 process.

Check the roll status of purchase orders.

Navigation:

Purchasing > Purchase Orders > Budget Year End Processing > PO Rollover Workbench > PO Rollover

Purchase orders that have been received or partially received, but not yet vouchered are available for selection for purchase order rollover processing on the PO Rollover page. To retain the relationship between the purchase order and the receipt, the PO Rollover2 process updates the purchase order distribution number on the receipt distribution to match the new purchase order distribution number.

However, if there is one receipt for the purchase order that has been partially vouchered, the PO Rollover page is unable to maintain the relationship between the associated documents. Therefore, the purchase order is not available for selection for purchase order rollover processing. The **Roll Status** field is set to *Part Vchrd* (partially vouchered) and the **Roll Error** field on the Purchase Order Details page is set to *One receipt partially vchrd* (one receipt partially vouchered). A receipt is considered partially vouchered if the sum (quantity or amount) of all associated vouchers is less than the amount or quantity on the single receipt.

Purchase orders that you selected on the PO Rollover View page appear if they qualify for rollover. Purchase orders that are canceled, fully vouchered, on hold, in process, or that have not been successfully budget checked do not qualify for rollover and do not appear on this page.

Distribution lines do not appear if they are canceled, closed, or fully liquidated (that is, if the commitment control close flag is set to Y), because they are not qualified for rollover.

Important! Once you select a line for rolling and set the status to *Pending*, use the PO Rollover page to reselect it if it appears again on this page and is available for selection. Otherwise, the system removes the line from staging.

Field or Control	Description
Business Unit and Search ID	Select the search criteria then click the Search button. If you select only a business unit, then multiple search IDs will display. If multiple search IDs contain the same purchase order number then that purchase order will display multiple times on the page. If you select a business unit and a search ID, then only the data from the specific search ID will display on the page.

Field or Control	Description
Run Roll Exception	Click to access the Run Roll Exception page where you can define report values for the PO Roll Exception report. This report provides a list of purchase orders that are not qualified for the rollover. The system uses a combination of the user ID and business unit to determine the run control ID for the report, and you can define the business unit and search ID for the report.
Finalize Requisition	<p>When running the PO Rollover1 process, you can choose to finalize requisitions associated with the purchase orders selected for the process.</p> <p>To help you prepare for requisition finalization, this field provides the finalization qualification status of the requisition associated with the purchase order that you selected for purchase order rollover processing. Values are:</p> <p><i>Not Qualified:</i> Requisition is not qualified for finalization.</p> <p><i>No Requisition:</i> There is no requisition associated with the selected purchase order.</p> <p><i>Qualified:</i> The associated requisition qualifies for finalization. A requisition qualifies for finalization when all purchase orders with the same requisition key fields have reached a budget check status of <i>Valid</i>.</p> <p><i>Not Applicable:</i> The distribution has an associated requisition; however, it has already been rolled.</p> <hr/> <p>Note: Requisition finalization in conjunction with the PO Rollover1 process is not available when the Keep PY Encumbrances Open option is selected for the purchase order.</p> <hr/>
Roll Status	Displays the roll status for a purchase order. The roll status is the current state of a purchase order. When rolling over purchase orders, the system budget checks distribution lines against budgets with expiring budget periods and then roll funds over to new budget periods.
Outstanding PO Encumbrance	Displays the encumbrance balance when commitment control is installed. When you create a purchase order, commitment control liquidates the pre-encumbrance balance from the requisition and establishes an encumbrance for the purchase order. You can view budget details for the purchase order. Click the Encumbrance Balance link to access the PO Accounting Entries Inquiry where you can select a General Ledger business unit and commitment control ledger group to use as a budget inquiry.

Field or Control	Description
PY Encum Open (prior year encumbrances open)	Displays whether the prior year remaining encumbrance is open or closed. If <i>Y</i> appears in the field, the encumbrance is closed. If <i>N</i> appears in the field, the prior year remaining encumbrances for the purchase order is open. You can update the value by selecting the purchase order and clicking the PY Encum Open or the PY Encum Close button.
	Click the Secondary Lines button for any row to access the Purchase Order Details page. Use the Purchase Order Details page to view additional details for the purchase order.
PY Encum Open (prior year encumbrances open)	<p>Click to keep the prior year remaining encumbrances open for the selected purchase orders. When you click the button, the system displays a <i>Y</i> in the PY Encum Open field in the Budget Year End Details grid.</p> <hr/> <p>Warning! If you select this option, remaining purchase order encumbrances for the prior year are not liquidated, and cannot be liquidated going forward. If you select this option, you can perform purchase order rollover in one step using the PO Roll Open Encum process. Purchase order rollover processing can be completed in one step, because budget checking is not required for the prior year's encumbrances before the creation of the distributions for the new budget period.</p>
PY Encum Close (prior year encumbrances close)	Click to close the prior year remaining encumbrances for the selected purchase orders. When you click the button, the system displays a <i>N</i> in the PY Encum Open field in the Budget Year End Details grid. If you used the PY Encum Open button to check selected lines, you can undo the selection using this button.
Hold From Rollover	Click to hold the selected purchase orders from rolling over. Purchase orders eligible to be set to Hold from Rollover should be have a roll status of None or Pending. After you click the button, the system places the selected purchase orders in a Hold status. The system saves your updates when you click Save . When purchase orders are in a Hold status they are not qualified for PO Rollover 1 or PO Rollover 2 rollover processing.
Release Hold	Click to release the selected purchase orders from Hold status. After you click the button, the system places the select purchase orders in a None status and they will become eligible for future rollover processes. Only purchase orders with a Hold status are updated when you click Save . When in a None status, and a purchase order has distributions that have previously been rolled, only the distributions that have not been rolled appear for the purchase order details. The lines are available for selection on the PO Rollover page.

Field or Control	Description
Save	<p>Select the purchase orders for the rollover processes and then click the Save button. After you click the Save button the system changes the roll status of those purchase order to <i>Pending</i>.</p> <hr/> <p>Important! If a purchase order is in multiple data sets and it has been set to a roll status of Pending from a specific search ID, the status will not display as Pending when you retrieve the other data sets. You will need to recreate the data sets by re-executing PO_POROLLVW to display any updates to the statuses.</p> <hr/>

Purchase Order Details Page

Use the Purchase Order Details page (PO_ROLLOVER_LN) to view additional details for purchase orders listed on the PO Rollover page.

Navigation:

Click the **Secondary Lines** button for any row on the PO Rollover page.

More Details Tab

Select the **More Details** tab.

Field or Control	Description
POs to Budg Chk for Finalizing (purchase orders to budget check for finalizing)	<p>Select to access the POs Not Budget Checked page, where you can view details about purchase orders that have not yet reached a budget check status of <i>Valid</i>.</p> <p>Bringing the budget check status of these purchase orders to <i>Valid</i> enables the associated requisition to be finalized by the PO Rollover1 process.</p>

Field or Control	Description
Roll Error	<p>Rollover error code. Values are:</p> <p><i>IPO</i>: Invalid budget status (purchase order).</p> <p><i>IVC</i>: Invalid budget status (voucher).</p> <p><i>N</i>: No error.</p> <p><i>PV</i>: Invalid budget status (purchase order and voucher).</p> <p><i>PVR</i>: Invalid budget status. Purchase order and voucher items received.</p> <p><i>R</i>: Rolled.</p> <p><i>REC</i>: Items received but not vouchered.</p> <p><i>VR</i>: Invalid budget status; voucher and items received.</p>

PO Rollover1 Page

Use the PO Rollover1 page (RUN_POROLL1) to run the PO Rollover1 process.

Navigation:

Purchasing > Purchase Orders > Budget Year End Processing > Request PO Rollover1 > PO Rollover1

The PO Rollover1 process adjusts amounts and quantities on current distributions to enable the budget processor to liquidate the selected purchase orders. The process then creates new distribution lines with the rolled amounts and quantities. The new distribution lines are held in a staging table until you run the PO Rollover2 process. It also returns outstanding amounts and quantities to the corresponding requisition and modifies various flags and statuses in the PO_HDR, PO_LINE_DISTRIB, and PO_LINE_DIST_NP tables in preparation for the Commitment Control Budget Processor process.

Note: You must budget check the purchase orders after you run the PO Rollover1 process and before you continue to the PO Rollover2 process.

Note: The PO Rollover1 process acts only on purchase orders when the **Keep PY Encumbrances Open** check box is clear on the PO Rollover page.

Field or Control	Description
Finalize Requisitions	<p>Select to finalize qualified requisitions associated with the purchase orders selected for processing by the PO Rollover1 process. A requisition qualifies for finalization when all purchase orders containing the requisition key fields have reached a budget check status of <i>Valid</i>.</p> <p>If this option is selected and a processed requisition does not qualify for finalization, remaining quantities and amounts are returned to the requisition.</p>
Run Exception Report	<p>Click to access the Run Roll Exception page where you can define report values for the PO Roll Exception report. This report provides a list of purchase orders that are not qualified for the rollover. The system uses the run control ID from the PO Rollover1 page to assign the run control ID for the report.</p>

Related Links

[Commitment Control Budget Processor Process in PeopleSoft Purchasing](#)

PO Rollover2 Page

Use the PO Rollover2 page (RUN_POROLL2) to run the PO Rollover2 process.

Navigation:

Purchasing > Purchase Orders > Budget Year End Processing > Request PO Rollover2 > PO Rollover2

The PO Rollover2 process breaks the relationship between the rolled purchase order and the prior year's transactions in the commitment control tables and to close all distributions not rolled.

The PO Rollover2 process updates the KK_ROLLED field in the KK_SOURCE_HDR commitment control table to *Y* for all rolled purchase orders. This update to KK_ROLLED prevents the budget processor from processing and modifying the existing transaction. Instead, the budget processor assigns the purchase order a new transaction ID the next time the rolled purchase order is budget checked. The budget processor bypasses distributions created in prior budget periods.

Once the budget check process is complete, you must run the PO Rollover2 process. The run control page provides the option to complete the rollover process by business unit or by individual purchase orders.

The process closes or cancels the old distribution lines by setting the **DISTRIB_LN_STATUS** field to *C* (completed) or *X* (canceled). Select *X* only if the entire amount of the distribution was rolled over. The data held in the staging tables is then inserted into the PO_LINE_DISTRIB and PO_LINE_DIST_NP tables.

Note: You must budget check after running the PO Rollover1 process and before continuing to the PO Rollover2 process.

Note: The new distributions must be budget checked.

Related Links

[Commitment Control Budget Processor Process in PeopleSoft Purchasing](#)

Roll Open Encum (roll open encumbrance) Page

Use the Roll Open Encum (roll open encumbrance) page (RUN_POROLLO) to run the PO Roll Open Encum process.

Navigation:

Purchasing > Purchase Orders > Budget Year End Processing > Request PO Roll Open Encum

Note: The process acts only on purchase orders when the **Keep PY Encumbrances Open** option is selected on the PO Rollover page.

The PO Roll Open Encum process combines PO Rollover1 and PO Rollover2 processing, along with functionality that keeps rolled remaining encumbrances open in the prior budget year. The process makes changes to the rolled distributions that prevent the budget processor from re-validating and liquidating them in the prior budget year. This functionality enables you to track unexpended amounts by individual purchase orders during a budget period without returning unexpended amounts to the budget.

In one step, the process adjusts amounts and quantities down to what has been vouchered on the distribution and creates new distributions for unvouchered amounts. These actions can be completed in one step, because budget checking rolled distributions in the prior budget year is not required, as the intent of the process is to prevent the liquidation of the remaining encumbrances.

Because budget checking of rolled distributions in the prior budget year is not performed when using this process, finalizing associated requisitions is not an option.

Run the budget processor after the PO Roll Open Encum process to budget check newly created distributions and to create their encumbrances in the new budget period.

<i>Field or Control</i>	<i>Description</i>
From Date/To Date	Enter the range of budget dates assigned to purchase orders that you want to roll into a new budget date.
Budget Date	Enter the new budget date that you want to assign to purchase orders successfully rolled by the process.

Run Roll Exception Page

Use the Run Roll Exception page (RUN_ROLL_EXCEPTION) to run the Non Qualified PO Listing process.

Navigation:

Purchasing, Purchase Orders, Budget Year End Processing, Non Qualified PO Listing

Use this page to create the PO Rollover Exceptions report. The report displays the non-qualified purchase orders and their associated documents.

To populate the tables that produce the report, you need to run the PO Rollover View process to create a data set on which to run the report. The report is also available as an BI Publisher report.

You can also access the Run Roll Exception page using the PO Rollover View and PO Rollover 1 pages and by using the PO Rollover Workbench.

<i>Field or Control</i>	<i>Description</i>
Business Unit	Select a PeopleSoft Purchasing business unit to limit your report to non-qualified purchase orders within this one business unit.
Search ID	Select a search ID. A search ID is made up of a data set that you define on the PO Rollover View page. The system uses the data set to create the PO Rollover Exceptions report. The report contains the purchase orders that are not qualified for rolling over.
Exception Type	Select to sort the PO Rollover Exceptions report by exception type. Exception types are the kinds of errors that prevent purchase orders from rolling over. The system sorts the report first by purchase order ID and business unit, then by exception type, and finally by purchase order keys. An example of an exception type is when a budget status on the purchase order is not valid.
Purchase Order	Select to sort the PO Rollover Exceptions report by purchase order ID. The system first sorts the report by purchase order and business unit, then by purchase order ID, and finally by exception type.

Establishing Purchasing ChartField Security

To facilitate ChartField Security functionality, Oracle delivers PeopleSoft Purchasing with components that are already set up for use with ChartField security. You can deactivate the settings, modify the settings, or add security for components. ChartFields are the fields that store charts of accounts and provide the system with the basic structure to segregate and categorize transactional and budget data. PeopleSoft Purchasing enables you to secure specific accounts to prevent unauthorized users from viewing or editing financial information. The ChartField Security feature provides the framework for you to define the ChartField security method and configure and maintain security for specific PeopleSoft Purchasing ChartField fields and records. You can define the security method based on users, roles, and permission lists.

Customers can assign a group of users, roles, or permission lists to a rule in one page using a default effective date. The rule applies to all products. Customers can assign many rules to a user, role, or permission list in one page. Different rules can be assigned to different products for one user.

Chartfields are secured at the distribution level on the purchase order and requisition entry transactions. Values for ChartFields on the Purchase Order Defaults page for the purchase order header are not secured. When you create a transaction, the distribution values may default onto the transaction. When you save

the transaction, the ChartField security will validate to ensure that the user can create and maintain documents using those secured ChartField values.

By default, most components in PeopleSoft Purchasing are secured when the product itself is enabled. You can activate or inactivate ChartField security for certain Purchasing components that include transactions, such as data entry for purchase orders and requisitions, search lists, inquiries, and prompts.

The core system for establishing ChartField security is described in the PeopleSoft Application Fundamentals 9.2. Also, the book provides descriptions of the Purchasing components and pages affected by ChartField security.

See “Securing ChartFields for PeopleSoft Purchasing” (Application Fundamentals).

Chapter 10

Running Document Tolerances

Understanding Document Tolerances

Document tolerance checking compares the balance of all subsequent documents distributions tied to the requisition distribution based on a tolerance tied to a specific ChartField. The fund code ChartField is usually the one used in the document tolerance checking process. For example, a 100 USD requisition distribution has a fund code 100 which has a 10 percent tolerance. If two purchase orders were entered against this requisitions distribution, one for 50 USD and a second for 75 USD, the first purchase order would pass document tolerance checking but the second purchase order would fail. In this case, the total against the requisitions distribution would be 125 USD exceeding the 10 percent tolerance. If you have the proper authorization, you can override the document tolerance checking and continue processing the purchase order.

You can run the Document Tolerance process either with or without enabling commitment control.

If you enable commitment control and document tolerance for the business unit, and you then initiate budget checking, the system runs the Document Tolerance Checking Application Engine process (FS_DOC_TOL) first and then it runs the Comm Cntrl Budget Processor Application Engine process (FS_BP).

If any amounts, quantities, general ledger business units, or ChartFields are modified on a purchase order after the document tolerance is checked, either manually or using the POCREATE or POCHNG processes, the system resets the document tolerance status to *Not Chk'd* (not checked).

Setting Up Document Tolerances

The setup for document tolerances is the same for both PeopleSoft Payables and PeopleSoft Purchasing.

See “Defining Document Tolerances” (PeopleSoft Source to Settle Common Information).

Running Document Tolerances With Budget Checking

If you enable commitment control and document tolerance for the business unit, you run document tolerance by initiating the Comm Cntrl Budget Processor Application Engine process (FS_BP) on the Maintain Purchase Order - Purchase Order page. The system runs the Document Tolerance Checking process and then the Comm Cntrl Budget Processor process.

You can check a purchase order document tolerance status on the Maintain Purchase Order - Purchase Order page.

This section discusses how to check document tolerances.

Page Used to Run Document Tolerances With Budget Checking

<i>Page Name</i>	<i>Definition Name</i>	<i>Usage</i>
<u>Maintain Purchase Order - Purchase Order Page</u>	PO_LINE	Enter or change purchase order information online.

Maintain Purchase Order - Purchase Order Page

Use the Maintain Purchase Order - Purchase Order page (PO_LINE) to enter or change purchase order information online.

Navigation:

Purchasing > Purchase Orders > Add/Update POs > Maintain Purchase Order - Purchase Order page

<i>Field or Control</i>	<i>Description</i>
	<p>Click the Budget Check button to run the Comm Cntrl Budget Processor process for this purchase order. This button appears only if you have enabled commitment control for PeopleSoft Purchasing and the purchase order has not been subjected to budget checking. This button is not available if you have run the Comm Cntrl Budget Processor process on the purchase order.</p> <p>If you enable commitment control and document tolerance checking for the business unit and you initiate the budget checking process, the system runs the Document Tolerance process then the Comm Cntrl Budget Processor process.</p> <hr/> <p>Note: You would normally run the Comm Cntrl Budget Processor process as a batch process using the Budget Check Request page. If you do so and document tolerance checking is enabled for the business unit, you must ensure that the commitment control source transaction definitions for purchase order transactions are defined, so that only purchase orders that have passed document tolerance checking are eligible for budget checking.</p> <hr/>

Field or Control	Description
Doc Tol Status (document tolerance status)	<p>If you enable document tolerance checking, the system displays the document tolerance status. Values are:</p> <p><i>Valid</i>: The purchase order has passed document tolerance checking.</p> <p><i>Not Chk'd</i> (not checked): The purchase order requires document tolerance checking. If any amounts, quantities, or ChartFields are modified after the document tolerance is checked, the system resets the document tolerance status to <i>Not Chk'd</i>.</p> <p><i>Error</i>: Exceptions are generated for the purchase order during document tolerance checking. You can override document tolerance exceptions on the Document Tolerance Exceptions - Doc To Exception page.</p>

Running Document Tolerances Without Budget Checking

If you do not enable commitment control but enable document tolerance, you initiate document tolerance checking using the Document Tolerance Request page.

This section lists the page used to run document tolerances without budget checking.

Page Used to Run Document Tolerances Without Budget Checking

Page Name	Definition Name	Usage
Document Tolerance Page	DOC_TOL_RUN_CNTRL	Initiate the Document Tolerance Checking process. The system checks the transaction for document tolerance exceptions.

Reviewing Document Tolerance Exceptions and Overrides

This section discusses how to Review Document Tolerance Exceptions and Overrides

Pages Used to Review Document Tolerance Exceptions and Overrides

Page Name	Definition Name	Usage
<u>Document Tolerance Exceptions - Doc Tol Exception Page</u>	DOC_TOL_EXCPT	View and update document tolerance exceptions.

<i>Page Name</i>	<i>Definition Name</i>	<i>Usage</i>
Document Tolerance Override - Override Log Page	DOC_TOL_OVR_LOG	View and update document tolerance exceptions.

Document Tolerance Exceptions - Doc Tol Exception Page

Use the Document Tolerance Exceptions - Doc Tol Exception page (DOC_TOL_EXCPT) to view and update document tolerance exceptions.

Navigation:

Purchasing > Purchase Orders > Review PO Information > Document Tolerance Exceptions > Doc Tol Exception

Exceptions

<i>Field or Control</i>	<i>Description</i>
Rule ID	Displays the rule ID and description of the match rule that produced the exception.

Details

<i>Field or Control</i>	<i>Description</i>
Pred Doc Amt (predecessor document amount)	Displays the amount of the predecessor document (purchase order).
Life-to-Date Liquidated Amt (life-to-date liquidated amount)	Displays the sum total of all source documents (purchase orders) linked to the predecessor document. If you have multiple purchase orders tied to the same requisition, the Document Tolerance process calculates the tolerance against the sum total of all of the purchase orders tied to this requisition rather than the amounts of the individual purchase orders. An individual purchase order may be within the tolerance, but if the sum total of the linked purchase orders exceeds the tolerance, the purchase order will not pass document tolerance checking.
Defined Tolerance Amount	The tolerance amount that you defined on the Document Tolerance page.

Field or Control	Description
Defined Tolerance Percentage	<p>Displays the tolerance percent that you defined on the Document Tolerance page.</p> <hr/> <p>Note: The system uses whichever value is lower (either the defined amount or the defined percentage) to calculate the tolerance. If the amount of the source document exceeds the lower defined amount, the purchase order does not pass document tolerance checking and the system generates an exception.</p> <hr/>
Calculated Doc Amt Tol Amount (calculated document amount tolerance amount)	Displays the amount of the source document (purchase order), plus any defined tolerance amount.
Calculated Doc Tol Percent Amt (calculated document tolerance percent amount)	Displays the amount of the source document (purchase order), plus any defined tolerance percentage amount.
Source Doc Monetary Amt (source document monetary amount)	Displays the amount of the source document (purchase order).
Source Doc Converted Amt (source document converted amount)	Displays the converted amount of the source document (purchase order). The system converts the source document to the predecessor document general ledger business unit base currency to calculate the tolerance.
Predecessor GL Base Currency	Displays the predecessor document general ledger business unit base currency.
Transaction Currency	Displays the currency of the source document (purchase order).
Override	Select to override this exception and make the transaction available for further processing.

Document Tolerance Override - Override Log Page

Use the Document Tolerance Override - Override Log page (DOC_TOL_OVR_LOG) to view and update document tolerance exceptions.

Navigation:

Purchasing > Purchase Orders > Review PO Information > Doc Tolerance Override History > Override Log

The fields on this page are the same as the fields on the Document Tolerance Exceptions - Doc Tol Exception page except for **User ID** and **DateTime**, which provide an audit trail of exceptions that have been overridden.

<i>Field or Control</i>	<i>Description</i>
User ID	Displays the user who overrode this exception on the Document Tolerance Exceptions - Doc Tol Exception page.
DateTime	Displays the date and time that the designated user overrode this exception on the Document Tolerance Exceptions - Doc Tol Exception page.

Using Entry Events

Understanding Entry Events in PeopleSoft Purchasing

Entry events are shorthand codes that are assigned to a transaction's distribution lines and enable you to post accounting entries to the general journal with minimal end-user input. Entry events post standard and supplemental accounting entries to the general ledger. These are based on accounting lines generated during budget checking or document posting.

Entry events are used to satisfy federal accounting requirements. PeopleSoft Purchasing is delivered with a set of entry event codes, and you can define additional entry event codes if necessary.

Entry events are enabled using the Installation Options component.

- If you choose not to enable entry events, the **Entry Event** field does not appear on the pages.
- If the use of entry events is optional, any default value set at the business unit level appears but can be overridden.
- If the use of entry events is required, the **Entry Event** field appears, business unit defaulting occurs, and an error appears if the field is left blank when you save the page.

You can override the default value but cannot leave the field blank.

PeopleSoft uses a common function to process entry events for PeopleSoft General Ledger, PeopleSoft Payables, PeopleSoft Purchasing, PeopleSoft Receivables, and PeopleSoft Billing.

Note: For requisitions and purchase orders, you must use commitment control to generate entry event transactions.

The processor is accessed through run control components for requisitions, purchase orders, and receipts.

The event entries that you generate can be viewed using the accounting line entries components. Drillback into the general ledger is provided through EE Journal Entries inquiries.

PeopleSoft Purchasing supports entry events in these areas:

- Requisitions
 - If there is a default entry event code for the PeopleSoft Purchasing business unit, then this default automatically populates on the header defaults, line defaults, and the distribution line levels. Users can override the business unit default value at any of these levels.
 - Entry event codes are defined by account codes, and the appropriate account code automatically populates whenever an entry event code is used and no other account code already exists.
- Requisition loader

When you run the Requisition Loader process, entry events found in the requisition loader defaults override entry event defaults found at the business unit level or on the Requisition Loader page.

- Purchase order
 - If you select entry event defaults at the business unit level, they appear by default to the header and distribution levels, where the user can override them.
 - If the **Account** field is blank, the default account for that particular entry event appears. If the **Account** field is not blank, it is not overridden by the account tied to the entry event.

- Maintain distribution

Users can also enter an entry event directly on the Maintain Purchase Order - Distributions for Schedule page.

- Purchase order express

Entry events function on the Express Purchase Order - Purchase order page in the same manner as on the Maintain Purchase Order - Purchase Order and Maintain Purchase Order - Schedules pages.

- Procurement cards

Any applicable entry event default value appears on the Procurement Card Limits and Restrictions page, and on the Account Distribution page. This entry event is carried over to PeopleSoft Payables through the Voucher Stage process.

- Receipt accrual

The user has the option of using the default value or overriding it on the Receipt Accrual page. If the user selects override, the entry event specified always overrides any default value.

- AutoSelect process

The Auto Select process enables you to source the organization requisitions automatically. The process also passes the entry event from the requisition to the staging area.

- Build Inventory Demand process

If the Build Inventory Demand process results in the creation of a purchase order, the entry event is passed to the staging area.

- PO Calculations and Create Purchase Orders processes

The purchasing system uses the PO Calculation and Create Purchase Orders processes to source requisitions to purchase orders. They also pass the entry event from the requisition to the purchase order. The Create Purchase Orders process validates the entry event code from the requisition. If that entry event code is not valid for the purchase order, the Create Purchase Orders process overrides the value with the entry event code defined at the business unit level for purchase orders.

The Entry Event Generator process (FS_EVENTGEN) processes entry events for all PeopleSoft products that use entry events, which include PeopleSoft General Ledger, PeopleSoft Payables, PeopleSoft Purchasing, PeopleSoft Receivables, and PeopleSoft Billing.

PeopleSoft Purchasing users access the process through components specific to requisitions, purchase orders, and receipts. The process uses setup data to create additional accounting transactions in a separate accounting record.

This diagram shows the entry event process flow:

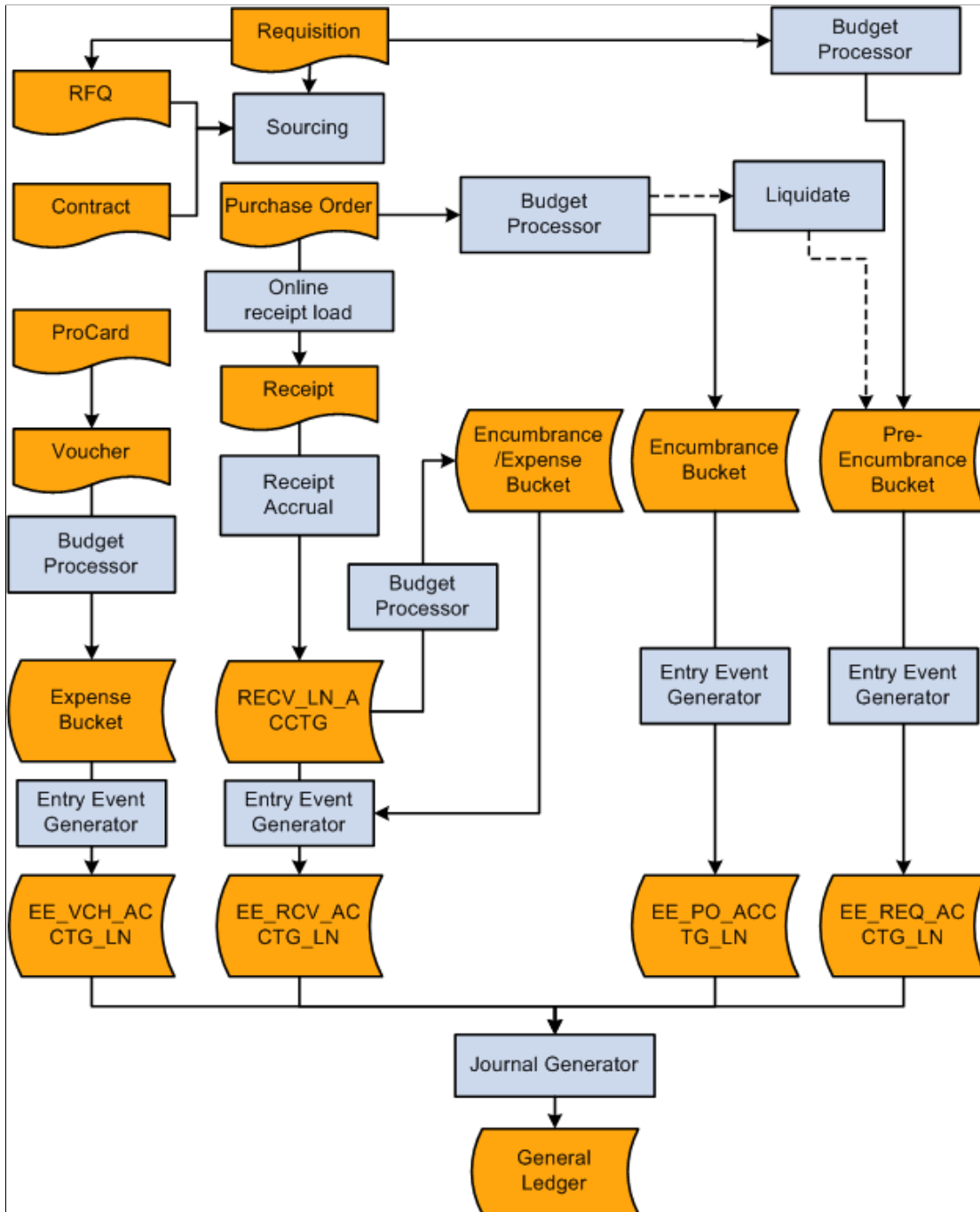

Related Links

[Entry Event Defaults Page](#)

[Maintain Purchase Order - Distributions for Schedule Page](#)

[Voucher Stage Page](#)

[Reviewing Purchase Order Accounting Line Entries](#)

[Reviewing Requisition Accounting Line Entries](#)

[Automatically Selecting Requisitions for Sourcing](#)

[Building Inventory Demand Transactions](#)

[Creating Purchase Orders Using the Create Purchase Orders Process](#)

[Running the PO Calculations Process](#)

[Understanding Receipt Accrual](#)

[Viewing Receipt Accrual Accounting Line Entries](#)

[Requisition Loader Request Page](#)

[Understanding Entry Events in PeopleSoft Purchasing](#)

“Using Requisition Loader Defaults and Overrides” (PeopleSoft Source to Settle Common Information)

Setting Up PeopleSoft Purchasing Entry Events

This section discusses how to Set Up PeopleSoft Purchasing Entry Events.

Pages Used to Set Up PeopleSoft Purchasing Entry Events

<i>Page Name</i>	<i>Definition Name</i>	<i>Usage</i>
Ledgers for a Unit - Definition Page	BUSINESS_UNIT_LED1	Select the general ledger detail ledger group for which you want to enable commitment control.
Ledgers for a Unit - Commitment Control Options Page	BUSINESS_UNIT_LED5	Enable commitment control for a business unit and general ledger detail ledger group.
Entry Event Page	INSTALLATION_EE	Select purchasing entry events for purchase orders, requisitions, and procurement cards.
Entry Event Defaults Page	BUS_UNIT_PM_EE	Select default entry events at the business unit level. The link does not appear unless entry events are enabled.

Related Links

[Understanding Entry Events in PeopleSoft Purchasing](#)

Entry Event Page

Use the Entry Event page (INSTALLATION_EE) to select purchasing entry events for purchase orders, requisitions, and procurement cards.

Navigation:

Set Up Financials/Supply Chain > Install > Installation Options

Click the **Entry Event** link in the General Options group box.

Field or Control	Description
Purchasing	Select the entry event option for PeopleSoft Purchasing. Values are: <ul style="list-style-type: none"> • <i>No EE</i> (no entry event): Entry events cannot be used. Entry event fields will be hidden. • <i>Optional</i>: Entry events can be used but are not required. Entry event fields appear. Default entry event codes appear. • <i>Required</i>: You must use entry events. If the Entry Event field appears on a page, you must select a value or an error appears when you save the page.

Entry Event Defaults Page

Use the Entry Event Defaults page (BUS_UNIT_PM_EE) to select default entry events at the business unit level.

Navigation:

Setup Financials/Supply Chain > Business Unit Related > Purchasing > Purchasing Definition

Click the **Entry Event Defaults** link on the Purchasing Definition - Business Unit Definition page.

Select from the available options to choose default entry event codes for purchase orders, requisitions, and procurement cards. Before selecting a default, you may need to review the defined codes.

Related Links

[Setting Up PeopleSoft Purchasing Entry Events](#)

Generating PeopleSoft Purchasing Entry Events

This section discusses how to generate PeopleSoft Purchasing entry events.

Note: PeopleSoft Purchasing enables you to access the Entry Event component on three menus: Requisitions, Purchase Orders, and Receipts.

Page Used to Generate PeopleSoft Purchasing Entry Events

Page Name	Definition Name	Usage
<u>Entry Event Run Request Page</u>	PST_EE_RUN_REQUEST	Run the Entry Event Generator Application Engine process (FS_EVENTGEN) or (FS_EE_DR)
<u>Entry Event Log Inquiry Page</u>	FS_EVENTGEN_LOG	Verify the documents processed/error during the batch process

Entry Event Run Request Page

Use the Entry Event Run Request page (PST_EE_RUN_REQUEST) to run the Entry Event Generator Application Engine process (FS_EVENTGEN) or (FS_EE_DR) to create EE entries.

Navigation:

- **Purchasing > Requisitions > Entry Event Request Req**
- **Purchasing > Purchase Orders > Entry Event Request PO**
- **Purchasing > Receipts > Entry Event Request Rcpt**

Note: Budget checking must be run before entry events are generated for purchase orders or requisitions.

Process Request Parameters

Field or Control	Description
Request ID	Enter an identifier for the request.
Description	Enter a description of the request.
Entry Event Process	<p>Select the process for which you want to generate entries. This field is required. The entry event generator determines whether each selected document is eligible for the process, based on the entry event code assigned to the document.</p> <p>Values are:</p> <p><i>PO Purchase Order</i> (PO Purchase Order posting)</p> <p><i>Requisition Posting</i></p> <p><i>Receipt Accrual</i></p>

Field or Control	Description
Process Option	<p>Select the process options based on the entry event process that you selected. Values are:</p> <p><i>All Units:</i> All business units.</p> <p><i>Document:</i> A document that you select in the Selection Criteria group box.</p> <p><i>Unit:</i> A business unit you select in the Selection Criteria group box.</p>

Selection Criteria

You can use these fields to limit the process to one business unit or one document. The documents available for the **Document** field depend on the selection in the **Entry Event Process** field.

Entry Event Log Inquiry Page

Use the Entry Event Log Inquiry page (FS_EVENTGEN_LOG) to verify the documents processed/error during the batch process.

Navigation:

Purchasing > Purchase orders > Review PO Information > Review PO EE Process Status

This example illustrates the fields and controls on the Entry Event Log Inquiry Page. You can find definitions for the fields and controls later on this page.

The screenshot shows the 'Inquiry' page interface. At the top, there is a 'Search Criteria' section with input fields for 'Business Unit' (containing 'US001') and 'Document'. Below these are fields for 'Request Date', 'Process Instance', and 'Run Status'. There are 'Clear' and 'Search' buttons. Below the search criteria is the 'Entry Event Process Inquiry Search' table. The table has columns for 'Business Unit', 'Document', 'Request Date', 'Process Instance', and 'Run Status'. It displays five rows of data, with the fourth row indicating a 'Processed with Error' status.

Business Unit	Document	Request Date	Process Instance	Run Status
1 US001	0000000050	08/19/2014		25562 Processed
2 US001	0000000253	08/19/2014		25562 Processed
3 US001	0000000254	08/19/2014		25562 Processed
4 US001	0000000255	08/19/2014		25562 Processed with Error
5 US001	0000000256	08/19/2014		25562 Processed

Drilling Down to the General Ledger to View Entry Event Journal Entries

This section lists the pages used to drill down to the general ledger system to view entry event journal entries.

Pages Used to Drill Down to the General Ledger to View Entry Event Journal Entries

<i>Page Name</i>	<i>Definition Name</i>	<i>Usage</i>
PO Purchase Order Drillback Page (purchase order purchase order drillback)	EE_PO_DRILL	Drill down to the general ledger and view entry event journals for the purchase orders.
PO Requisition Drillback Page	EE_REQ_DRILL	Drill down to the general ledger and view entry event journals for the requisitions.
PO Receipt Accrual Drillback Page	EE_RCV_DRILL	Drill down to the general ledger and view entry event journals for the receipts.

Creating Procurement Group Data

Understanding Procurement Groups in PeopleSoft

The Procurement Groups feature enables you to group purchasing items from a single or multiple transactions together such as consolidating items from multiple purchase order receipts into one asset for PeopleSoft Asset Management. Procurement Groups are not restricted to assets (in PeopleSoft Asset Management) and can be assigned to any PO transaction line item.

In PeopleSoft Asset Management, a large asset can come with many separate parts that need to be combined to create the large asset. Within PeopleSoft Purchasing, this large asset could have separate items and separate lines on a requisition, purchase order, or receipt. These parts may be bought from different suppliers causing more than one purchase order for the same large asset. For example, the total cost for an air conditioning unit may come in different parts such as the AC unit, air filters, installation brackets, and even the cost of the installation service. All of these costs should be part of the asset. The Procurement Groups feature enables you to track each item and its cost through requisitions, purchase orders, and receipts. Inquiry pages help you track the stage of each transaction so that you know when you have received the entire asset and are able to create the asset in PeopleSoft Asset Management with the entire cost captured.

The following fields are used on requisition, purchase order, or receipt transactions to identify transaction lines as part of a procurement group:

Field	Definition
Procurement Group ID field	<p>Select an existing Procurement Group ID for the item (search on partial or full values of the Procurement Group ID, Short Name or Description). When you select a Procurement Group ID, an edit enforces that the Receiving Required option is set. A save-time edit verifies that all items in the Procurement Group ID belong to the same Asset Management Business Unit value when the Allocate Purchasing Group to Assets option is selected on the Purchasing Options page. See Purchasing Options Page See also, Setting Up Procurement Groups</p> <p>At the time a Purchase Order is copied to create a new Purchase Order, the Procurement Group-related fields (Procurement Group ID, Primary Unit, Unit Allocation Quantity and Unit Allocation Amount fields) will be cleared on the new purchase order lines. At the time a Requisition line is copied to a Purchase Order, the Procurement Group-related field values found on the corresponding Requisition line populate the new Purchase Order line. When the Procurement Group ID is being copied from the Requisition to a PO, the Receiving Required field is selected for the PO line.</p>

Field	Definition
Primary Unit	Identifies whether the listed item is the primary unit (value = Y) within a given procurement group.
Unit Allocation Quantity	Identifies the quantity of the item to allocate per asset for the Procurement Group. This quantity is available for non-amount only transactions. It is utilized during receiving and asset integration.
Unit Allocation Amount	Identifies the amount of the item to allocate per asset for the Procurement Group. This amount is available for amount only transactions. It is utilized during receiving and asset integration.

The steps to activate and use the Procurement Groups feature in PeopleSoft Purchasing are:

1. To activate the Procurement Groups feature for a purchasing business unit, go to the Purchasing Options page and:
 - Select the Purchasing Group Option check box. If this check box is selected, then the Procurement Group ID, Primary Unit, Unit Allocation Quantity, and Unit Allocation Amount fields are displayed on the requisition, purchase order, and receipt transaction pages.
 - Select the Allocate Purchasing Group check box to enable functionality for procurement group information to be passed to PeopleSoft Asset Management to create an asset.
2. Use the Procurement Groups page to create a procurement group ID for each asset, or item grouping, that you want to create. For example, you might set up the procurement group ID, ACUnit_01 for the items making up an air conditioning unit.
3. When adding requisition lines, go to the Procurement Group ID, Primary Unit, Unit Allocation Quantity, and Unit Allocation Amount fields and populate the information. In PeopleSoft Purchasing, these procurement group fields are located within the Add/Update Requisitions component on the Maintain Requisitions- Requisition page and on the Maintain Requisitions- Details for Line page. In PeopleSoft eProcurement these procurement group fields are located in the Create Requisition component. In addition, the requisition pages have a link to the Procurement Groups page in case you need to add or update a procurement group ID. If this requisition line is sourced to a purchase order, then the procurement group information is placed on the purchase order line.
4. When adding purchase order lines online, go to the Procurement Group ID, Primary Unit, Unit Allocation Quantity, and Unit Allocation Amount fields and populate the information. These procurement group fields are located on the Add/Update POs and Add/Update Express POs components and the Details for Line page. In addition, the purchase order pages have a link to the Procurement Groups page in case you need to add or update a procurement group ID. If you copy this purchase order from another purchase order, the procurement group fields are not populated from the original purchase order. Procurement group information can be viewed on the Purchase Order Inquiry component in the Line Details section.
5. Once the purchase orders are dispatched to the suppliers and the items arrive at your organization, you can receive the items into PeopleSoft Purchasing or PeopleSoft eProcurement. In PeopleSoft

Purchasing, the procurement group fields (Procurement Group ID, Primary Unit, Unit Allocation Quantity, and Unit Allocation Amount fields) are displayed in the Maintain Receipts- Receiving page within the Source Information tab and on the Maintain Receipts - Receipt Line Details for Line page. In PeopleSoft eProcurement, the procurement group fields are displayed on the Receive page and the Line Details page.

6. The Procurement Group Inquiry page enables you to view the requisitions, purchase orders, receipts, and vouchers associated with a procurement group.
7. Once you have received the items, use the Receiver Interface Push process (PO_RECVPUSH) to move data to the PeopleSoft Asset Management interface table.

See Receipt Push Process [Processing Excise Duty and Sales Tax/VAT in the PO Receipt Push Process](#)

Example of Procurement Group Transactions

This example shows how to use a procurement group to create a new asset in PeopleSoft Asset Management and how the quantities are allocated. The items in this procurement group are:

- Commercial air conditioning units.
- Air conditioning brackets.
- Air conditioning filters.
- Installation services.

The supplier for the air conditioning units is different than the supplier for the brackets and filters .

The steps are:

1. Using the Procurement Groups page, a new procurement group ID named AC-ASSET is created.
2. A requisition is created with four lines. The AC-ASSET procurement group ID is assigned to each of the requisition lines with the following items:
 - (Primary unit) Four commercial air conditioning units with an allocation quantity of one.
 - Eight air conditioning brackets with an allocation quantity of two.
 - Four air conditioning filters with an allocation quantity of one.
 - An amount-only requisition line for 2,000 USD of installation services with an allocation amount of 500 USD.

Note: All four lines of the requisition have the same PeopleSoft Asset Management business unit and asset profile ID assigned at the distribution line level.

3. The requisition is approved.
4. The requisition is sourced to three separate purchase orders:
 - One purchase order for the supplier of the air conditioning units.

- One purchase order for the supplier of the brackets and filters.
 - One purchase order for the supplier of the installation services of the AC units.
5. The purchase orders are approved and dispatched.
 6. Two air conditioning units are received from the first purchase order and entered into the Maintain Receipts- Receiving page in PeopleSoft Purchasing.
 7. Five brackets and four filters are received from the second purchase order and entered into the Maintain Receipts- Receiving page in PeopleSoft Purchasing.
 8. 1,000 USD of installation services are performed by the service supplier and entered into the Maintain Receipts- Receiving page in PeopleSoft Purchasing.
 9. Receiver Interface Push process is run. The data is placed in the RECV_LN_ASSET table and the Asset Management Interface table (INTFC_PRE_AM) as follows:

Asset Interface Table (INTFC_PRE_AM)

Item Description	Procurement Group ID	Procurement Group Sequence	Primary Unit	Asset Qty	Asset Amount	Status
AC unit	AC-ASSET	0001	Y	1		Pending
Installation of AC	AC-ASSET	0001	N		\$500.00	Pending
AC Brackets	AC-ASSET	0001	N	2		Pending
AC Filters	AC-ASSET	0001	N	1		Pending
AC unit	AC-ASSET	0002	Y	1		Pending
Installation of AC	AC-ASSET	0002	N		\$500.00	Pending
AC Brackets	AC-ASSET	0002	N	2		Pending
AC Filters	AC-ASSET	0002	N	1		Pending
AC Brackets	AC-ASSET	0003	N	1		PO Grp Incomplete
AC Filters	AC-ASSET	0003	N	1		PO Grp Incomplete

Item Description	Procurement Group ID	Procurement Group Sequence	Primary Unit	Asset Qty	Asset Amount	Status
AC Filters	AC-ASSET	0004	N	1		PO Grp Incomplete

10. The remaining items are received and put into the Maintain Receipts- Receiving page in PeopleSoft Purchasing:

- Two air conditioning units.
- Three brackets
- 1,000 USD of installation services are performed by the service supplier.

11. Receiver Interface Push process is run. The data is placed in the RECV_LN_ASSET table and the Asset Management Interface table (INTFC_PRE_AM) as follows:

Asset Interface Table (INTFC_PRE_AM)

Item Description	Procurement Group ID	Procurement Group Sequence	Primary Unit	Asset Qty	Asset Amount	Status
AC unit	AC-ASSET	0003	Y	1		Pending
AC Brackets	AC-ASSET	0003	N	1		Pending
Installation of AC	AC-ASSET	0003	N		\$500.00	Pending
AC unit	AC-ASSET	0004	Y	1		Pending
AC Brackets	AC-ASSET	0004	N	2		Pending
Installation of AC	AC-ASSET	0004	N		\$500.00	Pending

In addition, the last three rows from the first receipt (procurement group sequence 0003 and 0004) now have a status of Pending.

If any changes are made to the receipts while the data is still in the Asset Management Interface table, the table is updated. For example, if the first receipt of filters is changed from four filters to two, then the AC filters rows for procurement group sequence 0003 and 0004 are set to the status of Retire. If the other interface rows for procurement group sequence 0003 and 0004 have not been processed by the Asset Transaction Loader process (AMIF1000) then the status of those rows would be set to

PO Grp Incomplete. Later, when the two additional filters are received, new rows are inserted for the filters and all rows for procurement group sequence 0003 and 0004 are set to Pending status.

Setting Up Procurement Groups

Create procurement group IDs to link purchasing transaction lines together as part of the same procurement group. Procurement group IDs can be placed on lines on requisitions or purchase orders, and displayed on receipts. Procurement groups can be used to group items together for any purpose. One purpose is to group all items that combined together will create a new asset in PeopleSoft Asset Management. Procurement group IDs are created on the Procurement Groups page.

Page Used to Set Up Procurement Groups

<i>Page Name</i>	<i>Definition Name</i>	<i>Usage</i>
<u>Procurement Groups Page</u>	PO_GROUP_TBL	Create or modify procurement groups.

Procurement Groups Page

Use the Procurement Groups page (PO_GROUP_TBL) to create or modify procurement groups.

Navigation:

Purchasing > Purchase Orders > Maintain Procurement Groups

This example illustrates the fields and controls on the Procurement Groups page. You can find definitions for the fields and controls later on this page.

The screenshot shows the 'Procurement Groups' page with the following details:

- SetID:** SHARE
- Procurement Group ID:** PGRP1
- Procurement Group Detail:** Find | View All | First 1 of 1 Last
- *Effective Date:** 01/01/2012
- *Status:** Active
- *Description:** Procurement Group 1
- *Short Description:** PGRP1
- Primary Unit Item ID:** AM1000
- Description Only Item

The Procurement Groups page enables you to create group IDs to be entered on a requisition line or purchase order line, and displayed on receipt line. This procurement group ID gathers transactions lines together to help you identify a larger item; for example, the Procurement Groups feature can be used in combination with PeopleSoft Asset Management to collect all item IDs that belong to a complete asset such as an air conditioning unit, installation brackets, air filters, and installation services. The complete cost of the asset can be captured as one asset.

Field or Control	Description
SetID	Enter the SetID for your procurement group. Procurement groups are part of the FS_18 Record Group.
Procurement Group ID	Enter a unique number or letter combination to identify a procurement group that you are creating; for example, GRP_01, AC_UNIT_22, and so on. This group ID can be entered on requisition lines or purchase order lines and displayed on receipt lines.
Status	Options include Active or Inactive. By linking status and effective date, you can retain historical information.
Description	Enter the long description for your procurement group.
Short Description	Enter the short description for your procurement group.

<i>Field or Control</i>	<i>Description</i>
Primary Unit Item ID	(Optional) Enter an item ID to define the primary unit for this procurement group. You can identify the primary unit here or leave this field blank and identify the primary unit on the transaction lines at which point the primary unit item ID will be updated. Once the primary item has been established (that exists on any transactions), it cannot be changed.
Description Only Item	<p>Select this check box if the primary unit is a description-only item.</p> <p>Once a description only item has been established (it has been marked as a primary item on any transaction), this cannot be unchecked</p>

Managing Procurement Cards

Understanding the Procurement Card Business Process

The procurement card feature supports credit card purchases made by card holding employees in your organization and enables you to reduce the number of small purchases that go through your procurement department. You must have PeopleSoft Payables installed to implement the procurement card feature in PeopleSoft Purchasing.

This diagram illustrates the basic flow of the procurement card business process from staging the electronic procurement card statement to the application tables through to the voucher staging table.

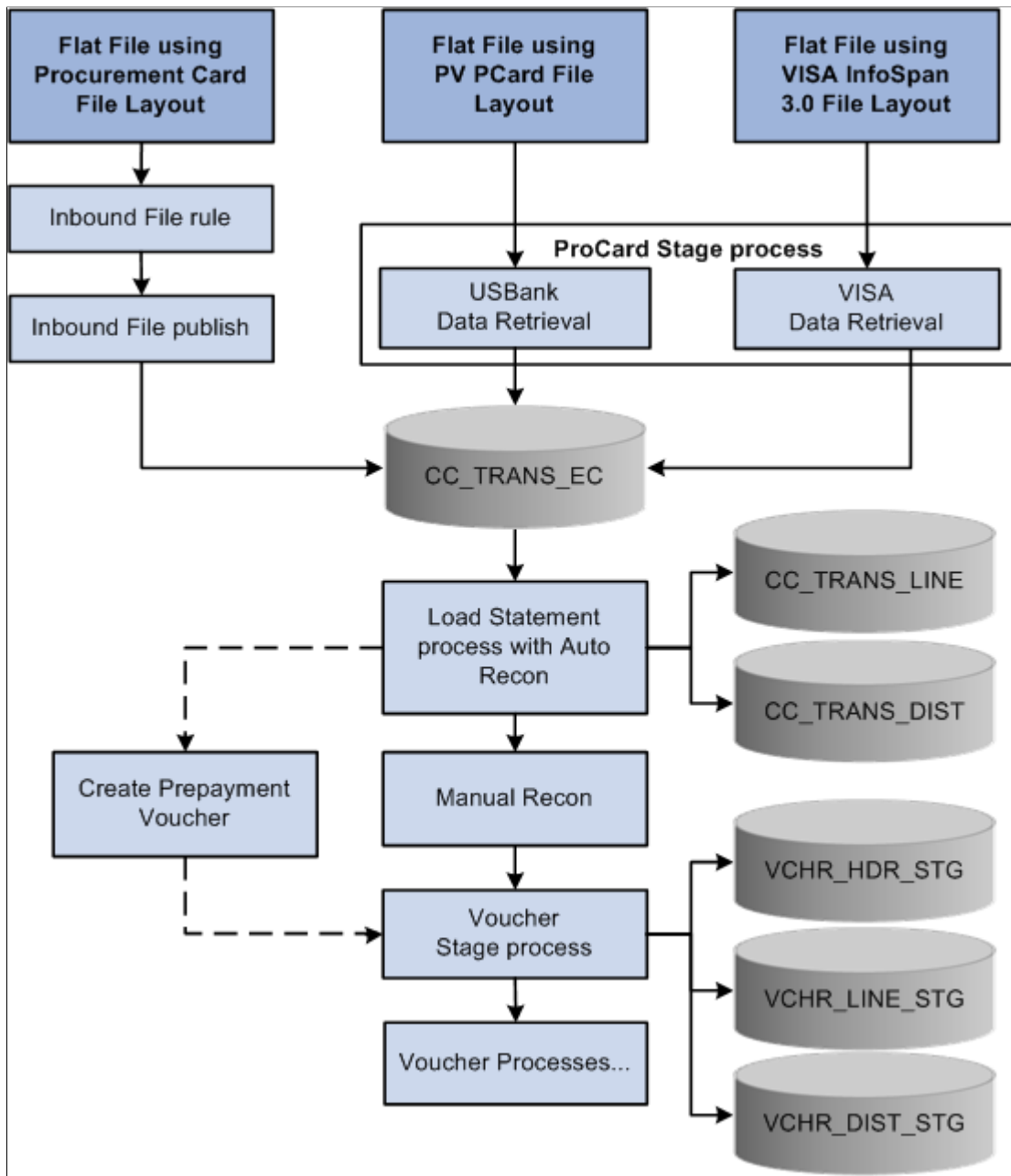

Common Elements Used in Procurement Card

<i>Field or Control</i>	<i>Description</i>
Employee Name	Displays the Last and First Name from the employee information which is entered on the “Personal Data (Edit) Page (Common Definitions)” (Application Fundamentals).

Field or Control	Description
Display Unmasked Card Number	<p>Select this check box if you want to show the full credit card number on the page or report. This check box appears cleared by default. This check box will only appear on a page if you are associated with a role that has Unmask Card Number rights for procurement cards.</p> <hr/> <p>Note: This field pertains to role of the user accessing the page.</p> <hr/>
Card Issuer	<p>Select the card issuer. In most cases, this is the name of the bank that issues the card.</p>
Card Number	<p>Enter the procurement card account number. After you enter the full card number the system will encrypt the card number and display the masked card number in this field. For example, if you enter 6755-8867-6666-6755, the system will display *****6755 as the masked card number. The number of digits that are visible for the card number is based on the Number of Digits to Display field setting you specify on the Installation Options - Purchasing page.</p> <p>To modify the encrypted card number, you can enter a full card number again or modify just the visible digits.</p> <p>For more information about PeopleSoft encryption technology See "Encrypting Text With PSCipher" and "Securing Data with PeopleSoft Encryption Technology" in the <i>PeopleTools: Security Administration</i>.</p> <p>Plus, you can perform a partial search on the card number field. The maximum number of digits that you can perform a partial search against is based on the Number of Digits to Display field setting as well. For example, if the number of digits to display is 4, and you enter 1234 in the card number field, the system will use %1234 to search for the corresponding card numbers. The system compares against the right most digits. If you enter 12345 the system won't be able to find any corresponding card number matches.</p> <p>If there are multiple cards with the same suffix and they are owned by the same employee, then the employee ID and name will appear in the header of the page. However, if they are owned by different employees, then employee ID and name will not appear.</p>
Billing Amount	<p>Amount and associated currency billed for the statement line.</p>
Location	<p>Location to which payment for the selected lines is to be distributed.</p>
Merchant	<p>Source of the purchased goods or services.</p>

Field or Control	Description
PO Qty (purchase order quantity)	Displays the purchase order quantity of each item purchased for this statement line. If there's no purchase order associated with the statement or the quantity is unknown, the purchase order quantity automatically changes to <i>1</i> .
Posted Date	Displays the date when each statement line has been processed and posted by the card issuer.
Proxy	A PeopleSoft user who has access rights to procurement card transactions.
Reference/Reference Number	Unique number captured by the merchant at the point of sale to help identify the transaction.
Role	A procurement card role carries a unique set of access rights.
Role Name	Select the role name that you want to filter the report by. The roles available for selection, are those roles that belong to the current user that also have cards assigned to them. It does not include those roles that have no cards assigned to them.
Ship To	Address to which the goods that you purchased were shipped. Used to identify applicable taxes if you decide to have the system calculate the sales or use tax for the statement.

Field or Control	Description
Statement Status	<p>Statement line status. Values are:</p> <p><i>Staged</i>: Statement from the bank is loaded into the staging tables by the Load ProCard Stage process.</p> <p><i>Initial</i>: Statement has been staged in the statement table and the cardholders have been notified through the Bank Statement Workflow process. After each notice has been successfully sent to a cardholder, the system updates its status to <i>Initial</i> if it was <i>Staged</i>.</p> <p><i>Verified</i>: Statement is waiting to be reviewed. After verification, the statement line status changes to <i>Approved</i>. Currently, the verified status does not have any significant meaning by itself. However, it can be used in an environment where tighter control is required. The cardholder can only set the status to <i>Verified</i> and another person has to approve it and set the status to <i>Approved</i>.</p> <p><i>Approved</i>: Statement is ready to be picked up by the voucher process. Only those statement lines that are approved are pushed to the voucher staging tables.</p> <p><i>Closed</i>: Statement has been pushed to the voucher staging table.</p> <p><i>Not Closed</i>: Any transactions that are not in the voucher staging table.</p> <p><i>Error</i>: Procurement card transaction that failed voucher edit.</p>
Tax Code	<p>A set of tax authorities that comprises all taxes that apply within a particular geographical location. In this US, tax codes are state, country, city, and other special jurisdictions. This field is informational on the procurement card transaction.</p>
Transaction Amount	<p>Amount of the purchase and the source amount (in its local currency) charged by the supplier. The amount and currency may be different than the billing amount and currency that the cardholder is liable to pay.</p>
Trans Date (transaction date)	<p>Date when the goods were purchased.</p>
VAT (value-added tax)	<p>A tax on the estimated market value added to a product or material at each stage of its manufacture or distribution.</p> <hr/> <p>Note: The VAT values that are recorded throughout the procurement card life cycle pass into the invoice and VAT reporting structures.</p> <hr/>

Related Links

[Establishing Procurement Card Security](#)

[Setting Up Procurement Card Installation Options](#)

Setting Up Procurement Card Installation Options

This section lists the page used to set up your procurement card installation options.

Note: Before you can use the procurement card functionality, you must first set up your procurement card installation options. These options determine procurement card controls that are used throughout the procurement card life cycle.

Page Used to Set Up Procurement Card Installation Options

<i>Page Name</i>	<i>Definition Name</i>	<i>Usage</i>
Installation Options - Purchasing Page	INSTALLATION_PO	Define general purchasing controls, such as autonumbering parameters, maximum quantities for quantity price breaks, and the maximum number of rows that are to appear in scroll areas; define requisition loader parameters, such as maximum lines loaded; and define procurement card controls, such as the number of digits that are to appear for a procurement card.

Establishing Procurement Card Security

This section provides an overview of procurement card security.

Pages Used to Establish Procurement Card Security

<i>Page Name</i>	<i>Definition Name</i>	<i>Usage</i>
<u>User Profiles - Roles Page</u>	USER_GENERAL	Assign users to procurement card roles.
<u>Register Procurement Card Roles Page</u>	CC_ROLE	Identify roles for the procurement card module. You can create your own PeopleSoft roles for the procurement card module. After registering them here on this page, they can be used in the procurement card module.
<u>Procurement Card Access Rights Page</u>	CC_RIGHTS1	Assign individual access rights for each procurement card role.

Page Name	Definition Name	Usage
<u>Assign Proxies Page</u>	CC_PROXY_BY_USER	Each PeopleSoft user who is a member of a procurement card role can be assigned to multiple cards with different roles.
Select Procurement Cards Page	CC_PROXY_BY_USER1	Search and assign additional procurement cards to the proxy user.
Assign Proxies Page	CC_PROXY_COPY	Select the user you want to copy to or move to the proxy role. This user will acquire the proxy role for the procurement cards selected in the Assign Proxies page.
Copy/Move Exceptions Page	CC_PROXY_BY_USER2	Review and override copy or move exceptions from one proxy user to another.
<u>SpeedChart Page</u>	SPEEDCHART	Define SpeedCharts.
<u>Define Accounting Tag</u>	ACCOUNTING TAG	Define Accounting Tag
<u>Assign SpeedCharts Page</u>	CC_ASSIGN_SPEEDCH	Assign SpeedCharts for each procurement card.
<u>Assign Accounting Tags page</u>	CC_ASSIGN_TAG	Assign Accounting Tag for each procurement card.
Assign Proxies Page	CC_CARD_DATA4	Assign users (proxies) and the role associated with the selected cardholder.

Understanding Procurement Card Security

The procurement card functionality enables your organization to define user roles and user-role access throughout the procurement card process. With increased role security, you can control the level of information that is accessed by users, manage the assignments of different procurement cards, and setup proxies and default accounting distributions. PeopleSoft delivers six procurement card roles and several predefined access rights with the system, so that you can establish your organizational role and role access parameters easily.

You do not need to use the predefined procurement card roles that PeopleSoft Purchasing provides. You can establish your own roles that match your environment. PeopleSoft Purchasing delivers these predefined roles so that you can quickly begin using the procurement card functionality.

For backward compatibility during upgrade, the system converts your existing proxies and assigns them to the procurement card administrator role. You can view this system conversion using the Assign Proxies page in PeopleSoft Purchasing. In addition, to complete the proxy assignment you must manually

assign each proxy (PeopleSoft user) using PeopleTools security functionality to the procurement card administrator role (CC_ADMINISTRATOR). This is done using the User Profiles - Role page.

See [User Profiles - Roles Page](#).

See [Assign Proxies Page](#).

PeopleSoft Predefined User Roles

PeopleSoft delivers the following predefined user roles with the system: Administrator, Approver, Reconciler, Reviewer, PO User (purchase order user), and Req User (requisition user).

User Profiles - Roles Page

Use the User Profiles - Roles page (USER_GENERAL) to assign users to procurement card roles.

Navigation:

PeopleTools > Security > User Profiles > User Profiles > User Profiles - Roles

See the product documentation for *PeopleTools: Security Administration*

Register Procurement Card Roles Page

Use the Register Procurement Card Roles page (CC_ROLE) to identify roles for the procurement card module.

You can create your own PeopleSoft roles for the procurement card module. After registering them here on this page, they can be used in the procurement card module.

Navigation:

Purchasing > Procurement Cards > Security > Register Roles > Register PCard Roles

When you register user roles, the system links those roles to the procurement card module.

Related Links

“Understanding PeopleSoft Application Security” (Application Fundamentals)

Procurement Card Access Rights Page

Use the Procurement Card Access Rights page (CC_RIGHTS1) to assign individual access rights for each procurement card role.

Navigation:

Purchasing > Procurement Cards > Security > Assign Access Rights to PCard

This example illustrates the fields and controls on the Procurement Card Access Rights page. You can find definitions for the fields and controls later on this page.

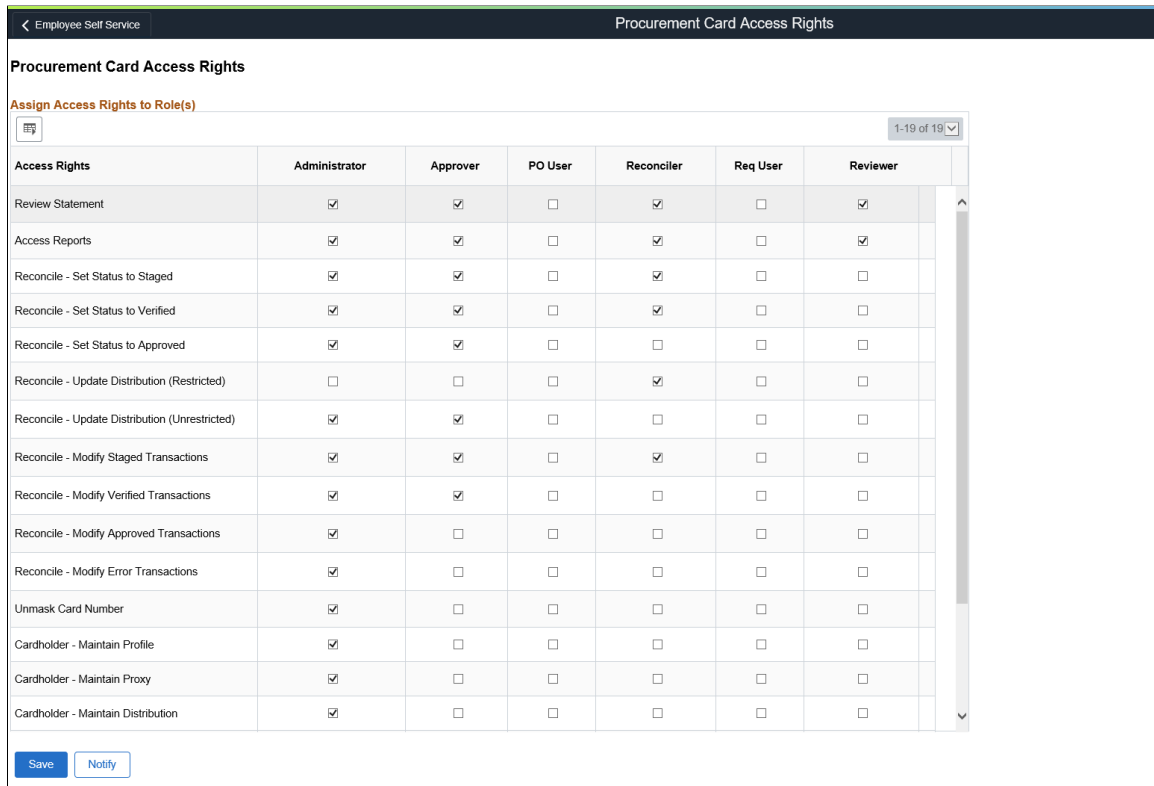

Use this page to link access rights to procurement card roles. Access rights determine how users access different components in the procurement card module.

Field or Control	Description
Review Statement	Select this check box to give this role—users—the access rights to review the statement only. With this right, this role has no authority to modify the statement.
Access Reports	Select this check box to give this role—users—the access rights to run procurement card reports.
Reconcile - Set Status to Staged	Select this check box to give this role—users—the access rights to change the status of the statement to <i>0 - Staged</i> .
Reconcile - Set Status to Verified	Select this check box to give this role—users—the access rights to change the status of the statement to <i>2 - Verified</i> . Note: Once the status is set to <i>Verified</i> and the reconciler saves and exist the page, the statement can no longer be modified. Users cannot change the status of any transaction that is already set to <i>Verified</i> , <i>Approved</i> , or <i>Closed</i> . For transactions that need to be reverified, users with approval rights must set their status to <i>Staged</i> .

Field or Control	Description
Reconcile - Set Status to Approved	<p>Select this check box to give this role—users—the access rights to change the status of the statement to 3 - <i>Approved</i>.</p> <hr/> <p>Note: Once the status is set to <i>Approved</i> and the approver saves and exits the page, the statement can no longer be modified.</p> <hr/>
Reconcile - Update Distribution (Restricted)	<p>Select this check box to give this role—users—the access rights to update the distribution by selecting one of the predefined Accounting Tags or (SpeedCharts) that are assigned to this card.</p>
Reconcile - Update Distribution (Unrestricted)	<p>Select this check box to give this role—users—the access rights to update the distribution by selecting one of the predefined Accounting Tags or (SpeedCharts) that are assigned to this card or by entering the ChartField information manually.</p>
Reconcile - Modify Staged Transactions	<p>Select this check box to give this role—users—the access rights to modify transactions that are not verified or approved.</p>
Reconcile - Modify Verified Transactions	<p>Select this check box to give this role—users—the access rights to modify transactions that are not approved.</p>
Reconcile - Modify Approved Transactions	<p>Select this check box to give this role—users—the access rights to modify transactions that are approved.</p>
Reconcile - Modify Error Transactions	<p>Select this check box to give this role—users—the access rights to resolve transactions that failed the voucher edit.</p>
Unmask Card Number	<p>Select this check box to give this role—users—the access rights to view the full credit card number.</p> <p>Plus, with this right, you have the option of printing the full credit card number on any of the procurement card reports or displaying it on any of the procurement card inquiry pages.</p> <hr/> <p>Note: The full credit card number always appears in the following components: Assign Proxies, Assign Accounting Tag or (Assign SpeedCharts), and Cardholder Profile.</p> <hr/>
Cardholder - Maintain Profile	<p>Select this check box to give this role—users—the access rights to modify any information on the Card Data page in the Cardholder Profile component.</p>
Cardholder - Maintain Proxy	<p>Select this check box to give this role—users—the access rights to add, change, or delete proxy assignments in the Cardholder Profile component.</p>

Field or Control	Description
Cardholder - Maintain Distribution	Select this check box to give this role—users—the access rights to add, change, or delete accounting distribution assignments in the Cardholder Profile component.
Usage - Use Procurement Card on Requisition	Select this check box to give this role—users—the access rights to assign a procurement card as a payment method when creating a requisition.
Usage - Use Procurement Card on PO (usage - use procurement card on purchase order)	Select this check box to give this role—users—the access rights to assign a procurement card as a payment method when creating a purchase order.
Usage - Allow Override of Supplier Card	Select this check box to give this role—users—the access rights to override a supplier card that was previously entered for a purchase order. The supplier card appears by default from the supplier profile and this role has the rights to override that value if the supplier is also set to allow override.
Reconcile – Reviewed Attachments	Select the user roles to grant the access rights for using the Attachment Reviewed check box on the Reconcile Statement - Procurement Card Transactions page.

Assign Proxies Page

Use the Assign Proxies page (CC_PROXY_BY_USER) to each PeopleSoft user who is a member of a procurement card role can be assigned to multiple cards with different roles.

Navigation:

Purchasing > Procurement Cards > Security > Assign Proxies to PCard

This example illustrates the fields and controls on the Assign Proxies page. You can find definitions for the fields and controls later on this page.

Assign Proxies

Kenneth Schumacher

This is a proxy user for the procurement cards identified below. Specify the proxy's role for each card individually, or Apply a role to the selected cards in mass.

Select Procurement Cards Display Unmasked Card Number

Assign Proxies								Personalize	Find	View All	Print	Export	First	1-8 of 8	Last	
*Empl ID	Employee Name	*Card Issuer	*Card Number	*Role	Requester Default	Buyer Default										
<input type="checkbox"/> IXHEEE102	Angelini,Gina	VISA	*****7890	Administrator	<input type="checkbox"/>	<input type="checkbox"/>										
<input type="checkbox"/> IXHEEE102	Angelini,Gina	VISA	*****VNDR	Administrator	<input type="checkbox"/>	<input type="checkbox"/>										
<input type="checkbox"/> IXHEEE120	Crawford,William	MC	*****9012	Administrator	<input type="checkbox"/>	<input type="checkbox"/>										
<input type="checkbox"/> IXHEEE128	Masterson,Carlos	BKAUS	*****3222	Administrator	<input type="checkbox"/>	<input type="checkbox"/>										
<input type="checkbox"/> IXHEEE128	Masterson,Carlos	VISA	*****3131	Administrator	<input type="checkbox"/>	<input type="checkbox"/>										
<input type="checkbox"/> IXHEEE128	Masterson,Carlos	VISA	*****7777	Administrator	<input type="checkbox"/>	<input type="checkbox"/>										
<input type="checkbox"/> IXHEEE128	Masterson,Carlos	VISA	*****1111	Administrator	<input type="checkbox"/>	<input type="checkbox"/>										
<input type="checkbox"/> IXHEEE128	Masterson,Carlos	VISA	*****0101	Administrator	<input type="checkbox"/>	<input type="checkbox"/>										

Select All Clear All

Assign Role: Administrator

Field or Control	Description
Requester Default	<p>Select this check box if you would like this procurement card to appear as the default when defining the requester on the Requestor Setup page. The selection you make here also appears on the Requestor Setup page. Establishing it here accomplishes the same thing as establishing it on the Requestor Setup page.</p> <p>The selection you make here will also appear on the Cardholder Profile - Card Data: Assign Proxies page.</p> <hr/> <p>Note: This field will only appear if this proxy user has also been set up as a requester using the Requestor Setup page.</p>
Buyer Default	<p>Select this check box if you would like this procurement card to appear as the default when defining the buyer on the Buyer Setup page. The selection you make here also appears on the Buyer Setup page. Establishing it here accomplishes the same thing as establishing it on the Buyer Setup page.</p> <p>The selection you make here will also appear on the Cardholder Profile - Card Data: Assign Proxies page.</p> <hr/> <p>Note: This field will only appear if this proxy user has also been set up as a buyer using the Buyer Setup page.</p>
Apply	<p>Click this button to apply the same role to multiple procurement cards for the proxy user.</p>

Field or Control	Description
Delete	Click this button to remove selected cards from the current proxy user. This proxy user can no longer access transactions for those cards.
Copy to	Click this button to copy access rights to another user.
Move to	<p>Click this button to transfer access rights to another user.</p> <p>When you move access rights to another user, the system copies the procurement card list from the current user to the target user and removes the cards from the original user list.</p> <hr/> <p>Note: All cards that are assigned (moved or copied) to the target user with different roles are identified as exceptions. You can override exceptions on the Exceptions page.</p> <hr/>

SpeedChart Page

Use the SpeedChart page (SPEEDCHART) to define SpeedCharts.

Navigation:

Setup Financials/Supply Chain > Product Related > Procurement Options > Management > SpeedChart

Related Links

“Defining SpeedCharts” (PeopleSoft Source to Settle Common Information)

Define Accounting Tag

Use the Accounting Tag page (ACCTG_TAG_MAIN) to define Accounting Tags.

For information on Define Accounting Tag, see “Accounting Tags - ChartFields Page” (Application Fundamentals) and “Setting Up Accounting Tags” (Application Fundamentals)

Assign SpeedCharts Page

Use the Assign SpeedCharts page (CC_ASSIGN_SPEEDCH) to assign SpeedCharts for each procurement card.

Navigation:

Purchasing > Procurement Cards > Security > Assign SpeedCharts

This example illustrates the fields and controls on the Assign SpeedCharts page. You can find definitions for the fields and controls later on this page.

Assign Proxies

Kenneth Schumacher

This is a proxy user for the procurement cards identified below. Specify the proxy's role for each card individually, or Apply a role to the selected cards in mass.

Select Procurement Cards Display Unmasked Card Number

Assign Proxies								Personalize	Find	View All	Print	First	1-8 of 8	Last
*Empl ID	Employee Name	*Card Issuer	*Card Number	*Role	Requester Default	Buyer Default								
<input type="checkbox"/> IXHEEE102	Angelini,Gina	VISA	*****7890	Administrator	<input type="checkbox"/>	<input type="checkbox"/>								
<input type="checkbox"/> IXHEEE102	Angelini,Gina	VISA	*****VNDR	Administrator	<input type="checkbox"/>	<input type="checkbox"/>								
<input type="checkbox"/> IXHEEE120	Crawford,William	MC	*****9012	Administrator	<input type="checkbox"/>	<input type="checkbox"/>								
<input type="checkbox"/> IXHEEE128	Masterson,Carlos	BKAUS	*****3222	Administrator	<input type="checkbox"/>	<input type="checkbox"/>								
<input type="checkbox"/> IXHEEE128	Masterson,Carlos	VISA	*****3131	Administrator	<input type="checkbox"/>	<input type="checkbox"/>								
<input type="checkbox"/> IXHEEE128	Masterson,Carlos	VISA	*****7777	Administrator	<input type="checkbox"/>	<input type="checkbox"/>								
<input type="checkbox"/> IXHEEE128	Masterson,Carlos	VISA	*****1111	Administrator	<input type="checkbox"/>	<input type="checkbox"/>								
<input type="checkbox"/> IXHEEE128	Masterson,Carlos	VISA	*****0101	Administrator	<input type="checkbox"/>	<input type="checkbox"/>								

Select All Clear All

Assign Role: Administrator

Field or Control	Description
SpeedChart Key	Click the associated link to view the details of SpeedCharts within a given SetID. When you click this link the SpeedChart Detail page appears.
Select Procurement Cards	Select this link to assign additional procurement cards to the SpeedChart. When you click this link the Select Procurement Cards page appears.

Note: Since SpeedCharts are driven by SetID, the available list of cardholders and cards are limited to business units that are tied to the same SetID.

Assign Accounting Tags page

Use the Assign Accounting Tags page (CC_ASSIGN_TAG) to assign Accounting Tag for each procurement card

This component is available only when the product is registered to use accounting tags. If the product is not registered to use accounting tags, Assign SpeedCharts component will be available. For more information see “Accounting Tag Products Page” (Application Fundamentals)

Navigation:

Purchasing > Procurement Cards > Security > Assign Accounting Tag

This example illustrates the fields and controls on the Assign Accounting Tags page. You can find definitions for the fields and controls later on this page.

Assign Accounting Tags

TEST3

Each Accounting Tag definition may carry one or more accounting distribution lines. Only universal Accounting Tag can be assigned to procurement cards. Each procurement card can have multiple Accounting Tag assigned to it; however, only one of them can be selected as default.

*Accounting Tag: **TEST3**

Select Procurement Cards Display Unmasked Card Number

Assign Accounting Tags				Personalize Find View All
*Empl ID	Employee Name	*Card Issuer	*Card Number	
<input type="checkbox"/> KU0011	Bendetto, John	VISA	*****3450	+ -
<input type="checkbox"/> KU9107	Ash, Jude	MC	*****5354	+ -
<input checked="" type="checkbox"/> KU9106	Ann, Mary	AMEX	*****6777	+ -
<input type="checkbox"/> IXHEEE102	Angelini, Gina	VISA	*****VNDR	+ -
<input type="checkbox"/> IXHEEE102	Angelini, Gina	VISA	*****7890	+ -

Select All Clear All

Field or Control	Description
Accounting Tag	Click the associated link to view the details of Accounting Tag within a given SetID. When you click this link the Accounting Tag Detail page appears.
Select Procurement Cards	Select this link to assign additional procurement cards to the Accounting Tag. When you click this link the Select Procurement Cards page appears.

Note: Since Accounting Tags are driven by SetID, the available list of cardholders and cards are limited to business units that are tied to the same SetID.

Defining Cardholder Profile

To define cardholder profiles, use the Cardholder Profile component (CC_EE_PROFILE).

This section provides an overview of the Personal Employee Enterprise Integration Point (EIP)

Pages Used to Define Cardholder Profile

Page Name	Definition Name	Usage
<u>Personal Data Page</u>	CC_PERSONAL_DATA	View cardholder information, such as personnel status and home address. This is a display-only page and is shared by PeopleSoft Expenses and PeopleSoft Purchasing.
<u>Card Data Page</u>	CC_CARD_DATA	Enter card issuer, card number, and set the transaction limits for that card.
<u>Suppliers Page</u>	CC_CARD_DATA5	Define suppliers and the card options for these suppliers.
<u>Assign Proxies Page</u>	CC_CARD_DATA4	Define who can access this procurement card and identify the rights that they have.
<u>Default Accounting Distribution Page</u>	CC_CARD_DATA2	Enter accounting distribution defaults for single-line distribution or assign SpeedCharts for multiline distributions.
SpeedChart Detail Page	CC_SPEEDCH_DTL	View the details of the SpeedChart.
<u>Restricted Purchase Page</u>	CC_CARD_DATA3	Set restrictions on the card by limiting the amount that the cardholder can spend on a specific commodity.
Cardholder Information Page	RUN_POY8000	Run the Cardholder Information multiprocess job (POY8000). This process will generate the Cardholder Information report (POX8000)
Purchase Exceptions Page	RUN_POY8010	Run one of these multiprocess jobs: Exceed Limit-Per-Trans (POY8010) which will generate the Exceed Limit-Per-Trans report (POX8010), Exceed Limit-Per-Cycle (POY8011) which will generate the Exceed Limit-Per-Cycle report (POX8011), Exceed Trans-Per-Day (POY8012) which will generate the Exceed Trans-Per-Day report (POX8012), Exceed Trans-Per-Cycle (POY8013) which will generate the Exceed Trans-Per-Cycle report (POX8013), or Unauthorized Commodity (POY8014) which will generate the Unauthorized Commodity report (POX8014).

Page Name	Definition Name	Usage
MCC Exceptions Page(merchant category code exceptions)	RUN_POY8064	Run the MCC Exceptions multiprocess job (POY8064). This process will generate the MCC Exceptions report (POX8064)

Understanding the Personal Employee EIP

The employee accessible in this setup may be a result of an interface with PeopleSoft Human Resources or another external human resources package. The external interface is created by using the personal employee EIP. The interface within PeopleSoft is accomplished using the Load Employee Data page.

You can also receive employee procurement card data from PeopleSoft Human Resources. These EIPs enable PeopleSoft Expenses and PeopleSoft Purchasing to send and receive basic cardholder data to and from PeopleSoft Human Resources. When one application changes a record, an EIP automatically updates and synchronizes tables in the other applications.

This table lists service operations that contain code used to send and receive information between the databases:

Service Operation	Records	Description
CORPORATE_CARD_DATA_FULLSYNC	CC_CARD_DATA_EX	Full data load of employee corporate card account data.
CORPORATE_CARD_DATA_SYNC	CC_CARD_DATA_EX	Incremental update of corporate card account data.
CORPORATE_CARD_FULLSYNC	CC_CARD_TBL_EX	Full data load of corporate card suppliers.
CORPORATE_CARD_SYNC	CC_CARD_TBL_EX	Incremental update of corporate card suppliers.

Related Links

“Understanding Integrating With PeopleSoft Applications” (PeopleSoft Expenses)

Personal Data Page

Use the Personal Data page (CC_PERSONAL_DATA) to view cardholder information, such as personnel status and home address.

This is a display-only page and is shared by PeopleSoft Expenses and PeopleSoft Purchasing.

Navigation:

Purchasing > Procurement Cards > Definitions > Cardholder Profile > Personal Data

Field or Control	Description
Personnel Status	Displays the cardholder personnel status, such as employee, consultant, contractor, or any other designation that your organization uses. Appears by default from human resources and cannot be changed.
Telephone	Displays the cardholder home telephone number.

Card Data Page

Use the Card Data page (CC_CARD_DATA) to enter card issuer, card number, and set the transaction limits for that card.

Navigation:

Purchasing > Procurement Cards > Definitions > Cardholder Profile > Card Data

This example illustrates the fields and controls on the Card Data page. You can find definitions for the fields and controls later on this page.

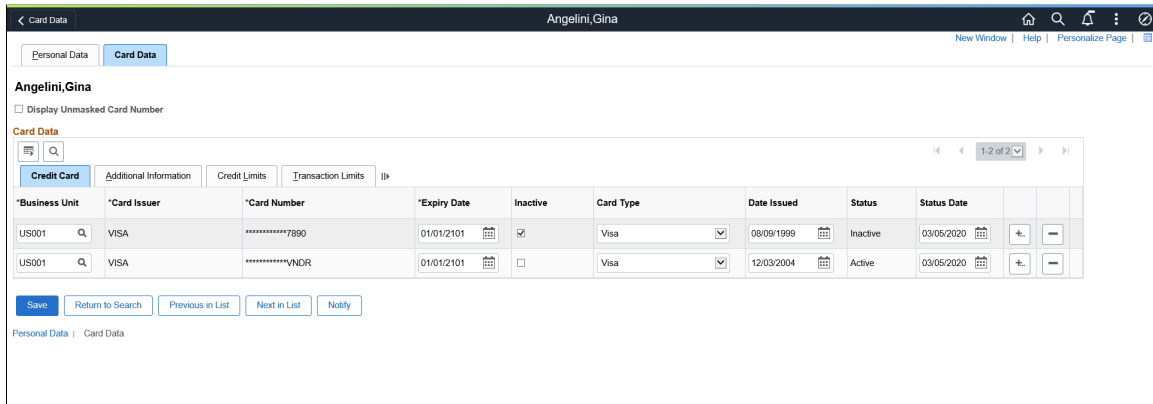

Card Data

Select the Card Data tab.

Field or Control	Description
Card Issuer	Select the procurement card issuer.
Card Number	Enter the card number. Note: The Display Unmasked Card Number check box under the employee name allows you to mask or unmask the card number.

Field or Control	Description
Expiry Date	Enter the card expiry date.
Inactive	<p>You can set the status of a card to Active or Inactive. When the card status is Inactive, another employee can use the same card number. In this case, the system generates a warning message similar to the following: Are you sure you want to assign credit card *****7890 to IXHEEE120 (10070, 381). The credit card number has been assigned to another employee with Inactive status.</p> <p>You can either proceed with the selection or cancel the process as you wish.</p> <hr/> <p>Note: You cannot assign an active credit card to multiple employees. The system does not allow it and generates an error message.</p> <hr/>
Card Type	Select the card type for this procurement card.
Date Issued	Select the date when the card was issued to the user.
Status	Displays the status as Active and Inactive based on the selection of the Inactive check box.
Status Date	Displays the date of status change.

Additional Information

Select the Additional Information tab.

Field or Control	Description
Supplier Card	Select this check box if this card is a Supplier card. Once you select this check box the suppliers link becomes available.
Suppliers	<p>Click this link to access the Suppliers page. Use this page to assign the supplier and card options for this supplier card.</p> <p>This will simultaneously update the supplier location with the same data (like requestor in assign proxies). This relationship can be maintained in either place.</p>

Field or Control	Description
Proxies	Select the Proxies link to assign proxies. For more information, see Assign Proxies Page .

Credit Limits

Select the Credit Limits tab.

Note: The fields on this tab are only used for reporting purposes.

Field or Control	Description
Maximum Credit Limit	(Optional) Enter the maximum credit limit for the credit card.
Monthly Credit Limit	(Optional) Enter the maximum amount that a cardholder can spend every month.
Transaction Amount Limit	(Optional) Enter the maximum amount that a cardholder can spend for each transaction.
Currency	Select the currency for the credit limit fields.

Transaction Limits

Select the Transaction Limits tab.

Note: The fields on this tab are only used for reporting purposes.

Field or Control	Description
Transactions Allowed Per Month	Enter the number of transactions that a cardholder can perform in a month.
Transactions Allowed Per Day	Enter the number of transactions that a cardholder can perform in a day.

Suppliers Page

Use the Suppliers page (CC_CARD_DATA5) to define suppliers and the card options for these suppliers.

Navigation:

Click the **Suppliers** link on the Card Data page.

Field or Control	Description
Pay for PO	Select this check box if you want this supplier card to appear as the payment method for this supplier and location on a purchase order. If selected this supplier card will appear by default on the purchase order.
Allow Override	Select this check box if this supplier card for this supplier and location can be overridden on a purchase order.
Dispatch Option	<p>Select the dispatch option for this supplier location. Options are:</p> <ul style="list-style-type: none"> • <i>Charge to Card on File:</i> Select this option to have "Charge to credit card" print in the header portion of the PO Dispatch/Print SQR report (POPO005). • <i>Contact Buyer:</i> Select this option to have the buyer's name and phone number print in the header portion of the PO Dispatch/Print report. For example, "*Please contact John Smith 925-694-3863 for payment information." • <i>Contact Cardholder:</i> Select this option to have the card holder's name and phone number print in the header portion of the PO Dispatch/Print report. For example, "*Please contact John Smith 925-694-3863 for payment information." • <i>Default:</i> Select this option to use the dispatch option on the purchase order. • <i>Include Masked Card Info</i> (include masked card information): Select this option to have the masked card number, card type, and expiration date appear in the header portion of the PO Dispatch/Print report. • <i>No Reference:</i> Select this option to have no procurement card information print on the PO Dispatch/Print report. <p>The system will also update the fields on the Cardholder Profile and Assign Proxies pages with the selection you make here.</p>

Assign Proxies Page

Use the Assign Proxies page (CC_CARD_DATA4) to define who can access this procurement card and identify the rights that they have.

Navigation:

Click the **Proxies** link on the Card Data page.

Field or Control	Description
Add Proxy By Role	Click the link to select proxy users by their role names. The system displays all users assigned to the selected role and adds them to the Proxies grid. The role names are populated in the Role field.
User ID	Select the user authorized to reconcile procurement card statements for the selected card. Creating a user ID enables you to have a centralized reconciliation team that has the authority to review and edit an individual cardholder's statement. Individual cardholders cannot reconcile their own statements unless they have been set up as their own proxy.
Role	Select an appropriate role for the designated proxy. Each role carries a set of access rights.
Requestor Default	<p>This check box setting appears by default from the Assign Proxies page when defining the security for the proxy. If this check box is selected, this is the procurement card that will appear as the default when defining the requestor on the Requestor Setup page.</p> <p>If you make any changes to this check box, the setting will automatically be reflected in the Assign Proxies page when defining the security for the proxy and automatically be reflected in the Requestor Setup page.</p>
Buyer Default	<p>This check box setting appears by default from the Assign Proxies page when defining the security for the proxy. If this check box is selected, this is the procurement card that will appear as the default when defining the buyer on the Buyer Setup page.</p> <p>If you make any changes to this check box, the setting will automatically be reflected in the Assign Proxies page when defining the security for the proxy and automatically be reflected in the Buyer Setup page.</p>

Default Accounting Distribution Page

Use the Default Accounting Distribution page (CC_CARD_DATA2) to enter accounting distribution defaults for single-line distribution or assign SpeedCharts for multiline distributions.

Navigation:

Click the **Default Distrib** (default distribution) link on the Card Data page.

This example illustrates the fields and controls on the Default Accounting Distribution page. You can find definitions for the fields and controls later on this page.

Distribution Choices

Field or Control	Description
Use Single-Line Distribution	<p>Select this option to assign a single account distribution for the procurement card transactions. This option is selected when the page appears.</p> <hr/> <p>Note: If you select this option, it enables the Use Single Line Distribution group box.</p>
Use Multi-Line Distribution	<p>Select this option to assign multi-line distributions for the procurement card transactions.</p> <hr/> <p>Note: If you select this option, the Use Multi-Line Distribution group box is enabled.</p>

Use Multi-Line Distribution

<i>Field or Control</i>	<i>Description</i>
Speedchart Key	<p>Select SpeedCharts that can be used for this card when reconciling the statement. Each SpeedChart can carry one or multiple distribution lines. Select a default SpeedChart that is used in the ProCard Load Statement process to create default accounting distribution lines.</p> <hr/> <p>Note: You must designate a default SpeedChart for the system to use when loading statement data.</p>
Accounting Tag	<p>Click the prompt to select appropriate Accounting Tags that will be used to populate ChartFields on transaction distribution lines. The system automatically prorates the amount of an accounting line according to the proration percentages defined on the Accounting Tag.</p> <hr/> <p>Note: Accounting Tag field appears only if Accounting Tag check box is selected for Purchasing on the Accounting Tag Registration page. See “Setting Up Accounting Tags” (Application Fundamentals)</p>
Show Accounting Tags	<p>Click the link to access the Accounting Tag detail page. The Accounting Tag detail page provides information about the Accounting Tag.</p>

Restricted Purchase Page

Use the Restricted Purchase page (CC_CARD_DATA3) to set restrictions on the card by limiting the amount that the cardholder can spend on a specific commodity.

Navigation:

Click the **Commodity Codes** link on the Card Data page.

Note: The fields on this page are only used for reporting purposes.

<i>Field or Control</i>	<i>Description</i>
Commodity Code	<p>Select the commodity for which you want to set a cardholder purchasing restriction. Only commodity codes defined for the SetID associated with the default business unit that you selected on the Card Data page are available.</p>

Field or Control	Description
Limit Amount	Enter the maximum amount that the cardholder can spend on the commodity.
Limit Per Trans (limit per transaction)	Enter the maximum amount that the cardholder can spend per transaction on the commodity.

Defining Card Issuers

To define card issuers, use the ProCard Card Issuers component (CC_CARD_TBL).

This section discusses how to define procurement card issuers.

Pages Used to Define Card Issuers

Page Name	Definition Name	Usage
<u>Card Issuer Page</u>	CC_CARD_TBL	Enter details about the procurement card providers and link these details to a Supplier ID.
VAT Defaults Setup Page	VAT_DEFAULTS_DTL	View VAT defaults.
Card Issuer - Setup Prepayment ChartFields Page	CC_CARD_TBL_CF	Define prepayment voucher ChartFields.

Card Issuer Page

Use the Card Issuer page (CC_CARD_TBL) to enter details about the procurement card providers and link these details to a supplier ID.

Navigation:

Setup Financials/Supply Chain > Product Related > Procurement Options > Purchasing > PCard Card Issuers

This example illustrates the fields and controls on the Card Issuer Page. You can find definitions for the fields and controls later on this page.

Card Issuer

SetID: SHARE Card Issuer: AMEX

Credit Card Provider Record Find | View All First 1 of 1 Last

*Effective Date: 01/01/2000 + -

*Status: Active

*Description: American Express

*Short Description: AMEX

AP Business Unit: US001

*Supplier ID: USA0000030 American Express (Credit Credit #3)

Supplier Location: 1

Corporate Number:

Load Level 3 Data (Purchasing)

Bill Includes Tax (if applied)

Bill Includes VAT (if applied) VAT Default

Days After Billing Date:

Expiration Grace Days:

Prepayment Voucher Default

Create Prepayment Voucher

Prepayment Voucher Options:

Payment Terms ID:

Expenses Enhanced Data Options

Load Enhanced Data

Hotel Folio Options

Create Expense Lines

Credit Card Import Hierarchy

All Detail Summary

Delay Days:

Statement as Approved VAT Receipt

Some countries allow credit card statements to be used in lieu of actual receipts for VAT tax reporting purposes. If a country allows this type of reporting for the above Credit Card Provider, please enter that information here.

VAT Country Personalize | Find | View All | First 1 of 1 Last

*Country	Description		
1 <input type="text"/>		+	-

Credit Card Provider Record

<i>Field or Control</i>	<i>Description</i>
AP Business Unit (PeopleSoft Payables business unit)	Select the PeopleSoft Payables business unit that will be used for the prepayment voucher and for staging reconciled transactions.

Field or Control	Description
Load Enhanced Data	Select this check box if you want to load itemized data for the procurement card transactions associated with this card issuer. Examples of enhanced data is additional information related to a transaction such as car rental, lodging, and passenger itinerary information.
Bill Includes Tax (if applied)	Select this check box to indicate that the procurement card provider record includes sales tax, if applicable.
Bill Includes VAT (if applied)	Select this check box to indicate that the procurement card provider record includes value-added taxes, if applicable.

Field or Control	Description
VAT Default (value-added tax default)	Click this link to access the VAT Defaults Setup page, where you can set VAT tolerances to check the difference between the calculated VAT amount and the amount entered on the bank statement. See “Understanding VAT” (PeopleSoft Global Options and Reports).

Prepayment Voucher Default

Field or Control	Description
Create Prepayment Voucher	Select this check box if you want to create a prepayment voucher for the procurement card statement amount.

Field or Control	Description
Prepayment Voucher Options	<p>Select the prepayment voucher option. Values are:</p> <ul style="list-style-type: none"> • <i>Auto Apply</i>: Select this option to have the system use the accounting entry template for the debit side of the transaction. If you select this option you can not select the prepayment voucher ChartFields on the Card Issuer - Setup Prepayment ChartFields page. • <i>Specify</i>: Select this option if you want to specify the ChartFields to be used for the prepayment voucher. This option also creates a reference ID so that only transactions from the same statement as the prepayment will be drawn down for that prepayment. <p>Once you select a prepayment voucher option the Setup Prepayment ChartFields link becomes available.</p>
Payment Terms ID	Select the payment terms for the prepayment voucher.
Setup Prepayment ChartFields	Click this link to access the Card Issuer - Setup Prepayment ChartFields page. Use this page to define prepayment ChartFields.

Expenses Enhanced Data Options

This group box enables you determine how many days you would like to delay importing enhanced data transactions into the system. This enables enhanced data, such as hotel, car rental, or air travel, to be available if it comes in a separate file.

Field or Control	Description
Load Enhanced Data	<p>Select to indicate that your system imports enhanced data such as airfare, car rental, and lodging, from credit card suppliers.</p> <p>Deselect to indicate that your system does not import enhanced data from credit card suppliers.</p>
Create Expense Lines	<p>Select to indicate that when the Load Enhanced Data check box is selected, then enhanced data is to be broken into individual expense lines.</p> <p>Deselect to indicate that when the Load Enhanced Data check box is selected, then enhanced data is loaded, but not broken into individual expense lines. Only the main transaction line is available for an expense report.</p>

Field or Control	Description
Credit Card Hierarchy	<p>Select the type of data to import when enhanced data from credit card suppliers is loaded:</p> <ul style="list-style-type: none"> • All:Select to use a hierarchical approach to import detail data or summary data, and the main transaction. • Detail:Select to import detail data and the main transaction. • Summary:Select to import summary data and the main transaction. <p>First, the system looks for detail data in the file that is received from the credit card supplier. If detail data is available, and no delay days exist, then the system loads the detail data and the main transaction to My Wallet. If detail data is available, and the delay days number is greater than zero, then the system loads the detail data and the main transaction into the staging tables.</p> <p>If the system does not find detail data, it looks for summary data. If summary data is available, and no delay days exist, then the system loads the summary data and the main transaction to My Wallet. If summary data is available, and the delay days number is greater than zero, then the system loads the summary data and the main transaction into the staging tables.</p> <p>If the system does not find detail data or summary data, it loads the main transaction to My Wallet.</p> <hr/> <p>Note: If the detail or summary amount does not match the transaction amount, only transaction rows are loaded.</p> <hr/> <p>If detail data is not available, the system imports only the main transaction. The system does not look for summary data.</p> <p>If the system does not find detail data, or if the detail amount does not match the amount of the main transaction, it imports only the main transaction.</p> <p>This is the only option and is automatically selected if the credit card supplier is American Express.</p> <p>If the system does not find summary data, or if the summary amount does not match the amount of the main transaction, it imports only the main transaction.</p>

Field or Control	Description
Delay Days	<p>Enter the number of days that the system waits to load enhanced data into My Wallet transactions.</p> <p>This field is used during the Load External Data process to determine the number of days to wait to load hotel information into My Wallet. This allows time for the summary data, detail data, or both to be imported if it is sent in a separate file from the main transaction. All other transactions flow through, but the hotel transactions are moved into staging tables and are not available in My Wallet until the appropriate number of days has passed.</p>

Credit Card Import Hierarchy

Use this group box to determine what type of data to import.

Field or Control	Description
All	Select to have the system check for detail data. If detail data exists, the system imports the data as well as the main transaction. If there is no detail data, the system checks for summary data, and if it finds that data imports it as well as the main transaction. If neither types of data are available, the system imports only the main transaction. All is the default value for the group box.
Detail	Select to have the system attempt to import the detail data. If detail data is not available, the system only imports the main transaction. The system does not check for summary data. If the detail data amount is not available or the total does not match, the system only imports the main transaction data.
Summary	Select to have the system attempt to import summary data. If summary data is not available, the system only imports the main transaction.

Statement as Approved VAT Receipt

<i>Field or Control</i>	<i>Description</i>
Country	<p>If the card issuer is an approved provider for claiming tax credit from procurement card statements, select the name of the country that uses credit card statements in lieu of actual receipts for VAT reporting.</p> <p>When the country is listed, the ProCard Load Statement Application Engine process (PO_CCLOADLD) sets the Claiming Tax Credit field to <i>Yes</i>, indicating that the electronic statement can be used as evidence of VAT for claiming VAT recovery. When this is the case, no additional receipt documentation is required for VAT reporting purposes. The system performs appropriate calculations of VAT rebate and recovery for these lines.</p> <p>When the country does not allow electronic versions of the procurement card statement to serve as evidence of VAT recovery, the user has the option to indicate whether a VAT receipt exists on the Reconcile Statement - Procurement Card component.</p>

Defining Preferred Suppliers

To define preferred suppliers, use the Preferred Suppliers component (CC_VNDR_XREF).

This section discusses how to Define Preferred Suppliers

Pages Used to Define Preferred Suppliers

<i>Page Name</i>	<i>Definition Name</i>	<i>Usage</i>
<u>List of Merchants Page</u>	CC_VNDR_NM	Displays a merchant or list of merchants with whom the cardholders have made purchases. To qualify as a preferred supplier, a merchant has to be mapped to a supplier set up in the system. After you enter and save the required information, the data is moved to the preferred supplier list.
Supplier Search Page	Vendor_LOOKUP_SEC	Search for suppliers. <u>List of Merchants Page</u>

Page Name	Definition Name	Usage
<u>Preferred Suppliers Page</u>	CC_VNDR_XREF	Maintain or change the relationship between a merchant and a preferred supplier. The preferred suppliers are those from whom you want the cardholders to purchase.
Non-Preferred Supplier Page	RUN_POY8061	Run the Non-Preferred Supplier multiprocess job (POY8061). This process will generate the Non- Preferred Supplier report (POX8061)

List of Merchants Page

Use the List of Merchants page (CC_VNDR_NM) to displays a merchant or list of merchants with whom the cardholders have made purchases.

To qualify as a preferred supplier, a merchant has to be mapped to a supplier set up in the system. After you enter and save the required information, the data is moved to the preferred supplier list.

Navigation:

Purchasing > Procurement Cards > Definition > Preferred suppliers

Use the fields on the Preferred Suppliers page and click **Search** to display a particular supplier, or leave the fields blank and click **Search** to display all suppliers.

Field or Control	Description
Merchant	Displays the merchant names that come from each line on the bank statement.
Supplier SetID	Select the Supplier SetID for the supplier that you want to associate with the merchant.
Supplier ID	Select the Supplier that you want to associate with the merchant.
Location	Select the Supplier Location.

Preferred Suppliers Page

Use the Preferred Suppliers page (CC_VNDR_XREF) to maintain or change the relationship between a merchant and a preferred supplier.

The preferred suppliers are those from whom you want the cardholders to purchase.

Navigation:

Purchasing > Procurement Cards > Definitions > Preferred Suppliers

On the Preferred Suppliers page, search for a supplier or suppliers.

On the List of Merchants page, select the Preferred Suppliers tab.

Use the fields on this page to edit the preferred suppliers that you defined on the List of Merchants page.

Defining Preferred UOM

To define preferred UOM, use the UOM Mappings component (CC_UOM_XREF).

This section discusses how to define preferred UOM

Pages Used to Define Preferred UOM

<i>Page Name</i>	<i>Definition Name</i>	<i>Usage</i>
<u>List of Merchant UOM (list of merchant unit of measure) Page</u>	CC_UOM_NM	Some suppliers are capable of entering level three data (line item information); therefore, UOM may show up for some statement lines. Displays a list of UOM that comes from the bank statement. Once the corresponding UOM is entered, data is moved to the preferred UOM when you save this page.
<u>Preferred UOM Page</u>	CC_UOM_XREF	Maintain the translation between the merchant UOM and system UOM (stored in UNITS_TBL). The statement load process is based on the information that you entered here to convert the UOM.

List of Merchant UOM (list of merchant unit of measure) Page

Use the List of Merchant UOM (list of merchant unit of measure) page (CC_UOM_NM) to some suppliers are capable of entering level three data (line item information); therefore, UOM may show up for some statement lines.

Displays a list of UOM that comes from the bank statement. Once the corresponding UOM is entered, data is moved to the preferred UOM when you save this page.

Navigation:

Purchasing > Procurement Cards > Definitions > Unit of Measure Mappings > List of Merchant UOM

<i>Field or Control</i>	<i>Description</i>
Merchant UOM	Displays the UOM used by the merchant.
Unit of Measure	Displays the UOM mapped to the merchant UOM.

Preferred UOM Page

Use the Preferred UOM page (CC_UOM_XREF) to maintain the translation between the merchant UOM and system UOM (stored in UNITS_TBL).

The statement load process is based on the information that you entered here to convert the UOM.

Navigation:

Purchasing > Procurement Cards > Definitions > UOM Mappings > Preferred UOM

Use the fields on this page to edit the preferred UOM that you defined on the List of Merchant UOM page.

Defining MCC Blocked

To define blocked MCC's, use the ProCard Blocked MCCs component (CC_MCC_BLOCKED).

This section lists the pages used to define MCC blocked.

Note: Once a merchant category code is blocked, the cardholder is not authorized to purchase from merchants within the blocked category code. This information is used for reporting purposes only within PeopleSoft.

Pages Used to Define MCC Blocked

<i>Page Name</i>	<i>Definition Name</i>	<i>Usage</i>
Blocked MCC Page(blocked merchant category code)	CC_MCC_BLOCKED	Blocks purchases made within the specified MCC.
Merchant Category Group Page	EX_VIS_MCG_MAP	Map MCCs to merchant category groups.

Defining Visa Transaction Type Codes

To define Visa transaction type codes, use the Visa ProCard Transaction Codes component (CC_VISA_TTYPE).

This section lists the page used to set up Visa transaction type codes.

Page Used to Define Visa Transaction Type Code

<i>Page Name</i>	<i>Definition Name</i>	<i>Usage</i>
Visa Transaction Codes Page	CC_VISA_TTYPE	Enter a code provided by VISA to indicate debit or credit transactions.

Defining Procurement Card Mapping

To define procurement card XML maps, use the ProCard MasterCard XML Map component (CC_MC_XML_MAP).

This section list the pages used for procurement card mapping.

Pages Used to Define Procurement Card Mapping

<i>Page Name</i>	<i>Definition Name</i>	<i>Usage</i>
“Country Code Page” (PeopleSoft Expenses)	EX_COUNTRY_MAP_PNL	Map the incoming countries associated with transactions to PeopleSoft countries.
“Currency Code Page” (PeopleSoft Expenses)	EX_CURRENCY_MAP_PNL	Map the incoming currencies associated with transactions to PeopleSoft currencies.
MasterCard XML Map Page	CC_MC_XL_MAP	Define the MasterCard XML mapping to the PeopleSoft mapping.

Setting Up Procurement Card Load Statement Options

To setup procurement card load statement options, use the ProCard Load Statement Options component (CC_RECON_OPT).

This section discusses how to define load statement options.

Page Used to Define Procurement Card Load Statement Options

<i>Page Name</i>	<i>Definition Name</i>	<i>Usage</i>
<u>Load Statement Options Page</u>	CC_RECON_OPT	Set criteria for handling transactions with small amounts and for enabling the system to match and populate purchase order data.

Load Statement Options Page

Use the Load Statement Options page (CC_RECON_OPT) to set criteria for handling transactions with small amounts and for enabling the system to match and populate purchase order data.

Navigation:

Setup Financials/Supply Chain > Product Related > Procurement Options > Purchasing > PCard Load Statement Options

This example illustrates the fields and controls on the Load Statement Options page (1 of 2). You can find definitions for the fields and controls later on this page.

Load Statement Options

Small Amount Criteria

Set status to when billing amount is <= Currency

ProCard Auto-Recon Options

Allow system to match and populate PO data

Criteria to Find Matching Purchase Orders

Reconcile by Header Date Field

Reconcile by Line Date Field

Reconcile by Schedule Date Field

Transactions Charged to a Supplier Card

Set status to when PO amount is within % Over

Set status to when PO amount = transaction amount % Under

Transactions with a Valid PO ID

Set status to when PO amount is within % Over

Set status to when PO amount = transaction amount % Under

This example illustrates the fields and controls on the Load Statement Options page (2 of 2). You can find definitions for the fields and controls later on this page.

▼ Transactions without a Valid PO ID

Set status to

Set status to

when PO amount is within % Over
0.00

when PO amount = transaction amount % Under
0.00

▼ PO Statuses to Include
Personalize | Find | |
First 1-2 of 2 Last

Select	PO Status
<input checked="" type="checkbox"/>	Approved
<input checked="" type="checkbox"/>	Dispatched

Save
Notify
Refresh

Small Amount Criteria

Field or Control	Description
Set status to	Select a small amount criteria status. Values are: <i>Verified</i> , <i>Approved</i> , or the field is blank. If it is blank, the default status is <i>Staged</i> . For tighter control, you can set the status to either blank or <i>Verified</i> . The statement line must be approved before you send it to PeopleSoft Payables.
when billing amount is<=	Enter an amount for the small amount criteria. Indicates the upper limit of the criterion.
Currency	Select a currency for the small amount criteria.

ProCard Auto-Recon Options

Field or Control	Description
Allow system to match and populate PO data (allow system to match and populate purchase order data)	Select this check box to request that the system automatically match the transaction data with the existing purchase order information to populate purchase order data.

Criteria to Find Matching Purchase Orders

<i>Field or Control</i>	<i>Description</i>
Reconcile by Header	Select this check box to match the transactions with the purchase order header. The system attempts to match the entire purchase order information.
Reconcile by Line	Select this check box to match the transactions with the purchase order line.
Reconcile by Schedule	Select this check box to match the transactions with the purchase order line schedule.
Date Field	Select a date for the purchase order header, line, or schedule. To match by schedule, values are: <i>PO Date</i> and <i>Ship Date</i> .

Transactions Charged to a Supplier Card

<i>Field or Control</i>	<i>Description</i>
Set status to	Select a status when the purchase order amount is not the same as the amount on the statement but is within the tolerance percentages and when the purchase order amount equals the transaction amount. Values are: <i>Verified</i> , <i>Approved</i> , or the field is blank. If it is blank, the default status is <i>Staged</i> .
% Over (percentage over)	Enter a percentage for the upper limit that exceeds the matching amount.
% Under (percentage under)	Enter a percentage for the lower limit that falls short of the matching amount.

Transactions with a Valid PO ID (transactions with a valid purchase order ID)

<i>Field or Control</i>	<i>Description</i>
Set status to	Select a status when the purchase order amount is not the same as the amount on the statement but is within the tolerance percentages and when the purchase order amount equals the transaction amount. Values are: <i>Verified</i> , <i>Approved</i> , or the field is blank. If it is blank, the default status is <i>Staged</i> .

Field or Control	Description
% Over (percentage over)	Enter a percentage for the upper limit that exceeds the matching amount.
% Under (percentage under)	Enter a percentage for the lower limit that falls short of the matching amount.

Transactions without a Valid PO ID

Field or Control	Description
Set status to	Select a status when the purchase order amount is not the same as the amount on the statement but is within the tolerance percentages and when the purchase order amount equals the transaction amount. Values are: <i>Verified</i> , <i>Approved</i> , or the field is blank. If it is blank, the default status is <i>Staged</i> .
% Over (percentage over)	Enter a percentage for the upper limit that exceeds the matching amount.
% Under (percentage under)	Enter a percentage for the lower limit that falls short of the matching amount.

PO Statuses to Include

Select the purchase order statuses to be included for the transactions. You can select **Dispatched**, **Approved**, or both. The system only considers those purchase orders that include purchase order statuses. The default selects both **Dispatched** and **Approved**.

Staging Procurement Card Statements Using PeopleSoft Integration Broker

You can load procurement card statements in XML format to your CC_TRANS_EC staging tables using PeopleSoft Integration Broker. If your inbound statement file complies with neither VISA Commercial Format, MasterCard Custom Data File, nor US Bank data layouts, you can use this approach to load your statement file.

See the product documentation for *PeopleTools: Integration Broker*

Related Links

“PeopleSoft SCM Inbound EIPs” (PeopleSoft Supply Chain Management Integration)

Staging Procurement Card Statements in a Flat File Format

You can load procurement card statements in flat-file format to your CC_TRANS_EC staging tables. If your inbound statement file complies with neither VISA Commercial Format, MasterCard Custom Data File, nor US Bank data layouts, you can use this approach to load your statement file.

To receive the flat-file statement into your system, you must first define an inbound file rule. This rule enables you to use the Inbound File Publish process to load data into your CC_TRANS_EC staging tables.

Related Links

“PeopleSoft Electronic Data Interchange” (PeopleSoft Electronic Data Interchange)

Using the Credit Card Data EIP

This section provides an overview of the Credit Card Data EIP and discusses how to set up the Credit Card Data EIP.

Understanding the Credit Card Data EIP

The Credit Card Data EIP sends corporate card data to an external system.

Use this asynchronous full data publish and component publish EIP to provide your external customers with credit card data from your purchasing system.

It's first published using the full data utility, then incrementally when the component associated with it is saved.

Setting Up the Credit Card Data EIP

PeopleSoft delivers the service operations in PeopleSoft Integration Broker with a default status of *Inactive*. You must activate each service operation before attempting to send or receive data from a third-party source or another PeopleSoft system, such as CRM.

Before you can use the Credit Card EIP, you must:

1. Setup the service operation within PeopleSoft Integration Broker and Enterprise Components:

Use the information in the table below and refer to the setup instructions in the PeopleSoft Supply Chain Management Integration 9.2, "Implementing Integrations" topic, Setting Up Service Operations section.

Service Operation	Direction and Type	Handlers	Chunking Available?	Integrates With
CORPORATE_CARD_DATA_FULLSYNC	Inbound and Outbound Asynchronous	CorporateCard DataFullSync	No	third-party system
CORPORATE_CARD_DATA_SYNC	Inbound and Outbound Asynchronous	CORPORATE_CARD_DATA_SYNC	No	third-party system
CORPORATE_CARD_FULLSYNC	Inbound and Outbound Asynchronous	CorporateCardFullSync	No	third-party system
CORPORATE_CARD_SYNC	Inbound and Outbound Asynchronous	CorporateCardSync	No	third-party system

2. Address any special setup steps defined for this EIP

Using the Procurement Card Load EIP

This section provides an overview of the Procurement Card Load EIP and discusses how to use the Procurement Card Load EIP.

Pages Used to Use the Procurement Card Load EIP

Page Name	Definition Name	Usage
<u>Load Statement Page</u>	RUN_CC_LOADTRANS	Run the ProCard Load Statement process to load the statement lines from the staging table into the statement tables and to perform autoreconciliation using the settings defined on the Procurement Card Load Statement Options page.
Data Collection Setup Page	BCT_SETUP_FS	Set the option to keep transaction log history for electronic data collection transactions and to set the default file suffix.
“Data Def Maint Page” (PeopleSoft Supply Chain Management Integration)	EO_EIP_CTL_MAINT	View data detail or correct errors for service operations that contain data rather than transactions.

Understanding the Procurement Card Load EIP

The Procurement Card Load EIP is an asynchronous batch subscribe service operation that uploads procurement card statements from your procurement card suppliers.

Run the ProCard Statement Load Application Engine process (PO_CCLOADLD) to move the data from staging tables to application tables.

Using the Procurement Card Load EIP

PeopleSoft delivers the service operations in PeopleSoft Integration Broker with a default status of *Inactive*. You must activate each service operation before attempting to send or receive data from a third-party source or another PeopleSoft system, such as CRM.

Before you can use the Procurement Card Load EIP, you must:

1. Setup the service operation within PeopleSoft Integration Broker and Enterprise Components:

Use the information in the table below and refer to the setup instructions in the PeopleSoft Supply Chain Management Integration 9.2, "Implementing Integrations" topic, Setting Up Service Operations section.

Service Operation	Direction and Type	Handlers	Chunking Available?	Integrates With
PROCUREMENT_CARD_LOAD	Inbound Asynchronous	ProcurementCardLoad	No	third-party system

2. Run the ProCard Statement Load process to move the service operation data from the staging tables to application tables.
3. Use the Data Def Maint page to view service operation data and correct error messages that are picked up in the processing of the service operation.

Staging Standard Delivered Bank Format Statements

This section discusses how to run the ProCard Data Loader Application Engine process (PO_CCPRDSTG).

Page Used to Stage Standard Delivered Bank Format Statements

<i>Page Name</i>	<i>Definition Name</i>	<i>Usage</i>
<u>ProCard Stage Page</u>	RUN_CC_PCRDSTG	<p>Load the bank statement (transactions) into the staging tables using the ProCard Data Loader process. If the data source is VISA, it triggers the PO_CCVISA subprocess to load the Visa Commercial Format compliant data file.</p> <p>If the data source is US Bank, it triggers the PO_CCUSBANK subprocess to load the US Bank compliant data file.</p> <p>If the data source is US Bank 4.0, it triggers the PO_CCVISA subprocess to load the US Bank 4.0 compliant data file.</p> <p>If the data source is MasterCard, it triggers the PO_CCMC subprocess to load the MasterCard Custom Data Format compliant data file.</p>

ProCard Stage Page

Use the ProCard Stage page (RUN_CC_PCRDSTG) to load the bank statement (transactions) into the staging tables using the ProCard Data Loader process.

If the data source is VISA, it triggers the PO_CCVISA subprocess to load the Visa Commercial Format compliant data file. If the data source is US Bank, it triggers the PO_CCUSBANK subprocess to load the US Bank compliant data file. If the data source is US Bank 4.0, it triggers the PO_CCVISA subprocess to load the US Bank 4.0 Visa compliant data file. If the data source is MasterCard, it triggers the PO_CCMC subprocess to load the MasterCard Custom Data Format compliant data file.

Navigation:

Purchasing > Procurement Cards > Process Statements > Load PCard Stage > ProCard Stage

This example illustrates the fields and controls on the ProCard Stage page. You can find definitions for the fields and controls later on this page.

Field or Control	Description
Card Issuer	Select the credit card supplier that issues the credit card.
Data Source	<p>Select to determine what file layout to use. If the bank statement is in VISA Commercial Format, then you should select <i>VISA Commercial Format</i>. If the bank statement is in US Bank format, then you should select <i>USBank Layout</i> or <i>US Bank 4.0 Layout</i>. If the bank statement is in MasterCard format, then you should select <i>MasterCard Custom Data Format</i>.</p> <hr/> <p>Note: You can load transactions from the US Bank 4.0 Layout data source as well. The US Bank 4.0 Layout has the similar file layout as the VISA card.</p>
File Name	<p>Select the Attachment icon and upload the required file. To delete a file, select the Delete icon.</p> <hr/> <p>Note: The Run button is enabled only after you add an attachment. The button is disabled if the field is empty.</p>
Billing Date	<p>Today's date appears by default. Select the billing date to use for staging the statements.</p> <hr/> <p>Note: This field is only available for the Visa Commercial Format data source.</p>

<i>Field or Control</i>	<i>Description</i>
Load Level 3 Data	<p>This field selection appears by default from the Card Issuer page. It is display only and cannot be modified on this page.</p> <hr/> <p>Note: This check box only appears for Visa Commercial Format and the Master Card Custom Data Format data sources.</p> <hr/>

Related Links

[Card Issuer Page](#)

Handling Statement Staging Errors

This section discusses how to handle staging errors.

Staging errors can arise when loading your procurement card statement data to the staging tables. For example, you can use this page to address invalid credit card supplier information and invalid credit card numbers.

Page Used to Handle Statement Staging Errors

<i>Page Name</i>	<i>Definition Name</i>	<i>Usage</i>
Correct Errors Page	CC_STG_ERR	Correct errors for data in the staging table. Statement lines cannot be loaded in the statement tables if the credit card supplier or credit card account number are incorrect.

Correct Errors Page

Use the Correct Errors page (CC_STG_ERR) to correct errors for data in the staging table.

Statement lines cannot be loaded in the statement tables if the credit card supplier or credit card account number are incorrect.

Navigation:

Purchasing > Procurement Cards > Process Statements > Correct PCard Statement Errors

Field or Control	Description
Stage Error	Displays the type of staging errors. Values are: <i>Account</i> , <i>Supplier</i> , or <i>Both</i> . An account error indicates that the cardholder number is invalid or not on file. A supplier error indicates the supplier name is invalid in the supplier table. An error for both error refers to both the account and supplier error. If there's a stage error, the employee ID does not appear.

Loading Procurement Card Statements to Application Tables

This section provides an overview of the ProCard Load Statement process and discusses how to run the ProCard Load Statement process.

Page Used to Load Procurement Card Statements to Application Tables

Page Name	Definition Name	Usage
<u>Load Statement Page</u>	RUN_CC_LOADTRANS	Run the ProCard Load Statement process to load the statement lines from the staging table into the statement tables and to perform autoreconciliation using the settings that you defined on the Load Statement Options page.

Understanding the ProCard Load Statement Process

The ProCard Load Statement Application Engine process (PO_CCLOADLD) has different functions, including:

- Automatically reconcile between procurement card statements and Purchase Orders using the criteria you define on the Load Statement Options page and then loading those statements to application tables.
- Load the statements to be manually reconciled by you using the Reconcile Statement component.

Once statement lines have been loaded successfully, the status of the lines is set to *Staged*, and the statement lines are ready for review using the Reconcile Statement component. After loading the statement lines into the statement tables, you can run the Bank Statement workflow process to notify cardholders. However, you are not required to run that process. Each cardholder needs an email ID in order to be notified. For each bank statement line that has not been approved, the system sends an email message to the corresponding cardholder. If the status of the statement line is *Staged*, then it changes to *Initial*.

- Create prepayment vouchers for the procurement card statements.

After the ProCard Load Statement process runs it creates prepayment vouchers in the voucher staging tables. You will then need to run the Voucher Build process to create the prepayment voucher in PeopleSoft Payables.

- Perform budget validation for the statement lines.

This function validates the existing budget rows for the ChartField combinations associated with the procurement cards. This budget validation process has no budgetary impact nor does it validate remaining budget balances.

See [Understanding Commitment Control in PeopleSoft Purchasing](#).

- Calculate VAT amounts for the statement lines.

Reconciling Statements Automatically

The system reconciles the statement lines by reconciling:

- Transactions based on small amount criteria.
- Transactions charged to a supplier card.
- Transactions with a valid purchase order ID.
- Transactions without a valid purchase order ID.

Note: The primary purpose of the Load Statement Options page is to set up filters to copy purchase order data into the statement tables and set the statement status. For tighter commitment control, you can create purchase orders for procurement card purchases. The automatic reconciliation process reduces the manual efforts to reconcile between these two sets of transactions.

Reconciling Transactions Based on the Small Amount Criteria

To reconcile based on small amount criteria:

1. If the statement line involves a small amount and is not part of a purchase order, the system only considers the small amount criteria and assigns a statement status associated with **When billing amount is <=**.
2. If the statement line fails to meet any of the criteria, the status automatically changes to *Staged*.

Reconciling Transactions Charged to a Supplier Card

To reconcile transactions charged to a supplier card:

1. If there is a purchase order with a valid supplier card in the statement, the system automatically copies the entire purchase order including line, schedule, and distribution information into the statement tables.

Note: The information that the system copies from the purchase order includes sales tax and VAT information.

2. The system splits the statement lines automatically.

3. If there is a discrepancy between the statement line amount and the purchase order amount, the system prorates the purchase order amount with respect to the statement line amount, because the statement line amount is what you are liable to pay.
4. If the transaction amount matches the purchase order amount, the system assigns a statement status associated with **When purchase order amount is = billing amount**.

Because this is a perfect match, you can set the status to *Approved*, and the cardholder does not need to reconcile it manually.
5. If the purchase order amount is within the tolerance range (percentage over and percentage under), the system assigns a statement status associated with **When purchase order amount is within tolerances**.
6. If the statement amount is neither the same as the purchase order amount nor within the tolerance range, the system considers the small amount criteria and assigns a statement status associated with **When billing amount is <=**.
7. If the statement line fails to meet any of the criteria, the status automatically changes to *Staged*.

Reconciling Transactions with Purchase Order ID

To reconcile transactions with a valid purchase order ID:

1. If there is a purchase order with a valid ID in the statement, the system automatically copies the entire purchase order including line, schedule, and distribution information into the statement tables.

Note: The information that the system copies from the purchase order includes sales tax and VAT information.

2. The system splits the statement lines automatically.
3. If there is a discrepancy between the statement line amount and the purchase order amount, the system prorates the purchase order amount with respect to the statement line amount, because the statement line amount is what you are liable to pay.
4. If the transaction amount matches the purchase order amount, the system assigns a statement status associated with **When purchase order amount is = billing amount**.

Because this is a perfect match, you can set the status to *Approved*, and the cardholder does not need to reconcile it manually.
5. If the purchase order amount is within the tolerance range (percentage over and percentage under), the system assigns a statement status associated with **When purchase order amount is within tolerances**.
6. If the statement amount is neither the same as the purchase order amount nor within the tolerance range, the system considers the small amount criteria and assigns a statement status associated with **When billing amount is <=**.
7. If the statement line fails to meet any of the criteria, the status automatically changes to *Staged*.

Reconciling Transactions Without Purchase Order ID

To reconcile transactions without a valid purchase order ID:

1. If you do not select **Allow System to match and populate PO data**, the system does not attempt to copy purchase order information into the statement tables for these transactions.

If the statement line amount meets the small amount criteria, the system assigns a statement status accordingly. The distribution information comes directly from the cardholder profile.

2. If you select **Allow System to match and populate PO data**, the system attempts to match the statement line with purchase order by header, then by line, and finally by schedule based on the settings in the Load Statement Options.

If the match results in no purchase order or multiple purchase orders, the system does not bring in any purchase order information, and it uses the distribution information from the cardholder profile.

3. If there is a purchase order whose date and amount is the same as the transaction date and amount on a statement line, then the system brings in the entire purchase order information including line, schedule, and distribution.
4. If there is no purchase order with the same date and amount, but there is a purchase order with the same date and the amount is within tolerance range, then the system also brings in the entire purchase order information including line, schedule, and distribution.
5. If there are multiple purchase orders that meet the matching criteria, the system does not copy the purchase order information and must reconcile this statement line manually.

However, when you are reconciling this statement line manually those purchase orders become candidates for you to pick from on the purchase order information page.

6. If the statement line fails to meet any of the criteria, the status automatically changes to *Staged*.

In cases where there is no purchase order available to copy to the transaction, the system applies any field defaults from the appropriate defaulting hierarchy, including the cardholder profile and the VAT defaulting hierarchy, to complete the data on the Procurement Card transaction. These data elements are available to review and override on the Reconcile Statement - Procurement Card component.

Note: When a procurement card transaction is linked to a purchase order, all VAT default fields are copied from the purchase order. In cases where a purchase order is not linked to the transaction, the system uses the following logic to derive the **Ship To Address**, **Ship From Address**, and **Seller's Location** fields in order to complete the VAT defaulting and calculation process:

Ship To Address: Use the ship to address on the CC_TRANS_LINE table to derive the ship to country and state. This appears by default from the cardholder profile.

Seller's Location: If the merchant address is available in the CC_TRANS_LINE, use the merchant country and state to derive the seller's country and state. Otherwise, if the merchant supplier cross-reference exists, use the ordering address of supplier in the CC_TRANS_LINE to derive seller's country and state.

Ship From Address: If the merchant and supplier relationship does exist, use the default ship from location defined in the supplier to determine the **Ship From Country** and **State** fields. If this relationship is not available, the Merchant Address fields are used. Finally, if no merchant address was transmitted on the transaction, use the ship to address.

Load Statement Page

Use the Load Statement page (RUN_CC_LOADTRANS) to run the ProCard Load Statement process to load the statement lines from the staging table into the statement tables and to perform autoreconciliation using the settings that you defined on the Load Statement Options page.

Navigation:

Purchasing > Procurement Cards > Process Statements > Load PCard Statement

<i>Field or Control</i>	<i>Description</i>
Total Rows in the Staging Tables	Displays the number of statement line records in the staging table waiting to be loaded into the application table.
Total Rows with Error in the Staging Tables	Displays the number of statement line records that did not successfully load from the staging tables to the application tables after the ProCard Load Statement process. Use the Correct Errors page to view and handle these errors.
Total Rows to be Loaded	Displays the total number of records in the staging table that are ready to be loaded. This includes the total rows in the staging tables and the total rows with errors in the staging tables.
Delete Loaded Rows From the Staging Tables	Select this check box to delete statement line records from the staging table that were successfully loaded to the statement tables.

Running the Bank Statement Workflow Application Engine Process (PO_CCSTMT_WF)

This section lists the page used to run the Bank Statement Workflow process.

Page Used to Run the Bank Statement Workflow Application Engine Process

<i>Page Name</i>	<i>Definition Name</i>	<i>Usage</i>
Bank Statement Workflow Page	PO_CCSTMT_WF	Notifies the cardholder that the bank statement has arrived. Upon notification, you can reconcile the statement. The statement remains at the same status that it was before you ran the Bank Statement Workflow (PO_CCSTMT_WF) process.

Reconciling Procurement Card Transactions Manually

This section discusses how to Reconcile Procurement Card Transactions Manually:

Pages Used to Reconcile Procurement Card Transactions Manually

Page Name	Definition Name	Usage
<u>Reconcile Statement -Search Page</u>	CC_RECON_SRCH	Enter search criteria for the procurement card transactions you want to reconcile.
<u>Reconcile Statement - Procurement Card Transactions Page</u>	CC_RECON_WB	Review, manage, and approve procurement card transactions loaded by the Load Statement process. You can view all of the procurement card transactions that you have been granted authority to access on the Cardholder Profile - Card Data: Assign Proxies page.
Reconcile Statement - Merchant Details Page	CC_RECON_MERCHANT	Review merchant or preferred supplier cross-reference information.
ProCard VISA Trans Detail Reconcile Statement - Visa Transaction Details Page	CC_RECON_VISA	View the details of the Visa transaction.
ProCard MasterCard Trans Reconcile Statement - MasterCard Transaction Details Page	CC_RECON_MC	View the details of the MasterCard transaction.
Reconcile Statement - MasterCard Transaction Details Page	CC_RECON_MC_5300CU	View the details associated with the MasterCard transaction.
Reconcile Statement - Master Card Financial Adjustment Transaction Details Page	CC_RECON_MC5900	View details of adjustment transactions associated with the MasterCard transaction. <hr/> Note: The Adjustment Transactions – Type 5900 grid on the ProCard MasterCard Trans Reconcile Statement MasterCard Transaction Details page appears only if Load Level 3 Data (Purchasing) check box is selected. <hr/>
Reconcile Statement - Line Comments Page	CC_RECON_COMMENT	Enter comment text that remains with the associated procurement card transaction line.
<u>Reconcile Statement - Account Distribution Page</u>	CC_TRANS_DIST	Split accounting distributions or override defaults for a statement line. The key difference between this page and the Distribution Templates/Reset Status page is that this page affects one statement line at a time.

Page Name	Definition Name	Usage
Credit Card Distribution VAT Page	CC_TRANS_DIST_VAT	View the distribution VAT details that are associated with your procurement card transactions.
<u>Reconcile Statement - Purchase Details Page</u>	CC_RECON_PO	(Optional) Define any purchasing attributes applicable to a statement line.
Sales/Use Tax Page	CC_TRANS_SUT	Enter optional tax information related to the statement line. This data is not passed to PeopleSoft General Ledger and is for informational purposes only.
Category Search Page	CAT_SEARCH_SEC	Search for and select an appropriate category ID for the item when entering an ad hoc item. The search for the category ID is done using a category hierarchy tree.
View Category Hierarchy Page	CAT_PARENTAGE_SEC	View information about where a category resides in the entire catalog tree hierarchy.
Purchase Order Pick List Page	CC_POPICKLIST	Select a purchase order from a list of candidates that meet the criteria specified on the Procurement Card Load Statement Options page.
<u>Reconcile Statement - Split Transaction Page</u>	CC_RECON_SPLIT	Enter a description to supplement level-one information given by your card provider or split the original statement line into multiple lines where you can record details of each item purchased. To split accounting lines or override default values only, use the Reconcile Statement - Account Distribution page.
<u>Reconcile Statement - Distribution Template Page</u>	CC_RECON_TEMPLATE	Change accounting distributions for all of the selected lines at once. You might use this feature to assign the same Accounting Tag or (SpeedChart) to several statement lines from a particular merchant.
Credit Card Transaction Line VAT Page	CC_TRANS_LINE_VAT	View the VAT line details that are associated with your procurement card transactions.

Page Name	Definition Name	Usage
Account Summary Page	RUN_POY8050	Run one of these multiprocess jobs: Purchase Summary by Issuer (POY8050) which will generate the Purchase Summary by Issuer report (POX8050), Purchase Summary by Merchant (POY8051) which will generate the Purchase Summary by Merchant report (POX8051), or Purchase Summary by Employee (POY8052) which will generate the Purchase Summary by Employee report (POX8052)
Purchase Details Page	RUN_POY8030	Run one of these multiprocess jobs: Purchase Detail by Issuer (POY8030) which will generate the Purchase Detail by Issuer report (POX8030), Purchase Detail by Merchant (POY8031) which will generate the Purchase Detail by Merchant report (POX8031), or Purchase Detail by Employee (POY8032) which will generate the Purchase Detail by Employee report (POX8032)

For Information on Reports See [PeopleSoft Purchasing Reports](#)

Reconcile Statement -Search Page

Use the Reconcile Statement Search page (CC_RECON_SRCH) to enter search criteria for the procurement card transactions you want to reconcile.

Navigation:

Purchasing > Procurement Cards > Reconcile > Reconcile PCard Statement

This example illustrates the fields and controls on the Reconcile Statement Search page You can find definitions for the fields and controls later on this page.

Reconcile PCard Statement

Reconcile Statement Search

Role Name

▼

Employee ID

🔍

Name

🔍

Business Unit

🔍

Card Issuer

▼

Card Number

Transaction Number

Merchant

 Exact Match

Sequence Number

Line Number

Billing Date

🔍
To

🔍

Statement Status

▼

Budget Status

▼

Chartfield Status

▼

Transaction Date

📅
To

📅

Charge Type

▼

Posted Date

📅
To

📅

Rows Per Page

50

Auto Save When Scrolling Through Chunks

Search

Clear

Field or Control	Description
Role Name	Select the role name that you want to filter the report by. The roles available for selection are those roles that belong to the current user that also have cards assigned to them. It does not include those roles that have no cards assigned to them.

Field or Control	Description
Employee ID	Select the employee ID of the employee whom the transaction is for.
Name	Displays the name of the employee associated with the Employee ID entered.
Business Unit	Select the Business Unit you want to use to filter the report.
Card Issuer	Select the card issuer. In most cases, this is the name of the bank that issues the card. The Card Issuer field is Business Unit dependent. To enable this field, you must select a Business Unit.
Card Number	Enter the card account number. After you enter the full card number, the system will encrypt the card number and display the masked card number in this field. For example, if you enter 6755-8867-8901-2015, the system will display *****2015 as the masked card number. The number of digits that are visible for the card number is based on the Number of Digits to Display field setting you specify on the Installation Options - Purchasing page.
Transaction Number	Displays the last transaction number used in the transaction log. The system uses the transaction number to automatically generate a unique number for each transaction added to the transaction log from the transaction pages.
Merchant	Enter a merchant from where you want to source the goods or services.
Exact Match	This check box is associated with the Merchant and by default is selected. Enter a value in the Merchant field that exactly matches the intended search value. Deselect the check box and enter a value in the Merchant field if you want the search to ignore upper and lower case characters while searching. The system returns results based on a partial match of the string entered.
Sequence Number	Enter a sequence number for this attribute.
Billing Date (From) and To	Select the starting and ending point of the billing date range.
Statement Status	Select the statement line status. Values are: Staged, Initial, Verified, Approved, Closed, Error or Processing.
Budget Status	Displays the budget checking status if budget checking is enabled.

Field or Control	Description
Transaction Date (From) and To	Select the start date and end date for the transaction date range. By default, the system displays the current date for the To date and subtract the Transaction Date Days to determine the From Date. The Transaction Date Days is setup on the “Installation Options - Purchasing Page” (Application Fundamentals)
Charge Type	Select a charge type. Values are: New Charge, Other credits, Other debits and Payments.
Posted Date (From) and To	Select the starting and ending point of the posted date range.
Rows Per Page	Displays the default value taken from Maximum Rows settings for the Procurement Card Reconcile Statement on the “Installation Options - Purchasing Page” (Application Fundamentals) Users can change the rows per page to help manage productivity.
Auto Save When Scrolling Through Chunks	This option is available when Rows Per Page is not blank. When selected, any changes made to existing transaction lines will be automatically saved without a warning message when scrolling through chunks. Users can get through quick updates and proceed to the next chunk without having to click through a save warning message. When deselected, the user will receive a save ‘warning’ message when scrolling if any of the current data has changed.
Clear	Click the Clear button to erase all search criteria.

Reconcile Statement - Procurement Card Transactions Page

Use the Reconcile Statement - Procurement Card Transactions Page (CC_RECON_WB) to enter search criteria for the procurement card transactions you want to reconcile.



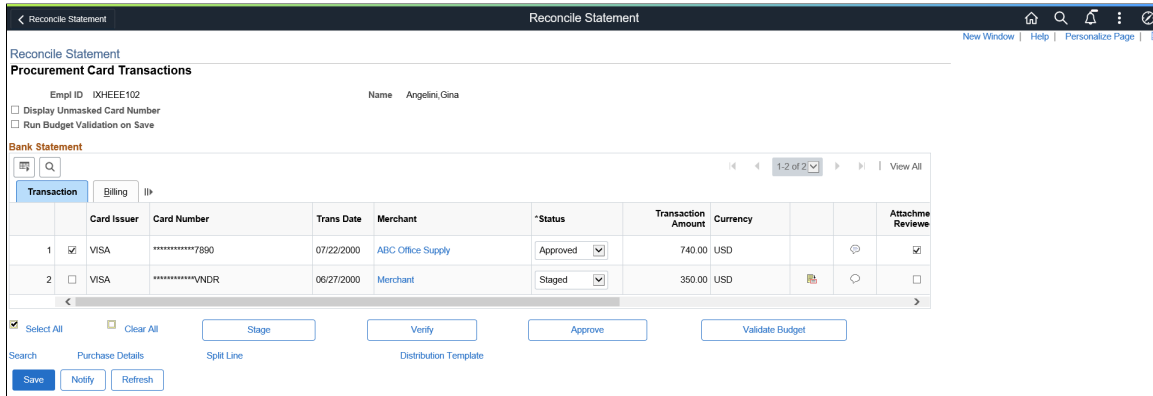

Navigation:

Purchasing > Procurement Cards > Reconcile > Reconcile PCard Statement > Reconcile Statement Search

This example illustrates the fields and controls on the Reconcile Statement Procurement Card Transactions Page. You can find definitions for the fields and controls later on this page.





Chunking Scroll Icons

Field or Control	Description
	Click the First icon to go to the first chunk (first set of rows). This icon is disabled when already on the first chunk.
	Click the Previous icon to go back to the previous chunk. This icon is disabled when already on the first chunk.
	Click the Next icon to go to the next chunk. This icon is disabled when already on the last chunk.
	Click the Last icon to go to the last chunk. This icon is disabled when already on the last chunk.
Chunking Scroll Counters	Displays directly above the scroll icons to indicate how many transaction lines are available as well as which rows are currently being displayed.

The chunking scroll icons are displayed when the number of rows returned exceeds the value in the Rows Per Page field. Users can scroll through each chunk of data using these icons. New, saved lines (lines created from Split Lines or PO association) are always added to the current chunk of data. When this occurs, the number of lines may exceed the value in the Rows Per Page field.

Note: It is not recommended for a user to employ chunking in the Reconcile Statements simultaneously in two separate windows or session (by alternating between those two windows/sessions). The system saves the data temporarily in the chunking table until a new search is conducted.

Transaction

Field or Control	Description
Merchant	Click the linked merchant name to access the Reconcile Statement - Merchant Details page. Use this page to view the source of the purchased goods.
	<p>Click the Line Details button to access the ProCard VISA Trans Detail Reconcile Statement - Visa Transaction Details, ProCard MasterCard Trans Reconcile Statement - MasterCard Transaction Details pages, or ProCard US Bank 4.0 Trans Detail Reconcile Statement – US Bank 4.0 Transaction Details. Use these pages to view the details for the Visa or MasterCard transaction.</p> <hr/> <p>Note: The Line Details button is only available when load level 3 data is on when loading with Visa, MasterCard, or US Bank 4.0 data files.</p>
	<p>Click the Comments and Attachments icon to enter comments and upload attachments for the reconcile statement line. When you enter a comment or upload an attachment, the empty callout icon changes to an icon with text.</p> <p>If you have selected the Receipt Required check box on the Purchasing Definition - Business Unit Options page and entered the Threshold Amount, a message displays when the Transaction Amount on the Reconcile Statement page exceeds the threshold amount. To proceed with saving the transaction, you must attach a receipt.</p> <p>For information on the Receipt Required check box, see Purchasing Definition - Business Unit Options Page.</p>
Attachment Reviewed	<p>The Attachment Reviewed check box is available only when the Reconcile – Reviewed Attachments access rights are granted on the Procurement Card Access Rights page. The check box indicates that the attachment has been reviewed. It appears irrespective of the attachment exists or not.</p> <p>For information, see Procurement Card Access Rights Page.</p>
	Click the Distribution button to access the Reconcile Statement - Account Distribution page, where you can modify the account distribution for a procurement card.
ChartField Status	Displays the status of the ChartField edits.

Billing

Select the Billing tab.

Field or Control	Description
Description	Enter additional information about the goods purchased.
Billing Amount	Displays the amount billed on the statement line.
Prepaid Ref (prepaid reference)	Displays the prepayment voucher associated with the transaction.
Dispute Amount	If your records disagree with the billing amount, enter the amount difference. This does not mean that your organization is not liable for the purchase, but rather acts as a notation that the user reconciling this account must follow up with the merchant or procurement card supplier to settle the disputed amount. If you enter an amount, the statement line is visible on the Review Disputes - Dispute page until it has been identified as collected.
Credit Collected	Displays the status of the disputed amount. If clear, the dispute is still open. If selected, the dispute has been identified as collected or closed on the Review Disputes - Dispute page.

VAT

Select the VAT tab.

Field or Control	Description
Physical Nature	Displays whether the purchased item is a good or service.
VAT Entity	Displays the VAT entity associated with PeopleSoft General Ledger business unit from the PeopleSoft Purchasing business unit.
Entered VAT Amount	Displays the amount of VAT included on the statement line.
VAT Calculated Amount	Displays the amount of VAT that the system calculates.

Field or Control	Description
Claiming Tax Credit	Indicates whether the statement line is to be used as proof for recovery of VAT. This field is automatically selected if statements issued by the card provider are defined as approved VAT receipts for the VAT reporting country. If you select this field, no additional VAT receipt is required to enable VAT recovery and rebate amounts to be calculated. If this field is not selected, you must indicate that a separate VAT receipt is available to enable the calculation of VAT recovery and rebate amounts.
No VAT Receipt	If the Claiming Tax Credit check box is not selected, this field indicates whether a separate VAT receipt is available as proof for recovery of VAT. Select this field to indicate that no VAT receipt is available. This causes zero VAT recovery and rebate amounts to be recorded.
	Click the Line VAT button to navigate to the Credit Card Transaction Line VAT page to review and possibly change the line VAT information.

Updating Transaction Status

You can change the status of a card transaction for individual lines or for many lines in mass.

To update the status of an individual line, select a value in the **Status** field.

To update the status for multiple lines at once, click the check box next to each line and use the buttons at the bottom of the Reconcile Statement - Procurement Card Transactions page to change the status to the appropriate value. You have authority to change statuses based on your procurement card roles and access rights granted to those roles defined on the Procurement Card Access Rights page.

Performing Budget Validation on Transactions

There are two ways to perform budget validation against transactions on this page if you are using commitment control. You have the option to perform budget validation on all the transactions when you save the page or you can select transactions and then perform budget validation on those transactions when you click the **Validate Budget** button.

Note: The Run Budget Validation on Save check box and the Validate Budget button only appear on this page if you are using commitment control for procurement cards.

Field or Control	Description
<p>Run Budget Validation on Save</p>	<p>Select to indicate that you want the system to initiate the Comm. Cntrl. Budget Processor (commitment control budget processor) Application Engine process (FS_BP) when you save the page. This page initiates the Comm. Cntrl. Budget Processor process but only a portion of the processing (budget validation) within that process is performed. This process validates the existing budget rows for the ChartField combinations associated with the procurement cards.</p> <p>This process has no budgetary impact nor does it validate remaining budget balances and finds errors in the ChartField combinations before they are found downstream in accounts payable.</p> <p>After budget validation is finished, the system will change the budget status on the transactions to either <i>Valid</i> or <i>Error</i>.</p>
<p>Validate Budget</p>	<p>After you select one or more transactions click this button to initiate the Comm. Cntrl Budget Processor process. By clicking this button you initiate the Comm. Cntrl. Budget Processor process but only does a portion of the processing (budget validation) within that process is performed. This process validates the existing budget rows for the ChartField combinations associated with the procurement card. This process has no budgetary impact nor does it validate remaining budget balances.</p> <p>When you click this button, the page will indicate that the process is being performed. The page will flash "processing" until the process has finished performing the budget validation for the document. After the process is finished, the system will change the budget status on the transactions to either <i>Valid</i> or <i>Error</i>.</p> <hr/> <p>Note: You can still click this button for specific transactions even if the Run Budget Validation on Save check box is selected.</p> <hr/>

Related Links

“Understanding VAT” (PeopleSoft Global Options and Reports)

[Budget Checking Procurement Cards](#)

Reconcile Statement - Account Distribution Page

Use the Reconcile Statement - Account Distribution page (CC_TRANS_DIST) to split accounting distributions or override defaults for a statement line.

The key difference between this page and the Distribution Templates/Reset Status page is that this page affects one statement line at a time.

Navigation:

Click the **Distribution** button on the Reconcile Statement - Procurement Card Transactions page.

Field or Control	Description
Unit Price	Displays the cost of the item purchased on the selected statement line.
SpeedChart	<p>Select a predefined distribution template to apply to the statement line.</p> <hr/> <p>Note: The field is enabled only when the default option is set to <i>override</i>.</p> <hr/> <p>Note: Accounting Tag field appears in lieu of Speedcharts when the Accounting Tag check box is selected for Purchasing on the Accounting Tag Registration page. See “Accounting Tag Registration Page” (Application Fundamentals)</p>
Accounting Tag	<p>Click the prompt to select appropriate Accounting Tags that will be used to populate ChartFields on transaction distribution lines. The system automatically prorates the amount of an accounting line according to the proration percentages defined on the Accounting Tag.</p> <hr/> <p>Note: Accounting Tag field appears in lieu of Speedcharts when the Accounting Tag check box is selected for Purchasing on the Accounting Tag Registration page. See “Accounting Tag Registration Page” (Application Fundamentals).</p>

ChartFields

You can manually override the distribution information for the statement line by changing any of the distribution field values in the scroll area.

Note: Once a purchase order is referenced by procurement card transactions you are no longer able to modify the ChartFields or liquidate method on this page.

Note: If the procurement card transaction is associated with a PeopleSoft Maintenance Management work order you are not able to modify the PeopleSoft General Ledger business unit, project related fields (PeopleSoft Project Costing business unit, project, and activity), and asset information.

Details/Tax

Select the Details/Tax tab.

Field or Control	Description
SUT Applicable (sales and use tax applicable)	Tax method applied to the statement line. Appears by default from the Sales/Use Tax page.
Sales/Use Tax % (sales and use tax percentage)	Tax percentage that the system uses to calculate the use tax for the statement line.
Use Tax	Calculated tax amount for the statement line. Appears by default from the Sales/Use Tax page.

Reconcile Statement - Purchase Details Page

Use the Reconcile Statement - Purchase Details page (CC_RECON_PO) to (Optional) Define any purchasing attributes applicable to a statement line.

Navigation:

Click the **Purchase Order** link on the Reconcile Statement - Procurement Card Transactions page.

Field or Control	Description
Original PO	The value of this field is <i>Y</i> (yes) if the purchase order ID came from a transaction on the bank statement. If the purchase order ID is missing or is generated by the system during the Auto Recon process, the value in this field is <i>N</i> (no). You can only modify the purchase order related data if the field value is <i>N</i> .
PO ID	<p>Displays the purchase order number associated with the statement line. This purchase order number is either an original purchase order on the bank statement, one that is populated by the system during the auto reconciliation process, or entered directly by the cardholder.</p> <hr/> <p>Note: Once a purchase order has been vouchered it is unavailable for selection on this page. If this credit card has never been used on purchase orders, then all qualified purchase orders will be listed in the prompt. However, if this credit card has been used on purchase orders, then only those purchase orders paid by this card will be available in the prompt.</p> <hr/>

Field or Control	Description
PO Line	<p>Displays the line number of a purchase order. As soon as you select the line number, the Supplier ID, Location, Ship To, Item ID, and Category field values are populated.</p> <hr/> <p>Note: If the Merchandise amount of the selected purchase order line exceeds the Transaction Amount, a warning message displays. To proceed with the selection, click Yes. If you click No, the PO ID and PO Line fields become blank. Select another line and proceed.</p> <hr/>
PO Sched (purchase order schedule)	Displays the schedule number of a purchase order.
Supplier ID	Select a Supplier ID for either a 1099 merchant or non-1099 merchant. At times, a procurement card may be used to purchase services from a 1099 merchant. Identifying the 1099 merchant as an authorized supplier ensures that you establish a valid tax reporting ID for the supplier. You can also set up suppliers that are non-1099 merchants. Identifying the non-1099 merchant supplier may be useful when renegotiating corporate contracts with a supplier.
Location	Select the location address for the supplier.
Ship To	Enter the shipping address.
Item ID	For reporting, select an item ID that represents the internally classified part number for goods purchased with the procurement card.
Category	If you do not want to enter an item ID, you can select an applicable item category for reporting purposes.
Supplier Item	For reporting purposes, enter the supplier item ID.
Unit Price	Displays the cost of the goods on the statement line.
Bill Includes Tax if Applied	This check box setting appears by default from the Procurement Card Issuer page.
Tax Paid	Select this check box to designate that tax was paid to the merchant at the point of sale. If tax was paid, no further documentation is required.

Maintenance WO (maintenance work order)

If the purchase order selected is associated with a PeopleSoft Maintenance Management work order the fields in this section will appear. You can modify the work order information that appears on this page or you can enter the work order information using this page.

Field or Control	Description
WO Business Unit (PeopleSoft Maintenance Management business unit)	Select the PeopleSoft Maintenance Management business unit associated with the work order you want to associate with the procurement card transaction.
Work Order ID	Select the work order you want to associate with the procurement card transaction.
Task Number	Select the task number associated with the work order.
Resource Type	Select the resource type associated with the work order. Types are: <i>Labor</i> , <i>Material</i> , and <i>Tools</i> .
Resource Line No.	Select the resource line number associated with the work order.

After you enter the work order information, the system will populate the account distributions on the Reconcile Statement - Account Distributions page based on the work order distribution template.

Sales/Use Tax Page

Use the Sales/Use Tax page (CC_TRANS_SUT) to enter optional tax information related to the statement line.

This data is not passed to PeopleSoft General Ledger and is for informational purposes only.

Navigation:

Click the **Sales/Use Tax** link on the Reconcile Statement - Purchase Details page.

Field or Control	Description
Tax Applicability	<p>Select the tax applicability for the statement line. Most procurement card purchases typically use the sales or use tax method. Values are:</p> <p><i>Direct Pay:</i> Use tax is not calculated on the purchase order. The invoice is not created with use tax, but a line is written to the general ledger for the amount that the buyer pays directly to the state.</p> <p>The use tax amount is calculated and displays on the Sales/Use Tax Information For Schedule page and the Sales/Use Tax Details For Distribution page. The use tax amount will not display on the Maintain Purchase Order - Purchase Order page or the PO Total Amount Details page.</p> <p><i>Exempt:</i> Item purchased is exempt from sales and use tax.</p> <p><i>Exonerated:</i> Buyer does not have to pay sales tax. Tax is not calculated on the purchase order and PeopleSoft Payables does not pay taxes.</p> <p><i>Sales Tax:</i> Calculate and apply sales tax on the purchase order.</p> <p><i>Use Tax:</i> Calculate and apply use tax on the purchase order.</p>
Tax Destination	<p>Select the location code of the final destination where the purchased goods are to be used. The system calculates sales and use tax amounts based on this information.</p>
Tax Code	<p>Enter the tax code. The tax code determines tax rate (or the sales and use tax code percent) used in the tax calculation.</p>
SUT Code Pct (sales and use tax code percentage)	<p>If you do not know the SUT destination or the tax code, you can enter the tax percent for the transaction.</p>
Use Tax	<p>If you entered the correct tax code information or SUT code percentage, it calculates and displays the use tax.</p>

Reconcile Statement - Split Transaction Page

Use the Reconcile Statement - Split Transaction page (CC_RECON_SPLIT) to enter a description to supplement level-one information given by your card provider or split the original statement line into multiple lines where you can record details of each item purchased.

To split accounting lines or override default values only, use the Reconcile Statement - Account Distribution page.

Navigation:

Click the **Split Line** link on the Reconcile Statement - Procurement Card Transactions page.

This example illustrates the fields and controls on the Reconcile Statement - Split Transaction page. You can find definitions for the fields and controls later on this page.

ProCard Transaction Splits

Line 1

Trans Date 07/22/2000 Billing Amount 740.00 USD

Posted Date 07/01/2000 Reference

Merchant ABC Office Supply

Description

Split Rules Personalize | Find | View All | | First 1 of 1 Last

Description	Transaction Amount	Billing Amount	Percentage	
Transaction Split	740.00	740.00	100.000000	+ -

Field or Control	Description
Description	Enter text describing the purchase reflected on the line. You may want to state what item was actually purchased.
Billing Amount	If you have split the transaction by description and want to split the line by amount as well, enter the appropriate amounts in this field for each line. However, the amounts must add up to the original amount.
Percentage	If you have split the transaction by description and want to split the line by percentage as well, enter the appropriate percentages in this field for each line. However, the percentages must add up to 100%.

Reconcile Statement - Distribution Template Page

Use the Reconcile Statement - Distribution Template page (CC_RECON_TEMPLATE) to change accounting distributions for all of the selected lines at once.

You might use this feature to assign the same Accounting Tag or (SpeedChart) to several statement lines from a particular merchant.

Navigation:

Click the **Distribution Template** link on the Reconcile Statement - Procurement Card Transactions page.

Field or Control	Description
SpeedChart	<p>Select the SpeedChart to assign to the distributions of all selected statement lines. Alternatively, you can manually assign distributions for all selected lines by entering distribution information.</p> <hr/> <p>Note: Accounting Tags appear in lieu of Speedcharts when the Accounting Tag check box is selected for Purchasing on the Accounting Tag Registration page. See “Setting Up Accounting Tags” (Application Fundamentals)</p>
Accounting Tag	<p>Enter an Accounting Tag that will be used to populate ChartFields on transaction distribution lines. The system automatically prorates the distribution amounts according to the proration percentages defined on the Accounting Tag.</p> <hr/> <p>Note: Accounting Tags appear in lieu of Speedcharts when the Accounting Tag check box is selected for Purchasing on the Accounting Tag Registration page. See “Setting Up Accounting Tags” (Application Fundamentals)</p>

Credit Card Transaction Line VAT Page

Use the Credit Card Transaction Line VAT page (CC_TRANS_LINE_VAT) to view the VAT line details that are associated with your procurement card transactions.

Navigation:

Click the **Line VAT** button on the Reconcile Statement - Procurement Card Transaction page.

Expanding and Collapsing Sections

To manage your VAT data more efficiently, you can expand and collapse sections to this page, which makes it easier for the user to manage.

Field or Control	Description
Expand All Sections	<p>Click the expand button to scroll to and access every section on the page. You can also expand one or more sections by clicking the arrow next to the section's name.</p>
Collapse All Sections	<p>Click to collapse all sections displaying only the header information. If you expand one or more sections, you can click the arrow next to the section's name to collapse the section.</p>

Physical Nature

<i>Field or Control</i>	<i>Description</i>
Physical Nature	Displays the default physical nature for transactions. Values are: <i>Goods</i> or <i>Services</i> .

VAT Locations

<i>Field or Control</i>	<i>Description</i>
Ship From Country	Displays the supplier ship from location country. In the case of transactions involving goods or freight service transactions, this determines the VAT treatment.
Ship From State	If the ship from country is defined as tracking VAT by state or province, it displays the supplier ship from location state. In the case of transactions involving goods or freight service transactions, this determines the VAT treatment.
Ship to Country	Displays the ship to location country. In the case of transactions involving goods or freight service transactions, this is used to determine the VAT treatment.
Ship to State	If the ship to country is defined as tracking VAT by state or province, it displays the ship to location state. In the case of transactions involving goods or freight service transactions, this is used to determine the VAT treatment.

VAT Defaults

<i>Field or Control</i>	<i>Description</i>
Service Type	If the transaction is for a service, it displays the VAT service type of <i>Freight</i> or <i>Other</i> . The value in this field determines whether or not the special rules for freight transport within the European Union apply. The default value comes from the PeopleSoft Purchasing VAT defaulting hierarchy.

Field or Control	Description
Place of Supply Driver	If the transaction is for a service, it displays the usual place of supply (such as the place where VAT is usually liable) for the service. This value helps to determine the place of supply country and the VAT treatment. Values are: <i>Buyer's Countries</i> , <i>Supplier's Countries</i> , or <i>Where Physically Performed</i> . The default value comes from the PeopleSoft Purchasing VAT defaulting hierarchy.
Reporting Country	Displays the country for which this VAT is to be reported. This is the VAT Entity VAT registration country and determines many of the VAT defaults.
Defaulting State	If the reporting country requires that VAT be tracked by state or province, this field displays the state within the reporting country that is used to retrieve values from the VAT Defaults table.
Supplier Registration Country and Supplier Registration ID	Displays the registration country and ID of the supplier.
Exception Type	Displays the exception granted to the VAT entity. Values are: <i>None</i> , <i>Exonerated</i> , or <i>Suspended</i> . This value is specified on the VAT entity registration.
Certificate ID	If applicable, displays the ID of the VAT exception certificate that may have been issued to the VAT entity.
Calculate at Gross or Net	Indicates how VAT is calculated. Values are: <i>Gross</i> : The system calculates VAT before it applies any early payment discounts. <i>Net</i> : The system calculates VAT after it deducts early payment discounts. If there are two percentage discounts, the system uses the larger of the two when it calculates VAT. The system does not use discount amounts, only discount percentages. The default value comes from the VAT entity registration driver.
Recalculate at Payment	Select this check box to enable the recalculation of VAT at payment time to allow for any early payment discounts, if you are calculating VAT at gross. This causes the system to adjust the VAT amount at the time of payment if the discount has been taken. This is set on the VAT entity registration driver.

Field or Control	Description
Declaration Point	<p>Displays the declaration point for a good or service when you want VAT transaction information to be recognized for reporting purposes. Values are:</p> <p><i>Invoice:</i> VAT is recognized at time of invoice.</p> <p><i>Payment:</i> VAT is recognized at time of payment.</p> <p><i>Delivery:</i> VAT is recognized on delivery.</p> <p>This value may be set at several levels in the VAT hierarchy: VAT entity registration, business unit options, supplier, or supplier location.</p>
Rounding Rule	<p>Displays the VAT rounding rule. The value comes from the VAT country, VAT entity, supplier or supplier location drivers. Values are:</p> <p><i>Natural Round:</i> Amounts are rounded normally (up or down) to the precision specified for the currency code. For example, for a currency defined with two decimal places, 157.4659 would round up to 157.47, but 157.4649 would round down to 157.46.</p> <p><i>Round Down:</i> Amounts are rounded down. For example, for a currency defined with two decimal places, 157.4699 would round down to 157.46.</p> <p><i>Round Up:</i> Amounts are rounded up with a rounding precision to one additional decimal place. For example, for a currency defined with two decimal places, 157.4659 would round up to 157.47, but 157.4609 would round down to 157.46.</p>
Use Type	<p>Determines the split between recoverable (taxable) and nonrecoverable (nontaxable) VAT.</p> <p>For Canadian public sector, the use type also determines the rebate of the nonrecoverable VAT. VAT rebates are calculated based on statutory rebate rates that are established for each public service body.</p> <p>The value comes from the VAT defaulting hierarchy, either from the item, item business unit, item category, supplier location, supplier, or purchasing options.</p>

Field or Control	Description
Include Freight	If selected, the system includes any freight amounts in the VAT basis by calculating VAT on the merchandise amount, plus any freight amount. This option is only available for exclusive VAT calculation. The value comes from the VAT entity registration driver.
Include Miscellaneous	If selected, the system includes any miscellaneous charge amounts in the VAT basis by calculating VAT on the merchandise amount, plus any miscellaneous charge amount. This option is only available for exclusive VAT calculation. The value comes from the VAT entity registration driver.
No VAT Receipt	If the Claiming Tax Credit check box is not selected, this field indicates whether a separate VAT receipt is available as proof for recovery of VAT. Select this field to indicate that no VAT receipt is available. This causes zero VAT recovery and rebate amounts to be recorded.
Domestic Reverse Charge Goods	Select whether to indicate that the goods on transaction lines associated with the VAT driver are domestic reverse charge goods.
Place of Supply Country	Displays the country in which the VAT is liable. An algorithm determines the default value.

Field or Control	Description
Treatment	<p>Displays the VAT treatment. Complex algorithms determine the VAT treatment. Values are:</p> <p><i>Domestic Goods Purchase:</i> If the ship from and ship to countries are the same, and the supplier is registered for VAT, the transaction is treated as domestic.</p> <p><i>Domestic Service Purchase:</i> If the buyer and seller are both located in the country where the VAT is liable, the transaction is treated as domestic</p> <p><i>EU Goods Purchase:</i> If the ship from and ship to countries are different, the system determines whether both countries are located within the European Union. If so, the system looks at the VAT registration for each trading partner to determine whether the transaction should be treated as an intra-European Union purchase, domestic, or outside the scope of VAT.</p> <p><i>EU Service Purchase:</i> If each trading partner is located and registered in different European Union countries, and the VAT on a service is liable in the buyer's country, the transaction is treated as a self-assessed European Union services purchase.</p> <p><i>Self-Assess Goods Import:</i> If the ship from country is different from the ship to country and either or both of the countries are located outside of the European Union, and the supplier is not registered in the ship to country, the transaction would be treated as an import. If the flag on the entry in the VAT Country table for the VAT reporting country indicates that VAT on imports should be self-assessed, the transaction is treated as a self-assess goods import, and both input and output VAT are recorded.</p> <p><i>Self-Assess Service Import:</i> If each trading partner is located and registered in different countries, and the VAT on a service is liable in the buyer's country, the transaction is treated as a self-assessed services import.</p> <p><i>Zero-rated Goods Import:</i> If the ship from country is different from the ship to country and either or both of the countries are located outside of the European Union, and the supplier is not registered in the ship to country, the transaction would be treated as an import. If the flag on the entry in the VAT Country table for the VAT reporting country indicates that only input VAT should be recorded on imports, the transaction is to be treated as a zero-rated goods import.</p> <p><i>Outside of Scope:</i> If the supplier is not registered for VAT, or if the VAT is liable in a country other than the VAT reporting country, the transaction is treated as outside the scope of VAT.</p>

Field or Control	Description
	<p><i>No VAT Processing:</i> For transactions where the physical nature is goods, if the ship to country has not been defined as a VAT country and the VAT reporting country on the transaction is blank, no VAT information is recorded.</p> <p>Within PeopleSoft detail, VAT treatment values on the transaction lines are used to apply the precise defaults applicable to the transaction lines. The treatment is determined based the rules that are applicable to the transaction.</p>
Applicability	<p>Displays the VAT status. Values are:</p> <p><i>Taxable</i></p> <p><i>Exempt</i> (not subject to VAT)</p> <p><i>Outside of Scope of VAT</i></p> <p><i>Suspended</i></p> <p><i>Exonerated</i></p> <p><i>Not Applicable</i> (valid only when VAT treatment is no VAT processing)</p>
VAT Code	<p>Displays the VAT code that defines the rate at which VAT is calculated for this line.</p>
Tax Rate	<p>Displays the rate at which the transaction is charged VAT.</p>
Transaction Type	<p>Displays the code that categorizes and classifies this transaction for VAT reporting and accounting.</p>

Adjust/Reset VAT Defaults

Any changes that you make to fields on this page may affect VAT defaults on this page. For accuracy and consistency, use the following fields to adjust affected VAT defaults or to reset all VAT defaults. Adjusting or resetting VAT defaults only affects fields within the **VAT Defaults** group box.

Field or Control	Description
Adjust Affected VAT Defaults	<p>Click this button to have the system adjust the VAT defaults that are affected by your changes. All changes that you have made to VAT defaults on this page that affect other VAT defaults on this page are retained.</p> <p>Click the i button to list the fields that are to be adjusted.</p> <hr/> <p>Note: PeopleSoft recommends that you always click the Adjust Affected VAT Defaults button after changing any defaults on the VAT page.</p> <hr/>
Levels	<p>Use to specify the levels to reset when you click the Reset All VAT Defaults button. Values are:</p> <p><i>All lower levels:</i> Resets all VAT defaults at lower levels for this page.</p> <p><i>This and all lower levels:</i> Resets all VAT defaults on this page and at any lower levels of this page.</p> <p><i>This level only:</i> Resets all VAT defaults on this page.</p>
Reset All VAT Defaults	<p>Click to have the system reset the VAT defaults based on the levels value that you selected. Any changes that you have previously made to VAT defaults is lost.</p> <hr/> <p>Note: Reset all VAT Defaults completely redetermines the VAT defaults. This does not necessarily mean that they are reset to their original values. For example, the user may not have changed any VAT default values, but if a VAT driver field changes, reset redetermines all of the defaults based on the new driver value.</p> <hr/>

VAT Calculations

Field or Control	Description
Basis Amount	Displays the amount on which the VAT is calculated in the transaction currency. If VAT is being calculated at net, this amount is net of any discounts.
Calculated Amount	Displays the system calculated VAT amount in the transaction currency.

Field or Control	Description
Override VAT Amount	<p>Displays the amount of VAT stated on the credit card statement.</p> <p>This is the amount transmitted by the merchant on the inbound credit card statement. This amount is compared to the system-calculated VAT amount. If the override VAT amount is outside of the calculated VAT amount, plus the VAT tolerance amounts defined on the VAT driver tables for procurement cards, an exception is noted in the field for the tax dispute amount.</p>

Related Links

“Understanding VAT” (PeopleSoft Global Options and Reports)

Running the Grace Period Has Expired Application Engine Process (PO_CCEXP_WF)

This section lists the page used to run the Grace Period Has Expired process.

Use this process to notify the cardholders that there are transactions that need to be approved or reconciled.

Page Used to Run the Grace Period Has Expired Application Engine Process

Page Name	Definition Name	Usage
Grace Period Expired Workflow Page	CC_BK_EXP_PRCS_WF	Run this process to notify users who did not reconcile their statements on time. Upon notification, cardholders must change the statement status to <i>Approved</i> .

Resolving Disputed Transactions

This section discusses how to view and resolve procurement card transaction amount disputes.

Pages Used to Resolve Disputed Transactions

<i>Page Name</i>	<i>Definition Name</i>	<i>Usage</i>
<u>Review Disputes Search Page</u>	CC_RECON_SRCH	Enter search criteria for the disputed transaction.
Review Disputes - Procurement Card Transactions Page	CC_TRANS_DISPUTE	View and resolve disputed transactions. The statement lines that appear on this page are lines with a dispute amount where the Credit Collected check box has been cleared.
Review Disputes - Line Comments Page	CC_TRANS_COMNT_SEC	Enter comment text that remains with the associated procurement card transaction dispute.
Expected Credits Page	RUN_POY8020	Run the Expected Credits multiprocess job (POY8020). This process will generate the Expected Credits report (POX8020)
Credit Detail By MCG (Credit Detail By Merchant Category Group) Page	RUN_POY8060	Run the Credit Detail by MCG multiprocess job (POY8060). This process will generate the Credit Detail By MCG report (POX8060)

For information on Reports See [PeopleSoft Purchasing Reports](#)

Review Disputes Search Page

Use the Review Disputes Search page (CC_RECON_SRCH) to enter search criteria for the disputed transaction.

Navigation:

Purchasing > Procurement Cards > Reconcile > Review Disputes > Review Disputes Search

Dispute Amount

<i>Field or Control</i>	<i>Description</i>
Collected	Select this check box to indicate that you have received the credit for the disputed amount. When you select the Collected check box, the transaction no longer appears on the Dispute page.

Field or Control	Description
Dispute Amount	Displays the difference in the amount between your records and the transaction amount. Appears by default from the Reconcile Statement - Procurement Card Transactions page.
Description	Appears by default from the Reconcile Statement - Procurement Card Transactions page, but you can change it here.

Viewing the Statement Summary

This section discusses how to view the statement summary.

Page Used to View the Statement Summary

Page Name	Definition Name	Usage
Review Statement Selection Criteria Page	CC_TRANS_LDSFETCH	Enter selection criteria for statements you want to view.
<u>Statement Summary Page</u>	CC_TRANS_LDSUMMARY	Use this page to view statement summary by credit card supplier, billing date, or statement status.

Statement Summary Page

Use the Statement Summary page (CC_TRANS_LDSUMMARY) to use this page to view statement summary by credit card supplier, billing date, or statement status.

Navigation:

Click the **Search** button on the Review Statement Selection Criteria page.

Field or Control	Description
Status	Displays the statement status for the statement summary. Values include <i>All Trans</i> (all transactions), <i>Approved</i> , <i>Closed</i> , <i>Initial</i> , <i>Not Closed</i> , <i>Staged</i> , and <i>Verified</i> .
Voucher ID	Displays the voucher ID. Only statements with a <i>Closed</i> status may have a voucher ID. To obtain a voucher ID, you must first create a voucher.

Staging Procurement Card Transactions for Voucher Processing

This section discusses how to run the voucher load process.

Use the ProCard Load Voucher Stage Application Engine process (PO_CCVSHRSTG) to populate data into the new staging tables for the Voucher Build process.

Note: All transactions in the staging tables must have an *Approved* status.

Page Used to Stage Procurement Card Transactions for Voucher Processing

<i>Page Name</i>	<i>Definition Name</i>	<i>Usage</i>
<u>Voucher Stage Page</u>	RUN_CC_VCHRSTG	Use the ProCard Load Voucher Stage process to move approved transactions to the voucher staging tables. Data in the CC_TRANS_LINE table is written into the Voucher Line staging table (VCHR_LINE_STG) and data in the CC_TRANS_DIST table is written into the Voucher Distribution staging table (VCHR_DIST_STG).

Voucher Stage Page

Use the Voucher Stage page (RUN_CC_VCHRSTG) to use the ProCard Load Voucher Stage process to move approved transactions to the voucher staging tables.

Data in the CC_TRANS_LINE table is written into the Voucher Line staging table (VCHR_LING_STG) and data in the CC_TRANS_DIST table is written into the Voucher Distribution staging table (VCHR_DIST_STG).

Navigation:

Purchasing > Procurement Cards > Process Statements > Load Voucher Stage > Voucher Stage

Process Request Parameters

<i>Field or Control</i>	<i>Description</i>
Card Issuer	Select the credit card supplier that you want to process.

<i>Field or Control</i>	<i>Description</i>
Billing Date	Select the billing date for the statements that you want to process. The PeopleSoft Purchasing system validates the billing date against the dates passed by the credit card provider.
Invoice Date to Use	Select any option from the drop down: <ul style="list-style-type: none"> • Billing Date: Populates the date specified in the Billing Date field. • Enter Date: Displays date picker to select a date. • Today: Displays today's date.
Invoice Date	Displays a value based on the Invoice Date to Use field value.
Create Vouchers	Select the method to create the vouchers. Values are <i>By Business Unit</i> or <i>By Credit Card Number</i> .
Business Unit	Select the business unit for the statements that you want to pay.
Invoice Number	Enter the invoice number for the statement. The invoice number is restricted to 22 characters.
Max Voucher Lines (maximum voucher lines)	Enter the maximum number of lines created into a single voucher.

Transaction Status Criteria

<i>Field or Control</i>	<i>Description</i>
Approved Status	Select this option to process only the transactions that are approved.
Any Status Except Closed	Select this option to process transactions that are not closed (this includes transactions that are not approved nor verified).

Budget Status Criteria

<i>Field or Control</i>	<i>Description</i>
Valid Budget Status	Select this option to process only the transactions that pass budget validation.
Any Budget Status	Select this option to process transactions that were never budget checked.

ChartField Status Criteria

<i>Field or Control</i>	<i>Description</i>
Valid ChartField Status	Select this option to process only the transactions that have no ChartField error.
Any ChartField Status	Select this option to process transactions that fail the ChartField combination edits.

Analyzing Procurement Card Information

This section lists the pages used to analyze procurement card information.

Pages Used to Analyze Procurement Card Information

<i>Page Name</i>	<i>Definition Name</i>	<i>Usage</i>
Purchase Exceptions Page	RUN_POY8010	Run one of these multiprocess jobs: Exceed Limit-Per-Trans (POY8010) which will generate the Exceed Limit-Per-Trans report (POX8010), Exceed Limit-Per-Cycle (POY8011) which will generate the Exceed Limit-Per-Cycle report (POX8011), Exceed Trans-Per-Day (POY8012) which will generate the Exceed Trans-Per-Day report (POX8012), Exceed Trans-Per-Cycle (POY8013) which will generate the Exceed Trans-Per-Cycle report (POX8013), or Unauthorized Commodity (POY8014) which will generate the Unauthorized Commodity report (POX8014).

Page Name	Definition Name	Usage
Credit Detail By MCG Page(Credit Detail By Merchant Category Group)	RUN_POY8060	Run the Credit Detail by MCG multiprocess job (POY8060). This process will generate the Credit Detail By MCG report (POX8060).
Non-Preferred Supplier Page	RUN_POY8061	Run the Non-Preferred Supplier multiprocess job (POY8061). This process will generate the Non-Preferred Supplier report (POX8061).
Top Supplier Chains Page	RUN_POY8062	Run the Top Supplier Chains multiprocess job (POY8062). This process will generate the Top Supplier Chains report (POX8062).
Top Merchant Category Page	RUN_POY8063	Run the Top Merchant Category multiprocess job (POY8063). This process will generate the Top Merchant Category report (POX8063).
MCC Exceptions Page(merchant category code exceptions)	RUN_POY8064	Run the MCC Exceptions multiprocess job (POY8064). This process will generate the MCC Exceptions report (POX8064).

For Information on Reports See [PeopleSoft Purchasing Reports](#)

Managing Procurement Card Expiration

To manage Procurement Card expiration, use the CC_CARD_DATA_UPD component. Only Administrator user roles can manage the ProCard expiration component.

This section discusses how to activate new cards assigned to employees and change their expiration dates.

Pages Used to Manage ProCard Expiration

Page Name	Definition Name	Usage
Manage ProCard Expiration	CC_CARD_DATA_UPD	View the details such as Employee ID, Employee Name, Business Unit, Card Issuer, Card number, Expiration Date, Status, Card Type, Date Issued, Status, and Status Date

Manage ProCard Expiration Page

Use the Manage ProCard Expiration page (CC_CARD_DATA_UPD) to activate new cards assigned to employees and to change the card expiration dates.

Navigation:

Purchasing > Procurement Cards > Definitions > Manage PCard Expiration

This example illustrates the fields and controls on the Manage ProCard Expiration Page.

The screenshot shows the 'Manage ProCard Expiration' page. It features a search section with fields for Card Issuer (VISA), Empl ID (IXHEEE102), Name, Business Unit, and Expiration Date. There are checkboxes for Active and Inactive status, and a 'Display Unmasked Card Number' option. Below the search section is a table titled 'Update Expiration and Status' with columns: Empl ID, Employee Name, Business Unit, Card Issuer, Card Number, Expiration Date, Inactive, Card Type, Date Issued, Status, and Status Date. The table contains two rows of data for employee IXHEEE102. The first row shows an active Visa card with number *****7890, issued 08/09/1999, with an expiration date of 01/01/2101. The second row shows an inactive Visa card with number *****VNDR, issued 12/03/2004, with an expiration date of 01/01/2101. At the bottom of the table are 'Save', 'Notify', and 'Refresh' buttons.

Empl ID	Employee Name	Business Unit	Card Issuer	Card Number	Expiration Date	Inactive	Card Type	Date Issued	Status	Status Date
IXHEEE102	Angelini, Gina	US001	VISA	*****7890	01/01/2101	<input type="checkbox"/>	Visa	08/09/1999	Active	03/15/2020
IXHEEE102	Angelini, Gina	US001	VISA	*****VNDR	01/01/2101	<input checked="" type="checkbox"/>	Visa	12/03/2004	Inactive	03/15/2020

It is possible to have the same card number for different employees. In such cases, the Administrator can set the card status to Active or Inactive and set their expiration dates. You can edit the Expiration Date field and Status check box. The expiration date must be later than the card issued date.

You can select multiple cards at once and their status and expiration date can be set. However, the system generates a warning message when an inactive card is assigned to another employee. You can either proceed with the selection or cancel the process. The system does not allow you to assign an active card to another employee and generates an error message.

Understanding Vendor Rebates

Understanding Vendor Rebates

Today's companies are faced with competitive pressures to reduce and manage costs and to have good working relationships with their suppliers. As competition intensifies, the successful management and profitability of vendor rebates is essential.

One of the ways that an organization can improve its profit margin is in the successful analysis, creation, processing, and tracking of vendor rebates in its environment. Vendor rebate information is an extremely valuable asset if you can obtain and use it properly. Without the means to capture and share that information, costly mistakes and loss of money can occur. You need functionality that provides the right information at the right time to the right individuals.

With the vendor rebate functionality of PeopleSoft Purchasing, you can effectively manage vendor rebates and increase revenue. The vendor rebate functionality that resides in PeopleSoft Purchasing integrates with other PeopleSoft applications to give you a complete and overall solution to the full life cycle of the vendor rebate. Through the implementation of the vendor rebate functionality, you can move one step closer to achieving success in managing vendor rebates and tracking the effectiveness of those vendor rebates.

This diagram illustrates the business process flow for vendor rebates were a vendor rebate agreement has been established and a variety of rebate options and PeopleSoft system processes, such as notifications and claims, help manage the rebate process:

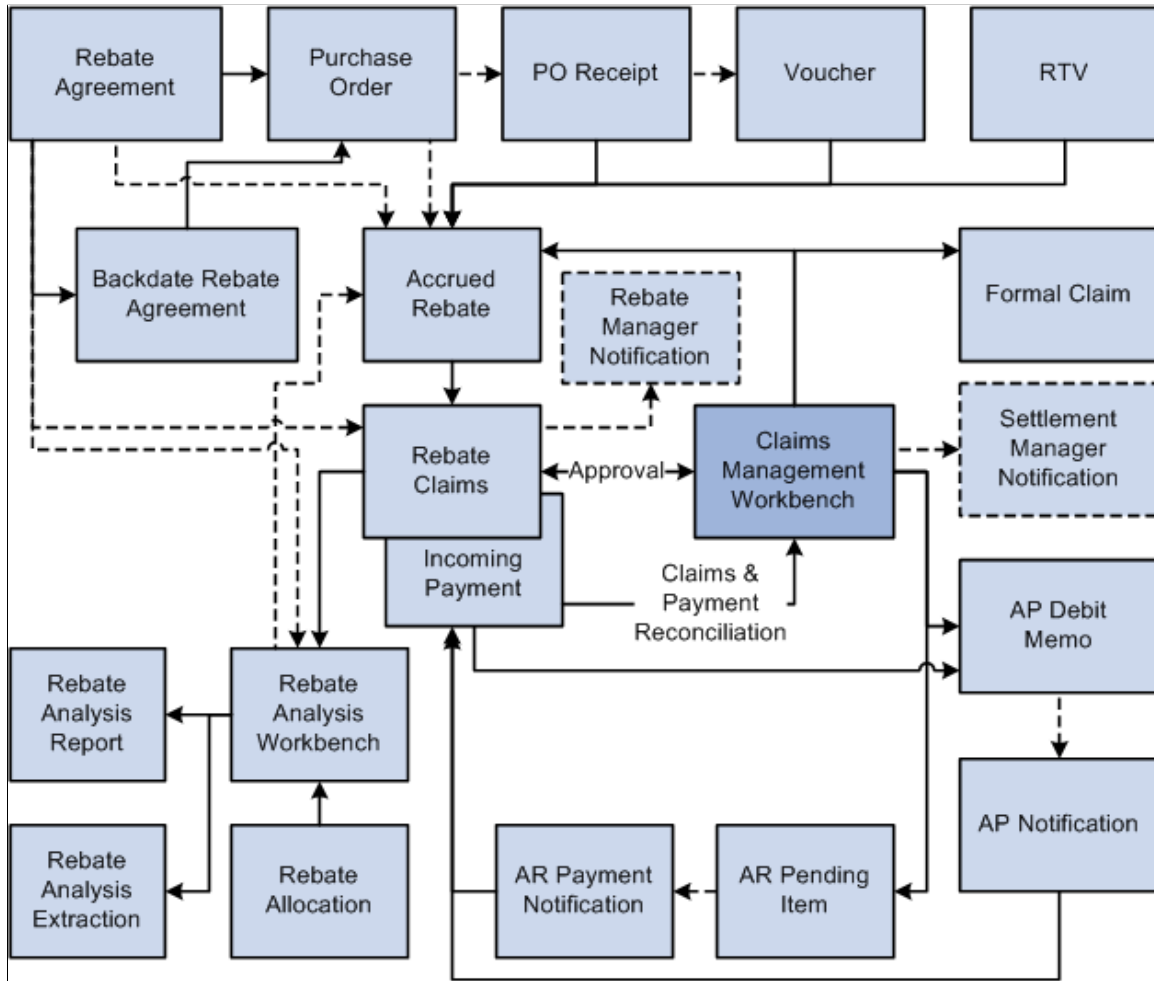

The next sections describe the process details.

Vendor Rebate Definition

The most important step in managing a successful vendor rebate program is the accurate definition of vendor rebate agreements. Using vendor rebate agreements in PeopleSoft Purchasing, you can capture the complex rules that are related to rebates from the supplier in a user-friendly and concise manner. You can define multiple rebate rules within a rebate agreement enabling you to fully define the contractual agreement with the supplier. PeopleSoft Purchasing supports a variety of rebate rules. The rebate rules supported are:

- Standard rebate: This type of rebate specifies a rebate factor (percentage or amount) based on the purchase threshold levels you defined during a specified time period. Increases in purchased amounts can reach a higher threshold level, which changes the rebate factor for additional purchases.
- Retrospective rebate: This type of rebate specifies a rebate factor (percentage or amount) based on the purchase threshold levels you defined during a specified time period. Increases in purchased amounts can reach a higher threshold level, which changes the rebate factor for additional purchases as well as all the purchases to date, within the specified rebate period.

- **Growth bonus rebate:** This type of rebate is based on a specified increase in purchases for a specific item or item category. For the growth bonus rebate, the user needs to be able to define the items, item categories, or both that will be considered for the growth bonus, the target percentage increase or growth that will trigger the rebate, and the purchase amount or quantity for each item or category that will be the basis to determine the growth percentage. The purchase volume for the current period will be compared to these values to determine whether the growth targets were achieved.
- **Marketing contribution rebate:** This type of rebate is based on amounts, with the rebate amount being based on amount or percentage. Unlike the other rebate rules types, the marketing contribution is independent of the purchase transactions. It's a one-time rebate for the life of the rebate agreement.
- **Flat amount rebate:** This type of rebate specifies a flat amount based on the purchase threshold levels you defined during the rebate agreement life. Flat rebate amount can be either prorated or not prorated.

Vendor Rebate Association with Purchase Orders

The vendor rebate assignment with purchase orders is another crucial area. When a purchase order is created in PeopleSoft Purchasing, the vendor rebate agreement association will automatically occur. However, due to business constraints in the business world, vendor rebate assignment when the purchase order is created might not be possible due to the availability of the vendor rebate agreement. This is similar to the beginning of a new rebate agreement period when purchase orders need to be released but the vendor rebate agreements are still in a negotiation phase with the supplier.

To support these types of exceptions, the vendor rebate functionality includes the Backdate Vendor Rebates component. Using the Backdate Vendor Rebates component, you can:

- Associate vendor rebate agreements with one or more purchase order lines at the same time.
- Dissociate vendor rebate agreements from one or more purchase order lines at the same time.
- Modify associated vendor rebate agreements line by line for purchase orders.

Vendor Rebate Claims Management

One of the last steps in managing a successful vendor rebate program is to be proactive in claiming rebate amounts from the supplier. When rebates are accrued, you can generate claims for the accrued rebates and inform suppliers of the rebate claims and payment terms. To assist suppliers in paying rebates, suppliers can pay for the rebate using a variety of settlement methods: adjustment voucher, check, credit memo, direct debit, draft, and electronic funds transfer (EFT).

PeopleSoft Purchasing provides you with the claims management workbench to assist you with the management of claims and the payment process for these claims. The claims management workbench enables you to:

- Review, approve, and generate a formal claim to send to the supplier.
- Settle a claim.
- Reconcile incoming payments.
- Defer a claim to the next payment cycle.
- Create deductions or reverse deductions to accommodate overdue payments from the supplier.

Overall, the claims management workbench enables you to track what rebates have been paid and what is due from suppliers. This helps ensure that organizations collect rebate claims in a timely fashion and results in cost savings.

The claims management processes integrate with PeopleSoft Payables and PeopleSoft Receivable to complete the payment cycle.

See [Understanding the Rebate Accrual Process](#). [Defining Vendor Rebate Agreements](#)

See .

Vendor Rebate Effectiveness Evaluation

The final step in managing a successful vendor rebate program is evaluating the profitability of the vendor rebates that are offered from the suppliers. Reviewing this type of information from time to time enables you to make adjustments to the vendor rebate structure and gives you the necessary information so that you can plan and carry out profitable rebates in the future.

PeopleSoft Purchasing provides you with the rebate analysis workbench to assist you with evaluating and determining the effectiveness and profitability of a vendor rebate. Using the rebate analysis workbench, you can perform multiple inquiries to analyze vendor rebates. You can perform rebate threshold analysis and time period analysis, view purchase orders that have not been received that are associated with the vendor rebate, and view accrued rebate details.

See [Defining Vendor Rebate Agreements](#).

Defining Vendor Rebate Agreements

Understanding Vendor Rebate Agreement Statuses

Multiple statuses can occur for a vendor rebate agreement during the life of the agreement. The available statuses for a vendor rebate agreement and the eligible processes for each status are:

<i>Vendor Rebate Agreement Status</i>	<i>Edits, Allowed Actions, Eligible Processes</i>
<i>Open</i>	<p>The user must have entry authority.</p> <p>Accrual transactions are created and claims are generated:</p> <p>If accruals are created and claims generated (other than canceled claims), the user cannot change rule information for the rebate agreement.</p> <p>Accrual transactions have been created and no claims have been generated, or claims exist in canceled status: the user can change the rebate rule information.</p> <p>Rebate Agreement references on purchase order but no accrual transactions have been generated:</p> <ul style="list-style-type: none"> • The user cannot change: <ul style="list-style-type: none"> • General Details: Supplier, Supplier ID, Currency, and Rate Type. Begin date and expiration date can be modified. • Rebate Options: Corporate Agreement, Eligible PO Business Units, Include Automatically PO Adhoc Items, and Open Item Rebate Agreement check boxes. The Open Item Rebate Agreement check box can be selected if it wasn't previously, but it cannot be cleared if previously selected. • Rebate lines and exceptions: The user cannot change or delete an existing rebate line. The user can mark the line inactive. You can add additional lines and exceptions. • Rebate Rules: The user can modify all rebate agreement rules information. <p>Rebate agreement is not referenced on a purchase order:</p> <p>The user can change all the information on the rebate agreement.</p>

Vendor Rebate Agreement Status	Edits, Allowed Actions, Eligible Processes
<i>Approved</i>	<ul style="list-style-type: none"> • The user must have approval authority. • The user cannot modify any rebate information except rebate status and dispatch fields. • Rebate agreements only in approved status can have the following processes run against them: <ul style="list-style-type: none"> • Rebate agreements can be dispatched. • Accrual transactions can be created. • Claims can be generated. <p>Claims Reconciliation and the Overdue and Cancel Overdue process can be processed if the rebate agreement is in either an <i>Approved</i> or <i>Hold</i> status.</p>
<i>Cancel</i>	<ul style="list-style-type: none"> • The user must have cancel authority. • The user cannot modify any rebate information except for rebate status. • The user can cancel rebate agreements only if no rebate agreement references are on a purchase order line. If any rebate agreement references are on a purchase order line, clear the references using the Maintain Purchase Order - Purchase Order page, the Express Purchase Order - , or the Backdate Vendor Rebates page.
<i>Hold</i>	<ul style="list-style-type: none"> • The user must have hold authority. • The user cannot modify any rebate information except for rebate status. • The user can put the rebate agreement on hold even if rebate references are on the purchase order, accrual transactions have been created, and claims have been generated. • No activity can occur against a rebate agreement that is in a hold status. You can perform payment activities against the rebate agreement, such as Claims Reconciliation and Overdue and Cancel Overdue processes.

Vendor Rebate Agreement Status	Edits, Allowed Actions, Eligible Processes
<i>Close</i>	<ul style="list-style-type: none"> • The user must have close authority. • The user cannot modify any rebate information except for rebate status. • The user controls the close action on the rebate agreement irrespective of the rebate references. The system issues warning messages based on the references. It issues individual messages based on the following rebate references: <ul style="list-style-type: none"> • Pending claims (claims in <i>Open</i>, <i>Approved</i>, <i>Pending Payment</i>, and <i>Partial Paid</i> statuses). • Accrual transactions that have been created and no claims have been generated or claims have been generated, but they are in a <i>Cancel</i> or <i>Paid</i> status. • Rebate agreement references on a purchase order and no accrual transactions have been generated.

Understanding Vendor Rebate Rule Types

PeopleSoft Purchasing provides five different vendor rebate rule types that you can associate with a vendor rebate agreement. These vendor rebate rule types are:

- Stepped/Standard.
- Retrospective.
- Flat Amount.
- Growth Bonus.
- Marketing Contribution.

Stepped/Standard

This is the simplest vendor rebate rule type and is based on amounts or quantities. Standard/Stepped rebate rule types specify a rebate factor percentage that is based on the defined purchase threshold levels during the rebate agreement life. Usually the higher the threshold, the greater the rebate percentage, thus awarding a greater vendor rebate amount for a supplier who makes large purchases.

For example, a rebate agreement is negotiated with a supplier, which states that:

- Purchases between 0 USD and 100,000 USD receive a 1 percent rebate.
- Purchases between 100,001 USD and 500,000 USD receive a 2 percent rebate.
- Purchases over 500,001 USD receive a 3 percent rebate.

- Rebates will be paid quarterly.
- The method of payment will be by check.

Assume that the purchases for the quarter were 650,000 USD. The rebate at the end of the quarter would be 13,500 USD.

$$13,500 \text{ USD} = ((100,000 \text{ USD} \times .01) + (400,000 \text{ USD} \times .02) + (150,000 \text{ USD} \times .03))$$

Retrospective

Retrospective rebate rule types are based on amounts or quantities. Retrospective rebate rule types specify a rebate factor percentage that is based on the defined purchase threshold levels during the rebate agreement life. Increases in purchased amounts can reach a higher threshold level, which changes the rebate factor for additional purchases as well as all the purchases to date within the rebate agreement life.

For example, a rebate agreement is negotiated with a supplier, which states that:

- Purchases between 0 USD and 100,000 USD receive a 1 percent rebate.
- Purchases between 100,001 USD and 500,000 USD receive a 2 percent rebate retrospectively back to 1 USD.
- Purchases over 500,001 USD receive 3 percent rebate retrospectively back to 1 USD.
- Rebates will be paid quarterly.

Assume that the purchases for the quarter were 650,000 USD. The rebate at the end of the quarter would be 19,500 USD.

$$19,500 \text{ USD} = (650,000 \text{ USD} \times .03)$$

Flat Amount

Flat amount rebate rule types are based on amounts or quantities. Flat rebate rule types specify a flat amount based on the defined purchase threshold levels during the rebate agreement life. Flat rebate amount can be either prorated or not prorated.

For example, a rebate agreement is negotiated with a supplier, which states that:

- Purchases between 0 USD and 100,000 USD receive a 1000 USD rebate, prorated.
- Purchases between 100,001 USD and 200,000 USD receive a 5000 USD rebate, prorated.
- Rebates will be paid quarterly.

Assume that the purchases for the quarter were 150,000 USD. The rebate at the end of the quarter would be 3,500 USD.

$$3,500 \text{ USD} = (1,000 \text{ USD} + 50 \text{ percent of } 5,000 \text{ USD})$$

This is another example not using prorate option:

- Purchases between 0 USD and 100,000 USD receive a 1000 USD rebate, prorated.
- Purchases between 100,001 USD and 200,000 USD receive a 5000 USD rebate, not prorated.

- Rebates will be paid quarterly.

Assume that the purchases for the quarter were 150,000 USD. The rebate at the end of the quarter would be 6,000 USD.

$$6,000 \text{ USD} = (1,000 \text{ USD} + 5,000 \text{ USD})$$

Growth Bonus

Growth bonus rebate rule types are based on a specified increase in purchases for a specific item or item category. For this rebate rule type, you can define the items, item categories that will be considered for the growth bonus, or both, the target percentage increase or growth that will trigger the rebate, and the purchase amount or quantity for each item or item category that will be the basis to determine the growth percentage. The purchase volume for the current period will be compared to these values to determine whether the growth targets were achieved. You can also define rebate per growth percentage threshold levels.

For example, a rebate agreement is negotiated with a supplier, which states:

- Receive a 2 percent growth bonus on a particular category (A) of products under the condition that the purchasing turnover has increased by 10 percent or more year on year.
- Rebates will be paid quarterly.

Assume that the purchases were:

Category	Fourth Quarter 2002	Fourth Quarter 2003	Percentage Increase
A	400,000 USD	450,000 USD	12.5 percent
B	200,000 USD	200,000 USD	0 percent
	600,000 USD	650,000 USD	

The rebate at the end of the quarter would be 1,000 USD.

$$1,000 \text{ USD} = (50,000 \times .02)$$

Marketing Contribution

Marketing Contribution rebate rule types are based on amounts, with the rebate amount being based on amount or percentage. Unlike the other rebate rules types, the marketing contribution is independent of the purchase transactions. It is a *one-time* rebate for the entire rebate agreement life.

For example, a contract is negotiated with a supplier for the quarter, which states:

Receive a 1.5 percent marketing contribution on purchases for the previous period.

Assume that the purchases for the previous quarter were 650,000 USD. The rebate at the end of the quarter would be 9,750.00 USD.

$$9,750 \text{ USD} = (650,000 \text{ USD} \times .015)$$

Rebate Agreement Examples

This is an example of a quarterly rebate agreement using retrospective rule with quantity basis and marketing contribution:

A rebate agreement with a supplier contains three items:

Item A: UOM EA

Item B: UOM EA

Item C: UOM CS (CS: case, 1 CS = 4 EA)

The rebate rules for the rebate agreement state:

- Purchases between 0 and 10,000 EA receive a 1 percent rebate.
- Purchases between 10,000 and 50,000 EA receive a 2 percent rebate retrospectively back to 1 EA.
- Purchases over 50,000 EA receive a 3 percent rebate retrospectively back to 1 EA.
- Additionally, we receive a 1 percent marketing contribution on purchases for the same quarter last year.
- Rebates will be paid quarterly.
- Method of payment will be by check.

Assume that the purchases for the same quarter last year were 300,000 USD. The following table illustrates the purchases for the current quarter:

<i>Item</i>	<i>Quantity</i>	<i>Unit of Measure</i>	<i>Unit Price</i>	<i>Amount</i>
Item A	4,000	EA	10.00 USD	40,000
Item B	6,000	EA	20.00 USD	120,000
Item C	4,000	CS	50.00 USD	200,000
Total Purchase	26,000	EA		360,000

Note: The total units in EA are calculated as $((4000 + 6000 + (4000 \times 4))$

The rebate at the end of the quarter would be 10,200 USD.

$$10,200 \text{ USD} = ((360,000 \text{ USD} \times .02) + (300,000 \times .01))$$

This is another example of rebate agreement using retrospective, marketing contribution, and growth bonus rules combined:

- Purchases between 0 USD and 100,000 USD receive a 1 percent rebate.

- Purchases between 100,001 USD and 500,000 USD receive a 2 percent rebate retrospectively back to 1 USD.
- Purchases over 500,001 USD receive a 3 percent rebate retrospectively back to 1 USD.
- Additionally, we receive a 1 percent marketing contribution on purchases for the same quarter in the previous year.
- Also, we receive a 2 percent growth bonus on a particular category (A) of products under the condition that the purchasing turnover has increased by 10 percent or more year on year.
- Rebates will be paid quarterly.
- Method of payment will be by check.

Assume that the purchases for the quarter were 650,000 USD. The purchases for the same quarter last year were 600,000 USD.

Category	Fourth Quarter 2002	Fourth Quarter 2003	Percentage Increase
A	400,000 USD	450,000 USD	12.5 percent
B	200,000 USD	200,000 USD	0 percent
	600,000 USD	650,000 USD	

The rebate at the end of the quarter would be 26,500 USD.

$$26,500 \text{ USD} = (650,000 \text{ USD} \times .03) + (600,000 \times .01) + (50,000 \times .02)$$

Prerequisites

Before you begin creating vendor rebate agreements, you should:

- Define vendor rebate agreement authorizations for each rebate manager using the Rebate Authorizations page.
See “User Preferences – Rebate Authorizations Page” (Application Fundamentals).
- Specify the rebate ID security control option using the Purchase Order Authorizations page.
See “User Preferences – Purchase Order User Authorizations Page” (Application Fundamentals).
- (Optional) Define vendor rebate settlement tolerance settings using the Set Controls - Contracts page.
See “Defining Contract and Vendor Rebate Control Parameters” (PeopleSoft Source to Settle Common Information).
- Set up automatic numbering for vendor rebate agreement IDs and claim IDs using the Auto Numbering page.

See “Auto Numbering Page” (Application Fundamentals).

- Define the accounting entry template for use with vendor rebate agreements using the Accounting Entry Template page.

See “Accounting Entry Template Page” (Application Fundamentals).

- Define reason codes to be used for claims adjustment using the Reason Codes page.

See “Defining Additional Common Information” (Application Fundamentals).

- Create bill to customers for each supplier using the supplier Information - Identifying Information page if the settlement method for the rebate agreement is anything but *Adjustment Voucher*.

See “Entering Supplier Identifying Information” (PeopleSoft Source to Settle Common Information)

- (Optional) Define the matching default hierarchy. The vendor rebate functionality requires the matching functionality to be implemented.

See Understanding the Matching Default Hierarchy.

Defining Vendor Rebate Agreements

To define vendor rebate agreements, use the Rebate Agreement component (VRBT_AGREEMENT).

This section discusses how to Define Vendor Rebate Agreements

Pages Used to Define Vendor Rebate Agreements

Page Name	Definition Name	Usage
<u>Rebate Agreement - Rebate Agreement Page</u>	VRBT_HDR	Define the overall rebate agreement information for the rebate agreement.
Rebate Agreement - Copy Rebate Agreement Page	VRBT_COPY_SEC	Copy an existing rebate agreement to a new rebate agreement.
Supplier Search Page	Supplier_LOOKUP_SEC	Search for the supplier that you want to associate with the rebate agreement.
Rebate Agreement - Specify Supplier Locations Page	VRBT_VNDR_LOC	Define the Supplier Locations that apply to the rebate agreement. If you specify Supplier locations, then the rebate agreement is applicable to purchase orders that are created for the specific Supplier location. If Supplier locations are not defined for the rebate agreement, then the rebate agreement is applicable to purchase orders irrespective of the Supplier locations.

Page Name	Definition Name	Usage
Rebate Agreement - Rebate Comments Page	VRBT_COMMENTS	Define rebate agreement comments.
Rebate Agreement - Rebate Activity Page	VRBT_ACTIVITY	Enter activities and the due dates that are associated with the rebate agreement. Also, you can mark when those activities have been completed.
Rebate Agreement - Supplier Primary Contact Info Page	VRBT_CNTCTPHNSEC	Review the Supplier's primary contacts address and other contact information, such as telephone number and pager number.
Rebate Agreement - Activity Log Page	PO_MAINT_POP	Review the activity log for this rebate agreement. This page displays the user ID and the date of the individual who entered, modified, and approved the rebate agreement.
Rebate Agreement - Item Search Page	PO_ITEM_SEARCH_SP	Search for items that you want to apply to the rebate agreement.
Category Search Page	CAT_SEARCH_SEC	Search for categories that you want to apply to the rebate agreement.
Rebate Agreement - Item Category Exceptions Page	VRBT_CAT_EXCPTN	Define items within a category that do not apply to this rebate agreement.
<u>Rebate Agreement - Rebate Options Page</u>	VRBT_OPTIONS	Define general and settlement rebate options that pertain to the rebate agreement.
Rebate Agreement - Eligible PO Business Units Page	VRBT_BU	Define eligible purchase order business units for the rebate agreement. This page is available if the rebate agreement is not specified as a corporate agreement.
<u>Rebate Agreement - Rebate Agreement Value Added Tax Page</u>	VRBT_HDR_VAT	Update value added tax details for the rebate agreement. The Header VAT link is available only if the PeopleSoft General Ledger business unit that is associated with the PeopleSoft Payables business unit is a VAT entity.

Page Name	Definition Name	Usage
Rebate Agreement - Receivables ChartFields Page	VRBT_AR_DIST	Review and override the ChartFields that are associated with PeopleSoft Receivables business unit that is associated with the rebate agreement. The system populates by default the ChartFields from the AR Distribution Code that is defined for the PeopleSoft Receivables business unit. The PeopleSoft Receivables ChartFields are required if the settlement method for the rebate agreement is anything but <i>Adjustment Voucher</i> .
<u>Rebate Agreement - Rebate Rules Page</u>	VRBT_RULES	Define the different rebate rules that apply to this rebate agreement.
Rebate Agreement - Rebate Types Explained Page	VRBT_RULE_INFO	Displays text explaining the five different types of rebates with examples, namely Standard or Stepped, Retrospective, Flat, Growth Bonus, and Market Contribution.
Rebate Agreement - Distributions for Rebate Rule Page	VRBT_RULE_DIST	Define the ChartField distributions for each rebate rule.

Rebate Agreement - Rebate Agreement Page

Use the Rebate Agreement - Rebate Agreement page (VRBT_HDR) to define the overall rebate agreement information for the rebate agreement.

Navigation:

Purchasing > Vendor Rebates > Supplier Rebate Agreement

This example illustrates the fields and controls on the Rebate Agreement - Rebate Agreement page. You can find definitions for the fields and controls later on this page.

The screenshot shows the 'Rebate Agreement' page with tabs for 'Rebate Agreement', 'Rebate Options', and 'Rebate Rules'. The main area is divided into 'General Details' and 'Amount Summary'.

General Details:

- SetID: SHARE
- Rebate ID: 0000000000000000005
- *Rebate Status: Open
- Supplier: CAMPER'S-001
- *Supplier ID: SCM0000002
- *Rebate Manager: VP1
- Settlement Manager: VP1
- Primary Contact: 1
- Rebate Reference: (empty)
- Description: Corp. Rebate Agreement 2009
- Master Contract ID: (empty)
- Currency: USD
- Rate Type: CRRNT
- *Begin Date: 01/17/2013
- Expiration Date: 01/18/2014

Amount Summary:

- Maximum Rebate Amount: 200,000.00 USD
- Total PO Amount
- Total Accrued Rebate
- Total Claim Amount
- Rebate Received
- Total Pending Rebate Amount

Line Items and Categories:

Line	Line Type	Search	Item ID	Category	Description	Status
1	Item		10038	CAMPING	Zone 2 Sleeping Bag, Regular	Active
2	Item		10039	CAMPING	Zone 2 Sleeping Bag, Long	Active

Field or Control	Description
Rebate Status	<p>This field appears by default from the User Preferences - Procurement: Rebate Authorizations page. When you are defining a rebate agreement, the initial default value is either <i>Open</i> or <i>Approved</i>.</p> <p>Select the overall rebate agreement status. Values are:</p> <ul style="list-style-type: none"> • <i>Approved</i> • <i>Canceled</i> • <i>Closed</i> • <i>Hold</i> • <i>Open</i> <p>See Understanding Vendor Rebate Agreement Statuses.</p>
Copy From Existing Rebate Agreement	<p>Click this link to access the Rebate Agreement - Copy Rebate Agreement page. Use this page to copy an existing rebate agreement to the new rebate agreement.</p> <hr/> <p>Note: This link appears only in Add mode.</p>

General Details

<i>Field or Control</i>	<i>Description</i>
Rebate Manager	Select the rebate manager for this rebate agreement. Rebate managers are users who are specified with the rebate manager role.
Settlement Manager	Select the settlement manager for this rebate agreement.
Master Contract ID	Select the contract to associate with this rebate agreement.
Begin Date	Select the start date for this rebate agreement. The current date appears by default for the begin date. <hr/> Note: You cannot change the begin date to be after the purchase order date. <hr/>
Expiration Date	Select the end date for this rebate agreement. <hr/> Note: You cannot change the expiration date to be before the purchase order date. <hr/>
Dispatch Method	Select the dispatch method for the rebate agreement. Values are: <ul style="list-style-type: none">• <i>Email</i>• <i>FAX</i>• <i>Phone</i>• <i>Print</i>
Dispatch	Click this button to dispatch the supplier agreement. The rebate agreement must be approved before you can dispatch it. When you click the button, the system automatically performs the Rebate Dispatch & Email multiprocess job (VRBTDISP).

Field or Control	Description
Specify Supplier Locations	<p>Click to access the Rebate Agreement - Specify Supplier Locations page. Use this page to specify specific Supplier locations where the rebate agreement ID can be applied when you are creating a purchase order.</p> <p>For example, suppose you have a supplier ABC and they have three locations: Location 1, Location 2, and Location 3. You have created a specific rebate agreement ID with this supplier that is applicable only if the purchase order is ordered from Location 2 and Location 3. In this situation, when ordering from Location 1, they are not eligible for the rebate agreement.</p> <p>Specifying Supplier locations is optional. If you do not specify Supplier locations, then the rebate agreement ID can be applied to all the Supplier locations from the specified supplier.</p>
Add Comments	<p>Click to access the Rebate Comments page where you can view and add comments about the rebate.</p> <p>See PO Header Comments Page.</p>
Rebate Activities	<p>Click to access the Rebate Activity page where you can view and update activities associated with the rebate. You can enter activities and the due dates and mark when those activities have been completed.</p>
Primary Contact Info (primary contact information)	<p>Select to access the Supplier Primary Contact Info page where you can review the supplier's primary contacts address and other contact information, such as telephone number and pager number.</p>
Activity Log	<p>Click to access the Activity Log page where you can review the activity log for this rebate agreement. The page displays the user ID and the date of the individual who entered, modified, and approved the rebate agreement.</p>

Amount Summary

Field or Control	Description
Maximum Rebate Amount	<p>Enter a value if a maximum rebate amount is available for this rebate agreement. This value is expressed in the rebate agreement currency.</p>

<i>Field or Control</i>	<i>Description</i>
Total PO Amount (total purchase order amount)	Displays the total purchase order amount in the rebate agreement currency. This is the sum of all merchandise amounts per purchase order line that are associated with this rebate agreement.
Total Accrued Rebate	Displays the total accrued amount for this rebate agreement.
Total Claim Amount	Displays the total claim amount for this rebate agreement.
Rebate Received	Displays the total claim amount that was collected from the supplier for this rebate agreement.
Total Pending Rebate Amount	Displays the difference between the total accrued rebate and the total claim amount for the rebate agreement (the accrued rebate portion that has not been claimed yet).

Line Items and Categories

<i>Field or Control</i>	<i>Description</i>
Add Items From	Click the Item Search link to access the Rebate Agreement - Item Search page. Use this page to add multiple items at once to the rebate agreement.
Line	<p>Displays the line number of the rebate agreement. The rebate agreement line indicates which item or item categories are applied to the vendor rebate agreement.</p> <hr/> <p>Note: This applies only if the vendor rebate agreement is not a corporate agreement.</p> <hr/>

Field or Control	Description
Line Type	<p>Select the type of line that you are adding to the rebate agreement. Values are:</p> <ul style="list-style-type: none"> • <i>Category</i> <p>When you select category as the line type, the Category field becomes available for entry and the Item ID field is not available for entry.</p> <ul style="list-style-type: none"> • <i>Item</i> <p>When you select item as the line type, the Item ID field becomes available for entry. The category that is associated with the item that you enter appears in the Category field.</p>
 (search)	<p>Click to search for either item IDs or categories.</p> <p>If you select a line type of <i>Category</i>, click this button to access the Category Search page. Use this page to search for categories.</p> <p>If you select a line type of <i>Item</i>, click this button to access the Rebate Agreement - Item Search page. Use this page to search for items.</p>
Exception	<p>Click this link to access the Rebate Agreement - Item Category Exceptions page. Use this page to identify the items in the category that you want to exclude from the rebate agreement.</p> <p>The Exception link appears only when you select a line type of <i>Category</i>.</p>

Rebate Agreement - Rebate Options Page

Use the Rebate Agreement - Rebate Options page (VRBT_OPTIONS) to define general and settlement rebate options that pertain to the rebate agreement.

Navigation:

Purchasing > Vendor Rebates > Rebate Agreement > Rebate Options

This example illustrates the fields and controls on the Rebate Agreement - Rebate Options page. You can find definitions for the fields and controls later on this page.

General Rebate Options

Field or Control	Description
Corporate Agreement	Select this check box if this rebate agreement can be used by all business units. This check box appears selected by default. If the check box is clear, then you need to specify at least one eligible PO business unit.
Open Item Rebate Agreement	Select this check box if the rebate agreement is open to all items. If you select this check box, you are not able to enter items or categories for the rebate agreement on the Rebate Agreement - Rebate Agreement page.
Include Automatically PO Adhoc Items (include automatically purchase order ad hoc items)	Select this check box if you want to include description-only items for the rebate agreement. If the check box is clear, the rebate agreement won't be automatically associated to the purchase order lines with description-only items.
Rebate Reduction From RTV (rebate reduction from return to vendor)	Select this check box if you want to generate accruals upon return to vendor shipments for the purchase orders that are associated with this rebate agreement. Accruals on RTV transactions will have a negative rebate amount.

Field or Control	Description
Include Only Vouchered Rebate Accruals in Claims	Select this check box if you want the Generate Vendor Rebate Claims process to include only the rebate accruals with a transaction status of <i>Vouchered</i> .
Direct Shipment Option	Select the direct shipment option. This option is used to determine the rebate agreement that is assigned to a purchase order when the purchase order is created. Values are: <ul style="list-style-type: none"> • <i>Direct Shipments Only</i>: Rebate agreement is applied exclusively to the direct shipment transactions. • <i>Exclude Direct Shipments</i>: Rebate agreement is applied exclusively to regular purchase order transactions. • <i>Include Direct Shipments</i>: Rebate agreements are applied to both regular purchase order transactions and direct shipment transactions.
Must Use Rebate Rate Date	Select this check box if you want the system to use the rate date of the rebate agreement for the currency conversion. After you select this check box, select the rate date in the Rate Date field.
Notify Rebate Manager	Select this check box if you want to notify the Rebate Manager by email, worklist, or both when a new claim is generated.
Notify Settlement Manager	Select this check box if you want to notify the Settlement Manager by email, worklist, or both when a claim is settled through the Claims Management Workbench.

Settlement Options

Field or Control	Description
AP Business Unit (PeopleSoft Payables business unit)	Select the PeopleSoft Payables business unit to use for the rebate agreements settlement.
AR Business Unit (PeopleSoft Receivables business unit)	Select the PeopleSoft Receivables business unit if the settlement method for the rebate agreement is anything but <i>Adjustment Voucher</i> .
GL Business Unit (PeopleSoft General Ledger business unit)	The PeopleSoft General Ledger business unit that is associated with the PeopleSoft Payables business unit appears.

Field or Control	Description
Supplier Location	<p>Select the Supplier location to apply to adjustment vouchers that are created for a claim settlement. Specifying a Supplier location is optional.</p> <p>This Supplier location will be passed to PeopleSoft Payables through the voucher staging process.</p> <p>Specifying a Supplier location can be useful if you want to handle a specific Supplier location for rebate differently than the normal ordering Supplier location.</p>
Settlement Frequency	<p>Select the frequency of the rebate agreement settlement. The schedule IDs that you define on the Maintain Purchase Order - Schedules page are used for the settlement frequency. For example, settlement frequency can be yearly, quarterly, monthly, and so on.</p> <p>See Creating Purchase Order Schedules.</p>
Next Claims Generation Date	<p>Displays the next claim generation date. The system calculates the date based on the rebate agreement begin date and settlement frequency that is selected. You can override this date.</p> <p>For example, assume that a rebate agreement is being entered on February 1, 2004 (current system date) with a begin date of January 1, 2004 and an expiration date of December 31, 2004 with a settlement method of quarterly. Assume that the schedule is defined as quarterly with a day of the month equal to one for the schedule ID. In this case, the next claims generation date calculated would be April 1, 2004.</p>
Settlement Method	<p>Select the settlement method for the rebate agreement. Values are <i>Adjustment Voucher</i>, <i>Check</i>, <i>Credit Memo</i>, <i>Direct Debit</i>, <i>Draft</i>, and <i>Electronic Funds Transfer</i>.</p>
AR Payment Terms (PeopleSoft Receivables payment terms) or AP Payment Terms (PeopleSoft Payables Payment Terms)	<p>Depending on the settlement method that you select, you will select either AR Payment Terms or AP Payment Terms. The system uses this field for the payment due days calculation.</p>

Settlement Tolerances

<i>Field or Control</i>	<i>Description</i>
Amount Tolerance Over and Amount Tolerance Under	These fields appear by default from the values that are defined on the Set Controls - Contracts page. See “Defining Contract and Vendor Rebate Control Parameters” (PeopleSoft Source to Settle Common Information).
Percentage Tolerance Over and Percentage Tolerance Under	These fields appear by default from the values that are defined on the Set Controls - Contracts page.

Rebate Agreement - Rebate Agreement Value Added Tax Page

Use the Rebate Agreement - Rebate Agreement Value Added Tax page (VRBT_HDR_VAT) to update value added tax details for the rebate agreement.

Navigation:

Click the **Header VAT** link on the Rebate Agreement - Rebate Options page.

Expanding and Collapsing Sections

To manage the VAT data more efficiently, you can expand and collapse sections on this VAT page making management of the information on this page easier.

<i>Field or Control</i>	<i>Description</i>
Expand All Sections	Click this button to scroll to and access every section on the page. You can also expand one or more sections by clicking the arrow next to the section's name.
Collapse All Sections	Click this button to collapse all sections displaying only the header information. If you expand one or more sections, you can click the arrow next to the name of the section to collapse the section.

Physical Nature

<i>Field or Control</i>	<i>Description</i>
Physical Nature	Indicates whether an object is a good or a service. Many countries are required to report the sale and purchase of goods separately from services. The default comes from the supplier location in the Settlement Options if specified, or the default supplier location or <i>Goods</i> value if not specified on the supplier location.

VAT Locations

<i>Field or Control</i>	<i>Description</i>
Ship From Country	Displays the Supplier's ship from location country. In the case of transactions involving goods or freight service transactions, this is used to determine the VAT treatment.
Ship From State	If the ship to country is defined as tracking VAT by state or province, this field displays the Supplier's ship from location state. In the case of transactions involving goods or freight service transactions, this is used to determine the VAT treatment.
Ship To Country	Displays the ship to location country. In the case of transactions involving goods or freight service transactions, this determines the VAT treatment.
Ship To State	If the ship to country is defined as tracking VAT by state or province, this field displays the ship to location state. In the case of transactions involving goods or freight service transactions, this is used to determine the VAT treatment.

VAT Defaults

<i>Field or Control</i>	<i>Description</i>
Reporting Country	Displays the country for which this VAT will be reported. This is the VAT entity VAT registration country and determines many of the VAT defaults.

Field or Control	Description
Defaulting State	If the reporting country requires that VAT be tracked by state or province, this field displays the state within the reporting country that is used to retrieve values from the VAT Defaults table.
Supplier's Registration Country and Supplier's Registration ID	Displays the registration country and ID of the supplier.
Exception Type	Displays the exception that is granted to the VAT entity. Values are: <i>None</i> , <i>Exonerated</i> , or <i>Suspended</i> . This value is specified on the VAT entity registration.
Certificate ID	If applicable, displays the ID of the VAT exception certificate that may have been issued to the VAT entity.
Calculate at Gross or Net	<p>Indicates how VAT is calculated. Values are:</p> <p><i>Gross</i>: The system calculates VAT before it applies any early payment discounts.</p> <p><i>Net</i>: The system calculates VAT after it deducts early payment discounts. If two percentage discounts exist, the system uses the larger of the two when it calculates VAT. The system does not use discount amounts, only discount percentages.</p> <p>The default value comes from the VAT entity driver.</p>
Recalculate at Payment	Select this check box to enable the recalculation of VAT at payment time to allow for any early payment discounts, if you are calculating VAT at gross. This causes the system to adjust the VAT amount at the time of payment if the discount has been taken. This is set on the VAT entity driver in the VAT defaults table.

Field or Control	Description
Declaration Point	<p>Appears for a good or service when you want VAT transaction information to be recognized for reporting purposes. Values are:</p> <ul style="list-style-type: none"> • <i>Invoice</i>: VAT is recognized at time of invoice. • <i>Payment</i>: VAT is recognized at time of payment. • <i>Delivery</i>: VAT is recognized on delivery. <p>This value may be set at several levels in the VAT hierarchy: VAT entity registration, business unit options, supplier, or supplier location.</p>
Rounding Rule	<p>Displays the VAT rounding rule. The value comes from the VAT country, VAT entity, supplier, or supplier location drivers. Values are:</p> <p><i>Nat Rnd</i> (natural round): Amounts are rounded normally (up or down) to the precision that is specified for the currency code. For example, for a currency that is defined with two decimal places, 157.4659 would round up to 157.47, but 157.4649 would round down to 157.46.</p> <p><i>Down</i> (round down): Amounts are rounded down. For example, for a currency that is defined with two decimal places, 157.4699 would round down to 157.46.</p> <p><i>Up</i> (round up): Amounts are rounded up with a rounding precision to one additional decimal place. For example, for a currency that is defined with 2 decimal places, 157.4659 would round up to 157.47, but 157.4609 would round down to 157.46.</p>
Use Type	<p>Determines the split between recoverable (taxable) and nonrecoverable (nontaxable) VAT.</p> <p>For the Canadian public sector, the use type also determines the rebate of the nonrecoverable VAT. VAT rebates are calculated based on statutory rebate rates that are established for each public service body.</p> <p>The value comes from the VAT defaulting hierarchy, from the supplier location, supplier, or purchasing options.</p>

<i>Field or Control</i>	<i>Description</i>
Include Freight	If this option is selected, the system includes any freight amounts in the VAT basis by calculating VAT on the merchandise amount plus any freight amount. This option is available only for exclusive VAT calculation. The value comes from the VAT entity registration driver.
Include Miscellaneous	If this option is selected, the system includes any miscellaneous charge amounts in the VAT basis by calculating VAT on the merchandise amount, plus any miscellaneous charge amount. This option is available only for exclusive VAT calculation. The value comes from the VAT entity registration driver.

Field or Control	Description
Treatment	<p>Displays the VAT treatment. VAT treatment is determined by a complex set of algorithms. Values are:</p> <ul style="list-style-type: none"> • <i>Domestic Goods Purchase</i>: If the ship from and ship to countries are the same, and the supplier is registered for VAT, the transaction is treated as domestic. • <i>Domestic Service Purchase</i>: If the buyer and seller are both located in the country where the VAT is liable, the transaction is treated as domestic. • <i>EU Goods Purchase</i> (European Union goods purchase): If the ship from and ship to countries are different, the system determines whether both countries are located within the European Union. If so, the system looks at the VAT registration for each trading partner to determine whether the transaction should be treated as an intra-EU purchase, domestic, or outside the scope of VAT. • <i>EU Service Purchase</i> (European Union service purchase): If each trading partner is located and registered in a different EU country, and the VAT on a service is liable in the buyer's country, the transaction is treated as a self-assessed EU Services Purchase. • <i>Self-Assess Goods Import</i>: If the ship from country is different from the ship to country and either or both of the countries are located outside of the European Union, and the supplier is not registered in the ship to country, the transaction would be treated as an import. If the flag on the entry in the VAT Country table for the VAT reporting country indicates that VAT on imports should be self-assessed, the transaction will be treated as a self-assess goods import, and both input and output VAT will be recorded. • <i>Self-Assess Service Import</i>: If each trading partner is located and registered in a different country, and the VAT on a service is liable in the buyer's country, the transaction is treated as a self-assessed services import. • <i>Zero-Rated Goods Import</i>: If the ship from country is different from the ship to country and either or both of the countries are located outside of the European Union, and the supplier is not registered in the ship to country, the transaction would be treated as an import. If the flag on the entry in the VAT Country table for the VAT reporting country indicates that only input VAT should be recorded on imports, the transaction will be treated as a zero-rated goods import.

Field or Control	Description
	<ul style="list-style-type: none"> • <i>Outside of Scope</i>: If the supplier is not registered for VAT, or if the VAT is liable in a country other than the VAT reporting country, the transaction is treated as outside the scope of VAT. • <i>No VAT Processing</i>: For transactions for which the physical nature is goods, if the ship to country has not been defined as a VAT country and the VAT reporting country on the transaction is blank, no VAT information will be recorded. <p>Within PeopleSoft, detail VAT treatment values on the transaction lines are used for applying the precise defaults that are applicable to the transaction lines. The treatment is determined based the rules that are applicable to the transaction.</p>
Applicability	<p>Displays the VAT status. Applicability is determined by an algorithm that makes use of the Applicable field in the VAT defaults table, the value of which may be set at almost every level in the PeopleSoft Purchasing VAT defaulting hierarchy. Values are:</p> <ul style="list-style-type: none"> • <i>Exempt</i> (not subject to VAT). • <i>Exonerated</i>. • <i>N/A</i> (not applicable): This is valid only when VAT treatment is No VAT Processing. • <i>Outside</i> (outside scope of VAT). • <i>Suspend</i>. • <i>Taxable</i>.
VAT Code	<p>Displays the VAT code that defines the rate at which VAT is calculated for this schedule. The default value comes from the VAT country, purchase order options, supplier, or supplier location levels in the PeopleSoft Purchasing VAT defaulting hierarchy.</p>

Field or Control	Description
Record Output VAT	Select this check box to enter vouchers in which VAT is not included on the invoice but is payable to the VAT authority rather than the supplier. In this case, you account for both input and output VAT for the purchase. This is the case for an Intra-EU Acquisition or when you must account for output VAT on a service that is supplied by a foreign supplier. This is also referred to as self-assessing for VAT. The value comes from an algorithm that uses the treatment and applicability to retrieve the applicable value from the PeopleSoft-delivered VAT system setup data.
Transaction Type	Displays the code that categorizes and classifies this transaction for VAT reporting and accounting. The default value comes from the VAT entity registration, purchase order options, supplier, or supplier location levels in the PeopleSoft Purchasing VAT defaulting hierarchy.

Adjust/Reset VAT Defaults

Any changes that you make to fields on this page may affect VAT defaults on this page. For accuracy and consistency, use the following fields to adjust affected VAT defaults or to reset all VAT defaults. Adjusting or resetting VAT defaults affects only fields that are within the **VAT Defaults** group box.

Field or Control	Description
Adjust Affected VAT Defaults	<p>Click this button to have the system adjust the VAT defaults that are affected by the changes. All changes that you have made to VAT defaults on this page that affect other VAT defaults on this page will be retained.</p> <p>Click the i button to list the fields that are to be adjusted.</p> <hr/> <p>Note: You should always click the Adjust Affected VAT Defaults button after changing any defaults on the VAT page.</p> <hr/>
Levels	<p>Enables you to specify the levels to reset when you click the Reset All VAT Defaults button. Values are:</p> <p><i>All lower levels:</i> Resets all VAT defaults at lower levels for this page.</p> <p><i>This and all lower levels:</i> Resets all VAT defaults on this page and at any lower levels of this page.</p> <p><i>This level only:</i> Resets all VAT defaults on this page.</p>

Field or Control	Description
Reset All VAT Defaults	<p>Click this button to have the system reset the VAT defaults based on the Levels value that you selected. Any changes that you previously made to VAT defaults will be lost.</p> <hr/> <p>Note: Reset completely redetermines the VAT defaults. This does not necessarily mean they are reset to their original values. For example, the user may not have changed any VAT default values, but if a VAT driver field changes, you can click Reset All VAT Defaults to redetermine all defaults based on the new driver value.</p> <hr/>

Note: The system captures all the VAT information for VAT processing to take advantage of the PeopleSoft Global Options even though some of the information may not be relevant to Vendor Rebates.

Related Links

[Preparing PeopleSoft Purchasing VAT Environments](#)

“Understanding VAT” (PeopleSoft Global Options and Reports)

Rebate Agreement - Rebate Rules Page

Use the Rebate Agreement - Rebate Rules page (VRBT_RULES) to define the different rebate rules that apply to this rebate agreement.

Navigation:

Purchasing > Vendor Rebates > Rebate Agreement > Rebate Rules

This example illustrates the fields and controls on the Rebate Agreement - Rebate Rules page. You can find definitions for the fields and controls later on this page.

Rules Summary

The fields in this group box display all the rebate rules that currently exist for this rebate agreement. This is a quick way to view a summary of the rebate rules that are associated with the rebate agreement.

Stepped or Standard Rule Type

To define a stepped or standard rule type:

1. Select *Stepped/Standard* in the **Rebate Rule Type** field.
2. (Optional) Enter a description for the rule using the **Description** field.
3. Configure the rule settings.

The field selections that you make in the Configure Rule section of the page determine how the fields in the **Rebate Tiers** group box will appear.

- Select a tier basis for the rule using the **Tier Basis** field. Values are *Amount* and *Quantity*. *Quantity* appears by default.

If you select amount, amount fields appear in the **Rebate Tiers** group box.

If you select quantity, quantity fields appear in the **Rebate Tiers** group box. Also, you will need to select a unit of measure that is associated with the quantity in the **UOM** field.

- Select a tiers in terms of setting for the rule using the **Tiers in Terms Of** field. Values are *From (Minimum)* and *To (Maximum)*. *From (Minimum)* appears by default.

If you select From (Minimum), a *From* column appears in the **Rebate Tiers** group box.

If you select To (Maximum), a *To* column appears in the **Rebate Tiers** group box.

- Select how the rebate is to be calculated for this rebate rule using the **Rebate Calculated As** field. Values are *Amount* and *Percentage*.

For stepped/standard rules, the rebate is always calculated as a *percentage*. *Amount* is not a valid selection for this rebate rule type.

4. Click the **Edit Rebate Tier Table** button.

When you click this button, the fields in the **Rebate Tiers** group box are configured to match the rule settings that you choose previously. Also, the configure rule fields are no longer available for entry.

5. Enter the terms of the rebate using the fields in the **Rebate Tiers** group box.

- Enter the *From* or *To* quantities or amounts. If you are working with quantities, the **UOM** field appears. If you are working with amounts, the **Currency** field appears.
- Enter the rebate percentage for each rebate rule line using the **Rebate %** field.

6. (Optional) Edit the rule setting fields.

If you have found that you need to change the fields that appear in the **Rebate Tiers** group box. Click the **Edit Rule Settings** button.

- Select the new field values for the rule settings.
- Click the **Edit Rebate Tier Table** button.
- Enter the new values for the rebate rule.

7. Enter rule distributions using the Rebate Agreement - Distributions for Rebate Rule page.

Click the **Rule ChartFields** link.

The rule ChartFields will appear by default from the Accounting Template, but you can override it. The Generate Vendor Rebate Claims process will retrieve and create claim distribution lines with the ChartFields from here. Then the claim distribution lines will be passed to PeopleSoft Payables or PeopleSoft Receivables when the claim is settled.

8. Save the rebate rule by clicking the **Save** button.

Flat Amount Rule Type

To define a flat amount rule type:

1. Select *Flat Amount* in the **Rebate Rule Type** field.
2. (Optional) Enter a description for the rule using the **Description** field.
3. Configure the rule settings.

The field selections that you make in the Configure Rule section of the page determine how the fields in the **Rebate Tiers** group box will appear.

- Select a tier basis for the rule using the **Tier Basis** field. Values are: *Amount* and *Quantity*. *Quantity* appears by default.

If you select amount, amount fields appear in the **Rebate Tiers** group box.

If you select quantity, quantity fields appear in the **Rebate Tiers** group box. Also, you will need to select a unit of measure associated with the quantity in the **UOM** field.

- Select a tiers in terms of setting for the rule using the **Tiers in Terms Of** field. Values are *From (Minimum)* and *To (Maximum)*. *From (Minimum)* appears by default.

If you select From (Minimum), a *From* column appears in the **Rebate Tiers** group box.

If you select To (Maximum), a *To* column appears in the **Rebate Tiers** group box.

4. Click the **Edit Rebate Tier Table** button.

When you click this button, the fields in the **Rebate Tiers** group box are configured to match the rule settings that you chose previously. Also, the configure rule fields are no longer available for entry.

5. Enter the terms of the rebate using the fields in the **Rebate Tiers** group box.

- Enter the *From* or *To* quantities or amounts. If you are working with quantities, the **UOM** field appears. If you are working with amounts, the **Currency** field appears.
- Click the **Prorate** check box to prorate the flat rebate amount.

For example, you define a rule for the purchase amount from 0 to 10,000 USD with the rebate being 100 USD. If the purchase amount is 6,000 USD and the prorate check box on the tier is clear, then the rebate amount is 100 USD. If the prorate check box is selected, then the rebate amount is 60 USD.

- Enter the flat rebate amount for each rebate rule line using the **Rebate Amount** field.

6. (Optional) Edit the rule setting fields.

If you have found that you need to change the fields that appear in the **Rebate Tiers** group box. Click the **Edit Rule Settings** button.

- Select the new field values for the rule settings.
- Click the **Edit Rebate Tier Table** button.
- Enter the new values for the rebate rule.

7. Enter rule distributions using the Rebate Agreement - Distributions for Rebate Rule page.

Click the **Rule ChartFields** link.

The rule ChartFields will appear by default from the Accounting Template, but you can override it. The Generate Vendor Rebate Claims process will retrieve and create claim distribution lines with the ChartFields from here. Then the claim distribution lines will be passed to PeopleSoft Payables or PeopleSoft Receivables when the claim is settled.

8. Save the rebate rule by clicking the **Save** button.

Growth Bonus Rule Type

To define a growth bonus rule type:

1. Select *Growth Bonus* in the **Rebate Rule Type** field.
2. (Optional) Enter a description for the rule using the **Description** field.
3. Configure the rule settings.

The field selections that you make in the Configure Rule section of the page determine how the fields in the **Rebate Tiers** group box will appear.

- Select a tier basis for the rule using the **Tier Basis** field. Values are *Amount* and *Quantity*. *Quantity* appears by default.

If you select amount, amount fields appear in the **Rebate Tiers** group box.

If you select quantity, quantity fields appear in the **Rebate Tiers** group box. Also, you will need to select a unit of measure that is associated with the quantity in the **UOM** field.

- Select a tiers in terms of setting for the rule using the **Tiers in Terms Of** field. Values are *From (Minimum)* and *To (Maximum)*. *From (Minimum)* appears by default.

If you select *From (Minimum)*, a *From* column appears in the **Rebate Tiers** group box.

If you select *To (Maximum)*, a *To* column appears in the **Rebate Tiers** group box.

- Select how the rebate is to be calculated for this rebate rule using the **Rebate Calculated As** field. Values are *Amount* and *Percentage*.

4. Click the **Edit Rebate Tier Table** button.

When you click this button, the fields in the **Rebate Tiers** group box are configured to match the rule settings that you chose previously. Also, the configure rule fields are no longer available for entry.

5. Enter the items or categories to associate with the growth bonus rule type using the **Eligible Items and Categories for Growth Bonus** group box.

Select a line type using the **Line Type** field. Values are *Item* and *Category*.

If you select *Item* as a line type, then select an item ID and enter a rebate basis amount using the **Basis Amount** field.

If you select *Category* as a line type, then select a category and enter a rebate basis amount using the **Basis Amount** field.

If you select item or category as the line type and quantity as the tier basis, then enter an item ID or a category and enter a rebate basis amount as well as a rebate basis quantity.

6. Enter the terms of the rebate using the fields in the **Rebate Tiers** group box.

- Enter the *From* or *To* quantities or amounts. If you are working with quantities, the **UOM** field appears. If you are working with amounts, the **Currency** field appears.

- Enter the rebate percentage for each rebate rule line using the **Rebate %** field.
7. (Optional) Edit the rule setting fields.

If you have found that you need to change the fields that appear in the **Rebate Tiers** group box, click the **Edit Rule Settings** button.

 - Select the new field values for the rule settings.
 - Click the **Edit Rebate Tier Table** button.
 - Enter the new values for the rebate rule.
 8. Enter rule distributions using the Rebate Agreement - Distributions for Rebate Rule page.

Click the **Rule ChartFields** link.

The rule ChartFields will appear by default from the Accounting Template, but you can override it. The Generate Vendor Rebate Claims process will retrieve and create claim distribution lines with the ChartFields from here. Then the claim distribution lines will be passed to PeopleSoft Payables or PeopleSoft Receivables when the claim is settled.
 9. Save the rebate rule by clicking the **Save** button.

Marketing Contribution Rule Type

To define a marketing contribution rule type:

1. Select *Marketing Contribution* in the **Rebate Rule Type** field.
2. (Optional) Enter a description for the rule using the **Description** field.
3. Enter the terms of the rebate using the **Previous Period Basis Amount**, **Rebate Amount**, or **Rebate %** (rebate percentage) fields.
4. Enter rule distributions using the Rebate Agreement - Distributions for Rebate Rule page.

Click the **Rule ChartFields** link.

The rule ChartFields will appear by default from the Accounting Template, but you can override it. The Generate Vendor Rebate Claims process will retrieve and create claim distribution lines with the ChartFields from here. Then the claim distribution lines will be passed to PeopleSoft Payables or PeopleSoft Receivables when the claim is settled.

5. Save the rebate rule by clicking the **Save** button.

Retrospective Rule Type

To define a retrospective rule type, follow the same procedure as you would to define a stepped or standard rule type. The only difference is that you select a **Rebate Rule Type** of *Retrospective*.

Dispatching Vendor Rebate Agreements

This section provides an overview of vendor rebate agreement dispatch and discusses how to dispatch vendor rebate agreements.

Page Used to Dispatch Vendor Rebate Agreements

<i>Page Name</i>	<i>Definition Name</i>	<i>Usage</i>
Vendor Rebate Agreement Dispatch Page	RUN_DISP_POVRBT100	Initiate the Vendor Rebate Dispatch SQR Report process (POVR100), Rebate Dispatch Email Application Engine process (PO_VR_EMAIL), or Rebate Dispatch & Email multiprocess job (VRBTDISP).

Understanding Vendor Rebate Agreement Dispatch

You can dispatch a vendor rebate agreement in two ways. You can dispatch a rebate agreement online using the Rebate Agreement - Rebate Agreement page or you can dispatch rebate agreements using the batch Rebate Dispatch & Email multiprocess job.

Use the Vendor Rebate Agreement Dispatch page to schedule a background batch job that dispatches a single rebate agreement or multiple rebate agreements that meet the selection criteria. After rebate agreements have been successfully dispatched, their statuses are updated to *Dispatched*.

Related Links

[Defining Vendor Rebate Agreements](#)

Vendor Rebate Agreement Dispatch Page

Use the Vendor Rebate Agreement Dispatch page (RUN_DISP_POVRBT100) to initiate the Vendor Rebate Dispatch SQR Report process (POVR100), Rebate Dispatch Email Application Engine process (PO_VR_EMAIL), or Rebate Dispatch & Email multiprocess job (VRBTDISP).

Navigation:

Purchasing > Vendor Rebates > Rebate Dispatch > Vendor Rebate Agreement Dispatch

This example illustrates the fields and controls on the Vendor Rebate Agreement Dispatch page. You can find definitions for the fields and controls later on this page.

Process Request Parameters

<i>Field or Control</i>	<i>Description</i>
SetID	Select the vendor rebate agreement SetID.
Rebate ID	Select a vendor rebate agreement.
Fax Cover Page	<p>Select a fax cover page if some of the rebate agreements that you are dispatching are to be sent by fax. Define fax cover letters in the system on the Fax Cover Letters page.</p> <p>The Vendor Rebate Dispatch process writes to the fax control file the file name that is associated with the selected cover letter combined with the cover letter file extension that you defined on the Dispatch Configuration page.</p> <hr/> <p>Note: Support for fax cover pages is purely a function of the fax software that you use. Please consult the fax software supplier to identify the limitations and capabilities of the fax cover page support in the software.</p> <hr/>

Dispatch Methods to Include

Select which dispatch methods to include in this run of the process. Selected values are used only as a part of the data selection criteria. To change the method by which the rebate agreement is to be dispatched, you must modify the dispatch method on the Rebate Agreement - Rebate Agreement page.

Miscellaneous Options

<i>Field or Control</i>	<i>Description</i>
Test Dispatch	Select to perform a test run of the dispatch. When you select this option, the process runs, but the rebate agreements that are processed do not appear in Dispatched status, and the rebate agreements are printed with the word Unauthorized at the bottom. This enables you to test the email or fax setup without updating the system.
Print Copy	Select to produce a printed copy of each processed rebate agreement. If any of the processed rebate agreements are by phone, fax, or email, the system prints a hard copy for review.
Print Duplicate	Select to print the word Duplicate on each rebate agreement.

Generating Rebate Accruals

Understanding the Rebate Accrual Process

The Rebate Accrual Application Engine process (PO_VRBTACCR) calculates earned rebates for transactions that are related to purchase orders, such as receipts, vouchers, and return to vendors (RTVs).

The Rebate Accrual process identifies all purchase order lines that have vendor rebate agreements defined. Then the system finds all associated receipts, vouchers, and RTVs to calculate the rebate and generate accrual records for those source transactions based on the rebate agreement terms and rules. During the processing of the different transactions, the system converts amounts and quantities to the currency and rule unit of measure on the vendor rebate agreement. The sum of these amounts and quantities becomes the basis for calculating the vendor rebate. The basis is referred to as the rebateable amount and rebateable quantity.

The rebate accrual records provide visibility to the rebate manager on the estimated earned rebates for analysis purposes, but also serve as the basis for the claim generation. The final rebate should be calculated based on the actual amount that you pay to the supplier for the goods that you order and receive. But with the analysis objective in mind, the accruals process will generate accruals records spontaneously as soon as the receipt transactions are available in the system. That is, the rebate amount is calculated based on the purchase-order estimated price and the received quantity. Later, when the voucher is entered and available, the accruals process will recalculate the final rebate based on the information on the voucher and update the accrual records. Of course, if the voucher is already entered and available at the time when the receipt transaction is being processed, the accruals process calculates the rebate amount based directly on the voucher information to avoid an unnecessary step.

The accruals process also supports purchase orders without receipts, such as direct shipments or purchase orders for which the receipt is optional. In these cases, the voucher serves as the source transaction to generate accruals records.

Finally, for return To vendor shipment transactions, the Rebate Accrual process will or will not calculate and generate rebate adjustments depending on the rebate agreement terms.

For analysis purposes, the rebate accrual records that are generated will have two levels of details:

- Header level, which corresponds to the total rebate that is calculated for the source transaction.
- Details level, which corresponds to the rebate that is calculated for each of the rebate agreement rules.

The Rebate Accrual process can be run on demand for one or multiple rebate agreements, or run automatically at the time of claim generation for the rebate agreement that is being processed.

The Rebate Accrual process can be initiated from these pages:

- Rebate Accrual.
- Generate Claims.

Note: The accuracy of the rebate information that is available for vendor rebate analysis depends on the Rebate Accrual process and how often you perform that process. The volume of information to be processed by the Rebate Accrual process can be very large and the processing time could take awhile. You should determine an appropriate frequency for the run of the process so that business requirements are met and the process is able to finish in a reasonable amount of time.

Restricted and Unrestricted Access

Rebate managers can initiate the Rebate Accrual process using the Rebate Accrual page. Rebate managers select the vendor rebate agreements that they want to process and then run the process.

The vendor rebate agreements that are available for selection on the Rebate Accrual page are determined by the rebate manager's access rights. When you set up PeopleSoft Purchasing, you can specify which rebate managers have unrestricted access rights. You give the rebate manager unrestricted access by selecting the **Unrestricted Rebate Manager** check box on the User Preferences: Procurement - Rebate Authorizations page.

If you are a rebate manager who does not have unrestricted access, then you can initiate the Rebate Accrual process only for your rebates.

If you are a rebate manager and have unrestricted access, then you can initiate the Rebate Accrual process for any vendor rebate agreements that are associated with any rebate manager.

See “User Preferences – Rebate Authorizations Page” (Application Fundamentals).

Common Processing for Rebate Transactions

For each of the eligible source transactions that are related to purchase order lines that have vendor rebate agreements defined, such as receipt, voucher, or RTV shipment transactions, the Rebate Accrual process first looks at the related transactions that are available for the source transactions to determine the applicable scenario to be processed. Then the process performs the rebate calculation and generation for each of the rules that are defined on the rebate agreement.

Note: Purchase orders require matching, receipts require processing, vouchers require posting, and RTVs must be in *Shipped* status to be considered for rebate accrual.

For example, assume that a receipt is the source transaction. Then the system verifies whether the related voucher exists and is eligible, matched, and posted. If the voucher covers the receipt totally or partially, based on the information that is available, the Rebate Accrual process processes the receipt as a receipt without a voucher, as a receipt partially vouchered, or as a receipt fully vouchered.

Note: To view an explanation of the different scenarios that can occur, see the subsequent section *Accruals Generation Upon Transactions*.

The rebate calculation and generation for each of the rules defined on the rebate agreement includes a series of functions, such as currency conversion, unit of measure conversion, rebate calculation based on the rule configuration for the rebate agreement, and rebate recalculation based on changes to the source transactions or other factors such as rebate agreement changes or modification of the rebate accruals balance on the rebate agreement.

The Rebate Accrual process performs these functions for each transaction that is associated with a vendor rebate agreement:

- Currency conversion:

The Rebate Accrual process converts the amounts for the different transactions that it processes to the vendor rebate agreement currency.

- Unit of measure (UOM) conversion:

The Rebate Accrual process converts the transaction UOMs for the different transactions that it processes to the vendor rebate agreement rule UOMs.

- Vendor rebate recalculation:

Accrual records are generated from the source transactions that are related to the purchase orders and to the terms and rules of the rebate agreement. Changes to the source transactions or to the rebate agreements might affect the earned rebates. Therefore, the Rebate Accrual process includes a function to detect changes that are made after the generation of the original rebate accrual to automatically recalculate the accruals as appropriate. Changes include rebate agreement change, source transaction change (receipt quantity change), and purchase orders that are dissociated from the rebate agreement or newly associated with the rebate agreement (using the Backdate Vendor Rebates page). Due to the nature of the retrospective and growth bonus rules types, rebate recalculation might also be necessary when new source transactions are entered into the system even if none of the changes that have been discussed occur. This function takes care of such situations.

When the Rebate Accrual process performs the recalculation function, the accrual records might have already been included in a claim, and are therefore no longer available for update. To not lose the history in such a situation, the Rebate Accrual process recalculates the rebate for the source transaction, but instead of updating the existing accrual records, it generates child accrual records with the difference between the new rebate and the old rebate. This mechanism is referred to as the rebate accruals split.

To view examples of rebate accruals split, see the subsequent section *Accruals Generation Upon Transactions*.

- Vendor rebate calculation for each vendor rebate agreement rule type:

The Rebate Accrual process calculates the vendor rebate for each vendor rebate agreement rule type. The rule types that it can calculate for are stepped/standard, retrospective, flat amount, growth bonus, and marketing contribution.

Stepped/Standard Rule Type:

Assume that:

Purchases between 0 USD and 100,000 USD receive 1 percent rebate.

Purchases between 100,001 USD and 500,000 USD receive 2 percent rebate.

As of date purchase amount is 100,000 USD.

Total rebate amount is 1,000 USD.

If the receipt transaction amount for the purchase order is 20,000 USD, then the rebate amount for this purchase order receipt transaction is 400 USD (2 percent of 20,000 USD). So the new total rebate amount is 1,400 USD (1,000 USD + 400 USD).

Retrospective Rule Type:

Assume that:

Purchases between 0 USD and 100,000 USD receive 1 percent rebate.

Purchases between 100,001 USD and 500,000 USD receive 2 percent rebate.

As of date purchase amount is 100,000 USD.

Total rebate amount is 1,000 USD.

If the receipt transaction amount for the purchase order is 20,000 USD, then the rebate amount for this purchase order receipt transaction is 400 USD (2 percent of 20,000 USD). And because the accumulative purchase amount reaches the next threshold level, the rebate is also recalculated for the existing accrued rebate transactions of 2,000 USD (2 percent of 100,000 USD), so the new total rebate amount is 2,400 USD (2,000 USD + 400 USD).

Flat Amount Rule Type:

Assume that:

Purchases between 0 USD and 100,000 USD receive 1,000 USD rebate.

Purchases between 100,001 USD and 200,000 USD receive 2,000 USD rebate.

As of date purchase amount is 90,000 USD.

Total rebate amount is 1,000 USD.

If the receipt transaction amount for the purchase order is 20,000 USD, then the rebate amount for this purchase order receipt transaction is:

With the prorated option, 200 USD (10 percent of 2,000 USD), so the new total rebate amount is 1,200 USD (1,000 USD + 200 USD).

Note: The system calculates the 10 percent prorate factor. The prorate factor calculation is ((new purchase amount – lower level of the applicable tier) / (upper level applicable tier – lower level applicable tier)).

Without the prorated option, 2,000 USD, so the new total rebate amount is 3,000 USD (1,000 USD + 2,000 USD).

Growth Bonus Rule Type:

Assume that:

A 2 percent growth bonus is on a particular category of products under the condition that the purchasing turnover has increased by 10 percent.

As of date purchase amount is 90,000 USD for this category.

Growth Basis is 100,000 USD.

If the receipt transaction amount for the purchase order is 20,000 USD for this category, then the growth bonus rebate amount is 200 USD (2 percent of 10,000 USD).

Marketing Contribution Rule Type:

This rule type is accrued once for a vendor rebate agreement.

Example: 500 USD for Marketing Contribution.

- Rebate accruals update with updates to the vendor rebate agreement:

When the Rebate Accrual process completes the rebate accrual calculation and generation for a rebate agreement, it calculates the total accrued rebate amount and updates the rebate agreement header. It also updates the total rebateable amount and rebateable quantity at the rule level of the rebate agreement.

Accruals Generation Upon Transactions

For each of the eligible source transactions that is related to purchase order lines that have vendor rebate agreements defined, the Rebate Accrual process looks at the related transactions that are available for the source transactions to determine the processing. One of these scenarios can occur:

- Receipt source transaction:
 - New receipt and related voucher is not available (voucher is not entered or voucher is entered but not matched and not posted).

The Rebate Accrual process generates the accrual records based on the receipt information, such as received quantity, the purchase order information, such as the unit price, and the rebate agreement information. The accrual records have the transaction status set as *Received*.

Example:

Before Rebate Accrual:

Receipt

Receipt ID	Purchase Order ID	Quantity	Unit Price	Rebate
RCV01	PO001	10	10	2 percent

Voucher

Voucher ID	Purchase Order ID	Quantity	Unit Price
N/A	N/A	N/A	N/A

Accrued Rebate

Receipt ID	Purchase Order ID	Sequence	Rebate Amount	Status
N/A	N/A	N/A	N/A	N/A

After Rebate Accrual:

Accrued Rebate

Receipt ID	Purchase Order ID	Sequence	Rebate Amount	Status
RCV01	PO001	1	2 (2 percent of 100)	Received

- New receipt, related voucher is available (voucher is entered, matched, and posted) and covers the receipt fully.

The Rebate Accrual process generates the accrual records based on the receipt information, such as received quantity, the voucher information, such as the unit price, and the rebate agreement information. The accrual records have the transaction status set as *Vouchered*.

Example:

Before Rebate Accrual:

Receipt

Receipt ID	Purchase Order ID	Quantity	Unit Price	Rebate
RCV01	PO001	10	10	2 percent

Voucher

Voucher ID	Purchase Order ID	Quantity	Unit Price
VCHR01	PO001	10	11

Accrued Rebate

Receipt ID	Purchase Order ID	Sequence	Rebate Amount	Status
N/A	N/A	N/A	N/A	N/A

After Rebate Accrual:

Accrued Rebate

Receipt ID	Purchase Order ID	Sequence	Rebate Amount	Status
RCV01	PO001	1	2.2 (2 percent of 110)	Vouchered

- New receipt, related voucher is available (voucher is entered, matched, and posted) and covers the receipt partially.

The Rebate Accrual process generates the accrual records based on the receipt information, such as received quantity, the voucher information, such as the unit price, quantity vouchered, and the rebate agreement information. The rebate accruals split occurs. The vouchered portion is calculated based on the unit price from the voucher and has accrual records with the transaction status set as *Vouchered*. The portion that has not been vouchered yet is calculated based on the unit price from the purchase order and has accrual records with the transaction status as *Received*.

Example:

Before Rebate Accrual:

Receipt

Receipt ID	Purchase Order ID	Quantity	Unit Price	Rebate
RCV01	PO001	10	10	2 percent

Voucher

Voucher ID	Purchase Order ID	Quantity	Unit Price
VCHR01	PO001	6	11

Accrued Rebate

Receipt ID	Purchase Order ID	Sequence	Rebate Amount	Status
N/A	N/A	N/A	N/A	N/A

After Rebate Accrual:

Accrued Rebate

Receipt ID	Purchase Order ID	Sequence	Rebate Amount	Status
RCV01	PO001	1	0.8 (2 percent of 40)	Received
RCV01	PO001	2	1.32 (2 percent of 66)	Vouchered

- Receipt with accruals already generated with a transaction status of *Received*, and the related voucher is newly available and covers the receipt fully.

The Rebate Accrual process recalculates and updates the accrual records with the voucher information. The accrual records now have the transaction status set as *Vouchered*.

Example:

Before Rebate Accrual:

Receipt

Receipt ID	Purchase Order ID	Quantity	Unit Price	Rebate
RCV01	PO001	10	10	2 percent

Voucher

Voucher ID	Purchase Order ID	Quantity	Unit Price
VCHR01	PO001	10	11

Accrued Rebate

Receipt ID	Purchase Order ID	Sequence	Rebate Amount	Status
RCV01	PO001	1	2 (2 percent of 100)	Received

After Rebate Accrual:

Accrued Rebate

Receipt ID	Purchase Order ID	Sequence	Rebate Amount	Status
RCV01	PO001	1	2.2 (2 percent of 110)	Vouchered

- Receipt with accruals already generated with a transaction status of *Received*, and the related voucher is newly available and covers the receipt partially.

The Rebate Accrual process recalculates and updates the accrual records with the voucher information. The rebate accruals split occurs. The vouchered portion now has accrual records with the transaction status set as *Vouchered*. The portion that has not been vouchered yet is calculated based on the unit price from the purchase order and has accruals records with the transaction status as *Received*.

Example:

Before Rebate Accrual:

Receipt

Receipt ID	Purchase Order ID	Quantity	Unit Price	Rebate
RCV01	PO001	10	10	2 percent

Voucher

Voucher ID	Purchase Order ID	Quantity	Unit Price
VCHR01	PO001	6	11

Accrued Rebate

Receipt ID	Purchase Order ID	Sequence	Rebate Amount	Status
RCV01	PO001	1	2 (2 percent of 100)	Received

After Rebate Accrual:

Accrued Rebate

Receipt ID	Purchase Order ID	Sequence	Rebate Amount	Status
RCV01	PO001	1	1.32 (2 percent of 66)	Vouchered
RCV01	PO001	2	0.8 (2 percent of 40)	Received

- Voucher source transaction:

New voucher, and the receipt is not available.

The Rebate Accrual process generates the accrual records based on the voucher information, such as unit price, quantity vouchered, and the rebate agreement information. The accrual records have the transaction status set as *Vouchered*.

Example:

Before Rebate Accrual:

Receipt

Receipt ID	Purchase Order ID	Quantity	Unit Price	Rebate
N/A	N/A	N/A	N/A	N/A

Voucher

Voucher ID	Purchase Order ID	Quantity	Unit Price
VCHR01	PO001	6	11

Accrued Rebate

Receipt ID	Purchase Order ID	Sequence	Rebate Amount	Status
N/A	N/A	N/A	N/A	N/A

After Rebate Accrual:

Accrued Rebate

Receipt ID	Purchase Order ID	Sequence	Rebate Amount	Status
RCV01	PO001	1	1.32 (2 percent of 66)	Vouchered

- RTV shipment source transaction:

Note: The RTV must be in a *Shipped* status to be considered for accrual.

- New RTV shipment and related adjustment voucher is not available (voucher is not generated or generated but not posted).

The Rebate Accrual process generates the accrual records based on the RTV shipment information, such as shipped quantity, the purchase order information, such as the unit price, and the rebate agreement information. The accrual records have the transaction status set as *Returned*.

Example:

Before Rebate Accrual:

RTV

RTV ID	Purchase Order ID	Quantity	Unit Price	Rebate
RTV01	PO001	10	10	2 percent

Voucher

Voucher ID	Purchase Order ID	Quantity	Unit Price
N/A	N/A	N/A	N/A

Accrued Rebate

RTV ID	Purchase Order ID	Sequence	Rebate Amount	Status
N/A	N/A	N/A	N/A	N/A

After Rebate Accrual:

Accrued Rebate

RTV ID	Purchase Order ID	Sequence	Rebate Amount	Status
RTV01	PO001	1	- 2 (2 percent of - 100)	Returned

- New RTV shipment and related adjustment voucher will not be generated (RTV adjustment voucher option not used).

The Rebate Accrual process generates the accrual records based on the RTV shipment information, such as shipped quantity, the purchase order information, such as the unit price, and the rebate agreement information. The accrual records have the transaction status set as *Vouchered*.

Example:

Before Rebate Accrual:

RTV

RTV ID	Purchase Order ID	Quantity	Unit Price	Rebate
RTV01	PO001	10	10	2 percent

Voucher

Voucher ID	Purchase Order ID	Quantity	Unit Price
N/A	N/A	N/A	N/A

Accrued Rebate

RTV ID	Purchase Order ID	Sequence	Rebate Amount	Status
N/A	N/A	N/A	N/A	N/A

After Rebate Accrual:

Accrued Rebate

RTV ID	Purchase Order ID	Sequence	Rebate Amount	Status
RTV01	PO001	1	- 2 (2 percent of - 100)	Vouchered

- New RTV shipment and related adjustment voucher is available (voucher is generated, matched, and posted).

The Rebate Accrual process generates the accrual records based on the RTV shipment information, such as shipped quantity, the adjustment voucher information, such as the unit price, and the rebate agreement information. The accrual records have the transaction status set as *Vouchered*.

Note: The adjustment voucher cannot be partially generated for RTVs, and therefore the partial adjustment voucher scenario is not applicable for rebate accruals.

Example:

Before Rebate Accrual:

RTV

RTV ID	Purchase Order ID	Quantity	Unit Price	Rebate
RTV01	PO001	10	10	2 percent

Voucher

Voucher ID	Purchase Order ID	Quantity	Unit Price
VCHR01	PO001	10	11

Accrued Rebate

RTV ID	Purchase Order ID	Sequence	Rebate Amount	Status
N/A	N/A	N/A	N/A	N/A

After Rebate Accrual:

Accrued Rebate

RTV ID	Purchase Order ID	Sequence	Rebate Amount	Status
RTV01	PO001	1	- 2.2 (2 percent of - 110)	Vouchered

- New RTV shipment, accruals already generated with a transaction status of *Returned*, and the related adjustment voucher is newly available.

The Rebate Accrual process recalculates and updates the accrual records with the voucher information. The accrual records now have the transaction status set as *Vouchered*.

Example:

Before Rebate Accrual:

RTV

RTV ID	Purchase Order ID	Quantity	Unit Price	Rebate
RTV01	PO001	10	10	2 percent

Voucher

Voucher ID	Purchase Order ID	Quantity	Unit Price
VCHR01	PO001	10	11

Accrued Rebate

<i>RTV ID</i>	<i>Purchase Order ID</i>	<i>Sequence</i>	<i>Rebate Amount</i>	<i>Status</i>
RTV01	PO001	1	-2 (2 percent of 100)	Returned

After Rebate Accrual:

Accrued Rebate

<i>RTV ID</i>	<i>Purchase Order ID</i>	<i>Sequence</i>	<i>Rebate Amount</i>	<i>Status</i>
RTV01	PO001	1	- 2.2 (2 percent of - 110)	Vouchered

Generating Rebate Accruals

This section discusses how to generate rebate accruals.

Page Used to Generate Rebate Accruals

<i>Page Name</i>	<i>Definition Name</i>	<i>Usage</i>
<u>Rebate Accrual Page</u>	RUN_PO_VRBTACCR	Generate rebate accruals.

Rebate Accrual Page

Use the Rebate Accrual page (RUN_PO_VRBTACCR) to generate rebate accruals.

Navigation:

Purchasing > Vendor Rebates > Rebate Accrual > Rebate Accrual

<i>Field or Control</i>	<i>Description</i>
Rebate ID	<p>Select one or more vendor rebate agreements that you want to have processed by the Rebate Accrual process.</p> <hr/> <p>Note: If you do not select any vendor rebate agreements, the Rebate Accrual process processes all eligible vendor rebate agreements.</p> <hr/>

Maintaining Vendor Rebate Agreement Association with Purchase Orders

Understanding the Backdate Vendor Rebates Component Processes

In normal situations, the rebate agreement assignment on the purchase order line occurs automatically at the time of purchase order creation. However, due to business constraints in the business world, vendor rebate assignment during purchase order creation might not be possible due to the rebate agreement availability. This is similar to the beginning of a new rebate agreement period in which purchase orders need to be released but the rebate agreements are still in negotiation phase with the supplier. Another scenario that would require an association change is when the rebate agreement that is already assigned to a purchase order line is no longer applicable. The Backdate Vendor Rebates component is designed to enable you to handle all these exceptions.

The Backdate Vendor Rebates component enables the rebate manager to:

- Manually associate vendor rebate agreements with one or more purchase order lines at the same time.
- Dissociate vendor rebate agreements from one or more purchase order lines at the same time.
- Modify associated vendor rebate agreement line by line to purchase orders.

The rebate manager can associate and dissociate vendor rebate agreements in purchase order lines that are in the purchase order statuses of (*Initial, Open, Pending Approval, Approved, Dispatched, and Closed*) using this component. You cannot associate with or dissociate from purchase orders that are in a *Pending Cancel* or *Canceled* status. Note that you can retrospectively associate and dissociate vendor rebate agreements with closed purchase order lines. Also, purchase orders against which vendor rebate claims are already generated are not available for update in the Backdate Vendor Rebates component.

If the rebate manager is associating with or dissociating from a vendor rebate agreement to a purchase order that already has rebate accrual transactions, this component when you save does these actions:

- Records the new vendor rebate agreement association.
- Marks this purchase order to indicate that the related receipt and return to vendor (RTVs) transactions need to be recalculated by the Rebate Accrual Application Engine process (PO_VRBTACCR)

Also, after you perform the new vendor rebate agreement association with purchase order lines, you can view the new vendor rebate agreement association using the Maintain Purchase Order - or the Express Purchase Order - Details for Line page if you have the authorization to view or update the rebate agreement on the purchase order.

After accrued rebate transactions are generated against a purchase order line, the **Rebate ID** field is not available to be modified on the purchase order line on the Maintain Purchase Order - Purchase Order

page or the Express Purchase Order - Details for Line page. In this case, the rebate manager must use the Backdate Vendor Rebates component to change the vendor rebate agreement on the line.

If you are a rebate manager who does not have unrestricted access, then you can work with your rebate agreements only.

If you are a rebate manager and have unrestricted access, then you can work with any rebate agreements.

Related Links

[Maintain Purchase Order - Purchase Order Page](#)

[Understanding the Rebate Accrual Process](#)

“User Preferences – Rebate Authorizations Page” (Application Fundamentals)

Associating to, Dissociating from, and Modifying Associated Vendor Rebate Agreements Line by Line to Purchase Orders Manually

This section discusses how to associate to, dissociate from, and modify existing rebate agreements line by line to purchase orders.

Pages Used to Manually Associate to, Dissociate from, and Modify Associated Vendor Rebate Agreements Line by Line to Purchase Orders Manually

<i>Page Name</i>	<i>Definition Name</i>	<i>Usage</i>
Backdate Vendor Rebates Page	VRBT_BACKDATE	Maintain Vendor Rebate agreement associations with purchase orders.
Backdate Vendor Rebates - Rebate Agreement ID Lookup Page	VRBT_SEARCH_SP2	Search for vendor rebate agreements that you want to associate with the purchase order lines. Backdate Vendor Rebates Page
Backdate Vendor Rebates - Rebate Agreement ID Lookup Page	VRBT_SEARCH_SP	Search for vendor rebate agreements that you want to associate with this specific purchase order line. Backdate Vendor Rebates Page

Backdate Vendor Rebates Page

Use the Backdate Vendor Rebates page (VRBT_BACKDATE) to maintain vendor rebate agreement associations with purchase orders.

Navigation:

Purchasing > supplier Rebates > Backdate Vendor Rebates > Backdate Vendor Rebates

This example illustrates the fields and controls on the Backdate Vendor Rebates page. You can find definitions for the fields and controls later on this page.

Backdate Vendor Rebates

Search Criteria

*Supplier SetID <input type="text" value="SHARE"/>	Item ID <input type="text"/>
*Supplier ID <input type="text" value="FRA0000001"/>	Category <input type="text"/>
Supplier Location <input type="text"/>	Rebate ID <input type="text"/>
Business Unit <input type="text"/>	<input checked="" type="checkbox"/> Exclude Lines with Rebate IDs
PO Date From <input type="text"/>	
PO Date To <input type="text"/>	

Search Results

Select an action from menu, make appropriate changes to PO Lines in grid, then click Apply.

*Selected PO Lines Action

New Rebate ID

Select All - Deselect All

PO Lines Personalize | Find | View All | First 1-10 of 10 Last

PO Information	Business Unit	PO ID	Line	PO Status	Vendor Rebate ID
<input type="checkbox"/>	GBR01	0000000004		1 Dispatched	
<input type="checkbox"/>	GBR01	0000000007		1 Approved	
<input type="checkbox"/>	US001	0000000130		1 Dispatched	

The Backdate Vendor Rebates page enables you to maintain vendor rebate agreement associations with purchase order lines.

Associating Vendor Rebate Agreements with Purchase Orders

To associate a vendor rebate agreement with a purchase order:

1. Select the search criteria for the purchase order in the **Search Criteria** group box, and then click the **Get PO Lines** button.
 - Select the **Exclude Lines with Rebate IDs** check box to have the system display all purchase orders that match the search criteria and do not have a vendor rebate agreement associated with them.

Results are shown in the **PO Lines** group box at the bottom of the page. This is the normal option for associating vendor rebate agreements with purchase orders.

- Clear the **Exclude Lines with Rebate IDs** check box to have the system display all purchase orders that match the search criteria and have a vendor rebate agreement associated with them.

Results are shown in the **PO Lines** group box at the bottom of the page. Purchase orders that are not associated with a vendor rebate agreement will not appear.

2. Select *Associate New Rebate ID* in the **Selected PO Lines Action** field.
3. Enter the vendor rebate agreement that you want to associate with the purchase order lines in the **New Rebate ID** field.
4. Select the purchase order lines that you want to associate with the new rebate agreement.
5. Click the **Apply** button.

The system will display messages stating whether the modification was successful or unsuccessful.

Dissociating Vendor Rebate Agreements from Purchase Orders

To dissociate a Vendor rebate agreement from a purchase order:

1. Select the search criteria for the purchase order in the **Search Criteria** group box, and then click the **Get PO Lines** button.

Clear the **Exclude Lines with Rebate IDs** check box to have the system display all purchase orders that match the search criteria and have a vendor rebate agreement associated with them.

Results are shown in the **PO Lines** group box at the bottom of the page. Purchase orders that are not associated with a vendor rebate agreement will not appear. This is the normal option for dissociating vendor rebate agreements from purchase orders.

2. Select *Dissociate Existing Rebate IDs* in the **Selected PO Lines Action** field.
3. Select the purchase order lines that you want to dissociate a vendor rebate agreement from.
4. Click the **Apply** button.

The system will display messages stating whether the modification was successful or unsuccessful.

Modifying Associated Vendor Rebate Agreements Line by Line to Purchase Orders

To modify a associated vendor rebate agreement line by line to purchase orders:

1. Select the search criteria for the purchase order in the **Search Criteria** group box, and then click the **Get PO Lines** button.
 - Select the **Exclude Lines with Rebate IDs** check box to have the system display all purchase orders that match the search criteria and do not have a vendor rebate agreement associated with them.

Results are shown in the **PO Lines** group box at the bottom of the page.

- Clear the **Exclude Lines with Rebate IDs** check box to have the system display all purchase orders that match the search criteria and have a vendor rebate agreement associated with them.

Results are shown in the **PO Lines** group box at the bottom of the page. Purchase orders that are not associated with a vendor rebate agreement will not appear.

2. Select *Modify Rebate IDs Line-by-Line* in the **Selected PO Lines Action** field.
3. Enter the new vendor rebate agreement next to each purchase order line that you want to modify using the **New Rebate ID** field in the **PO Lines** group box.
4. Click the **Apply** button.

The system will display messages stating whether the modification was successful or unsuccessful.

Managing Vendor Rebate Claims

Understanding the Claims Management Business Process for Vendor Rebates

PeopleSoft Purchasing enables you to manage the complete life cycle of a vendor rebate claim. Using PeopleSoft Purchasing vendor rebate functionality, you can generate claims, send a formal claim to the supplier, inform PeopleSoft Payables and PeopleSoft Receivables of the accrued rebate amount and expected payment from the supplier, reconcile payments from the supplier with the claim, and finally, at any time during this claim processing, notify the rebate manager or settlement manager of the claim activity that is occurring.

To assist with the management of vendor rebate claims and the payment for those claims, PeopleSoft Purchasing developed the claims management workbench. The claims management workbench is a part of the vendor rebate functionality. Using the claims management workbench, you can perform several process actions against the claim. A few of the processes that you can initiate from the claims management workbench can also be initiated from other pages that can be reached directly from the Vendor Rebates menu in PeopleSoft Purchasing. Depending on the security settings in the environment, you can choose to initiate the processes from the claims management workbench or from an individual run control page.

When using the claims management workbench, you can perform several processes. Basically, you select the process that you want to perform using the workbench, and then click the **Submit For Processing** button. When you click this button, the Claims Management Workbench - Process Request Option page appears. After specifying the process options, you click the **OK** button. This page initiates the Process supplier Claims Application Engine process (PO_PRCSCCLAIM) or the Vendor Rebate Claim Print SQR Report process (PORB7010). The Process supplier Claims process can view the action that was requested and initiate the additional necessary processes. The Process supplier Claims process can initiate these processes:

- Defer Claim Application Engine process (PO_CLMDEFER).
- Cancel Claim Application Engine process (PO_CLMCANCEL).
- Claim Settlement Process for AP (claim settlement process for account payables) Application Engine process (PO_CLMSETTLE_AP).
- Claim Settlement Process for AR (claim settlement process for account receivables) Application Engine process (PO_CLMSETTLE_AR).
- Claims Reconciliation Application Engine process (PO_CLMRECON).
- Claim Overdue Deduction Application Engine process (PO_CLMDEDUCT).
- Claim Cancel Deduction Application Engine process (PO_CLMCANDED).

The next diagram depicts the claims management process flow for vendor rebates using the Claims Management workbench. The process includes rebate claim approvals through the Claims Management Workbench and notifications to the rebate manager and settlement manager:

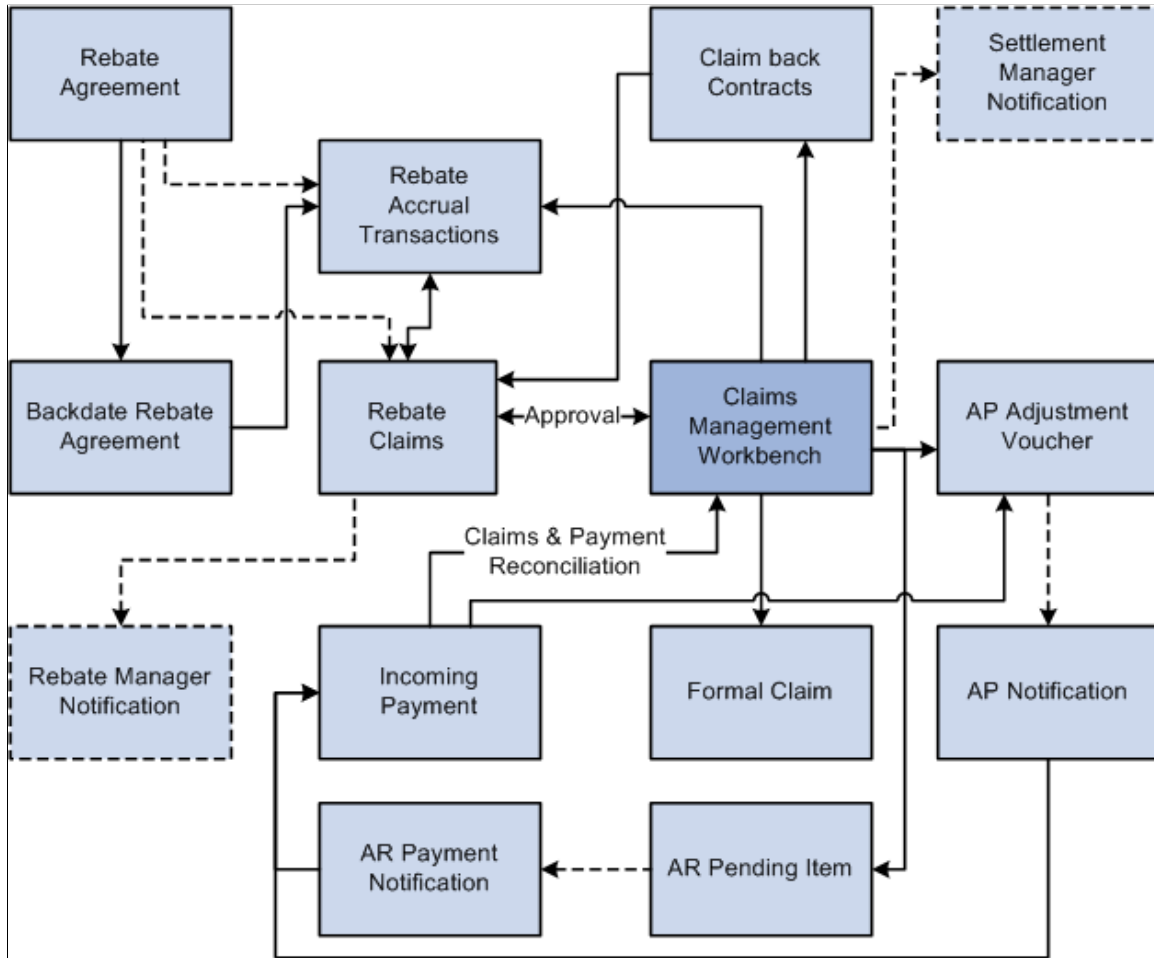

Vendor Rebate Claim Process

To process a vendor rebate claim:

Note: The vendor rebate claims process becomes available after you create a vendor rebate agreement, associate that vendor rebate agreement with a purchase order, and perform transactions (receipts, vouchers, and return To vendors) that are related to the purchase order that is associated with a vendor rebate agreement. Also, a claim will be generated for a rebate agreement only if the next claims generation date is reached.

1. (Optional) Initiate the Generate Rebate Accrual Application Engine process (PO_VRBTACCR).
The rebate accrual records serve as the basis for claim generation.
2. Initiate the Generate Vendor Rebate Claims Application Engine process (PO_GENCLAIM).
This process generates the vendor rebate claims.
3. (Optional) Initiate the Notify Rebate Manager Application Engine process (PO_VRBT_NTFY).

This process notifies the particular rebate manager of claims that were created for all vendor rebate agreements, a specific vendor rebate agreement, or a specific claim.

4. Approve the claim using the Claims Management Workbench - Rebate Claims page.

Using the Apply Claim Action or Claim Status Action fields on this page, you can approve, unapprove, or cancel a claim.

5. (Optional) Defer a claim to the next period using the Claims Management Workbench - Rebate Claims page.

- Select *Defer* in the **Apply Claim Action** field or the **Claim Status Action** field.
- Click the **Submit for Processing** button to initiate the Process Supplier Claims process. This process then initiates the Defer Claim process.

6. Perform a specific process action for the claim using the Claims Management Workbench - Rebate Claims page.

Using the **Apply Process Action** field or the *Claim Processing Action* field, you can select the process that you want to initiate for the claims, and then click the **Submit For Processing** button. The **Submit For Processing** button initiates the process that you selected to perform in the processing action field. Using these fields, you can:

- Select a process action of *Claim Settlement* to initiate the Process Supplier Claims process. This process then initiates the Claim Settlement Process for AP or the Claim Settlement Process for AR.

These processes send expected payment from the supplier to PeopleSoft Payables in the form of an adjustment voucher if the Settlement Method on the vendor rebate agreement is *Adjustment Voucher* or to PeopleSoft Receivables as a pending item if the Settlement Method on the vendor rebate agreement is *Check, Credit Memo, Direct Debit, Draft, or Electronic Funds Transfer (EFT)*.

- Select a process action of *Print for Dispatch* to initiate the Vendor Rebate Claims Print process.

This process generates a hard copy of the claim. The rebate manager can then send this claim report to the supplier.

- Select a process action of *Payment Reconciliation* to initiate the Process Supplier Claims process. This process then initiates the Claim Reconciliation process.

This process reconciles the claim with incoming payments from PeopleSoft Payables and PeopleSoft Receivables.

- Select a process action of *Overdue* to initiate the Process Supplier Claims process. This process then initiates the Claim Overdue Deduction process.

This process reverses the pending items that were previously sent to PeopleSoft Receivables, and then generates adjustment vouchers to send to PeopleSoft Payables.

- Select a process action of *Cancel Deduction* to initiate the Process Supplier Claims process. This process then initiates the Claim Cancel Deduction process.

This process reverses the adjustment vouchers (for overdue) that were previously sent to PeopleSoft Payables, and then it regenerates the pending items to send back to PeopleSoft Receivables. Once again, you are expecting to receive payment from the supplier.

7. (Optional) Save this workbench using the Claims Management Workbench - Rebate Claims page.
Click the **Save For Later** button.
8. Perform the PeopleSoft Payables vendor rebate claim processing flow for adjustment vouchers.
9. Perform the PeopleSoft Receivables vendor rebate claim processing flow for pending items.
10. (Optional) Initiate the Notify Settlement Manager Application Engine process (PO_VRBT_NTFY).
This process notifies the particular settlement manager of claim settlement activity that was created for all vendor rebate agreements, a specific vendor rebate agreement, or a specific claim.
11. View the results from all the claim and payment activity that is associated with vendor rebate claim using the Claims Management Workbench - Rebate Claims page.
The Claims Management Workbench - Rebate Claims page contains four different tabs where you can view information and current amounts for vendor rebate claims, claim settlement, claim reconciliation, and value added tax (VAT) details.
12. (Optional) View claim settlement results that are associated with a vendor rebate claim using the Claim Settlement inquiry page.

Note: If the rebate manager does not have unrestricted access, then that manager can select only vendor rebate agreements that are assigned to him or her on any pages that reference the rebate agreement.

See “User Preferences – Rebate Authorizations Page” (Application Fundamentals).

Warning! The claims management functionality in PeopleSoft Purchasing is the driver and central location for all PeopleSoft Payables and PeopleSoft Receivables transactions that are sourced for claims. You should not manually modify these claims transactions in PeopleSoft Payables or PeopleSoft Receivables because this could cause an out-of-sync situation between PeopleSoft Purchasing and the other applications.

PeopleSoft Payables Claim Processing Flow for Vendor Rebates

Before you can process claims in PeopleSoft Payables, you must have first run the Claim Settlement Process for AP using the Claims Management Workbench - Rebate Claims page. Select a process action of *Claim Settlement*.

To process an adjustment voucher (expected payment) in PeopleSoft Payables:

1. Build the adjustment vouchers that came from the Vendor rebate claim processing in PeopleSoft Purchasing to PeopleSoft Payables by initiating the Voucher Build Application Engine process (AP_VCHRBLD) using the Voucher Build page.

This process also writes the voucher information to the Incoming Payment tables for Claims Management in PeopleSoft Purchasing.

See “Understanding Voucher Build Processing” (PeopleSoft Payables).

See “Understanding Voucher Build Source Transactions” (PeopleSoft Payables).

See “Running the Voucher Build Process and Reviewing Messages” (PeopleSoft Payables).

2. Initiate the Claim Reconciliation process using the Claims Management Workbench - Rebate Claims page.

Select a process action of *Payment Reconciliation*.

This process looks at the Incoming Payment tables and reconciles the expected amount on a claim with how much was received for the claim.

Note: To adjust the claim amounts, use the Claims Management Workbench in PeopleSoft Purchasing before running the Claim Settlement Process. Do not adjust claim amounts in PeopleSoft Payables. You can also initiate the Claim Reconciliation process using the Payment Reconcile page.

PeopleSoft Receivables Claim Processing Flow for Vendor Rebates

In PeopleSoft Receivables, two different processes can occur when you are integrating with PeopleSoft Purchasing for Vendor rebate agreements. One process is for PeopleSoft Receivables to process a vendor rebate claim with a settlement method of credit memo. The other process is to process a vendor rebate claim with a settlement method of cash (check, direct debit, draft, or EFT).

Before you can process claims in PeopleSoft Receivables, you must have first run the Claim Settlement Process for AR using the Claims Management Workbench - Rebate Claims page. Select a process action of *Claim Settlement*.

To process a pending item (expected payment) in PeopleSoft Receivables (cash settlement method):

1. Post the pending items that came from the vendor rebate claim processing in PeopleSoft Purchasing to PeopleSoft Receivables by initiating the Receivables Update multiprocess job (ARUPDATE) using the Receivable Update Request page.

See “PeopleSoft Purchasing and PeopleSoft Order Management Interface” (PeopleSoft Receivables).

See “Understanding the Receivables Update Application Engine Process” (PeopleSoft Receivables).

2. If the rebate claim is reversed, use the maintenance worksheet to offset the original claim item (this process is the same as offsetting any other item).

See “Maintaining Customer Accounts Using Worksheets” (PeopleSoft Receivables).

3. Enter the cash settlement payment as a deposit in PeopleSoft Receivables to record the payment.

See “Understanding Payments and Deposits” (PeopleSoft Receivables)

4. Apply payments that are received for vendor rebate claims using the payment worksheet.

You must manually apply the payments on the payment worksheet to indicate the base and VAT amounts if any for each item.

See “Applying Payments Using Payment Worksheets” (PeopleSoft Receivables).

5. Initiate the Receivables Update process (ARUPDATE) using the Receivables Update Request page to post the payments for a vendor rebate claim.

See “Understanding the Receivables Update Application Engine Process” (PeopleSoft Receivables)

6. Initiate the AR Rebate Notification Application Engine process (AR_REBATE) using the Receivables Rebate Notification page to attach the payment information or any other change to the balance of a claim item to the Claims Incoming Payment staging table (VRBT_CLAIM_PMTI). This enables users to reconcile the payments with the original claims using the claims management workbench. This process also updates the claim balances in the claims management workbench based on payment and maintenance activity in PeopleSoft Receivables.

See “Running the AR Rebate Notification Process” (PeopleSoft Receivables).

7. Initiate the Claim Reconciliation process using the Claims Management Workbench - Rebate Claims page.

Select a process action of *Payment Reconciliation*.

This process looks at the Incoming Payment tables and reconciles the expected amount on a claim with how much was received for the claim.

It also creates a Claim Voucher with the collected amounts (VAT, claim amount, and so on).

Note: The claim voucher that is created here will not be processed by the PeopleSoft Payables pay cycle. You can also initiate the Claim Reconciliation process using the Payment Reconcile page.

8. Process the claim voucher through PeopleSoft Payables using the Voucher Build process.

To process a pending item (expected payment) in PeopleSoft Receivables (credit memo settlement method):

1. Post the pending items that came from the vendor rebate claim processing in PeopleSoft Purchasing to PeopleSoft Receivables by initiating the Receivables Update Multiprocess job (ARUPDATE) using the Receivable Update Request page.

See “PeopleSoft Purchasing and PeopleSoft Order Management Interface” (PeopleSoft Receivables).

See “Understanding the Receivables Update Application Engine Process” (PeopleSoft Receivables)

2. Initiate the Receivables Update process (ARUPDATE) using the Receivables Update Request page to post the payments for a vendor rebate claim.

This process posts the credit memo information for the claim to the Incoming Payment tables for Claims Management in PeopleSoft Purchasing.

3. Enter the credit memo in PeopleSoft Receivables as an AR item.

See “Understanding Payments and Deposits” (PeopleSoft Receivables)

4. Apply credit memo received for vendor rebate claims using the maintenance worksheet.

You must manually apply the credit memo payments on the maintenance worksheet to indicate the base and VAT amounts if any for each item.

See “Maintaining Customer Accounts Using Worksheets” (PeopleSoft Receivables).

5. Initiate the Receivables Update process (ARUPDATE) using the Receivables Update Request page to post the payments for a vendor rebate claim.
6. Initiate the AR Rebate Notification Application Engine process (AR_REBATE) using the Receivables Rebate Notification page to attach the payment information or any other change to the balance of a claim item to the Claims Incoming Payment staging table (VRBT_CLAIM_PMTI).

This enables users to reconcile the payments with the original claims using the claims management workbench. This process also updates the claim balances in the claims management workbench based on payment and maintenance activity in PeopleSoft Receivables.

See “Running the AR Rebate Notification Process” (PeopleSoft Receivables).

7. Initiate the Claim Reconciliation process using the Claims Management Workbench - Rebate Claims page.

Select a process action of *Payment Reconciliation*.

This process looks at the Incoming Payment tables and reconciles the expected amount on a claim with how much was received for the claim.

It also creates a claim voucher with the collected amounts.

Note: The claim voucher that is created here is just a regular adjustment voucher. You can also initiate the Claim Reconciliation process using the Payment Reconcile page.

8. Process the claim voucher through PeopleSoft Payables using the Voucher Build process.

Prerequisites

Before you begin working with vendor rebate claims, you should:

- Set up entry types and reasons if you are integrating with PeopleSoft Receivables.
See “Setting Up Entry Types and Reasons” (PeopleSoft Receivables).
- Set up group types and group origins if you are integrating with PeopleSoft Receivables.
You must define a group type of *R* for vendor rebates.
See “Setting Up Group Types and Group Origins” (PeopleSoft Receivables).
- Define vendor rebate PeopleSoft Receivables options for each accounts receivable business unit and claim type using the AR BU Options page.
See “Defining Account Receivables Integration Options for Vendor Rebates” (PeopleSoft Source to Settle Common Information).

Generating Vendor Rebate Claims

This section discusses how to generate vendor rebate claims.

Page Used to Generate Vendor Rebate Claims

<i>Page Name</i>	<i>Definition Name</i>	<i>Usage</i>
Generate Claims Page	VRBT_GEN_CLM_RC	Generate vendor rebate claims.

Generate Claims Page

Use the Generate Claims page (VRBT_GEN_CLM_RC) to generate Vendor rebate claims.

Navigation:

Purchasing > Vendor Rebates > Vendor Rebate Claims > Generate Claims

<i>Field or Control</i>	<i>Description</i>
Through Date	Select the date through which you want to generate claims.
Claim Run Options	Select the run option. Values are: <ul style="list-style-type: none"> <i>Specific Rebate Agreements:</i> Select this option to generate claims for a specific rebate agreement. After you select this option, select the specific SetID and rebate ID that you want to process using the SetID and Rebate ID fields in the Rebate Agreements group box. <i>All Rebate Agreements:</i> Select this option to generate claims for all rebate agreements. After you select this option, the Rebate Agreements group box is not available.

Printing a Vendor Rebate Claim

This section lists the page that is used to print a vendor rebate claim.

Note: The Vendor Rebate Claims Print page is used to initiate the Vendor Rebate Claims Print process outside of the claims management workbench. You can also initiate the Vendor Rebate Claims Print process directly from the Claims Management Workbench - Claim Details page.

Page Used to Print a Vendor Rebate Claim

<i>Page Name</i>	<i>Definition Name</i>	<i>Usage</i>
Vendor Rebate Claims Print Page	VRBT_CLAIMS_PRT_RC	Initiate the Vendor Rebate Claims Print process.

Notifying Rebate Managers of Claims

This section discusses how to notify rebate managers of claims.

Page Used to Notify Rebate Managers of Claims

<i>Page Name</i>	<i>Definition Name</i>	<i>Usage</i>
<u>Notify Rebate Manager Page</u>	VRBT_NTFY_RM_RC	Initiate the Notify Rebate Manager process.

Notify Rebate Manager Page

Use the Notify Rebate Manager page (VRBT_NTFY_RM_RC) to initiate the Notify Rebate Manager process.

Navigation:

Purchasing > Vendor Rebates > Vendor Rebate Claims > Notify Rebate Manager

<i>Field or Control</i>	<i>Description</i>
Notification Option	<p>Select the notification option. Values are:</p> <ul style="list-style-type: none"> <p><i>All Rebate IDs:</i> Select this option to notify rebate managers of vendor rebate claims that are generated for all vendor rebate agreements.</p> <p>After you select this option, select the specific SetID that you want to process using the SetID field.</p> <p><i>Specific Claim ID:</i> Select this option to notify rebate managers of a specific vendor rebate claim that was generated.</p> <p>After you select this option, select the specific claim ID that you want to process using the SetID, Rebate ID, and Claim ID fields.</p> <p><i>Specific Rebate Agreement:</i> Select this option to notify rebate managers of vendor rebate claims that are generated for a specific vendor rebate agreement.</p> <p>After you select this option, select the specific SetID and rebate ID that you want to process using the SetID and Rebate ID fields.</p>

Using the Claims Management Workbench

This section provides an overview of the Claims Management Workbench and discusses how to use the Claims Management Workbench.

Pages Used to Use the Claims Management Workbench

<i>Page Name</i>	<i>Definition Name</i>	<i>Usage</i>
Claims Management Workbench - Rebate Claims Page Claims Management Workbench - Rebate Claims Page	VRBT_CLAIM_WB	Maintain Vendor rebate claims.
Claim - Details Page	VRBT_CLAIM_DETAIL	View all the detail information for a claim. Claims Management Workbench - Rebate Claims Page
Claim Settlement Page	VRBT_CLAIM_SETTLE	View claim settlement information. Claims Management Workbench - Rebate Claims Page
Claim Reconciliation - Claim Details Page	VRBT_CLAIM_RECON	View claim reconciliation details. Claims Management Workbench - Rebate Claims Page
Claims Management Workbench - Process Request Options Page	VRBT_CLAIM_WB_PRC	Initiate the Process Supplier Claims process or the Vendor Rebate Claim Print process. The Process Supplier Claims process will perform the action that was requested in the Apply Processing Action or the Claim Processing Action fields on the Claims Management Workbench - Rebate Claims page. Claims Management Workbench - Rebate Claims Page

Understanding the Claims Management Workbench

The rebate manager can use the Claims Management Workbench after a rebate claim has been generated by the Generate Vendor Rebate Claims process. The rebate manager can use the Claims Management Workbench to:

- Review, approve, and generate a formal rebate claim to send to the supplier.

- Settle claims by sending the expected rebate claim payment to PeopleSoft Payables or to PeopleSoft Receivables.
- Reconcile incoming payments and reconcile payments with a claim ID.

In addition to the rebate claim life cycle, the Claims Management Workbench enables the rebate manager to handle outstanding situations, such as deferring a claim to the next payment cycle or creating a deduction (or reversing a deduction) that is created in the next period to address overdue payments from the supplier.

Claims Management Workbench - Rebate Claims Page

Use the Claims Management Workbench - Rebate Claims page (VRBT_CLAIM_WB) to maintain vendor rebate claims.

Navigation:

Purchasing > Vendor Rebates > Vendor Rebate Claims > Claims Management Workbench

This example illustrates the fields and controls on the Claims Management Workbench - Rebate Claims page. You can find definitions for the fields and controls later on this page.

The screenshot displays the 'Rebate Claims' interface. At the top, it shows 'SetID: SHARE' and 'User ID: VP1'. Below this, there are search criteria fields for 'Claim ID' (VRC0000000000003) and 'Supplier ID'. A 'Get Claims' button is present. To the right, there are fields for 'Rebate ID', 'Claim Status', and 'Claim Due Date', along with a 'Claims Past Due' checkbox. Below the search area, there are 'Apply Claim Action' and 'Apply Process Action' dropdowns. A table at the bottom shows a single claim entry with the following data:

Select	Claim Status	Claim Processing Action	Claim ID	Claim Status	Claim Date	Rebate ID	Supplier ID
<input type="checkbox"/>			VRC0000000000003	Open	01/17/2013	000000000000000001	SCM0000004

Before you access this page, enter the workbench ID in the Claims Management Workbench dialog box.

Field or Control	Description
Description	Enter a description for the Claims Management Workbench.

Claims Search Criteria

<i>Field or Control</i>	<i>Description</i>
Overdue Status	Select this check box if you want to work with claims that are overdue. The Overdue Status check box is selected on the claim.
Claim Due Date	Select a claim due date. The system displays all claims for which the claim due date is prior to or equal to the date that is specified.
Claims Past Due	Select this check box if you want to work with claims that are past due. The system looks at the claim due date that is entered to determine what is past due.
Get Claims	After you select the claim search criteria, click this button to have the system display in the Claims group box all of the claims that match the search criteria that is selected.

Applies To Selected Rows

Field or Control	Description
Apply Claim Action	<p>Select the claim action that you want to apply to all the claim rows that you select in the Claims group box. Claim actions are:</p> <ul style="list-style-type: none"> • <i>Approve</i>: Enables the rebate manager to change the claim ID from an <i>Open</i> claim status to an <i>Approved</i> claim status. • <i>Cancel</i>: Enables the rebate manager to change the claim ID from an <i>Open</i>, <i>Approved</i>, or <i>Deferred</i> claim status to a <i>Cancel</i> claim status only if the claim is not included in a new claim ID (the Defer Claim field is clear). • <i>Defer</i>: Enables the rebate manager to change the claim ID from an <i>Open</i> or <i>Approved</i> claim status to a <i>Deferred</i> claim status. • <i>Unapprove</i>: Enables the rebate manager to change the claim ID from an <i>Approved</i> claim status to an <i>Open</i> claim status. <p>Using this field, you can apply the claim action that you select to multiple claims. To apply a claim action to an individual claim row, select the claim action using the Claim Status Action field in the Claims group box.</p>

Field or Control	Description
<p>Apply Process Action</p>	<p>Select the process action that you want to apply to all the claim rows that you select in the Claims group box. Process actions are:</p> <ul style="list-style-type: none"> • <i>Cancel Deduction:</i> The system initiates the Process Supplier Claims process that then initiates the Claim Cancel Deduction process. This process reverses the adjustment vouchers that were previously sent to PeopleSoft Payables as overdue, and then it regenerates the pending items to send back to PeopleSoft Receivables. • <i>Claim Settlement:</i> The system initiates the Process Supplier Claims process that then initiates the Claim Settlement for AP process and the Claim Settlement for AR process. These processes send expected payment from the supplier to PeopleSoft Payables in the form of an adjustment voucher if the settlement method in the vendor rebate agreement is <i>Adjustment Voucher</i> or to PeopleSoft Receivables as a pending item if the settlement method in the vendor rebate agreement is <i>Check, Credit Memo, Direct Debit, Draft, or Electronic Funds Transfer (EFT)</i>. • <i>Overdue:</i> The system initiates the Process Supplier Claims process that then initiates the Claim Overdue Deduction process. This process reverses the pending items that were previously sent to PeopleSoft Receivables, and then it generates adjustment vouchers to send to PeopleSoft Payables. • <i>Payment Reconciliation:</i> The system initiates the Process Supplier Claims process that then initiates the Claim Reconciliation process. This process reconciles the claim with incoming payments from PeopleSoft Payables or PeopleSoft Receivables. • <i>Print for Dispatch:</i> The system initiates the Rebate Claim Print process. This process generates a hard copy of the vendor rebate claim that you can send to the supplier as a formal contract of the vendor rebate agreement. <p>Using this field, you can apply the claim action that you select to multiple claims. To apply a claim action to an individual claim row, select the claim action using the Claim Processing Action field in the Claims group box.</p>

Claims

Field or Control	Description
Select	This check box next to each claim row is used in conjunction with the Apply Claim Action , Claim Status Action , Apply Process Action , and Claim Processing Action fields. Select the claims to which you want to apply the claim action or the process action.
Claim Status Action	Select a status action for an individual claim. Claim status action values are the same as those for the Apply Claim Action field. Claim status actions are: <ul style="list-style-type: none"> • <i>Approve</i> • <i>Cancel</i> • <i>Defer</i> • <i>Unapprove</i>
Claim Processing Action	Select a claim processing action for an individual claim. Claim processing action values are the same as those for the Apply Process Action field. Claim processing actions are: <ul style="list-style-type: none"> • <i>Cancel Deduction</i> • <i>Claim Settlement</i> • <i>Overdue</i> • <i>Payment Reconciliation</i> • <i>Print for Dispatch</i>
Claim ID	Displays the claim ID. Click the Claim ID link to access the Claim - Details page. Using this page, you can view all the detail information that is associated with the claim.
Claim Status	Displays the header status for the claim.
Claim Date	Displays the claim date from the claim header.
	Click the Claim Processing Error button to view the error message that is associated with the last claim processing action performed on the claim. This button appears only if an error has occurred.

<i>Field or Control</i>	<i>Description</i>
	<p>The In Process button appears on the page when a process that you submitted is being run by the system. This button appears only if a process is currently running.</p> <p>Also, the Claim Status Action and Claim Processing Action fields are not available for entry until the requested processing action has finished and this button no longer appears.</p>

Settlement

Select the Settlement tab.

<i>Field or Control</i>	<i>Description</i>
Total Claim Amount	Displays the total claim amount in the currency of the vendor rebate agreement from the claim header.
Total Claim Collected	Displays the total claim amount that was collected in the currency of the vendor rebate agreement from the claim header.
Claim Amount Not Collected	Displays the claim amount that is available for collection in the currency of the vendor rebate agreement from the claim header.
Settlement Method	Displays the settlement method for the claim.
Claim Settlement	Click this link to access the Claim Settlement inquiry page. Using this page, you can view the details of the settlement.

Reconcile

Select the Reconcile tab.

<i>Field or Control</i>	<i>Description</i>
Recon Status (reconciliation status)	Click this link to access the Claim Reconciliation - Claim Details page. Using this page, you can view all the claim reconciliation details.

<i>Field or Control</i>	<i>Description</i>
Defer Claim	Displays the deferred claim ID. If the claim ID has been deferred and already included in a new and subsequent claim ID, the new claim ID appears here for reference. Click this link to access the Claim - Details page. Using this page, you can view the claim details for the deferred claim.

VAT Details (value-added tax details)

Select the VAT Details tab.

<i>Field or Control</i>	<i>Description</i>
Total Claim VAT	Displays the total claim VAT amount in the currency of the vendor rebate agreement for the claim header.
VAT Collected	Displays the total claim VAT amount that was collected in the currency of the vendor rebate agreement for the claim header.
VAT Amount Not Collected	Displays the total claim VAT amount that is available for collection in the currency of the vendor rebate agreement for the claim header.

Miscellaneous Information

<i>Field or Control</i>	<i>Description</i>
Save For Later	Click this button to save this claims management workbench and its associated information. At a later date, you can retrieve the workbench and continue maintaining the claim information.
Refresh	Click this button to have the system refresh the information that appears on this page.
Override Accounting Date	(Optional) Select an override accounting date to be used by the claim processing action. This date will override the claims accounting date that appears in the claim header.

<i>Field or Control</i>	<i>Description</i>
Submit For Processing	Click this button to initiate the process that is selected in either the Apply Process Action field or the Claim Processing Action field for one or more vendor rebate claims. When you click this button, the Claims Management Workbench - Process Request Options page appears. Use this page to specify request options and then initiate the selected process.

Reconciling Payments for Vendor Rebates

This section discusses how to reconcile payments for vendor rebates.

Note: The Payment Reconcile page is used to initiate the payment reconciliation process outside of the claims management workbench. You can also initiate the payment reconciliation process directly from the Claims Management Workbench - Claim Details page.

Page Used to Reconcile Payments for Vendor Rebates

<i>Page Name</i>	<i>Definition Name</i>	<i>Usage</i>
<u>Incoming Payment Reconcile Page</u>	VRBT_PYMT_RECON_RC	Initiate the Payment Reconcile Application Engine process (PO_CLMRECON).

Incoming Payment Reconcile Page

Use the Incoming Payment Reconcile page (VRBT_PYMT_RECON_RC) to initiate the Payment Reconcile Application Engine process (PO_CLMRECON).

Navigation:

Purchasing > Vendor Rebates > Vendor Rebate Claims > Incoming Payment Reconcile

Field or Control	Description
Incoming Payment Recon Option (incoming payment reconciliation option)	<p>Select the reconciliation option. Values are:</p> <ul style="list-style-type: none"> • <i>All Rebate IDs</i>: Select to reconcile incoming payments for all vendor rebate agreements. After you select this option, select the specific SetID that you want to process using the SetID field. • <i>Specific Claim ID</i>: Select to reconcile incoming payments for a specific claim ID. After you select this option, select the specific SetID, rebate ID, and claim ID that you want to process using the SetID, Rebate ID, and Claim ID fields. • <i>Specific Rebate Agreement</i>: Select to reconcile incoming payment for a specific rebate agreement. After you select this option, select the specific SetID and rebate ID that you want to process using the SetID and Rebate ID fields. <hr/> <p>Note: If you do not have unrestricted access, then you can select only the claim IDs and rebate IDs that apply to your user ID. If you have unrestricted access, you can select any claim ID or rebate ID regardless of user ID.</p> <hr/>
Accounting Date	(Optional) Select an accounting date that you want to apply for this incoming payment reconciliation process. This date overrides the accounting date for the vendor rebate agreement.

Maintaining Claims

This section provides an overview of change processing for claim amounts and discusses how to Maintain Claims

Pages Used to Maintain Claims

Page Name	Definition Name	Usage
Claim - Details Page	VRBT_CLAIM_DETAIL	Maintain claims for vendor rebate agreements.
Claim - Activities	VRBT_CLAIM_ACT_SEC	Maintain claim activities. Claim - Details Page
Claim - Distributions Page	VRBT_CLAIM_DIST	View distribution information for claim details and update claim distribution ChartFields.

Understanding Change Processing for Claim Amounts

Using the Claim - Details page, you can modify, that is, increase or decrease, the claim amount on a vendor rebate claim. For you to change the claim amount, the claim status must be *Open*, *Approved*, *Deferred*, *Pending Payment*, *Partially Paid* (if the related active claim settlement is on hold), or *Paid*.

This table describes the processing that occurs when a claim amount is changed:

Claim Status	Action	System Processing That Occurs
<i>Open</i> , <i>Approved</i> , or <i>Deferred</i>	Change the claim amount.	<ul style="list-style-type: none"> • Validate accounting date. • Recalculate total claim amount. • Recalculate VAT amounts at the header, line, and distribution levels.
<i>Pending Payment</i> (Claim settlement already sent to PeopleSoft Payables or PeopleSoft Receivables)	Change the claim amount.	<ul style="list-style-type: none"> • Validate accounting date. • Recalculate total claim amount. • Reverse pending claim settlement. • Recreate a new claim settlement with the new claim amount. • Recalculate VAT amounts at the header, line, and distribution levels. • Set claim header status to <i>Paid</i> and reconciliation status to <i>Reconciled</i> if new claim header total claim amount – total claim collected amount = 0.
<i>Partially Paid</i> and active claim settlement on hold. (Claim settlement has not been sent to PeopleSoft Payables or PeopleSoft Receivables)	Change the claim amount.	<ul style="list-style-type: none"> • Validate accounting date. • Recalculate total claim amount. • Inactivate pending claim settlement. • Recreate a new claim settlement with the new claim amount for the adjustment. • Recalculate VAT amounts at the header, line, and distribution levels. <hr/> <p>Note: The new total claim amount cannot be less than the total claim collected amount. For example, suppose that the total claim amount is 100 USD and the total claim collected amount is 40 USD. Then you cannot adjust the claim amount by decreasing for more than 60 USD.</p>

Claim Status	Action	System Processing That Occurs
<p><i>Paid</i></p> <p>(Claim settlement is complete)</p>	<p>Change the claim amount.</p>	<ul style="list-style-type: none"> • Validate accounting date. • Recalculate total claim amount. • Create a new adjustment claim settlement with the new claim amount for the adjustment. • Recalculate VAT amounts at the header, line, and distribution levels. • Set claim header status to <i>Partially Paid</i> and reconciliation status to <i>To Be Reconciled</i>. <hr/> <p>Note: The new total claim amount cannot be less than the total claim collected amount. For example, suppose that the total claim amount is 100 USD and the total claim collected amount is 90 USD. Then you cannot adjust the claim amount by decreasing for more than 10 USD.</p> <hr/>

Claim - Details Page

Use the Claim - Details page (VRBT_CLAIM_DETAIL) to maintain claims for vendor rebate agreements.

Navigation:

Purchasing > Vendor Rebates > Vendor Rebate Claims > Claim Details

This example illustrates the fields and controls on the Claim - Details page (1 of 2). You can find definitions for the fields and controls later on this page.

Claim & Details

Header

SetID: SHARE Claim ID: VRC000000000001 Claim Date: 05/27/2005 Claim Due Date: 05/27/2005 Accounting Date: 05/27/2005 <input type="text"/> Settlement Method: <input type="text" value="Check"/> AR Payment Terms: IMMED AP Payment Terms: <input type="text"/> Description: Products Rebate Agreement 1	Rebate ID: 000000000000000002 Claim Status: Pending Payment Reconciliation Status: Not Reconciled Overdue Deduction: None <input type="checkbox"/> Overdue Status Supplier SetID: SHARE Supplier ID: SCM00000004 Customer SetID: SHARE Customer ID: SCM00000004 Remit From Customer
---	---

Settlement Tolerances <table style="width: 100%; border-collapse: collapse;"> <tr> <td style="width: 50%;">Over Tolerance Percent</td> <td style="width: 50%; text-align: right;">5.00</td> </tr> <tr> <td>Over Tolerance Amount</td> <td style="text-align: right;">500.00</td> </tr> <tr> <td>Under Tolerance Percent</td> <td style="text-align: right;">5.00</td> </tr> <tr> <td>Under Tolerance Amount</td> <td style="text-align: right;">200.00</td> </tr> </table>	Over Tolerance Percent	5.00	Over Tolerance Amount	500.00	Under Tolerance Percent	5.00	Under Tolerance Amount	200.00	Amount Summary <table style="width: 100%; border-collapse: collapse;"> <tr> <td style="width: 60%;">Total Claim Amount</td> <td style="width: 20%; text-align: right;">2,054.00</td> <td style="width: 20%; text-align: right;">USD</td> </tr> <tr> <td>Total Claim Collected</td> <td style="text-align: right;">0.00</td> <td></td> </tr> </table>	Total Claim Amount	2,054.00	USD	Total Claim Collected	0.00	
Over Tolerance Percent	5.00														
Over Tolerance Amount	500.00														
Under Tolerance Percent	5.00														
Under Tolerance Amount	200.00														
Total Claim Amount	2,054.00	USD													
Total Claim Collected	0.00														

Comments:

This example illustrates the fields and controls on the Claim - Details page (2 of 2). You can find definitions for the fields and controls later on this page.

Activities

Lines Personalize | Find | View All | First 1-2 of 2 Last

Line	Defer Claim	Rebate Type	Description	Claim Amount	VAT Amount	Reason Code
1		Retrospective	Volume Rebate	54.00 USD	0.00	<input type="text"/>
3		Marketing Contribution	Marketing Contribution	2,000.00 USD	0.00	<input type="text"/>

Header

Field or Control	Description
Claim Date	Displays the claim date. You can modify this claim date if the claim status is <i>Open</i> or <i>Approved</i> . If you change the claim date, the system will recalculate the claim due date and will display a message asking whether you want to accept the new claim due date.
Claim Due Date	Displays the claim due date. You can modify this claim due date if the claim status is <i>Open</i> or <i>Approved</i> .

Field or Control	Description
Accounting Date	<p>Displays the accounting date that is used for this claim. You can modify this accounting date for a claim in any status.</p> <p>If you modify the accounting date, the system validates that the accounting date is defined in an open period for the claim.</p>
Settlement Method	<p>Displays the settlement method for the claim. You can modify this settlement method if the claim status is <i>Open</i> or <i>Approved</i>.</p> <p>If you modify the settlement method, you must enter the accounts-receivable payment terms, the accounts-payable payment terms, or both depending on the settlement method. Enter the payments terms using the AR Payment Terms (accounts receivable payment terms) or AP Payment Terms (accounts payable payment terms) fields.</p>
Remit From Customer	<p>Displays the remit from customer that is associated with the customer and supplier on the claim. This is the customer that will send the payment for the claim.</p>

Settlement Tolerances

The settlement tolerance fields appear by default from the vendor rebate agreement. You can override the tolerance settings.

Amount Summary

Field or Control	Description
Total Claim Amount and Currency	<p>Displays the total claim amount in the currency for the vendor rebate agreement. Also, the vendor rebate currency.</p>
Total Claim Collected	<p>Displays the total collected amount for the claim in the currency for the vendor rebate agreement.</p>
Total Claim VAT Amount (total claim value added tax amount)	<p>Displays the total claim VAT amount in the currency of the vendor rebate agreement. This field appears if you are using VAT functionality.</p>
VAT Collected (value added tax collected)	<p>Displays the VAT collected amount in the currency for the vendor rebate agreement. This field appears if you are using VAT functionality.</p>

Comments and Messages

Field or Control	Description
Comments	Enter claim comments. These comments appear on the Vendor Rebate Claims Print report.
Message	Displays the error message that is received from any of the batch processes that are run against the claim. This field does not appear if no messages are displayed.

Activities

Field or Control	Description
Activities	Click this link to access the Claim - Activities page. Use the page to manage the claim activities.

Lines

Field or Control	Description
Line	Displays the claim line.
Defer Claim	Displays the deferred from claim.
Rebate Type	Displays the rebate rule type.
Claim Amount and Currency	Displays the claim amount in the currency for the vendor rebate agreement. Also the currency of the vendor rebate agreement. You can modify the claim amount if the claim status is: <i>Open, Approved, Deferred, Pending Payment, Partially Paid</i> (if the related active claim settlement is on hold), or <i>Paid</i> .
VAT Amount (value added tax amount)	Displays the VAT amount in the vendor rebate agreement currency.
Reason Code	Enter a reason code if you modify the claim amount.

Field or Control	Description
	Click the Distribution button to access the Claim - Distributions page. Use this page to view distribution information for claim details and to update claim distribution ChartFields.

Claim - Distributions Page

Use the Claim - Distributions page (VRBT_CLAIM_DIST) to view distribution information for claim details and update claim distribution ChartFields.



Navigation:

Click the **Distribution** button next to a claim line in the **Lines** group box on the Claim - Details page.

This example illustrates the fields and controls on the Claim - Distributions page. You can find definitions for the fields and controls later on this page.

Claim Distributions

SetID: SHARE Claim ID: VRC0000000000001 Line: 1

Distribution Details Personalize | Find | View All |   First 1 of 1 Last

Amounts ChartFields 

Line	Rebate Type	Percent	Claim Amount	VAT Amount
1	Retrospective	100.0000	54.00 USD	

Field or Control	Description
Line	Displays the distribution line number.
Percent	Displays the distribution percent of the line amount.

ChartFields

Select the ChartFields tab.

Field or Control	Description
Type	Displays the distribution type. <i>VR Agrmnt</i> (vendor rebate agreement) appears for vendor rebate agreement claims.

Field or Control	Description
ChartFields	Displays the ChartFields that are associated with the claim distribution. You can modify the ChartFields if the claim status is <i>Open</i> or <i>Approved</i> .

Reconciling Claims

This section provides an overview of exception processing and discusses how to Reconcile Claims

Pages Used to Reconcile Claims

Page Name	Definition Name	Usage
<u>Claim Reconciliation - Claim Details Page</u>	VRBT_CLAIM_RECON	View claim reconciliation details and maintain claim payment exceptions.
<u>Claim Reconciliation - Incoming Payments Page</u>	VRBT_RECON_INPAY	View incoming payments details that are associated with a vendor rebate claim.
Voucher Payment Inquiry Page	VCHR_INQ_PYMNT	View voucher payment details.
Customer Item Inquiry Page	ITEM_LIST	View customer item payment details.

Understanding Exception Processing

Using the Claim Reconciliation - Claim Details page, you can handle exceptions that occur against claim reconciliation. You can change the reconciliation status on this page and the system performs additional processing depending on what you change the status to. This table illustrates the exception processing that can occur when you change the reconciliation status:

Exception Process to Correct	Current Reconciliation Status	Changed to Reconciliation Status	Additional System Processing
Total claim collected amount against an adjustment voucher or against a pending item that was sent to PeopleSoft Receivables is less than the under tolerance amount, or the total claim collected amount is greater than the over tolerance amount and the claims manager wants to stop further reconciliation processing.	<i>Exception</i>	<i>Reconciled</i>	When this status is changed, the system creates an adjustment claim settlement entry to clear the residual amount and then, depending on the settlement method, generates an adjustment voucher in PeopleSoft Payables or a pending item in PeopleSoft Receivables. Also, the claim status is changed from <i>Partially Paid</i> to <i>Paid</i> .

Claim Reconciliation - Claim Details Page

Use the Claim Reconciliation - Claim Details page (VRBT_CLAIM_RECON) to view claim reconciliation details and maintain claim payment exceptions.

Navigation:

Purchasing > Vendor Rebates > Vendor Rebate Claims > Claim Reconciliation

This example illustrates the fields and controls on the Claim Reconciliation - Claim Details page (1 of 2). You can find definitions for the fields and controls later on this page.

Claim Reconciliation

Claim Details

Header

SetID: SHARE	Supplier ID: SCM0000004
Claim ID: VRC0000000000001	Claim Status: Pending Payment
Rebate ID: 000000000000000002	*Reconciliation Status: Not Reconciled
Claim Date: 05/27/2005	Overdue Deduction: None <input type="checkbox"/> Overdue Status
Claim Due Date: 05/27/2005	Description: Products Rebate Agreement 1
Accounting Date: 05/27/2005	

Settlement Tolerances	Amount Summary
Over Tolerance Percent: 5.00	Total Claim Amount: 2,054.00 USD
Over Tolerance Amount: 500.00	Total Claim Adjustment: 0.00
Under Tolerance Percent: 5.00	Total Claim Collected: 0.00
Under Tolerance Amount: 200.00	

Comments:

This example illustrates the fields and controls on the Claim Reconciliation - Claim Details page (2 of 2). You can find definitions for the fields and controls later on this page.

Incoming Payments										
Settlement Personalize Find View All First 1 of 1 Last										
Details 										
Settle Seq	Status	DateTime	Settlement Method	Claim Amount		Amount Collected	Overdue Status	Hold	Reason	Description
1	Active	01/16/2007 11:00AM	Check	2054.00	USD	0.00	<input type="checkbox"/>	<input type="checkbox"/>		

Claim Lines Personalize Find View All First 1-2 of 2 Last						
Line	Defer Claim	Rebate Type	Claim Amount	Claim Adjust	Reason	Description
1		Retrospective	54.00	0.00		
3		Marketing Contribution	2000.00	0.00		

Save
 Return to Search
 Notify
 Refresh

Header and Settlement Tolerances

Most of the fields that appear in these sections on this page are the same as those that appear on the Claim - Details page.

See [Claim - Details Page](#).

Field or Control	Description
Accounting Date	<p>The accounting date appears by default as the claim date. You can override it. Select another accounting date if you want to record all the subsequent transactions that are sent to PeopleSoft Payables or PeopleSoft Receivables with this accounting date.</p> <p>Overriding the accounting date is useful in cases in which the claim life cycle is long and spans multiple accounting periods. For example, assume that you generate a claim in a particular accounting period, but due to some disputes with the supplier, you can make the decision to close outstanding remaining claim amounts only in subsequent accounting periods (previous accounting period might already be closed). Overriding the accounting date enables you to record the adjustment in the current accounting period.</p>
Claim Status	<p>Displays the current claim status. Statuses are <i>Open</i>, <i>Approved</i>, <i>Deferred</i>, <i>Pending Payment</i>, <i>Partially Paid</i>, and <i>Paid</i>.</p>
Reconciliation Status	<p>The current reconciliation status appears. Statuses are <i>Exception</i>, <i>Pending</i>, <i>Reconciled</i>, and <i>To Be Reconciled</i>.</p> <p>Change this status to handle claim payment exceptions. You can change the status from <i>Exception</i> to either <i>Reconciled</i> or <i>To Be Reconciled</i>.</p>

Amount Summary

<i>Field or Control</i>	<i>Description</i>
Total Claim Amount	Displays the total claim amount in the vendor rebate agreement currency.
Total Claim Adjustment	Displays the total claim adjustment amount in the currency for the vendor rebate agreement. Total Claim Adjustment = (Total Claim Amount – Original Claim Amount)
Total Claim Collected	Displays the total claim amount collected in the currency for the vendor rebate agreement.
Total Claim VAT Amount (total claim value added tax amount)	Displays the total claim VAT amount in the vendor rebate agreement currency. This field appears only if you are using VAT.
VAT Collected (value added tax collected)	Displays the VAT amount that is collected in the vendor rebate agreement currency. This field appears only if you are using VAT.

Settlement

<i>Field or Control</i>	<i>Description</i>
DateTime	Displays the date and time when the settlement was created.

Claim Lines

<i>Field or Control</i>	<i>Description</i>
Claim Adjust	Displays the claim adjustment amount for this claim and line in the vendor rebate agreement currency. Claim Adjust = (Claim Amount – Original Claim Amount)

Additional Links

<i>Field or Control</i>	<i>Description</i>
Incoming Payments	Click this link to access the Claim Reconciliation - Incoming Payments page. Use this page to view the claim payment details that came from PeopleSoft Payables and PeopleSoft Receivables.

Claim Reconciliation - Incoming Payments Page

Use the Claim Reconciliation - Incoming Payments page (VRBT_RECON_INPAY) to view incoming payments details that are associated with a vendor rebate claim.

Navigation:

Click the **Incoming Payments** link on the Claim Reconciliation - Claim Details page.

This example illustrates the fields and controls on the Claim Reconciliation - Incoming Payments page. You can find definitions for the fields and controls later on this page.

The screenshot shows a web application window titled "Incoming Payments". At the top, it displays "SetID SHARE" and "Claim Status Pending Payment". Below that, "Claim ID VRC0000000000001" is shown. A "Payment Details" table is present with the following columns: "Payment Date", "Settlement Method", "Amount Collected", "VAT Collected", "Processed", and "Document ID". The table has one data row with values: "1", (blank), "0.000", "0.000", a checkbox, and (blank). Navigation controls like "Personalize", "Find", "View All", "First", "1 of 1", and "Last" are visible. At the bottom, there are "OK", "Cancel", and "Refresh" buttons.

<i>Field or Control</i>	<i>Description</i>
AP Payment Reference (account payables payment reference)	Click this link to access the Voucher Inquiry page. Use this page to view all the details that are associated with this voucher.
AR Payment Reference (account receivables payment reference)	Click this link to access the Customer Item Inquiry page. Use this page to view all the details that are associated with this pending item payment.

Notifying Settlement Managers

This section discusses how to notify settlement managers.

Page Used to Notify Settlement Managers

Page Name	Definition Name	Usage
<u>Notify Settle Mgr (Notify Settlement Manager) Page</u>	VRBT_NTFY_SM_RC	Notify settlement managers by initiating the Notify Settlement Manager process.

Notify Settle Mgr (Notify Settlement Manager) Page

Use the Notify Settle Mgr (Notify Settlement Manager) page (VRBT_NTFY_SM_RC) to notify settlement managers by initiating the Notify Settlement Manager process.

Navigation:

Purchasing > Vendor Rebates > Vendor Rebate Claims > Notify Settlement Manager > Notify Settle Mgr

Field or Control	Description
Notification Option	<p>Select the notification option. Values are:</p> <ul style="list-style-type: none"> • <i>All Rebate IDs</i>: Select to notify settlement managers of claim settlement activity for all vendor rebate agreements. After you select this option, select the specific SetID that you want to process using the SetID field. • <i>Specific Claim ID</i>: Select to notify settlement managers of claim settlement activity for a specific claim. After you select this option, select the specific claim ID that you want to process using the SetID, Rebate ID, and Claim ID fields. • <i>Specific Rebate Agreement</i>: Select to notify settlement managers of claim settlement activity for a specific vendor rebate agreement. After you select this option, select the specific SetID and rebate ID that you want to process using the SetID and Rebate ID fields.

Viewing Claim Settlement Information

This section discusses how to view claim settlement information.

Page Used to View Claim Settlement Information

Page Name	Definition Name	Usage
<u>Claim Settlement Page</u>	VRBT_CLAIM_SETTLE	View information that is associated with a vendor rebate claim settlement.

Claim Settlement Page

Use the Claim Settlement page (VRBT_CLAIM_SETTLE) to view information that is associated with a vendor rebate claim settlement.

Navigation:

Purchasing > Vendor Rebates > Vendor Rebate Claims > Claim Settlement Inquiry

This example illustrates the fields and controls on the Claim Settlement page. You can find definitions for the fields and controls later on this page.

Claim Settlement Inquiry

SetID: SHARE	Claim Status: Pending Payment
Claim ID: VRC0000000000001	Reconciliation Status: Not Reconciled
Claim Date: 05/27/2005	Supplier ID: SCM0000004
Claim Due Date: 05/27/2005	Rebate ID: 000000000000000002

Personalize | Find | View All | | | First 1 of 1 Last

Settle Seq	Status	Date Time	Settlement Method	Claim Amount	Amount Collected	Overdue Status	Hold	Reason	Description	From AR Payment
1	Active	01/16/2007 11:00AM	Check	2054.00 USD	0.00	<input type="checkbox"/>	<input type="checkbox"/>			<input type="checkbox"/>

Save
 Return to Search
 Notify

Note: You can view the same information that appears on this page using the claims management workbench. This page is useful for those individuals who only need to inquire on the information that is associated with a claim and do not require update capability.

Details

<i>Field or Control</i>	<i>Description</i>
From AR Payment (from accounts receivable payment)	Indicates that the voucher has been created to account for the payment that is recorded in PeopleSoft Receivables.

Entering Claim Payments Manually

This section provides an overview of the manual entry of claim payments and discusses how to enter claim payments manually.

Page Used to Enter Claim Payments Manually

<i>Page Name</i>	<i>Definition Name</i>	<i>Usage</i>
<u>Claim Incoming Payment Page</u>	VRBT_CLAIM_INPAY	Enter claim payments manually.

Understanding the Manual Entry of Claim Payments

The Claim Incoming Payment component enables you to manually record incoming claim payments from external systems. If you are not using PeopleSoft Payables or PeopleSoft Receivables to collect vendors' rebate claim payments, then you would use this component to enter claim payments.

Note: This Claim Incoming Payment component should not be used if you are using PeopleSoft Receivables to collect suppliers' rebate claim payments. In this case, you should remove user access to this component.

Claim Incoming Payment Page

Use the Claim Incoming Payment page (VRBT_CLAIM_INPAY) to enter claim payments manually.

Navigation:

Purchasing > Vendor Rebates > Vendor Rebate Claims > Claim Incoming Payment

This example illustrates the fields and controls on the Claim Incoming Pay page. You can find definitions for the fields and controls later on this page.

Claim Incoming Payment

Header

SetID SHARE	Claim Status Pending Payment	
Rebate ID 0000000000000000002	Description Products Rebate Agreement 1	
Claim ID VRC000000000000001	Amount Summary	
Claim Date 05/27/2005	Total Claim Amount	2,054.00 USD
Claim Due 05/27/2005	Total Claim Collected	
Settlement Method Check	Total Claim VAT	
	VAT Collected	

Incoming Payments Find | View All | First 1 of 1 Last

Settle Seq 1	Amount Collected <input type="text" value="2,054.00"/> USD
Payment Date <input type="text" value="01/14/2013"/> <small>BY</small>	VAT Collected <input type="text"/>
Settlement Method <input type="text" value="Check"/>	<input type="checkbox"/> Processing Flag
AP Payment Reference <input type="text"/>	
AR Payment Reference <input type="text"/>	

Header and Amount Summary

The fields in this section of the page are the same as those discussed on the Claim - Details page.

See [Claim - Details Page](#).

Incoming Payments

Field or Control	Description
Amount Collected	The amount collected in the rebate agreement currency appears by default from the claim settlement. You can override the amount collected.
VAT Collected (value added tax collected)	The VAT amount collected in the rebate agreement currency appears by default from the claim settlement. You can override the VAT amount collected.
Processing Flag	Indicates whether the incoming transaction has been processed by the reconciliation process. When you manually enter a new claim payment, this check box is cleared.
AP Payment Reference (accounts payable payment reference)	Enter the reference of the payables payment transaction from the payables legacy system.
AR Payment Reference (accounts receivable payment reference)	Enter the reference of the receivables payment transaction from the receivables legacy system.
Save Payment	Click this button to save the incoming claim payment.

Analyzing Vendor Rebates

Understanding the Vendor Rebate Analysis Workbench

The vendor rebate analysis workbench is a tool that is used to assist rebate managers with vendor rebate analysis. Using the vendor rebate analysis workbench, a rebate manager can:

- Manage earned rebates by keeping track of rebate allocations among sales organizations.
- Analyze accumulative purchases and earned rebates for each vendor rebate agreement, which includes details of open purchase orders, receipts, and vouchers that have been associated with the vendor rebate agreement.
- View the next rebate level approaching a threshold.
- View transactional information from accrued rebate details.
- Generate reports of threshold analysis and open purchase order information.
- Extract accrued rebate transaction data to a flat file.

Note: The accuracy of the rebate information that is available for vendor rebate analysis depends on the Rebate Accrual process and how often you perform that process. The volume of information to be processed by the Rebate Accrual process can be very large and the processing time could take awhile. You should determine an appropriate frequency for the run of the process so that business requirements are met and the process is able to finish in a reasonable amount of time.

Vendor Rebate Analysis Process

To use the vendor rebate analysis workbench:

1. Select the vendor rebate agreements that you want to include for analysis using the Vendor Rebate Analysis Workbench - Workbench Filter Options page.
2. View claim and rebate summary activity using the Vendor Rebate Analysis Workbench page.
3. Perform additional vendor rebate analysis.
 - a. Select one or more of the vendor rebate agreements that you want to perform additional analysis processing for by selecting the check box next to each vendor rebate agreement in the **List of supplier Rebates** group box on the Vendor Rebate Analysis Workbench page.
 - b. Select the type of additional processing that you want to perform for the supplier rebates using the **Select Row For** field on the Vendor Rebate Analysis Workbench page.

Select *Threshold & Time Period Only* (threshold and time period analysis) to perform a threshold and time period analysis for the supplier rebates that you selected.

Select *PO Not Received Report* to generate the PO Not Received report for the supplier rebates that you selected.

Select *Rebate Threshold Report* to generate the Rebate Threshold report for the supplier rebates selected.

Select *Extract Accrued Dtls to File* (extract accrued details to file) to generate a flat file containing the accrued details for the vendor rebates that you selected.

- c. Select the time period to be used for the threshold and time period analysis using the **View Results by Time Period** field on the Vendor Rebate Analysis Workbench page.

Note: Time period is applicable only for the threshold and time period analysis.

- d. Click the **OK** button on the Vendor Rebate Analysis Workbench page.
- e. View the information that is rendered by the processing action that you requested.

The process that you requested in the **Select Row For** field determines what page appears next.

Use the Vendor Rebate Analysis Workbench - Rebate Threshold Analysis page to view the vendor rebate threshold and time period analysis for the supplier rebates that you selected.

Use the supplier Rebate Analysis Workbench - PO Not Received Report page to generate the PO Not Received report for the supplier rebates that you selected.

Use the supplier Rebate Analysis Workbench - Rebate Threshold Report page to generate the Rebate Threshold report for the supplier rebates that you selected.

Use the supplier Rebate Analysis Workbench - Flat File Extraction on Rebate Transactions page to generate a flat file of the accrued details for the supplier rebates that you selected.

4. (Optional) Save this version of the supplier Rebate Analysis Workbench for use at a later date by clicking the **Save Workbench** button on the supplier Rebate Analysis Workbench page.

Defining Sales Organizations

To define sales organizations to be used with supplier rebates, use the Sales Organization Setup component (VRBT_SALES_ORG).

This section discusses how to define sales organizations.

Page Used to Define Sales Organizations

<i>Page Name</i>	<i>Definition Name</i>	<i>Usage</i>
Sales Organization Setup Page	VRBT_SLS_ORG_SETUP	Define the sales organizations that you want to allocate earned rebates to in PeopleSoft Purchasing. You can associate a PeopleSoft Order Management business unit to the sales organization if you have also implemented PeopleSoft Order Management.

Sales Organization Setup Page

Use the Sales Organization Setup page (VRBT_SLS_ORG_SETUP) to define the sales organizations that you want to allocate earned rebates to in PeopleSoft Purchasing.

You can associate a PeopleSoft Order Management business unit to the sales organization if you have also implemented PeopleSoft Order Management.

Navigation:

Purchasing > supplier Rebates > supplier Rebate Analysis > Sales Organization Setup

<i>Field or Control</i>	<i>Description</i>
OM Business Unit (PeopleSoft Order Management business unit)	<p>Select the PeopleSoft Order Management business unit to associate with the sales organization.</p> <p>If you want to use a PeopleSoft Order Management business unit for fund allocation, you must create a sales organization and associate this sales organization to the PeopleSoft Order Management business unit to perform vendor rebate allocations.</p> <hr/> <p>Note: Only one sales organization can exist per PeopleSoft Order Management business unit and only one set of contact information can exist, which is contact, email, and phone information.</p> <hr/>

Establishing Vendor Rebate Allocations

This section lists prerequisites and discusses how to establish vendor rebate allocations.

Page Used to Establish Vendor Rebate Allocations

<i>Page Name</i>	<i>Definition Name</i>	<i>Usage</i>
<u>Vendor Rebate Allocation Page</u>	VRBT_ALLOC_DTLS	Allocate the earned rebate from the supplier to the sales organizations. Use this page to capture the allocation percentage for history and analysis purposes. The accounts allocation itself will be manually done through the PeopleSoft General Ledger.

Prerequisites

Before you can establish vendor rebate allocations, you need to define a sales organization.

See Defining Sales Organizations.

Vendor Rebate Allocation Page

Use the Vendor Rebate Allocation page (VRBT_ALLOC_DTLS) to allocate the earned rebate from the supplier to the sales organizations.

Use this page to capture the allocation percentage for history and analysis purposes. The accounts allocation itself will be manually done through the PeopleSoft General Ledger.

Navigation:

Purchasing > supplier Rebates > supplier Rebate Analysis > Vendor Rebate Allocation

Note: If rebate managers do not have unrestricted access, then they can select only Vendor Rebate agreements assigned to them.

See “User Preferences – Rebate Authorizations Page” (Application Fundamentals).

This example illustrates the fields and controls on the Vendor Rebate Allocation page. You can find definitions for the fields and controls later on this page.

Vendor Rebate Allocation

SetID SHARE
 Rebate ID 000000000000000004 Corp. Rebate Agreement 2005
 Supplier ID SCM0000002 CAMPER'S-001
 Rebate Begin Date 01/01/2005 Rebate Expire Date 12/31/2005
 Total Accrued Rebate Total Rebate Payment Received
 Total Allocated Amount Amount Available to Allocate

Vendor Rebate Allocation Find | View All First 1 of 1 Last

Reference Number *Allocation Date 01/14/2013

Allocation Description

Amount to Allocate

Allocation Line Personalize | Find | View All First 1 of 1 Last

Alloc Line	*Alloc Percent	*Allocated Amount	Description	*Sales Organization ID	Sales Organization Name	OM Business Unit		
1	100.0000	<input type="text"/>	<input type="text"/>	US001 <input type="button" value="🔍"/>	NY Operations	US001	<input type="button" value="+"/>	<input type="button" value="-"/>

Field or Control	Description
Total Accrued Rebate	Displays the total accrued rebate amount for this vendor rebate agreement as of today.
Total Rebate Payment Received	Displays the total rebate payment received amount for this vendor rebate agreement.
Total Allocated Amount	Displays the total allocated amount for this vendor rebate agreement.
Amount Available to Allocate	Displays the amount available to allocate for this vendor rebate agreement. Amount Available to Allocate = (Total Rebate Payment Received – Total Allocated Amount)

Vendor Rebate Allocation

Field or Control	Description
Allocation Date	The date for today appears by default. You can select another allocation date.

Field or Control	Description
Amount to Allocate and Allocated Amount	<p>Select the amount that you want to allocate to the sales organizations.</p> <p>When you insert a new allocation row, this field label appears as Amount to Allocate. After you complete the allocation, the field label appears as Allocated Amount.</p> <p>If no other allocations currently exist for this vendor rebate agreement, the Total Rebate Payment Received amount appears by default. If other allocations exist, the Amount Available to Allocate amount appears by default. You can enter a different amount.</p>

Allocation Line

Field or Control	Description
Alloc Percent (allocation percent)	<p>Select the allocation percent. 100 percent appears by default. The allocation percent for all the allocation lines together must be less than or equal to 100 percent.</p> <p>If you change the allocation percent, the system automatically calculates and displays the new allocated amount for the line in the grid.</p>
Allocated Amount	<p>Displays the allocated amount that you want to associate with this particular sales organization.</p> <p>$\text{Allocated Amount} = (\text{Allocation Percent} \times \text{Amt to Allocate or Allocated Amount (in the header portion of page)})$</p>
Description	Enter a description for this allocation line.
Sales Organization ID	Select the sales organization that you want to associate with this allocation amount.

Analyzing Vendor Rebates

This section discusses how to Analyze Vendor Rebates:

Pages Used to Analyze Vendor Rebates

Page Name	Definition Name	Usage
<u>Vendor Rebate Analysis Workbench - Workbench Filter Options Page</u>	VRBT_ANLY_WB_SRCH	Enter filter options for the Vendor Rebate Analysis Workbench.
Supplier Search Page	VNDR_LOOKUP_SEC	Search for available suppliers. <u>Vendor Rebate Analysis Workbench - Workbench Filter Options Page</u>
<u>Vendor Rebate Analysis Workbench Page</u>	VRBT_ANLY_WB	Perform analysis on a Vendor Rebate agreement.
Rebate Agreement - Rebate Agreement Page	VRBT_HDR	View the complete Vendor Rebate agreement. <u>Vendor Rebate Analysis Workbench - Rebate Threshold Analysis Page</u>
<u>Vendor Rebate Analysis Workbench - Accrued Rebate Details Page</u>	VRBT_ACCR_INQ	View accrued rebate transaction details.
Purchase Order Inquiry - Purchase Order Page	PO_LINE_INQ	View the complete purchase order with all its details. <u>Vendor Rebate Analysis Workbench - Accrued Rebate Details Page</u>
Receipts Page	RECV_INQ	View the receipt details. <u>Vendor Rebate Analysis Workbench - Accrued Rebate Details Page</u>
<u>Vendor Rebate Allocation Page</u>	VRBT_ALLOC_DTLS	View the Vendor Rebate allocation to the sales organizations.
<u>Vendor Rebate Analysis Workbench - Rebate Threshold Analysis Page</u>	VRBT_THRSHLD_ANLY	Perform threshold analysis for a rebate agreement. Threshold analysis assists rebate managers in analyzing the extent of additional purchases that are required to optimize the rebate amount.
<u>Vendor Rebate Analysis Workbench - PO Not Received Analysis Page</u>	VRBT_PO_NRCVD	View purchase orders that are still open that are associated with the Vendor Rebate agreements.
Vendor Rebate Analysis Workbench - Rebate Threshold Report Page	VRBT_SERVER_RPT2	Initiate the Rebate Threshold Report SQR Report process (POVRB200).

Page Name	Definition Name	Usage
Vendor Rebate Analysis Workbench - PO Not Received Report Page	VRBT_SERVER_RPT2	Initiate the PO Not Received Report SQR Report process (POVRB300).
<u>Vendor Rebate Analysis Workbench - Flat File Extraction on Rebate Transactions Page</u>	VRBT_PRINT_OPTION	Initiate the Flat File Extraction Application Engine process (VRBT_FILEXT), which creates a flat file containing the Vendor Rebate transactions.
Save Workbench Page	VRBT_SAVE_WB_SBP	Save a Vendor Rebate analysis workbench for later retrieval and use. <u>Vendor Rebate Analysis Workbench Page</u>

Vendor Rebate Analysis Workbench - Workbench Filter Options Page

Use the Vendor Rebate Analysis Workbench - Workbench Filter Options page (VRBT_ANLY_WB_SRCH) to enter filter options for the Vendor Rebate Analysis Workbench.

Navigation:

Purchasing > Vendor Rebates > Vendor Rebate Analysis > Rebate Analysis Workbench > Vendor Rebate Analysis Workbench - Workbench Filter Options

Field or Control	Description
Supplier Search	Click this link to access the Supplier Search page. Use this page to search for suppliers.
Transaction Accrued From	Select the from date on which to search for Vendor Rebate accrued transactions. In Add mode, January 1st of the current year appears by default.
Transaction Accrued To	Select the to date on which to search for Vendor Rebate accrued transactions. In Add mode, the current date appears by default.
Rebate ID	Select the Vendor Rebate agreement that you want to analyze on the workbench. Only approved Vendor Rebate agreements are available for selection. Also, the Vendor Rebate agreements that are available for selection is determined by the rebate manager's access right. If you are a rebate manager who does not have unrestricted access, then you can view and select only your rebate agreements. If you are a rebate manager and have unrestricted access, then you can view and select any rebate agreements that are associated with any rebate manager.

Field or Control	Description
Rebate Rule Type	Select the rebate rule type. Leave this field blank to have the system retrieve all transactions for all rebate rule types that are associated with the Vendor Rebate agreement on the Vendor Rebate Analysis Workbench.
Claim Status	Select the claim status. Leave this field blank to have the system retrieve all transactions for all claim statuses that are associated with the Vendor Rebate agreement on the Vendor Rebate Analysis Workbench page.
View Workbench	After you enter filter options, click this button to display the Vendor Rebate analysis workbench populated with the information that matches the filter options that you selected.

Vendor Rebate Analysis Workbench Page

Use the Vendor Rebate Analysis Workbench page (VRBT_ANLY_WB) to perform analysis on a Vendor Rebate Agreement.

Navigation:

Click the **View Workbench** button on the Vendor Rebate Analysis Workbench - Workbench Filter Options page.

Vendor Rebate Analysis Workbench Page

Vendor Rebate Analysis Workbench
 SetID: SHARE
 WorkBench ID: 1
 Description: Accrued Rebate Details
 Select Vendor Rebate(s) for Further Report Analysis

Select Rows For: Threshold & Time Period Only View Results by Time Period: Monthly

List of Vendor Rebates Personalize | Find | View All | | First 1 of 1 | Last

Supplier ID	Rebate ID	Total Rebate Amt on Sel Trans	Total Claim Collected	Total VAT Claim Collected	Total Claim Adjustment	Total Allocated Rebate Amount		
<input type="checkbox"/> SCM0000004	00000000000000000002	2,054.00 USD					Accrued Rebate Details	Vendor Rebate Allocation Details

Select All Clear All

[Set Filter Options](#)

Field or Control	Description
Select Rows For	<p>Select the type of activity that you want to perform for the Supplier rebates that you select. Activities are:</p> <ul style="list-style-type: none"> • <i>Extract Accrued Dtls to File</i>: When you select this activity, the Vendor Rebate Analysis Workbench - Flat File Extraction on Rebate Transactions page appears. Use this page to extract the accrued rebate details to a flat file. See Vendor Rebate Analysis Workbench - Flat File Extraction on Rebate Transactions Page. • <i>PO Not Received Report</i> (purchase order not received report): When you select this activity, the Vendor Rebate Analysis Workbench - PO Not Received Report page appears. Use this page to initiate the PO Not Received SQR Report process (POVRB300). See PeopleSoft Purchasing Reports. • <i>Rebate Threshold Report</i>: When you select this activity, the Vendor Rebate Analysis Workbench - Rebate Threshold Report page appears. Use this page to generate the Rebate Threshold Report SQR Report process (POVRB200). See PeopleSoft Purchasing Reports. • <i>Threshold & Time Period Anly</i> (threshold and time period analysis): When you select this activity along with a view results by time period option, the Rebate Threshold and Time Period Analysis page appears populated with the Vendor Rebate information that is associated with the Vendor rebates that you selected. Use this page to perform threshold and time period analysis for Vendor rebates. See Vendor Rebate Analysis Workbench - Rebate Threshold Analysis Page.
OK	<p>Click this button to have the system perform the process that you requested in the Select Rows For field.</p> <hr/> <p>Note: You must select at least one Vendor Rebate agreement in the List of Supplier Rebates group box before any process occurs.</p> <hr/>

Field or Control	Description
View Results by Time Period	<p>Select the time period that you want to use to view the Vendor Rebate analysis. Time periods are:</p> <ul style="list-style-type: none"> • <i>Monthly.</i> • <i>Quarterly.</i> • <i>Yearly.</i> <p>This field is available only if you select <i>Threshold & Time Period Any</i> in the Select Rows For field.</p>

List of Vendor Rebates

Field or Control	Description
Selection	<p>Select this check box next to the Vendor rebates that you want to analyze. You can analyze one or more rebates at the same time.</p>
Rebate ID	<p>Click a rebate ID link to access the Rebate Agreement - Rebate Agreement page. Use this page to view all the details of this Vendor Rebate agreement.</p>
Total Rebate Amt on Sel Trans (total rebate amount on selected transactions) and Currency	<p>Displays the total rebate amount in the rebate currency for the selected transactions.</p> <p>The total rebate amount on selected transactions equals the sum of transaction line rebate amounts on the Vendor Rebate Analysis Workbench - Accrued Rebate Details page that match the filter options that you selected.</p>
Total Claim Collected	<p>Displays the total collected amount for a Vendor Rebate in the rebate currency.</p> <p>The total claim collected equals the sum of total claimed amount for all claims that are associated with the transaction lines on the Vendor Rebate Analysis Workbench - Accrued Rebate Details page that match the filter options that you selected.</p>

Field or Control	Description
Total VAT Claim Collected (total value added tax claim collected)	<p>Displays the total VAT claim collected amount in the rebate currency.</p> <p>The total VAT claim collected equals the sum of total claimed collected VAT amount for all claims that are associated with the transaction lines on the Vendor Rebate Analysis Workbench - Accrued Rebate Details page that match the filter options that you selected.</p>
Total Claim Adjustment	<p>Displays the total claim adjustment amount.</p> <p>The total claim adjustment equals the sum of the difference between the total claim amount minus the original total claim amount for each claim that is associated with the transaction lines on the Vendor Rebate Analysis Workbench - Accrued Rebate Details page that match the filter options that you selected.</p>
Total Allocated Rebate Amount	<p>Displays the total allocated rebate amount for the rebate agreement.</p>
Accrued Rebate Details	<p>Click this link to access the Vendor Rebate Analysis Workbench - Accrued Rebate Details page. Use this page to view the accrued rebate details for this Vendor Rebate agreement.</p>
Vendor Rebate Allocation Details	<p>Click this link to access the Vendor Rebate Allocation page. Use this page to view the rebate allocation details for this vendor rebate and the sales organizations.</p> <p>See Establishing Vendor Rebate Allocations.</p>

Rebate to Date Activity

Select the Rebate to date Activity tab.

Field or Control	Description
Total Accrued Rebate	<p>Displays the total accrued amount for the vendor rebate agreement.</p>
Total Rebate Payment Received	<p>Displays the total payment received amount for the vendor rebate agreement.</p>

<i>Field or Control</i>	<i>Description</i>
Total Pending Rebate Amount	Displays the total pending amount for the vendor rebate agreement.

Miscellaneous Information

<i>Field or Control</i>	<i>Description</i>
Save Workbench	Click this button to access the Save Workbench page. Use this page to save this vendor rebate analysis workbench and its associated information, including the filter options that you entered. At a later date, you can retrieve the workbench and continue to perform rebate analysis.
Set Filter Options	Click this link to access the Vendor Rebate Analysis Workbench - Workbench Filter Options page. Use this page to maintain the different filter options for this workbench.

Vendor Rebate Analysis Workbench - Accrued Rebate Details Page

Use the Vendor Rebate Analysis Workbench - Accrued Rebate Details page (VRBT_ACCR_INQ) to view accrued rebate transaction details.

Navigation:

- Click the **Accrued Rebate Details** link in the **List of Vendor Rebates** group box on the Claim to date Activity tab on the supplier Rebate Analysis Workbench page.
- After selecting transactions, then select *Threshold & Time Period Only* in the **Select Rows For** field and click the **OK** button on the Vendor Rebate Analysis Workbench page.

Click the **Accrued Rebate Details for Rule** link in the **List of Vendor Rebates** group box on the Rebate Rule Details tab on the Vendor Rebate Analysis Workbench - Rebate Threshold Analysis page.

Vendor Rebate Analysis Workbench - Accrued Rebate Details page

Vendor Rebate Analysis Workbench																																																																												
Accrued Rebate Details																																																																												
Supplier SetID		SHARE																																																																										
Rebate ID				000000000000000002			Products Rebate Agreement 1																																																																					
Supplier ID				SCM0000004			ERNIE'S BIKE SHOP																																																																					
List of Accrued Rebate Details Personalize Find View All First 1-5 of 5 Last																																																																												
<table border="1"> <thead> <tr> <th>Transaction Date</th> <th>Rebate Amount</th> <th>Item ID</th> <th>Category</th> <th>Sequence</th> <th>Trans Status</th> <th>Rebate Rule Type</th> <th>Rule Number</th> <th>Rebateable Amount</th> <th>Rebateable Quantity</th> <th>Rebate UOM</th> </tr> </thead> <tbody> <tr> <td>05/27/2005</td> <td>2000.000</td> <td></td> <td></td> <td></td> <td>1 Vouchered</td> <td>Marketing Contribution</td> <td>3</td> <td></td> <td>USD</td> <td></td> </tr> <tr> <td>05/27/2005</td> <td>25.500</td> <td>10015</td> <td>CYCLING</td> <td></td> <td>1 Received</td> <td>Retrospective</td> <td>1</td> <td>2550.000 USD</td> <td>100.0000</td> <td></td> </tr> <tr> <td>05/27/2005</td> <td></td> <td>10015</td> <td>CYCLING</td> <td></td> <td>1 Received</td> <td>Growth Bonus</td> <td>2</td> <td>2550.000 USD</td> <td>100.0000</td> <td></td> </tr> <tr> <td>05/27/2005</td> <td>28.500</td> <td>10017</td> <td>CYCLING</td> <td></td> <td>1 Received</td> <td>Retrospective</td> <td>1</td> <td>2850.000 USD</td> <td>100.0000</td> <td></td> </tr> <tr> <td>05/27/2005</td> <td></td> <td>10017</td> <td>CYCLING</td> <td></td> <td>2 Received</td> <td>Growth Bonus</td> <td>2</td> <td>2850.000 USD</td> <td>100.0000</td> <td></td> </tr> </tbody> </table>											Transaction Date	Rebate Amount	Item ID	Category	Sequence	Trans Status	Rebate Rule Type	Rule Number	Rebateable Amount	Rebateable Quantity	Rebate UOM	05/27/2005	2000.000				1 Vouchered	Marketing Contribution	3		USD		05/27/2005	25.500	10015	CYCLING		1 Received	Retrospective	1	2550.000 USD	100.0000		05/27/2005		10015	CYCLING		1 Received	Growth Bonus	2	2550.000 USD	100.0000		05/27/2005	28.500	10017	CYCLING		1 Received	Retrospective	1	2850.000 USD	100.0000		05/27/2005		10017	CYCLING		2 Received	Growth Bonus	2	2850.000 USD	100.0000	
Transaction Date	Rebate Amount	Item ID	Category	Sequence	Trans Status	Rebate Rule Type	Rule Number	Rebateable Amount	Rebateable Quantity	Rebate UOM																																																																		
05/27/2005	2000.000				1 Vouchered	Marketing Contribution	3		USD																																																																			
05/27/2005	25.500	10015	CYCLING		1 Received	Retrospective	1	2550.000 USD	100.0000																																																																			
05/27/2005		10015	CYCLING		1 Received	Growth Bonus	2	2550.000 USD	100.0000																																																																			
05/27/2005	28.500	10017	CYCLING		1 Received	Retrospective	1	2850.000 USD	100.0000																																																																			
05/27/2005		10017	CYCLING		2 Received	Growth Bonus	2	2850.000 USD	100.0000																																																																			
Return																																																																												

Rebate Details

Displays the rebate accruals that were generated by the Generate Rebate Accrual process for the rebate agreement that you selected and according to the filter options that you selected.

See [Generating Rebate Accruals](#).

Field or Control	Description
Rebate Amount	Displays the rebate amount for this transaction.
Trans Status (transaction status)	<p>Displays the particular transaction status for the rebate accrual record. For example, if the transaction is a receipt transaction and the related voucher was not available at the time of rebate accruals generation, then the transaction status is <i>Received</i>.</p> <p>If the voucher was available for the receipt transaction at the time of rebate accruals generation or if the transaction is related to a voucher, then the transaction status is <i>Vouchered</i>.</p> <p>See Understanding the Rebate Accrual Process.</p>
Rebateable Amount and Currency	<p>Displays the rebateable amount in the vendor rebate currency for this transaction.</p> <p>This amount comes from the rebate accrual records that were generated by the Generate Rebate Accrual process for the receipt, voucher, or RTV transaction. The rebateable amount corresponds to the basis amount for rebate calculation.</p>

Field or Control	Description
Rebateable Quantity and (VRBT UOM) (vendor rebate agreement unit of measure)	<p>Displays the rebateable quantity in the vendor rebate unit of measure for this transaction.</p> <p>This quantity comes from the rebate accrual records that were generated by the Generate Rebate Accrual process for the receipt, voucher, or RTV transaction. The rebateable quantity corresponds to the basis quantity for rebate calculation.</p>

Purchase Order

Use the Purchase Order Inquiry - Purchase Order page (PO_LINE_INQ) to view the complete purchase order with all its details.

Navigation:

- Click a **Purchase Order** link on the PO tab on the supplier Rebate Analysis Workbench - Accrued Rebate Details page.
- After selecting transactions, then select *Threshold & Time Period Only* in the **Select Rows For** field and click the **OK** button on the supplier Rebate Analysis Workbench page.

Click the **Total Open PO Amount** link in the **List of supplier Rebates** group box on the supplier Rebate Analysis Workbench - Rebate Threshold Analysis page.

Click a **Purchase Order** link on the supplier Rebate Analysis Workbench - PO Not Received Analysis page.

Select the PO tab.

Field or Control	Description
Purchase Order	Click this link to access the Purchase Order Inquiry - Purchase Order page. Use this page to view all the purchase order information that is associated with this purchase order.
Merchandise Amount	Displays the merchandise amount for this transaction.

Receipt

Select the Receipt tab.

Field or Control	Description
Receiver ID Number	Click this link to access the Receipts inquiry page. Use this page to view all the details that are associated with this receipt.

Claim

Select the **Claim** tab.

Field or Control	Description
Claim Number	Displays the claim number that is associated with the rebate accrual if the rebate accrual has already been processed by the claim generation. Click this link to access the Claim - Details page. Use this page to view all the information that is associated with this claim.
Total Claim Amount	Displays the total claim amount.
Total Claimed Amount	Displays the total claimed amount.

Vendor Rebate Analysis Workbench - Rebate Threshold Analysis Page

Use the Vendor Rebate Analysis Workbench - Rebate Threshold Analysis page (VRBT_THRSHLD_ANLY) to perform threshold analysis for a rebate agreement.

Threshold analysis assists rebate managers in analyzing the extent of additional purchases that are required to optimize the rebate amount.

Navigation:

After selecting transactions, then select *Threshold & Time Period Only* in the **Select Rows For** field and click the **OK** button on the supplier Rebate Analysis Workbench page.

This example illustrates the fields and controls on the Vendor Rebate Analysis Workbench - Rebate Threshold Analysis page. You can find definitions for the fields and controls later on this page.

Supplier ID	Rebate ID	Rule Number	Rebate Rule Type	UOM	Next Threshold Level	Estimated Additional Purchase Amount	Estimate Rebate Amount	Total Open PO Amount
SCM0000004	00000000000000000002	1	Retrospective		10000.000	4,600.00 USD	200.00	5544.5
SCM0000004	00000000000000000002	2	Growth Bonus		Not Applicable		USD	2346
SCM0000004	00000000000000000002	3	Marketing Contribution		Not Applicable		USD	5544.5

<i>Field or Control</i>	<i>Description</i>
View Results by Time Period	Select a time period, and then click the OK button to have the system redisplay the rebate threshold analysis information for that time period.

Next Threshold

<i>Field or Control</i>	<i>Description</i>
Rebate ID	Click a rebate ID link to access the Rebate Agreement - Rebate Agreement page. Use this page to view all the details of this vendor rebate agreement.
Next Threshold Level	<p>Displays the next threshold level amount or quantity depending on the rebate agreement rule definition. This threshold level is determined based on either the current rebateable amount or current rebateable quantity.</p> <hr/> <p>Note: This field is applicable only for retrospective rebate rule types.</p>
Estimated Additional Purchase Amount	<p>Displays the estimated amount of purchases that are required to reach the next threshold level for the vendor rebate.</p> <p>Estimated Additional Purchase Amount = (Next Threshold Level – Current Rebateable Amount)</p> <hr/> <p>Note: This field is applicable only for retrospective rebate rule types and amount based rules.</p>
Estimated Additional Purchase Quantity	<p>Displays the estimated quantity of purchases that are required to reach the next threshold level for the vendor rebate.</p> <p>Estimated Additional Purchase Quantity = (Next Threshold Level – Current Rebateable Quantity)</p> <hr/> <p>Note: This field is applicable only for retrospective rebate rule types and quantity based rules.</p>

Field or Control	Description
Estimate Rebate Amount	<p>Displays the estimated rebate amount if the next threshold is reached for the vendor rebate. This amount is based on the rebate agreement rule and the rule details.</p> <p>If the rebate factor qualifier is percentage and the rebate tier basis equals amount, then Estimate Rebate Amount = (Next Threshold Level (lower) Amount × Rebate Factor).</p> <p>If the rebate factor qualifier is percentage and the rebate tier basis equals quantity, then the estimated rebate amount cannot be determined because purchase amount cannot be determined.</p> <p>If the rebate factor qualifier is amount and the rebate tier basis equals amount or quantity, then Estimate Rebate Amount = (Rebate Factor of the Next Threshold Level + the sum of the rebate factor for all the lower threshold levels).</p>
Total Open PO Amount (total open purchase order amount)	<p>Click this linked value to access the Vendor Rebate Analysis Workbench - PO Not Received Analysis page. Use this page to view purchase order schedules that are associated with the vendor rebate that have not been received or vouchered.</p>

Rebate Rule Details

Select the Rebate Rule Details tab.

Field or Control	Description
Accrued Rebate Details for Rule	<p>Click this link to access the Vendor Rebate Analysis Workbench - Accrued Rebate Details page. Use this page to view accrued rebate details for the vendor rebate agreement rule.</p>

Current Rebate

Select the Current Rebate tab.

Field or Control	Description
Current Rebateable Quantity	<p>Displays the current rebateable quantity for the rebate agreement rule according to the filter options that you selected.</p> <p>Current rebateable quantity equals the sum of all the accepted quantity in the vendor rebate unit of measure.</p>

Field or Control	Description
Current Rebateable Amount	Displays the current rebateable amount for the rebate agreement rule according to the filter options that you selected. Current rebateable amount equals the sum of all rebateable amounts in the vendor rebate currency for all accrued details.
Total Accrued Rebate	Displays the total accrued rebate amount for the rebate agreement rule according to the filter options that you selected.
Total Purchases to Date	Displays the total purchases to date amount for the vendor rebate.

Time Period Analysis

Select the Time Period Analysis tab.

This section of the page is very dynamic. Depending on the time period that you select, you will view different time period columns in the **List of Supplier Rebates** group box. For example, if you select a monthly time period, you will view monthly columns with the rebate amount shown for each month.

The columns that appear on this page are based on the time period that you selected and the header start date and end date for the vendor rebate agreement. If the end date is in the future, the current system date is used.

Vendor Rebate Analysis Workbench - PO Not Received Analysis Page

Use the Vendor Rebate Analysis Workbench - PO Not Received Analysis page (VRBT_PO_NRCVD) to view purchase orders that are still open that are associated with the vendor rebate agreements.

Navigation:

Click the **Total Open PO Amount** link in the **List of supplier Rebates** group box on the supplier Rebate Analysis Workbench - Rebate Threshold Analysis page.

This example illustrates the fields and controls on the Vendor Rebate Analysis Workbench - PO Not Received Analysis page. You can find definitions for the fields and controls later on this page.

Vendor Rebate Analysis Workbench

PO Not Received Analysis

SetID SHARE
 Rebate ID 00000000000000000000 Products Rebate Agreement 1
 Supplier ID SCM0000004 ERNIE'S BIKE SHOP
 Rule Number/Type/Tiers Basis 1/Retropective/Amount Vendor Rebate UOM
 Total Purchases to Date 5400.000 USD Total Open PO Qty
 Total Open PO Amount 5544.500

PO Line Schedules Tied to Current Rebate That Have Not Yet Been Received or Vouchered. Personalize | Find | View All | First 7-12 of 56 Last

Due Date	Open Merchandise Amount	PO Quantity Not Received	PO Qty	UOM	Business Unit	Purchase Order	PO Status	Line	Sched
04/19/2006	150.00	15.0000	15.0000	EA	US001	0000000145	Approved	3	2
04/20/2006	27.50	5.0000	5.0000	EA	US001	0000000171	Dispatched	1	2
04/20/2006	85.00	10.0000	10.0000	EA	US001	0000000187	Dispatched	1	1
04/20/2006	8.50	1.0000	1.0000	EA	US001	0000000188	Dispatched	1	1
04/23/2006	285.00	10.0000	10.0000	EA	US001	0000000187	Dispatched	2	1
04/23/2006	142.50	5.0000	5.0000	EA	US001	0000000188	Dispatched	2	1

[Return](#)

Field or Control	Description
Total Purchases to Date	Displays the total purchases to date amount for this vendor rebate.
Total Open PO Amount (total open purchase order amount)	Displays the total open purchase order amount for this vendor rebate agreement rule.
Total Open PO Qty (total open purchase order quantity)	Displays the total open purchase order quantity for this vendor rebate agreement rule. The total open purchase order quantity is not relevant to the amount based rule.
Purchase Order	Click this link to access the Purchase Order Inquiry - Purchase Order page. Use this page to view the details for this purchase order.

Vendor Rebate Analysis Workbench - Flat File Extraction on Rebate Transactions Page

Use the Vendor Rebate Analysis Workbench - Flat File Extraction on Rebate Transactions page (VRBT_PRINT_OPTION) to initiate the Flat File Extraction Application Engine process (VRBT_FILEXT), which creates a flat file containing the vendor rebate transactions.

Navigation:

After selecting transactions, then select *Extract Accrued Dtls to File* in the **Select Rows For** field and click the **OK** button on the supplier Rebate Analysis Workbench page.

Field or Control	Description
Report Destination	Enter the location where you want the flat file to be stored.

Flat File Layout

The system creates the flat file using this file layout:

Field	Field Description
SETID	SetID
VRBT_ID	Vendor rebate ID
BUSINESS_UNIT_PO	Purchasing business unit
PO_ID	Purchase order ID
PO_LINE_NBR	Purchase order line number
PO_SCHED_NBR	Purchase order schedule number
VRBT_TRANS_TYPE	Vendor rebate transaction type
BUSINESS_UNIT	Business unit This is the business unit that is associated with the document ID. It can be a PeopleSoft Purchasing receiving business unit if the document ID is a receipt or a PeopleSoft Payables business unit if the document ID is a voucher.
DOC_ID	Document ID
LINE_NBR	Line number
RECV_SHIP_SEQ	Receiving shipment sequence number
SEQ_NUM	Sequence number
TRANS_DATE	Transaction date

Field	Field Description
ITM_SETID	Item SetID
INV_ITEM_ID	Item ID
CATEGORY_ID	Category ID
SUPPLIER_SETID	Supplier SetID
SUPPLIER_ID	Supplier ID
VRBT_TRANS_STATUS	Vendor rebate transaction status
MERCHANDISE_AMT	Merchandise amount
CURRENCY_CD	Currency code
VRBT_RULE_ID	Vendor rebate rule ID
VRBT_RULE_TYPE	Vendor rebate rule type
RBTABLE_AMT	Rebateable amount
RBTABLE_QTY	Rebateable quantity
UNIT_MEASURE_VRBT	Vendor rebate unit of measure
REBATE_AMOUNT	Rebate amount
TOTAL_CLAIMED_AM	Total claimed amount
CLAIM_ID	Claim ID
CLAIM_STATUS	Claim status
TOTAL_CLAIM_AMT	Total claim amount
TOT_CLAIM_VAT	Total claim value added tax amount

Field	Field Description
TOT_CLAIM_COLLEC	Total claim collected amount
TOT_VAT_COLLECT	Total value added tax collected amount
TOT_CLAIM_ADJ_AM	Total claim adjustment amount

Chapter 20

Approving Supplier User Registration Using the PeopleSoft Fluid User Interface

Approving Supplier User Registration Using the PeopleSoft Fluid User Interface

This topic discusses approving supplier user registrations using the PeopleSoft Fluid User Interface.

Note: If users have the authority to approve suppliers using the Fluid approval component, then these users are redirected to fluid approval user interface, and the classic approval component is hidden from the menu. Otherwise, the classic approval component displays on the menu, and a user can access the classic approval pages from the EC worklist or from the classic work center.

Pages Used to Approve Supplier User Registrations in the PeopleSoft Fluid User Interface

<i>Page Name</i>	<i>Definition Name</i>	<i>Usage</i>
<u>Pending Approvals - User Registration Page</u>	EOAWMA_MAIN_FL	Use this page to view a list of all supplier user registration transactions that are pending your approval.
<u>User Registration - Approval Header Detail Page</u>	EOAWMA_TXNHDTL_FL	Use this page to review user account and supplier information, and approve or deny the supplier user registration.
<u>Associated Roles Page</u>	SUP_USR_ROLES_FL	Use this page to view roles associated with a specific supplier user.
<u>Associated Permission Lists Page</u>	SUP_USR_PERMLST_FL	Use this page to view permission lists associated with a specific supplier user.

Understanding Supplier User Registration Approval Using the Fluid User Interface

PeopleSoft provides mobile approvals using the Enterprise Component Fluid Approvals framework. Approvers can take Application Workflow Engine (AWE) actions on select PeopleSoft transactions pending their approval using the Fluid User Interface.

Using the **Approvals** tile on the Employee Self Service page, you can manage approvals for supplier user registration. These are requests from existing suppliers to access the supplier portal.

Approvals tile in the Fluid User Interface

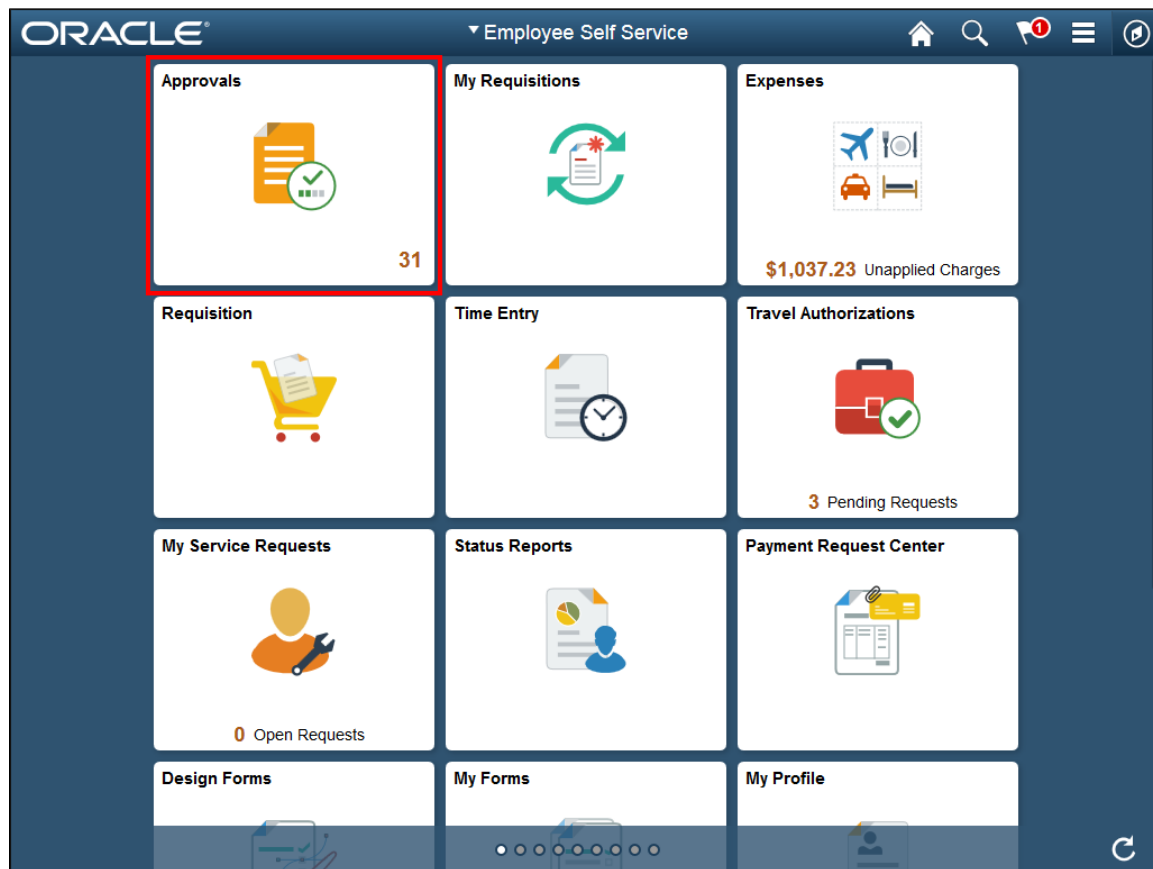

Approvers can perform the following actions using the approval pages:

- Review supplier user account and supplier information.
- View roles associated with a specific supplier user.
- View permission lists associated with a specific supplier user.
- Add comments for approval actions and view comments from previous reviewers.
- View the approval chain.

Note: The Fluid User Interface supports small and large form factors.

Supplier User Registration Approval Sequence

Supplier user registration approvals follow this sequence:

1. A requester creates a new supplier user account using the *Request a User ID* functionality of the User Registration page and saves the transaction.

See “User Registration Page” (PeopleSoft Source to Settle Common Information)

2. The transaction is flagged as pending approval.

The supplier user account is not created while the approval is pending.

3. The approver approves or denies the transaction.

The final approval triggers the creation of the supplier user account.

See [User Registration - Approval Header Detail Page](#).

Understanding Fluid Approval Set Up

This section discusses how to set up Fluid approvals for supplier user registration.

Set Up Approval Framework

PeopleSoft delivers the approval process IDs on the following Enterprise Components setup pages:

- Register Transactions page (Enterprise Components > Approvals > Approvals > Transaction Registry > Register Transactions).

You should not modify the values on this page (with the exception of the Notification Options values, which you can alter).

- Configure Transactions page (Enterprise Components > Approvals > Approvals > Transaction Configuration > Configure Transactions).

You can modify the values on this page to meet your approval requirements.

PeopleSoft delivers the *SUP_OB_USER* process ID for supplier user registration approval.

See:

“Register Transactions Page” (Approval Framework)

“Configure Transactions Page” (Approval Framework)

Set Up User Roles and Permissions

Define approval path steps by user role on the Setup Process Definitions page (Enterprise Components > Approvals > Approvals > Approval Process > Setup Process Definitions) for the *SUP_OB_USER* process ID.

Next use the User List Definition page (Enterprise Components > Approvals > Approvals > User List Setup) to define approval user lists to use with the approval process.

See:

“Setup Process Definitions Page” (Approval Framework)

“User List Definition Page” (Approval Framework)

Review Registered Components and Configure Page Composer

Use the Developer Registration page of Page Composer (Enterprise Components > Page Composer Administrator > Developer Registration > Registration) to review a list of registered components. Users cannot add new components for registration, but you can edit existing components per your business needs. Registered components and the changes made to them are then available in the Toolbox panel in Page Composer.

Next use the Page Composer page (Enterprise Components > Page Composer > Page Composer) to edit the design of the Fluid Approval pages based on the registered components. Users can design the existing placement of the fields in the fluid approval pages as well as add buttons and links in line with specific business requirements.

See:

“Registration Page” (Enterprise Components)

“Page Composer Page” (Enterprise Components)

Pending Approvals - User Registration Page

Use the Pending Approvals - User Registration page (EOAWMA_MAIN_FL) to review a list of all supplier user registrations that are pending your approval.

Navigation:

Approvals (tile) > Select User Registration in the approval list panel on the left side of the page.

This example illustrates the fields and controls on the Pending Approvals - User Registration page.

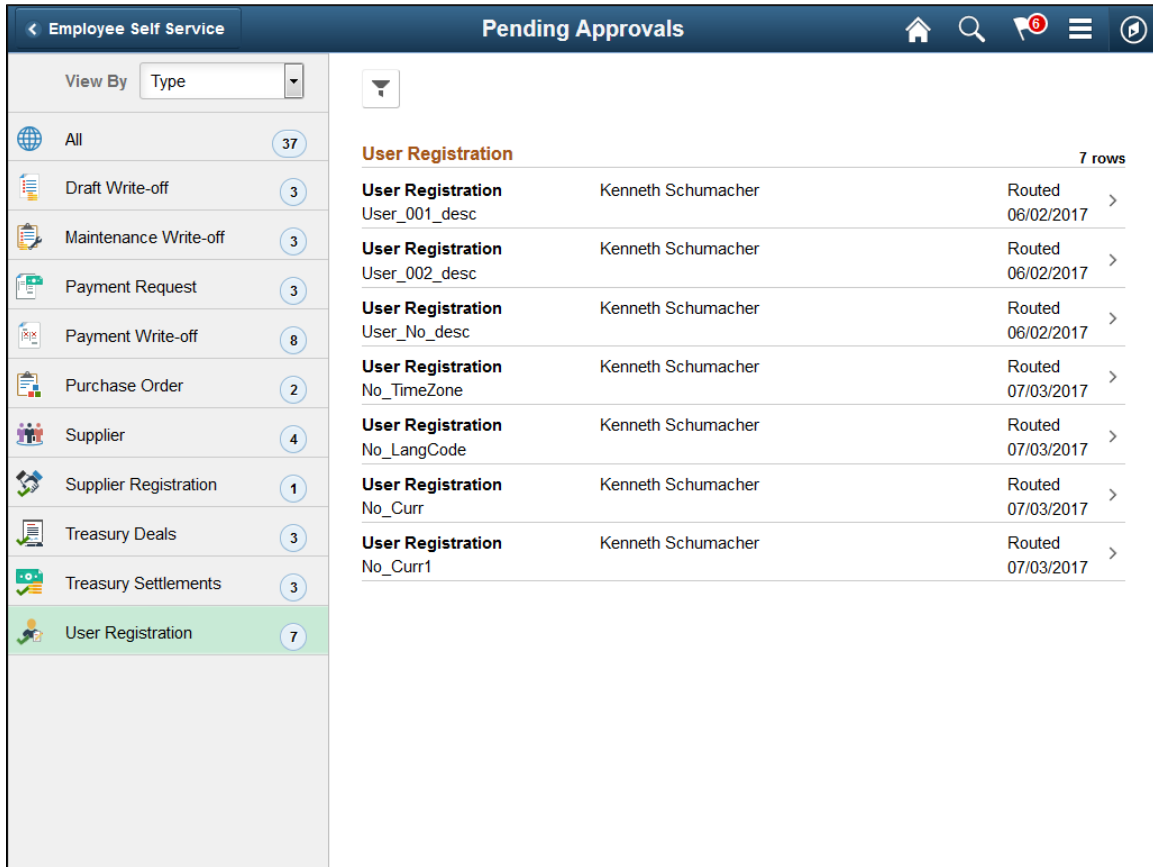

Select the Filter button to access the Filters page. Use the filter to refine the results displayed in the pending approvals list.

Select an individual User Registration row to access the User Registration - Approval Header Detail page and review supplier user account and supplier information. You can also approve or deny the supplier user registration from the page.

User Registration - Approval Header Detail Page

Use the User Registration - Approval Header Detail page (EOAWMA_TXNHDTL_FL) to review supplier user account and supplier information, and approve or deny the user registration.

Navigation:

Select an individual User Registration row from the Pending Approvals - User Registration page.

This example illustrates the fields and controls on the User Registration - Approval Header Detail page.

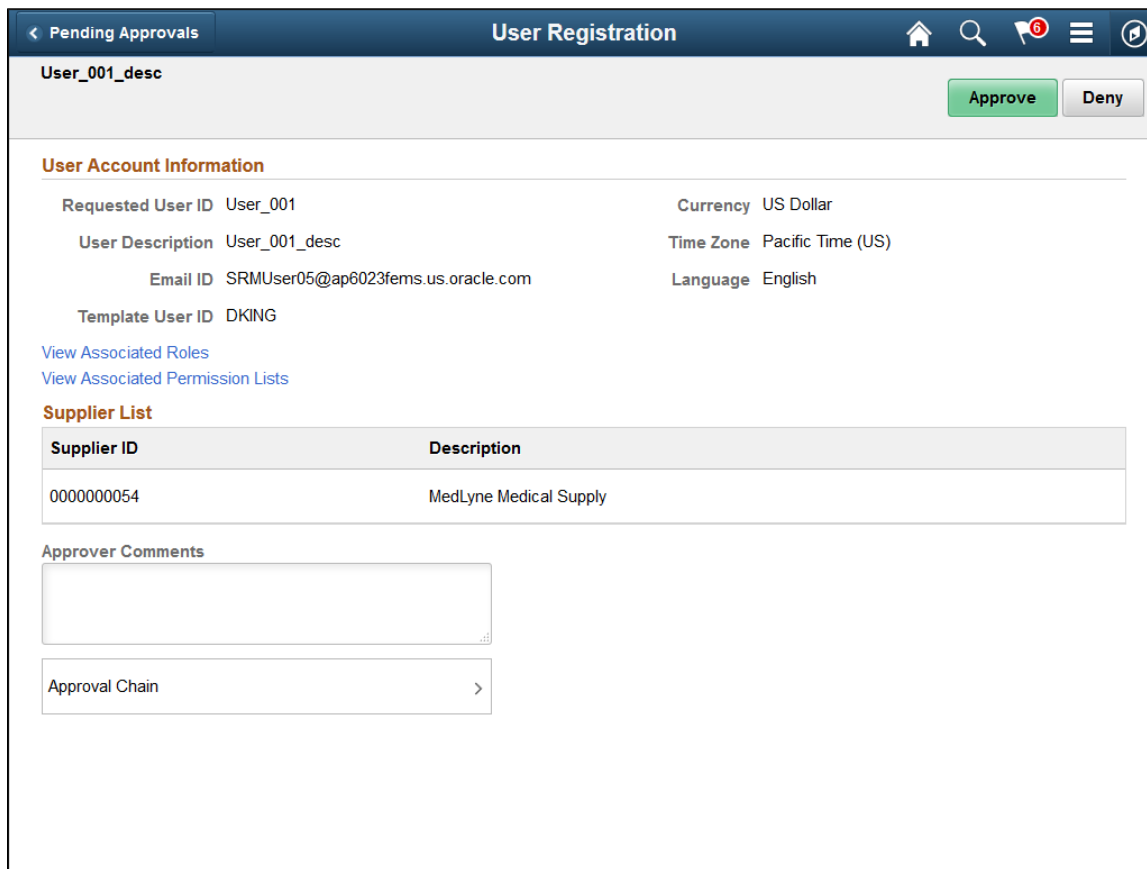

Review supplier user account and supplier information.

Click **View Associated Roles** to access the Associated Roles pagelet and view roles associated with the user.

Click **View Associated Permission Lists** to access the Associated Permission Lists pagelet and view permission lists associated with the user.

Click **Approval Chain** to access the Approval Chain pagelet and view the approval hierarchy.

Click **Approve** to approve the transaction. The system prompts you to provide comments and submit the approval. This action routes the approval to the next approver in the chain. The final approval triggers the creation of the supplier user account. In addition, the supplier receives a notification that confirms their new supplier user account information.

Click **Deny** to deny the transaction. The system prompts you to provide a denial reason (Reason Code) and comments, and submit the denial. When you deny a transaction, the supplier user account is not created, the status changes to Denied, and the transaction is removed from the approval queue.

Associated Roles Page

Use the Associated Roles page (SUP_USR_ROLES_FL) to view roles associated with a specific user.

Navigation:

Click the View Associated Roles link on the User Registration - Approval Header Detail page.

This example illustrates the fields and controls on the Associated Roles page.

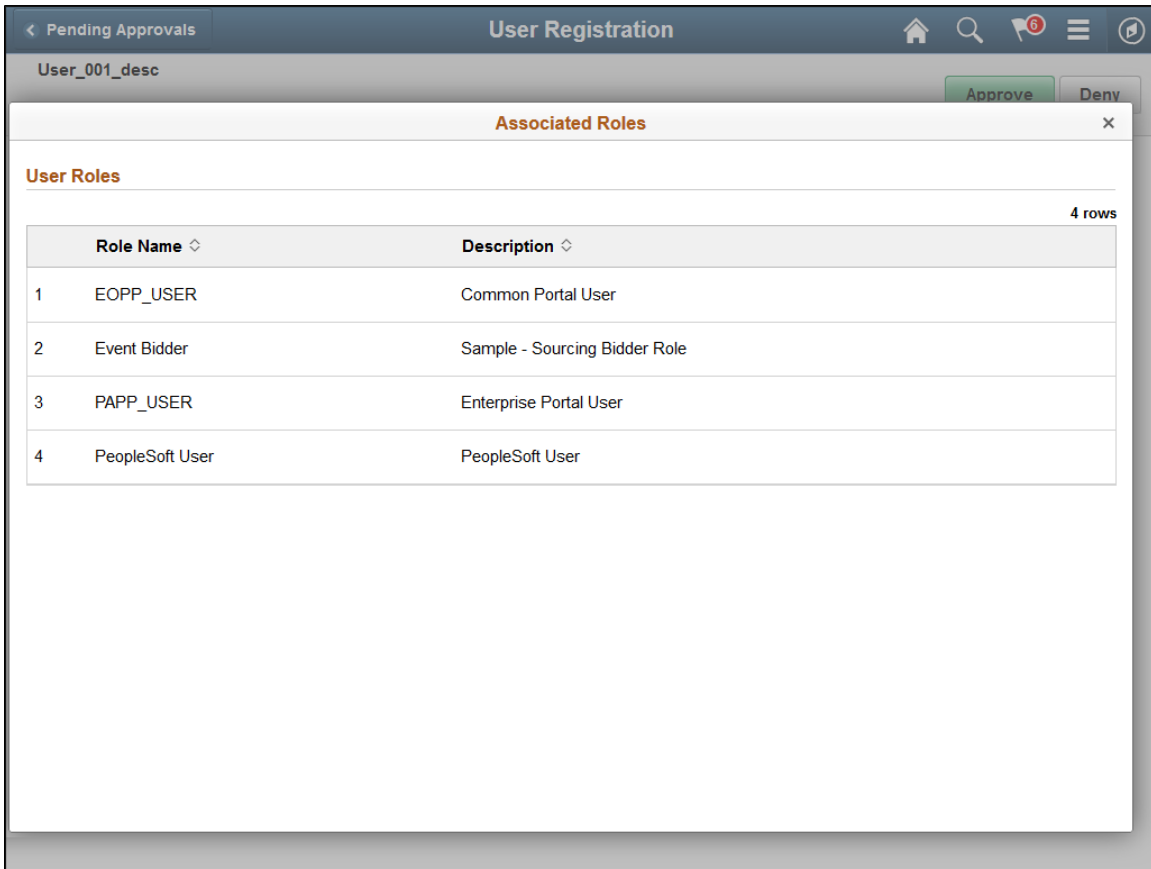

Associated Permission Lists Page

Use the Associated Permission Lists page (SUP_USR_PERMLST_FL) to view permission lists associated with a specific user.

Navigation:

Click the View Associated Permission Lists link on the User Registration - Approval Header Detail page.

This example illustrates the fields and controls on the Associated Permission Lists page.

The screenshot displays the 'Associated Permission Lists' page for a user registration. The page title is 'User Registration' and the user being reviewed is 'User_001_desc'. There are 'Approve' and 'Deny' buttons at the top right. The main content is a table titled 'User Permission Lists' with 7 rows. The table has two columns: 'Permission List' and 'Permission List Description'. The data is as follows:

	Permission List	Permission List Description
1	EOPP0000	Base Common Portal Objects
2	EPAUC2000	Event Responses - Bidder
3	EPAUC5500	Sourcing MCF User
4	EPAUC6000	Forum User
5	PAPP0000	Enterprise Portal User
6	PAPP0002	Personalize HomePage
7	PTPT1000	PeopleSoft User

Understanding Requisitions

Configuring Requisition Defaults

To minimize data entry, you can configure defaults for requisitions. Beyond basic requisition defaults, you can use the Header Defaults page to enter default data that applies to the requisition as a whole. You can use this page to override the defaults at the line, schedule, and distribution levels. You can also use the Line Defaults page to enter default data that applies to a particular requisition line. The requisition line default values that you enter on this page can be applied to all associated distribution lines.

If you enter values on the Header Defaults page or Line Defaults page, and the **Default** option is selected, the system treats the values entered as part of the default hierarchy. The system first searches the PeopleSoft Purchasing default hierarchy for existing values for each requisition field. If it does not find this information in the default hierarchy, the system uses the information that you entered on the Header Defaults page and Line Defaults page. If default values already exist in the control hierarchy, the system uses those values and ignores the values on the Header Defaults page and Line Defaults page.

If you select the **Override** option on the Header Defaults page, the override setting appears by default on the Line Defaults page as well, and the system overrides the default hierarchy information for this requisition. The system does not search the default hierarchy for the fields that you have entered on the Header Defaults page and Line Defaults page. All default values entered on these pages override the values found in the default hierarchy.

When you change the default requisition header information and exit the Header Defaults page, the system prompts you with the **Retrofit** field changes to all existing requisition lines, schedule, and distribution pages. This page enables you to retrofit the default changes to all existing lines of the requisition.

When you change the default requisition line information and exit the Line Defaults page, the system prompts you with the **Retrofit** field changes to all of the distributions on the Requisition Line page. This page enables you to retrofit the default changes to all of the existing distribution lines associated with the line.

Related Links

[Requisition Defaults Page](#)

[Defaults for Line Page](#)

[Retrofit field changes to all existing requisition lines/schedule/distributions Page](#)

[Requisition Default Hierarchy](#)

Canceling Requisitions and Requisition Lines

Using PeopleSoft Purchasing you can cancel a requisition or requisition lines.

Canceling Requisitions

You can cancel an entire requisition if:

- The requisition is not on hold.
- You are authorized to cancel requisitions on the User Preferences - Requisition Authorizations page.
- You are authorized to cancel requisitions for the requester on the User Preferences - Requisition Authorizations page.
- No requisition lines have been sourced to a purchase order or request for quote.
- No requisition schedules have been staged.
- The requisition has never been successfully budget checked. If it has been successfully budget checked before, the budget status must be valid before the user can cancel the document.

Canceling Requisition Lines

You can cancel a requisition line if:

- The requisition budget status in the header is *Valid*.

In this case, the budget has been checked and you can cancel a requisition line. When you cancel a requisition line, the system changes the budget status in the header to *Not Chk'd* (not checked).

- The requisition budget status in the header is *Not Chk'd* and the requisition has never been budget checked in its life cycle.

In this case, the budget has never been checked and you can cancel a requisition line.

- The requisition budget status in the header is *Error*.

In this case, the budget checking process found an error and you can cancel a requisition line.

You cannot cancel a requisition line if the requisition budget status in the header is *Not Chk'd* and the requisition has been previously budget checked during its life cycle.

Sourcing Requisitions Automatically

When you manually create a purchase order, you can set up the system to automatically select the most appropriate contract to which to source requisitions. During the process, the system searches for contracts to use on purchase orders, reducing the need for organizations to know the contract at the time of requisitioning. Requesters can ensure that the correct contract is selected, and override the contract if necessary. Budget checking can more accurately record pre-encumbrance and requisitions that may have otherwise been denied are approved by using the lower contract price.

Related Links

[Understanding How to Apply Procurement Contract Prices to Transactions](#)

“Fixed, Open-Item, and Category Contract Relationships” (PeopleSoft Source to Settle Common Information)

Deleting Requisitions

You can delete a requisition line, schedule, or distribution by clicking the **Delete Row** button on the respective requisition page.

You can delete an entire requisition by clicking the **Requisition Delete** button on the Requisition Header page. To delete an entire requisition, the requisition must meet the following criteria:

- The requisition is not on hold.
- The requisition has never been successfully budget checked.
- The **Allow Requisition Deletion** check box is selected on the Purchasing Business Unit Options page.
- You are authorized to delete entire requisitions on the User Preferences - Requisition Authorizations page.
- You are authorized to delete entire requisitions for the requester on the User Preferences - Requisition Authorizations page.
- There are no change orders for this requisition.
- The deletion will not cause change order processing.
- No requisition lines have been sourced to a purchase order or request for quote.
- No requisition schedules are staged.
- No lines have been processed by PeopleSoft Project Costing.

The system deletes records from these tables when you delete a requisition:

REQ_HDR

REQ_LINE

REQ_LINE_SHIP

REQ_LN_DISTRIB

REQ_LN_COMM

REQ_HDR_COMM

REQ_COMMENTS

REQ_APPROVAL

REQ_DFLT_TBL

REQ_DFLT_DISTRB

REQ_L_DFLT_DIST

REQ_ACTIVITY

Related Links

[Purchasing Definition - Business Unit Definition Page](#)

“User Preferences – Requisition Authorizations Page” (Application Fundamentals)

Placing a Requisition On Hold

To place a requisition on hold from further processing, select the Hold From Further Processing check box on a requisition using the Maintain Requisitions - Requisition page. Once you place a requisition on hold, PeopleSoft Purchasing prevents you from doing the following at all levels of the document:

- Approving a requisition.
- Canceling a requisition.
- Closing a requisition.

You will not be able to delete a requisition at the header level, but row level deletions are permitted.

In addition, if you have indicated hold from further processing on a requisition, you will not be able to source that requisition to a purchase order or a request for quote.

Note: All buttons on the requisition will be grayed out (not available) except for the Budget Check, Create Header Change, and Create Line Change buttons.

Budget Checking a Requisition On Hold

When you perform budget checking for a requisition, using the actual buttons on the Maintain Requisitions - Requisitions page or the Req Budget Check run control page, that process is also affected by the hold from further processing functionality.

Budget checking is now determined by the selection criteria that you define as part of the Source Transaction definition for the Commitment Control Budget Processor process and whether you have selected the Hold From Further Processing check box for the requisition. You define the Source Transaction definition selection criteria using the Source Transactions - Selection Criteria page.

Source Transaction	Source Transaction - Selection Criteria	Hold From Further Processing	Budget Checking
REQ_PREENC (requisition preencumbrance)	HOLD_STATUS = N	Selected	Budget checking will not occur.
REQ_PREENC	HOLD_STATUS not entered as selection criteria.	Selected	Budget checking will occur.
REQ_PREENC	HOLD_STATUS = Y	Selected	Budget checking will occur for only those requisitions on hold.

Source Transaction	Source Transaction - Selection Criteria	Hold From Further Processing	Budget Checking
REQ_PRECNP (requisition (non-prorated) preencumbrance)	HOLD_STATUS = N	Selected	Budget checking will not occur.
REQ_PRECNP	HOLD_STATUS not entered as selection criteria.	Selected	Budget checking will occur.
REQ_PRECNP	HOLD_STATUS = Y	Selected	Budget checking will occur for only those requisitions on hold.

Processing Not Affected When a Requisition is Placed On Hold

If a requisition has the Hold From Further Processing check box selected, you will still be able to:

- Create header and line changes.
- Run document tolerances.
- Run entry events.
- Execute the Request for Quote/Contract process—if this process has already started and the requisition is placed on hold, the process will continue.

Related Links

[Creating Requisition Header Information](#)

[Understanding Commitment Control in PeopleSoft Purchasing](#)

Using Procurement Cards on Requisitions

If you are using the procurement card functionality in PeopleSoft Purchasing, the system may automatically assign a procurement card to the requisition as the payment method. The system looks for procurement cards that are defined as a default for the requester. The requester needs to have the access rights to use a procurement card on a requisition before they can use the procurement card. Plus, after the system assigns a procurement card the requester can override the procurement card if they choose with another card.

A procurement card will default on to the requisition from the requester if the requestor has a procurement card specified and they have selected the Use Procurement Card as default payment method on requisitions check box on the Requester Setup page.

If the requester wants to add a procurement card to a requisition where one has not been specified they will select the Use Procurement Card check box on the requisition header and if they have a default card

specified for the requester defaults (without the Use Procurement Card check box as payment method on Requisitions selected) the system will automatically populate the requisition.

A requester can change or add any procurement card to a requisition if they have the role that has been assigned the *Usage - Use Procurement Card on Requisition* access rights for that card. Plus, a requester can deselect lines for payment by procurement card by clearing the Use ProCard check box in the line details for the requisition.

In addition, supplier cards cannot be associated with a requisition. At the time of requisition creation the supplier location is not known until the buyer saves the purchase order or the system creates the purchase order through the sourcing processes. In PeopleSoft Purchasing supplier cards are associated with a supplier location and can be used when defining purchase orders.

Related Links

[Understanding Procurement History Analysis](#)

[Understanding Procurement Groups in PeopleSoft](#)

[Understanding the Requisition Business Process](#)

[Procurement Card Processing on the Purchase Order](#)

Using PeopleSoft Maintenance Management Work Orders on Requisitions

In PeopleSoft Purchasing you can only associate a PeopleSoft Maintenance Management work order to a requisition for non-inventory and description only items. Once you make this association, the requisition schedule is pegged to a work order. You will use the Pegging Workbench to associate work orders to inventory items on a requisition.

In PeopleSoft Purchasing there are a few different methods of defining a requisition to support a PeopleSoft Maintenance Management work order. These methods are:

- PeopleSoft Maintenance Management creates their own requisition staging tables directly so that the PeopleSoft Purchasing Requisition Loader process can generate the requisition from their tables.

If the requisition was created through the Purchasing Requisition Loader processes and the requisition originated in PeopleSoft Maintenance Management, then the fields on Maintain Requisitions - Schedules page will contain the work order information passed from PeopleSoft Maintenance Management.

- You manually create the PeopleSoft Maintenance Management work order association directly when defining a requisition in PeopleSoft Purchasing.

You manually associate PeopleSoft Maintenance Management work order information to a requisition schedule by selecting existing work order information on Maintain Requisitions - Schedules page. You can also manually associate a maintenance work order to a requisition schedule even though the item ID on the requisition does not exist on the work order parts list. Making this association will add the item to the work order.

Plus, if you change the work order information that is already associated with a requisition schedule, the system will delete the existing requisition distributions and copy in the work order distributions from the work order itself. Plus, the pegging information will be updated to reflect the new work order information.

Related Links

[Understanding the Purchase Order Sourcing Business Process](#)

[“Understanding Pegging” \(PeopleSoft Supply Chain Management Common Information\)](#)

[Maintain Requisitions - Schedule Page](#)

[Maintain Purchase Order - Schedules Page](#)

[PeopleSoft Maintenance Management Work Order Processing on the Purchase Order](#)

[“PeopleSoft Maintenance Management Integration with PeopleSoft Purchasing and PeopleSoft Payables” \(PeopleSoft Maintenance Management\)](#)

Creating Requisitions Online

Understanding the Requisition Business Process

You can add a level of control early in the procurement life cycle by entering item requests using requisitions.

You enter requisitions into PeopleSoft Purchasing using either the PeopleSoft Purchasing online requisition pages or the Purchasing Requisition Loader process (PO_REQLOAD). This topic discusses requisition entry using the online requisition pages.

Requisitions consist of these basic elements: headers, lines, schedules, and distributions. Each requisition has one header, which can have multiple lines. Each line can have multiple schedules. Each schedule can have multiple distributions.

The schedule defines when and where you want the line items delivered. The distribution defines internal information for the schedule, such as how to charge accounts and departments for the purchase and how much of the total price each department should pay. When you process requisitions, you can track other requisition values such as pre-encumbrance balances when you have commitment control installed. These balances appear at the header level and the distribution-line level for requisitions and are carried over to purchase orders.

If you create a requisition using all available system-supplied values, you have to access only one page, the Maintain Requisitions - Requisition page. You don't need to access other pages, except to confirm or edit information that was supplied to the transaction from the default hierarchy.

Here is the basic flow of requisitions in PeopleSoft Purchasing:

1. Create the requisition in one of two ways:
 - Use the online requisition pages.
 - Use the Purchasing Requisition Loader process, which loads requisitions from external sources and PeopleSoft Inventory, PeopleSoft Order Management, PeopleSoft Project Costing, PeopleSoft Maintenance Management, and PeopleSoft Product Configurator (if these applications are installed with PeopleSoft Purchasing).

2. Approve the requisition.

The requisitions can require approval of amounts and ChartFields, or you can configure the users with authority to enter requisitions that require no additional approvals. You can also use PeopleSoft Approval Framework for requisition approvals.

See [Setting Up the Approval Framework for PeopleSoft Purchasing](#).

3. Run the Commitment Control Budget Processor Application Engine process (FS_BP) if you've enabled the Commitment Control feature.

This process determines whether funds exist to cover the cost of the requisition. You can also run this process as a background process.

4. Copy request for quote (RFQ) or strategic sourcing events.

Copy the requisition into an RFQ or strategic sourcing event for the bidding process.

5. Source the requisition to purchase orders or inventory demand.

After you approve the requisition, it is sourced into purchase orders through online sourcing pages or background processes. You can source the requisition to PeopleSoft Inventory through the Build Inventory Demand process (PO_REQINVS). You can also copy the requisition directly into a purchase order using the online pages.

Note: If you create requisitions manually, you can set up the system to automatically apply contracts to requisitions. For more information, see the next sections.

6. Run the Requisition Reconciliation process (PO_REQRCON) to close qualifying requisitions.

Pegging in PeopleSoft Purchasing

By using the pegging feature, you can tag requisitions or purchase orders to be used to meet specific demand such as sales orders, interunit transfers, or production IDs.

See [Using Pegging with Requisitions in PeopleSoft Purchasing](#).

Related Links

[Understanding the Purchase Order Sourcing Business Process](#)

[Understanding the Close Requisitions Process](#)

[Understanding the Purchasing Requisition Loader Application Engine Process \(PO_REQLOAD\)](#)

“Understanding Pegging” (PeopleSoft Supply Chain Management Common Information)

Understanding How to Apply Procurement Contract Prices to Transactions

The PeopleSoft Purchasing application is integrated with procurement contract functionality to streamline the use of contracts with requisitions, purchase orders, and vouchers. As part of the contract functionality, you can:

- Set up and use procurement contracts by item, category, or open item reference.

Using a category or categories tied to a contract, you can set up requisitions and purchase orders to reference the contract for any items under those categories.

See “Understanding Contract Categories” (PeopleSoft Source to Settle Common Information).

- Use procurement contract version control and change tracking so that you can view contract versions on requisitions, purchase orders, and vouchers.

See “Defining Contract and Vendor Rebate Control Parameters” (PeopleSoft Source to Settle Common Information).

- Specify whether the system automatically supplies a contract on a requisition.
- Specify whether the system automatically supplies a contract on a manual purchase order.
- Control whether the system automatically searches for contracts when sourcing requisitions.

When sourcing requisitions in batch or processing online purchase orders, the system evaluates system settings to determine whether to check for prices and use a contract on the purchase order.

- Define price adjustments at the header level of the contract that you can apply to transactions that use the contract.

This feature helps you streamline and simplify the entry of discounts and surcharges at the contract line-item and category levels. You can apply a predesignated set of adjustment criteria to each line or category on the contract.

See “Template Price Adjustments Page” (PeopleSoft Source to Settle Common Information).

Applying Contracts to Requisitions

You can set up requisitions to automatically search for a contract to use for requisitions. Applying contract prices to requisitions enables you to receive contract prices for requisition items and to more accurately track budgets and pre-encumbrance balances. When the system applies contract prices, it controls the entire flow of the transaction, from the Requisition Loader to creation and update of purchase orders. Requesters, buyers, and administrators with the appropriate security can set to search for and use contracts on transactions at various levels.

The system uses the values in the requisition to apply negotiated contracts prices for purchases and transactions against the contract. The system searches for purchase order, general, and release-to-single PO only contracts. release-to-single PO contracts can be referenced manually on the requisition.

You use the **Default Contract on Req** check box on the Business Unit Options page to initiate the search. To access the page, select **Set Up Financials/Supply Chain > Business Unit Related > Purchasing > Purchasing Definition > Business Unit Options**.

To apply contracts to a requisition, the system locates possible contracts and copies them to requisition transaction lines when you create or change any of these fields on the requisition:

- **Supplier**
- **Quantity**
- **UOM** (unit of measure).
- **Shipto**
- **Item**
- **Item Description**
- **Category**

To automatically supply a contract to a requisition, the system searches for and ensures that the correct contract is selected for use with the requisition and verifies that the **Auto Default** check box is selected on the Contract page. This makes the contract available to be automatically supplied to requisition and purchase order transactions.

You can override contracts at the line level that have been selected by the system. The initial value of the **Use Contract if Available** check box is *Y* regardless of the value of the **Default Contract On Req** check box for the business unit. If the item requires a contract, the system forces the **Use Contract if Available** check box to *Y* regardless of whether the contract exists on the line. Sourcing looks for the best contract if the contract is not referenced on the requisition line where this check box is selected. Deselecting this check box removes the contract information for the line (if any). However, the price will not be supplied again by default from the hierarchy to prevent overriding the user-entered price. Sourcing logic bypasses searching for the best contract for this line.

Contract Pricing for Requisitions and Purchase Orders

You can use pricing from contracts for requisitions and purchase orders. Using the **Default Contract on Req** and **Default Contract on PO** check boxes on the Business Unit Options page, you can make contracts available for use with requisitions and purchase orders.

Separate price calculation routines are used for online (PeopleCode) and batch processing (application engine). When pricing a purchase order line that has a contract category reference, you need to establish the base price (item supplier, manual, and so on), and then apply the category price adjustments, the supplier price adjustments, or both depending on the pricing options specified on the contract.

Copy Requisitions to Purchase Orders

When copying a requisition onto a new purchase order, the system evaluates settings on requisition lines that include the **Use Contract If Applicable** field.

The following table outlines how the system handles the combinations of these settings:

<i>Use Contract if Applicable Field Setting</i>	<i>Calculate Price Setting</i>	<i>Is a Contract Value on the Requisition Line?</i>	<i>Does the PO Supplier Match the Requisition Supplier?</i>	<i>During Online Sourcing, the System:</i>	<i>When the System Creates a Purchase Order, It Uses the Contract ID.</i> ..
Y	Y	Y	Y	Recalculates the contract price and assigns the contract ID from the requisition.	Assigned from the requisition.
Y	N	Y	Y	Uses the price from the requisition and assigns the contract ID from the requisition.	Assigned from the requisition.

Use Contract if Applicable Field Setting	Calculate Price Setting	Is a Contract Value on the Requisition Line?	Does the PO Supplier Match the Requisition Supplier?	During Online Sourcing, the System:	When the System Creates a Purchase Order, It Uses the Contract ID. ..
Y	Y	N	Y	Finds the most current contract for the supplier on the requisition and uses the item or supplier contract pricing.	Assigned during sourcing.
Y	N	N	Y	Finds the most current contract for the supplier on the requisition and uses the requisition price.	Assigned during sourcing.
N	N	N	Y	Uses the requisition price and does not assign the contract ID.	blank
N	N	N	N	Uses the requisition price and does not assign the contract ID.	blank
N	Y	N	Y	Uses the item or supplier price and does not assign the contract ID.	blank
N	Y	N	N	Uses the item or supplier price and does not assign the contract ID.	blank
N	N	Y	Y	Uses the requisition price and does not assign the contract ID.	blank

Use Contract if Applicable Field Setting	Calculate Price Setting	Is a Contract Value on the Requisition Line?	Does the PO Supplier Match the Requisition Supplier?	During Online Sourcing, the System:	When the System Creates a Purchase Order, It Uses the Contract ID. ..
N	N	Y	N	Uses the requisition price and does not assign the contract ID.	blank
N	N	Y	Y	Not Applicable - If the use contract setting is set to N, the system prevents the entry of a contract ID on the requisition.	NA
N	N	Y	N	Not Applicable - If the Use Contract on Req check box is not selected. The system prevents the entry of a contract ID on the requisition.	NA
Y	Y	Y	N	Not Applicable - An error prevents you from copying the requisition to a purchase order when the supplier does not match the contract supplier.	NA
Y	N	Y	N	Not Applicable - An error prevents you from copying the requisition to a purchase order when the supplier does not match the contract supplier.	NA

<i>Use Contract if Applicable Field Setting</i>	<i>Calculate Price Setting</i>	<i>Is a Contract Value on the Requisition Line?</i>	<i>Does the PO Supplier Match the Requisition Supplier?</i>	<i>During Online Sourcing, the System:</i>	<i>When the System Creates a Purchase Order, It Uses the Contract ID.</i> ..
Y	Y	N	N	Not applicable - The supplier on the contract assigned to the requisition must match the transaction's supplier. The system finds the most current contract for the supplier on the requisition, then uses the item and supplier contract pricing.	Assigned during sourcing.
Y	N	N	N	Not applicable - The supplier must match the requisition supplier. The system finds the most current contract for the supplier on the requisition, and then uses the requisition price.	Assigned during sourcing.

Contract Pricing for Manually Entered Purchase Orders

You can select to indicate that the system should automatically search for appropriate contracts for purchase order lines. The **Default Contract on PO** check box on the PeopleSoft Purchasing Business Unit Options page applies only to manually created purchase orders, and not include orders created using a batch process. This automates the process of selecting the most appropriate contract for use with manually created purchase orders.

Note: The default contract on purchase order option does not apply to blanket purchase orders or to sourced PeopleSoft Strategic Sourcing purchase orders.

If you select to search for contracts, the system begins its search for contracts with process types of Purchase Order or General, and that are in a current version with an Approved status. If multiple contracts

exist, the system selects the one with the most recent (but not future) contract begin date. After validating the contract and using it on the transaction, the system:

- Updates released amounts and quantities.
- Creates a contract event.
- Updates the transaction with contract information.

The default contract on purchase order option does not apply to PeopleSoft Services Procurement project roles on the contract. The Services Procurement system searches for an applicable contract on the work order, and uses it on a purchase order regardless of the **Default Contract on PO** check box value.

When the system determines the best contract, the contract is already validated. When you save the purchase order, the system validates the contract again in case you update released amounts and quantities and create the contract event. Other considerations for when the **Default Contract on PO** check box is selected include:

- The system finds the most current active contract for the supplier and item. After that contract is determined, the system determines the most granular level to use as the contract reference, such as the line, then category, and then open item. If the contract uses line groups and multiple line references exist for the item, the system returns the line with the lowest price, or the lowest line number when there is a duplicate situation.
- When the system finds a better contract for the purchase order than the existing contract, it provides a message with the option to let you keep the existing contract or load the new contract. This can happen when you update a purchase order line field and the change results in a different contract ID, line number or category line number.
- When you are editing an existing purchase order line that has a contract ID, and the best contract cannot be found due to the version, you can replace the version number. If you do not have the authority to replace the number, the system keeps the existing version.

If the system finds the best contract based on a different contract ID, you can select to either use the new contract or keep the existing contract. If you select the new contract, the system replaces the contract ID and line, category line, and version number.

- When you are copying an existing purchase order to a new purchase order and if changing a field results in a different contract ID, line number, or category line number, the system displays a message and provides you the option to replace the existing contract. If the new contract found is the same as the existing one on the purchase order, but version numbers are different, the system does not provide an option to replace the contract, but will use the most current version.

Source Requisitions and Create Purchase Orders Using Batch Processing

During sourcing requisitions in batch mode, the sourcing function evaluates the requisition line settings to determine how to price the order and assign the contract. The following table provides the valid combinations and corresponding results:

Use Contract if Applicable	Calculate Price Flag	Contract Value on Requisition Line	Consolidate with Other Requisitions	Override Suggested Supplier	During Batch Sourcing, the System Determines the Price by...	When PO is Created, Contract ID Is:
Y	Y	Y	N	N	Recalculating the contract price using the contract from the requisition.	Assigned from requisition.
Y	N	Y	N	N	Passing the price from the requisition and the contract ID assigned from the requisition.	Assigned from requisition.
Y	Y	N	Y/N	Y/N	Finding the most current contract for the supplier on the requisition, then using item and supplier contract pricing.	Assigned during sourcing.
Y	Y	N	N	N	Finding the most current contract for the supplier on the requisition, then by using item and supplier contract pricing.	Assigned during sourcing.
Y	N	N	N	N	Finding the most current contract for the supplier on requisition, and then using the requisition price.	Assigned during sourcing.

<i>Use Contract if Applicable</i>	<i>Calculate Price Flag</i>	<i>Contract Value on Requisition Line</i>	<i>Consolidate with Other Requisitions</i>	<i>Override Suggested Supplier</i>	<i>During Batch Sourcing, the System Determines the Price by...</i>	<i>When PO is Created, Contract ID Is:</i>
N	N	N	N	N	Using the requisition price and not assigning the contract ID.	Blank
N	Y	N	N	N	Using the item and supplier price and not assigning the contract ID.	Blank
N	Y	N	Y	Y	Using the item and supplier price and not assigning the contract ID.	Blank

Creating Requisition Header Information

This section discusses how to create requisition header information:

Pages Used to Create Requisition Header Information

<i>Page Name</i>	<i>Definition Name</i>	<i>Usage</i>
<u>Purchasing Definition - Business Unit Options Page\</u>	BUS_UNIT_TBL_PM2	<p>Create business unit options or update existing ones and activate value-added tax (VAT) defaults and calculations for the requisitions.</p> <p>When you use this VAT option in conjunction with the VAT option on the Purchasing Definition - Business Unit Options page, the system uses the supplier business unit, item, and ship to information to derive VAT determinants.</p>

Page Name	Definition Name	Usage
Procurement - Requisition Authorization Page	OPR_REQ_AUTH	Authorize users to create and update requisitions for applicable buyers. Define a user's requisition processing authority in relation to applicable buyers. When you use this VAT option in conjunction with the VAT option on the Requisition Authorization page, the system uses the supplier business unit, item, and ship to information to derive VAT determinants.
Requisitions Page	(Search)	Search for existing requisitions or add a new requisition. You can search for requisitions based on the requisition ID, name, or status and by requester and requester name.
<u>Maintain Requisitions - Requisition Page</u>	REQ_FORM	Create requisition header information.
Commitment Control Page	KK_EXCPTN_OVER_SEC	This link is available only when the commitment control option is enabled.
Requester Information Page	REQ_USER_AUDIT	View requester information.
<u>Requisition Defaults Page</u>	REQ_HDR_DEFAULTS	Enter defaults that apply to the entire requisition. You can override defaults at the line, schedule, and distribution levels.
<u>Supplier Search Page</u>	VENDOR_LOOKUP_SEC	Search for suppliers.
Supplier Detail Page	VENDOR_LOOKUP_DTL	View supplier details.
Address Page	VENDOR_ADDR_SEC	View address details for the location relevant to the page from which this page is accessed.

Page Name	Definition Name	Usage
<u>Req One Time Address Default (requisition one time address default) Page</u>	REQ_DFLT_ADDR	Set up a one-time ship to address for the selected transaction. The address entered serves as the default one-time address for all new lines and schedules on the transaction document. You can have the system supply the address to the existing lines by default as well. You cannot define a one-time address for direct shipment requisitions. To change the address for a direct shipment, you must go to the sales order in PeopleSoft Order Management and make the address change there.
<u>Retrofit field changes to all existing requisition lines/schedule/distributions Page</u>	REQ_DFLT_RETROFIT	Apply changes to default values in requisition header, line, schedule, and distribution fields.
<u>Header Comments Page</u>	REQ_COMMENTS	Enter comments for a transaction. You can enter a unique comment or select from predefined standard comments.
<u>Standard Comments Page</u>	STD_COMM_SEC	Add standard comments to the comments text box. You can modify the standard comments to meet the requirements of the transaction.
<u>Currency Information Page</u>	EXCH_RT_DTL_INQ	Display the rules used to calculate exchange rates for the transaction.
Activities Page	REQ_ACTIVITY_SEC	Enter and track activities associated with a particular transaction. Keep the activity comments organized by logging the due date and by selecting the Done check box.
Req DOC Status Page(requisition document status)	PRCR_DOCSTAT_INQ	Access and review information about procurement documents associated with a requisition.
Add a Document Page	CS_DOC_ADD	Add a PeopleSoft Supplier Contract Management requisition document.
Document Management Page	CS_DOC_MAINT	Modify a PeopleSoft Supplier Contract Management requisition document.
Enter Kit Items Page	REQ_KIT_ITEMS	Order an item by kit ID. The individual items in the kit will become new lines on the requisition.

Page Name	Definition Name	Usage
Item Search Criteria Page	ITEM_SEARCH_SP	Search for items.
Item Supplier Priority Page	ITM_VND_PRTY_HC	View qualifying suppliers that are preapproved to provide selected items.
<u>Order By Catalog Page</u>	ORD_BY_ITEM_CAT	Search for and select items to order from a catalog.
Item Details Page	ITM_CAT_DETAIL	View details about the item.
Item Supplier Priority Page	ITM_CAT_VND	View the name, status, priority, and price for the supplier.
Set Item Alias Page	None.	Set up an alias for the selected item so that you don't have to remember the supplier's ID or description each time that you order the part. Aliases are stored according to user ID so that each user can have a different alias for the same item.
<u>Requester Favorite Items Page</u>	REQUESTOR_ITEMS	View, select for reorder, or modify all items requested by the requester.
Req Change Ord Header History Page (requisition change tracking header history)	REQ_CHANGE_HDR	View the header history of requisition tracked changes.

Maintain Requisitions - Requisition Page

Use the Maintain Requisitions - Requisition page (REQ_FORM) to create requisition header information.

Navigation:

Purchasing > Requisitions > Add/Update Requisitions > Maintain Requisitions - Requisition

This example illustrates the fields and controls on the Maintain Requisitions —Requisition Page. You can find definitions for the fields and controls later on this page.

This example illustrates the fields and controls on the Maintain Requisition - Requisition page(2of2). You can find definitions for the fields and controls later on this page.

Line	Item	Description	Quantity	*UOM	Category	Price	Merchandise Amount	Status
1	10089	Premier Casting Rod	2.5000	BOX	FISHING	600.00000	1,500.00	Approved
2	10010	Mountain Bike	10.0000	EA	CYCLING	9.00000	90.00	Approved

Click on the Item Tab on the requisition to view the original sub item, description and item substitution search icon.

This example illustrates the fields and controls on the Maintain Requisition — Item Information page. You can find definitions for the fields and controls later on this page.

Line	Item	Description	RFG Required	Stockless Item	Device Tracking	Supplier Item ID	Supplier's Catalog	Manufacturer ID	Manufacturer's Item ID	UPN Type	UPN ID
1	10075	Nextstar Outback	<input type="checkbox"/>	<input type="checkbox"/>	<input type="checkbox"/>			APPLE	APPLE-10075	<input type="checkbox"/>	<input type="checkbox"/>
2	10075	Nextstar Outback	<input type="checkbox"/>	<input type="checkbox"/>	<input type="checkbox"/>			APPLE	APPLE-10075	<input type="checkbox"/>	<input type="checkbox"/>

The Item Info Tab – shows the new item substitute fields:



Clicking on the Item Search Icon will bring up the Substitute Item page (SUB_ITM_SRCH) that will allow the user to view all items available to substitute.

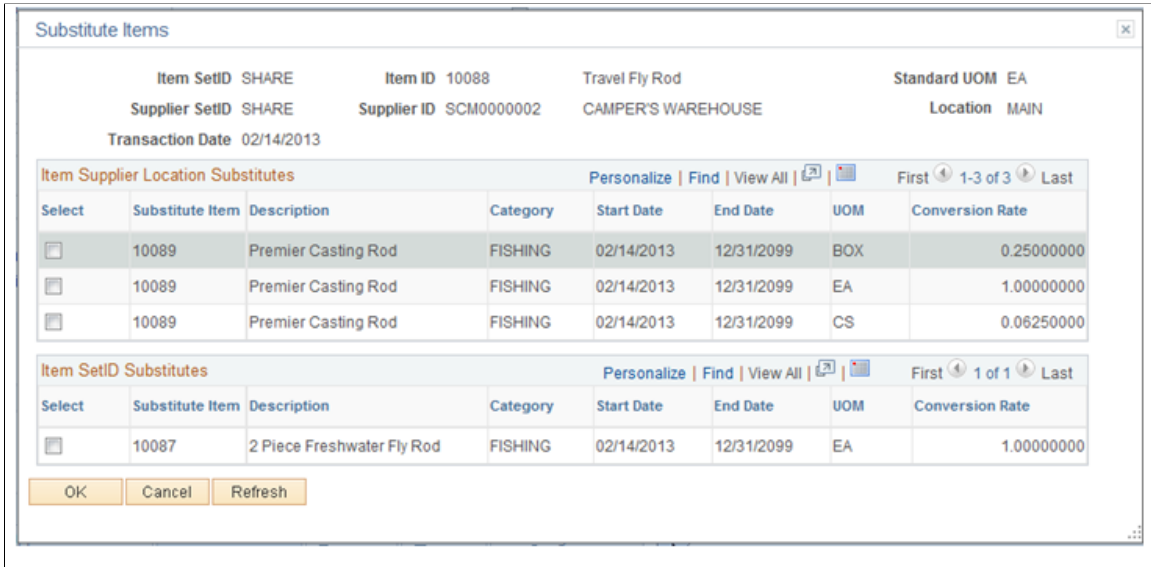

This example illustrates the fields and controls on the Substitute Item page. You can find definitions for the fields and controls later on this page.



For Information on Substitute Item Search Page See [Working With Substitute Items in Procurement](#)

Field or Control	Description
Status	<p>Displays the requisition status:</p> <p><i>Open:</i> Appears by default from the requester. The requisition is not eligible for the approval process until an authorized user changes this status to <i>Pending Approval</i>.</p> <p><i>Pending:</i> Depending on the Initial Status setting defined for the requester in the Requester Setup component, the default status might be set to Pending.</p> <p><i>Pending Approval:</i> The requisition has been submitted for approval.</p> <p><i>Approved:</i> The requisition is approved.</p> <p><i>Line Approved:</i> One or more requisition lines are approved.</p> <hr/> <p>Note: An individual requisition line that originates in PeopleSoft eProcurement can be approved and eligible for sourcing even if the entire requisition is not fully approved. The same is true for Purchasing requisitions when the approval framework is enabled for requisitions.</p> <hr/> <p>Note: Requisitions in <i>Canceled</i> and <i>Completed</i> statuses are not available on this page and can be viewed only using requisition inquiry pages.</p> <hr/>
	Click to approve the requisition and its lines when the approval framework is enabled.

Field or Control	Description
	<p>Click to cancel the requisition. Cancellation is irreversible, and you must create a new requisition. You cannot change a canceled requisition. You can only cancel a requisition if you are granted authorization on the Define User Preferences - Procurement: Requisition Authorizations page. Also, if you cancel the requisition, it terminates the approval framework process.</p>
	<p>Click to make fields that are eligible for change request updates available for updates on this page. When a requisition is eligible for change tracking, the system makes the Create Header Change button available for use. The system makes all eligible change tracking fields available for entry. Inserting a new line or schedule or canceling an existing line or schedule can create a change request. You cannot delete a line or schedule if that line or schedule is eligible for change tracking. If you cancel a line, you also cancel its schedules and distributions.</p> <p>When you update the requisition and change tracking is required, the Change Reason page appears for you to define the change reason and enter comments. The system also makes the Current Change Reason link available if the change is the first change. You use this link to view the last change reason used. To review all tracked changes for a requisition, select the <i>Change History</i> option in the Go To field.</p> <p>When you click the Create Header Change button, the system checks to determine whether this is the first change request for this requisition. If so, the system inserts changed fields with the batch number and sequence number of 0 to store the original, history values for the requisition.</p>
<p>Copy From</p>	<p>Click to access the Copy Requisitions page. Using this page you can use information from an existing requisition to define information for the current information.</p>
<p>Budget Status</p>	<p>Displays the requisition budget checking status if budget checking is enabled.</p> <p><i>Not Chk'd</i> (not checked): This is the requisition's initial budget checking status. The status may also return to this value after a value change that affected the budget status.</p> <p><i>Valid</i>: The requisition has been successfully budget checked.</p> <p><i>Error</i>: The requisition has failed budget checking. The text is enabled as a link, which you can click to access the Requisition Exceptions page, where you can view budget check exceptions for this requisition. Users with appropriate authority can override the budget exceptions on the Requisition Exceptions page. When you open a requisition that has failed a budget check, the system displays a message.</p> <p><i>Prov Valid</i> (provisionally valid): The requisition has had a budget pre-check performed against it and it was valid.</p>

Field or Control	Description
	<p>Click to invoke budget checking to verify that funds exist in the appropriate accounts to cover the price on the requisition. This option appears if budget checking is enabled for the database.</p>
	<p>Click to perform a pre-budget check. This button enables you to pre-budget check whether a budget exists for a requisition before the amount is committed to the pre-encumbrance or encumbrance and makes it possible to validate documents in work-in-progress mode without affecting budget balances. When performing pre-budget check processing, the Budget Processor performs all of its budget checking and edits, but does so without committing changes to the ledger or other records. The statuses of <i>Provisionally Valid</i> or <i>Error</i> on the transaction pages indicate whether a budget is available. If you click the button and if the pre-budget check is provisionally valid, then the system sets the budget header status for the requisition to <i>Prov Valid</i>. If the pre-budget check is not valid, then the system sets the budget header status to Error with a link to the Exception page.</p> <p>The button is visible only if the Purchasing check box is selected in the Enable Commitment Control section on the Installation Options - Products page and the Purchasing check box is selected in the Enable Budget Pre-check section on Installation Options - Commitment Control page. The button is not visible if the budget status is <i>Valid</i>.</p> <p>See “Checking Budget Journals and Transactions Without Posting” (PeopleSoft Commitment Control).</p>
Requisition ID	<p>If you are adding a requisition, enter an identifier for the requisition. If you are using automatic numbering, the field displays <i>NEXT</i>.</p>
Track Batch	<p>Displays the last batch number used to generate a tracked changes for the requisition. Change order numbers identify the batches of changes that you make to a requisition.</p>
Requisition Name	<p>If you are adding a requisition, enter a description of the request to help you identify this requisition as it flows through the system. If you are using PeopleSoft eProcurement, this value is carried from the eProcurement requisition to the Purchasing requisition when the requisition is created in eProcurement.</p>

Field or Control	Description
Hold From Further Processing	<p>Select to temporarily prevent further processing of the requisition. The requisition will not be eligible for approval, unapproval, cancellation, closure, or sourcing to a purchase order.</p> <p>In addition, budget checking is determined by the selection criteria that you define as part of the Source Transaction definition for the Commitment Control Budget Processor process and whether you have selected the Hold From Further Processing check box for the requisition.</p> <p>If the HOLD_STATUS = N for the selection criteria for the source transaction, the Hold From Further Processing check box is selected, and you perform budget checking, no budget checking will occur for the requisition.</p> <p>If the HOLD_STATUS is not entered as Selection Criteria for the Source Transaction, and the Hold From Further Processing check box is selected, and you perform budget checking the budget checking process will execute for the requisition.</p> <p>If the HOLD_STATUS = Y for the selection criteria for the source transaction, the Hold From Further Processing check box is selected, and you perform budget checking, the budget checking process will run but will process only the requisitions that are marked on hold.</p> <p>See Placing a Requisition On Hold.</p>

Header

Field or Control	Description
Procurement Group Add Update	Click to access the Procurement Groups page where you can create or update a procurement group ID.
Requester	Select the ID of a user who will be the requisition's requesting party.
Requisition Date	Select the creation date of the requisition.
Requester Info (requester information)	Click to view the phone and facsimile number of the requester who appears in the Requester ID field.
Origin	Select the origin of the requisition. Origin codes are defined on the Origin Codes page.

Field or Control	Description
Currency Code	<p>Displays the requisition transaction currency. This value is supplied from the Requester Setup page (REQUESTOR_TBL) by default if the business unit allows multicurrency requisitions. If a currency is not set up in the requester table, it appears by default from the business unit. If the business unit does not allow multicurrency requisitions, the currency field value is supplied from the business unit and cannot be overridden on this page.</p>
Accounting Date	<p>Determines the open period or allowable open date range for budget checking a requisition when you are using commitment control. If the requisition's accounting date falls before or after the open period date range, the system provides a message or warning to prevent you from running budget checking.</p> <p>This field is available only if commitment control is enabled.</p>
Current Change Reason	<p>Click to view the last change reason used to track change requests for this requisition.</p>
Add Request Document	<p>Click to access the Add a Document page. The page appears with information about the requisition. You then select the document type that you want to use to create the document and respond to wizard questions concerning the new requisition document. A requisition document is one that contains responses to wizard questions. Contract specialists can use these responses to determine proper terms and conditions for a contract document when the requisition becomes a contract.</p> <p>This link is available when PeopleSoft Supplier Contract Management has been installed and the application installation options have been set to use document types and to use documents with purchase order requisitions. You must also set up document types to use only with purchase order requisitions.</p> <p>After you create the document, use the Modify Request Document link to update and edit the document.</p> <p>See “Add a Document Page - Requisition” (PeopleSoft Supplier Contract Management)</p>

Field or Control	Description
Procurement Group	<p>This link appears in the header area of the Requisition page if you enabled the Purchasing Group Option field on the Purchasing Options Page. Click to access the Procurement Groups page to add or update a procurement group ID. The Procurement Groups page is launched in a new instance of the browser so you can perform the necessary maintenance to the procurement group IDs. When changes are complete, you can close the browser instance and continue with the requisition transaction. You can select the Procurement Group ID for an item within the Attributes tab of the Requisition page. See Procurement Groups Page Understanding Procurement Groups in PeopleSoft</p>
Custom Field	<p>The user definable fields in this Custom Fields link are available when you check the Enable Custom Fields check box on the Purchasing Installation Options page. You can customize these fields for your use. The custom fields are informational only.</p> <p>For more information, See Understanding User-Definable Fields</p>
Modify Request Document	<p>Click to access the Document Management page. Using this page, you can open and review responses to the wizard questions provided by the requestor. The responses can assist contract specialists in defining contract conditions.</p> <p>See .“Creating Contract Documents for Purchase Orders” (PeopleSoft Supplier Contract Management)</p>
Card Number and Card Type	<p>The requester procurement card and type appears by default from the Requester Setup page. You can override the procurement card that appears. Only the valid procurement cards for this requester are available for selection.</p> <hr/> <p>Note: All the procurement card fields on this page are controlled by the users assigned roles and the access rights assigned to those roles that you define using the Security menu for procurement cards.</p> <hr/>
Expiration Date	<p>Displays the expiration date of the procurement card.</p>

<i>Field or Control</i>	<i>Description</i>
Use Procurement Card	The setting of this check box appears by default from the Requester Setup page. You can override the setting. If you select this check box, the procurement card will be used as the payment method for the requisition.
Procurement Group Add/Update	Click to access the Procurement Groups page where you can create or update a procurement group ID.

Amount Summary

If you're using VAT, the **Merchandise Amount**, **Tax**, and **Total Amount** fields appear in the **Amount Summary** group box.

<i>Field or Control</i>	<i>Description</i>
Total Amount	Displays the total amount for all lines in the transaction currency.
Recalculate Gross Amount	Use this option to recalculate the tax and total amount upon request. <hr/> Note: This option is available only if VAT is enabled. <hr/>

Field or Control	Description
<p>Pre-Encumbrance Balance</p>	<p>Displays the pre-encumbrance balance for the requisition.</p> <p>When you use commitment control, the system deducts each type of financial obligation from the budget and tracks it according to obligation type. This enables you to determine the monies that you have committed in pre-encumbrances.</p> <p>The system extracts these values from commitment control tables by passing the business unit, document ID, and other key information depending on the display.</p> <p>The system displays the Pre-Encumbrance Balance field only when commitment control is on and the document has been budget checked at least once. In addition, a default detail ledger must be identified so that the accounting entries can be summarized to display the respective pre-encumbrance balance for the requisition. After the budget checked, the pre-encumbrance balance will appear and the system enables the inquiry link. If the pre-encumbrance balance is less than zero, the link is not available. Pre-encumbrance balances are updated each time that you budget check the requisition.</p> <p>When you generate a requisition, a pre-encumbrance is created in budget records by the budget-checking process. When a requisition is sourced to a purchase order, Commitment Control liquidates the pre-encumbrance from the requisition and establishes an encumbrance for the purchase order. These balances are updated when you budget check the purchase order.</p> <hr/> <p>Note: Commitment Control customers will not be able to liquidate the pre-encumbrance until the requisition is successfully closed if they choose to copy a contract into the online purchase order.</p> <hr/> <p>Pre-encumbrance balances appear on the currency code for the balances in the transaction currency of the requisition and are based on the transaction date rate. You can have a pre-encumbrance currency value in a different currency than the supplier's currency. Balances can be partially or fully sourced to purchase orders and can be for multiple requisition lines, schedules, and distributions.</p> <p>You can view accounting details for the requisition, such as the purchase orders and vouchers that have been created from the requisition. Click the Pre-Encumbrance Balance link to access the Requisition Accounting Entries page. You use this page to view accounting information including the commitment control ledger group and transactions that have been performed against the requisition. The link is available when the budget status is valid and the pre-encumbrance</p>

<i>Field or Control</i>	<i>Description</i>
	balance is greater than zero. The link is not available when the budget has not been checked and the balance is zero. See “Viewing Budget Details and Transaction Activity” (PeopleSoft Commitment Control).

Add Items From

<i>Field or Control</i>	<i>Description</i>
Purchasing Kit	Click to access the Enter Kit Items page, where you can select a kit and a quantity to add to the requisition.
Catalog	Click to access the Order By Catalog page, where you can select a catalog item to add to the requisition.
Item Search	Click to access the Item Search Criteria page, where you can define search criteria for items to add to the requisition.
Requester Items	Click to access the Requester Favorite Items page, where you can select items to add to the requisition.

Select Lines to Display

<i>Field or Control</i>	<i>Description</i>
Line	Select a beginning line for a range of lines that you want to display in the Lines grid.
To	Select the ending line that you want to display.
Retrieve	Click to display the requisition lines that you selected. If a line has changed, the system saves the changes before populating the Lines grid with the line.

For Information on Advanced Line Search page using the Search for Lines See [Working with Large Requisitions](#)

Additional Information

<i>Field or Control</i>	<i>Description</i>
View Printable Version	Click to review the requisition printout on the page. Clicking this link does not print the requisition. Be aware that the requisition is saved prior to display. To preview the requisition, you must enter header, line, schedule, and distribution information.
Delete Requisition	Click to delete the requisition header and all records associated with the requisition. When you click this button, you must confirm that you want to delete the requisition. The system makes this field available for entry only if you are authorized to delete requisitions on the User Preferences - Procurement: Requisitions Authorizations page.
View Approvals	Click to review who is required to approve this requisition.

Related Links

- [Understanding Requisition Change Tracking](#)
- [Deleting Requisitions](#)
- [Budget Checking Requisitions](#)
- [Delivered Source Transaction Types for Purchasing](#)
- [Open Period](#)
- [Establishing Procurement Card Security](#)

Requisition Defaults Page

Use the Requisition Defaults page (REQ_HDR_DEFAULTS) to enter defaults that apply to the entire requisition.

You can override defaults at the line, schedule, and distribution levels.

Navigation:

Click the **Requisition Defaults** link on the Maintain Requisitions - Requisition page.

This example illustrates the fields and controls on the Requisition Defaults page. You can find definitions for the fields and controls later on this page.

When you change the default requisition header information and exit this page, whether you use the **Default** or **Override** option, the system prompts you with the Retrofit Field Changes to All Existing Requisition Lines/Schedule/Distributions page.

Default Options

Field or Control	Description
Default	If you select this option, the new default value that you enter on this page is assigned to the given field if no other value is assigned from prior defaults.
Override	<p>If you select this option, the new value that you enter on this page overrides any value that is assigned from prior defaults. Only nonblank values are assigned.</p> <hr/> <p>Note: If you are maintaining a requisition that is associated with a PeopleSoft Maintenance Management work order, the system does not override the changes that you make on this page for PeopleSoft Project Costing information (PC Business Unit, Project, and Activity fields) and asset information (AM Business Unit and Profile ID). The system does not apply project changes to the distribution rows because the work order is linked with projects information and you cannot change these values in PeopleSoft Purchasing. Plus, the asset information changes are not applied because distributions linked with a work order noninventory cannot be received as assets.</p> <hr/>

Line

<i>Field or Control</i>	<i>Description</i>
Buyer	Select a default buyer for this line.
Unit of Measure	Select a default unit of measure for the requisition. Selecting a default value here can help enable you to request ad hoc (description-only) items.
Supplier	Select a supplier.
Supplier Location	Select a supplier location.
Category	Select a default category code for the requisition. Selecting a default value here can facilitate the ability to request ad hoc (description-only) items.
Supplier Lookup	Click to search for a supplier.

Schedule

<i>Field or Control</i>	<i>Description</i>
Ship To	Select the default location where the supplier will ship the order.
Due Date	<p>Enter the default shipment due date to populate the requisition schedule. If you don't specify a due date here, when you source the requisition to a purchase order, the system derives the due date by incrementing the purchase order date by the number of lead time days defined for the item. If the item is not defined in the system, or if ordering by description-only, the due date becomes the purchase order due date by default.</p> <hr/> <p>Note: If the PeopleSoft Inventory business unit associated with the ship to location requires closure calendar validation and processing for receiving activities as defined on the Closure Calendar page and the due date that you enter here falls on a defined closure date, the system issues a warning. You can choose to keep the invalid date, or use the next valid date on the calendar.</p> <hr/>

Field or Control	Description
Ultimate Use Code	<p>Select an ultimate use code to override the default tax rate for a location.</p> <p>In most cases, sales tax is computed as a use tax based on the tax code applicable to the ship to or usage destination. However, how merchandise is ultimately used may also result in a different tax rate within the same ship to or usage destination.</p>
Distribute by	<p>Select to distribute by either amount or quantity.</p> <p>When you select the Override option on this page, you can set up multiple distribution lines. You then enter the percentage for each distribution in the distribution details. The sum of the line distribution percentages must equal 100 percent.</p>
Attention To	<p>Enter the person to whom, or place to where the services or goods are to be delivered. You can enter a new value or override the existing value. The system includes this field value on outbound purchase orders to the Marketplace.</p>
Ship Via	<p>Select the Ship Via Code.</p>
Freight Terms	<p>Select the Freight Terms Code.</p> <hr/> <p>Note: The Ship Via and Freight Terms codes displayed as default are copied from the Purchasing Options page.</p> <hr/>
Liquidate by	<p>Liquidate the outstanding pre-encumbrance and encumbrance balances by amount or quantity.</p> <hr/> <p>Note: This field is available only if commitment control is enabled and you choose the Liquidate by Quantity option on the Purchasing Definition - Business Unit Options page. If commitment controlled is not installed, or you do not choose the option to liquidate by quantity on the purchase order business unit page, the budget processor balance will liquidate by amount only.</p> <hr/>
Field or Control	Description
One Time Address	<p>Click to access the Req One Time Address Default page, where you can temporarily assign a supplier address.</p>

Distribution

<i>Field or Control</i>	<i>Description</i>
SpeedChart	<p>Select a default SpeedChart. The SpeedChart feature enables you to use a code that contains preset distributions.</p> <hr/> <p>Note: The field is enabled only when the default option is set to <i>override</i>. Accounting Tags appear in lieu of Speedcharts when the Accounting Tag check box is selected for Purchasing on the Accounting Tag Registration page. See “Setting Up Accounting Tags” (Application Fundamentals)</p> <hr/>
Accounting Tag	<p>Enter an Accounting Tag that will be used to populate ChartFields on transaction distribution lines. The system automatically prorates the distribution amounts according to the proration percentages defined on the Accounting Tag.</p> <hr/> <p>Note: Accounting Tags appear in lieu of Speedcharts when the Accounting Tag check box is selected for Purchasing on the Accounting Tag Registration page. See “Setting Up Accounting Tags” (Application Fundamentals)</p> <hr/>

Details

<i>Field or Control</i>	<i>Description</i>
Budget Date	<p>If you are using commitment control, the system supplies the budget date from the accounting date, but you can override it.</p>

Asset Information

Select the Asset Information tab.

Field or Control	Description
Business Unit (PeopleSoft Asset Management business unit)	<p>Select a PeopleSoft Asset Management business unit to associate with the asset item.</p> <hr/> <p>Note: If you consider an item to be an asset and plan to pass it to PeopleSoft Asset Management through the PeopleSoft Receiving business process, you must populate both the PeopleSoft Asset Management business unit and Profile ID fields.</p> <p>If both fields contain values, data is written to the PeopleSoft Asset Management staging tables. If only one of the fields is populated, the system does not consider the item an asset.</p> <hr/>
Profile ID	Select an asset profile ID.
Capitalize	Designates a capitalized item. A PeopleSoft Asset Management business unit must be selected for this check box to be enabled. If the item is capitalized, it can be depreciated before being paid.
Cost Type	<p>Select the cost type associated with the item purchase, if applicable. Cost types represent components of the cost of an asset, such as materials, labor, and overhead. For example, you can differentiate between the cost of building an asset and its market value by allocating production cost to one cost type and the profit margin to another. Cost type, in combination with asset category and transaction code, determines into which accounts the costs are entered in the general ledger.</p> <p>See “Understanding the Manufacturing Standard Cost Foundation” (PeopleSoft Cost Management).</p>

Related Links

Open Period

“Understanding PeopleSoft ChartField Configuration” (Application Fundamentals)

“Understanding PeopleSoft ChartFields” (Application Fundamentals)

“Closure Calendar Page” (PeopleSoft Inventory)

“Establishing Operation Closure Dates” (PeopleSoft Inventory)

Supplier Search Page

Use the Supplier Search page (VENDOR_LOOKUP_SEC) to search for suppliers.

Navigation:

Click the **Supplier Lookup** link on the Requisition Defaults page.

Field or Control	Description
Class	Select a class of suppliers: <i>A</i> (attorney), <i>E</i> (employee), <i>H</i> (HRMS), or <i>R</i> (outside party).
Type	Select a type of supplier: <i>ADV</i> (advertising), <i>CNS</i> (consultant), <i>CNT</i> (contractor), <i>ENT</i> (entertainment), <i>FRG</i> (foreign supplier), <i>GVT</i> (government), <i>MNR</i> (minority supplier), <i>PR</i> (public relations), <i>TRD</i> (tradesman), <i>TRN</i> (transportation), or <i>TRV</i> (travel-related services).

Address Page

Use the Address page (VENDOR_ADDR_SEC) to view address details for the location relevant to the page from which this page is accessed.

Navigation:

Click the **Address** link on the Supplier Search page.

When this page functions as a ship to address page, the address that appears is the address where the items will be shipped to. When this page functions as a supplier address page, the address that appears is the address that appears on the purchase order for the supplier.

The information on this page is supplied by the system from the address information entered on either the Location - Location Definition page or the Supplier Information - Address page.

Related Links

“Location - Definition Page” (Application Fundamentals)

“Entering Supplier Addresses” (PeopleSoft Source to Settle Common Information)

Req One Time Address Default (requisition one time address default) Page

Use the Req One Time Address Default (requisition one time address default) page (REQ_DFLT_ADDR) to set up a one-time ship to address for the selected transaction.

The address entered serves as the default one-time address for all new lines and schedules on the transaction document. You can have the system supply the address to the existing lines by default as well. You cannot define a one-time address for direct shipment requisitions. To change the address for a direct shipment, you must go to the sales order in PeopleSoft Order Management and make the address change there.

Navigation:

Click the **One Time Address** link on the Requisition Defaults page.

The fields on this page are identical to those on the Supplier Information - Address page. However, no **Effective Date** or **Status** fields are on this page because the address information on this page is used only for a one-time shipping address and is not retained by the system.

If you have added address information on this page, upon exiting the page, you'll be prompted with the Retrofit Field Changes To All Lines page, where you can select the default field changes that you want to apply to all applicable areas of the selected transaction document.

You cannot define a one-time address for direct shipment requisitions. To change the address for a direct shipment you must go to the sales order in PeopleSoft Order Management and make the address change there.

Related Links

[Retrofit field changes to all existing requisition lines/schedule/distributions Page](#)

“Entering Supplier Addresses” (PeopleSoft Source to Settle Common Information)

Retrofit field changes to all existing requisition lines/schedule/distributions Page

Use the Retrofit field changes to all existing requisition lines/schedule/distributions page (REQ_DFLT_RETROFIT) to apply changes to default values in requisition header, line, schedule, and distribution fields.

Navigation:

Exit the Header Defaults page after you have entered field value changes on the page or any of the pages accessed from it, and you have a transaction line that contains item description and quantity information.

When accessed from the requisition-related Header Defaults page, this page enables you to retrofit the header default field value changes to lines, schedules, and distributions on a requisition without having to manually apply them to each area. You can make the changes once and apply as many of them as you want to the transaction.

The option to apply these defaults is available depending on whether you select the **Default** or **Override** option on the requisition-related Header Defaults page.

Category and unit of measure defaults can be applied at the line level only for ad hoc (description-only) item requests.

<i>Field or Control</i>	<i>Description</i>
Apply	<p>Select to apply the default values for header fields to the distribution line that appears in the Distrib Line (distribution line) field. For example, if you select Apply for Distrib Line 3, the change will be applied to each Distrib Line 3 that appears on the requisition.</p> <p>If the Distrib Line field is blank, the header default field value change does not apply at the distribution level. In this case, select the Apply option to carry the default value changes for header fields to the line or schedule level instead.</p>
Distrib Line (distribution line)	<p>Displays the distribution line affected by the field value change. If this field is blank, the default value change for header fields does not apply at the distribution level.</p>

Field or Control	Description
Apply to All Distribs (apply to all distributions)	Select to apply the default value changes for header fields to all existing distribution lines on the transaction, regardless of the value that appears in the Distrib Line field. A distribution percentage value (DISTRIB_PCT) is specific to an individual distribution line. Therefore, the Apply to All Distribs option is unavailable for this field value change.

Related Links

[Maintain Requisitions - Requisition Page](#)

Header Comments Page

Use the Header Comments page (REQ_COMMENTS) to enter comments for a transaction.

You can enter a unique comment or select from predefined standard comments.

Navigation:

Click the **Add Comments** link on the Maintain Requisitions - Requisition page.

Field or Control	Description
Retrieve Active Comments Only	Select to retrieve only active comments. In Add mode, this check box is selected and cannot be deselected. After you inactivate a comment line using the Inactivate button, save, and then reenter the transaction, you cannot access the comment line when this check box is selected. You can deselect this check box to retrieve the comment line that you inactivated, in addition to any active comment lines.
Retrieve	Click to load existing comments into the comments text box. This button appears only if existing comments are available.
Sort Method	Select the method that you want to use to sort the comments retrieved: <i>Comment Time Stamp:</i> Select to sort the comments by the time stamp assigned by the system when they were created or modified. Each time a comment is modified, the comment time stamp is updated with the current date and time. <i>Supplier Flag:</i> Select to sort by comments flagged to be sent to the supplier.
Sort Sequence	Select whether you want to sort the retrieved comments in an ascending or descending order.

Field or Control	Description
Sort	Click to sort comments according to the selections that you made in the Sort Method and Sort Sequence fields.
Copy Standard Comments	Click to copy standard comments to the requisition header comments. When you click this link, the Standard Comments page appears. See Standard Comments Page .
Comment Status	Displays the status of the comments.
Inactivate	Click to inactivate the currently displayed comment. The comment is not actually deleted, but is set to an inactive status. If you need to retrieve inactive comments, you must deselect the Retrieve Active Comments Only check box and then click the Retrieve button. This enables you to retrieve all inactive comments. Note: Retrieving the comments again will override all the comments that you have worked on. However, any context that was previously saved as a standard comment will be saved after the transaction is complete.
Send to Supplier	Select if you want comments to appear on purchase orders dispatched to suppliers. If the comments are for internal use only, leave the check box deselected. The Send to Supplier option applies to comments in the comment text box only, not to the documents that you attach using the Associated Document fields.
Show at Receipt	Select if you want comments to appear on the receipt documents.
Show at Voucher	Select if you want comments to appear on the vouchers.
Approval Justification	Select to indicate that you want the comment to be used as an approval justification comment which appears in the Approval Justification section of the Requisition approval page. This flag appears when Workflow is enabled. When this flag is selected, then other flags (Send to vendor, shown at receipts, shown at voucher) is disabled. This is to make comments marked as approval justification is internal and send it to approval process internally. If user want to add comments to be shown at receipts/voucher then they have to add new comment row.

Associated Document

Use the fields in this group box to attach files to the transaction. You can attach any type of file. The documents that you choose to attach do not transmit with the purchase order to the supplier.

<i>Field or Control</i>	<i>Description</i>
Attachment	Displays the attachment ID. This field is unavailable for entry because the attachment is automatically assigned.
Attach	Click to attach a document to the comments. When you click this button, you will be prompted to select a file for uploading. Select the file, and then click the Upload button.
View	Click to display an attachment that has already been linked to the comments.
Delete	<p>Click to delete an attachment.</p> <hr/> <p>Note: When deleting an attachment, the system checks that the attachment is not referenced on another transaction within Supplier Relationship Management products. The physical file attachment will only be deleted from the server if no other document is linked to it. After an attachment is confirmed as deleted from the server, the file is removed immediately.</p> <hr/>
Email	Click to include the attachment when you email requisition comments.
Go To Source	<p>If the transaction's comments originated with another transaction, you can click this link to view the originating source transaction. This link is available only if a source is available.</p> <p>For example, if the requisition was copied from another requisition containing these comments, you can select this link to view the originating requisition.</p>

Standard Comments Page

Use the Standard Comments page (STD_COMM_SEC) to add standard comments to the comments text box.

You can modify the standard comments to meet the requirements of the transaction.

Navigation:

Click the **Copy Standard Comments** link on the Header Comments page.

Field or Control	Description
Action	<p>Select the action that you want to perform on the standard comments:</p> <p><i>Copy Comment:</i> Select to make the standard comments that you select available on the Comments page. You can use the standard comments as they are or modify them. Modifications to the standard comments on the Comments page do not affect the original standard comments. If you select this option, you must also select the comment type and comment ID for the standard comment that you want to use. The text of the selected standard comment appears in the text box at the bottom of the page.</p> <p><i>Create New Comment:</i> Select to enter a standard comment for an existing or new comment ID within an existing standard type. The comment that you enter becomes a new standard comment available on the standard comment table and is carried over to the transaction.</p> <p><i>Link to Comment:</i> Select to copy the selected standard comments to the Comments page. If you select this option, you cannot modify or add to the text of this comment. You can use this option multiple times to include more than one standard comment. If you select this option, you must also select the comment type and comment ID for the standard comment that you want to use. The text of the selected standard comment appears in the text box at the bottom of the page.</p>
Comment Type	Select a standard comment type code. Standard comment types are defined on the Std Comm Type page.
Comment ID	Select a standard comment using its comment ID. Various comments are available depending on the selected standard type. These comments and their IDs are user-defined on the Standard Comments page.

Related Links

“Setting Up Standard Comments” (PeopleSoft Source to Settle Common Information)

Currency Information Page

Use the Currency Information page (EXCH_RT_DTL_INQ) to display the rules used to calculate exchange rates for the transaction.

Navigation:

Select *01 - Exchange Rate Detail* in the **Go to** field on the Maintain Requisitions - Requisition page.

Field or Control	Description
Rate Quotation Basis	Displays the quotation basis for the exchange rate as defined on the Currency Quotation Method page. If a quotation method is not defined, the quotation basis is <i>Direct</i> .
Quote Units	Displays the quote units for the exchange rate as defined in the Currency Quotation Method page. If no quotation method is defined, the quote unit is <i>I</i> .
Triangulate	Displays the triangulated setting for the exchange rate as defined in the Currency Quotation Method page. If no quotation method is defined, the triangulated setting is <i>N</i> .
Reference Currency	Displays triangulated exchange rates only and shows the reference currency used in the triangulated exchange.
Current Quote	<p>Displays the current exchange rate used to convert the <i>From</i> currency to the <i>To</i> currency. A direct, nontriangulated rate shows quote units (or 1) on the left side of the equal sign and the visual rate on the right. For example:</p> <p>1 USD = 1.40000000 CAD</p> <p>An indirect, nontriangulated rate displays the visual rate on the left side of the equal sign and quote units (or 1) on the right. For example:</p> <p>1.40000000 CAD = 1 USD</p> <p>A triangulated rate displays two component rates of the triangle: the rate for converting the <i>From</i> currency to the <i>Reference</i> currency, and the rate for converting the <i>Reference</i> currency to the <i>To</i> currency. For example, for a direct rate quotation basis, USD to FRF involves triangulation, so 1 USD equals 5.69061334. The second rate for EUR is quoted indirectly. The third rate for EUR to FRF is direct and reads as follows:</p> <p>1.1527 USD = 1 EUR = 6.55957 FRF</p>
Historic Quote	<p>Displays a quote indicating the quotation method originally used by a historic exchange rate if the system determines that the quotation method originally used by the historic rate was different from the current quotation method. For example, the Historic Quote field displays a quote if the historic rate converted the <i>From</i> currency to the <i>To</i> currency directly using a calculated reciprocal rate, but the current quotation method for the currency pair is now indirect. The field would also display a quote if the historic quote method were nontriangulated and the current quote method is triangulated.</p> <p>If the system does not determine that the historic and current quote methods are different, the Historic Quote field displays <i>Not Applicable</i>.</p>

<i>Field or Control</i>	<i>Description</i>
Exchange Rate	Displays a single visual rate for nontriangulated exchange rates or displays all three component visual rates for triangulated exchange rates. The cross rate for triangulated exchange rates is editable only if the Allow Override check box is selected in the exchange rate's quotation method definition.

Related Links

“PeopleSoft Global Options and Reports Overview” (PeopleSoft Global Options and Reports)

Enter Kit Items Page

Use the Enter Kit Items page (REQ_KIT_ITEMS) to order an item by kit ID.

The individual items in the kit will become new lines on the requisition.

Navigation:

Click the **Purchasing Kit** link on the Maintain Requisitions - Requisition page.

PeopleSoft Purchasing kits are defined on the Purchasing Kit Definition page as a single item ID, representing two or more component items.

<i>Field or Control</i>	<i>Description</i>
Kit Quantity	Enter the number of kits that you want to order. Each item in the kit appears on a separate line on the transaction document. The quantity ordered for each item is equal to the quantity defined in the kit definition multiplied by the number of kits ordered.

Order By Catalog Page

Use the Order By Catalog page (ORD_BY_ITEM_CAT) to search for and select items to order from a catalog.

Navigation:

Click the **Catalog** link on the Maintain Requisitions - Requisition page.

<i>Field or Control</i>	<i>Description</i>
Retrieve Items	Click to retrieve a list of the items in the selected category.

Field or Control	Description
Item Search	<p>Click to display the entire catalog or a selected category. You can also click to retrieve a list of items that meet the requirements defined in the Item Search Options fields.</p> <hr/> <p>Note: This option is not available if the Item Search Options field is <i>List All</i>.</p> <hr/>
Limit Items by Supplier	<p>Select to limit the search to catalog items offered by the supplier designated on the Maintain Purchase Order - Purchase Order page. This check box is available only when you access the Order By Catalog page from the Maintain Purchase Order - Purchase Order page.</p>
Order	<p>Click to add selected items to the transaction document. For the item to be added, you must select the Sel check box for the item and enter a quantity in the Qty Ordered field.</p>
Line Page	<p>Click to return to the page from which you accessed the Order By Catalog page.</p>

Item Details Page

Use the Item Details page (ITM_CAT_DETAIL) to view details about the item.

Navigation:

Click the **Item Details** link on the Order By Catalog page.

The field values on this page appear by default from the Item Definition - General: Common page and the Purchasing Attributes page. The manufacturer description information appears by default from the Manufacturer page.

Item Supplier Priority Page

Use the Item Supplier Priority Page (ITM_CAT_VND) to view the name, status, priority, and price for the supplier.

Navigation:

Click the **Item Supplier** link on the Order By Catalog page.

Field or Control	Description
Status	<p>Displays the status of the item availability. Values are:</p> <p><i>A</i> (active): The item has a current effective date.</p> <p><i>D</i> (discontinued): The item has been discontinued by the manufacturer, or the supplier has decided to no longer supply the item.</p> <p><i>H</i> (hold): The item is temporarily unavailable from the supplier.</p> <p><i>I</i> (inactive): The item has an expired effective date.</p> <p><i>X</i> (to be deleted): The item is unavailable and will be or has been deleted from the system. You can use this status to write SQL scripts to remove obsolete items from active tables.</p>
Item Supplier Priority	<p>Displays the numeric rating assigned to each of the selected item approved suppliers. This rating designates the priority that the organization places on ordering the selected item from that supplier. The field values appear by default from the Purchasing Attributes - Item Supplier Priority page.</p>
Price	<p>Displays the supplier standard price for the selected item. This information appears by default from Supplier's UOM & Pricing Info (supplier's unit of measure and pricing information) page.</p>

Set Item Alias Page

Use the Set Item Alias page (None) to set up an alias for the selected item so that you don't have to remember the supplier's ID or description each time that you order the part.

Aliases are stored according to user ID so that each user can have a different alias for the same item.

Navigation:

Click the **Alias** link on the Order By Catalog page.

Field or Control	Description
Item Alias	<p>Enter an item alias. The alias is available after you save the transaction document. If you don't save the originating transaction document, the alias is not saved. The item alias is associated with a user ID and is available only to the specific user.</p>

Requester Favorite Items Page

Use the Requester Favorite Items page (REQUESTOR_ITEMS) to view, select for reorder, or modify all items requested by the requester.

Navigation:

Click the **Requester Items** link on the Maintain Requisitions - Requisition page.

This page lists all items that have been requested by the requester. You can also manually add or remove items from this list of favorites.

Select item check boxes to transfer the items to the requisition when you click **OK**.

<i>Field or Control</i>	<i>Description</i>
Last Date	Displays the last date on which the requester ordered the item.
Count	Display the frequency of the item requested. This is the number of time of times that this item has been requested by this requester.

Creating Requisition Lines

This section discusses how to create requisition lines:

Pages Used to Create Requisition Lines

<i>Page Name</i>	<i>Definition Name</i>	<i>Usage</i>
<u>Maintain Requisitions - Requisition Page</u>	REQ_FORM	Create requisitions online.
<u>Maintain Requisition - Details for Line Page</u>	REQ_LINE_DETAILS	Verify or modify line details, such as buyer, supplier, and other line-specific information.
Item Description Page	REQ_ITEM_DESCR	Enter and view descriptions for a specific item. The item description link comprises the first 30 characters of the item's description in the Transaction Item Description text box on the Maintain Requisitions - Details for a Line page.
Buyer Telephone Information Page	REQ_BUYER_INFO	View buyer telephone and fax numbers.

Page Name	Definition Name	Usage
View Category Hierarchy Page	CAT_PARENTAGE_SEC	View information about where a category resides in the entire catalog tree hierarchy.
Supplier Search Page	VENDOR_LOOKUP_SEC	Search for suppliers.
Supplier Summary Page	VNDR_ID1_SUM	View supplier summary information.
Configuration Info Page	REQ_LINE_CONFIG	View item configuration codes for configured items. The item that you query must be defined as a configured item and have configuration codes created for it.
Contract Page	CNTRCT_HDR	View detailed contract information.
Item Search Criteria Page	ITEM_SEARCH_SP	Search for items.
Look Up UOM Page	UOM_SEARCH_SP	Search for a unit of measure to associate with the item and supplier on the requisition.
Line Comments Page	REQ_COMMENTS	Enter line comments for a transaction. You can enter a unique comment or select from predefined standard comments.
Standard Comments Page	STD_COMM_SEC	Add standard comments to the comments text box. You can modify the standard comments to meet the requirements of the transaction.
Include Item Specifications Page	PO_ITEM_SPEX	<p>Include standard item specifications as they are or modify them to meet the requirements of the transaction comment.</p> <p>The item for which you are viewing comments must be associated with item specifications on the Item Specifications page.</p>
Defaults for Line Page	REQ_LINE_DEFAULTS	Enter default information for a requisition line.
<u>Retrofit field changes to all the distributions on the requisition line Page</u>	REQ_DFLT_RETROFIT	Apply default field-value changes for the requisition line to all distribution lines.

Page Name	Definition Name	Usage
Category Search Page	CAT_SEARCH_SEC	Search for and select an appropriate category ID for the item when entering an ad hoc item. The search for the category ID uses a category hierarchy tree.

Maintain Requisitions - Requisition Page

Use the Maintain Requisitions - Requisition page (REQ_FORM) to create requisitions online.

Navigation:

Purchasing > Requisitions > Add/Update Requisitions > Maintain Requisitions - Requisition

This example illustrates the fields and controls on the Maintain Requisitions - Requisition page. You can find definitions for the fields and controls later on this page.

This example illustrates the fields and controls on the Maintain Requisition - Requisition page(2of2). You can find definitions for the fields and controls later on this page.



Line	Item	Description	Quantity	*UOM	Category	Price	Merchandise Amount	Status
1	10089	Premier Casting Rod	2.5000	BOX	FISHING	600.00000	1,500.00	Approved
2	10010	Mountain Bike	10.0000	EA	CYCLING	9.00000	90.00	Approved





Requisition line numbers are assigned in the order in which you generate them, regardless of where you insert the lines. For example, if you open a requisition with five lines and insert a new line between lines 1 and 2, the new line is numbered 6, even though it appears between lines 1 and 2. When you save the requisition, leave the page, and reaccess the requisition, the last lines that you entered appear at the bottom of the scroll area.

If you create multiple requisition schedules for a requisition line, the quantity, unit of measure, price, and ship to location fields on the corresponding line on the Maintain Requisitions - Requisition page are unavailable for entry. This indicates that multiple values exist for one or more fields on the Maintain Requisitions - Schedule page.

Details

Select the Details tab.

Field or Control	Description
	Click the Details button to access the Maintain Requisitions - Details for Line page. Use this page to view the details for the requisition lines.
Item	Select the ID of the item that you want to order. If the item that you want to order does not have an item ID, you can order the item by description only. To do this, enter item information in the Description field.
Description	Enter a description of the item that is listed in the Item field. If you are ordering an item by description only, enter item information in this field. If you specify an item ID, the description appears from the Purchasing Attributes page.
 Item Search	Click to access the Item Search Criteria page where you can enter search criteria to locate and select an item that you want to apply to a requisition line. If you select this button from a requisition line with an item ID, you can replace the current item with the item that you select on the Item Search Criteria page. See Item Search Criteria Page .
Quantity	Enter the item quantity to order. The quantity is recalculated if you change the unit of measure.
UOM (unit of measure)	Select the unit of measure for the requested item.
Category	Enter the category for the item on the requisition line. If you specify an item ID, the category appears from the Purchasing Attributes page; you cannot change it.

Field or Control	Description
Price	<p>The item price derived through the pricing default hierarchy. You can change this value if it is enabled according to the default hierarchy. If you are ordering an item by description only, enter the item price. The price can also be derived based on contract pricing or price adjustment.</p> <p>If you are using commitment control, the price field is unavailable for modification when a requisition schedule that is distributed by quantity has been partially or fully sourced to a purchase order. This field is also unavailable for modification when you are creating a change order for a requisition (that is distributed by quantity) that has been partially or fully sourced to a purchase order.</p>
Merchandise Amount	Displays the total amount for the requisition line.
Status	Displays the status of this requisition line.
Use ProCard (use procurement card)	This check box appears as selected for the line if you have the Use Procurement Card check box selected at the header level. If you select this check box, this purchase order line will be charged to the procurement card.
	Click the Line Comments button to access the Line Comments page. Use this page to maintain line comments.
	Click the Line Defaults button to access the Details for Line page. Use this page to maintain line defaults.
	Click the Schedule button to access the Maintain Requisitions - Schedule page, where you can view schedule shipment details and distribution information.
	Click the Cancel Line button to cancel the line on the requisition.

Ship To/Due Date

Select this tab to access information about shipment ship date, due dates, and schedules.

See [Creating Requisition Schedules](#).

Status

<i>Field or Control</i>	<i>Description</i>
Status	Displays the current status of the requisition.

Supplier Information

<i>Field or Control</i>	<i>Description</i>
Supplier and Priority location	Displays the supplier and the priority location for the item and supplier. See Defining Purchasing Item Attributes

Item Information

Click on the Item Tab on the requisition to view the original sub item, description and item substitution search icon

This example illustrates the fields and controls on the Item Information page. You can find definitions for the fields and controls later on this page.

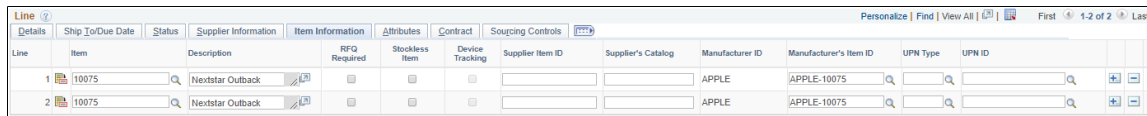

The Item Info Tab – shows the new item sub fields:

For more Information See [Understanding Item Substitution in Procurement](#)

<i>Field or Control</i>	<i>Description</i>
Original substituted item	Displays the original item ID on a procurement transaction that is being substituted. Once an Original Substituted Item is designated for a procurement transaction, it is carried all the way through to the receipt and cannot be changed. (The field name is also referred to as Original Item in some cases where the Item may or may not have been substituted.)
Substitute Item search	Select to display all the related substitute items

Field or Control	Description
RFQ Required (request for quote required)	<p>Select to indicate that this requisition line must be submitted for supplier quotes before purchase order sourcing. The setting of the RFQ Required check box appears as a default value from the Item Category - Purchasing Item Attribute Hierarchy.</p> <p>If you can override the RFQ required rule, which you set on the User Preferences: Procurement - Requisition Authorizations page, you can select or deselect the RFQ Required check box on this page.</p> <p>If you cannot override the RFQ required rule, you can only select the RFQ Required check box if it is deselected. You will receive an error message if you try to deselect the RFQ Required check box if it is selected.</p> <hr/> <p>Note: If the RFQ Required check box is deselected, the system checks to ensure that the business unit RFQ-required monetary threshold is defined, checks the line amount, and then sets the RFQ Required check box accordingly.</p> <p>After you save the requisition, the system also matches the requisition distribution ChartField values with the RFQ Rule ChartField values. If a match exists, the system selects the RFQ Required check box.</p>
Stockless Item	<p>Select to indicate that the ordered item is for par replenishment. This check box is available only if the selected item is set up as stockless, according to the default hierarchy for stockless items.</p>
Device Tracking	<p>Indicates whether a line contains a device-tracked item.</p>
Supplier Item ID	<p>Enter the item ID used by the supplier for this item.</p>
Supplier's Catalog	<p>Enter the item ID used by the supplier for this item.</p>
Manufacturer ID	<p>Enter the item ID that the supplier uses for this item.</p>
Manufacturer's Item ID	<p>Enter the manufacturer's item ID that the supplier uses for this item.</p>
UPN Type	<p>Select applicable UPN Type Code.</p>

Field or Control	Description
<p>UPN ID</p>	<p>Select applicable universal product number that is defined by a unique combination of item ID, manufacturer ID, manufacturer item ID, and Unit of Measure.</p> <p>On selecting the UPN ID, the item line information associated with the selected UPN ID will be populated.</p> <p>For inventory items, if you have set up the information in the Item Manufacturer UPN table, this information appears by default into the contract. If you order by UPN ID, the item ID and related information is copied to the purchase order or requisition line. The system verifies that the UPN ID is valid for inventory items and matches what is set up in the Item Manufacturer UPN table.</p> <p>When the Inventory Item ID has been left blank, an attempt will be made to retrieve the Inventory Item (from the Item Manufacturer UPN table) based on the UPN ID entered. UPN ID is the only value required for looking up the item in the Item Manufacturer UPN table. If a match with the Item Manufacturer UPN Table has been found, all of the fields associated with the UPN ID (Item ID, UPN Type, Mfg ID, Mfg Item, and UOM) will be defaulted onto the transaction line along with other Item attributes required for the requisition like Item description, Price, Supplier etc. No confirmation message will be displayed.</p> <hr/> <p>Note: For description only items (ad hoc items), you do not have the option to select UPN Type and UPN ID from the prompt. UPN ID and UPN Type values will default from the contract.</p> <hr/>
	<p>Clicking on the Item Search Icon will bring up the Substitute Item page (SUB_ITM_SRCH) that will allow the user to view all items available to substitute.</p>

Click on the Item Search icon to bring up the Substitute Item Page

This example illustrates the fields and controls on the Substitute Item Search Page. You can find definitions for the fields and controls later on this page.

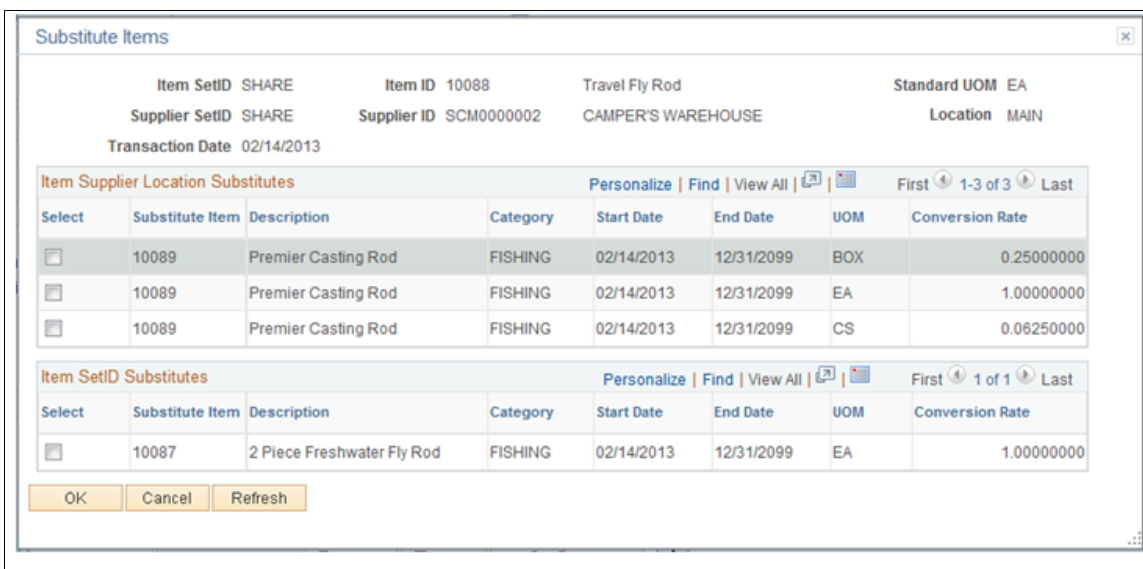

For more information on the Substitute Item Search Page See Manual Substitution [Understanding Item Substitution in Procurement](#)

Attributes

Field or Control	Description
 Item Details	Click to access Item Details page that provides item attributes.
Buyer	Select a buyer for the requisition line. If you select a new value on the requisition that is tied to a different default buyer (item, supplier, or category, for example), the value in this field is overridden with the new default buyer value. The buyer's name appears in the Name field after you select the buyer.
Name	Displays the buyer's name that corresponds to the buyer ID.
Physical Nature	Select to indicate whether the object is a physical good or service. Values are <i>Goods</i> and <i>Services</i> .

Field or Control	Description
Where Services Performed	<p>Select to indicate the location where the service is most often performed:</p> <p><i>Buyer's</i>: Select if the service is physically performed at the buyer's location.</p> <p><i>Ship From</i>: Select if the service is physically performed at the ship from location.</p> <p><i>Ship To</i>: Select if the service is physically performed at the ship to location.</p> <p><i>Supplier's</i>: Select if the service is physically performed at the supplier's location.</p> <hr/> <p>Note: This option is available only when the Physical Nature value is <i>Services</i>.</p> <hr/>
Zero Price Indicator	<p>Select to indicate that the line item is zero-priced. This option is deselected and unavailable for entry for ad hoc item orders.</p>

Field or Control	Description
Amount Only	<hr/> <p>Note: Amount Only work order can only be associated with Amount Only requisition line. If requisition is associated with non Amount Only work order then work order association must be removed to change requisition line to Amount Only otherwise system would issue an error message.</p> <hr/> <p>Select this check box to designate the line as an amount-only line. If you select this check box when creating a new requisition line, these actions occur on the requisition:</p> <ul style="list-style-type: none"> • The requisition and schedule quantity are set to <i>1</i> and these fields become unavailable for entry. • The Price field on the line is available for entry. The price amount that you enter becomes the schedule price and amount. <hr/> <p>Note: An amount-only line cannot be priced at zero.</p> <hr/> <ul style="list-style-type: none"> • The Inspection Required check box is unavailable for entry. • The Consolidate with other Reqs, and Inventory Source Flag check boxes are unavailable for entry. • The Distribute By and Liquidate By fields are set to <i>Amount</i> and become unavailable for entry. • The PeopleSoft Inventory business unit field is cleared and this field becomes unavailable for entry. <p>In addition, amount-only requisition lines can have only one schedule line. The system prevents you from adding another schedule line by removing the Add Row button on the Maintain Requisitions - Schedule page.</p> <p>If you have an existing requisition line, and then select this option, each of these values discussed previously is reset. If you are using commitment control, changing the setting of the Amount Only check box causes the resetting of the budget status to not checked.</p> <p>The Amount Only check box is not available for entry under these conditions:</p> <ul style="list-style-type: none"> • The requisition line originated from PeopleSoft Inventory, PeopleSoft Project Costing, PeopleSoft Product Configurator, PeopleSoft Maintenance Management, and PeopleSoft Order Management.

Field or Control	Description
	<ul style="list-style-type: none"> The requisition line has been partially or fully sourced to a purchase order, request for quote, service work order, or strategic sourcing. <p>If PeopleSoft Strategic Sourcing is installed in your environment, you can set the Amount Only and RFQ Required check boxes at the same time. If PeopleSoft Strategic Sourcing is not installed, the Amount Only and RFQ Required check boxes cannot be set at the same time.</p> <p>If both check boxes are selected at the same time, the system issues a warning message prior to deselecting the Amount Only check box.</p>
Inspection Required	Select to require that this item be inspected. You define inspection instructions at the item level on the Inspection Routing page. This inspection instruction information is captured upon receipt and can be modified or overridden at the time of inspection.
Inspect ID	Select an inspection ID. This field becomes available when you select the Inspection Required check box.

Field or Control	Description
<p>Procurement Group ID</p>	<p>Select an existing Procurement Group ID for the item (search on partial or full values of the Procurement Group ID, Short Name or Description). When you select a Procurement Group ID, an edit enforces that the Receiving Required option is set. A save-time edit verifies that all items in the Procurement Group ID belong to the same Asset Management Business Unit value when the Allocate Purchasing Group to Assets option is selected on the Purchasing Options page. See Purchasing Options Page</p> <p>See Understanding Procurement Groups in PeopleSoft.</p> <hr/> <p>Note: Note: Once the composition of a procurement group has been established, it should not be changed. If the composition (items that make up a procurement group) should change, then a new procurement group should be created and utilized instead. Since the Receipt Push process examines all of the purchase order lines and open requisition lines in determining the composition of the procurement group, if you create a new transaction with different items intending that only the new or different items replace those that make up the procurement group, the former items and the new items will be identified later as making up the procurement group. Hence, in the event the composition of a procurement group needs to change (and it is too late to disassociate all former transaction lines in the system from the procurement group), a new procurement group should be created for the new items.</p> <hr/>

Field or Control	Description
Primary Unit	<p>Select this item as the primary unit for the procurement group. If this item has already been designated as primary for the procurement group, then the primary unit check box is automatically selected when the item ID is entered on the transaction line. Only one Item ID (or Description-Only item) can be set as Primary Unit for a procurement group. If you try to select an item (or Description Only item) as the primary unit and one has already been designated for the group, this results in an error message that disallows selection. This edit spans all transactions for Requisitions, Purchase Orders, Receipts and Vouchers.</p> <p>When an Item is Serialized and set as the Primary Unit, the system forces a Unit Allocation Qty = 1. If the Primary Unit flag is selected after Unit Allocation Qty > 1, a message lets you know that the system is resetting the Primary Unit Allocation Qty to 1 because this is a serialized item. When an Item is non-serialized and the Unit Allocation fields are blank, an error message informs you that the Unit Allocation fields are blank and you need to enter an Unit Allocation Qty or Allocation Amt.</p>
Unit Allocation Qty	<p>Enter a Unit Allocation Qty if the Amount Only field is deselected. If the Allocate Purchasing Group option is enabled on the Purchasing Options page, the value in this field determines how many asset lines are generated; for example, one asset line per each unit of allocation quantity until the sum totals the receipt line distribution quantity.</p>
Unit Allocation Amt	<p>The Unit Allocation Amt can only be entered when the Amount Only field is selected. If the Allocate Purchasing Group option is enabled on the Purchasing Options page, the value in this field determines how many asset lines are generated: one asset line per each unit of allocation amount until the sum totals the receipt line distribution amount.</p>

Contract

Use the Contract tab to view and maintain contract information related to the requisition. Using this tab, you can control whether you use an existing contract for requisition lines and search for contracts that match requisition requirements when you don't need to calculate the price.

Requisition lines with an item ID can reference line item contracts, contracts by category, and open item contracts. If the requisition is by amount only, whether the order is by description or line item, you can reference contracts only by category or open-item reference.

<i>Field or Control</i>	<i>Description</i>
	<p>Click the Contract Search button to access the Contract Search page, where you can perform advanced searches for contracts See Contract Search Page.</p> <p>You can also search based on the contract style.</p> <p>See“Contract Style page” (PeopleSoft Source to Settle Common Information).</p>

Field or Control	Description
<p>Contract ID</p>	<p>Select the contract ID that you want to associate with the requisition line.</p> <p>Contract terms and pricing on the requisition may not reflect the true contract terms and pricing. When the requisition is sourced to a purchase order, the PO Calculations process calculates the purchase order terms and pricing according to the contract conditions.</p> <p>If a supplier is selected, you can select only from those contracts that are set up with the supplier. If a supplier is not defined yet, the supplier associated with the specified contract appears. After you have specified a contract, you cannot change the supplier. The Override Suggested Supplier check box is deselected and is unavailable for entry. If an item ID exists on the contract, the Calc Price (calculate price) check box is selected and unavailable for entry.</p> <p>You can select a contract ID and not the contract line number only if the contract is defined as an open item contract. This option is available for item ID, description-only, and amount-only lines. Amount-only requisition lines can be associated only with open-item contracts.</p> <p>To be eligible for selection on this page, the contract must be in <i>Approved</i> status and cannot be defined as an amount-only contract. Even if you do not specify a contract here, if you source the requisition through the PO Calculations process, the process may find an eligible contract for the requisition, and that contract is used on the purchase order.</p> <p>If the purchase order business unit's RFQ required rule indicates that the contract ID should be copied to the transaction if a valid contract is located, the contract ID and line number will be supplied by default to the requisition line.</p> <hr/> <p>Note: If you select a blanket purchase order contract, you cannot override the choice by selecting a different purchase order on the Requisition Selection - Staging page. You cannot select the Define PO option on this page because you are using a contract that is assigned to one specific purchase order and the purchase order is already defined. You can click the Contract Details link to review the details of the contract that you select in this field.</p> <hr/> <p>See “Understanding Voucher and Order Contracts” (PeopleSoft Source to Settle Common Information).</p>

Field or Control	Description
Contract Version	<p>Select the contract version that you want for this requisition line. Multiple versions are available when you are using version control. Contract versions enable contract administrators to create and maintain multiple versions of a contract in the procurement system. The field appears when version control has been established for the business unit.</p> <p>You define user authorization for changing a version using the Purchase Order Authorizations page. To access the page, select Set Up Financials/Supply Chain > Common Definitions > User Preferences > Define User Preferences > Procurement and click the Purchase Order Authorizations link. You must have the authority to update the contract version.</p>
Contract Line	<p>Select the contract line that you want to apply to this requisition line.</p>
Category Line Number	<p>Select a contract category line number. Categories enable you to specify groups of items on a contract, rather than having to enter the items one at a time.</p>
Use Contract if Available	<p>Select to use contract pricing for this requisition line item. This overrides the setting of the Calculate Price check box on the Sourcing Controls tab that determines whether the system uses purchase order sourcing to define a contract. When you select the Use Contract if Available check box, the system uses the contract that you select for pricing an item on this requisition row.</p> <p>The Use Contract if Available check box is selected if the Contract Required check box is selected on the Purchasing Controls tab of the Purchasing Attributes page.</p> <p>When you search for a contract and select to use the contract, the system automatically selects the Use Contract if Available check box.</p>
GPO Contract (group purchasing organization contract)	<p>Select the group purchasing organization contract number.</p>
GPO ID (group purchasing organization ID)	<p>Select the group purchasing organization ID.</p>

Field or Control	Description
Group ID	<p>Displays the line group to which this line item belongs. A line group is a bundle of items that buyers use in PeopleSoft Strategic Sourcing to obtain better pricing for items. The system populates the Group ID field when:</p> <ul style="list-style-type: none"> • The line is being awarded from PeopleSoft Strategic Sourcing to the requisition. • Requisition sourcing selects a contract line that has a group ID assigned to it. <p>The group ID is copied from the contract line to the requisition line.</p> <ul style="list-style-type: none"> • A line group contract line is selected when you create a new requisition and the group ID is copied from the contract line to the requisition line. <p>See “Line Groups” (PeopleSoft Strategic Sourcing).</p>

Sourcing Controls

Select the Sourcing Controls tab.

These values control the unit price tolerances that the system uses to determine whether a requisition can be accepted by the PO Calculation process (PO_POCALC). The PO Calculation process calculates the correct price for a purchase order based on the item supplier or item price plus or minus any price adjustments. It can use the contract price if a contract is used and the **Use Contract Base Price** option is selected on the contract line.

The system applies the sourcing unit price tolerance to the suggested price on the requisition and then compares the result with the calculated purchase order price. If the purchase order price is outside the tolerance, the PO Calculations process rejects the staged row.

If you change the price of an ad hoc item on the Requisition Selection - Sourcing page, and the price exceeds tolerances defined here, the ad hoc row is not rejected. Instead, the system recognizes that the price exceeds the defined tolerances, issues a warning, and gives you the option to accept the newly entered price or reset it to the price defined on the original requisition.

Field or Control	Description
Source Date	<p>Enter the date when the requisition is available for sourcing. The default value is the current system date. The requisition is available on the Requisition Selection page and AutoSelect Req page only after the source date.</p>

Field or Control	Description
Calculate Price	<p>Select to have the PO Calculations process recalculate the sourced purchase order price based on the supplier selected. If this check box is deselected, the requisition price is the purchase order price.</p>
Override Suggested Supplier	<p>Select to enable the sourcing process to override the suggested supplier. If you select this check box, the system overrides any supplier suggested on the requisition line with the supplier selected based on the applicable sourcing method.</p> <p>The setting of this check box depends on the setting of the Override Preferred Supplier check box on the User Preferences - Procurement: Requisition Authorizations page.</p> <p>If the Override Preferred Supplier check box is selected, the Override Suggested Supplier check box is selected and can be deselected.</p> <p>If the Override Preferred Supplier check box is deselected, the Override Suggested Supplier check box is selected and cannot be deselected. The logic behind this setting is that if you are not authorized to override the preferred supplier, you must accept the supplier selected by the PO Calculations process.</p>
Consolidate with other Reqs (consolidate with other requisitions)	<p>Select to source the line item to a purchase order line, along with quantities of the same item from other requisitions.</p> <p>If selected, you must also select the Override Suggested Supplier check box.</p>
Source to Inventory	<p>Select to source this requisition line from inventory. The check box is selected by default for inventory items. If the check box is selected, the Build Inventory Demand process (PO_REQINVS) attempts to fulfill the request. If it cannot fulfill the full demand, the remaining order quantity is sourced to a purchase order.</p>
Auto Item Substitute	<p>Select to uncheck the 'Auto Item Substitution' box on a Requisition Line when you wish to retain the current Item ID and do not want it automatically substituted during sourcing. Additionally, you will be able to reject a Substitute Item found by Auto Item Substitution on the online requisition.</p>

Field or Control	Description
Sourcing Controls	Select the method for sourcing tolerances. Values are: <ul style="list-style-type: none"> • <i>% Unit Price Tolerance</i> • <i>Unit Price Tolerance</i>
% Unit Price Tolerance (percent unit price tolerance)	If you select a sourcing control of <i>% Unit Price Tolerance</i> , then enter the upper base price tolerance on a percentage of the suggested requisition price. If you want no tolerances to apply, enter exactly <i>999.99</i> .
% Unit Price Tolerance - Under (percent unit price tolerance - under)	Enter the lower price tolerance percentage. Prices that are less than this tolerance are rejected. A tolerance of <i>0</i> means that the requisition price must match the purchase order price. It does not mean that tolerances do not apply.
Unit Price Tolerance	If you select a sourcing control of <i>Unit Price Tolerance</i> , then enter the upper base price tolerance on an amount over the suggested requisition price. In Add mode, <i>999999.99999</i> appears by default. If you want no tolerances to apply, enter exactly <i>99999999.99999</i> .
Unit Price Tolerance - Under	Enter the lower unit price amount tolerance. Prices that are less than this tolerance are rejected. A tolerance of <i>0</i> means that the requisition price must match the purchase order price. It does not mean that tolerances do not apply.

Related Links

[Understanding Purchasing Item Information](#)

[Understanding the UOM Conversion Hierarchy](#)

[UOM Conversion Rate Defaults](#)

Item Search Criteria Page

Use the Item Search Criteria page (ITEM_SEARCH_SP) to search for items.

Navigation:

Click the **Item Search** button or the **Item Search** link on the Maintain Requisitions - Requisition page.

All of the fields available for entry on this page compose the item search criteria. The system finds all items that match the search criteria entered. You can perform as wide or narrow a search as needed, but you must enter at least one search parameter. The values that appear on this page are defined in the Item Definition component.

Then after the search results appear, select the check box next to the associated item and click the **Return** button to populate the selected transaction line on the page from which you originally accessed this page. Selecting this check box causes the selected item to overwrite any existing item on the selected line on the page from which you accessed this page.

Related Links

“Defining Items at the SetID Level” (PeopleSoft Managing Items)

Defaults for Line Page

Use the Defaults for Line page (REQ_LINE_DEFAULTS) to enter default information for a requisition line.

Navigation:

Click the **Line Defaults** button on the Maintain Requisitions - Requisition page.

This example illustrates the fields and controls on the Defaults for Line page. You can find definitions for the fields and controls later on this page.

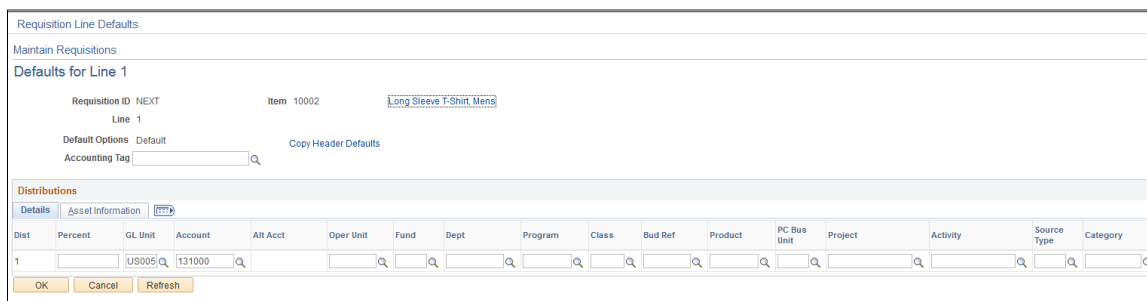

When you change requisition line default information and exit the page, whether using the **Default** or **Override** option set at the header, the system prompts you with the **Retrofit** field changes to all the distributions on the requisition line page.

Field or Control	Description
Default Options	Displays either <i>Default</i> or <i>Override</i> . This value is defined on the Requisition Defaults page.
SpeedChart	<p>Select a default SpeedChart. The SpeedChart feature enables you to use a code that contains preset distributions.</p> <hr/> <p>Note: The field is enabled only when the default option is set to <i>override</i>.</p> <hr/> <p>Note: Accounting Tags appear in lieu of Speedcharts when the Accounting Tag check box is selected for Purchasing on the Accounting Tag Registration page. See “Setting Up Accounting Tags” (Application Fundamentals)</p>

Field or Control	Description
Accounting Tag	<p>Enter an Accounting Tag that will be used to populate ChartFields on transaction distribution lines. The system automatically prorates the distribution amounts according to the proration percentages defined on the Accounting Tag.</p> <hr/> <p>Note: The field is enabled only when the default option is set to <i>override</i>.</p> <hr/> <p>Note: Accounting Tags appear in lieu of Speedcharts when the Accounting Tag check box is selected for Purchasing on the Accounting Tag Registration page. See “Setting Up Accounting Tags” (Application Fundamentals)</p> <hr/>
Copy Header Defaults	Click to copy requisition header distribution defaults to the line.

Details Tab

Select the Details tab.

Enter the percentage for each distribution in the distribution details. The sum of the line distribution percentages must equal 100 percent. If the **Default Options** field is set to *Override*, you can set up multiple distribution lines.

Related Links

[Retrofit field changes to all existing requisition lines/schedule/distributions Page](#)

[Requisition Defaults Page](#)

“Understanding PeopleSoft ChartFields” (Application Fundamentals)

Retrofit field changes to all the distributions on the requisition line Page

Use the Retrofit field changes to all the distributions on the requisition line page (REQ_DFLT_RETROFIT) to apply default field-value changes for the requisition line to all distribution lines.

Navigation:

Exit the Defaults for Line page (requisition-related) after you have entered field value changes on the page or any of the pages accessed from it, and you have a transaction line that contains item description and quantity information.

Note: This page is very similar to the Retrofit field changes to all existing requisition lines/schedule/distributions page.

When accessed from the requisition-related Defaults for Line page, this page enables you to retrofit the line default field value changes to schedules and distributions on a requisition without having to manually apply them to each area. You can make the changes once and apply as many of them as you want to the transaction.

The option to apply these defaults is available depending on whether you select the **Default** or **Override** option on the requisition-related Requisition Defaults page.

<i>Field or Control</i>	<i>Description</i>
Apply	Select to apply the line default value to the distribution line field that appears in the Distrib Line (distribution line) field, if it exists on the selected requisition line.
Distrib Line (distribution line)	Displays the distribution line affected by the field value change.
Apply to All Distribs (apply to all distributions)	Select to apply the line default field value change to all existing distribution lines on the requisition line, regardless of the distribution line value that appears. A distribution percentage value (DISTRIB_PCT) is specific to an individual distribution line. Therefore, the Apply to All Distribs check box is unavailable for this field value change.

Maintain Requisition - Details for Line Page

Use the Maintain Requisition - Details for Line page (REQ_LINE_DETAILS) to verify or modify line details, such as buyer, supplier, and other line-specific information.

Navigation:

Click the **Details** button on the Maintain Requisitions - Requisition page.

Note: Most fields on this page are described in the Entering Requisition Line Information section. See that section if a field is not described for this page.

See [Maintain Requisitions - Requisition Page](#).

<i>Field or Control</i>	<i>Description</i>
Create Line Change	<p>When a requisition is eligible for change request or change order tracking, the system makes this button, and all change template fields, available for entry. Inserting a new line or schedule or canceling an existing line or schedule may create a change order. You can't delete a line or schedule. If you cancel a line, you also cancel its schedules and distributions.</p> <p>When you click the Create Line Change button, the system checks to determine whether this is the first change order for this requisition. If so, the system inserts change order fields with the batch number and sequence number of 0 to store the original history values for the line.</p> <p>When you change the quantity field on the line level, if only one schedule is tied to the line, both line and schedule quantity fields are tracked if they are the change order fields.</p>

Line Details

<i>Field or Control</i>	<i>Description</i>
Buyer	Select a buyer for the requisition line. If you select a new value on the requisition that is tied to a different default buyer (item, supplier, or category, for example) the value in this field will be overridden with the new default buyer value.
Category	Displays the category to which the requisition line item is assigned.
Transaction Item Description	Enter a unique description for the item.

Amount Summary

<i>Field or Control</i>	<i>Description</i>
Merchandise Amount	Displays the total price of the items on the requisition line in the transaction currency.

Additional Information

<i>Field or Control</i>	<i>Description</i>
Use Procurement Card to pay for this item	This check box appears as selected if at the requisition line level you have selected the Use ProCard check box. Select this check box if you want the procurement card to be the payment method for this requisition line.

Supplier Information

<i>Field or Control</i>	<i>Description</i>
Supplier ID (supplier identification)	<p>Displays by default the first priority supplier ID for the requisition line, along with its default supplier location. You can override these values or enter values if the fields are blank.</p> <p>Changing the supplier value may affect the supplier location, supplier catalog ID, supplier item ID, and buyer values for the requisition.</p> <p>The supplier ID is supplied by default according to the hierarchy defined for Item Supplier ShipTo, Item Supplier Region, and Item Supplier tables.</p>
Supplier GLN	Displays the GLN values based on the Supplier

Item Information

<i>Field or Control</i>	<i>Description</i>
Supplier's Catalog and Supplier Item ID	The supplier catalog and item ID assigned to the selected item-supplier combination appear. These values are supplied by default from the Purchasing Attributes - Item Supplier page.

Field or Control	Description
RFQ Required (request for quote required)	<p>The setting of the RFQ Required check box appears by default from the Item Category - Purchasing Item Attribute Hierarchy.</p> <p>Select this check box to indicate that this requisition line must be submitted for supplier quotes before purchase order sourcing.</p> <p>If you can override the RFQ required rule, which you set on the User Preferences: Procurement - Requisition Authorizations page, you can select or deselect the RFQ Required check box on this page.</p> <p>If you cannot override the RFQ required rule, you can select the RFQ Required check box only if it is deselected. You receive an error message if you try to deselect the RFQ Required check box if it is selected.</p> <hr/> <p>Note: If the RFQ Required check box is deselected, the system checks to ensure that the business unit RFQ Required Monetary Threshold is defined, checks the line amount, and then sets the RFQ Required check box accordingly.</p> <p>When you save the requisition, the system also matches the requisition distribution ChartField values with the RFQ Rule ChartField values. If a match exists, the system selects the RFQ Required check box.</p> <hr/>
Stockless Item	Select to indicate that the ordered item is for par replenishment. This check box is available only if the selected item is set up as stockless, according to the default hierarchy for stockless items.
Device Tracking	Indicates whether a line contains a device-tracked item.
Configuration Info (configuration information)	Click to access the Configuration Information page. For this link to be available, the line item must have configuration information with which it is associated. In addition, the requisition must have a PeopleSoft Inventory business unit defined and the Consolidate with other Reqs check box must be deselected.
UPN Type	Select applicable UPN Type Code.

Field or Control	Description
UPN ID	<p>Select applicable universal product number that is defined by a unique combination of item ID, manufacturer ID, manufacturer item ID, and Unit of Measure.</p> <p>On selecting the UPN ID, the item line information associated with the selected UPN ID will be populated.</p>

Attributes

Field or Control	Description
Physical Nature	Select to indicate whether the object is a physical good or service. Values are <i>Goods</i> and <i>Services</i> .
Where Services Performed	<p>Select to indicate the location where the service is most often performed:</p> <p><i>Buyer's</i>: Select if the service was physically performed at the buyer's location.</p> <p><i>Ship From</i>: Select if the service was physically performed at the ship from location.</p> <p><i>Ship To</i>: Select if the service was physically performed at the ship to location.</p> <p><i>Supplier's</i>: Select if the service was physically performed at the supplier's location.</p> <hr/> <p>Note: This option is available only when the Physical Nature value is <i>Services</i>.</p> <hr/>
Zero Price Indicator	Select to indicate that the line item is zero-priced. This check box deselected and unavailable for entry for ad hoc item orders.

For Procurement Group Id to Unit Allocation Amount See field description [Maintain Requisition - Details for Line Page](#)

Contract

Field or Control	Description
Contract ID	<p>Select the contract ID that you want to associate with the requisition line. The adjacent field displays the contract line number.</p> <p>Contract terms and pricing on the requisition may not reflect the true contract terms and pricing. When the requisition is sourced to a purchase order, the PO Calculations process calculates the purchase order terms and pricing according to the contract conditions.</p> <p>If a supplier is selected, you can select from only those contracts set up with the supplier. If a supplier is not defined yet, the supplier associated with the specified contract appears. When you have specified a contract, you cannot change the supplier. The Override Suggested Supplier check box is deselected and unavailable for entry. If an item ID exists on the contract, the Calc Price (calculate price) check box is selected and unavailable for entry.</p> <p>You can select a contract ID and not the contract line number only if the contract is defined as an open item contract. This option is available for item ID, description-only, and amount only lines.</p> <p>Amount-only requisition lines can be associated only with open item contracts.</p> <p>To be eligible for selection on this page, the contract must be in <i>Approved</i> status and cannot be defined as an amount only contract.</p> <p>Even if you do not specify a contract here, if you source the requisition through the PO Calculations process, the process may find an eligible contract for the requisition, and that contract is used on the purchase order.</p> <p>If the purchase order business unit's RFQ required rule indicates that the contract ID should be copied to the transaction if a valid contract is located, the contract ID and line number will be supplied by default to the requisition line.</p>

Field or Control	Description
	<p>Note: If you select a blanket purchase order contract, you cannot override the choice by selecting a different purchase order on the Requisition Selection - Staging page. You cannot select the Define PO option on this page because you are using a contract that is assigned to one specific purchase order and the purchase order is already defined. You can click the Contract Details link to review the details of the contract that you select in this field.</p>
	<p>Click the Contract Search button to access the Contract Search page, where you can perform advanced searches for contracts.</p> <p>See Contract Search Page.</p>
Version	Displays the contract version when you are using track changes for contracts.
GPO Contract (group purchasing organization contract)	Select the group purchasing organization's contract number.
GPO ID (group purchasing organization ID)	Select the group purchasing organization ID.

Sourcing Controls

Field or Control	Description
Calculate Price	<p>Select to have the PO Calculations process recalculate the sourced purchase order price based on the supplier selected. If this check box is deselected, the requisition price is the purchase order price. This check box is available for entry for description-only items. This check box is selected and unavailable for entry for item ID lines when a contract is specified.</p>

Related Links

[Understanding Requisition Change Tracking](#)

[Defining Purchasing Item Attributes](#)

[Supplier's UOM and Pricing Information \(Supplier's unit of measure and pricing information\) Page PO Calculations Page](#)

[Understanding GPO Contracts](#)

“Using Universal Item Identifiers” (PeopleSoft Managing Items)

“Using Device Tracking” (PeopleSoft Managing Items)

Item Description Page

Use the Item Description page (REQ_ITEM_DESCR) to enter and view descriptions for a specific item.

The item description link comprises the first 30 characters of the item's description in the Transaction Item Description text box on the Maintain Requisitions - Details for a Line page.

Navigation:

Click the **Item Description** link on the Maintain Requisitions - Details for Line page.

The item description appears in the base language in the **Transaction Item Description** text box. The item description appears in the preferred language in the display-only **Preferred Language Item Descr** (preferred language item description) text box. The preferred language is the language preference that you specify when you log in to the system.

The item descriptions in the preferred language are defined in the Purchasing Attributes component. This component is capable of storing certain field values in the base language, as well as in preferred languages.

For example, if the base language for the system is French, but you log in with a preferred language of Dutch, certain fields, including **Item Description** in the Purchasing Attributes component, are available for entry in the preferred language of Dutch. If you enter an item description in a preferred language of Dutch, when you log in to the system with a preferred language of Dutch and access the Item Description page, the **Preferred Language Item Desc** text box displays the item description that you entered in the preferred language. The **Transaction Item Description** text box retains the item description entered in the base language.

If an item description in the preferred language does not exist, or if the base and preferred languages are the same, the base language item description appears in the **Preferred Language Item Descr** text box.

You can modify the item description in the **Transaction Item Description** text box on the transaction line for requisitions, RFQs, contracts, and purchase orders. For all other scenarios, the **Transaction Item Description** group box is unavailable for entry.

Use the **Description** text box on the transaction line to enter ad hoc items on RFQs, requisitions, contracts, and purchase orders. The description that you enter becomes available on the Item Description page. The preferred language option is not applicable in this scenario.

Related Links

[Defining Purchasing Item Attributes](#)

View Category Hierarchy Page

Use the View Category Hierarchy page (CAT_PARENTAGE_SEC) to view information about where a category resides in the entire catalog tree hierarchy.

Navigation:

Click the **View Hierarchy** link on the Maintain Requisitions - Details for Line page.

Field or Control	Description
Catalog ID	Select a catalog ID to display the catalog's category hierarchy. Click the folder button to display item categories and subcategories contained in the selected catalog.

Buyer Telephone Information Page

Use the Buyer Telephone Information page (REQ_BUYER_INFO) to view buyer telephone and fax numbers.

Navigation:

Click the **Buyer Information** link on the Maintain Requisitions - Details for Line page.

Related Links

“Defining Buyers” (PeopleSoft Source to Settle Common Information)

Line Comments Page

Use the Line Comments page (REQ_COMMENTS) to enter line comments for a transaction.

You can enter a unique comment or select from predefined standard comments.

Navigation:

Click the **Line Comments** button on the Maintain Requisitions - Requisition page.

The fields on this page are the same as the fields on the Header Comments page.

See [Header Comments Page](#).

Include Item Specifications Page

Use the Include Item Specifications page (PO_ITEM_SPEX) to include standard item specifications as they are or modify them to meet the requirements of the transaction comment.

The item for which you are viewing comments must be associated with item specifications on the Item Specifications page.

Navigation:

Click the **Copy Item Specs** (copy item specifications) link on the Line Comments page.

Field or Control	Description
Action	<p>Select the action that you want to perform on the standard item specification:</p> <p><i>Copy Comment:</i> Select this value and select the Select check box to make the selected item specifications available on the Line Comments page. On the Line Comments page, you can use the item specifications as they appear or modify them. Modifications to the item specifications on the Line Comments page do not affect the original item specifications.</p> <p><i>Link to Comment:</i> Select this value and select the Select check box to copy the selected item specifications to the Line Comments page. If you select this value, you cannot modify or add to the specifications text on the Line Comments page.</p>
Select	Select to include the associated item specifications on the Line Comments page.
Send to Supplier	<p>Displays the setting as defined on the Item Specification page.</p> <p>If this check box is selected, when you move the item specifications to the Line Comments page, the Send to Supplier check box on the Line Comments page is automatically selected and the item specifications are eligible to be sent to the supplier.</p>

Category Search Page

Use the Category Search page (CAT_SEARCH_SEC) to search for and select an appropriate category ID for the item when entering an ad hoc item.

The search for the category ID uses a category hierarchy tree.

Navigation:

Select *03 - Category Search* in the **Go to** field on the Maintain Requisitions - Requisition page.

Field or Control	Description
Catalog ID	Select the catalog ID that you want the system to use to locate the catalog in which you want to search for item categories.
All Items	Click to display all categories associated with the selected catalog. Select a category to populate the Category field on the transaction and then click the OK button.

Creating Requisition Schedules

This section discusses how to create requisition schedules

Pages Used to Create Requisition Schedules

<i>Page Name</i>	<i>Definition Name</i>	<i>Usage</i>
<u>Maintain Requisitions - Schedule Page</u>	REQ_SCHEDULE	Specify multiple shipping schedules for each line and define multiple distributions for each schedule.
Item Description Page	REQ_ITEM_DESCR, REQ_ITEM_DESCR4	Enter and view descriptions for a specific item.
<u>VAT Information for a Schedule Page</u>	REQ_SCHED_VAT	Enter VAT details for the requisition schedule. This page is available only when the Calculate VAT on Req check box is selected for the requisition business unit in the purchasing business unit definition component.
<u>Additional Details Page</u>	REQ_SCHED_DTL2	Enter time due, ultimate use, and sales and use tax destination information.
Maintain Requisitions - Direct Ship Page	REQ_SCHED_DROP	View details about the sales order from which a direct shipment requisition was created. The requisition must contain a direct shipment. This button is available only if the schedule is a direct shipment.
<u>Requisition Ship To Address Page</u>	REQ_ONETIME_ADDR	View address details for the location relevant to the page from which this page is accessed. You can also set up a one-time ship to address for the selected requisition. When you enter a one-time address and exit the page, the One-Time Address button changes to indicate that a one-time address exists for the schedule. This page is unavailable for direct shipment requisitions.
Pegging Workbench Page	IN_PEG_DETAIL_SP	View and maintain pegging information associated with the requisition schedule.

Page Name	Definition Name	Usage
Pegging Inquiry Page	IN_PEG_DETAIL_SP	View the demand for this requisition.
Qualified Distributions Page	REQ_DIST_PEG	Select the requisition distribution that you want to maintain or view the pegging information for.
Requisition Ship To Comments	REQ_COMMENTS	Add comments related to the ship to address.

Maintain Requisitions - Schedule Page

Use the Maintain Requisitions - Schedule page (REQ_SCHEDULE) to specify multiple shipping schedules for each line and define multiple distributions for each schedule.

Navigation:

Purchasing > Requisitions > Add/Update Requisitions > Maintain Requisitions - Requisition

Click the **Schedule** button on the Maintain Requisitions - Requisition page.

This example illustrates the fields and controls on the Maintain Requisitions - Schedule page. You can find definitions for the fields and controls later on this page.

Schedule

Business Unit: US001 Requisition Date: 12/29/2012
 Requisition ID: NEXT Status: Approved

[Return to Main Page](#)

Line	Item	Description	Quantity	AvgCost	Merchandise Amt
1			0.0000		

Schedule

Details Maintenance W/O

Sched	*Ship To	Ship To GLN	Quantity	Price	Merchandise Amount	Due Date	Attention To	Revisio
1	US001	22222222222222	<input type="text" value="0.0000"/>	<input type="text" value="0.00000"/>	0.00	<input type="text"/>	<input type="text" value="ST"/>	<input type="text"/>



[Add Ship To Comments](#)



Save Notify Refresh

Details

Use the Details tab to define schedule information. You can specify multiple shipping schedules for each line and multiple distributions for each schedule.

Field or Control	Description
Ship To	<p>Select the location to which the supplier will ship the order. You can update this value for each schedule that you define.</p> <hr/> <p>Note: If you change the ship to location to a PeopleSoft Inventory business unit that requires closure calendar validation and processing for receiving activities as defined on the Closure Calendar page, the system validates the due date as a valid date for receiving. If it encounters an exception date, it uses the next valid future date as the due date.</p>
	<p>Click the Ship To Address button to access the Requisition Ship To Address page. Use this page to view the ship to address or to define a one-time address for the requisition.</p> <hr/> <p>Note: This button is unavailable for direct shipment requisitions created from sales orders in PeopleSoft Order Management.</p>
Ship to GLN	<p>Displays the GLN values on the Schedule Page</p> <hr/> <p>Note: The ShipTo GLN value be displayed based on the Location defined in the setup.</p>
Quantity	<p>Supplied from the requisition line. If you update this quantity on either the line or schedule, the other quantity is also updated. The sum of the active schedules for a line must equal the line quantity. This linkage prevents you from scheduling a different quantity than you have requisitioned.</p>
Price	<p>Enter the unit price of the item.</p> <p>If you are using commitment control, the price field is unavailable for modification when a requisition schedule that is distributed by quantity has been partially or fully sourced to a purchase order. This field is also unavailable for modification when you create a change order for a requisition (that is distributed by quantity) that has been partially or fully sourced to a purchase order.</p>
Amount	<p>Displays the total price of the items on the requisition schedule. This is the unit price multiplied by the schedule quantity.</p>

Field or Control	Description
Due Date	<p>(Optional) Select the requisition schedule due date. The date that you enter becomes the default purchase order due date.</p> <p>If you don't specify a due date here, when you source the requisition to a purchase order, the system derives the due date by incrementing the purchase order date by the number of lead-time days defined for the item. If the item is not defined in the system, or if you are ordering by description-only, the due date becomes the purchase order due date by default.</p> <hr/> <p>Note: If the PeopleSoft Inventory business unit associated with the ship to location requires closure calendar validation and processing for receiving activities as defined on the Closure Calendar page, and the due date that you enter falls on a defined closure date, the system issues a warning. You can choose to keep the invalid date, or use the next valid date on the calendar.</p> <hr/>
Attention To	<p>Enter the person to whom or place where the services or goods are to be delivered. The system uses values for this field from PeopleSoft eProcurement requisitions. You can override the value or enter a value.</p>
Revision	<p>Enter the manufacturer's product revision number of the item ordered. If the ship to is a PeopleSoft Inventory business unit and the item is under revision control in that business unit, the revision number by default becomes the one that is effective on the due date.</p>
	<p>Click the Schedule Direct Shipment button to access the Maintain Requisitions - Direct Ship page. Use this page to view the sales order information for the direct shipment requisition.</p>
	<p>Click the Pegging Workbench button to access the Pegging Workbench page. Use this page to view and maintain the pegging information associated with this requisition.</p> <p>See Using Pegging with Requisitions in PeopleSoft Purchasing.</p>

Field or Control	Description
	<p>Click the Pegging Inquiry button to access the Pegging Inquiry page. Use this page to view the demand for this requisition.</p> <p>See Using Pegging with Requisitions in PeopleSoft Purchasing.</p>
<p>Status</p>	<p>Displays the status of the schedule.</p>
	<p>Click to create a change request or change order for the requisition. When a requisition is eligible for change order tracking, the system makes the Create Schedule Change button available for use. All eligible change request and change order fields are disabled prior to selecting this button. The Cancel buttons are also enabled. Inserting a new line or schedule or canceling an existing line or schedule creates a change order. You can't delete a line or schedule if it is eligible for change order processing.</p> <p>When you click the button, the system checks whether this is the first change for this requisition. If so, the system inserts change order fields with the batch number and sequence number of 0. This stores the original values of the schedule.</p> <p>Changing the quantity field on the schedule level causes both line and schedule quantity fields to be tracked if they are define as change request or change order fields.</p>

Schedule - Maintenance WO

Select the Maintenance WO (maintenance work order) tab.

Note: This tab does not appear on this page if PeopleSoft Maintenance Management is not installed.

If a requisition was created through the Purchasing Requisition Loader process coming from PeopleSoft Maintenance Management, then the fields on this page are populated with the work order information from PeopleSoft Maintenance Management. If work order information does not already exist, you can manually associate the work order information with the requisition using the fields on this page.

In PeopleSoft Purchasing you can associate a PeopleSoft Maintenance Management work order only with a requisition for noninventory and description-only items. When you make this association, the requisition schedule is pegged to a work order. You use the Pegging Workbench to associate work orders with inventory items on a requisition.

When you associate a work order with a requisition, the system copies the distributions from the work order parts template, including distribute by method, distribution percentage, general ledger business unit, ChartFields, and projects information.

In addition, if you change the work order information that is already associated with a requisition schedule, the system deletes the existing requisition distributions and copies the work order distributions from the work order itself. Also, the pegging information is updated to reflect the new work order information.

Field or Control	Description
WO Business Unit (PeopleSoft Maintenance Management work order business unit)	Select the PeopleSoft Maintenance Management business unit.
Work Order ID	Select the work order that you want to associate with this requisition.
Task Number	Select the work order task number.
Resource Type	Select the type of resource for which you are defining a requisition. Types are: <ul style="list-style-type: none"> • <i>Labor</i> • <i>Material</i> • <i>Tools</i>
Resource Line No. (Resource line number)	Select the resource line number associated with the work order. <hr/> <p>Note: You can link Amount Only requisitions with the corresponding source MM Work Order Task Schedule Purchase/On-hand resource lines. If the Amount Only check box is selected, the search results match to the Amount Only WO Task Purchase/On-hand resource lines. Quantity-based requisitions can only be linked to non-amount only WO Task lines.</p> <hr/>
Schedule Date	Displays the schedule date for the Maintenance Work Order This field is only displayed in update and display mode, and not visible in Add mode.
Amount	Displays the total amount for the Maintenance Work Order This field is only displayed in update and display mode, and not visible in Add mode.
Currency	Displays the currency for the Maintenance Work Order This field is only displayed in update and display mode, and not visible in Add mode.

Note: The Schedule Date, Amount, currency fields are from WO schedule not from the Requisition. If the Amount Only check box is selected for requisition line and requisition line is associated to Amount Only Work Order Schedule, only then the Schedule Date, Amount, Currency fields are displayed.

Note: If the user tries to associate Non Amount Only transaction (Requisition) to Amount Only (WO) transaction, the system displays an error message.

Changing Work Order Information

If the purchase order distributions are associated with a requisition, you must clear the requisition before you can change the work order information. Also, if the work order is associated with the purchase order schedule (noninventory and ad hoc (description-only) lines), then when you make a change to the purchase order and reopen the quantity back on the requisition, the system reopens the requisition pegs to the work order. Changes that can cause this behavior are reducing quantity, canceling a distribution, and deleting a distribution. If the purchase order is for an inventory item, reopening the requisition quantity does not reopen the pegs—you must manually redo the pegging.

Related Links

[Understanding Requisition Change Tracking](#)

[Understanding the UOM Conversion Hierarchy](#)

[Understanding Multicurrency Conversions](#)

[Understanding the Supplier Location Hierarchy and Multicurrency Pricing](#)

“Establishing Operation Closure Dates” (PeopleSoft Inventory)

“PeopleSoft Maintenance Management System Overview” (PeopleSoft Maintenance Management)

“Understanding Pegging” (PeopleSoft Supply Chain Management Common Information)

VAT Information for a Schedule Page

Use the VAT Information for a Schedule page (REQ_SCHED_VAT) to enter VAT details for the requisition schedule.

Navigation:

Click the **Schedule VAT** button on the Maintain Requisitions - Schedule page.

Expanding and Collapsing Sections

<i>Field or Control</i>	<i>Description</i>
Expand All Sections	Click to scroll to and access every section on the page. You can also expand one or more sections by clicking the arrow next to the section's name.
Collapse All Sections	Click to collapse all sections, displaying only the header information. If you expand one or more sections, you can click the arrow next to the section's name to collapse the section.

Physical Nature

<i>Field or Control</i>	<i>Description</i>
Physical Nature	Indicates whether the item is a good or a service. Many countries are required to report the sale and purchase of goods separately from services. The default comes from PeopleSoft Purchasing defaulting hierarchy from either the item, item category, supplier location, or purchasing options.
Change Physical Nature	Click to override the default physical nature for this item. The system resets all the VAT defaults.

VAT Locations

<i>Field or Control</i>	<i>Description</i>
Location Country	For services only, displays the Purchasing business unit bill to location country.
Location State	For services only, displays the Purchasing business unit bill to location state.
Supplier Location Country	For services only, displays the supplier's order from location country.
Supplier Location State	For services only, displays the supplier's order from location state.
Service Performed Country	<p>Depending on the services performed setting in the PeopleSoft Purchasing defaulting hierarchy (for example on the supplier or business unit), the system sets the value for this field in the following way:</p> <ul style="list-style-type: none"> • If the ship from location is specified, this field is set to the supplier's ship from location country • If the ship to location is specified, this field is set to the ship to location country. • If the buyer's location is specified, this field is set to the Purchasing business unit bill to location country. • If the supplier's location is specified, this field is set to the supplier's order from location country.

Field or Control	Description
Service Performed State	<p>Depending on the services performed setting in the PeopleSoft Purchasing defaulting hierarchy (for example on the supplier or business unit), the system sets the value for this field in the following way:</p> <ul style="list-style-type: none"> • If the ship from location is specified, this field is set to the supplier's ship from location state. • If the ship to location is specified, this field is set to the ship to location state. • If the buyer's location is specified, this field is set to the Purchasing business unit bill to location state. • If the supplier's location is specified, this field is set to the supplier's order from location state. <p>This value appears only if the value in the Service Performed Country field requires that VAT be tracked by state or province.</p>
Ship From Country	<p>Displays the supplier's ship from location country. In the case of transactions involving goods or freight service transactions, this is used to determine the VAT treatment.</p>
Ship From State	<p>Displays the supplier's ship from location state if the ship from country is defined as tracking VAT by state or province. In the case of transactions involving goods or freight service transactions, this is used to determine the VAT treatment.</p>
Ship To Country	<p>Displays the ship to location country. In the case of transactions involving goods or freight service transactions, this is used to determine the VAT treatment.</p>
Ship To State	<p>Displays the ship to location state if the ship to country is defined as tracking VAT by state or province. In the case of transactions involving goods or freight service transactions, this is used to determine the VAT treatment.</p>

VAT Defaults

Field or Control	Description
Service Type	Displays the VAT service type of <i>Freight</i> or <i>Other</i> if the transaction is for a service. The value in this field determines whether the special rules for freight transport within the European Union apply. The default value comes from five drivers in the VAT default hierarchy, purchase order options, supplier, supplier location, item category, and item.
Place of Supply Driver	Displays the usual place of supply (that is, the place where VAT is usually liable) for the service if the transaction is for a service. This value is used to help determine the place of supply country and the VAT treatment. Options are <i>Buyer's Countries</i> , <i>Supplier's Countries</i> , and <i>Where Physically Performed</i> . The default value comes from five drivers in the VAT default hierarchy, purchase order options, supplier, supplier location, item category, and item.
Reporting Country	Displays the country for which this VAT will be reported. This is the VAT entity VAT registration country and determines many of the VAT defaults.
Defaulting State	Displays the state within the reporting country that is used to retrieve values from the VAT Defaults table (if the reporting country requires that VAT be tracked by state or province).
Supplier Registration Country and Supplier Registration ID	Displays the registration country and ID of the supplier.
Exception Type	Displays the exception granted to the VAT entity: <i>None</i> , <i>Exonerated</i> , or <i>Suspended</i> . This value is specified on the VAT entity registration.
Certificate ID	If applicable, displays the ID of the VAT exception certificate that may have been issued to the VAT entity.

Field or Control	Description
Calculate at Gross or Net	<p>Indicates how VAT is calculated:</p> <p><i>Gross:</i> The system calculates VAT before it applies any early payment discounts.</p> <p><i>Net:</i> The system calculates VAT after it deducts early payment discounts. If two percentage discounts exist, the system uses the larger of the two when it calculates VAT. The system won't use discount amounts, only discount percentages.</p> <p>The default value comes from the VAT entity driver.</p>
Recalculate at Payment	<p>Select to enable the recalculation of VAT at payment time to allow for any early payment discounts if you are calculating VAT at gross. This causes the system to adjust the VAT amount at the time of payment if the discount has been taken. This check box is set on the VAT entity driver.</p>
Declaration Point	<p>For a good or a service, displays when you want VAT transaction information to be recognized for reporting purposes:</p> <p><i>Invoice:</i> VAT is recognized at time of invoice.</p> <p><i>Payment:</i> VAT is recognized at time of payment.</p> <p><i>Delivery:</i> VAT is recognized on delivery.</p> <p>This value can be set at four levels in the VAT hierarchy, VAT entity registration, purchase order options, supplier, and supplier location.</p>

Field or Control	Description
VAT Rounding Rule	<p>Displays the VAT rounding rule. The default value comes from the VAT country, VAT entity registration, supplier, or supplier location driver. Options are:</p> <p><i>Natural Round:</i> Amounts are rounded normally (up or down) to the precision specified for the currency code. For example, for a currency defined with two decimal places, 157.4659 would round up to 157.47, but 157.4649 would round down to 157.46.</p> <p><i>Round Down:</i> Amounts are rounded down. For example, for a currency defined with two decimal places, 157.4699 would round down to 157.46.</p> <p><i>Round Up:</i> Amounts are rounded up with a rounding precision to one additional decimal place. For example, for a currency defined with two decimal places, 157.4659 would round up to 157.47, but 157.4609 would round down to 157.46.</p>
Use Type	<p>Determines the split between recoverable (taxable) and nonrecoverable (nontaxable) VAT.</p> <p>For the Canadian public sector, the use type also determines the rebate of the nonrecoverable VAT. VAT rebates are calculated based on statutory rebate rates that are established for each public service body.</p> <p>The value comes from the VAT defaulting hierarchy, either from the item, item business unit, item category, supplier location, supplier, or purchasing options.</p>
Include Freight	<p>If this option is selected, the system includes any freight amounts in the VAT basis by calculating VAT on the merchandise amount plus any freight amount. This option is available only for exclusive VAT calculation. The value comes from the VAT entity registration driver.</p>
Include Miscellaneous	<p>If this option is selected, the system includes any miscellaneous charge amounts in the VAT basis by calculating VAT on the merchandise amount plus any miscellaneous charge amount. This option is available only for exclusive VAT calculation. The value comes from the VAT entity registration driver.</p>
Place of Supply Country	<p>For services, displays the country in which the VAT is liable. The default value comes from a complex algorithm.</p>

Field or Control	Description
Treatment	<p>Displays the VAT treatment, based on a complex algorithm:</p> <p><i>Domestic Goods Purchase:</i> If the ship from and ship to countries are the same and the supplier is registered for VAT, the transaction is treated as domestic.</p> <p><i>Domestic Services Purchase:</i> If the buyer and seller are both located in the country where the VAT is liable, the transaction is treated as domestic.</p> <p><i>EU Goods Purchase (European Union goods purchase):</i> If the ship from and ship to countries are different, the system determines whether both countries are located within the EU. If so, the system looks at the VAT registration for each trading partner to determine whether the transaction should be treated as an intra-EU purchase, domestic, or outside the scope of VAT.</p> <p><i>EU Services Purchase (European Union services purchase):</i> If each trading partner is located and registered in a different EU country, and the VAT on a service is liable in the buyer's country, the transaction is treated as a self-assessed EU services purchase.</p> <p><i>Self-Assess Goods Import:</i> If the ship from country is different from the ship to country and either or both of the countries are located outside of the EU, and the supplier is not registered in the ship to country, the transaction is treated as an import. If the entry in the VAT Country table for the VAT reporting country indicates that VAT on imports should be self-assessed, the transaction is treated as a self-assess goods import, and both input and output VAT are recorded.</p> <p><i>Self-Assess Services Import:</i> If each trading partner is located and registered in different countries, and the VAT on a service is liable in the buyer's country, the transaction is treated as a self-assessed services import.</p> <p><i>Zero-rated Goods Import:</i> If the ship from country is different from the ship to country and either or both of the countries are located outside of the EU, and the supplier is not registered in the ship to country, the transaction is treated as an import. If the entry in the VAT Country table for the VAT reporting country indicates that only input VAT should be recorded on imports, the transaction is treated as a zero-rated goods import.</p> <p><i>Outside of Scope:</i> If the supplier is not registered for VAT, or if the VAT is liable in a country other than the VAT reporting country, the transaction is treated as outside the scope of VAT.</p>

Field or Control	Description
	<p><i>No VAT Processing:</i> For transactions in which the physical nature is goods, if the ship to country has not been defined as a VAT country and the VAT reporting country on the transaction is missing, no VAT information is recorded.</p> <p>Within PeopleSoft detail, VAT treatment values on the transaction lines are used for applying the precise defaults applicable to the transaction lines. The treatment is determined based on the rules applicable to the transaction.</p>
Applicability	<p>Displays the VAT status, which comes from an algorithm. Options are:</p> <p><i>Taxable.</i></p> <p><i>Exempt</i> (not subject to VAT).</p> <p><i>Outside of Scope of VAT.</i></p> <p><i>Suspended.</i></p> <p><i>Exonerated.</i></p>
Record Output	<p>Select to enable entry of vouchers for which VAT is not included on the invoice but is payable to the VAT authority rather than the supplier. In this case, you are accounting for both input and output VAT for the purchase.</p> <p>This is the case for an intra-EU acquisition or when you must account for output VAT on a service supplied by a foreign supplier. This is also referred to as self-assessing for VAT. The value comes from an algorithm that uses the treatment and applicability to retrieve the applicable value from the PeopleSoft-delivered VAT system setup data.</p>
VAT Code (value-added tax code)	Displays the VAT code that defines the rate at which VAT is calculated for this line.
Transaction Type	Displays the code that categorizes and classifies this transaction for VAT reporting and accounting.

Adjust/Reset VAT Defaults

Any changes that you make to fields on this page may affect VAT defaults on this page. For accuracy and consistency, use the following fields to adjust affected VAT defaults or to reset all VAT defaults. Adjusting or resetting VAT defaults affects only fields within the **VAT Defaults** group box.

Field or Control	Description
Adjust Affected VAT Defaults	<p>Click to have the system adjust the VAT defaults that are affected by the changes. All changes that you have made to VAT defaults on this page that affect other VAT defaults on this page are retained.</p> <p>Click the i button to list the fields that will be adjusted.</p> <hr/> <p>Note: Oracle recommends that you always click the Adjust Affected VAT Defaults button after changing any defaults on the VAT page.</p>
Levels	<p>Enables you to specify the levels within the requisition transaction hierarchy to reset when you click the Reset All VAT Defaults button. Options are:</p> <p><i>All lower levels:</i> Resets all VAT defaults at lower levels for this page, namely the requisition distribution level.</p> <p><i>This and all lower levels:</i> Resets all VAT defaults on this page and at any lower levels of this page.</p> <p><i>This level only:</i> Resets all VAT defaults on this page.</p>
Reset All VAT Defaults	<p>Click to have the system reset the VAT defaults based on the value that you selected in the Levels field. Any changes that you have previously made to VAT defaults will be lost.</p> <hr/> <p>Note: Reset redetermines the VAT defaults. This does not necessarily mean that they will be reset to their original values. For example, the user may not have changed any VAT default values, but if a VAT driver field was changed, clicking this reset button will redetermine all defaults based on the new driver value.</p>

Additional Details Page

Use the Additional Details page (REQ_SCHED_DTL2) to enter time due, ultimate use, and sales and use tax destination information.

Navigation:

Click the **Additional Detail** icon on the Maintain Requisitions - Schedule page.

Details

<i>Field or Control</i>	<i>Description</i>
Tax Destination	Displays the location code on which the sales and use tax calculation for the schedule should be based. This is also known as the tax basis.
Ultimate Use Code	Displays the ultimate use code for the item. The ultimate use of an item can alter the SUT amount that a business unit pays. The SUT amount can be calculated based on the SUT authority and the ultimate use code established on the Ultimate Use Code page.
Ship Via	Select the Ship Via Code.
Freight Terms	Select the Freight Terms Code. <hr/> Note: The Ship Via and Freight Terms values are copied directly from the requisition if the Override Suggested Supplier check box is not selected on the Requisition page. <hr/>

Related Links

“Ultimate Use Codes Page” (Application Fundamentals)

Requisition Ship To Address Page

Use the Requisition ShipTo Address page (REQ_ONETIME_ADDR) to view address details for the location relevant to the page from which this page is accessed.

You can also set up a one-time ship to address for the selected requisition.

Navigation:

Click the **Ship To Address** button on the Maintain Requisitions - Schedule page.

The fields on this page are identical to those on the Supplier Information - Address page. However, no effective date or status fields are on this page because the address information on this page is used only for a one-time shipping address and is not retained by the system.

Note: This page is unavailable for direct shipment requisitions that originated from PeopleSoft Order Management. To change the address on a direct ship requisition, you must change the address associated with the sales order in PeopleSoft Order Management.

Related Links

“Entering Supplier Addresses” (PeopleSoft Source to Settle Common Information)

Using Pegging with Requisitions in PeopleSoft Purchasing

This section provides an overview of using pegging with requisitions in PeopleSoft Purchasing.

Pages Used to Peg Requisitions

Page Name	Definition Name	Usage
<u>Pegging Workbench Page</u>	IN_PEG_DETAIL_SP	Apply, change, or remove pegs from items.
<u>Pegging Inquiry Page</u>	IN_PEG_DETAIL_SP	View pegging information for line items.

Understanding Using Pegging With Requisitions in PeopleSoft Purchasing

You can use the pegging process with requisitions and purchase orders. By using the pegging feature, you can prevent the incoming supply from being promised, reserved, or allocated to another order by tagging it to be used specifically for certain requisitions and subsequent purchase orders. You can use requisitions and purchase orders as supply to satisfy sales orders or material stock requests (MSR) from inventory. However, you can break (remove) pegs by using the Pegging Workbench.

If a requisition is pegged to satisfy specific demand such as a sales order or MSR, this information is copied over to the purchase order.

Two types of pegs are available:

- A *soft peg* links an outgoing order to the quantity included in an incoming supply. For example, a sales order for 10 units is soft-pegged to an incoming purchase order with 2,000 units. When a soft peg is changed or canceled, the peg is changed but the incoming supply (in this case the purchase order) is not changed. A notification is sent to the buyer informing them that a change in the demand pegged to the PO has taken place. Soft pegs are useful when items are in short supply and you want to peg higher-priority customer orders to specific supply.
- A *hard peg* is created when a sales order (demand) creates a purchase order, requisition, or interunit transfer (supply) to fulfill it. Hard pegs are created from the sales order only when you are adding a direct ship or direct receipt. All other orders are considered soft pegs and result in notifications only upon changes. When a hard peg is changed or canceled, not only is the peg changed, but also the incoming supply is changed. For example, a sales order for 10 units is hard-pegged to an incoming purchase order with 10 units. If the sales order is changed to 4 units, then the purchase order is changed to 4 units. Hard pegs are useful for make-to-order items or special products.

Hard Pegs Versus Soft Pegs

The following are examples of hard pegs:

- A new direct ship purchase order (formerly drop ship purchase order)
- A new direct receipt purchase order or a direct receipt interunit transfer that is created from a sales order

- A new direct ship requisition (formerly drop ship requisition)
- A new direct receipt requisition that is created from a sales order

Note: All other orders are considered soft pegs.

Related Links

“Understanding Pegging” (PeopleSoft Supply Chain Management Common Information)

“Pegging in PeopleSoft Purchasing” (PeopleSoft Supply Chain Management Common Information)

Prerequisites

You can set up pegging at the business unit, item, or user level. To use this feature, you must set up these pages:

1. Pegging Setup (**Inventory > Order Pegging > Business Unit Setup**): To define pegging attributes for the PeopleSoft Inventory business unit.
2. Pegging Item Setup (**Inventory > Order Pegging > Item Setup**): To define pegging attributes for the item and business unit combination.
3. User Security (**Inventory > Order Pegging > Pegging User Security**): Select the type of supply and demand with which users can control.

See “Setting Up Pegging” (PeopleSoft Supply Chain Management Common Information) “Understanding Pegging” (PeopleSoft Supply Chain Management Common Information).

Pegging Workbench Page

Use the Pegging Workbench page (IN_PEG_DETAIL_SP) to apply, change, or remove pegs from items.

Navigation:

Purchasing > Requisitions > Add/Update Requisitions

Click the **Schedules** button for a particular line item on the requisition.

Select the **Statuses** tab.

Click the **Pegging Workbench** button.

This example illustrates the fields and controls on the Pegging Workbench page. You can find definitions for the fields and controls later on this page.

Pegging Workbench

Order Type Purchase		Inventory Unit US010
Unit US001	Order No 0000000266	
Order Line 1	Schedule 1	Distribution Line 1
Item ID 10002		
Schedule Date 01/16/2013		QTY Order 1.0000 EA
From Date <input type="text" value="01/11/2013"/>		Total QTY Putaway
To Date <input type="text" value="01/21/2013"/>		Pegged Quantity 1.0000
		Peg Remaining 0.0000

Hide Other Fully Pegged Orders

Details Personalize | Find | View All | First 1 of 1 Last

Order Type	Order Information	Line	Schedule Date	Hard Peg	QTY Available Remaining	QTY Pegged	Open QTY Pegged
Sales Order	US001/CEN1131	OM/1/1/2	01/16/2013	<input checked="" type="checkbox"/>	0.0000	1.0000	<input type="text" value="1.0000"/>

Note: Items must indicate that they are to be received into an Inventory business unit to access the Pegging Workbench.

Use the Pegging Workbench to apply, change, or remove pegs. The workbench enables you to link a specific quantity from a demand to incoming supply. For example, 10 units of a soft-reserved item on a sales order's demand line can be pegged to 10 units on a requisition line. One demand line can be pegged to one or more supply-side lines. For example, 10 units of a soft-reserved item on an order's demand line can be pegged to 4 units on one purchase order and 6 units on another purchase order. In addition, you can peg the supply side to the demand side, for example, starting with a purchase order line with 10 units and pegging to a sales order that needs 10 units.

Field or Control	Description
From Date and To Date	Enter beginning and end dates for pegged information.
Hide Other Fully Pegged Orders	Select this check box if you want to filter out other orders than are completely pegged to other orders.

Details

Field or Control	Description
Order Information	Displays the source business unit and order number. Select the line to access an inquiry page with additional information about this order.

Field or Control	Description
Line	Displays the order line, schedule line, distribution (or demand) line.
Schedule Date	Displays the date of the schedule.
Hard Peg	Indicates whether the row has hard-pegged demand or supply. Hard pegs indicate that the existing peg has a one-to-one relationship between a demand line and a supply-side line. If you attempt to peg additional demand or supply quantities to this row, the system displays a warning that will change the peg to a soft peg. If you continue with the change, then the peg chain is changed to a soft peg.
QTY Available Remaining (quantity available remaining)	Displays the item quantity that is available to be pegged.
QTY Pegged (quantity pegged)	Displays the quantity of this line that has already been pegged to another order.
Open Qty Pegged (open quantity pegged)	To create a peg, enter a quantity in this field to be pegged against the line displayed at the top of this page and then click the Save button. This creates the peg chains for the demand and supply. To break (remove) a peg, enter zero in this field and then click the Save button.
Pegged QTY Received (pegged quantity received)	Displays the pegged quantity that has already been received into a PeopleSoft Purchasing business unit.

Quantity

View the quantity that has been sourced for the specific order.

Pegging Inquiry Page

Use the Pegging Inquiry page (IN_PEG_DETAIL_SP) to view pegging information for line items.

Navigation:

Click the **Pegging Inquiry** button on the Maintain Requisitions - Schedule page.

This example illustrates the fields and controls on the Pegging Inquiry page. You can find definitions for the fields and controls later on this page.

Pegging Inquiry

Order Type Purchase		Inventory Unit US010
Unit US001	Order No 0000000266	
Order Line 1	Schedule 1	Distribution Line 1
Item ID 10002		
Schedule Date 01/16/2013		QTY Order 1.0000 EA
		Total QTY Putaway
		Pegged Quantity 1.0000
		Peg Remaining 0.0000

Details Personalize | Find | View All | | First 1 of 1 Last

Order Type	Order Information	Line	Schedule Date	Peg Status	Hard Peg	QTY Available Remaining	QTY Pegged	Open QTY Pegged
Sales Order	US001/CEN1131	OM/1/1/2	01/16/2013	Open	<input checked="" type="checkbox"/>	0.0000	1.0000	1.0000

Return

Important! You must save any changes before you can access the Pegging Inquiry page.

Use this page to view information such as order type, order information, and quantity pegged that is associated with any pegged orders.

Related Links

“Understanding Pegging” (PeopleSoft Supply Chain Management Common Information)

Entering Distribution Information

This section discusses how to Enter Distribution Information

Pages Used to Enter Distribution Information

Page Name	Definition Name	Usage
<u>Maintain Requisitions - Distribution Page</u>	REQ_DISTRIB_DETAIL	Specify multiple shipping schedules for each line and define multiple distributions for each schedule.
Currency Information Page	EXCH_RT_DTL2_INQ	Display the rules used to calculate exchange rates for the transaction.
<u>VAT Details for Distribution Page</u>	REQ_DISTRIB_VAT	View and modify VAT control options, VAT details, and VAT calculations.
Multiple SpeedCharts Page	RUN_REQSPCHARTS_OL	Define multiple speed charts and the requisition quantity to distribute for each speed chart.

Page Name	Definition Name	Usage
Multiple Accounting Tag Page	ACCTG_TAG_SEL_SEC	Define multiple accounting tag and the requisition quantity to distribute for each accounting tag.

Maintain Requisitions - Distribution Page

Use the Maintain Requisitions - Distribution page (REQ_DISTRIIB_DETAIL) to specify multiple shipping schedules for each line and define multiple distributions for each schedule.

Navigation:

Purchasing > Requisitions > Add/Update Requisitions > Maintain Requisitions - Requisition

Click the **Schedule** button on the Maintain Requisitions - Requisition page.

Click the **Distribution** button on the Maintain Requisitions - Schedule page.

This example illustrates the fields and controls on the Maintain Requisitions - Distribution page. You can find definitions for the fields and controls later on this page.

The settings of the **Override** and **Default** options on the Header Defaults page affect defaulting behavior on this page when you split distribution lines.

For example, if you selected the **Override** option and you split 50 percent of distribution line 1 to distribution line 2, the system checks the requisition line defaults for a matching distribution line number (in this case, it is 2). If no match exists, the system checks the requisition header defaults. If no match exists, it applies the value from distribution line 1. If no value exists on distribution line 1, the system looks to the next levels in the default hierarchy.

If you have the **Default** option selected and perform the same split, the system checks the default hierarchy first. If no values exist, the system checks the requisition line and header default values as described previously.

Add distribution lines to the schedule to divide the delivery of goods among business units in the organization and to further define the accounting distributions. Sequential numbers are assigned to each distribution that you define for a schedule.

Distributions are transferred to purchase orders, but are not sent to the supplier.

Field or Control	Description
Distribute by	<p>Select the method to use to allocate the expense account distribution. Selecting either option enables you to distribute by percentage. If you change the amount or quantity, the percent is adjusted. If you change the percent, the amount or quantity is adjusted. In either case, the total must equal 100 percent.</p> <p><i>Amount:</i> Select to enter a value in the Amount field. The sum of all distribution amounts must equal the schedule amount (the value in the Amount field on the Maintain Requisitions - Schedule page). It is not recommended that requisition distribution lines for inventory items have a Distribute By value of <i>Amount</i> as it can cause rounding problems if sourced to PeopleSoft Inventory.</p> <p><i>Quantity:</i> Select to enter a value in the Req Qty field. The sum of all distribution quantities must equal the schedule quantity (the value in the Req Qty field on the Maintain Requisitions - Schedule page). This options is recommended for inventory items that are sourced from PeopleSoft Inventory.</p>
Liquidate by	<p>Liquidate the outstanding pre-encumbrance and encumbrance balances by amount or quantity.</p> <hr/> <p>Note: This field is visible only if commitment control is enabled and you select the Allow Liquidate by Quantity when Distribute by Quantity check box is selected on the Purchasing Definition - Business Unit Options page. If commitment controlled is not installed, or you do not select the option to liquidate by quantity on the Purchasing Definition - Business Unit page, the budget processor balance liquidates by amount only.</p> <hr/>
SpeedChart	<p>Select a SpeedChart code. A SpeedChart retrieves preset ChartField definitions and applies them to the schedule distribution.</p> <hr/> <p>Note: Accounting Tags appear in lieu of Speedcharts when the Accounting Tag check box is selected for Purchasing on the Accounting Tag Registration page. See “Setting Up Accounting Tags” (Application Fundamentals)</p> <hr/>
Multi-SpeedCharts	<p>Click to access the Multiple Speed Charts page. Use this page to define multiple speed charts and the requisition quantity to distribute by speed chart.</p> <hr/> <p>Note: Accounting Tags appear in lieu of Speedcharts when the Accounting Tag check box is selected for Purchasing on the Accounting Tag Registration page. See “Setting Up Accounting Tags” (Application Fundamentals)</p> <hr/>

Field or Control	Description
Accounting Tag	<p>Enter an Accounting Tag that will be used to populate ChartFields on transaction distribution lines. The system automatically prorates the distribution amounts according to the proration percentages defined on the Accounting Tag.</p> <hr/> <p>Note: Accounting Tags appear in lieu of Speedcharts when the Accounting Tag check box is selected for Purchasing on the Accounting Tag Registration page. See “Setting Up Accounting Tags” (Application Fundamentals)</p>
Multi-Accounting Tag	<p>Click to access the Multi Accounting Tag page where you can append and override accounting tags for the purchase order schedule.</p> <hr/> <p>Note: Accounting Tags appear in lieu of Speedcharts when the Accounting Tag check box is selected for Purchasing on the Accounting Tag Registration page. See “Setting Up Accounting Tags” (Application Fundamentals)</p>
Open Quantity and Open Amount	<p>Displays the quantity on the schedule not yet sourced to a purchase order if you are distributing by quantity. If you are distributing by amount, this field displays the amount on the schedule not yet sourced to a purchase order.</p>

The following fields apply to the entire distribution.

Field or Control	Description
Quantity	<p>Displays the quantity of items on the schedule, along with the applicable unit of measure.</p>
Merchandise Amt (merchandise amount)	<p>Displays the total price of the items on the schedule, along with the transaction currency.</p>
Pre-Encumbrance Balance	<p>Click to access information about the pre-encumbrance balance. The link is available when the budget status is valid and the balance is not zero. If the balance is zero and budget status is not check enabled, the link is not available.</p>

ChartFields

Select the ChartFields tab.

Field or Control	Description
Status	<p>Displays the distribution line status:</p> <p><i>Complete:</i> The distribution line has met requisition reconciliation criteria and has been closed.</p> <p><i>Open:</i> The distribution line is open and is available for sourcing. This value is open by default when the Requisition Status option is set to open on the Requester Setup page.</p> <p><i>Canceled:</i> The distribution line has been canceled and is not available for sourcing.</p> <p><i>Processed:</i> The distribution line is available for sourcing and is either in process or complete. This status implies that the line has already been processed.</p>
Percent	<p>Enter the percentage of either the quantity or the amount that you want distributed on the distribution line. The value in the Amount or Req Qty field, depending on the distribution method, is calculated based on the value that you enter.</p>
Quantity	<p>Enter the quantity of items that you want distributed on the distribution line. The value in the Percent field is calculated based on this value.</p> <p>This field is available for entry when you distribute by quantity.</p> <hr/> <p>Note: You cannot enter a distribution quantity greater than the associated schedule quantity. To increase the quantity on a distribution line, return to the Maintain Requisitions - Schedule page and increase the schedule quantity, or reduce the quantity on other distributions for that schedule. The quantity on the distributions must equal the ordered quantity of the associated schedule.</p> <hr/>
Merchandise Amt (merchandise amount)	<p>Enter the total amount that you want distributed on the distribution line. The value in the Percent field is calculated based on this value.</p> <p>This field is available for entry when you distribute by amount.</p>

Field or Control	Description
Account and Alt Account (alternate account)	<p>Select the account and alternate account for this distribution line.</p> <p>If you associate a purchasing kit definition with a requisition, the account and alternate account fields appear by default from the purchasing kit definition. If the fields are not defined on the purchasing kit definition, the system looks at the header defaults. If the fields are not there, the system continues to look at the other levels of the default ChartField hierarchy.</p> <p>See Purchasing ChartField Default Hierarchy.</p> <p>See Creating Purchasing Kits.</p>
Pre-Encumbrance Amount	<p>Displays the monies that you have committed in pre-encumbrances. The system extracts these values from commitment control tables by passing the business unit, document ID, and other key information that depends on the display.</p> <p>Pre-encumbrance balances appear on the currency code for the balances in the transaction currency of the requisition and are based on the transaction date rate.</p> <p>You can view budget details for the requisition, such as the purchase orders and voucher that have been created from the requisition. Click the Pre-Encumbrance link to access the PO Accounting Entries Inquiry, where you can select a General Ledger business unit and commitment control ledger group to use as a budget inquiry.</p> <p>See “Viewing Budget Details and Transaction Activity” (PeopleSoft Commitment Control).</p>

Details

Select the Details tab.

Field or Control	Description
IN Unit (PeopleSoft Inventory business unit)	<p>Select the default PeopleSoft Inventory business unit for which you are purchasing the items.</p> <p>If the item on the requisition line is an inventory item and the Defaults Inventory BU check box is selected on the Requester Setup page, the PeopleSoft Inventory business unit defined at the ship to level is supplied to the distribution. If the item is an inventory item and the check box is deselected, the system does not provide a default value. If the item on the requisition line is not an inventory item, this field is unavailable for entry. You can enter a PeopleSoft Inventory business unit for items that are identified as stockless.</p> <p>The presence of an Inventory business unit value in this field causes the items to be received and put away to the selected Inventory business unit. If you do not want the items to be received into inventory, be sure to clear this value.</p>
Statistics Code	<p>Select a code that identifies a value that you use to identify non-monetary amounts. Examples might be work days or floor space.</p>
Open Qty (open quantity)	<p>Enter the quantity on the distribution not yet sourced to a purchase order. This field is available for entry when you distribute by quantity.</p>
Open Amt (open amount)	<p>Enter the amount on the distribution not yet sourced to a purchase order. This field is available for entry when you distribute by amount.</p>
GL Base Amount (general ledger base amount)	<p>Displays the total amount of the distribution, expressed in the base currency of the PeopleSoft General Ledger business unit associated with the distribution line.</p>
Distribution VAT (distribution value-added tax)	<p>Click to view VAT information for the current line, schedule, and distribution.</p>
	<p>Click the Exchange Rate Detail button to access the Currency Information page. Use this page to view the rules used to calculate exchange rates for the transaction.</p>

Field or Control	Description
	<p>Click the Cancel button to cancel a selected distribution line. After a distribution line is canceled and the requisition is saved, the distribution line cannot be changed and is unavailable for entry.</p> <p>Cancellation reduces the schedule line open quantity and amount by the open quantity and amount on the distribution line. It also changes the distribution line open quantity and amount to zero. The total order quantity at the requisition line and schedule are not reduced.</p> <p>The canceled distribution line information is stored for future reference.</p> <hr/> <p>Important! You can't source a quantity on a distribution line that has been canceled.</p> <hr/>

Asset Information

Select the Asset Information tab.

Field or Control	Description
<p>AM Unit (PeopleSoft Asset Management business unit)</p>	<p>Select a PeopleSoft Asset Management business unit to associate with the asset item. If this field is populated by the system, the value appears by default from the PeopleSoft Purchasing business unit or the Requisition Defaults page.</p> <hr/> <p>Note: If you consider an item to be an asset and plan to pass it to PeopleSoft Asset Management through the PeopleSoft Receiving business process, you must populate the AM Unit (PeopleSoft Asset Management business unit) field and Profile ID field.</p> <p>If both fields contain values, data is written to the PeopleSoft Asset Management staging tables. If only one of the fields is populated, the system does not consider the item an asset.</p> <p>All of the information that you enter on this page is passed to PeopleSoft Asset Management.</p> <hr/>
<p>Profile ID</p>	<p>Select an asset profile ID.</p>
<p>CAP# (capital acquisition plan number)</p>	<p>Select a CAP number defined for this item in PeopleSoft Asset Management. This is required only if the item is capitalized.</p>

Field or Control	Description
Sequence	Select a sequence number for the capital acquisition plan.
Tag Number	<p>Enter an asset tag number. The quantity on the distribution must be 1 to enter a tag number. This information becomes available on the Asset Information page when the asset data has passed on to PeopleSoft Asset Management.</p> <p>In addition, the system checks the tag number that you enter on the requisition to make sure it is not already assigned to an asset when the Allow Dup Tags option is not set for the PeopleSoft Asset Management business unit. If the tag number has already been assigned to another asset, the system issues a warning. The system looks only at the Assets table; it does not look at the interface tables, previously entered receipts, purchase orders, or requisitions to determine whether the tag number has been assigned to another pending transaction.</p>
EmplID (employee ID)	Select an employee ID of the custodian for this item. This information corresponds to the employee ID number on the Asset Custodian/License/Manufacturer page.
Capitalize	Designates a capitalized item. A PeopleSoft Asset Management business unit must be selected for this check box to be enabled. If the item is capitalized, it can be depreciated before being paid.
Cost Type	<p>Select the cost type associated with the item purchase, if applicable. Cost types represent components of the cost of an asset, such as materials, labor, and overhead. For example, you can differentiate between the cost of building an asset and its market value by allocating production cost to one cost type and the profit margin to another. Cost type, in combination with asset category and transaction code, determines which accounts the costs are entered into in the general ledger.</p> <p>See “Understanding the Manufacturing Standard Cost Foundation” (PeopleSoft Cost Management).</p>

Budget Information

Select the Budget Information tab.

Field or Control	Description
Distrib (distribution line)	Displays the distribution line number.
Budget Status	When commitment control is on, the system displays the budget status for this distribution line. Statuses include <i>Valid</i> and <i>Not Chk'd</i> .
Budget Date	If commitment control is enabled, enter a budget date. Commitment control uses this date to determine the budget period to which this item cost belongs.
Merchandise Amount	Displays the merchandise amount for this distribution line.
Pre-Encumbrance Balance	When commitment control is activated, the system displays the pre-encumbrance balance. When you create a purchase order, commitment control liquidates the pre-encumbrance balance from the requisition and establishes an encumbrance for the purchase order. You must reestablish pre-encumbrance documents manually. See Maintain Requisitions - Requisition Page .
Currency Code	Appears for the pre-encumbrance amounts at the distribution level of the requisition. This is the currency of the default commitment control ledger group for the distribution-level General Ledger business unit.
Pre-Encumbered Base Balance	Displays the beginning pre-encumbered amount.
Base Currency	Displays the base currency for the distribution.
Commitment Control Close Flag	Appears as selected when the purchase order associated with the requisition has been fully liquidated, thus indicating that the outstanding pre-encumbrance has also been fully liquidated. This option can also appear as selected when the distribution has been canceled.

Related Links

[Creating Requisition Header Information](#)

[Creating Requisition Lines](#)

[Creating Requisition Schedules](#)

[Understanding the PeopleSoft Purchasing Default Hierarchy](#)

[Understanding Commitment Control in PeopleSoft Purchasing](#)

Understanding the Receiving Business Process

VAT Details for Distribution Page

Use the VAT Details for Distribution page (REQ_DISTRIB_VAT) to view and modify VAT control options, VAT details, and VAT calculations.

Navigation:

Click the **Distribution VAT** button on the Maintain Requisitions - Distribution page.

Field or Control	Description
Use Type	<p>Displays the use type entered on the schedule line, which determines the split between recoverable (taxable) and nonrecoverable (nontaxable) VAT.</p> <p>For the Canadian public sector, the use type also determines the rebate of the nonrecoverable VAT. VAT rebates are calculated based on statutory rebate rates that are established for each public service body.</p> <p>The value comes from the VAT defaulting hierarchy, either from the item, item business unit, item category, supplier location, supplier, or purchasing options.</p>
VAT Apportionment Control (value-added apportionment control)	<p>Select the appropriate apportionment control to apply, as applicable. The default value comes from the Purchasing business unit definition driver.</p> <p><i>Distribution GL Business Unit</i> (distribution General Ledger business unit): The system uses the PeopleSoft General Ledger business unit on the distribution line to search for the taxable and exempt percentages.</p> <p><i>Transaction Business Unit</i>: The system uses the applicable transaction business unit to search for the taxable and exempt percentages</p> <p><i>Transaction GL Business Unit</i> (transaction General Ledger business unit): The system uses the PeopleSoft General Ledger business unit to which the applicable transaction business unit is mapped to search for the taxable and exempt percentages.</p>
Recovery Source	See “Understanding VAT Processing in PeopleSoft Payables” (PeopleSoft Payables).
Rebate Source	See “Understanding VAT Processing in PeopleSoft Payables” (PeopleSoft Payables).
Transaction Type	Displays the code that categorizes and classifies this transaction for VAT reporting and accounting. This value comes from the requisition schedule but can be overridden at the requisition distribution.

VAT Calculations

Use this group box to review the VAT calculations for the line.

Field or Control	Description
Transaction Amount	Displays the amount of the transaction in the transaction currency.
Transaction Amount Base	Displays the amount of the transaction in the base currency.
Basis Amount	Displays the amount on which the VAT is calculated in the transaction currency. If VAT is being calculated at net, this amount is net of any discounts.
Basis Amount Base	Displays the amount on which the VAT is calculated in the base currency. If VAT is being calculated at net, this amount is net of any discounts.
Tax Rate	Displays the applicable VAT percentage.
Recorded Amount	Displays the calculated VAT amount that is recorded for this transaction in the transaction currency.
Recorded Amount Base	Displays the calculated VAT amount that is recorded for this transaction in the base currency.
Recovery Amount	Displays the amount of VAT that is recoverable in transaction currency.
Recovery Amount Base	Displays the amount of VAT that is recoverable in base currency.
Rebate Amount	Displays the amount of VAT that is available as a rebate in transaction currency.
Rebate Amount Base	Displays the amount of VAT that is available as a rebate in base currency.
Recalculate	Click to recalculate the VAT for the line.

Related Links

[“PeopleSoft Global Options and Reports Overview” \(PeopleSoft Global Options and Reports\)](#)

Copying an Existing Requisition to a New Requisition

This section discusses how to copy existing requisitions.

Pages Used to Copy an Existing Requisition to a New Requisition

<i>Page Name</i>	<i>Definition Name</i>	<i>Usage</i>
<u>Maintain Requisitions - Requisition Page</u>	REQ_FORM	Create requisitions online.
<u>Copy Requisition Page</u>	REQ_COPY_PROMPT	Select an existing requisition to copy to the current requisition. This option is available only in Add mode.

Copy Requisition Page

Use the Copy Requisition page (REQ_COPY_PROMPT) to select an existing requisition to copy to the current requisition.

This option is available only in Add mode.

Navigation:

Click the **Copy From** link on the Maintain Requisitions - Requisition page.

This feature eliminates redundant data entry by using an existing requisition as a template. You can select and copy any requisition, regardless of its status. If information already exists on the requisition line to which you are copying, you are prompted to confirm that you want to clear existing data and proceed with copying the requisition to the selected line. You can locate requisitions to copy using search criteria. For example, you can search for a requisition based on a requisition ID or status, requester or requisition name, or item description.

When you copy a requisition that has procurement card information defined, the system does not copy the procurement card information to the new requisition. The system redetermines the procurement card information for the new requisition by looking at the card information that is defined for the requester.

When you copy a requisition that has procurement group related information defined, the system does not copy these values to the new requisition. The requisition will have to be manually linked to the procurement group id.

When you copy a requisition that is associated with a PeopleSoft Maintenance Management work order, the system does not copy over the work order information to the new requisition.

You can copy a canceled requisition or a requisition that has canceled lines to a new requisition. If you copy a canceled requisition, all the lines from the canceled requisition are copied over to the new requisition and the status of the lines is made active. If you copy a requisition that has one or more lines canceled, only the active lines from the existing requisition are copied to the new requisition.

The status of the newly created requisition is *Open*, *Pending*, or *Approved*, depending on requester setup.

You can override any values that were copied over with the requisition. Activity and original requisition dates are not copied over.

Note: After copying a requisition, you must save the cart upon checkout if you wish to retain it. The items added through the Copy Requisition feature are not persistent until saved.

Printing Requisition Templates

This section provides an overview of the Requisition Template SQR Report (PORQ011) and lists the page used to generate the report.

Page Used to Print Requisition Templates

<i>Page Name</i>	<i>Definition Name</i>	<i>Usage</i>
Requisition Template Page	RUN_PORQ011	Produce the Requisition Template report.

Understanding the Requisition Template SQR Report (PORQ011)

The Requisition Template report provides a printed requisition form that requesters can use to order commonly requisitioned items. The report provides order information from an existing requisition, including requested items and supplier and manufacturer information. The quantity field on the report is blank and can be completed by the requester. The Requisition Template can help streamline the requisition process and improve the accuracy of data entry.

Previewing and Printing Requisitions

This section discusses how to Preview and Print Requisitions

Pages Used to Preview and Print Requisitions

<i>Page Name</i>	<i>Definition Name</i>	<i>Usage</i>
<u>Maintain Requisitions - Requisition Page</u>	REQ_FORM	Preview requisitions online.
<u>Requisition Print Page</u>	RUN_POY100	Produce the Requisition Print SQR Report (PORQ010). You can print one or multiple requisitions. The report includes contract information when a contract was used by the requisition for pricing.

Maintain Requisitions - Requisition Page

Use the Maintain Requisitions - Requisition page (REQ_FORM) to preview requisitions online.

Navigation:

Purchasing > Requisitions > Add/Update Requisitions > Maintain Requisitions - Requisition

<i>Field or Control</i>	<i>Description</i>
View Printable Version	Click to preview the requisition printout on the screen. This option does not print the requisition. Be aware that the requisition is saved prior to display.

Requisition Print Page

Use the Requisition Print page (RUN_POY100) to produce the Requisition Print SQR Report (PORQ010).

You can print one or multiple requisitions. The report includes contract information when a contract was used by the requisition for pricing.

Navigation:

Purchasing > Requisitions > Reports > Print Requisition > Requisition Print

<i>Field or Control</i>	<i>Description</i>
Business Unit	Select a business unit. If you leave this field blank, requisitions from all business units are printed.
Requisition ID	Select a single requisition number. If you leave this field blank, all requisitions from the selected business unit with statuses that match the values that you specified in the Statuses to Include group box are printed.
From Date and Through Date	Select the date range for the requisitions you want to print. If you select a single requisition in the Requisition ID field, this information is ignored.

Statuses to Include

Select one or more of the status check boxes. Requisitions with the selected status are included in the report. You must select at least one status.

Note: If you select the approved status, both approved and some of the requisition lines approved statuses for the requisitions appear on the report.

Select a requisition hold status from the options provided below the status check boxes. Requisitions with the selected hold status are included in the report. If you select *On Hold AND Not On Hold*, the system does not look at the requisition hold status when selecting the requisitions to print.

Updating Supplier History Dates and Amounts for Cumulative Sourcing

This section provides an overview of the Cumulative Sourcing Update Application Engine process and discusses how to run the Cumulative Sourcing Update process.

Page Used to Update Supplier History Dates and Amounts for Cumulative Sourcing

<i>Page Name</i>	<i>Definition Name</i>	<i>Usage</i>
Cumulative Sourcing	RUN_PO_POHISTUD	Enter the selection criteria for the Cumulative Sourcing Update process and to run the process.

Understanding the Cumulative Sourcing Update Application Engine Process

The Cumulative Sourcing Update process (PO_POHISTUD) has two functions: it updates supplier history dates and recalculates amounts for cumulative split sourcing.

When you run the Cumulative Sourcing Update process (PO_POHISTUD), the process verifies whether the current date is equal to or greater than the supplier history end date for the Item Categories - Category Definition 3 page. If the current date is greater than the supplier history end date then the supplier history start and end dates are recalculated for the new period. The history end date becomes the history start date, and the new history end date is calculated by adding the number of history months to the new history start date. The month to start field is also updated to the history start date month.

The second function of the Cumulative Sourcing Update process (PO_POHISTUD) is to recalculate amounts. This function is useful if you feel the amounts are not reliable and want to recalculate them. The Cumulative Sourcing Update process can be run for one or all suppliers, and one or all categories. You can choose to force a recalculation of amounts, however, amounts are recalculated when you or the Cumulative Sourcing Update process change supplier history start and end dates.

The process calculates the total dispatched order amount for orders dated after the history start date (HIST_START_DT) for the selected suppliers and categories and stores the result on ITM_CAT_TBL.MERCH_AMT_CAT_TOT. All items within the category are included in the calculation, even if they have a different sourcing method. Only category suppliers are included in the calculation total.

This process should be scheduled at the start of the month to look for expired history periods; however, it is automatically triggered by these events:

- You change a sourcing method to cumulative for a category.

- You add a category supplier.
- You delete a category supplier.
- You change the supplier history start month.
- You change the supplier history number of months.

Cumulative Sourcing Page

Use the Cumulative Sourcing page (RUN_PO_POHISTUD) to enter the selection criteria for the Cumulative Sourcing Update process and to run the process.

Navigation:

Purchasing > Purchase Orders > Stage/Source Requests > PO Cumulative Sourcing Update

Process Request Parameters

<i>Field or Control</i>	<i>Description</i>
All Categories	Select to run the Cumulative Sourcing Update process for all categories that are set to use the cumulative split sourcing method. When selected, the SetID and Category fields are unavailable for entry.
SetID	Select the SetID of the category on which you want to run the Cumulative Sourcing Update process.
Category	Select the category on which you want to run the Cumulative Sourcing Update process.
All Vendors	Select to run the Cumulative Sourcing Update process for all the suppliers that are set to use the cumulative split sourcing method. When selected, the Supplier SetID and Supplier ID fields are unavailable for entry.
Supplier SetID	Select the SetID of the supplier for which you want to run the Cumulative Sourcing Update process.
Supplier ID	Select the supplier for which you want to run the Cumulative Sourcing Update process.

Run Controls

<i>Field or Control</i>	<i>Description</i>
Check Cumulative Period	Select this check box to look for categories that have entered a new period, update history dates, and recalculate amounts for those categories. The Process Request Parameters fields do not apply to this check box.
Force Amount Recalculation	Select this check box to force amount recalculation for the categories and suppliers that meet the process request parameters.

Working with Large Requisitions

Chunking controls the number of lines that the system initially loads when you open a requisition. Using chunking functionality, you can initiate an advanced requisition line search that eliminates system processing times for a requisition with a large number of lines and provides a quick and easy method to retrieve specific lines in the requisition.

Note: A chunk is not the same as a page full of data. It represents all of the rows that are in the scroll at a given point in time.

When you open an existing requisition, if the number of requisition lines exceeds the chunking limit defined on the Installation Options page for Purchasing and the new PO Installation setting specifies to display the Advanced Line Search first, the system does not initially load requisition lines. Instead, a search page appears that you can use to view and load specific lines, based on criteria that you specify.

The search can either pull lines directly into the Maintain Requisition page or show the results in a temporary summary grid from which you can select individual lines to load into the page.

Note: You can also access the Advanced Line Search page using the Search for Lines link on the Maintain Requisitions page.

1. Open the Installation Option page for Purchasing. “Installation Options - Purchasing Page” (Application Fundamentals)
2. Specify the maximum number of rows to retrieve for requisition searches.
3. Select the Display Advanced Line Search Page option to define the initial advanced search behavior when the maximum number of rows has been exceeded for requisition lines.
4. Search for a requisition with lines that exceed the maximum number of rows to retrieve.

Note: If the requisition lines do not exceed the maximum number of rows, the system accesses the Maintain Requisition page and does not initiate the advanced search.

5. Define search criteria to limit the search results and click the Search button.

6. Select the requisition lines that you want to load into the Maintain Requisitions page.
7. Click the Retrieve Selected Items link.

The system loads the lines and you can now maintain requisition and schedule lines.

Page Used to Work with Large Requisitions

Page Name	Object Name	Navigation	Usage
Maintain Requisitions – Advanced Line Search	REQ_HDR_CHUNK	Purchasing > Requisitions > Add/Update Requisitions	Define advanced search criteria for requisition lines.

Maintain Requisitions- Advanced Line Search

Use the Advanced Line Search page to define requisition line criteria

Navigation:

Purchasing > Requisitions > Add/Update Requisitions

This example illustrates the fields and controls on the Maintain Requisitions- Advanced Line Search. You can find definitions for the fields and controls later on this page.

Maintain Requisitions
Advanced Line Search

Business Unit US001 Requisition ID 000001146

Search for Requisition Lines

From Line To Line Max Number of Rows in Scrolls

Item ID Ship To Location

Description Supplier Item ID

Category Supplier's Catalog

Buyer Manufacturer ID

Supplier Name Mfg Item ID

From Due Date To Date UPN ID

Chartfields

GL Unit	Entry Event	Account	Alt Acct	Oper Unit	Fund	Dept	Program	Class	Bud Ref	Product	PC
<input type="text"/>	<input type="text"/>	<input type="text"/>	<input type="text"/>	<input type="text"/>	<input type="text"/>	<input type="text"/>	<input type="text"/>	<input type="text"/>	<input type="text"/>	<input type="text"/>	<input type="text"/>

The Search button displays lines which can be individually selected for retrieval whereas the Search and Load button loads the lines directly into the component. Hit Cancel Search to return to the main page with no changes. Clear Results will merely clear the search results from this page. Click off Warn Before Autosaving to avoid a message that prior changes will be saved before loading in new lines.

Search Search and Load Cancel Search Clear Results Warn Before Autosaving

Search Results Personalize Find View All First 1 of 1 Last

Line	Item	Description	UOM	Category	Status	Merchandise Amount	Currency
<input type="checkbox"/>	1 BKCS-1	Bike Transport Case	EA	ACCESSORIES	Approved	1980.00	USD

Select All Deselect All

Use the Advanced Line Search page to define requisition line criteria on which to base the search. After defining search criteria, click the Search button to display the lines in the Search Results grid. The results

include information about the line and additional actions that you can perform to load the lines. Select the More Details tab to see more information about the requisition lines.

You can also load the lines into the Maintain Requisition page by clicking the Search and Load button.

You can use all of the fields that are available for entry in the Search for PO Lines section and the Chartfields grid to filter the search results. The prompts that are available for the item ID, ship to location, supplier item ID, category, supplier's catalog, manufacturer ID, manufacturing item ID, and contract ID are for distinct values within existing requisition lines. The system loads a requisition line if at least one of the line's schedules matches any schedule criterion entered.

The Chartfields grid displays the ChartFields on the purchase order distribution level. Any combination of ChartField values that you enter must match the same values on at least one distribution line for the requisition line to be loaded. The system loads the requisition line even if other distributions that belong to that line do not match the exact ChartField combination entered

The search and processing options for the Maintain Requisitions - Advanced Line Search page are the same as those for the Maintain Purchase Order - Advanced Line Search page.

For more information about the page field descriptions [Working with Large Purchase Orders](#)

Using the Requisition Loader

Understanding the Purchasing Requisition Loader Application Engine Process (PO_REQLOAD)

The Purchasing Requisition Loader process collects purchase requests from PeopleSoft Inventory, PeopleSoft Order Management, PeopleSoft Project Costing, PeopleSoft Product Configurator, PeopleSoft Maintenance Management and from PeopleSoft Purchasing or external systems. The process loads the requests into PeopleSoft Purchasing, where requisitions can be created for them.

These different sources of requisition data are called system sources. The PO Batch (purchase order batch) and External Source are always valid system sources for the Purchasing Requisition Loader process. Valid system sources for other PeopleSoft applications appear if you have those applications installed.

The Purchasing Requisition Loader process identifies each loaded purchase request by its requesting business unit. It uses default requester, item, and supplier information to generate requisition lines for sourcing purchase orders or generating inventory demand transactions. Before running the Purchasing Requisition Loader process, you must establish this requisition default information on the Requisition Loader Defaults - Req Loader Defaults (requisition loader defaults - requisition loader defaults) page. Use this page to set up default values for each business unit, system source, and loader business unit combination for which you want to process purchase requests. These default values populate appropriate empty requisition fields when the process runs.

You can use the Requisition Loader Defaults - Overrides and Options page to set override options for the Purchasing Requisition Loader process. The values and status that you define on this page replace the applicable existing requisition field values when the process runs.

The Purchasing Requisition Loader process initially validates the requesting business unit ID and identifies SetID-related information. If the process does not encounter any errors, it changes the purchase request status to being processed. The Purchasing Requisition Loader process generates a requisition for the valid request rows and assigns it the next sequential requisition ID for the PeopleSoft Purchasing business unit.

This process will also populate the procurement card information on the requisition if default procurement card information is defined for the requester. If during this process the system determines that the procurement card has expired, it will go ahead and create the requisition without the procurement card information. In this situation the process does not issue any messages. Finally, the process then sets the status of the valid request rows to *Processed*. If the Purchasing Requisition Loader process encounters an error in processing the purchase request rows, it stops processing and leaves the purchase requests unchanged.

PeopleSoft Integrated FieldService, PeopleSoft Purchasing, and external system purchase requests are stored on the PO_REQLOAD_RQST table. You should purge the PO_REQLOAD_RQST table periodically by using the Purge Reqload Requests process (PO_RLRQPRG).

You can also default contract information into the requisition loader by using **Default Contract on Req** check box on the Purchasing Business Unit Options page. This makes the contract available to automatically default onto requisition and purchase order transactions.

The system searches for and ensures that the correct contract is selected for use with the requisition. Any pricing changes for the requisition are called by the AE_PO_CMPRICE process to handle the pricing related to the defaulted contract. For example, if a contract is defaulted into the requisition loader, it will have its related contract price in the requisition item. The system also verifies that the **Auto Default** check box is selected on the Contract page.

Note: Depending on the PeopleSoft Framework Approval setting for the requisition, the update might be required to go through approval workflow.

See [Contract Pricing for Requisitions and Purchase Orders](#).

Related Links

[Correcting Purchasing Requisition Loader Process Errors](#)

[Purging Requisition Load Requests](#)

[Commitment Control Budget Processor Process in PeopleSoft Purchasing](#)

“Using Requisition Loader Defaults and Overrides” (PeopleSoft Source to Settle Common Information)

Defining Purchasing Requisition Loader System Sources

This section discusses Purchasing Requisition Loader process system sources. The process looks to these various sources to see if any transactions are available for requisition creation.

Inventory System Source

When running the Purchasing Requisition Loader process, you can have it query the PeopleSoft Inventory system source (REPLEN_RQST_INV table) for inventory items that require replenishment. To have the process query this table, select a system source field value of *BIN* (inventory batch) on the Requisition Loader page.

The Purchasing Requisition Loader process retrieves PeopleSoft Inventory requisitions in *Ready* status. While the Purchasing Requisition Loader process is processing the inventory requisition, the inventory requisition is in a process status. Once the Purchasing Requisition Loader process successfully creates a requisition for the inventory requisition, the inventory requisition is in *Processed* status. If the item ID is not a valid PeopleSoft Purchasing item, the inventory requisition schedule status is set to *Error*.

The Purchasing Requisition Loader process requires a default account code, which you set up on the Requisition Loader Defaults - Req Loader Defaults page. The value that you define populates the account code on the requisition's distribution lines. This is typically defined with an accrued liability account rather than the expense or inventory account when the Purchasing Requisition Loader process loads replenishment requisitions from PeopleSoft Inventory. Because these replenishment requests will be putaway into inventory, the Inventory Accounting Line generation process determines the appropriate inventory account for the putaway transaction, and the offset accounting information originates from the Requisition's General Ledger ChartFields. In addition, the DISTRIB_TYPE field can be populated from the replenishment request, carried through PeopleSoft Purchasing, and passed back to PeopleSoft Inventory with the receiving transactions. The information is then passed to PeopleSoft Cost Management, which creates the appropriate PeopleSoft General Ledger transactions. The offset account information, which is in the PeopleSoft General Ledger ChartFields on the purchase order, is populated

by PeopleSoft Payables and used on the voucher transactions to offset the actual AP Liability when the voucher is posted.

Order Management System Source

When running the Purchasing Requisition Loader process, you can have it query the PeopleSoft Order Management system source (ORD_SCHEDULE table) for order line items that require direct shipment from the supplier to the customer. To have the process query this table, select a system source field value of *BOM* (order management batch) on the Requisition Loader page.

The Purchasing Requisition Loader process retrieves direct shipment purchase requests that meet the following criteria:

Field	Field Value
TRFT_SRC_TYPE	3 (New Requisition)
IN_FULFIL_STATE	10 (Pending)
TRFT_DISPOSITION	2 (Direct Receipt)
or	or
TRFT_SRC_TYPE	3 (New Requisition)
IN_FULFIL_STATE	10, 70 (Pending, Depleted)
TRFT_DISPOSITION	1 (Direct Ship)
ORD_SCHEDULE.ORD_SCH_STATUS	O (open)
ORD_SCHEDULE.PO_DISTRIB_STATUS	1 (active)
ORD_SCHEDULE.PO_HOLD_FLAG	N (no)

If the special handling check box (SPEC_HANDLE_CODE) is selected on the order schedule, the Purchasing Requisition Loader process uses the shipping method code (SHIP_TYPE_ID) and carrier ID (CARRIER_ID) on the order schedule for the requisition schedule. The same shipping method and carrier ID information is used on the purchase order. If the purchase request is for a configured product, the Purchasing Requisition Loader process also retrieves the configuration code (CONFIG_CODE) and template ID (TEMPLATE_ID). Each requisition line generated carries the ship to customer ID (SHIP_TO_CUST_ID) from the PeopleSoft Order Management sales order.

While the Purchasing Requisition Loader process is processing the direct shipment purchase requests, the direct ship from supplier schedule is in *In Process* status. Once the Purchasing Requisition Loader process successfully creates a requisition for the purchase request, the direct ship from supplier schedule status changes to *Processed*. If the item ID is not a valid purchasing item, the Purchasing Requisition Loader process changes the schedule status to *Error*. The Purchasing Requisition Loader process updates the PeopleSoft Order Management sales order with the requisition information. View the requisition in PeopleSoft Order Management on the Shipment Schedules page.

Note: Direct ship from supplier orders are not eligible for receiving in PeopleSoft Purchasing because they are normally sent directly to a customer site and received there.

Project Costing System Source

When running the Purchasing Requisition Loader process, you can have it query the PeopleSoft Project Costing system source (PROJ_RESOURCE table) for PeopleSoft Project Costing purchase requests. To have the process query this table, select a system source field value of *PPC* (project costing online entry page) on the Requisition Loader page.

The Purchasing Requisition Loader process retrieves PeopleSoft Project Costing purchase requests that meet the following criteria:

Field	Field Value
DEFAULT_ANALYSIS_TYPE	<i>REQ</i> (required)
PO_DISTRIB_STATUS	<i>I</i> (active)

While the Purchasing Requisition Loader process is processing the PeopleSoft Project Costing purchase request, the Project Costing order is in *In Process* status. Once the Purchasing Requisition Loader process creates requisitions from the PeopleSoft Project Costing purchase request, it adds a requisition ID to each of the requisition transactions on the PROJ_RESOURCE table. It also changes the PO_DISTRIB_STATUS of the requisition transactions on the PROJ_RESOURCE table to *Processed*.

Maintenance Management System Source

When running the Purchasing Requisition Loader process, you can have it query the PeopleSoft Maintenance Management system source (WM_WO_SCHED_PO table) for description only or non-inventory line items that need to be sourced through PeopleSoft Purchasing. To have the process query this table, select a system source field value of *WM* (Maintenance Management) on the Requisition Loader page.

The Purchasing Requisition Loader process retrieves PeopleSoft Maintenance Management requisitions in *Ready to Stage* status (WO_REQ_STATUS). While the Purchasing Requisition Loader process is processing the maintenance management requests, the maintenance management requisition status is *In Process*. Once the Purchasing Requisition Loader process successfully creates a requisition for the maintenance management requisition, the maintenance management requisition is in *Complete* status.

The Purchasing Requisition Loader process retrieves the PeopleSoft Maintenance Management procurement distribution rows if the item is non-inventoried or open description. It then copies the distribution rows to the requisition. It also copies the project business unit, project, and project activity from the work order.

Plus, the process will clear the asset information for distributions that are associated with PeopleSoft Maintenance Management work orders because requisitions associated with work orders cannot be designated for PeopleSoft Asset Management.

External System Sources

External system sources for the Purchasing Requisition Loader process include third-party systems, PeopleSoft Integrated FieldService, and PeopleSoft Purchasing. Each of these external system sources stages requisition data to the PO_REQLOAD_RQST table.

The following table lists the system source field values that designate external systems sources on the Requisition Loader page:

<i>External System Source</i>	<i>System Source Field Value</i>
PeopleSoft Purchasing	<i>BPO</i>
PeopleSoft CRM FieldService	<i>BPO</i>
Third-party data source	<i>FRM</i> (external form)

Related Links

[Correcting Purchasing Requisition Loader Process Errors](#)

[Updating Direct Shipment Information](#)

“Processing Inbound EIPs” (PeopleSoft Supply Chain Management Integration)

“Understanding Inventory Replenishment Processing” (PeopleSoft Inventory)

“Creating and Modifying Replenishment Requests” (PeopleSoft Inventory)

“Maintaining Order Schedule Information” (PeopleSoft Order Management)

“Integrating Requisitions and Purchase Orders with PeopleSoft Project Costing” (PeopleSoft Project Costing)

“Using Requisition Loader Defaults and Overrides” (PeopleSoft Source to Settle Common Information)

Loading Requisitions

This section discusses how to run the Purchasing Requisition Loader process.

Page Used to Load Requisitions

<i>Page Name</i>	<i>Definition Name</i>	<i>Usage</i>
Requisition Loader Page	RUN_POC1210	Set parameters for running the Purchasing Requisition Loader process.

Requisition Loader Page

Use the Requisition Loader page (RUN_POC1210) to set parameters for running the Purchasing Requisition Loader process.

Navigation:

Purchasing > Requisitions > Load Requisitions > Requisition Loader

This example illustrates the fields and controls on the Load Requisitions page. You can find definitions for the fields and controls later on this page.

Load Requisitions

Run Control ID 190253US010PAR Report Manager Process Monitor Run

Process Request Parameters

*System Source Par Location Batch

*Run Type

*Requesting Loader Bus Unit To

Requisition Request ID

Replenish ID

Par Location ID Par Count ID

Auto Assign Req ID Create Mult Reqs

Auto Line Numbering Copy Item Spec

*Get Preferred Supplier

<i>Field or Control</i>	<i>Description</i>
System Source	<p>Indicates the version of the Purchasing Requisition Loader process that you want to run for the selected requisition loader business unit.</p> <p>Depending on the system source that you define here, the process queries various tables and loads qualifying purchase requests to create requisitions.</p> <p>PeopleSoft Purchasing batch and the external system sources are always valid values. Other valid system sources vary depending on the applications installed.</p> <p>Values include:</p> <p><i>BCP</i> (configurator product batch).</p> <p><i>BIN</i> (inventory batch).</p> <p><i>BOM</i> (order management batch).</p> <p><i>BPO</i> (purchase order batch).</p> <p><i>POU</i> (point of use).</p> <p><i>PPC</i> (project costing online entry page).</p> <p><i>WM</i> (maintenance management)</p> <p><i>BPL</i> (par location replenishment)</p>

Field or Control	Description
Run Type	<p>Select whether to run the process for all business units, one business unit, one purchase request, or a range of business units. The Auto Load Indicator check box on the Requisition Loader Defaults - Req Loader Defaults page must be selected for business units and their requests to be eligible for processing in conjunction with the <i>All Business Units</i> and <i>Range of Business Units</i> run types. Run types are:</p> <p><i>All Business Units</i>: Select to run the process for all business units.</p> <p><i>One Business Unit</i>: Select to run the process for one business unit. If you select this value, enter a value in the Requesting Loader Bus Unit (requesting loader business unit) field.</p> <p><i>One Request</i>: Select to run the process for a particular requisition request ID or replenish ID. When you select this value, the Requisition Request ID field becomes available for entry. If you select this value for the BIN system source, the Replenish ID field becomes available for entry and you must enter a value.</p> <p><i>Range of Business Units</i>: Select to run the process for a range of business units. If you select this value, enter a From and To Requesting Loader Bus Unit.</p>
Requesting Loader Bus Unit (requesting loader business unit)	Select the originating business unit for the requests that you want to load. Values include only those business units that are valid for the selected system source. The valid business units for each system source are defined on the Requisition Loader Defaults - Req Loader Defaults page.
Requisition Request ID	Identifies a group of purchase request rows on the PO_REQLOAD_RQST table. Create this ID by specifying any number as the requisition request ID. If you select a run type of <i>One Request</i> , you must enter either a requisition request ID or a replenish ID. The Requisition Request ID field is not used for inventory batch requests, or for the BIN system source.
Replenish ID (replenishment ID)	Identifies the inventory replenishment to be loaded to a requisition and is used when the system source is inventory batch, or BIN. If you select a run type of <i>One Request</i> , you must enter a replenishment ID. If you do not enter a replenishment ID when running the process for the BIN system source, all replenishment IDs for the Inventory Requisition Loader business unit selected are loaded to the requisition.
Par Location ID and Par Count ID	<p>Select a par location ID and Par Count ID.</p> <p>These fields are available when the selected option for the Run type field is One Request.</p>

Field or Control	Description
Auto Assign Req ID (automatic assign requisition ID)	<p>Select to specify the automatic numbering options for the requisitions that are created by the Purchasing Requisition Loader process. If a requisition ID is already assigned to the purchase request on the PO_REQLOAD_RQST table, the existing requisition ID is used. Values are:</p> <p><i>When not specified:</i> If no requisition ID is assigned on the table or on the page, the Purchasing Requisition Loader process determines the requisition ID.</p> <p><i>When not specified use:</i> If no requisition ID is assigned, the requisition ID that you specify in the adjacent field is assigned and the line numbers are calculated.</p>
Create Mult Reqs (create multiple requisitions)	<p>Select this check box to create a separate requisition ID for each replenishment ID (PeopleSoft Inventory), loader requisition ID (external), resource ID (PeopleSoft Project Costing), and order number (PeopleSoft Order Management). If you select this check box, the maximum load lines number is ignored, and the Auto Assign Req ID and Auto Line Numbering fields are unavailable for entry.</p> <p>Unless you select the Create Mult Reqs (create multiple requisitions) check box, the Purchasing Requisition Loader process creates one requisition that includes all the purchase request data until the maximum load lines number is met. Set the maximum load lines number at installation on the Installation Options - Purchasing page.</p> <hr/> <p>Note: If the rows for the Purchasing Requisition Loader process have stockless items and standard items (items you stock) and you <i>do not</i> select the Create Mult Reqs check box, the system will still create separate requisitions one for the stockless items and one for the standard items.</p> <hr/>
Auto Line Numbering	<p>Select automatic line numbering options for the requisitions that are created by the Purchasing Requisition Loader process. Values are:</p> <p><i>Auto Assign:</i> Select to have the system assign a number to each requisition line automatically. Any requisition line numbers that you entered previously are overridden.</p> <p><i>When not specified:</i> Select to have the system assign requisition line numbers only when a line number is not specified.</p>
Copy Item Spec (copy item specifications)	<p>Select this check box to copy the item specifications to the requisition. This check box is available when the system source is inventory batch, or BIN.</p>

Field or Control	Description
Get Preferred Supplier	<p>Select a supplier for the requisitions that the Purchasing Requisition Loader process creates. Values are:</p> <p><i>Always Override:</i> Select to have the system override the supplier that is selected on the requisition and substitute it with the preferred supplier.</p> <p><i>None:</i> Disables this field. A preferred supplier is not selected. If the supplier ID field on a requisition is blank, the system does not populate that field. However, if you have already provided a supplier ID, the system preserves the selection.</p> <p><i>When not specified:</i> Select to have the system select the preferred supplier only on requisitions that do not have a supplier specified.</p>

Related Links

[Defining Purchasing Requisition Loader System Sources](#)

“Installation Options - Purchasing Page” (Application Fundamentals)

“Req Loader Defaults Page” (PeopleSoft Source to Settle Common Information)

Using the Purchase Order Requisition EIP

This section provides an overview of the Purchase Order Requisition EIP and discusses how to process the Purchase Order Requisition EIP.

Pages Used to Use the Purchase Order Requisition EIP

Page Name	Definition Name	Usage
Requisition Loader Page	RUN_POC1210	Set parameters for running the Purchasing Requisition Loader process.
Data Collection Setup Page	BCT_SETUP_FS	Set the option to keep transaction log history for electronic data collection transactions and to set the default file suffix.
“Data Def Maint Page” (PeopleSoft Supply Chain Management Integration)	EO_EIP_CTL_MAINT	View data detail or correct errors for subscribe messages that contain data rather than transactions

Understanding the Purchase Order Requisition EIP

The Purchase Order Requisition EIP processes requisition data using an asynchronous service operation from PeopleSoft CRM or external surgical resource software application.

This data is loaded to the PO_REQLOAD_RQST and PO_REQLOAD_CMT staging tables.

Run the Purchasing Requisition Loader process to create requisitions from the staged data.

Using the Purchase Order Requisition EIP

PeopleSoft delivers the service operations in PeopleSoft Integration Broker with a default status of *Inactive*. You must activate each service operation before attempting to send or receive data from a third-party source or another PeopleSoft system, such as CRM.

Before you can use the Purchase Order Requisition EIP, you must:

1. Setup the service operation within PeopleSoft Integration Broker and Enterprise Components:

Use the information in the table below and refer to the setup instructions in the PeopleSoft Supply Chain Management Integration, "Implementing Integrations" topic, Setting Up Service Operations section.

Service Operation	Direction and Type	Handlers	Chunking Available?	Integrates With
PURCHASE_ REQUISITION_ LOAD	Inbound Asynchronous	Purchase Requisition Load	No	third-party system Surgical Resource Software application
PURCHASE_ REQUISITION_ LOAD_CRM	Inbound Asynchronous	Purchase Requisition Load	No	PeopleSoft CRM

2. Run the Purchasing Requisition Loader process to create requisitions from the staged data.
3. Use the Data Def Maint page to view service operation data and correct error messages that are picked up in the processing of the service operation.

See the product documentation for *PeopleTools: Integration Broker*

Related Links

“Setting Up Service Operations” (PeopleSoft Supply Chain Management Integration)

“PeopleSoft SCM Inbound EIPs” (PeopleSoft Supply Chain Management Integration)

Correcting Purchasing Requisition Loader Process Errors

This section provides an overview of the Purchasing Requisition Loader error processing.

Pages Used to Correct Purchasing Requisition Loader Process Errors

Page Name	Definition Name	Usage
Requisition Loader Request Page	PO_REQLOAD_RQST	Review and correct Purchasing Requisition Loader process data for the external form and purchasing batch system sources. For other system sources, errors are set as statuses on source records. Access the source document directly to correct data.
Description Page	PO_REQLOAD_DESCR	Enter and view descriptions for a specific item. The item description link comprises the first 30 characters of the item's description in the Transaction Item Description text box on the Description page. Requisition Loader Request Page
Asset Information Page	REQ_LOAD_ASSET	Enter asset information for an eligible item. Requisition Loader Request Page
Comments Page	REQ_LOAD_CMT1	View and enter comments for specific requisitions. Requisition Loader Request Page
Category Search Page	CAT_SEARCH_SEC	Search for and select an appropriate category ID for the item when entering an improvised item. The search for the category ID is done using a category hierarchy tree. Requisition Loader Request Page
Override Address Page	REQ_LOAD_OVADDR	Enter or edit override address information that is carried over with the requisition from the PO_REQLOAD_RQST table.
View Category Hierarchy	CAT_PARENTAGE_SEC	View information about where a category resides in the entire catalog tree hierarchy. Requisition Loader Request Page

Understanding the Purchasing Requisition Loader Error Processing

During processing, the Purchasing Requisition Loader process, like other processes, writes messages to the PeopleSoft Application Engine trace log. If an error occurs that terminates the Purchasing Requisition Loader process before it creates the new requisition, you must review the log, correct the error that is indicated on the Requisition Loader Request page, and restart or rerun the Purchasing Requisition Loader process.

If the item ID on a purchase request is not a valid PeopleSoft Purchasing item, the purchase request line status is set to *Error*. To correct this error, go to the system source.

See the product documentation for *PeopleTools: Application Engine*

Requisition Loader Request Page

Use the Requisition Loader Request page (PO_REQLOAD_RQST) to review and correct Purchasing Requisition Loader process data for the external form and purchasing batch system sources.

For other system sources, errors are set as statuses on source records. Access the source document directly to correct data.

Navigation:

Purchasing > Requisitions > Stage Requisitions

Requisition Tab

<i>Field or Control</i>	<i>Description</i>
Status	Displays the current status of the purchase request transaction. After you make any necessary corrections on this page, change the status from <i>Error</i> to <i>Active</i> , then save the page. When you change the status to <i>Active</i> , the purchase request transaction becomes available to be picked up by the Purchasing Requisition Loader process.
Item ID	Displays the ID number for the requisitioned item. If the purchase request has an incorrect item ID, you must correct the item ID to save the page. If the purchase request does not have an item ID, enter a requisition quantity, unit of measure, price, and category in order to save the page.

Price Tab

Select the **Price** tab.

Field or Control	Description
Ship To Customer	Displays the ship to customer ID that is assigned to the requisition line. For system sources of BPO, a value in this field indicates that the order should be shipped directly to a customer.
IN Unit (PeopleSoft Inventory business unit)	Displays the PeopleSoft Inventory business unit that is assigned to the requisition line.
Revision	Displays the manufacturer's product revision number of the requested item. If the ship to is a PeopleSoft Inventory business unit, and the item is under revision control in that business unit, the revision defaults to that effective on the due date.
Req Qty (requisition quantity)	Displays the requisition quantity. If no requisition quantity appears, you must enter a value here.
Calc Price (calculate price)	Select this check box if you want the requisition price to be recalculated for the purchase order by the PO Calculations process (PO_POCALC).

Chartfields Tab

Select the **Chartfields** tab.

All the fields on this tab are optional and are used only if they are supplied by the system source from which the information is being loaded.

Field or Control	Description
Currency	The value in this field appears by default from the Requester Setup page (REQUESTOR_TBL) if the business unit enables multicurrency requisitions. If the business unit does not allow multicurrency requisitions, the currency field value is populated from the business unit. You cannot override this value on this page. This currency is referred to as the requisition transaction currency. If there is no currency set up in the requester table, it appears by default from the business unit.
Location	Enter the internal item delivery location for this requisition line. The value in this field is the internal destination of the requested items.

Field or Control	Description
GL Unit (PeopleSoft General Ledger business unit)	Displays the PeopleSoft General Ledger business unit that is charged for the requisitioned items. The PeopleSoft General Ledger business unit appears by default from the requisition business unit.
Entry Event	Correct any errors resulting from invalid entry event codes that are loaded from external sources. Any value that is selected here is overridden if there is an entry event code selected on the Requisition Loader Defaults - Overrides and Options page.
Ult Use Code (ultimate use code)	Select the ultimate use code. In some situations, the ultimate use of an item alters the sales and use taxes that a business unit must pay. The system calculates the sales and use tax based on the tax authority and the ultimate use codes that are established on the Ultimate Use Code page.
Entered By	Displays the user ID of the person who entered the requisition.

Related Links

[Understanding Entry Events in PeopleSoft Purchasing](#)

[Running the PO Calculations Process](#)

“Ultimate Use Codes Page” (Application Fundamentals)

“Understanding PeopleSoft ChartFields” (Application Fundamentals)

“Requester Setup Page” (PeopleSoft Source to Settle Common Information)

“Using Requisition Loader Defaults and Overrides” (PeopleSoft Source to Settle Common Information)

Comments Page

Use the Comments page (REQ_LOAD_CMT1) to view and enter comments for specific requisitions.

Navigation:

Click the **Comments** link on the Requisition Loader Request page.

Field or Control	Description
Comment Type	Select a comment type. Types are: <i>Header:</i> Comments are designated as requisition header comments and are accessible from the Maintain Requisitions - Requisitions page. <i>Line:</i> Comments are designated as requisition line comments and are accessible from the Maintain Requisitions - Requisitions page.
Allow Modify Comments	Select this check box to enable other users to modify these comments.
Send to Supplier	Select this check box to send these comments to suppliers.
Shown at Receipt	Select this check box to have these comments appear on the receipt documents.
Shown at Voucher	Select this check box to have these comments appear on the voucher.

Related Links

[Maintain Requisitions - Requisition Page](#)

Override Address Page

Use the Override Address page (REQ_LOAD_OVADDR) to enter or edit override address information that is carried over with the requisition from the PO_REQLOAD_RQST table.

Navigation:

Click the **Override Address** link on the Requisition Loader Request page.

The address information that you enter on this page should not necessarily be the customer address, if a ship to customer ID is supplied. The override address information could be almost any other address, from an alternate customer address to a mailbox stop where a service technician can pick up a part that is needed to perform a repair.

Updating Direct Shipment Information

This section provides an overview of the Direct Shipments Update Application Engine process (PO_REQDROP) and discusses how to run the Direct Shipments Update process.

Page Used to Update Direct Shipment Information

Page Name	Definition Name	Usage
Update Direct Ship Page	RUN_REQ_DRPSHP_CHG	Run the Direct Shipments Update process.

Understanding the Direct Shipments Update Application Engine Process (PO_REQDROP)

The Direct Shipments Update process retrieves modified PeopleSoft Order Management sales order schedules and updates the requisitions in PeopleSoft Purchasing.

This process looks for purchase requests on the ORD_SCHEDULE table that have a direct ship status (PO_DISTRIB_STATUS) value of *Modified*. When you modify certain aspects of direct ship from supplier sales order lines or shipment schedules in PeopleSoft Order Management, the system sets the direct ship status to *Modified*.

Changes made to the following fields set the direct ship status to *Modified*:

Field	Field Name	PeopleSoft Order Management Page
Product ID	PRODUCT_ID	Order Lines
Order Quantity	QTY_ORDERED	Order Lines
Requested Shipment Date	REQ_SHIP_DTTM	Shipment Schedules
Requested Shipment Time	REQ_SHIP_DTTM	Shipment Schedules
Requested Arrival Date	REQ_ARRIVAL_DTTM	Shipment Schedules
Requested Arrival Time	REQ_ARRIVAL_DTTM	Shipment Schedules

If the special handling check box (SPEC_HANDLE_CODE) is selected on the order schedule, changes that are made to the values in the following fields also set the direct ship status to *Modified*:

Field	Field Name	PeopleSoft Order Management Page
Carrier ID	CARRIER_ID	Shipment Schedules
Shipping Via	SHIP_TYPE_ID	Shipment Schedules

If you cancel the PeopleSoft Order Management direct ship from supplier sales order schedule, the system sets the direct ship status to *Modified*. After the Direct Shipments Update process runs, if the direct ship from supplier sales order schedule is changed, the direct ship status (PO_DISTRIB_STATUS) is set to *Processed*. If the direct ship from supplier sales order schedule is canceled, the system sets the requisition distribution status to *Canceled*. If the requisition is sourced to a purchase order, an entry is created for the Change Purchase Order process. When the change order is processed and if the purchase order is already dispatched, corresponding purchase order lines are canceled. If the purchase order is not yet dispatched you'll receive a message suggesting that you delete the corresponding purchase order lines.

If the requisition has already been sourced to one or more purchase orders, each changed field that is defined in the change order template generates a change order in PeopleSoft Purchasing. If the changed field is not identified in the change order template, PeopleSoft Purchasing does not create a change order. There is a new change order every time that you dispatch the purchase order.

Update Direct Ship Page

Use the Update Direct Ship page (RUN_REQ_DRPSHP_CHG) to run the Direct Shipments Update process.

Navigation:

Purchasing > Requisitions > Update Direct Shipments > Update Direct Ship

Process Request Parameters

<i>Field or Control</i>	<i>Description</i>
All Business Units	Select to run this process for all PeopleSoft Order Management business units. If you clear this check box, enter a single PeopleSoft Order Management business unit value in the Order Management Business Unit field.

Purging Requisition Load Requests

This section provides an overview of the Purge Requisition Load Request Application Engine process (PO_RLRQPRG) and discusses how to run the Purge Requisition Load Request process.

Page Used to Purge Requisition Load Requests

<i>Page Name</i>	<i>Definition Name</i>	<i>Usage</i>
<u>Purge Reqload Requests (purge requisition load requests) Page</u>	RUN_PO_RLRQPRG	Set parameters for the Purge Requisition Load Request process and initiate the process.

Understanding the Purge Requisition Load Request Application Engine Process (PO_RLRQPRG)

Use this process to purge purchase requests that accumulate on the PO_REQLOAD_RQST table. This table is used to store purchase requests that are loaded by the Purchasing Requisition Loader process.

To increase system performance, PeopleSoft recommends that you run the Purge Requisition Load Request process regularly, depending on how often you execute the Purchasing Requisition Loader process.

Purge Reqload Requests (purge requisition load requests) Page

Use the Purge Reqload Requests (purge requisition load requests) page (RUN_PO_RLRQPRG) to set parameters for the Purge Requisition Load Request process and initiate the process.

Navigation:

Purchasing > Requisitions > Purge Load Requests > Purge Reqload Requests

<i>Field or Control</i>	<i>Description</i>
Purge Processed Rows	Select this check box to purge the purchase requests on the PO_REQLOAD_RQST table that are in <i>Processed</i> status.
Purge Error Rows	Select this check box to purge the purchase requests on the PO_REQLOAD_RQST table that are in <i>Error</i> status.
System Source	Select the system source for the requests that are to be purged.
Requesting Loader Bus Unit (requesting loader business unit)	Select a business unit. If you do not specify a business unit, all requisition loader business units are processed.
Requisition Request ID	Select a requisition request ID on which to run this process. If you enter a value here, specify a requesting loader business unit. Values include the available IDs for the selected business unit. Entering a value here further refines the selection that you make by specifying a requesting loader business unit.

Field or Control	Description
Date Selection	<p>Specify a date selection operation. This field value combines with other operation modifiers to define a date selection operation for capturing Purchasing Requisition Loader requests to purge. Values include:</p> <p><i>C</i> (current date): Defines the date selection operation based on the current date and the operation modifier in the Operand field.</p> <p><i>M</i> (current date minus days): Defines the date selection operation based on the current date, the operation modifier in the Operand field, and the number of days that you subtract from the current date by using the Nbr Days (number of days) field.</p> <p><i>N</i> (no selection by date): Prevents the use of a date selection operation.</p> <p><i>P</i> (current date plus days): Defines the date selection operation based on the current date, the operation modifier in the Operand field, and the number of days that you add to the current date by using the Nbr Days field.</p> <p><i>S</i> (specified date): Defines the date selection operation based on a date that you specify and on the operation modifier in the Operand field. When you select this value, the Date Sel Date (date selection date) field is activated.</p>

Field or Control	Description
Operand	<p>Enter an operand to modify the date selection operation. An operand is the modifier that is appended to an operation. In this case, the value in this field combines with the value in the Date Selection field to define the date selection operation that the system uses to collect the Purchasing Requisition Loader requests for purging. The value that you enter here can also combine with the value in the Nbr Days field to further define the date selection operation. Values include:</p> <p>< (less than selection date): The date selection operation captures only Purchasing Requisition Loader process requests with process dates that are less than the selection date. The process date is the date on which the Purchasing Requisition Loader process processed the request and created the requisition.</p> <p><= (less than or equal to selection date): The date selection operation captures only Purchasing Requisition Loader process requests with process dates that are less than or equal to the selection date.</p> <p><> (not equal to selection date): The date selection operation captures only Purchasing Requisition Loader process requests with process dates that are not equal to the selection date.</p> <p>= (equal to selection date): The date selection operation captures only Purchasing Requisition Loader process requests with process dates that are equal to the selection date.</p> <p>> (greater than selection date): The date selection operation captures only Purchasing Requisition Loader process requests with process dates that are greater than the selection date.</p> <p>>= (greater than or equal to selection date): The date selection operation captures only Purchasing Requisition Loader process requests with process dates that are greater than or equal to the selection date.</p>
Nbr Days (number of days)	<p>Enter a number of days to be used as an operation modifier. This operation modifier combines with the values in the Date Selection and Operand fields to define the date selection operation. If you select a date selection value that requires a number of days, enter the number here.</p>
Date Sel Date (date selection date)	<p>Enter a specific selection date other than the current date. The date that you enter here is the basis for the date selection operation that is used to collect Purchasing Requisition Loader process requests for purging. This field becomes available for entry when you select <i>S</i> (specified date) in the Date Selection field.</p>

Approving Requisitions

Understanding Requisition Approvals

Within PeopleSoft Purchasing, you can use workflow to approve requisitions. This enables you to direct approvals to the correct people in the correct order. At the purchasing business unit level, you can choose one of two different workflow methods:

1. PeopleTools Workflow Technology documented in the *PeopleTools: Workflow Technology*. This workflow method enables you to approve the requisition at the header level. You can route a requisition for approval based on the amount, the ChartFields used, or both. When you use the PeopleTools Workflow Technology approval method, requisitions are approved using workflow roles, rules, and routings. To implement workflow approvals, define the roles, rules, and routings using the PeopleSoft Application Designer, PeopleCode, and Workflow Administrator. Your system is delivered with basic approval rules already established.
2. PeopleSoft Approval Framework documented in the *PeopleSoft Approval Framework*. This workflow method enables you to approve the requisition at the header level, line level, or both. You can deny some lines of the requisition and approve others, making line-level approvals independent for each line. Besides approving or denying a requisition, you can also pushback a requisition or requisition line. A pushback returns the transaction to the previous approval step, requiring the prior approver to reevaluate the approval. With proper authorization, an approver can add other approvers, called ad hoc approvers, to the current or a later stage of the approval process. Reviewers and ad hoc reviewers can be part of the workflow. Reviewers see the requisition or requisition line but do not approve it.

See “Understanding the Approval Framework Process Flow” (Approval Framework)

Related Links

[Understanding PeopleSoft Purchasing Workflow](#)

Approving Requisitions With the Approval Framework

Use the Approve Requisitions component to perform a number of approval tasks, including:

- Approving a requisition or requisition line. You can approve the entire requisition at the header level or approve individual lines at the line level.
- Denying a requisition or requisition line. You can deny some lines of the requisition and approve others, making line-level approvals independent for each line. Once a requisition or requisition line is denied, the workflow stops.
- Holding a requisition or requisition line. This action gives the approver time to research an issue and prevents the approval process from going to the next approval step until the approver takes action on the requisition or requisition line. When an approver uses the hold action, the system inserts the

requisition's originator (i.e. requester) as an ad hoc reviewer at the current approval step and the approver can add a comment requesting more information from the requester. If multiple approvers are required to approve in this one approval step in the approval framework, then the other approvers of the same step can approve or deny the requisition or requisition line; however, the approval process does not move to the next approval step until the hold is removed by the approver who entered it.

- Pushing back a requisition or requisition line. A pushback returns the transaction to the previous approval step. The meaning of *push back* is that the approver is questioning the prior step's approval and is requesting clarification.
- Adding or removing ad hoc approvers or reviewers. During the approval process, approvers can add other approvers or reviewers to the current or a later stage of the approval process. For example, if a buyer wants input from an inventory analyst, she can add the analyst as an approver. This action is called ad hoc approval, and it only applies to the approval instance in which the addition occurs and does not affect the underlying process definition used for other requests.
- Reviewing an online requisition that shows the layout of the printed version. The requisition opens up as a second window and can be printed. The Oracle BI Publisher is used to generate this report and you can customize it.
- Making comments to be viewed by other approvers or reviewers.
- Approving a requisition that has been changed. When a requisition is changed during or after the approval process, the approval framework can require re-approval of the changes using the same approval component as the original requisition.
- Performing mass approvals. Using the Manage Requisition Approvals page, you can select multiple requisitions to be approved or denied at one time. Use the Mark All icons to perform mass approval.
- Self approval of requisitions. This feature can be restricted or turned off.

For a complete list of approval features, see the Understanding Approval Features section of the Understanding the Approval Framework of the PeopleSoft Approval Framework 9.2.

See "Understanding the Approval Framework," *PeopleSoft FSCM 9.2: Approval Framework*.

Approving, Denying, or Holding a Requisition

A requisition can be approved, denied, or put on hold at the header or line level. The Manage Requisition Approvals component enables you to:

- Approve, deny, or hold multiple requisitions at one time using the mass approval feature on the Manage Requisition Approvals page.
- Approve, deny, or hold requisitions at the header level using the Manage Requisition Approvals page.
- Approve, deny, or hold requisition lines using the Manage Requisition Approvals page.
- Approve, deny, or hold requisition lines using the Requisition Approval page where you can view more details and add ad hoc approver and reviewers.

To approve, deny, or hold multiple requisitions using the mass approval feature:

1. Go to the Manage Requisition Approvals page.

2. Select the *Approve*, *Deny*, or *Hold* button on the *Mark All* row. All displayed requisitions are marked with this action in the *Action/Status* field.
3. Change the *Action/Status* field for any requisitions that you do not want included in the mass approval action.
4. Click the *Submit* button.

Use the *Manage Requisition Approvals* page (PV_APP_MAN_PG) to view and take action on requisitions that require your approval or requisitions that previously required your approval.

Navigation:

Purchasing > Requisitions > Manage Requisition Approvals

This example illustrates the fields and controls on the *Manage Requisition Approvals* page (partial page). You can find definitions for the fields and controls later on this page.

Requisitions								
To approve or deny one or more pending requisitions, select the appropriate action from the dropdown and click submit. To view the complete details of a requisition, click the Requisition ID link.								
▼ Expand All			▶ Collapse All					
Action/Status	Req ID	Requisition Name	Bus. Unit	Date	Requester	Entered By	Total	
▶ Hold	0000000171	0000000171	US001	01/15/2013	Anita Gardner	Anita Gardner	200.00	USD
▶ Hold	0000000170	0000000170	US001	01/15/2013	Anita Gardner	Anita Gardner	28.00	USD
▶ Hold	0000000168	0000000168	US001	01/15/2013	Anita Gardner	Anita Gardner	200.00	USD
Mark All:	Approve	Deny	Hold					
<input type="button" value="Submit"/>								

To approve, deny, or hold requisitions (header level) using the *Manage Requisition Approvals* page:

1. Select a requisition that is in pending status.
2. Select the *Approve*, *Deny*, or *Hold* option in the *Action/Status* field.
3. Click the *Submit* button at the bottom of the page.

Use the *Requisition Approval* page (PV_REQ_APPROVAL) to perform approval tasks on one individual requisition.

You can view requisition details, enter comments, add ad hoc approvers and reviewer, as well as approve, deny, or hold a requisition line.

Navigation:

- **Purchasing > Requisitions > Manage Requisition Approvals. Click the Requisition ID link.**
- **Worklist > Worklist. For the work item > Approval Routing > click the requisition link on the row.**

This example illustrates the fields and controls on the Approving an entire requisition using the Manage Requisition Approvals page (partial page). You can find definitions for the fields and controls later on this page.

Manage Requisition Approvals

Search Requisitions

To locate requisitions that require your approval (or requisitions that previously required your approval), edit the criteria below and click the Search button.

Requisition ID <input type="text"/>	Requisition Name <input type="text"/>
Business Unit <input type="text"/>	*Status <input type="text" value="Pending"/>
Date From <input type="text"/>	Date To <input type="text"/>
Requester <input type="text"/>	Entered by <input type="text"/>

[Show Advanced Search](#)

Requisitions

To approve or deny one or more pending requisitions, select the appropriate action from the dropdown and click submit. To view the complete details of a requisition, click the Requisition ID link.

[Expand All](#) [Collapse All](#)

Action/Status	Req ID	Requisition Name	Bus. Unit	Date	Requester	Entered By	Total
<input type="text" value="Pending"/>	0000000094	0000000094	US100	01/12/2013	Kelly Jones	Kenneth Schumacher	618,403,630.00 USD

To approve, deny, or hold one or more requisition lines from the Manage Requisition Approvals page:

1. Expand a requisition in the Requisitions group box so that the lines are displayed. You can only approve, deny, or hold lines that are in a pending status.
2. Using the Action/Status field at the requisition line level, select an option for each requisition line that you want to approve, deny or put on hold.
3. Click the Submit button at the bottom of the page.

This example illustrates the fields and controls on the The Requisitions group box within the Manage Requisition Approvals page (partial page). You can find definitions for the fields and controls later on this page.

Requisitions

To approve or deny one or more pending requisitions, select the appropriate action from the dropdown and click submit. To view the complete details of a requisition, click the Requisition ID link.

[Expand All](#) [Collapse All](#) Currency: Approver Requester

Action/Status	Req ID	Requisition Name	Bus. Unit	Date	Requester	Entered By	Total
<input type="text" value="Pending"/>	0000000058	0000000058	US100	01/09/2013	Kelly Jones	Kelly Jones	1,310.00 USD
<input type="text" value="Pending"/>	0000000060	0000000060	US100	01/09/2013	Kelly Jones	Kelly Jones	2,340.00USD

Summary 2 of 2 Lines Pending Total Pending 2,340.00 USD Priority: Medium

Justification:
No justification entered by requester.

Lines [Personalize](#) | [Find](#) | [View All](#) | [First](#) | 1-2 of 2 | [Last](#)

Requisition Details		Item Details						
*Action/Status	Line	ePro Special Request Item	Item Description	Supplier Name	Price	Qty	UOM	
<input type="text" value="Pending"/>	1		Special request item 1		250.00 USD	6.0000	Each	
<input type="text" value="Pending"/>	2		Special request item 2		140.00 USD	6.0000	Each	

To approve, deny, or hold requisition lines using the Requisition Approval page:

1. On the Manage Requisition Approvals page, select the Requisition ID link to access the Requisition Approval page. This page displays the lines within one requisition that are pending an approval action.

- In the Line Information group box, select one or more requisition lines by selecting the check box next to the line. You can also use the Select All option. You can only take action on lines that are in the pending status.
- Enter comments in the Enter Approver Comments section at the bottom of the page. A comment is required before you can deny or hold a requisition line. Only one comment is allowed per save.
- Click the **Approve**, **Deny**, or **Hold** button.

This example illustrates the fields and controls on the The Requisition Approval page (partial page). You can find definitions for the fields and controls later on this page.

Requisition Approval

Business Unit US100
 Requisition ID 000000072
 Requisition Name 000000072
 Requester Kelly Jones
 Entered on 01/10/2013
 Status Pending
 Priority Medium
 Budget Status Not Checked

Total Amount 37,560.34 USD

Requester's Justification
 No justification entered by requester.

[Edit Requisition](#) [View printable version](#)

Line Information ?

Line Information Personalize | Find | | First 1-5 of 5 | Last

Line	Item Description	Supplier Name	Quantity	UOM	Price	USD
<input type="checkbox"/>	1 Freight Expense		10.0000	EA	120.00000	USD
<input checked="" type="checkbox"/>	2 Desktop CPU 450Mhz, 128 Mb R...	FRENCH OPS-001	10.0000	EA	1,156.36000	USD
<input checked="" type="checkbox"/>	3 Laptop CPU 450Mhz, 64Mb RAM...	FRENCH OPS-001	10.0000	EA	1,156.36000	USD
<input checked="" type="checkbox"/>	4 Desktop CPU 450Mhz, 128 Mb R...	AXIS-SYSTEM-001	10.0000	EA	1,123.32000	USD
<input type="checkbox"/>	5 5 Years Warranty Extension...	PC-PRO-001	10.0000	EA	200.00000	USD

Select All / Deselect All

[View Line Details](#) Approve Deny Hold

Note: If commitment control is turned on for approvals in PeopleSoft Purchasing, then you must add a row to the Source Transactions component. From the Source Transactions component, select the **Source Transaction Type** of *REQ_PREENC*, and click the Selection Criteria tab. Add a row with a **Field Name** of *REQ_STATUS*, and a **Field Value** of *LA*.

Pushing Back Requisitions

To pushback a requisition line, access the Requisition Approval page and:

- Select a line that is pending the approval.
- Enter comments in the Enter Approver Comments section. This is required before pushing back the requisition.
- Click the **Pushback** button in the Line Information section. To push back the entire requisition, use the pushback button under the Enter Approve Comments section.

Note: Requisition line approval appears as the **Pushback** button at the Line Information section.

Insert Ad Hoc Approvers

To insert ad hoc approvers and reviewers, go to the Requisition Approval page and click the plus + icon for a pending requisition line. The Insert additional approver or reviewer window appears for you to select the user ID and to indicate whether the person is an ad hoc approver or reviewer for this line.

You cannot change ad hoc approvers or reviewers; however, you can delete and add them again to indicate whether they are approvers or reviewers. To delete an approver or reviewer, click the minus – icon. To add multiple approvers or reviewers, click + at the point where you want the additional approver or reviewer to receive the approval.

Use the **Ad Hoc User List** field on the Configure Transactions page to limit the users that can be added as ad hoc approvers and reviewers. If this field is left blank, then any active user can be added as an ad hoc approver or reviewer.

When you click the + icon on the Review/Edit Approvers section of the Requisition Approval page, the following window appears:

This example illustrates the fields and controls on the Insert additional approver or reviewer page. You can find definitions for the fields and controls later on this page.

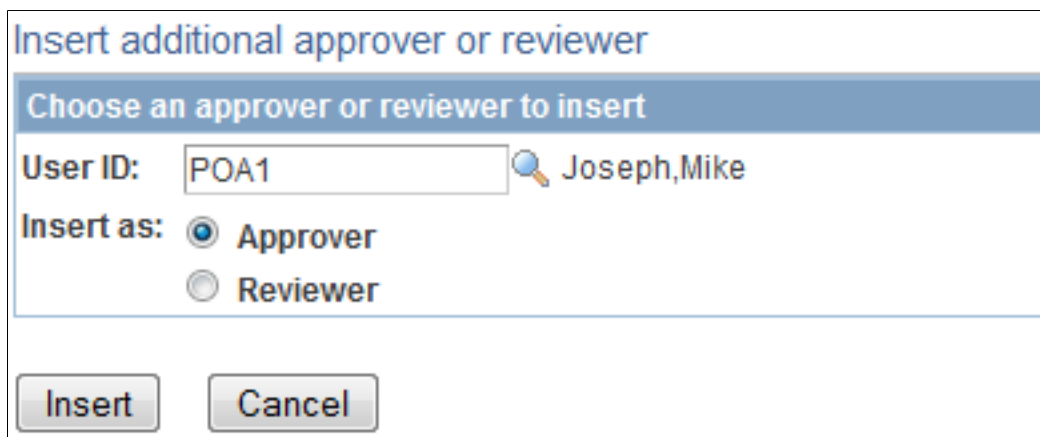

The screenshot shows a dialog box titled "Insert additional approver or reviewer". At the top, there is a blue header bar with the text "Choose an approver or reviewer to insert". Below this, the "User ID:" field contains the text "POA1" and a magnifying glass icon. To the right of the magnifying glass, the text "Joseph, Mike" is displayed. Below the "User ID:" field, the "Insert as:" section has two radio buttons: "Approver" (which is selected) and "Reviewer". At the bottom of the dialog box, there are two buttons: "Insert" and "Cancel".

This example illustrates the fields and controls on the Review/Edit Approvals section after an ad hoc approver has been added (partial page). You can find definitions for the fields and controls later on this page.

▼ **Review / Edit Approvers**

Commodity/Category Approval

Line 1: Pending

Apple iMac Core 2 Duo 2.5GHz 24" Widescreen Desktop

View/Hide Comments

Start New Path

Route to Hardware Approver

✓

Approved

Tiffany Irving
Hardware Buyer
01/18/13 - 9:20 AM

⚠

Skipped

Calvin Roth
Hardware Buyer
01/18/13 - 9:17 AM

🕒

Pending

Multiple Approvers
Hardware Buyer

👁

Reviewer

Mary Lewis
Reviewer

Not Routed -

Brenda Arden
Inserted Approver

Pages Used to Approve Requisitions With Approval Framework

<i>Page Name</i>	<i>Definition Name</i>	<i>Usage</i>
Manage Requisition Approvals Page	PV_APP_MAN_PG	View and take action on requisitions that require your approval or requisitions that previously required your approval.
Requisition Approval Page	PV_REQ_APPROVAL	Perform approval tasks on one individual requisition. You can view requisition details, enter comments, add ad hoc approvers and reviewer, as well as approve, deny, or hold a requisition line.
Requisition Line Details Page	None	View details about requisition line items.

Copyright © 1988, 2024, Oracle and/or its affiliates.

667

Page Name	Definition Name	Usage
<u>Requester's Workbench Page</u>	REQ_RC_WB	Submit requisitions into the approval workflow process by selecting the requisitions and then clicking the Approve button. Requisitions can also be unapproved.

Manage Requisition Approvals Page

Use the Manage Requisition Approvals page (PV_APP_MAN_PG) to view and take action on requisitions that require your approval or requisitions that previously required your approval

Navigation:

Purchasing > Requisitions > Manage Requisition Approvals

This example illustrates the fields and controls on the Manage Requisition Approvals page. You can find definitions for the fields and controls later on this page.

Manage Requisition Approvals

Search Requisitions

To locate requisitions that require your approval (or requisitions that previously required your approval), edit the criteria below and click the Search button.

Requisition ID <input type="text"/>	Requisition Name <input type="text"/>
Business Unit <input type="text"/>	*Status Pending
Date From <input type="text"/>	Date To <input type="text"/>
Requester <input type="text"/>	Entered by <input type="text"/>

[Show Advanced Search](#)

Requisitions

To approve or deny one or more pending requisitions, select the appropriate action from the dropdown and click submit. To view the complete details of a requisition, click the Requisition ID link.

Expand All
 Collapse All
 Currency: Approver Requester

Action/Status	Req ID	Requisition Name	Bus. Unit	Date	Requester	Entered By	Total
<input type="checkbox"/> Pending <input type="button" value="v"/>	0000000162	0000000162	US001	01/14/2013	Kenneth Schumacher	Kenneth Schumacher	125.22 FRF
<input type="checkbox"/> Pending <input type="button" value="v"/>	0000000167	0000000167	US001	01/15/2013	Anita Gardner	Anita Gardner	1,252.24 FRF
<input type="checkbox"/> Pending <input type="button" value="v"/>	0000000169	0000000169	US001	01/15/2013	Anita Gardner	Anita Gardner	250.45 FRF





Mark All:
 Approve
 Deny

[Create New Requisition](#)
[Manage Requisitions](#)

The Manage Requisition Approvals page enables you to view and take action on requisitions that require your approval or view requisitions that previously required your approval.

Use the Search Requisitions group box to search for requisitions needing your approval. Requisitions displayed are based on the user ID of the person accessing this page. You can limit the scope and number of requisitions that appear on the page. For example, you can limit the search results to a specific business unit, requester, or approval status. After displaying the requisitions, you can select individual requisitions to review and update.

Field or Control	Description
Requisition ID	Select a specific system-assigned identifier of the requisition that you want to review or maintain. This limits the search results to one specific requisition.
Requisition Name	Select the name of a specific requisition that you want to view or maintain. This is the name the requester assigned to the requisition. If a name was not assigned, the system uses the requisition ID as the name. This limits the search results to one specific requisition.
Business Unit	Select a PeopleSoft Purchasing business unit containing the requisitions that you want to review for approval.
Status	Select a requisition status used by the requisitions that you want to review for approval. Requisitions that appear in the search results are those in the status you select and that meet the other search criteria you enter. Status values are: <i>Approved:</i> Displays all requisitions that you have approved. <i>Denied:</i> Displays all requisitions that you have denied. <i>On Hold:</i> Displays all requisitions that you have placed on hold. <i>Pending:</i> Displays all requisition that are waiting for your action. <i>Pushedback:</i> Displays all requisitions you have pushed back to the previous approver.
Date From and Date To	Select a range of dates to select requisitions to view.
Requester	Select the user who entered the requisitions.
Entered by	Select an operator for which you want to manage requisitions. Operators are people who have created requisitions for someone else. Only the requisitions submitted by this specific operator appear in the list.
Show Advanced Search	Click to display additional search criteria to locate requisitions. Additional fields are Item/Job Title (for item description or job title) and Supplier ID .
Search	Click to initiate your search.
Clear	Click to erase your current search criteria in the Search Requisitions group box.

Field or Control	Description
	Click the Expand All icon to display requisition detail including line and header level information.
	Indicates that there are lines pending approval for the requisition.
Req ID	Click to access the Requisition Approval page, where you can perform approval tasks, such as approve, deny, or hold. In addition, you can add comments and add ad hoc approvers and reviewers.
	Indicates that the requisition has a high priority. Priorities are assigned when the requisition is created or edited.
	Indicates that a specific header or line is pending approval.
Mark All	<p>Use the Mark All row to perform a mass approval action on several requisitions at one time. After using the Mark All row, you must save (submit) the page to perform this action. Possible actions are:</p> <ul style="list-style-type: none"> • Click Approve to mark all displayed requisitions as <i>Approve</i> in the Action/Status field. • Click Deny to mark all displayed requisitions as <i>Deny</i> in the Action/Status field. • Click Hold to mark all displayed requisitions as <i>Hold</i> in the Action/Status field.

Requisition Approval Page

Use the Requisition Approval page (PV_REQ_APPROVAL) to perform approval tasks on one individual requisition. You can view requisition details, enter comments, add ad hoc approvers and reviewer, as well as approve, deny, or hold a requisition line.

Navigation:

- **Purchasing > Requisitions > Manage Requisition Approvals. Click the Requisition ID link.**
- **Worklist > Worklist. For the work item > Approval Routing > click the requisition link on the row.**

This example illustrates the fields and controls on the Requisition Approval page (1 of 3). You can find definitions for the fields and controls later on this page.

Requisition Approval

Business Unit US001
 Requisition ID 0000000174
 Requisition Name 0000000174
 Requester Anita Gardner
 Entered on 01/15/2013
 Status Pending
 Priority Medium
 Budget Status Not Checked

Currency Approver Requester

Total Amount 1,210.70 FRF

Requester's Justification
No justification entered by requester.

[Edit Requisition](#) [View printable version](#)

Line Information Personalize | Find | | First 1 of 1 Last

Line	Item Description	Supplier Name	Quantity	UOM	Price	
1	Long Sleeve Biking Jersey, M...	BIKE-001	10.0000	EA	121.07000	FRF

Select All / Deselect All

[View Line Details](#) Approve Deny

This example illustrates the fields and controls on the Requisition Approval page (2 of 3). You can find definitions for the fields and controls later on this page.

Review / Edit Approvers

Commodity/Category Approval

Line 1: Pending
Apple Macbook Pro Laptop

View/Hide Comments
Start New Path

Route to Hardware Approver

Approved ✔ Tiffany Irving Hardware Buyer 01/17/13 - 4:39 PM	}
Skipped ⚠ Calvin Roth Hardware Buyer 01/17/13 - 4:38 PM	
Pending 🕒 Multiple Approvers Hardware Buyer	
Reviewer 👤 Mary Lewis Reviewer	
Reviewer 👤 Supplier Contract Approver Reviewer	

+

This example illustrates the fields and controls on the Requisition Approval page (3 of 3). You can find definitions for the fields and controls later on this page.

Comments

Brad Bell at 01/18/13 - 9:47 AM
This is okay with me. Wendy, what do you think?

System at 01/18/13 - 9:44 AM
Requester (TIRVING) is approver on step number 1, path 1, stage 10, which has self-approval disabled! (18081,1031)

Fiscal Approval

Line 1: Awaiting Further Approvals View/Hide Comments
Start New Path

Apple Macbook Pro Laptop

Route to Supervisors

Not Routed

Calvin Roth
Supervisor by UserId

→

Not Routed

Kenneth Schumacher
Supervisor by UserId

→

Not Routed

Michael Buhler
Supervisor by UserId

→

Comments

Approval Comments

Use the Requisition Approval page to perform your approval tasks on a single requisition, including:

- Approving one or more requisition lines. The line-level approval can be used only if the process ID is configured for line-level approval on the Register Transactions page.
- Denying one or more requisition lines.
- Placing one or more requisition lines on hold. This action inserts the requester as an ad hoc reviewer and requires you to enter comments to be sent to the requester.
- Pushing back one or more requisition lines. A pushback returns the line to the previous approval step.
- Adding or removing ad hoc approvers or reviewers.
- Reviewing an online requisition that shows the layout of the printed version.
- Making comments to be viewed by other approvers or reviewers.

The page displays details about the requisition, such as the requester, the date it was entered, the requisition name and ID, and the requisition priority. Also appearing is the total monetary value of the requisition and the currency used.

Note: If you select a line that does not require action, you receive a message telling you to select a line that is pending an approval.

Field or Control	Description
Requester	<p>Click to access the Requester Information page. The page displays details about who created the requisition and includes the requester's supervisor and reporting structure, department, email ID, and telephone number.</p> <p>The information displayed can be changed by modifying the approver information view that is registered on the Register Transactions page.</p>
Requester's Justification	<p>Displays any comments the requester entered to justify the need for the requisition.</p>
View printable requisition	<p>Click this link to review an online requisition that shows the layout of the printed version. The requisition opens up as a second window and can be printed. The Oracle BI Publisher is used to generate this report and you can customize it.</p>

Line Information

Use this section of the Requisition Approval page to review requisition line details and perform approval tasks. Line items that are awaiting approval are highlighted and selected as default values when you access the page.

Field or Control	Description
	<p>The Awaiting Approval icon displays with a requisition line to indicate the line is pending approval.</p>
Item Description	<p>Click this link to view details about an item contained on a requisition. As you review approvals, you can see the item details and an image of the item.</p>
Requester's Comments	<p>Click to review comments made by the requester about a requisition line item.</p>
Select All/Deselect All	<p>Click to either select all line items or to clear all line item check boxes. You can select this check box to approve, deny, or hold all lines or select individual check boxes to for single lines.</p>
View Line Details	<p>Click to access the Requisition Line Details page where you can view details about the requisition line items that you selected.</p>

Field or Control	Description
Approve	Click to approve the selected requisition line items. When you approve a line- or header-level item, the system routes the requisition line to the next approver and updates the approval status for the line.
Deny	Click to deny the selected requisition line items. Before the system accepts a denial, you must enter comments indicating why you did not approve the lines.
Hold	Click to put the selected requisition lines on hold. You must enter a comment that is sent to the requester. The requester is added as an ad hoc reviewer to this approval step.
Pushback	Select Pushback to return an approved requisition back to the previous approver or the requester with comments. This is possible only if there was a previous approver in the same path. You cannot push back a requisition across stages.

Review/Edit Approvers

Use this section of the Requisition Approval page to review the approval flow, such as who approved the requisition before you and who will approve it after you. Click the plus + symbol to insert ad hoc approvers and reviewers. If you want to remove an ad hoc approver or reviewer click the minus — symbol.

All qualified ad hoc approvers or reviewers must be defined as part of the **Ad Hoc User List** on the Configure Transactions page.

Enter Approver Comments

Use this section to enter comments about the requisition. If you deny a requisition, the system requires that you enter a comment.

Requisition Line Details Page

Use the Requisition Line Details page (None) to view details about requisition line items.

Navigation:

Select one or more lines.

Click the **View Line Details** button on the Requisition Approval page.

This example illustrates the fields and controls on the Requisition Line Details page. You can find definitions for the fields and controls later on this page.

Business Unit: US001	Requester: PATRICKSANCHEZ	Status: Pending Approval					
Requisition: 0000000169	Requested By: Anita Gardner	Currency: FRF					
Requisition Name: 0000000169	Entered Date: 1/15/13	Requisition Total: 40.00					
Line: 1	Item Description: Long Sleeve Biking Jersey, Men's	Quantity: 2.0000					
		UOM: EA					
		Price: 20.00					
		Line Total: 40.00					
		Line Status: Pending					
Ship Line: 1	Ship To: US001	Address:					
Attention: Anita Gardner	Due Date:	144 North Street					
		New York NY 10168					
		United States					
		Shipping Quantity: 2.0000					
		Shipping Total: 40.00					
Dist	Status	Location	Qty	PCT	Amount	GL Unit	Account
1	Open	US001	2.0000	100.00	40.00	US001	131000
Dept							
13000							
Open QTY		Open Amt					
2.0000		0.000					
GL Base Amount	Currency	Sequence					
40.00	USD	0					

Use this page to review shipping and accounting details for line items that you selected to review using the Requisition Approval page.

Approving Requisitions With PeopleTools Workflow Technology

This section provides an overview of approving requisitions using the PeopleTools Workflow Technology.

Pages Used to Approve Requisitions With PeopleTools Workflow Technology

Page Name	Definition Name	Usage
Requisitions - Approval Workflow Page	REQ_APPR_WF	<p>Run the Requisition Amount Approval Application Engine process (PO_WFREQAMT) to submit requisition amounts for approval using workflow.</p> <p>Run the Requisition ChartField Approval Application Engine process (PO_WFREQCF) to submit requisition ChartFields for approval using workflow.</p> <p>When using the batch Requisition Amount Approval and Requisition ChartField Approval processes, these processes do not look to verify who is logged in when running the process, therefore the User ID is irrelevant. Instead, these processes look to the requestor on the requisition to see if they have approval authority.</p>

Page Name	Definition Name	Usage
<u>Requisition Amount Approval Page</u>	REQ_APPROVAL_AMT	Approve, deny, or recycle a requisition. You can also view details for amount approvals on this page. If you have a requisition approval role in workflow, you can access this page when you select a requisition from your worklist.
Currency Information Page	EXCH_RT_DTL_INQ	View the rules used to calculate exchange rates for the transaction. <u>Requisition Amount Approval Page</u>
Item Description Page	REQ_ITM_DESCR	View descriptions for a specific item. <u>Requisition Amount Approval Page</u>
<u>Requisition ChartField Approval Page</u>	REQ_APPROVAL_CHRT	Approve, deny, or recycle a requisition based on the ChartFields that appear. You can also view details for ChartField approvals. If you have a requisition approval role in workflow, you can access this page when you select a requisition from your worklist.

Understanding Requisition Approvals With PeopleTools Workflow Technology

PeopleTools Workflow Technology requisition approvals are available in two areas. You can require approval of one or both of the following:

- Requisition amounts.
- Requisition ChartFields.

There are two types of approval methods:

- Automatic approvals.
- Workflow approvals.

When you use the PeopleTools Workflow Technology approval method, requisitions are approved using workflow roles, rules, and routings. To implement workflow approvals, define the roles, rules, and routings using the Workflow component. Your system is delivered with basic approval rules already established.

This table lists the requisition save statuses that result from all possible setup configurations:

Approval Method	Requester with Approval Authority	Requester's Req Status Setting	Requisition Save Status
Automatic	Yes	<i>Pending</i>	<i>Approved</i>
Automatic	Yes	<i>Open (not recommended)</i>	<i>Open</i>
Automatic	No	<i>Pending</i>	<i>Pending</i>
Automatic	No	<i>Open</i>	<i>Open</i>
Workflow	Yes	<i>Pending</i>	<i>Pending</i>
Workflow	Yes	<i>Open (not recommended)</i>	<i>Open</i>
Workflow	No	<i>Pending</i>	<i>Pending</i>
Workflow	No	<i>Open</i>	<i>Open</i>

When you save a requisition and the system is set up so that the requisition status has the default value set to *Pending/Approved*, or when you select the **Approve** status on the Maintain Requisitions - Requisition page, workflow verifies that you have the authority to approve the requisition.

If you do not have the authority to approve the requisition, workflow notifies the approver at the next level in the approval hierarchy that a requisition needs approval and adds the requisition to that approver's worklist. PeopleTools Workflow Technology routes the requisition until it reaches an approver with proper approval authorizations.

You can set up PeopleTools Workflow Technology to search automatically for requisitions that require approval and to move those requisitions to the appropriate users for approval.

Even if you chose to use workflow approvals, you still have the option not to invoke workflow and instead use online approval pages to approve requisitions manually.

You can use either of the following methods to send requisitions into PeopleTools Workflow Technology:

- Use the PeopleSoft Application Engine processes.

PeopleSoft Requisition Amount Approval process and the Requisition ChartField Approval process use queries to determine which requisitions are eligible for workflow routings and approvals. To be eligible, a requisition must have a status of *Pending Approval* and the approval status on the requisition approval table must be *Initial*. The requisition approval table tracks the approval status.

For eligible requisitions, the Requisition Amount Approval process sets statuses on the approval table to *In Process*, and the first worklist entries are created for the requisition. The requisition is now in workflow. The status remains as *Pending Approval*, until the requisition completes its workflow cycle and the status changes to *Approved*.

- Perform manual steps on the requisition approval pages.

If the requisition requires workflow approval, setting the requisition status to *Approved* on the Requisition Amount Approval page and the Requisition ChartField Approval page changes the status on the requisition approval table to *In Process*, which triggers workflow approval.

You can also use the Requester's WorkBench or Maintain Requisitions - Requisition page to perform online requisition approvals.

Using Automatic Approvals

When you use the automatic approval method, requisitions are automatically approved when they are saved by a user with proper authorizations. If a requester saves a requisition without proper authorizations, the status changes to the requester's default requisition save status, either *Open* or *Pending*. The requisition must be manually accessed and approved by a qualified requester using the Approve Amounts and Approve ChartFields components.

If you choose to use automatic approvals, you must use the Workflow component to assign approval roles to your buyers and requesters. This involves determining whether you need a system of multi-level approvals or just specific users who have the authority to approve everything. If you decide to use workflow-based approvals later, your basic infrastructure is already in place.

Example of Approving a Requisition

You have the authority to approve a requisition up to 1,000.00 USD, your supervisor can approve requisitions up to 10,000.00 USD, the manager can approve requisitions up to 100,000.00 USD, and the president of your organization has the authority to approve requisitions of any amount.

You enter a requisition to purchase new computers for the entire organization and the requisition amount totals 1,000,000.00 USD. Because you don't have the authority to approve a requisition of this amount, workflow moves this requisition to your supervisor's worklist and notifies your supervisor that a requisition needs her approval. She approves the requisition, but because she doesn't have the authority to approve this amount, workflow moves the requisition to the manager's worklist and notifies the manager that a requisition needs his approval now. He approves the requisition, but because he doesn't have the authority to approve a 1,000,000.00 USD requisition, workflow moves the requisition to the president's worklist and notifies her that a requisition needs her approval. She reviews the transaction requisition and approves the requisition amount.

If you are the approver, you can manually approve, recycle, or deny requisitions on the Approve Amounts - Approval page and Approve ChartFields - Approval page.

You can also set up workflow, so that activities are routed directly to the person with the proper authority, bypassing the incremental routing process up the chain of authority. In the previous example, workflow could have routed the activity directly to the president of the organization, because she is the only one with authority to approve the activity.

This table lists the workflow notification events and workflow business process names that are related to approving requisitions:

Workflow Notification Event	Workflow Notification Type	Business Process Name
Notify approver when a requisition needs approval.	Worklist	Requisition Approvals

Workflow Notification Event	Workflow Notification Type	Business Process Name
Notify requester that requisition has been approved or denied.	Email	REQ_NOTIFICATION
Notify previous approver that requisition has been denied or recycled.	Worklist and email (denied) Worklist (recycled)	Requisition Approvals

See the product documentation for *PeopleTools: Workflow Technology*

Related Links

[Maintain Requisitions - Requisition Page](#)

[Setting Up the Approval Framework for PeopleSoft Purchasing](#)

[Understanding the Requester's Workbench](#)

Requisition Amount Approval Page

Use the Requisition Amount Approval page (REQ_APPROVAL_AMT) to approve, deny, or recycle a requisition.

You can also view details for amount approvals on this page. If you have a requisition approval role in workflow, you can access this page when you select a requisition from your worklist.

Navigation:

Purchasing > Requisitions > Approve Amounts Req

This example illustrates the fields and controls on the Requisition Amount Approval page. You can find definitions for the fields and controls later on this page.

The screenshot shows the 'Requisition Amount Approval' page with the following details:

- Unit: US001, Req: 0000000013, Requester: Kenneth Schumacher
- *Approval Action: Approve (dropdown), Approval Status: Initial
- View Printable Req button
- Comment section with a text area and icons
- Amount Details section:
 - Requisition Date: 01/15/2003
 - Total Amount: 20.000 Dollar
 - Total Base Amount: 20.000 Dollar
- Line Details section:

Line	Sched	Status	Merchandise Amt	Currency	Merch Amt Base	Base Currency	Req Qty	UOM	Revision
1	1	Active	20.00	USD	20.00	USD	1.0000	EA	

Field or Control	Description
Appr Act (approval action)	<p>Select one of the following actions. If you do not have the authority to complete the approval or if you deny or recycle the requisition, the value in the Approval Status field remains <i>In Process</i> and routes to the next role user in the approval definition. Values are:</p> <p><i>Approve</i>: Select to approve the requisition amount or ChartField. If you have the authority to complete the approval, the approval status changes to <i>Complete</i> when you save this page. If workflow is implemented, the system sends an email to the requester stating that the requisition has been approved.</p> <p><i>Deny</i>: Select to send the requisition back to the requester. If workflow is implemented, the system adds the requisition to the requester's worklist and sends the requester an email notification. The requisition approval status changes to <i>Denied</i>.</p> <p><i>Recycle</i>: Select to send the requisition back to the last user who approved the requisition. If workflow is implemented, the system adds the requisition to the user's worklist and sends the user an email notification.</p>
Approval Status	Displays the overall status of the requisition.
View Printable Req (view printable requisition)	Click to launch the Requisition Print SQR (requisition print structured query report) process (PORQ010), where you can view additional details about the requisition. This process opens the resulting requisition print PDF file directly to the user's desktop if a REN server is configured.
Comment	Enter comments pertinent to your approval action. These comments are saved with the requisition and are visible only on the originating page (the Approve Amounts - Approval page or Approve ChartFields - Approval page).

Amount Details

The amounts that appear are the amounts that you are to approve. You can change these values on the Maintain Requisitions - Requisition page and Maintain Requisitions - Schedule page.

Line Details - Amounts/Qty Tab

Field or Control	Description
Amount	Displays the price of the items on the requisition line.
Base Amt (base amount)	Displays the price of the items on the requisition line expressed in the base currency.

Field or Control	Description
Revision	Displays the manufacturer product revision number for the ordered item. If the ship to is an inventory business unit, and the item is under revision control in that business unit, the revision automatically defaults to that effective on the due date.

Line Details - Details Tab

Select the **Details** tab.

Field or Control	Description
Price Tol /Price Tol Under (price tolerance/price tolerance under)	Displays the over and under price tolerance amount for the selected requisition line.
% Prc Tol /% Prc Tol Under (price tolerance percentage/ price tolerance under percentage)	Displays the over and under price tolerance percentage for the selected requisition line.
RFQ Required (request for quote required)	Designates whether the purchase of this requisition line item requires an RFQ.

Related Links

[Maintain Requisitions - Requisition Page](#)

[Maintain Requisitions - Schedule Page](#)

Requisition ChartField Approval Page

Use the Requisition ChartField Approval page (REQ_APPROVAL_CHRT) to approve, deny, or recycle a requisition based on the ChartFields that appear.

You can also view details for ChartField approvals. If you have a requisition approval role in workflow, you can access this page when you select a requisition from your worklist.

Navigation:

Purchasing > Requisitions > Approve ChartFields Req

This example illustrates the fields and controls on the Requisition ChartField Approval page. You can find definitions for the fields and controls later on this page.

Requisition ChartField Approval

Unit US001 Req 000000013 Requester Kenneth Schumacher

*Approval Action Approval Status Initial [View Printable Req](#)

Comment

Distributions/ChartFields Personalize | Find | View All | [Print](#) First 1 of 1 Last

Line	Sched	Distrib	Status	GL Unit	Account	Alt Acct	Oper Unit	Fund	Dept	Program	Class	Bud
1	1	1	Open	US005	600020			F900	11000	P7000		

Line Details Personalize | Find | [Print](#) First 1 of 1 Last

Line	Sched	Status	Merchandise Amt	Currency	Merch Amt Base	Base Currency	Req Qty	UOM	Revision
1	1	Active	20.00	USD	20.00	USD	1.0000	EA	

[Save](#) [Return to Search](#) [Previous in List](#) [Next in List](#) [Notify](#)

Field or Control	Description
Appr Act (approval action)	<p>Select one of the following actions. If you do not have the authority to complete the approval or if you deny or recycle the requisition, the value in the Approval Status field remains <i>In Process</i> and routes to the next role user in the approval definition. Values are:</p> <p><i>Approve</i>: Select to approve the requisition amount or ChartField. If you have the authority to complete the approval, the approval status changes to <i>Complete</i> when you save this page. If workflow is implemented, the system sends an email to the requester stating that the requisition has been approved.</p> <p><i>Deny</i>: Select to send the requisition back to the requester. If workflow is implemented, the system adds the requisition to the requester's worklist and sends the requester an email notification. The requisition approval status changes to <i>Denied</i>.</p> <p><i>Recycle</i>: Select to send the requisition back to the last user who approved the requisition. If workflow is implemented, the system adds the requisition to the user's worklist and sends the user an email notification.</p>
Approval Status	Displays the overall status of the requisition.
View Printable Req (view printable requisition)	Click to launch the Requisition Print SQR (requisition print structured query report) process (PORQ010), where you can view additional details about the requisition. This process opens the resulting requisition print PDF file directly to the user's desktop if a REN server is configured.

Field or Control	Description
Comment	Enter comments pertinent to your approval action. These comments are saved with the requisition and are visible only on the originating page (the Approve Amounts - Approval page or Approve ChartFields - Approval page).

Distributions/ChartFields

These are the ChartField values that you are to approve. You can change these values on the Maintain Requisitions - Requisition page and Maintain Requisitions - Distributions page.

Related Links

[Maintain Requisitions - Requisition Page](#)

[Maintain Requisitions - Schedule Page](#)

[Requisition ChartField Approval Page](#)

Tracking Requisition Changes

Understanding Requisition Change Tracking

After you create a requisition, you can track changes for the requisition. PeopleSoft Purchasing provides an audit trail to track changes made after a requisition has been approved, budget checked, or sourced to a purchase order, request for quote, or material stock request.

This section discusses how to:

- Track requisition changes.
- Review requisition change history.

Note: When you create a change template for tracking requisition changes, you can use it for tracking changes in PeopleSoft eProcurement, Services Procurement, and Purchasing. For more information about tracking changes in these applications, see the *PeopleSoft eProcurement 9.2*.

See “Understanding Requisition Changes and Change Requests” (PeopleSoft eProcurement).

Pages Used to Track Requisition Changes

Page Name	Definition Name	Usage
<u>Maintain Requisitions - Requisitions Page</u>	REQ_FORM	Create and update requisitions online.
Change Reason Page	REQ_CHNG_REASON	Enter a reason code for changing a requisition. Requisition change tracking is enabled on the Req Change Options page for the PeopleSoft Purchasing business unit. When you make a change to the requisition and the fields that you change are defined for change tracking, the Change Reason page appears when you save the requisition.

Maintain Requisitions - Requisitions Page

Use the Maintain Requisitions - Requisitions page (REQ_FORM) to create and update requisitions online.

Navigation:

Purchasing > Requisitions > Add/Update Requisitions > Maintain Requisitions - Requisition

To create a tracked requisition change:

1. Use the Maintain Requisitions - Requisition page in Update/Display mode, and select the requisition that you want to change.

Depending on the value established for the business unit's purchasing options, you can also track the changes for requisitions after they have been approved or after they have been sourced or budget checked.

2. Click the **Create Header Change**, **Create Line Change**, or **Create Schedule Change** button.

The system makes available the fields that are defined on the Change Template page. The button is located on the Maintain Requisitions - Requisitions for header changes. For line changes, click the **Line Details** link and the button appears on the Details for Line page for each line. For schedules, the button is available for each line on the Schedule page.

3. After you make the change, the system displays the **Track Changes** field and increments the change for this requisition by one.

You can change fields that are not included on the change template at any time, but the system does not track the changes. You can also view the current change reason code and use the *Change History* option in the **Go To** field to view a history of tracked changes.

Related Links

“Creating Change Templates” (PeopleSoft Source to Settle Common Information)
[Creating Requisition Header Information](#)

Reviewing Requisition Change History

You can access and review a history of requisition changes generated for specific requisitions. The system displays only the fields that were changed for each tracked changes and the original values for all of the eligible fields for the header, line, or schedule.

This section lists the pages used to review requisition change history.

Pages Used to Review Requisition Change History

<i>Page Name</i>	<i>Definition Name</i>	<i>Usage</i>
Batch Page	REQ_CHANGE_BATCH	View requisition change history batch.
Header Page	REQ_CHANGE_HDR	View requisition change header history.
Line Page	REQ_CHANGE_LINE	View requisition change line history.
Ship Page	REQ_CHANGE_SHIP	View requisition change ship history.

Using the Requester's Workbench

Understanding the Requester's Workbench

You can use the Requester's Workbench to retrieve, review, and modify multiple requisitions for the purpose of performing these functions:

- Updating a requisition.
- Resetting the approval status of a requisition.
- Approving a requisition.
- Canceling a requisition.
- Closing a requisition.
- Inquiring about a requisition.

Related Links

[Creating Requisition Header Information](#)

[Creating Requisition Lines](#)

[Entering Distribution Information](#)

Prerequisites

You must have the authority to perform the actions that you specify against the requisitions that you retrieve and select. Set up this authority on the User Preferences: Procurement - Requisition Authorizations page.

Related Links

[“User Preferences – Requisition Authorizations Page” \(Application Fundamentals\)](#)

Using the Requester's Workbench

This section discusses how to use the Requester's Workbench

Pages Used to Use the Requester's Workbench

Page Name	Definition Name	Usage
Requester's Workbench - Filter Options Page	REQ_RC_WB_SRCH	Search for requisitions.
Requester's Workbench Page	REQ_RC_WB	Use the Requester's Workbench to analyze, approve, disapprove, cancel, and close requisitions.
Requisitions Page	REQ_INQ_LOOKUP	View the information associated with the requisition. Requester's Workbench Page
REQ DOC Status Page	PRCR_DOCSTAT_INQ	View the requisition document status inquiry. Requester's Workbench Page
Requester's Workbench - Requisition Lines Page	REQ_RC_WB_LN	View requisition lines that are associated with the selected requisition.
Requester's Workbench - Requisition Schedules Page	REQ_RC_WB_SCHD	View requisition schedules that are associated with the selected requisition.
Requester's Workbench - Requisition Distributions Page	REQ_RC_WB_DISTRIB	View the distribution associated with the selected requisition. Requester's Workbench Page
Requester's Workbench - Processing Results Page	REQ_RC_WB_RSLT	View processing results returned when you take an action on selected requisitions.
Requester's Workbench - Processing Log Page	REQ_RC_WB_MSG	View the message text stating why a requisition was not qualified for processing. Requester's Workbench - Processing Results Page

Requester's Workbench - Filter Options Page

Use the Requester's Workbench - Filter Options page (REQ_RC_WB_SRCH) to search for requisitions

Navigation:

Purchasing > Requisitions > Requester's Workbench > Requester's Workbench - Filter Options

This example illustrates the fields and controls on the Requester's Workbench - Filter Options Page. You can find definitions for the fields and controls later on this page.

Requester's Workbench
Filter Options

Business Unit US001 WorkBench ID GRFGH

Description

Enter search criteria and click on Search. Leave blank for all values.

Search Criteria

Requisition To

Requisition Name

Req Date Until

Activity Date To

Due Date To

Supplier ID

Item ID

Requester

Status

Open Approved Lines Approved

Pending Appr Canceled Denied

Sourcing

Partially or Fully Sourced

Encumbrance

Open Pre-encumbrances

ChartFields Personalize | Find | View All | First 1 of 1 Last

Chartfields	GL Unit	Account	Alt Acct	Oper Unit	Dept	Program	Class	Fund	Bud R
	<input type="text"/>	<input type="text"/>	<input type="text"/>	<input type="text"/>	<input type="text"/>	<input type="text"/>	<input type="text"/>	<input type="text"/>	<input type="text"/>

 [Return to Requester's Workbench](#)

This example illustrates the fields and controls on the Requester's Workbench - Filter Options page (2 of 2). You can find definitions for the fields and controls later on this page.

Encumbrance

Open Pre-encumbrances

ChartFields Personalize | Find | View All | First 1 of 1 Last

Chartfields	GL Unit	Account	Alt Acct	Oper Unit	Dept	Program	Class	Fund	Bud R
	<input type="text"/>	<input type="text"/>	<input type="text"/>	<input type="text"/>	<input type="text"/>	<input type="text"/>	<input type="text"/>	<input type="text"/>	<input type="text"/>

 [Return to Requester's Workbench](#)

You use this page to define the criteria that you want to use to retrieve requisitions. To save time and resources, consider entering selection criteria to reduce the number of records retrieved. This strategy

is especially useful in a high-volume environment. In addition, keep in mind that the workbench can be saved, and the saved criteria is reusable.

Search Criteria

You can search for a specific requisition or use additional fields in this section to limit requisition filter values to a specific item or range of dates.

<i>Field or Control</i>	<i>Description</i>
Requester	Select the requester who created the requisitions. After you select the requester and if the requester uses procurement cards, the Card Number field becomes available.
Card Number	Select the procurement card number associated with the requisitions.

Status

Select the check boxes that correspond to status' that you want the system to retrieve during the search. The check boxes limit the number of retrieved requisitions to only those you select. If you do not select a status, the system retrieve requisitions in all statuses that also meet other search criteria that you enter

<i>Field or Control</i>	<i>Description</i>
Pending Appr	<p>Select this check box to select requisitions that are in a status of pending approved. You can cancel requisitions that are in a pending approved status.</p> <p>When you select the Pending Appr checkbox an additional field becomes visible, which allows filtering of Requisitions based on number of days a requisition is pending for Approval. On entering value for this field, requisition's which have been pending for approval with an Approver greater than the number of days entered is selected when you click the Search button.</p> <hr/> <p>Note: The Pending Approval checkbox and No of day's field will be made available if AWE is enabled in Business unit option for the BU and the no of days field will be available when AWE is enabled and the Pending approval is checked. When Accessibility mode is enabled, the no of days will be always be available irrespective of the pending approval selection.</p> <hr/>

Sourcing

<i>Field or Control</i>	<i>Description</i>
Partially or Fully Sourced	Select this check box to view requisitions for which one or more lines on a requisition have been sourced to a purchase order.

Encumbrance

<i>Field or Control</i>	<i>Description</i>
Open Pre-encumbrances	<p>If you are using commitment control, the Open Pre-encumbrances check box appears as a search parameter. This check box enables you to search for requisitions that are tied to purchase orders with an open balance.</p> <p>When you use commitment control, the system deducts each type of financial obligation from the budget and tracks it according to obligation type. When you generate a requisition, a pre-encumbrance is created in your budget records by the budget-checking process. When a requisition is sourced to a purchase order, commitment control liquidates the pre-encumbrance from the requisition and establishes an encumbrance for the purchase order.</p>

ChartFields

You can enter multiple ChartField combinations as search criteria. For example, you can search for requisitions in **GL Unit** US001 and **Account** 50000, as well as US005 and Account 1200.

Click **Search** to retrieve the selected information and have it appear on the Requester's Workbench page.

Related Links

“Understanding PeopleSoft ChartFields” (Application Fundamentals)

Requester's Workbench Page

Use the Requester's Workbench page (REQ_RC_WB) to use the Requester's Workbench to analyze, approve, unapprove, cancel, and close requisitions.

Navigation:

Click the **Search** button on the Requester's Workbench - Filter Options page.

This example illustrates the fields and controls on the Requester's Workbench page. You can find definitions for the fields and controls later on this page.

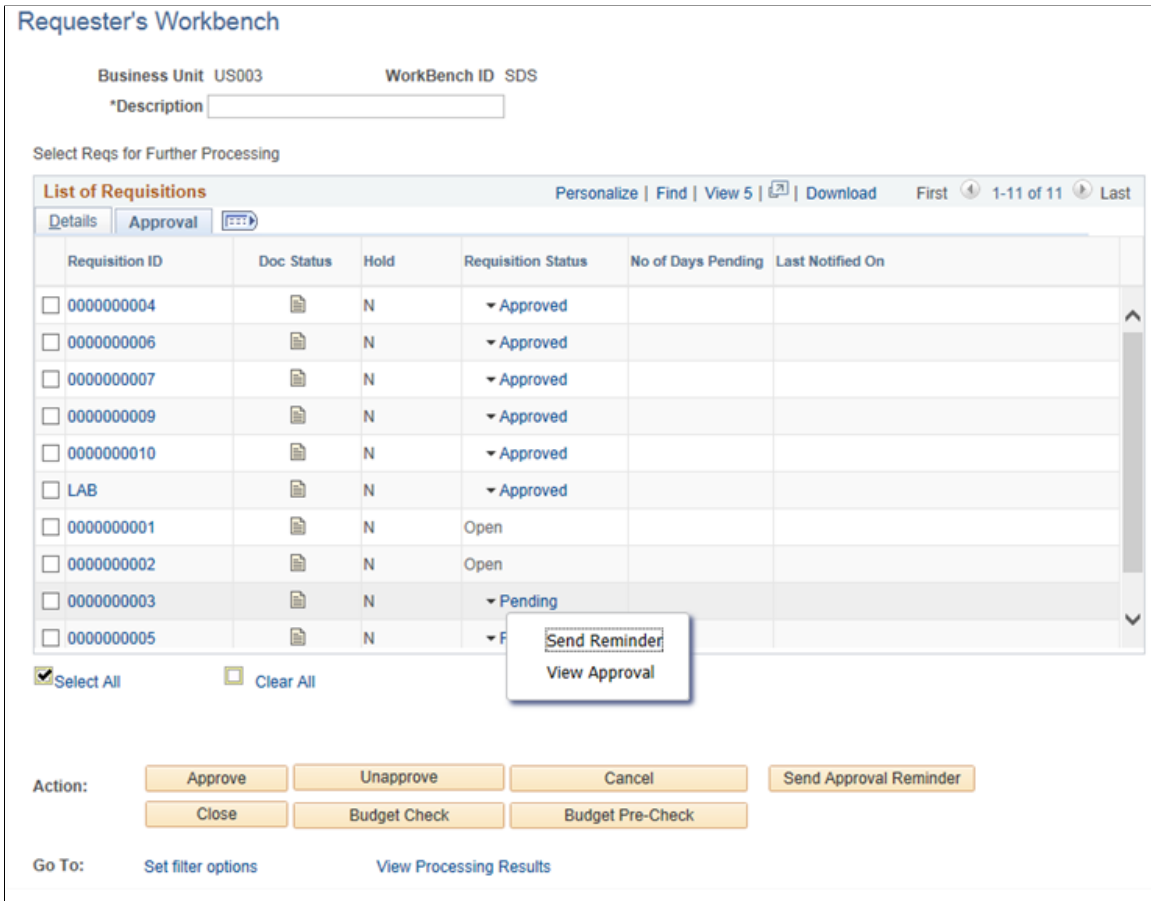

You use the Requester's Workbench to maintain requisitions that were returned using the search criteria that you entered. You can select a single or multiple requisitions to maintain. After selecting the requisition, click an action to start processing the requisitions. The system displays the Processing Results page, where you can select to proceed with the action.

Field or Control	Description
Description	Enter a description for the workbench. The first time in the workbench, you must enter a description before you can save the workbench.
Requisition ID	Click a linked requisition ID to access the corresponding Requisitions inquiry page.
	Click the Doc Status icon for the selected requisition to access the Requisition Document Status inquiry page for the requisition.

Field or Control	Description
Change Order	Displays the change order batch number. Change order numbers identify the batches of changes that you make to a requisition. Select the <i>Y</i> value to access the Change History - Batch page. Using this page, you can view the change request or change order history for the requisition.
	Click the Lines icon for the selected requisition to access the Requester's Workbench - Requisition Lines page.

Click one of the following buttons to perform actions on the requisitions that you have selected for processing:

Field or Control	Description
Approve	Click to change the status of the selected requisitions to Approved.
Unapprove	Click to change the status of the selected requisitions to Open.
Cancel	Click to cancel the selected requisitions and all lines.

Note: When canceling requisitions, the system does not create change orders. If change order tracking is required for canceled requisitions, you must cancel requisitions individually through the Add/Update Requisitions component.

Field or Control	Description
Close	<p>Click to close the selected requisitions from further processing. To override requisitions that are not qualified and make them available for closing, select the requisition IDs and click the Override button.</p> <p>To give a user the authority to override nonqualified requisitions, click the Override Non-Qualified Requisitions for Close check box on the User Preferences - Procurement: Requisition Authorizations page.</p> <p>Requisitions that are associated with purchase orders that have not yet been closed will not be qualified for override. If you are using commitment control, you will not be able to close requisitions that are associated to purchase orders unless the purchase orders are closed and have been successfully budget checked.</p> <p>See “User Preferences – Requisition Authorizations Page” (Application Fundamentals).</p>
Save	Click to save the selected requisitions.

Field or Control	Description
Budget Check	<p>Click to initiate the Commitment Control Budget Processor process for the selected requisitions. This button is available if commitment control is enabled for PeopleSoft Purchasing.</p> <p>When you click the Budget Check button, the Processing Results page appears, where you can review the selected requisitions and select to proceed with processing for the requisitions.</p>

Field or Control	Description
Budget Pre-Check	<p>Click to check the budget only. This button enables you to check whether a budget exists for a requisition before the amount is committed to the pre-encumbrance or encumbrance and makes it possible to validate documents in work-in-progress mode without affecting budget balances. When performing budget pre-check only processing, the Budget Processor performs all of its budget checking and edits but does so without committing changes to the ledger or other records. The statuses of <i>Provisionally Valid</i> and <i>Error</i> on the transaction pages indicate whether a budget is available. If you click the button and if the budget check is valid, then the system sets the budget header status for the requisition to <i>Prov Valid</i>. If the budget check is not valid, then the system sets the budget header status to <i>Error</i> with a link to the Exception page.</p> <p>The button is visible only if the Purchasing check box is selected in the Enable Commitment Control section on the Installation Options - Products page and the Purchasing check box is selected in the Enable Budget Pre-check section on the Installation Options - Commitment Control page. The button is not visible if the budget status is <i>Valid</i>.</p>

Field or Control	Description
Set filter options	Click this link to access the Requester's Workbench - Filter Options page, where you can enter selection criteria for a new subset of requisitions to review, modify, or act upon.
View Processing Results	Click this link to access the Requester's Workbench - Processing Results page, where you can view the results of the actions that you have performed.

Approval

Select the Approval tab.

Field or Control	Description
Requisition Status	<p>Displays a Related action drop down for pending requisitions. The drop down will have the following values:</p> <ul style="list-style-type: none"> • Send Reminder – Select to send reminders to all the Approvers with whom the Requisition is pending. Reminders will be sent in the form of email, worklist or both, depending on the set up in transaction configuration. This action displays when the Can Send Approval Reminder checkbox is selected in the User preference and the requisition status is Pending. <hr/> <p>Note: The Send Reminder option in the drop down is available when using PeopleTools 8.54. Select lines and click on the button Send Approval Reminder when drop down option is unavailable.</p> <hr/> <ul style="list-style-type: none"> • View Approval — Displays requisitions and approval workflow information. If the requisition is pending at line level, List of Lines Pending will also be shown in addition to Approver information. The user can select lines for which he wants to send reminder and click Send Approval Reminder in the Requisitions List page. This action displays when Approval Framework is enabled for the business unit and the requisition status is Pending or Approved.
No of Days Pending	<p>Displays the number of days the Requisition has been pending with the current Approver. When the approval is pending at header level, the number of days pending will display. When multiple lines are pending approval and each line has the same number of days pending, the No of Days Pending will show the value. If any of the lines have a different number of days pending, (Multiple Values) will display.</p>

Line 1 (Pending days)	Line 2 (Pending days)	Line 3 (Pending days)	No of days displayed in Req grid
4	4	4	4
3	10	14	(Multiple Values)
0	0	0	0

Field or Control	Description
Last Notified on	<p>Displays when the last notification was issued to the user. In case of escalations the latest notified date time will be displayed either through NEM or through Requester's workbench, whichever is recent.</p> <p>If the last notified date is available, it will be displayed if Approvals are pending at the Header level. If notified date is not available, the field remains blank. In case if approval is pending at the Line level and last notified dates are not same, it will be displayed as (Multiple values). This field will be blank if no notification is sent for the lines.</p>

Related Links

[Creating Requisition Header Information](#)

[Understanding Document Status Inquiries](#)

Requester's Workbench - Requisition Lines Page

Use the Requester's Workbench - Requisition Lines page (REQ_RC_WB_LN) to view requisition lines that are associated with the selected requisition.

Navigation:

Click the **Lines** button for a requisition on the Requester's Workbench page.

Use this page to select or clear requisition lines. You can also select **Select All** or **Clear All** to make updates. Click **Return to Requester's Workbench** to include the selected requisition lines in further processing.

This example illustrates the fields and controls on the Requester's Workbench - Requisition Lines page. You can find definitions for the fields and controls later on this page.

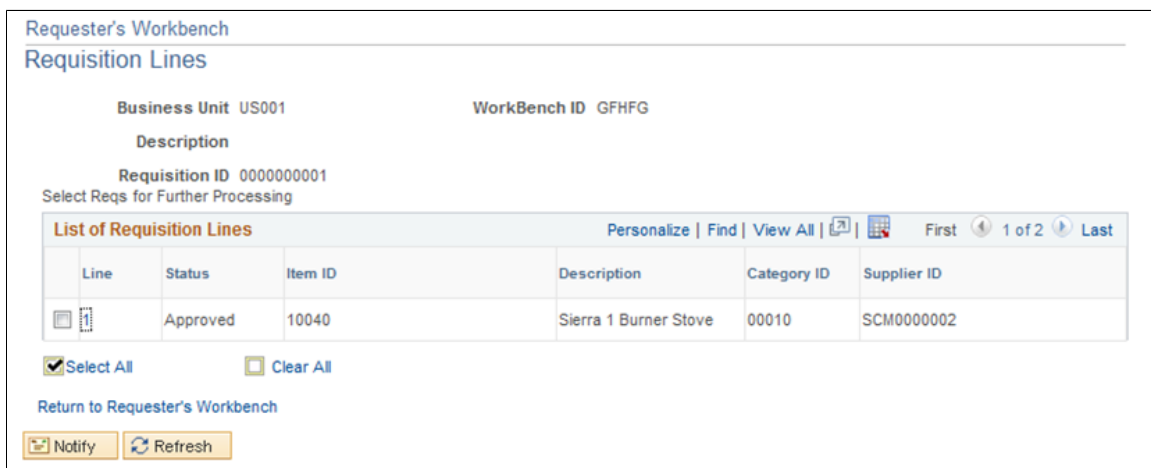

List of Requisition Lines

<i>Field or Control</i>	<i>Description</i>
Line	Click the Line Number link to access the schedule for the line.

When the approval is pending at the line level, the user will have to select from the List of Requisition Lines, and then click **Send Approval Reminder** in Requester's Workbench page to send reminder approvals.

You can select or clear Requisition lines, and then select the **Return to Requester's Workbench** link to select requisition for further processing.

Requester's Workbench - Requisition Schedules Page

Use the Requester's Workbench - Requisition Schedules page (REQ_RC_WB_SCHD) to view requisition schedules that are associated with the selected requisition.

Navigation:

Click a **Line number** link on the Requester's Workbench - Lines page.

<i>Field or Control</i>	<i>Description</i>
Sched Num (schedule number)	Click a schedule line number to access the associated distribution.

Requester's Workbench - Processing Results Page

Use the Requester's Workbench - Processing Results page (REQ_RC_WB_RSLT) to view processing results returned when you take an action on selected requisitions.

Navigation:

- Click an **Action** button on the Requester's Workbench.
- Click the **View Processing Results** link on the Requester's Workbench.

This example illustrates the fields and controls on the Requester's Workbench - Processing Results page. You can find definitions for the fields and controls later on this page.

Requester's Workbench

Processing Results

Business Unit US001 WorkBench ID REQ_WB

Description For Close

Select Reqs for Further Processing

Accounting Date for Action

Update Budget Date Equal to Accounting Date

Not Qualified Personalize | View All |

Personalize 1 of 1 Last

	Requisition ID	Log
<input type="checkbox"/>	0000000155	

Qualified Personalize | View All |

Personalize 1 of 1 Last

Requisition ID	Line	Sched	Distrib Line

Select All Clear All

Proceed: [Return to Requester's Workbench](#)

The system reviews the documents for the action taken on the Requester's Workbench page and determines whether the requisitions are qualified for that action.

Field or Control	Description
	<p>When you close the requisition, click the Override button to move not qualified requisitions in the Not Qualified group box to be qualified for the action in the Qualified group box.</p> <p>When closing the requisition, the system displays this button, which you can click to override the edits on selected lines that are not qualified if you have the authority to do so. This makes the lines available for closing and moves the lines to the qualified side.</p> <p>To give a user authority to override nonqualified requisitions, click the Override Non-Qualified Requisitions for Close check box on the User Preferences - Procurement: Requisition Authorizations page.</p> <hr/> <p>Note: This button will only be available if the user has the authority to override nonqualified purchase orders for close.</p> <hr/> <p>See “User Preferences – Requisition Authorizations Page” (Application Fundamentals).</p>

Field or Control	Description
Accounting Date for Action and Update Budget Date Equal to Accounting Date	Displays the accounting date for action, which is used to determine the open period or allowable open date range for budget checking a requisition when you are using commitment control. The system updates the accounting dates with this date for the requisitions being closed or canceled by using the Requester's Workbench.
	Click the Log icon to access the Requester's Workbench - Processing Log page. This page is a log for the selected nonqualified requisition that states why the requisition was not qualified for the previous processing action.
Yes	Click this button to proceed with the processing of the qualified requisitions. The system prompts you to confirm this selection.
Delete	Click this button to cancel the processing.

Related Links

[Understanding the Close Requisitions Process](#)

Closing Requisitions

Understanding the Close Requisitions Process

Use the Close Requisitions Application Engine process (PO_REQRCON) to close requisitions that are fully canceled or fully sourced and no longer need to be modified. When you run the Close Requisitions process, it reconciles requisition-related settings and statuses to change the status of applicable requisitions to *C* (completed).

To perform the Close Requisitions process you need to have the authorization to do so. To enable users to be able to close requisitions, you must establish their authorizations using the User Preferences- Requisition Authorizations page. Using this page you can give the user the ability to close requisitions as well as override non-qualified requisitions for close.

The benefit of this status change is that completed requisitions no longer appear in your list of available requisitions when you access requisition pages in update or display mode. These completed requisitions are also removed from the view in many other situations in which the available options have been set to exclude completed or canceled requisitions. Removing these requisitions from these prompts improves system performance and decreases the time required to find requisitions that you must modify.

If commitment control is enabled, the Close Requisitions process also sets the budget header and line statuses, as well as the requisition distribution close flags (**KK_CLOSE_FLAG** and **PROCESS_MANUAL_CLOSE**). **This allows** the Commitment Control Budget Processor process (FS_BP) to liquidate pre-encumbrance budget amounts for outstanding requisitions.

Although the Close Requisitions process is optional and you can run it at any time, you should run the process at the end of each month to help improve the efficiency of your requisitioning process. Schedule the Close Requisitions process to run at an interval of your choosing using the PeopleSoft Process Scheduler or run it manually using the Close Requisitions page.

To understand the Close Requisitions process, it is important to know where the process fits in the PeopleSoft Purchasing transaction life cycle. This diagram illustrates the transaction flow leading to the Close Requisitions process:

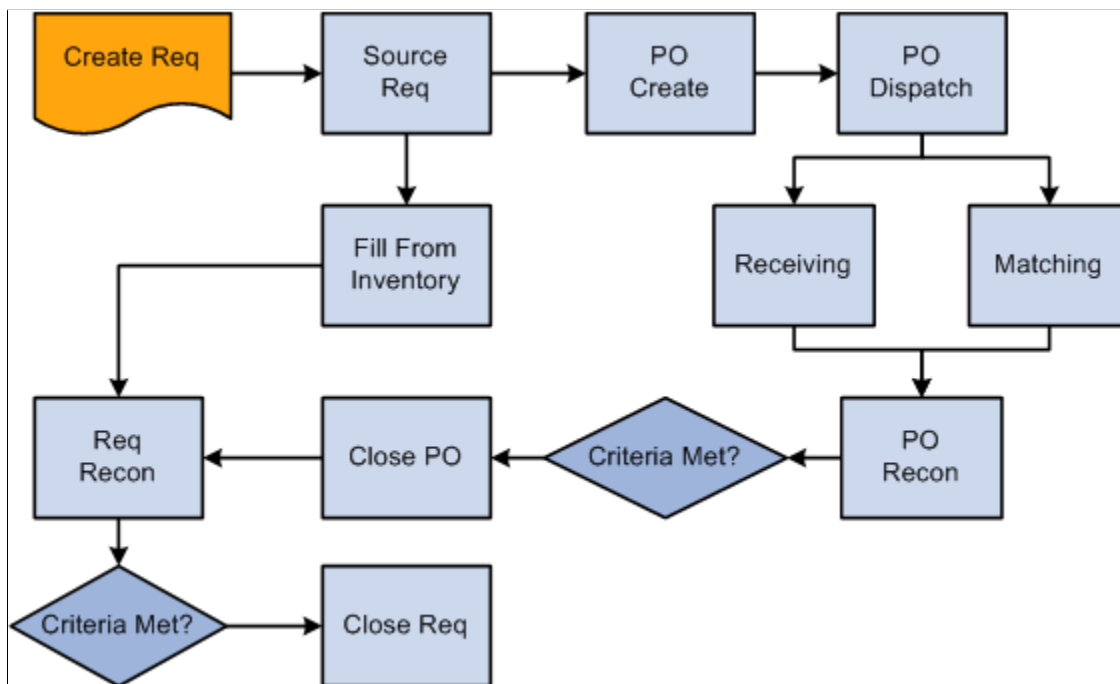

When you initiate the Close Requisitions process from the Close Requisitions page, you have three processing options on the Process Scheduler Request page:

- Select **Close Requisition SQR Report (PORQ009)** to produce the Requisition Reconciliation report.
- Select **Close Requisitions Application Engine process (PO_REQRCON)** to run the Close Requisitions process.
- Select **Close Requisitions a multi-process job (PO_REQRQ)** to run the Close Requisitions process and produce the Requisition Reconciliation report.

Note: If necessary, you can run the Requisition Reopen Application Engine process (PO_REQREOPN) to undo the changes made by the Close Requisitions process.

See the product documentation for *PeopleTools: Process Scheduler*

Related Links

[Close Page](#)

[Commitment Control Budget Processor Process in PeopleSoft Purchasing](#)

“User Preferences – Requisition Authorizations Page” (Application Fundamentals)

Describing Requisition Close Criteria

To understand how the Close Requisitions process functions, you must know the criteria that the process uses to close a requisition. The process references the settings and statuses of several criteria to determine that a requisition is ready to be closed and that it does not need to be modified in the future.

The following table details the business-related criteria referenced by the Close Requisitions process and the settings and statuses that must be met to qualify for closure. Each of the criteria discussed must be met for the Close Requisitions process to close a requisition.

The settings and statuses referenced by the Close Requisitions process include a sourcing requirement that requires all lines on a requisition to be accounted for on a purchase order to qualify for closure. Sourcing requirements can also be met if the requisition lines are fulfilled using the inventory demand functionality or a combination of the two sourcing options.

General Criteria	Qualifying Setting or Status
<p>Close Days</p> <p>The Close Days field on the Purchasing Definition - Business Unit Definition page specifies the number of days beyond a requisition last activity date during which a requisition cannot be closed. The value for the Close Days field creates a grace period during which you can make changes to a requisition after the requisition qualifies to be closed, but before the requisition closes. If you leave the Close Days field blank, the system uses zero close days.</p> <hr/> <p>Note: The Close Days value that you define for the business unit is for purchase order reconciliation and has no relationship to the close days value on the Close Short Run control pages.</p>	<p>The Close Requisitions process verifies that the number of close days defined for the requisition PeopleSoft Purchasing business unit have elapsed. The system adds the value in the Close Days field to the last activity date to determine whether the required number of grace period days have passed.</p> <p>For example, for a Close Requisitions process run date of August 31, 2000, suppose that the last activity date for the requisition is August 25, 2000, and the close days is set to five days. In this example, the process would close the requisition.</p>
<p>Cancel Days</p> <p>The Cancel Days field on the Purchasing Definition - Business Unit Definition page specifies the number of days beyond a requisition's last activity date during which the canceled requisition cannot be closed. The value for the Cancel Days field creates a grace period during which a canceled requisition cannot be closed. If you leave the Cancel Days field blank, the system uses zero cancel days. Cancel days is a business unit attribute; therefore, the system omits the cancel days calculation when the Close Requisitions page specifies a specific requisition ID.</p>	<p>The value for the Cancel Days field works in the same way as the value for the Close Days field, but for canceled requisitions. The Close Requisitions process verifies that the number of cancel days defined for the requisition's PeopleSoft Purchasing business unit has elapsed. The system adds the value for the Cancel Days field to the last activity date to determine whether the required number of grace period days have passed.</p> <hr/> <p>Note: The Close Requisitions process does not change the line status from <i>Canceled</i> to <i>Complete</i>. However, it does change the header status to <i>Complete</i>. The requisition line status remains <i>Canceled</i> so that you can distinguish canceled lines from closed lines.</p>
Record-Level Criteria	Qualifying Setting/Status
<p>PO Status</p>	<p>The Close Requisitions process verifies that the purchase orders to which the requisition lines are sourced have a <i>Completed</i> status.</p>

Record-Level Criteria	Qualifying Setting/Status
<p>Activity Date</p> <p>The system updates this date on the requisition when you save your requisition.</p>	<p>The Close Requisitions process adds criteria, such as close days and cancel days, to the last modified date and time on the requisition Activity Log page. Then the process compares the resulting date to the Close Requisitions process run date (current date) to determine whether it can close the requisition.</p> <p>You can view activity date values by writing a Structure Query Language (SQL) statement against the PS_REQ_HDR record and looking at the ACTIVITY_DATE field.</p>
Distribution Line Status	<p>The Close Requisitions process verifies that the requisition distribution line status is set to <i>X</i> (canceled) or <i>P</i> (processed). A requisition has a status of <i>P</i> after it is sourced to a purchase order or copied to a request for quote.</p>
Entry Event Status	<p>If commitment control is enabled, the Close Requisitions process verifies that you have Entry Event checked for the row.</p>

The Close Requisitions process closes a requisition if any one of the following is true:

- The requisition status is *Canceled* (`PS_REQ_HDR.REQ_STATUS = X`), and the last activity date is less than or equal to the current date minus the close days:
 $(\text{Last Activity Date}) \leq (\text{Current Date}) - (\text{Close Days})$
- The requisition has been sourced to a purchase order (`PS_REQ_LN_DISTRIB.DISTRIB_LN_STATUS = P`), the purchase order status is *Completed*, and the last activity date is less than or equal to the current date minus the close days:
 $(\text{Last Activity Date}) \leq (\text{Current Date}) - (\text{Close Days})$
- The requisition has been sourced to inventory (`PS_REQ_LN_DISTRIB.DISTRIB_LN_STATUS = P`), and the last activity date is less than or equal to the current date minus the close days:
 $(\text{Last Activity Date}) \leq (\text{Current Date}) - (\text{Close Days})$

You can view requisition header information (`PS_REQ_HDR`) and requisition distribution information (`PS_REQ_LN_DISTRIB`) by accessing the requisition online or by writing an SQL statement against the mentioned tables as necessary.

Related Links

[Purchasing Definition - Business Unit Definition Page](#)

Describing Close Requisition Changes to Requisition Statuses

A requisition's distribution lines, schedules, lines, and header can be closed in intervals by the Close Requisitions process. Distribution lines close first, followed by the schedules, lines, and header. Therefore, it is possible to have a distribution line close before the rest of the requisition.

For example, suppose that a requisition contains 20 lines, each with two schedules. When the necessary distributions close, the schedule qualifies for closure. Once the two schedules close for a line, the line closes. When the 20 lines close, the requisition closes.

When you run the Close Requisitions process, it changes the status of all requisitions that meet closure criteria as shown in these tables:

Requisition Header	Updated Status
REQ_STATUS	C (completed)
ACTIVITY_DATE	Run Date
BUDGET_HDR_STATUS (if commitment control is used)	N (not checked)

Requisition Line	Updated Status
CURR_STATUS	C (closed) unless the line was canceled, in which case the status remains X

Requisition Schedule Line	Updated Status
CURR_STATUS	C (closed) unless the schedule was canceled, in which case the status remains X

Requisition Distribution Line	Updated Status
DISTRIB_LN_STATUS	C (completed) unless the distribution line was canceled, in which case the status remains X
PROCESS_MANUAL_CLOSE	Y (yes)
PC_DISTRIB_STATUS	N (none)
BUDGET_LINE_STATUS (if commitment control is used)	N (not checked)
KK_CLOSE_FLAG (if commitment control is used)	Y (yes)
KK_TRAN_OVER_FLAG (if commitment control is used)	N (no)

Related Links

[Understanding the Close Purchase Orders Process](#)

[Commitment Control and PeopleSoft Purchasing Close Processes](#)

Closing Requisitions

This section discusses how to run the Close Requisitions process.

Note: You can use the Requester's Workbench to preview the results of the Close Requisitions process on selected transactions. Once you confirm that the process will produce your desired results, you can run the Close Requisitions process from the Requester's Workbench.

Page Used to Close Requisitions

<i>Page Name</i>	<i>Definition Name</i>	<i>Usage</i>
<u>Close Page</u>	RUN_REQRECON	Run the Close Requisitions process and produce the Requisition Reconciliation report.

Related Links

[Understanding the Requester's Workbench](#)

Close Page

Use the Close page (RUN_REQRECON) to run the Close Requisitions process and produce the Requisition Reconciliation report.

Navigation:

Purchasing > Requisitions > Reconcile Requisitions > Close Requisitions

Process Requests Parameters

<i>Field or Control</i>	<i>Description</i>
Requisition Run Option	<p>Determines which requisitions are selected for the Close Requisitions process. Values are:</p> <p><i>I Bus Unit</i> (one business unit): Reconciles all of the requisitions for a single business unit. If you select this value, enter business unit and ChartField criteria.</p> <p><i>I Document</i>: Reconciles a single requisition within a single business unit. If you select this value, enter business unit, requisition ID, and ChartField criteria.</p> <p><i>All BUs</i> (all business units): Reconciles all of the requisitions for all of your business units. If you select this value, all of the other fields on the page are unavailable for entry.</p>

ChartField Criteria

Use the **ChartField Criteria** group box to select requisitions for processing based on ChartField values. This option is useful if you are using commitment control and want to process requisitions based on ChartField values.

<i>Field or Control</i>	<i>Description</i>
Accounting Date for Action	Determines the open period or allowable open date range for budget checking a requisition when you are using commitment control. The system updates the accounting date with this date for the requisitions that are closed by the Close Requisitions process.
Update Budget Date Equal to Accounting Date	Select to make your budget date the same as the accounting date.

Related Links

“Understanding PeopleSoft ChartFields” (Application Fundamentals)

Reopening Requisitions

This section provides an overview of the Requisition Reopen process and discusses how to run the Requisition Reopen process.

Page Used to Reopen Requisitions

<i>Page Name</i>	<i>Definition Name</i>	<i>Usage</i>
<u>Reopen Requisitions Page</u>	RUN_PO_REQREOPEN	Run the Requisition Reopen process.

Understanding the Requisition Reopen Process

The Requisition Reopen Application Engine process (PO_REQREOPN) gives you the ability to reopen requisitions. To perform the Requisition Reopen process you need to have the authorization to do so. To enable users to be able to reopen requisitions, you must establish their authorization using the Procurement - Requisition Authorizations page. Using this page you can give the user the ability to reopen requisitions.

The Requisition Reopen process gives you the ability to reopen requisitions in a couple of different ways. You can:

- Undo changes made by the last run of the Close Requisition process.

This process reverses the effects of the Close Requisitions process on the most recently processed group of requisitions.

- Reopen any requisition at any time.

This process gives you the ability to reopen a range of requisitions, a specific requisition, or all requisitions associated with a business unit.

Note: A requisition that has been canceled at the header level, is not eligible for reopening.

Running this process resets several values associated with the requisition. The Requisition Reopen process will reset these values:

REQ_HDR	Updated Value After Reopen
REQ_STATUS	Value saved at close
ACTIVITY_DATE	Current Date
BUDGET_HDR_STS_PR (if commitment control used)	N
BUDGET_HDR_STS_NP (if commitment control used)	N if there are non-prorated distributions. Otherwise, set to V.

REQ_LINE	Updated Value After Reopen
CURR_STATUS	Value saved at close

REQ_LINE_SHIP	Updated Value After Reopen
CURR_STATUS	Value saved at close

REQ_LINE_DISTRIB	Updated Value After Reopen
DISTRIB_LINE_STATUS	Value saved at close
BUDGET_LINE_STATUS (if using commitment control)	Value saved at close
KK_CLOSE_FLAG	Value saved at close
PROCESS_MAN_CLOSE	N
PC_DISTRIB_STATUS	N (if PeopleSoft Project Costing is installed)

REQ_LINE_DISTRIB	Updated Value After Reopen
PEG_STATUS	Value saved at close (for non-inventory distributions where complete quantity < peg quantity). If PEG_STATUS is set to <i>Open</i> the Requisition Reopen process will reopen the pegs.

REQ_LN_DIST_NP	Updated Value After Reopen
DISTRIB_LN_STATUS (is using commitment control)	Value saved at close
BUDGET_LINE_STATUS	Value saved at close
KK_CLOSE_FLAG	Value saved at close
PROCESS_MAN_CLOSE	N

Related Links

[Commitment Control Budget Processor Process in PeopleSoft Purchasing](#)

“User Preferences – Requisition Authorizations Page” (Application Fundamentals)

Reopen Requisitions Page

Use the Reopen Requisitions page (RUN_PO_REQREOPEN) to run the Requisition Reopen process.

Navigation:

Purchasing > Requisitions > Reconcile Requisitions > Reopen Requisitions > Reopen Requisitions

This example illustrates the fields and controls on the Reopen Requisitions page. You can find definitions for the fields and controls later on this page.

Reopen Requisitions

Run Control ID Reopen Report Manager Process Monitor
Run

Process Request Parameters

Last Close Requisitions Run
 Select Requisitions to be Reopened

Reopen Requisition Selection Criteria

Reopen Request: Specific Document ▼
 Business Unit: 🔍
 Requisition ID: 🔍
 Requisition Date: All ▼
 Activity Date: All ▼
 Requester: 🔍

Accounting Date Option

Open with Specified Accounting Date 01/17/2013 📅
 Open with Existing Accounting Date

Save
Notify

Add
Update/Display

Field or Control	Description
Last Close Requisitions Run	Select this option if you want to reopen the requisitions that were closed during the last run of the Close Requisitions process. When you select this option, the Reopen Requisition Selection Criteria group box is not available.
Select Requisitions to be Reopened	Select this option if you want to reopen any requisition that has already been closed. After you select this option, enter the requisition or requisitions you would like to reopen in the Reopen Requisition Selection Criteria group box.

Reopen Requisition Selection Criteria

Field or Control	Description
Reopen Request	<p>Select the reopen request option. Values are:</p> <ul style="list-style-type: none"> • <i>Range of Documents:</i> Select if you want to reopen a range of requisitions. After you select this option, select the requisition range using the Requisition ID and To fields. • <i>Specific Business Unit:</i> Select if you want to reopen the requisitions associated with a specific business unit. After you select this option, select the business unit using the Business Unit field. • <i>Specific Document:</i> Select if you want to reopen a specific requisition. After you select this option, select the requisition using the Requisition ID field.
Requisition Date	<p>Select a requisition date option. Values are:</p> <ul style="list-style-type: none"> • <i>All:</i> Select if you want to reopen requisitions for all requisition dates. • <i>Range:</i> Select if you want to reopen requisitions for a certain date range. After you select this option, select the date range using the From and To date fields next to this field. • <i>Value:</i> Select if you want to reopen requisitions for a specific date. After you select this option, select the date using the date field next to this field.
Activity Date	<p>Select an activity date option. Values are:</p> <ul style="list-style-type: none"> • <i>All:</i> Select if you want to reopen requisitions for all activity dates. • <i>Value:</i> Select if you want to reopen requisitions for a specific date. After you select this option, select the date using the date field next to this field.
Requester	<p>Select the requester. Requisitions associated with this requester will be reopened.</p>

Accounting Date Options

<i>Field or Control</i>	<i>Description</i>
Open with Specified Accounting Date	Select this option if you want to reopen the requisitions using the accounting date you specify. The current date appears by default in the date field but you can override it if you choose. This field only appears if you are using commitment control.
Open with Existing Accounting Date	Select this option if you want to reopen the requisitions using the existing accounting date on the requisitions. This field only appears if you are using commitment control.

Chapter 28

Reviewing Requisition Information

Using Requisition Inquiries

This section discusses how to Use Requisition Inquiries

Pages Used to Use Requisition Inquiries

Page Name	Definition Name	Usage
Requisitions Inquiry Search Page	REQ_INQ_SELECT	Enter criteria for selecting requisitions to view on the Requisitions inquiry page.
Supplier Search Page	VENDOR_LOOKUP_SEC	Search for suppliers. Requisitions Inquiry Search Page
Supplier Detail Page	VENDOR_LOOKUP_DTL	View supplier details. Requisitions Inquiry Search Page
Requisitions Inquiry Page	REQ_INQ_LOOKUP	Review requisition information.
Requisition Details Page	REQ_INQ_LINE	View line information for selected requisitions.
Item Description Page	REQ_ITM_DESCR	View descriptions for a specific item. The Item Description link comprises the first 30 characters of the item's description in the Transaction Item Description text box on the Item Description page. Requisition Details Page
Line Comments Page	REQ_INQ_COMMENTS	View line comments for a transaction. Requisition Details Page
Schedule Details Page	REQ_INQ_SCHED	View requisition schedule details about a requisition line.

Page Name	Definition Name	Usage
Requisition Ship To Address Page	PO_SHIPTO_ADDR	View address details for the location relevant to the page from which you accessed this page. If you've identified the address as a one-time address, you see that information on this page.
Distribution Information Page	REQ_INQ_DIST	View distribution details for the selected schedule line.
Direct Shipment Page	REQ_INQ_DROPSHIP	View details about the sales order from which this direct shipment requisition was created.
View Category Hierarchy Page	CAT_PARENTAGE_SEC	View information about where a category resides in the catalog tree hierarchy.
Header Comments Page	REQ_INQ_COMMENTS	View header comments for a transaction. Requisitions Inquiry Page
Approval History Page	REQ_INQ_APPROVAL	Display the approval history for selected requisitions. Requisitions Inquiry Page
Change History - Batch Page	REQ_CHANGE_BATCH	View information about change orders associated with the requisition.
Requisition to RFQ List (requisition to request for quotation list)	REQ_INQ_RFQ	View information for RFQs created from selected requisitions. Requisitions Inquiry Page
All Suppliers Page	RFQ_VND_BY_RFQ	View supplier information listed by RFQ.
Requisition to Purchase Order List	REQ_INQ_PO	View information for purchase orders created from selected requisitions. Requisitions Inquiry Page
“Purchase Order Inquiry Page” (PeopleSoft Payables)	PO_LINE_INQ	View detailed purchase order information.
Requisition Receipts List Page	REQ_INQ_RECV	View receipt information associated with selected requisitions.

Page Name	Definition Name	Usage
Requisition to MSR List (requisition to material stock request list) Page	REQ_INQ_MSR	View information for MSRs created from selected requisitions.
Stock Requests Inquiry	ORDER_INQ_INV	View detailed information about the stock request for a selected requisition. Requisition to MSR List (requisition to material stock request list) Page
Requisition to Voucher List	REQ_INQ_VCHR	View information for vouchers associated with selected requisitions. Requisitions Inquiry Page
“Voucher Inquiry Page” (PeopleSoft Payables)	AP_VOUCHER_INQUIRY	View voucher information.
Voucher Payments Page	VCHR_PAYMENT_PNL	View voucher payment information.
Procurement Card Information Page	CC_USE_HDR_DTL_1	View procurement card details.
Document Status Page - Requisitions	PRCR_DOCSTAT_INQ	Review information about procurement documents associated with a requisition.

Requisitions Inquiry Search Page

Use the Requisitions Inquiry Search page (REQ_INQ_SELECT) to enter criteria for selecting requisitions to view on the Requisitions Inquiry page.

Navigation:

Purchasing > Requisitions > Review Requisition Information > Requisitions > Requisitions Inquiry

Field or Control	Description
Requisition Name	Select a description of a requisition to retrieve. If you are using PeopleSoft eProcurement this value is carried from the eProcurement requisition to the Purchasing requisition. Requisition names assist you in identifying purchase orders associated with eProcurement requisitions.
Supplier SetID	Select a supplier SetID. This field is unavailable for entry if you have selected a business unit.

Field or Control	Description
Item SetID	Select an item SetID. This field is unavailable for entry if you have selected a business unit.
UPN ID	Enter a UPIN ID to search for requisition(s) having UPN ID.
Direct Ship	Select this check box to view requisitions designated for direct shipment.
OK	Click to retrieve the requisitions that match the selection criteria entered and display them on the Requisitions Inquiry Page .

For more information see [Maintain Requisitions - Requisition Page](#).

Requisitions Inquiry Page

Use the Requisitions (inquiry) page (REQ_INQ_LOOKUP) to review requisition information.

Navigation:

Purchasing > Requisitions > Review Requisition Information > Requisitions

After you enter selection criteria on the Requisitions Inquiry Search page, click the **OK** button.

When the system processes the search criteria that you enter, all requisitions that meet that criteria appear in the Req Query grid box. The Details tab provides basic information about the requisition. Click the **Requisition** link to access the Line Details page where you can view line details for the requisition.

Status

Select the Status tab.

Field or Control	Description
Change Order	Select the linked <i>Y</i> value to access the Change History - Batch page. Using this page you can view the change order history for the requisition.
On RFQ (on request for quotation)	Select the linked <i>Y</i> or <i>P</i> values to access the Requisition to RFQ List page. <i>Y</i> (yes): All lines appear on RFQs. <i>P</i> (partial): Some lines appear on RFQs.

Field or Control	Description
On PO (on purchase order)	Select the linked <i>Y</i> or <i>P</i> values to access the Requisition to Purchase Order List page. <i>Y</i> (yes): All lines appear on purchase orders. <i>P</i> (partial): Some lines appear on purchase orders.
Direct Ship	Select the linked <i>Y</i> value to access the Line Details page, where you can then click on the Schedule Details button to access the Schedule Details page. From that page, you can click the Direct Shipment button to view requisition schedule direct shipment information. <i>Y</i> (yes): The requisition is designated for direct shipment.
Received	Select the linked <i>Y</i> or <i>P</i> values to access the Requisition Receipts List page. <i>Y</i> (yes): All lines appear on receipts. <i>P</i> (partial): Some lines appear on receipts.
On MSR (on material stock request)	Select the linked <i>Y</i> or <i>P</i> values to access the Requisition to MSR List page. <i>Y</i> (yes): All lines appear on MSRs. <i>P</i> (partial): Some lines appear on MSRs.
On Voucher	Select the linked <i>Y</i> or <i>P</i> values to access the Requisition to Voucher List page. <i>Y</i> (yes): All lines appear on vouchers. <i>P</i> (partial): Some lines appear on vouchers.
Use ProCard	Select the linked <i>Y</i> value to access the Procurement Card Information inquiry page. <i>Y</i> (yes): The requisition is using a procurement card.
Document Status	Click to access the Document Status page.
Approval History	Click to access the Approval History page. The page displays who approved the requisition and who approved it.

Field or Control	Description
Comments	Click the Comments button to view and add comments to the requisition.

Related Links

[Requisition to Purchase Order List Page](#)

[Requisition Receipts List Page](#)

[Requisition to MSR List \(requisition to material stock request list\) Page](#)

Requisition Details Page

Use the Requisition Details page (REQ_INQ_LINE) to view line information for selected requisitions.

Navigation:

Click a **Requisition ID** link on the Requisitions inquiry page.

This example illustrates the fields and controls on the Requisition Details Page. You can find definitions for the fields and controls later on this page.

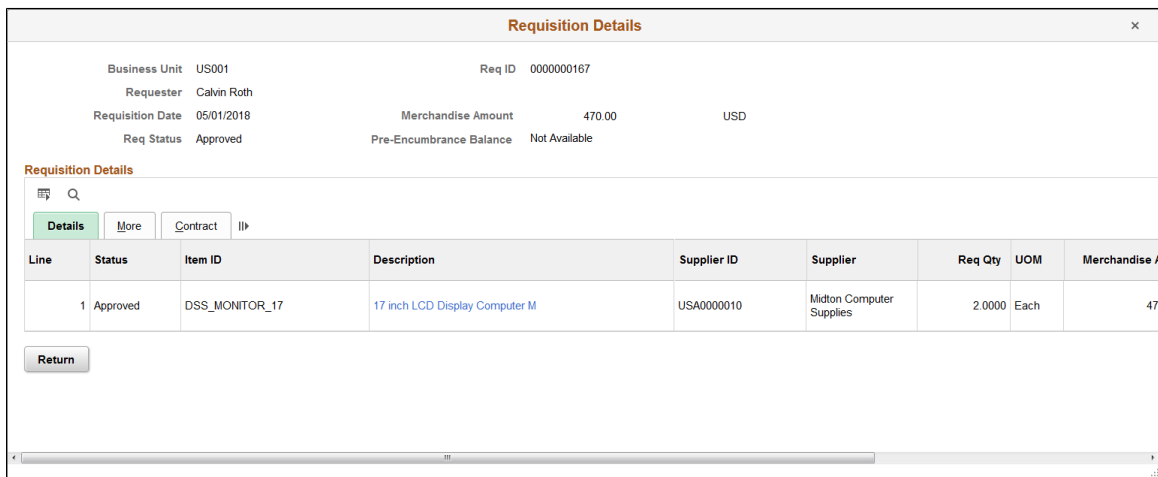

This page displays the requisition's lines. The header provides information that applies to all lines.

Field or Control	Description
Requester	Displays the name of the user who created the requisition.
Requisition Date	Displays the date on which the requisition was created.

Field or Control	Description
Req Status (requisition status)	Displays the requisition status. Values include: <i>Approved</i> <i>Canceled</i> <i>Completed</i> <i>Line Approved</i> <i>Open</i> <i>Pending Approval</i>
Merchandise Amount	Displays the total cost for all of the lines on this requisition. The amount appears in the currency code for the business unit.
Pre-Encumbrance Balance	Displays the amount that you have committed in pre-encumbrances. The system extracts these values from commitment control tables by passing the business unit, document ID, and other key information that depends on the display. The system also updates the pre-encumbrance balance in the distribution grid for each distribution line, and enables the Pre-Encumbrance Balance link when the budget status is valid and balance is not zero. If the balance is zero and budget status is not check, the system does not enable the link. Click the Pre-Encumbrance Balance link to access the Requisition Accounting Entries page. You use this page to view accounting information including the commitment control ledger group and transactions that have been performed against the requisition. See “Viewing Budget Details and Transaction Activity” (PeopleSoft Commitment Control).

Common Fields

This section lists the fields common to all three requisition details tabs.

Field or Control	Description
Status	Displays the requisition status.
Item ID	Displays the item associated with this requisition line.
Description	Displays the description for this requisition line item. Click the link to view the item's description.

Details

Field or Control	Description
Supplier ID and Supplier (Name)	Displays the supplier and supplier name for this requisition line.
Req Qty (requisition quantity)	Displays the item quantity for this requisition line.
UOM (unit of measure)	Displays the item's unit of measure.
Merchandise Amount	Displays the monetary amount for this requisition line.
Amount Only (requisition quantity)	Indicates whether the line is an amount-only line. If the option is selected, the system uses processing values defined for amount-only lines. For more information about how the system processes the line, see See Maintain Requisition - Details for Line Page .
Line Comments	Click to access the Line Comments page, where you can view line item comments and attachments associated with the requisition.
Schedule Details	Click to access the Schedule Details page, where you can view requisition schedule details about a requisition line.

More

Select the More tab.

Field or Control	Description
Buyer (universal product number ID)	Displays the person who is responsible for requisition.
Supplier Item ID (universal product number ID)	Displays the item ID that the supplier uses for this requisition line item. The value is a default value from the Purchasing Attributes - Item Supplier page.
UPN Type	Displays the UPN Type Code.
UPN ID	Displays the universal product number that is assigned to this requisition item.

Field or Control	Description
Supplier's Catalog (universal product number ID)	Displays the supplier catalog to which this item was retrieved. The value is a default value from the Purchasing Attributes - Item Supplier page.
Category and Short Description	Displays the category to which this item is assigned. Categories are groupings of items.
Procurement Group ID	Displays the procurement group to which this requisition belongs.
Primary Unit	Identifies this item as the main item for an item-grouping within a procurement group.
	Click the View Hierarchy button to access the View Category Hierarchy page. Use this page to view information about where a category resides in the catalog tree hierarchy.
Mfg ID (manufacturing ID)	Displays the manufacturer ID for the requisition line item.
Manufacturer's Item ID	Displays the manufacturer item ID for the requisition line item.
GPO ID (group purchasing organization ID)	Displays the group purchasing organization ID.
GPO Contract Number (group purchasing organization contract number)	Displays the group purchasing organization contract number.
Device Tracking	Indicates if the item is flagged for device tracking.

Contract

Use the Contract tab to review information about the contract associated to the requisition line.

Field or Control	Description
Set ID	Displays the set ID associated with this requisition.
Contract ID	Displays the contract on which the pricing of this requisition line is based. Click the link to access contract details.

Field or Control	Description
Contract Version	Displays the version of the contract. Contract versions enable you to create and maintain multiple versions of the contract in the system. Versions are available when version control has been enabled for the business unit. The version that appears in this field is the version that was current when the requisition used the contract.
Contract Line Nbr (contract line number)	Displays the contract line used for this requisition line.
Category Line Number	Displays the category line number for this requisition line.
Contract Reference Type	Displays the type of information in a contract that was used for this requisition line. Available reference types include open item contracts and category, and line item contracts. The contract line field that appears depends on the reference type specified. For <i>Line Item</i> types, the system uses the contract line number value and for <i>Category</i> types, the system uses the category line number.

Note: On Requisitions if the supplier id is shown in line level grid then the GLN label will not get changed as per the hierarchy only the values will be retrieved and the label will show as “supplier GLN”.

Related Links

[Understanding Procurement Groups in PeopleSoft](#)

“Using Universal Item Identifiers” (PeopleSoft Managing Items)

“Using Device Tracking” (PeopleSoft Managing Items)

Schedule Details Page

Use the Schedule Details page (REQ_INQ_SCHED) to view requisition schedule details about a requisition line.

Navigation:

Click the **Schedule Details** button on the Line Details page.

Field or Control	Description
Ship To	Click this link to access the Requisition Ship To Address page, where you can view the ship to address, including a one-time address for this requisition.
Ship Via	Displays the Ship Via Code.

<i>Field or Control</i>	<i>Description</i>
Freight Terms	Displays the Freight Terms code.
Revision	Displays the manufacturer product revision number of the item being ordered. If the ship to is an inventory business unit, and the item is under revision control in that business unit, the revision defaults to that effective on the due date.

Distribution Information Page

Use the Distribution Information page (REQ_INQ_DIST) to view distribution details for the selected schedule line.

Navigation:

Click the **Distrib Details Display** (distribution details display) button on the Schedule Details page.

Details

<i>Field or Control</i>	<i>Description</i>
Location	Displays the internal distribution destination of the item. The internal destination can differ from the ship to location on the schedule. For example, the ship to location of the schedule can be corporate headquarters, and the distribution location can be a specific supply room.

Related Links

“Understanding PeopleSoft ChartFields” (Application Fundamentals)

Requisition to Purchase Order List Page

Use the Requisition to Purchase Order List page (REQ_INQ_PO) to view information for purchase orders created from selected requisitions.

Navigation:

Click the **On PO** (on purchase order) link on the Requisitions inquiry page.

More

Select the More tab.

Field or Control	Description
Open Qty (open quantity)	Displays the quantity remaining to be sourced to a purchase order.
Open Amt (open amount)	Displays the amount remaining to be sourced to a purchase order.
Change Order	Displays a change order number, if applicable.

Requisition Receipts List Page

Use the Requisition Receipts List page (REQ_INQ_RECV) to view receipt information associated with selected requisitions.

Navigation:

Click the **Received** link on the Requisitions inquiry page.

Field or Control	Description
Recv Qty (received quantity)	Displays the quantity delivered for the requisition line.
Business Unit	Displays the receiving business unit.
Description	Displays the receipt unit of measurement.

Requisition to MSR List (requisition to material stock request list) Page

Use the Requisition to MSR List (requisition to material stock request list) page (REQ_INQ_MSR) to view information for MSRs created from selected requisitions.

Navigation:

Click the **On MSR** (on material stock request) link on the Requisitions inquiry page.

Details

Field or Control	Description
Business Unit	Displays the PeopleSoft Inventory business unit.

Field or Control	Description
Demand Source	Displays the source of the stock request: <i>IN:</i> (PeopleSoft Inventory material request). <i>OM:</i> (PeopleSoft Order Management sales order). <i>PL:</i> (PeopleSoft Planning requisition). <i>PO:</i> (PeopleSoft Purchasing sourced demand). <i>PR:</i> (PeopleSoft Purchasing requisition). <i>RT:</i> (material return). <i>SF:</i> (PeopleSoft Production request).
Order No (order number)	Displays the stock request order number, often associated with the requisition ID number.
Order Line	Displays the order line on the stock request order that is associated with the selected requisition line number. Essentially, the stock request order line number and the requisition line number both reference the item that is being requisitioned and requested from inventory.
Sched Line No (schedule line number)	Displays the schedule line number for the stock request order.

Using the Requisition Workbench

This section discusses how to Use the Requisition Workbench

Note: The Requisition Workbench component provides the same information as the Requisition inquiry component, plus more details about MSRs, interunit receipts, and external shipments.

Pages Used to Use the Requisition Workbench

Page Name	Definition Name	Usage
Requisition Workbench selection criteria Page	REQ_WB_SELECT	Enter selection criteria for requisition information to appear on the Workbench - Requisitions page.

Page Name	Definition Name	Usage
<u>Workbench Page</u>	REQ_WB_LOOKUP	View and work with requisition information that has been retrieved according to your selection criteria. You can view the status of requisitions and service orders, and navigate to their details.
Line Details Page	REQ_INQ_LINE	View line information for selected requisitions. <u>Workbench Page</u>
Item Description Page	REQ_ITM_DESCR	View descriptions for a specific item.
Schedule Details Page	REQ_INQ_SCHED	View shipment schedule information about a requisition line.
Distribution Information Page	REQ_INQ_DIST	View distribution details for the selected schedule line.
Direct Ship Page	REQ_INQ_DROPSHIP	View details about the sales order from which this direct shipment requisition was created.
Approval History Page	REQ_INQ_APPROVAL	Display the approval history for selected requisitions. <u>Workbench Page</u>
Header Comments Page	REQ_INQ_COMMENTS	View header comments for a transaction. <u>Workbench Page</u>
Line Comments Page	REQ_INQ_COMMENTS	View line comments for a transaction.
Requisition to RFQ List Page (requisition to request for quotation list)	REQ_INQ_RFQ	View information for RFQs created from selected requisitions. <u>Workbench Page</u>
All Suppliers inquiry Page	RFQ_VND_BY_RFQ	View supplier information listed by RFQ.
Requisition to Purchase Order List Page	REQ_INQ_PO	View information for purchase orders created from selected requisitions. <u>Workbench Page</u>

Page Name	Definition Name	Usage
“Purchase Order Inquiry Page” (PeopleSoft Payables)	PO_LINE_INQ	View detailed purchase order information.
<u>Requisition Receipts List Page</u>	REQ_INQ_RECV	View receipt information associated with selected requisitions.
<u>Requisition to MSR List (requisition to material stock request list) Page</u>	REQ_INQ_MSR	View information for MSRs created from selected requisitions.
Stock Requests Inquiry Page	ORDER_INQ_INV	View detailed information about the stock request for a selected requisition.
Requisition to Interunit MSR List Page (requisition to interunit material stock request list)	REQ_INQ_IURECV	View MSR information for a requisition with an associated interunit receipt. A requisition line must be associated with an interunit receipt for this page to be accessible.
Serial/Lot Detail Page	REQ_INQ_IUSER	View lot and serial number information for lot- and serial-controlled items. The item on the requisition line must be serial- or lot-controlled for this page to be accessible.
Requisition to Voucher List Page	REQ_INQ_VCHR	View information for vouchers associated with selected requisitions.
“Voucher Inquiry Page” (PeopleSoft Payables)	AP_VOUCHER_INQUIRY	View voucher information.
Voucher Payments Page	VCHR_PAYMENT_PNL	View voucher payment information.

Related Links

[Requisition Details Page](#)

Requisition Workbench selection criteria Page

Use the Requisition Workbench selection criteria page (REQ_WB_SELECT) to enter selection criteria for requisition information to appear on the Workbench - Requisitions page.

Navigation:

Purchasing > Requisitions > Review Requisition Information > Workbench

This example illustrates the fields and controls on the Requisition Workbench selection criteria page. You can find definitions for the fields and controls later on this page.

Enter selection criteria to view the status of a specific requisition and check where it is in the process flow from sourced to received. You can search for requisitions based on a number of system values including requisition ID and name, requester name, and requisition date. The system uses the values that you define in the top portion of the page along with sourcing activity values that you enter in the lower portion of the page.

Also enter criteria to view all requisitions for a specific requester that have been sourced to a purchase order, received, or sourced to an MSR.

Field or Control	Description
System Source	Displays the source of the Purchasing Requisition Loader process (PO_REQLOAD) that processed the purchase requests to retrieve. Note: You can only select system sources that are used by the batch process that loads batch requisitions.
Loader BU (Purchasing Requisition Loader process business unit)	Displays the business unit of the Purchasing Requisition Loader process that loaded the purchase request to retrieve.

Note: When using the Requisition Workbench page to search for requisitions originating from PeopleSoft Field Service, the **Loader BU** value should be the same as your PeopleSoft CRM Field Service and PeopleSoft CRM Support business unit.

Field or Control	Description
Business Unit	Displays the business unit of the requisitions to retrieve. If you have entered a value in the Loader BU and System Source fields, the business unit value designated for the Loader BU/System Source combination on the Requisition Loader Defaults - Req Loader Defaults page appears.

Sourcing Activity

Use the **Sourcing Activity** group box to further define the selection criteria.

Field or Control	Description
Reqs Never Sourced (requisitions never sourced)	Select to retrieve information about requisitions that have no sourcing activity. If you do not select this option, the search excludes requisitions with no sourcing activity.
Apply Activity Dates	Click this button to apply the From Activity Date and To Activity Date values to the PO Activity Dates and MSR Activity Dates fields.
From Activity Date and To Activity Date	Displays the range of activity dates for which you want to retrieve requisition information. Click the Apply Activity Dates button to apply the date range that you enter.

Sourced to Purchase Order

Use the **Sourced to Purchase Order** group box to further refine the types of requisitions to be retrieved. Only requisition IDs that exist on purchase order distributions are available when using these criteria.

In the first drop-down list box, select from the following purchase order process flow attributes. Requisitions that have been sourced to purchase orders with the selected attributes are retrieved in your search:

- *All*: All qualifying requisition lines are retrieved.
- *All Except Direct Shipments*: All qualifying requisition lines that are not direct shipments are retrieved.
- *POs Direct Shipments Only* (purchase orders direct shipments only): All qualifying requisition lines that are direct shipments are retrieved.
- *POs Not Rcvd Plus Direct Ship* (purchase orders not received plus direct shipments): All qualifying requisition lines that do not exist on active receipt distributions and are not direct shipments are retrieved.

- *POs Not Received* (purchase orders not received): All qualifying requisition lines that do not exist on active receipt distributions are retrieved. Selecting this value enables the retrieval of direct shipment lines as well.
- *POs Received* (purchase orders received): All qualifying requisition lines that exist on an active receipt distribution are retrieved.

Field or Control	Description
From Receipt Date and To Receipt Date	Select <i>All</i> , <i>All Except Direct Shipments</i> , and <i>POs Received</i> , as well as the Sourced to Purchase Order options in order for the system to use the receipt date range (from RECV_HDR).

PO Activity Dates

Use the **PO Activity Dates** (purchase order activity dates) group box to further limit the range of requisition lines retrieved based on the purchase order line ship due date on associated purchase orders.

Field or Control	Description
From Due Date and To Due Date	Displays the range of purchase order line ship due dates for which you want to retrieve requisition information. This date range is used by the system for any sourced to purchase order options that are selected.

Sourced to Material Stock Request

Use the **Sourced to Material Stock Request** group box to refine the types of requisitions to be retrieved. Requisitions that have been sourced to MSR with the selected attributes are retrieved in your search.

You can use the options available in the two drop-down fields either individually or in tandem to create combinations of selection criteria. The first drop-down list box containing the *All*, *Not Shipped*, and *Shipped* options enables you to select MSRs in those statuses. Selecting an option in the second drop-down list box further refines your selection by limiting the MSRs retrieved to the type selected.

Note: Selecting *Not Shipped* and the MSR type *InterUnits Received* does not return any results.

MSR Activity Dates

Use this group box to further limit the range of requisition lines retrieved based on MSR ship and schedule dates.

Field or Control	Description
From Schedule/Ship and To Schedule/Ship	Displays the range of MSR ship and schedule dates for which you want to retrieve requisition information. For MSRs that are not shipped, the system checks against the MSR SCHED_DATE. For shipped MSRs, the system checks against the MSR SHIP_DATE.

MSR Type

Use this group box to limit the MSRs retrieved to the type selected. Using the **MSR Type** field, in combination with the other search criteria available in the **Sourced to Material Stock Request** group box, enables you to further refine your search.

Note: Selecting *Not Shipped* and the MSR type *InterUnits Received* does not return any results.

Select MSR attributes:

- *All*: Retrieves all qualifying requisition lines for which requisition IDs exist on MSRs.
- *All InterUnits*: Retrieves all qualifying interunit transfer requisition lines.
- *External Shipments*: Retrieves all qualifying requisition lines for which external shipments exist.
- *InterUnits Not Received*: Retrieves all qualifying interunit transfer requisition lines that have not been received.
- *InterUnits Received*: Retrieves all interunit transfer requisition lines that have been received.

Click **OK** to access the Workbench - Requisitions page, where you can view and work with requisition information that has been retrieved according to your Requisition Workbench selection criteria.

Related Links

[Requisition Loader Page](#)

“Using Requisition Loader Defaults and Overrides” (PeopleSoft Source to Settle Common Information)

Workbench Page

Use the Workbench page (REQ_WB_LOOKUP) to view and work with requisition information that has been retrieved according to your selection criteria.

You can view the status of requisitions and service orders, and navigate to their details.

Navigation:

Purchasing > Requisitions > Review Requisition Information > Workbench > Requisitions

After you enter the selection criteria, click the **OK** button on the Requisitions Workbench page.

Status

Field or Control	Description
MSR Not Shipped	<p>Designates if the requisition is tied to an MSR that has not been shipped. Values are:</p> <p><i>Y</i> (yes): The MSR has not been shipped.</p> <p><i>P</i> (partial): A partial quantity on the MSR has not been shipped.</p> <p>Select the linked <i>Y</i> and <i>P</i> statuses to access the Requisition to MSR List page.</p>
MSR Shipped	<p>Designates if the requisition is tied to an MSR that has been shipped. Values are:</p> <p><i>Y</i> (yes): The MSR has been shipped.</p> <p><i>P</i> (partial): A partial quantity on the MSR has been shipped.</p> <p>Select the linked <i>Y</i> and <i>P</i> statuses to access the Requisition to MSR List page.</p>
External MSR	<p>Designates if the selected requisition has been sourced to an MSR to be shipped to a customer location. Values are:</p> <p><i>Y</i> (yes): The entire requisition has been sourced or shipped to the external MSR.</p> <p><i>P</i> (partial): A partial quantity on the requisition has been sourced or shipped to the external MSR.</p> <p>Select the linked <i>Y</i> and <i>P</i> statuses to access the Requisition to MSR List page.</p>
Inter Unit Receipt	<p>Designates if the requisition involves an interunit receipt. Values are:</p> <p><i>Y</i> (yes): All lines appear on interunit receipts.</p> <p><i>P</i> (partial): Some lines appear on interunit receipts.</p> <p>Select the linked <i>Y</i> and <i>P</i> statuses to access the Requisition to Interunit MSR List page.</p>

Related Links

[Requisitions Inquiry Page](#)

[Requisition to MSR List \(requisition to material stock request list\) Page](#)

Reviewing Requisition Accounting Line Entries

This section discusses how to Review Requisition Accounting Line Entries:

Note: You can review both standard entries and supplemental (entry event) entries when commitment control is enabled on the Installation Options - Products page.

Pages Used to Review Requisition Accounting Line Entries

<i>Page Name</i>	<i>Definition Name</i>	<i>Usage</i>
Selection Criteria (for requisition accounting line entries) Page	REQ_ACTG_LN_SELECT	Select the criteria that you want to view on the Requisition Accounting Entries page. Filter criteria by requisition range, business unit, fiscal year range, requisition status, and ChartField combinations.
Requisition Accounting Entries Page	REQ_ACTG_LN_LOOKUP	Review accounting line entries.

Related Links

[Understanding Entry Events in PeopleSoft Purchasing](#)

Selection Criteria (for requisition accounting line entries) Page

Use the Selection Criteria (for requisition accounting line entries) page (REQ_ACTG_LN_SELECT) to select the criteria that you want to view on the Requisition Accounting Entries page.

Filter criteria by requisition range, business unit, fiscal year range, requisition status, and ChartField combinations.

Navigation:

Purchasing > Requisitions > Review Requisition Information > Accounting Entries

This inquiry displays standard or supplemental (entry event) entries. You can also choose to view both types.

Field or Control	Description
Accounting Line View Option	<p>Select from these types of views:</p> <p><i>Standard</i>: Select to view standard accounting entries.</p> <p><i>Supplemental (Entry Event)</i>: Select to view entry event accounting entries.</p> <p><i>View Both</i>: Select to view both standard and supplemental accounting entries.</p> <hr/> <p>Note: If entry events are disabled, the values in this box are not available. However, you are still able to inquire on standard accounting entries.</p> <hr/>
Ledger Group	<p>Select the ledger group for which you want to view accounting lines. The available options are defined at the business unit level. If a commitment detail ledger has been selected for that commitment control ledger group on the Ledgers For A Unit - Commitment Control Options page, the selected commitment control ledger group appears as the default ledger group here.</p>

Requisition Accounting Entries Page

Use the Requisition Accounting Entries page (REQ_ACTG_LN_LOOKUP) to review accounting line entries.

Navigation:

Purchasing > Requisitions > Review Requisition Information > Accounting Entries > Requisition Accounting Entries

To properly generate entry event accounting entries, run the Entry Event Generator each time that you run the budget check process. When the Entry Event Generator is run more than once, it does not replace the existing entries. Instead, it creates a new set of entries for that transaction by increasing the Unpost Sequence Number instead. The entire entry event history for a transaction appears on the Requisition Accounting Entries page. The values in the Unpost Seq (unpost sequence) field display every entry event post process.

Standard accounting entries are created by the budget check process. When the budget check process is run again, it deletes the existing entries for that transaction and re-creates a new set of entries for that transaction so that the value in the **Unpost Seq** field is always 0 (zero) for standard entries.

Accounting Entries

Field or Control	Description
Requisition ID	<p>Click this link to access the Requisition Inquiry page, where you can view the supplier ID and other requisition details.</p>

Field or Control	Description
Trans Type (transaction type)	Displays the journal template or source transaction. If it is a standard accounting entry, a source transaction appears. If it is an entry event accounting entry, a journal template appears.
Unpost Seq (unpost sequence)	Indicates the number of times that the Entry Event Generator has been run. For standard entries, the value is always 0. For supplemental entries, the value is 0 the first time that the Entry Event Generator is run, 1 the second time, and so on.
Monetary Amount	Click to access the Commitment Control Activity Log page, where you can view basic activity information.
Pre-Encumbrance Balance	<p>Displays the pre-encumbrance balance. When you use commitment control, the system deducts each type of financial obligation from the budget and tracks it according to obligation type. When you generate a requisition, a pre-encumbrance is created in your budget records by the budget-checking process. When a requisition is sourced to a purchase order, commitment control liquidates the pre-encumbrance from the requisition and establishes an encumbrance for the purchase order.</p> <p>Pre-encumbrance balances display on the currency code for the balances in the transaction currency of the requisition and is based on the transaction date rate. You can have a pre-encumbrance currency value in a different currency than the supplier's currency. Balances can be partially or fully sourced to purchase orders and can be for multiple requisition lines, schedules, and distributions.</p> <p>You can view accounting details for the requisition, such as the purchase orders and vouchers that have been created from the requisition. Click the Pre-Encumbrance Balance field link to access the Requisition Accounting Entries page. You use this page to view accounting information including the commitment control ledger group and transactions that have been performed against the requisition.</p> <p>See “Viewing Budget Details and Transaction Activity” (PeopleSoft Commitment Control).</p>

Field or Control	Description
Closed Value	Indicates whether the transaction has been closed. Values are: Y: Closed. N: Open. When a transaction is closed, the Budget Processor liquidates all of its remaining unliquidated commitment control ledger amounts.
Journal ID	For standard entries, displays the journal ID. For supplemental entries, displays the commitment control ID.
Reference Reversal ID	Displays the purchase order ID associated with the reversal accounting entry lines.

Related Links

[Purchase Order ChartField Approval Page](#)

[Purchase Order Amount Approval Page](#)

“Understanding Accounting Calendars Based on Open and Close Periods” (Application Fundamentals)

“Understanding PeopleSoft ChartFields” (Application Fundamentals)

“Viewing the Activity Log” (PeopleSoft Commitment Control)

Reviewing Requisition Entry Event Journal Entries

This section lists the page used to view requisition entry event journal entries.

Page Used to View Requisition Entry Event Journal Entries

Page Name	Definition Name	Usage
PO Requisition Drillback Page	EE_REQ_DRILL	Drilldown to the general ledger and view entry event journals for your requisitions.

Managing Requests for Quotes

Understanding RFQs in PeopleSoft Purchasing

You can establish one RFQ and dispatch it to as many suppliers as needed. You can send an RFQ to a supplier that is not yet approved within the PeopleSoft Purchasing system, but the supplier must be approved before you can award the RFQ to that supplier.

The next diagram illustrates the flow of information and transactions involved in the RFQ process. The process includes creating, dispatching, analyzing, and inquiring about RFQs and begins with setting up supplier quote groups:

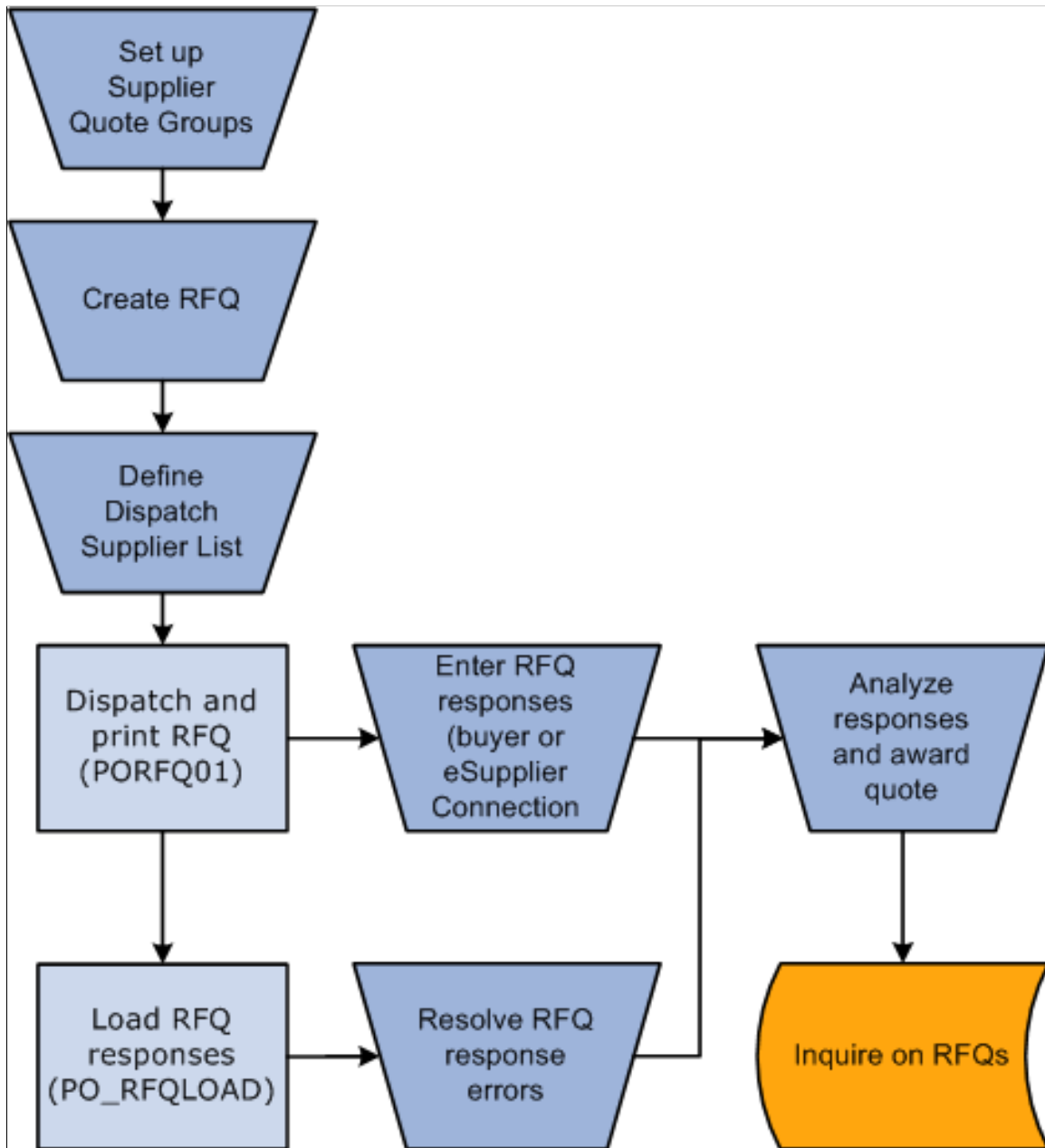

Establishing Supplier Quote Groups

PeopleSoft Purchasing enables you to establish groups of suppliers specific to particular items, locations, or other criteria under a single supplier quote group ID. You can use these groups to conveniently send RFQs to the entire group or a subset of the group.

This section lists the pages used to establish supplier quote groups.

Pages Used to Establish Supplier Quote Groups

<i>Page Name</i>	<i>Definition Name</i>	<i>Usage</i>
List of Suppliers Page	RFQ_VNDR	Select suppliers from the Supplier table to add to a supplier quote group.
Supplier Lookup Page	VENDOR_LOOKUP_WRK	Search for suppliers.
Supplier Select by SIC Page (supplier select by standard industrial classification)	RFQ_VND_SELECT	Search for suppliers to add to a supplier quote group by using SICs as selection criteria.

Creating RFQs

This section discusses how to create RFQs

Pages Used to Create RFQs

<i>Page Name</i>	<i>Definition Name</i>	<i>Usage</i>
<u>Request Quotes Page</u>	RFQ_HDR	Create an RFQ.
<u>Dispatch Options Page</u>	RFQ_DISP_OPTIONS	Enter dispatch options for the RFQ to dispatch it to the supplier. This page becomes available when you select a supplier on the RFQ Dispatch Supplier List page and click the To Dispatch check box for the supplier.
Item Description Page	RFQ_ITEM_DESCR, RFQ_ITEM_3_DESCR	Enter and view descriptions for a specific item.
<u>Enter Copy Criteria Page</u>	RFQ_HDR_COPY	Copy lines from another RFQ or a requisitions. This page is accessible only when you are in Add mode on the Request Quotes page.

Page Name	Definition Name	Usage
Select lines to copy Page	RFQ_FROM_RFQ_COPY	Select specific lines to copy to the RFQ from the requisitions or RFQs that you selected on the Enter Copy Criteria page. To access this page, you must clear the Copy all Req/RFQ lines (copy all requisitions/RFQ lines) check box on the Enter Copy Criteria page.
<u>RFQ Dispatch History Page</u>	RFQ_DISP_DSPLY	View the supplier location, date, and time that the RFQ was dispatched.
Order By Catalog Page	ORD_BY_ITEM_CAT	Search for and select items to order from a catalog.
RFQ Currency Information Page	EXCH_RT_DTL_INQ	View the rules used to calculate exchange rates for the transaction.
<u>RFQ Header Details Page</u>	RFQ_HDR_SEC	Enter additional header information for the RFQ.
<u>RFQ Dispatch Supplier List Page</u>	RFQ_DISPATCH_SEC	Select the suppliers to whom you want to send the RFQ.
Select RFQ Lines For Supplier Page	RFQ_VNDR_LN_SEC	Specify the lines to send to a supplier.
Supplier Details Page	RFQ_VNDR_ADDR_SEC	View supplier contact information.
Address Page	RFQ_VNDR_ADDR_SEC	View the supplier address based on send to, contact, or sales contact information.
Phone Page	VNDR_PHONE_SEC	View the supplier phone information based on send to, contact, or sales contact information.
Supplier Search Page	VENDOR_LOOKUP_SEC	Search for suppliers.
RFQ Header Comments Page	RFQ_HDR_COMM_SEC	Enter comments for a transaction. You can enter a unique comment or select from predefined standard comments.

Page Name	Definition Name	Usage
<u>Email Message Page</u>	WV_PE_EMAIL_SP	Send an email to someone regarding the quote. This email includes links to take a supplier to the Request for Quotes List page (if the installation includes PeopleSoft eSupplier Connection) or links to take the email recipient to the Request for Quotes or the Maintain Responses page.
<u>Item Supply Supplier List Page</u>	RFQ_VNDR_ITEM_SEC	Search for the suppliers defined as suppliers of a particular RFQ line item. Select the suppliers that you want to add to the suppliers available on the Dispatch Supplier List page.
RFQ Line Comments Page	RFQ_HDR_COMM_SEC	Enter comments for a transaction. You can enter a unique comment or select from predefined standard comments.
Category Search Page	CAT_SEARCH_SEC	When entering an ad hoc item, search for and select an appropriate category ID for the item. A category hierarchy tree is used to search for the category ID.
View Category Hierarchy Page	CAT_PARENTAGE_SEC	View information about where a category resides in the catalog tree hierarchy.
RFQ Activities Page	RFQ_ACTIVITY_SEC	Enter and track activities associated with a particular transaction. Keep activity comments organized by logging the due date and selecting the Done check box.
RFQ DOC Status Page(request for quote document status)	PRCR_DOCSTAT_INQ	Access and review information about procurement documents associated with an RFQ.

Request Quotes Page

Use the Request Quotes page (RFQ_HDR) to create an RFQ.

Navigation:

Purchasing > Request for Quotes > Add/Update RFQs > Request Quotes

Note: You cannot associate PeopleSoft Maintenance Management work order information to a manually created RFQ. The PeopleSoft Maintenance Management work order information can be carried with the requisition that is associated to an RFQ.

This example illustrates the fields and controls on the Request Quotes page. You can find definitions for the fields and controls later on this page.

The screenshot shows the 'Request Quotes' interface. At the top, there are fields for Business Unit (US001), RFQ ID (0000000007), Request Date (02/03/2003), Status (Approved), Currency (USD), Origin (ONL), Date Time Opened (02/03/2003 8:19AM), and Reference (PeopleSoft). A 'View Printable Version' link is also present. Below this is a 'Lines' section with a table of items:

Line	Item ID	Description	Category	UOM	Quantity	Price	Line Comments
1	10003	Long Sleeve Biking Jersey, ...	CYCLING	EA	100.0000		
2	10004	Long Sleeve T-Shirt, Womens	CYCLING	EA	100.0000	17.00000	
3	10007	Sidepocket Shorts, Womens	CYCLING	EA	200.0000	20.00000	

Below the table are various navigation and action buttons like 'Save', 'Return to Search', 'Previous in List', 'Next in List', 'Notify', 'Refresh', 'Add', and 'Update/Display'. There are also links for 'Dispatch History', 'Catalog', 'Exchange Rate', and 'Dispatch Supplier List'.

Field or Control	Description
View Printable Version	Click this link to access the Report Manager page, from which you can print the RFQ.
Status	<p>Displays the status of the RFQ. The RFQ is not available for dispatch until it is in <i>Approved</i> status. The status appears by default from the User Preferences - Procurement: Request for Quote Process page. Values are:</p> <ul style="list-style-type: none"> <i>Approved</i>: RFQ is ready to be dispatched. <i>Canceled</i>: RFQ has been rejected. <i>Closed</i>: RFQ is closed. <p>See Closing RFQs.</p> <ul style="list-style-type: none"> <i>On Hold</i>: RFQ is pending. <i>Open</i>: RFQ is not ready to be dispatched.
DtTm Open (date and time open)	Displays the date and time when the RFQ opens for supplier response.
DtTm Close (date and time close)	Displays the date and time when the RFQ closes for supplier response.
Currency	Displays the currency for the entire RFQ. When you analyze the responses, they can all be converted to this currency.

Line Info

Select the Line Info tab.

<i>Field or Control</i>	<i>Description</i>
Item	<p>Select an item ID. If you used the order function from the catalog or the Select Lines to Copy page from the Enter Copy Criteria page, a value already appears.</p> <p>If the RFQ line is associated with a requisition line that has one or more distributions that are being pegged, then the Item field is not available.</p>
Category	Select a category. If you selected an item ID, the category appears by default from the Purchasing Attributes page.
Price	Enter the cost that you want quoted. The default for this field is based on the value defined for the item.

More Details

Select the More Details tab.

<i>Field or Control</i>	<i>Description</i>
Due Date	Displays the default value of the current system date, plus the number of lead-time days, but you can override it by entering the date by which you actually need the item.
Physical Nature	Select to indicate if the object is a physical good or service.

Field or Control	Description
Where Performed	<p>Select to indicate the location where the service is most often performed. Values are:</p> <ul style="list-style-type: none"> • <i>Buyer's</i>: Select if the service was physically performed at the buyer location. • <i>Ship From</i>: Select if the service was physically performed at the bill from location. • <i>Ship To</i>: Select if the service was physically performed at the bill to location. • <i>Supplier's</i>: Select if the service was physically performed at the supplier location. <hr/> <p>Note: The Physical Nature and Where Performed fields are used as part of the purchasing defaulting hierarchy. The Where Perform field is available when the value in the Physical Nature field is <i>Service</i>. These fields default onto requisition, purchase orders, contract, and RFQ lines. These fields also impact the VAT treatment determination.</p>

Note: If the PeopleSoft Inventory business unit requires closure calendar validation and processing for shipping activities (as defined on the Closure Calendar page), and the reservation lead days include exception dates, then the system adds one day for every closed day to the number of reservation lead days to compare against the scheduled ship date. Therefore, the lead days include only open business days.

Item Information

Select the Item Information tab.

Field or Control	Description
Device Tracking	Indicates whether a line contains a device-tracked item.

Related Links

[Dispatching RFQs](#)

[Understanding the UOM Conversion Hierarchy](#)

“Establishing Operation Closure Dates” (PeopleSoft Inventory)

“Freight Terms Page” (Application Fundamentals)

“Using Device Tracking” (PeopleSoft Managing Items)

RFQ Header Details Page

Use the RFQ Header Details page (RFQ_HDR_SEC) to enter additional header information for the RFQ.

Navigation:

Click the **Header Details** link on the Request Quotes page.

Field or Control	Description
Terms	Displays payment terms expected for the vouchers that correspond to any purchase orders generated from this RFQ.

Field or Control	Description
Currency	Displays the currency for the entire RFQ. When you analyze the responses, they can all be converted to this currency. The corresponding rate type displays next to the currency. This rate type is used for currency conversions when processing the RFQ responses.

Related Links

“Defining Payment Terms” (PeopleSoft Source to Settle Common Information)

Enter Copy Criteria Page

Use the Enter Copy Criteria page (RFQ_HDR_COPY) to copy lines from another RFQ or a requisitions.

This page is accessible only when you are in Add mode on the Request Quotes page.

Navigation:

Click the **Copy From** link on the Request Quotes page.

This example illustrates the fields and controls on the Enter Copy Criteria page. You can find definitions for the fields and controls later on this page.

The screenshot shows a web form titled "Enter Copy Criteria" with a close button (X) in the top right corner. The form is organized into three main sections:

- Copy Template:** Contains a dropdown menu labeled "*Copy From" with the value "Request For Quotes" selected.
- Selection Criteria:** Contains three fields:
 - "Business Unit" with the value "US001".
 - "*Select Req Lines" with a dropdown menu showing "RFQ Required".
 - "*Copy Method" with a dropdown menu showing "Override".
- Copy Criteria:** Contains a text input field for "RFQ ID" with the value "0000000001" and a magnifying glass icon to its right. Below this field is a checkbox labeled "Copy all Req/RFQ lines" which is checked.

At the bottom of the form, there are three buttons: "OK", "Cancel", and "Refresh".

Copy Template

Field or Control	Description
Copy From	<p>Select the type of document from which you want to copy information to the RFQ. The fields that appear in the Copy Criteria group box depend on the value that you select here.</p> <p>Values are:</p> <p><i>Request For Quotes:</i> Select to copy lines from RFQs. When you select this value, the only available field in the Copy Criteria group box is RFQ ID.</p> <p><i>Requisitions:</i> Select to copy lines from requisitions. You can copy requisition information to an RFQ provided that the following are true:</p> <ul style="list-style-type: none"> • The requisition status is <i>Approved</i>. • The requisition is not on hold. • The requisition is not involved in another sourcing process. • If the business unit requires budget checking, the requisition must already be budget checked. <hr/> <p>Note: Amount only requisition lines on a requisition will not be copied to an RFQ.</p> <hr/> <p>When copying from multiple requisitions or RFQs all active header comments will be copied to the new RFQ.</p> <p>If you copy an RFQ that originated as a requisition, PeopleSoft Purchasing updates the source status on the requisition line to <i>In Progress</i>, and the requisition cannot be sourced or modified.</p> <p>The requisition open amounts and quantities are updated when the RFQ is awarded to the purchase order or contract.</p> <p>The requisition's associated PeopleSoft Maintenance Management work order information and pegging information is passed to the purchase order when the RFQ is awarded to a purchase order.</p> <p>If you cancel an RFQ copied from a requisition, the system sets the open quantity and amount to the original values.</p>

Selection Criteria

Field or Control	Description
Business Unit	Displays the business unit from the RFQ. The system uses this business unit to search for eligible documents.
Select Req Lines (select requisition lines)	<p>Select the types of requisition lines to retrieve to the Select Lines to Copy page, where you can select the lines that you want to copy to the RFQ. Values are:</p> <ul style="list-style-type: none"> • <i>RFQ Not Required</i>: Select to retrieve requisition lines for which RFQs are not required. • <i>RFQ Required</i>: Select to retrieve requisition lines for which RFQs are required. • <i>Req Lines</i> (requisition lines): Select to retrieve any eligible requisition lines.
Copy Method	<p>Determines the method by which lines that you select on the Select Lines to Copy page are copied to the RFQ.</p> <p>When you copy to the first RFQ line, the only available value is <i>Override Existing RFQ</i>. When you copy to subsequent lines, you can select this option to have the current copy selection override all existing RFQ lines.</p> <p>When you copy to subsequent lines, you can select the <i>Append to Existing RFQ</i> value to add the current copy selection to the existing RFQ.</p>

Copy Criteria

The fields that appear in the **Copy Criteria** group box depend on the value that you select in the **Copy From** field. The lines retrieved and available for selection on the Select Lines to Copy page depend on the selections here.

Field or Control	Description
Exclude Auto Source Item	Select this check box to exclude lines that contain items marked for automatic sourcing.
Include Inventory Items	Select this check box to include only lines that contain inventory items.

Field or Control	Description
Stockless Item	Select this check box to retrieve only stockless items, which are items from par replenishment.
Include Reqs With No Supplier (include requisitions with no supplier)	Select this check box to include requisitions with no suppliers.
Copy all Req/RFQ lines (copy all requisitions/RFQ lines)	Select this check box to have the system copy all the requisition or RFQ lines to the new RFQ. If you select this check box, you must specify a requisition or RFQ ID in the Copy Criteria group box. If you leave this check box clear, you can select the lines that you want from the Select Lines to Copy page.
OK	If you do not select the Copy all Req/RFQ lines check box, click this button to access the Select Lines to Copy page, where you can view and select lines to copy to the RFQ.

Related Links

[Understanding Commitment Control in PeopleSoft Purchasing](#)

Item Supply Supplier List Page

Use the Item Supply Supplier List page (RFQ_VND_ITEM_SEC) to search for the suppliers defined as suppliers of a particular RFQ line item.

Select the suppliers that you want to add to the suppliers available on the Dispatch Supplier List page.

Navigation:

Click the **Item Suppliers** link on the Request Quotes page.

Suppliers

Select the item suppliers that you want to add to the suppliers available on the Dispatch Supplier List page. The suppliers that appear are suppliers for which item supplier relationships have been established on the Purchasing Attributes - Item Supplier page.

Related Links

[Purchasing Attributes -Item Supplier \(ITM_VENDOR\)Page](#)

RFQ Dispatch Supplier List Page

Use the RFQ Dispatch Supplier List page (RFQ_DISPATCH_SEC) to select the suppliers to whom you want to send the RFQ.

Navigation:

Click the **Dispatch Supplier List** link on the Request Quotes page.

Supplier Group

<i>Field or Control</i>	<i>Description</i>
Quote Group ID	Select a supplier quote group ID to make the group the dispatch supplier list for the RFQ. You can add or delete suppliers from the list on this page without affecting the original group from which you loaded them. Alternatively, you can create a supplier list by adding suppliers directly to the Suppliers group box.

Suppliers

<i>Field or Control</i>	<i>Description</i>
Sel (select)	Select the supplier for which you want to view information on the pages accessible from this page.
To Dispatch	Select this check box for the supplier that you want to dispatch the RFQ to. You can select this check box to dispatch to one supplier at a time.
Method	<p>Select the RFQ dispatch method. Values are:</p> <p><i>EDX</i>: Select to dispatch by using any EDX method.</p> <p><i>Email</i>: Select to dispatch by email. You must have a valid email address set up for the supplier to use this option. Set the supplier email address on the Supplier Information - Address page.</p> <hr/> <p>Note: When PeopleSoft eSupplier Connection is installed, the email includes a URL that enables suppliers to review and respond to the RFQ by using a standard web browser.</p> <hr/> <p><i>Fax</i>: Select to dispatch by fax.</p> <p><i>Phone</i>: Select to dispatch by phone.</p> <p><i>Print</i>: Select to dispatch by print.</p>

Related Links

[Dispatching RFQs](#)

“Entering Supplier Addresses” (PeopleSoft Source to Settle Common Information)

Dispatch Options Page

Use the Dispatch Options page (RFQ_DISP_OPTIONS) to enter dispatch options for the RFQ to dispatch it to the supplier.

This page becomes available when you select a supplier on the RFQ Dispatch Supplier List page and click the To Dispatch check box for the supplier.

Navigation:

Click the **Dispatch** button on the Request Quotes page.

Field or Control	Description
Test Dispatch	Select this check box to test the dispatch but not actually dispatch the RFQ to the supplier.
Print Copy	Select this check box to print a copy of the dispatch. Use this check box if the dispatch method is something other than print and you need a hard copy for your files.
Print Duplicate	Select this check box to print the word "Duplicate" in the header section of the RFQ printout.
Fax Cover Page	If the dispatch method is fax, enter the location of the fax cover page file.
Server Name	Select the name of the server on which you want this print request to be queued and processed.
Output Destination Type	Specify the destination to which you want the RFQ dispatched: <i>FILE</i> , <i>PRINTER</i> , or <i>WEB</i> .
Output Destination Format	Select the format of the dispatch file. Select the appropriate format based on how you want to send the file to the supplier. Values are: <i>CSV</i> : Comma delimited (*.csv). <i>HP</i> : HP format (*.lis). <i>HTM</i> : HTML documents (*.htm). <i>LP</i> : Line printer format (*.lis). <i>PDF</i> : Acrobat (*.pdf). <i>PS</i> : Postscript (*.lis). <i>SPF</i> : SQriBE Portable Format (*.scb).

<i>Field or Control</i>	<i>Description</i>
OK	Click this button to dispatch the RFQ. The system uses the dispatch method set up on the RFQ Dispatch Supplier List page.

RFQ Dispatch History Page

Use the RFQ Dispatch History page (RFQ_DISP_DSPLY) to view the supplier location, date, and time that the RFQ was dispatched.

Navigation:

Click the **Dispatch History** link on the Request Quotes page.

<i>Field or Control</i>	<i>Description</i>
Fax Dir (fax directory)	If the RFQ was dispatched by fax, the system displays the directory in which the fax file created by the dispatch process was saved.
File Name	Displays the file name assigned to the fax file created by the dispatch process.

Email Message Page

Use the Email Message page (WV_PE_EMAIL_SP) to send an email to someone regarding the quote.

This email includes links to take a supplier to the Request for Quotes List page (if the installation includes PeopleSoft eSupplier Connection) or links to take the email recipient to the Request for Quotes or the Maintain Responses page.

Navigation:

Click the **Send Email** link on the Request Quotes page.

This example illustrates the fields and controls on the Email Message page. You can find definitions for the fields and controls later on this page.

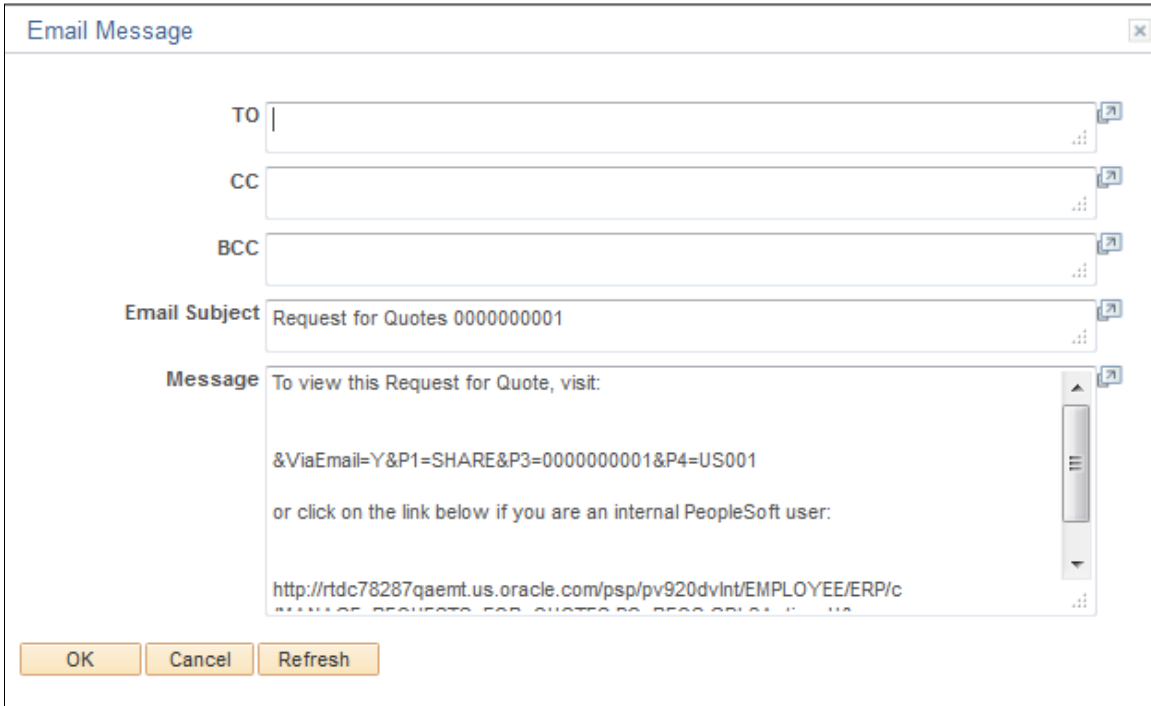

Field or Control	Description
Message	Displays the text of the message, including links that can take a supplier to the Request for Quotes List page (when PeopleSoft eSupplier Connection is installed) or links that can take an email recipient to the Request Quotes page or the Maintain Responses page.
OK	Click this button to send the email.

Dispatching RFQs

This section provides an overview of the RFQ Dispatch and Print process and discusses how to run the RFQ Dispatch/Print process.

Page Used to Dispatch RFQs

Page Name	Definition Name	Usage
<u>Dispatch Quote Forms Page</u>	RUN_PORFQ01	Define selection criteria and run the RFQ Dispatch/Print process, the Email process, or the RFQ Dispatch & Email multiprocess job.

Understanding the RFQ Dispatch and Print Process

The RFQ Dispatch/Print SQR Report process (PORFQ01) dispatches the RFQs one at a time or in volume in the background. This section discusses how to run the RFQ Dispatch/Print process.

When you run the RFQ Dispatch/Print process from the Dispatch Quote Forms page, you dispatch the RFQ. For hard copy reports only, select the Print Copy check box and specify the number of copies that you want. There is no separate page used to produce a report only.

When you run this process from the Dispatch Quote Forms page, on the Process Scheduler Request page you have three choices:

Term	Definition
RFQ Dispatch & Email multiprocess job (RFQDISP)	Select to run the RFQ Dispatch/Print SQR process (PORFQ01) and then the Email Application Engine process (PO_RFQ_EMAIL).
RFQ Dispatch/Print SQR Report process (PORFQ01)	Select to run only the RFQ Dispatch/Print process.
Email Application Engine process (PO_RFQ_EMAIL)	Select to run only the Email process.

When you use the email dispatch method, the RFQ Dispatch/Print process creates an output file in the location that you specify on the File Locations page. The Email process picks up the output file from the specified location and sends out an email message with the RFQ as an attachment. When the dispatch method is fax, the dispatch process creates an RFQ file and a fax control file in the locations that you specify on the File Locations page.

Dispatching RFQs by email requires that you run two processes: the RFQ Dispatch/Print process and the Email process.

To dispatch by email, you first must run the RFQ Dispatch/Print process to update the RFQ email queue table. You must then run the Email process.

The Email process is an Application Engine process that picks up the email output file created by the RFQ Dispatch/Print process in the location specified on the File Locations page and generates an email through the Simple Mail Transfer Protocol gateway. For ad hoc email notifications, it sends out a notification message without a file attachment; for email dispatches, it sends out a message with an RFQ document attached.

If you specify an RFQ contact on the Supplier Details page, the Email process sends the email to the address that you specify in the Email ID field on the Supplier Information - Contacts page. If you do not specify a supplier contact on the RFQ, the Email process sends the email to the address that you specify in the Email ID field on the Supplier Information - Address page:

- If PeopleSoft eSupplier Connection is installed, the email includes a URL link that directs the email recipient to the pages where the recipient can review and respond to the RFQ.
- If PeopleSoft Application Portal is installed, the Email process can also generate a tasklist entry, which appears on the Integrated Task List pagelet on the organization extranet homepage.

To simplify dispatching by email, you can use the RFQ Dispatch & Email multiprocess job on the Process Scheduler Request page that you access from the Dispatch Quote Forms page. The RFQ Dispatch & Email multiprocess job automatically runs the RFQ Dispatch/Print process and then the Email process.

If the dispatch method is EDX, the RFQ Dispatch/Print process does not create an output file but updates these EC outbound tables: RFQ_DISP_HDR_EC and RFQ_DISP_PLN_EC.

Related Links

[Dispatch Quote Forms Page](#)

“Understanding the eRFQ Feature” (PeopleSoft eSupplier Connection)

Dispatch Quote Forms Page

Use the Dispatch Quote Forms page (RUN_PORFQ01) to define selection criteria and run the RFQ Dispatch/Print process, the Email process, or the RFQ Dispatch & Email multiprocess job.

Navigation:

Purchasing > Request for Quotes > Dispatch Quotes > Dispatch Quote Forms

Process Request Parameters

<i>Field or Control</i>	<i>Description</i>
Fax Cover Page	Select the cover sheet to use for RFQs dispatched by fax in the same run of the process.

Miscellaneous Options

<i>Field or Control</i>	<i>Description</i>
Test Dispatch	Select to do a test dispatch and run the RFQ Dispatch/Print process. If you select this check box, the process runs as usual, but the RFQs are not dispatched and their statuses are not updated.
Print Duplicate	Select to print the word <i>Duplicate</i> in the header section of the RFQ printout.
Print Copy	Select to produce a printed copy of each RFQ processed. If any of the purchase orders processed are by phone, fax, email, or EDX, the system prints a hard copy for review.
Number of Copies	If you select to print a copy, enter the number of copies that you want to print.

Related Links

[Dispatching RFQs](#)

Loading RFQ EDX Responses

This section provides an overview of the Load RFQ EDX Responses process and lists the page used to run the Load Inbound RFQ Responses process.

Page Used to Load RFQ EDX Responses

<i>Page Name</i>	<i>Definition Name</i>	<i>Usage</i>
Load Responses Page	RUN_RFQ_RESPONSE	Run the Load Inbound RFQ Responses process.

Understanding the Load RFQ EDX Responses Process

Use the Load Inbound RFQ Responses Application Engine process (PO_RFQLOAD) to load RFQ responses received through EDX. RFQ responses can be received through EDI with the 843 transaction.

After running the EDI Inbound Agent, accessed through PeopleTools or Process Inbound EC Agent, you must run the Load Inbound RFQ Responses process. The Load Inbound RFQ Responses process adds the supplier responses to the PeopleSoft tables.

Related Links

“PeopleSoft Electronic Data Interchange” (PeopleSoft Electronic Data Interchange)

Using the RFQ EIP

This section provides an overview of the RFQ EIP and discusses how to Use the RFQ EIP.

Pages Used to Use the RFQ EIP

<i>Page Name</i>	<i>Definition Name</i>	<i>Usage</i>
Request Quotes Page	RFQ_HDR	Create an RFQ.
“Publish Outbound Message Page” (PeopleSoft Supply Chain Management Integration)	IN_RUN_PUB_MSG	Initiate the outbound message publish process for outbound PeopleSoft SCM service operations.
RFQ Message Selection Criteria Page	PO_RUN_RFQ	Launch the Request for Quotation outbound transaction.

Understanding the RFQ EIP

The RFQ EIP sends requests for quotation to potential sellers of goods and services. This asynchronous batch publish EIP also supports flat-file processing for EDI transaction X.12 840.

Use this EIP to dispatch requests for quotes to suppliers, usually using EDI.

Run the RFQ Dispatch/Print process to stage the RFQ.

Use the common Publish Outbound Message page to initiate the PO_RFQ Application Engine process that processes the PO_REQUEST_FOR_QUOTE service operation.

Setting Up the RFQ EIP

PeopleSoft delivers the service operations in PeopleSoft Integration Broker with a default status of *Inactive*. You must activate each service operation before attempting to send or receive data from a third-party source or another PeopleSoft system, such as CRM.

Before you can use the RFQ EIP, you must:

1. Setup the service operation within PeopleSoft Integration Broker and Enterprise Components:

Use the information in the table below and refer to the setup instructions in the PeopleSoft Supply Chain Management Integration 9.2, "Implementing Integrations", Setting Up Service Operations section.

<i>Service Operation</i>	<i>Direction and Type</i>	<i>Handlers</i>	<i>Chunking Available?</i>	<i>Integrates With</i>
PO_REQUEST_FOR_QUOTE	Outbound Asynchronous	ROUTERSENDHDLR	Yes	third-party system EDI transaction X.12 840

2. On the RFQ, specify EDX as the RFQ dispatch method.

See the product documentation for *PeopleTools: Integration Broker*

Related Links

“Setting Up Service Operations” (PeopleSoft Supply Chain Management Integration)

RFQ Message Selection Criteria Page

Use the RFQ Message Selection Criteria page (PO_RUN_RFQ) to launch the Request for Quotation outbound transaction.

Navigation:

Select Request for Quotation on the Publish Outbound Message page to enable the Request for Quotation link. Click the **Request for Quotation** link to launch the RFQ Message Selection Criteria page.

Field or Control	Description
Selection Type	Select <i>Select Ven</i> (select suppliers) to deliver staged RFQs based on the suppliers invited. Select <i>Select BU</i> (select business unit) to deliver staged RFQs based on the business units from which the RFQ originated.
BU Sel Type (business unit selection type)	Select <i>1 Bus Unit</i> to process RFQs that originated from a specific business unit. Select <i>All BUs</i> (all business units) to process all RFQs originating from all business units. This field is available for entry only when you select <i>Select BU</i> in the Selection Type field.
Business Unit	Select a business unit. This field is available for entry only when you select <i>1 Bus Unit</i> in the BU Sel Type field.
Supplier Selection Type	Select <i>All Supplier</i> to process all RFQs designated for deliver to all suppliers. Select <i>1 Supplier</i> to process RFQs designated for deliver to a specific supplier. This field is available for entry only when you select <i>Select Ven</i> in the Selection Type field.
Supplier SetID	Select a valid supplier SetID. This field is available for entry and required only when you select <i>1 Supplier</i> in the Supplier Selection Type field.
Supplier ID	Select a valid supplier ID. This field is available for entry and required only when you select <i>1 Supplier</i> in the Supplier Selection Type field.
Location	Select a valid supplier location code. This field is available for entry only when you select <i>1 Supplier</i> in the Supplier Selection Type field.

Using the RFQ Response EIP

This section provides an overview of the RFQ Response EIP and discusses how to use the RFQ Response EIP.

Pages Used to Use the RFQ Response EIP

Page Name	Definition Name	Usage
Load Responses Page	RUN_RFQ_RESPONSE	Run the Load Inbound RFQ Responses process.

Page Name	Definition Name	Usage
Data Collection Setup Page	BCT_SETUP_FS	Set the option to keep transaction log history for electronic data collection transactions and to set the default file suffix.
“Data Def Maint Page” (PeopleSoft Supply Chain Management Integration)	EO_EIP_CTL_MAINT	View data detail or correct errors for subscribe messages that contain data rather than transactions.

Understanding the RFQ Response EIP

The RFQ Response EIP processes service operations that receive supplier responses to RFQs.

This asynchronous batch subscribe EIP also supports flat-file processing for EDI transaction X.12 843.

Run the Load Inbound RFQ Responses process to move the service operation data from staging tables to application tables.

Using the RFQ Response EIP

PeopleSoft delivers the service operations in PeopleSoft Integration Broker with a default status of *Inactive*. You must activate each service operation before attempting to send or receive data from a third-party source or another PeopleSoft system, such as CRM.

Before you can use the RFQ Responses EIP, you must:

1. Setup the service operation within PeopleSoft Integration Broker and Enterprise Components:

Service Operation	Direction and Type	Handlers	Chunking Available?	Integrates With
PO_REQUEST_FOR_QUOTE_RESPONSE	Inbound Asynchronous	PO RequestForQuoteResponse	No	third-party system EDI transaction X.12 843.

2. Run the Load Inbound RFQ Responses process to move the service operation data from staging tables to application tables.
3. Use the Data Def Maint page to view service operation data and correct error messages that are picked up in the processing of the service operation.

See the product documentation for *PeopleTools: Integration Broker*

Related Links

- “Setting Up Service Operations” (PeopleSoft Supply Chain Management Integration)
- “PeopleSoft Electronic Data Interchange” (PeopleSoft Electronic Data Interchange)

Resolving Supplier Response Load Errors

This section discusses how to correct supplier response errors.

After you have made the necessary corrections, you can run the Load Inbound RFQ Responses process.

Pages Used to Resolve Supplier Response Load Errors

<i>Page Name</i>	<i>Definition Name</i>	<i>Usage</i>
Response Errors Page	RFQ_RESP_ERROR	Resolve supplier response errors and mark corrected responses for reprocessing.
Item Description	RFQ_ITEM_1_DESCR	View descriptions for a specific item.
Header Errors	RFQ_RESP_HDR_ERR	View messages that describe header-level errors found in RFQ responses.
Line Errors	RFQ_RESP_ERR_MSG	View messages that describe line-level errors found in RFQ responses.

Response Errors Page

Use the Response Errors page (RFQ_RESP_ERROR) to resolve supplier response errors and mark corrected responses for reprocessing.

Navigation:

Purchasing > Request for Quotes > Resolve Load Errors > Response Errors

<i>Field or Control</i>	<i>Description</i>
Reprocess RFQ Response	Select this check box to enable the Load Inbound RFQ Responses process to reprocess the corrected RFQ responses.
RFQ ID	Select the RFQ ID number.
Supplier ID	Select the ID number of the supplier.
Terms	Select payment terms agreed upon.
Currency	Select the currency that the supplier response is in.

<i>Field or Control</i>	<i>Description</i>
Date Time Responded	Displays the date and time that the supplier responded. This value appears by default from the Enter Responses - RFQ Response page.

Line Info

Select the Line Info tab.

<i>Field or Control</i>	<i>Description</i>
UOM (unit of measurement)	Displays the unit of measurement that the supplier plans to use.

More Details

Select the More Details tab.

<i>Field or Control</i>	<i>Description</i>
Quantity	Displays the amount that you requested.
Min Qty (minimum quantity)	Displays the minimum amount that you can order from this supplier.
RFQ Price	Displays the cost that the supplier will charge for this item.
Ship Via	Displays the shipping method that the supplier plans to use.
Freight Trm (freight term)	Displays the agreed upon freight terms for this item.

Maintaining RFQ Responses

This section discusses how to:

- Maintain supplier responses.
- View supplier response header details.

As you receive supplier responses to the RFQs, you can enter them into the database for analysis. To better evaluate and compare all responses, the system converts them to the currency established on the

RFQ header. You may receive the RFQ responses through EDX format or you can enter them into the PeopleSoft system. Either way, you are able to review all responses together.

Note: If the installation includes PeopleSoft eSupplier Connection, suppliers can enter their RFQ responses directly into the PeopleSoft system (and a history of supply-side responses is maintained for each RFQ item). Furthermore, if additional collaboration is required, the buyer can clear the **Responded** check box on the RFQ line to reset the RFQ line status to *New* in PeopleSoft eSupplier Connection, enabling the supplier to override previously submitted responses.

Pages Used to Maintain RFQ Responses

Page Name	Definition Name	Usage
<u>Maintain Responses Page</u>	RFQ_RESPONSE_LN	Enter responses from suppliers into the database for analysis, or if the installation includes PeopleSoft eSupplier Connection, view and edit supplier-entered responses. Once an RFQ has been awarded, the fields on this page are no longer available for entry.
Item Description Page	RFQ_ITEM_2_DESCR	View descriptions for a specific item.
RFQ DOC Status Page(request for quote document status)	PRCR_DOCSTAT_INQ	Access and review information about procurement documents associated with an RFQ.
RFQ Currency Information Page	EXCH_RT_DTL_INQ	View the rules used to calculate exchange rates for the transaction.
<u>Response Header Details Page</u>	RFQ_RESP_HDR_SEC	View supplier response method and contact information.
Address Page	RFQ_RESP_ADDR_SEC	View address details for the location relevant to the link selected.
Response Comments Page	RFQ_RESP_CMT_SEC	Enter response comments for the RFQ. The comments that you enter here can also be viewed on the Response Comments page accessed from the Response by Supplier page.

Page Name	Definition Name	Usage
Email Message Page	WV_PE_EMAIL_SP	Send an email to someone regarding the quote. This email includes links that can take suppliers to the Request for Quotes List page (if the installation includes PeopleSoft eSupplier Connection) or links that can take email recipients to the Request Quotes page or the Maintain Responses page.

Related Links

“Reviewing and Responding to RFQs” (PeopleSoft eSupplier Connection)

Maintain Responses Page

Use the Maintain Responses page (RFQ_RESPONSE_LN) to enter responses from suppliers into the database for analysis, or if the installation includes PeopleSoft eSupplier Connection, view and edit supplier-entered responses.

Once an RFQ has been awarded, the fields on this page are no longer available for entry.

Navigation:

Purchasing > Request for Quotes > Add/Update Supplier Responses > Maintain Responses

This example illustrates the fields and controls on the Maintain Responses page. You can find definitions for the fields and controls later on this page.

Field or Control	Description
Terms	Displays payment terms of the supplier response.
Currency	Displays the currency of the supplier response.

Line Info

Select the Line Info tab.

Field or Control	Description
Supplier Responded	<p>Select to indicate that the supplier has responded and that the RFQ is ready to be awarded. You can respond to individual lines by selecting the Supplier Responded check box directly or you can respond to all lines or clear all lines by using the Select All or Clear All buttons. This check box is unavailable when the RFQ is awarded.</p> <hr/> <p>Note: If the installation includes PeopleSoft eSupplier Connection, suppliers can enter their own RFQ responses directly into the PeopleSoft system. When a supplier submits an RFQ response, the system automatically selects this check box and displays the Supplier History button.</p> <hr/> <p>You can also reopen the line for a new supplier response by clearing the Supplier Responded check box and clicking Save. You can also change the Quantity, Price, or Due Date values, but must clear the Supplier Responded check box to change the RFQ status to <i>New</i>, and make it available for further supplier response from within PeopleSoft eSupplier Connection.</p> <p>When communicating with a supplier in this scenario, it is suggested that you generate an email by using the Send Email link instead of entering comments by using the Response Comments link. The Response Comments page is intended to enable the buyer to manually enter supplier comments received from another source; they appear as supplier header comments (not buyer comments) on the Request for Quote Response page in PeopleSoft eSupplier Connection.</p>
Req Price (requisition price)	Displays the requisition price for the item. This appears only if the line item was copied from a requisition; otherwise, this field is blank.

More Details

Select the More Details tab.

Field or Control	Description
Supplier History	Click this button to access the Request for Quote History page in PeopleSoft eSupplier Connection, where you can view the original RFQ details and supplier-entered responses by date time. This button is visible only when PeopleSoft eSupplier Connection is installed and the supplier has submitted an RFQ response directly into the system. This history can be useful when recollecting supplier responses to specific RFQ lines at a particular time.

Related Links

“Understanding the eRFQ Feature” (PeopleSoft eSupplier Connection)

Response Header Details Page

Use the Response Header Details page (RFQ_RESP_HDR_SEC) to view supplier response method and contact information.

Navigation:

Click the **Response Header Details** link on the Maintain Responses page.

Field or Control	Description
Response Method	Select the manner in which the response was received: <i>Fax</i> , <i>Phone</i> , <i>Print</i> , and <i>EDX</i> . If the response was sent through EDX, the system completes this field automatically. Note: The system identifies supplier-entered online RFQ responses from PeopleSoft eSupplier Connection as having a <i>Print</i> response method.
Billing Address	Click to view the details of the current billing address.
Address Seq (address sequence)	Select a location that is associated with the supplier, such as corporate office or sales center.
Address	Click to view the details of the address that appears in the Address Seq field.

Awarding RFQs to Suppliers

This section discusses how to analyze and award quotes.

Pages Used to Analyze and Award RFQs to Suppliers

<i>Page Name</i>	<i>Definition Name</i>	<i>Usage</i>
<u>Analyze Quote Page</u>	RFQ_AWARDS	View RFQ lines one at a time, analyze the supplier response, and award quotes to suppliers from whom quotes have been entered.
RFQ Currency Information Page	EXCH_RT_DTL_INQ	View the rules used to calculate exchange rates for the transaction. <u>Analyze Quote Page</u>
RFQ DOC Status Page(request for quote document status)	PRCR_DOCSTAT_INQ	Access and review information about procurement documents associated with an RFQ. <u>Analyze Quote Page</u>

Analyze Quote Page

Use the Analyze Quote page (RFQ_AWARDS) to view RFQ lines one at a time, analyze the supplier response, and award quotes to suppliers from whom quotes have been entered.

Navigation:

Purchasing > Request for Quotes > Award Quotes > Analyze Quote

When you save this page, if you have *not* already established an item supplier relationship for the selected item supplier combination, the system asks you if you want to create it. If you choose to create the relationship, the ITM_VENDOR table inserts a new row for this item supplier combination. If you choose not to create the data, you can still continue the analysis and award of RFQ responses.

<i>Field or Control</i>	<i>Description</i>
Award List of Items to Supplier	Select a value to award the entire RFQ to one supplier.

List of Items to Award

The **RFQ Lines** scroll area displays the terms of the original RFQ.

List of Supplier Who Responded

Use the **RFQ Award Supplier** scroll area to analyze supplier responses, award quantities, and enter comments for each RFQ line.

Line Info

Select the Line Info tab.

Field or Control	Description
Qty Award (quantity award)	Enter quantities to award to the supplier. You can award the entire RFQ line quantity to a single supplier or share the line quantity among multiple supplier.
Total Qty Awarded (total quantity awarded)	Displays the total quantity awarded to all suppliers.
Order Qty (order quantity)	Displays the total quantity ordered from all suppliers.

More Details

Select the More Details tab.

Field or Control	Description
Minor Ind (minority indicator)	Displays the minority indicator for applicable suppliers. This information is supplied by the supplier.

Creating Purchase Orders or Contracts from RFQs

This section discusses how to create purchase orders or contracts from RFQs

The purchase orders that you create here are placed in the PeopleSoft Purchasing stage tables, where they can be picked up by the sourcing processes. The contracts that you create here and the contract release defaults for the RFQ business unit are automatically generated after you save the data on the Create PO/Contract page.

Pages Used to Create Purchase Orders or Contracts from RFQs

Page Name	Definition Name	Usage
<u>Create PO/Contract (create purchase order/contract) Page</u>	RFQ_GEN_PO	View the awarded suppliers of a specified RFQ and create a purchase order or contract based on the supplier and line item response.
Item Description Page	RFQ_ITEM_2_DESCR	View descriptions for a specific item.
<u>RFQ PO Distribution (request for quote purchase order distribution) Page</u>	RFQ_DISTRIB_SEC	Define multiple distributions for the purchase order schedule that you are creating from the RFQ.

Page Name	Definition Name	Usage
Asset Information Page	RFQ_DST_AM_SEC	Enter asset information for an eligible item.

Related Links

“Understanding Voucher and Order Contracts” (PeopleSoft Source to Settle Common Information)
[Maintaining RFQ Responses](#)

Create PO/Contract (create purchase order/contract) Page

Use the Create PO/Contract (create purchase order/contract) page (RFQ_GEN_PO) to view the awarded vendors of a specified RFQ and create a purchase order or contract based on the supplier and line item response.

Navigation:

Purchasing > Request for Quotes > Award Quotes > Create PO/Contract

This example illustrates the fields and controls on the Create PO/Contract page. You can find definitions for the fields and controls later on this page.

The screenshot displays the 'Create PO/Contract' page. At the top, there are tabs for 'Analyze Quote' and 'Create PO/Contract'. Below the tabs, the 'Business Unit' is set to 'US001' and the 'RFQ ID' is '0000000004'. A 'List of Suppliers who Responded' section shows 'CAMPERS-001' as the selected supplier. The 'Create Form Type' is set to 'Purchase Order' and the 'PO Type' is 'General'. The 'PO/Contracts Defaults' section includes fields for Buyer, PO Date (01/17/2013), Dispatch Method, Tax Exempt Flag, Origin, Ship To (US001), Location, Match Action (Standard), and Match Rule (STANDARD). The 'List of Items to Award' table has the following data:

Select	Line	Item ID	Item Description	Quantity Ordered	PO Qty	Qty Award	Distribute By
<input type="checkbox"/>	1	10071	Compact Binoculars, 10x25	500.0000		500.0000	Qty

At the bottom of the page, there are navigation buttons: Save, Return to Search, Previous in List, Next in List, Notify, and Refresh. The footer shows 'Analyze Quote | Create PO/Contract'.

List of Suppliers who Responded

<i>Field or Control</i>	<i>Description</i>
Create Form Type	<p>Select a value to create a purchase order or a contract for the lines awarded to a supplier. Values are:</p> <p><i>Contracts RFQ/Resp. Currency</i> (contracts RFQ and response currency): Select to create a contract in the response currency and to have an entry in the UOM/Pricing table on the contract for each currency. With this feature, you can select the default price and currency to be used on the contract releases and ultimately the purchase order.</p> <p><i>Contracts Response Currency</i>: Select to create a contract in the response currency. The entry in the UOM/Pricing table on the contract appears in the response currency.</p> <p><i>Purchase Order</i>: Select to create a purchase order in the response currency.</p> <hr/> <p>Note: If the requisition associated with the RFQ has pegging information then you cannot create a contract from the RFQ. For example, if the requisition associated with the RFQ has PeopleSoft Maintenance Management work order information you will not be able to create a contract from the RFQ only a purchase order. The purchase order will contain the pegging information associated with the requisition.</p>
Create	Select this check box to create the contract or purchase order.
PO Type (purchase order type)	<p>Select a purchase order type:</p> <p><i>General</i>: Designates a general purchase order.</p> <p><i>Kanban</i>: Designates a Kanban purchase order.</p>

PO/Contracts Defaults

<i>Field or Control</i>	<i>Description</i>
Dispatch Method	Select a dispatch method for either the purchase order or contract.
Tax Exempt Flag	Designates whether the purchase order is exempt from sales and use taxes.

Field or Control	Description
Exempt ID	If the Tax Exempt Flag check box is selected, the tax exempt ID appears by default from the business unit if it is set up with tax exempt status. The tax exempt ID prints on the purchase order.
ID	Indicates the ID of the purchase order or contract to be created. If you have autonumbering enabled, the field value is <i>NEXT</i> , and the ID is automatically generated by the system.
Origin	Displays the origin of the purchase order or contract. Origin codes are established on the Origin Codes page and help identify the origins of the transactions.
Ship To	Displays the ship to information defined on the User Preferences - Procurement: Request for Quote Process page. Ship to information assigned to purchase orders usually appears by default from the ship to value entered on the Request Quotes page and the Enter Responses - Maintain Responses page. The ship to address designated on the Maintain Responses page overrides the ship to defined on the Request Quotes page. However, if the ship to value is empty on the Maintain Responses page upon purchase order creation, this ship to value is used.
Location	Displays the user location defined on the User Preferences - Procurement page. Location information assigned to purchase orders usually appears by default from the location value entered on the Request Quotes page.
Match Action	Appears by default from the supplier. If it is not defined there, the value appears by default from the business unit. Values are: <i>No Match</i> : No match is required. <i>Standard</i> : Composed of two-way, three-way, and four-way matching, or any matching rules that you have defined.
Match Rule	Select a match rule. Match rules are defined on the Match Rules page and activated on the Match Rule Control page.

List of Items to Award

Use the **RFQ Lines** group box to select lines that you want to use to create the purchase order or contract.

Field or Control	Description
Distribute by	Select the method by which you want to allocate or charge the expense account distribution. Select <i>Amt</i> (amount) or <i>Qty</i> (quantity). Inventory items cannot be distributed by amount; you must distribute inventory items by quantity.

Related Links

[Understanding Purchase Order Dispatch](#)

[Establishing PeopleSoft Purchasing Business Units](#)

[Purchasing Definition - Document Numbering Page](#)

[Creating RFQs](#)

[Maintaining RFQ Responses](#)

“Defining Origin Codes” (PeopleSoft Source to Settle Common Information)

RFQ PO Distribution (request for quote purchase order distribution) Page

Use the RFQ PO Distribution (request for quote purchase order distribution) page (RFQ_DISTRIB_SEC) to define multiple distributions for the purchase order schedule that you are creating from the RFQ.

Navigation:

Click the **Distribution** link on the Create PO/Contract page.

Details

Select the Details tab.

Field or Control	Description
IN Unit (inventory business unit)	<p>Displays the PeopleSoft Inventory business unit for the distribution. If the purchase order line is for an inventory item, this field appears by default from the ship to location on the Maintain Purchase Order - Schedules page. If the item is an inventory item and a PeopleSoft Inventory business unit is entered on the first distribution line of the schedule, the due date on the Maintain Purchase Order - Schedules page is validated against the PeopleSoft Inventory business unit closure calendar. This is done to ensure that the PeopleSoft Inventory business unit is open to receive merchandise on that day.</p> <p>If the RFQ line is associated with a requisition line that has one or more distributions that are pegged, the IN Unit is unavailable for entry.</p>

<i>Field or Control</i>	<i>Description</i>
Percent	Enter the item distribution percent for the line.

Related Links

[“Understanding PeopleSoft ChartFields” \(Application Fundamentals\)](#)

[Understanding the Purchase Order Business Process](#)

Closing RFQs

This section discusses how to close a RFQ.

Page Used to Close RFQs

<i>Page Name</i>	<i>Definition Name</i>	<i>Usage</i>
Request Quotes Page	RFQ_HDR	Close a RFQ.

Request Quotes Page

Use the Request Quotes page (RFQ_HDR) to close a RFQ.

Navigation:

Purchasing, Request for Quotes, Add/Update RFQs, Request Quotes

You use the **Status** field on the Request Quote page to manually close a RFQ. Request for quotes are not automatically closed after you award them. Use the **Lookup** button to view options for managing a RFQ. Select the *Close* value to complete the RFQ and to update its status to Closed. After you close or cancel the RFQ, you cannot update it or change its status.

Inquiring and Reporting on RFQs and Supplier Responses

PeopleSoft Purchasing includes several inquiries and a report that enable you to review and analyze the RFQ and supplier response data.

This section discusses how to compare request and response values.

Pages Used to Inquire and Report on RFQs and Supplier Responses

Page Name	Definition Name	Usage
All Quotes inquiry Page	RFQ_BY_VNDR	Inquire on all the RFQs sent to a specific supplier.
Supplier Address Page	RFQ_VNDR_SEND_SEC	View supplier address details based on send to, contact, or sales contact information.
Phone Page	VNDR_PHONE_SEC	View the supplier phone information based on send to, contact, or sales contact information.
RFQ Dispatch History Page	RFQ_DISP_DSPLY	View the supplier location, date, and time that the RFQ was dispatched.
Last Updated Page	RFQ_LAST_UPDT_SEC	View the last user to modify the RFQ and the date of the modification.
RFQ Header Comments Page	RFQ_INQ_COMMENTS	View RFQ header comments.
RFQ Header Details By Supplier Page	RFQ_HDR_BY_VNDR	View nonessential additional information regarding the RFQ by supplier.
RFQ Line Details By Supplier Page	RFQ_LINE_BY_VNDR	View RFQ line information.
Item Description Page	RFQ_ITEM_6_DESCR, RFQ_ITEM_5_DESCR	View descriptions for a specific item.
RFQ Line Comments Page	RFQ_INQ_COMMENTS	View RFQ line comments.
View Category Hierarchy Page	CAT_PARENTAGE_SEC	View information about where a category resides in the catalog tree hierarchy.
All Suppliers inquiry Page	RFQ_VNDR_BY_RFQ	Inquire on all suppliers for a specific RFQ that was dispatched.
Response By Supplier inquiry Page	RFQ_RESP_BY_VNDR	View RFQ responses by supplier. If the installation includes PeopleSoft eSupplier Connection, you can view RFQ and supplier response history by using the RFQ Response component in PeopleSoft eSupplier Connection.

Page Name	Definition Name	Usage
Response Comments Page	RFQ_RESP_CMT_SEC	View RFQ response comments.
Response Line Details By Supplier Page	RFQ_RESP_BY_VNDR_LN	View supplier response line details.
<u>Response Information Page</u>	RFQ_RSP_BY_VNDR_DTL	View details of the response.
REQ/RFQ Cross Reference Page (requisitions/request for quote cross reference)	RUN_POY6100	Generate the REQ/RFQ Cross Reference report (POY6100). This report provides a cross-reference between requisitions and the RFQs created from those requisitions.

Response Information Page

Use the Response Information page (RFQ_RSP_BYVNDR_DTL) to view details of the response.

Navigation:

Click the **Response Information** link on the Response Line Details By Supplier page.

Field or Control	Description
Select Currency	<p>Select the currency:</p> <p><i>Resp Curr</i> (response currency): Select to display the prices in the supplier response currency.</p> <p><i>RFQ Cur</i> (RFQ currency): Select to display the prices in the original RFQ currency. If the response currency differs from the RFQ currency, values are converted to the RFQ currency.</p>

Requested

Use this group box to view original RFQ values.

Responded

Use this group box to view supplier response values.

Understanding Purchase Orders

Purchase Order Defaults

Purchase orders contain fields whose values and rules for processing are controlled by the information that you specify at different levels in the default hierarchy. To use the system of defaults available in PeopleSoft Purchasing, configure the purchase order business rules and defaults during the installation phase and maintain them regularly. If you use the purchase order online pages, you can override many of the defaults that you have defined at higher levels of the hierarchy.

When you set up the system, there are pages available that enable you to define the defaults for the typical purchase order. When you create a purchase order online, you do not need to access any other page than the Maintain Purchase Order - Purchase Order page. If you find that you must access pages other than the Maintain Purchase Order - Purchase Order page on a regular basis, consider changing the default hierarchy that you have defined.

Define purchase order default values at various levels of the purchase order hierarchy, such as at the business unit, buyer, or supplier level. These values apply to purchase order lines, schedules, and distributions.

When you add new lines to a purchase order, default values appear by default on lines depending on the settings of the default and override options on the Purchase Order Defaults page. If *Default* is selected, data appears by default on the line from the default hierarchy. If *Override* is selected, data appears by default on the line from the Purchase Order Defaults page. You can override these defaults using the Purchase Order Defaults page. Changing a value on the Purchase Order Defaults page does not affect any purchase order detail that is already associated with a quantity, unless specified by the user. The new defaults are used on any new schedules that you add.

If you modify a value on the Purchase Order Defaults page or any pages accessed from it and there is an existing line on the purchase order, and you click the **OK** button the **Retrofit** field changes to "all" existing PO lines/schedules/distributions page appears. Use this page to specify that you want to apply the changes to existing lines, schedules, and distributions.

Related Links

[Retrofit field changes to all existing PO lines/schedule/distributions Page](#)

[Maintain Purchase Order - Purchase Order Page](#)

[Purchase Order Defaults Page](#)

[Understanding the PeopleSoft Purchasing Default Hierarchy](#)

Purchase Order Header Status Values

The purchase order header status, like all header values, applies to the entire purchase order. The purchase order status is the high-level indication of where the purchase order is in its life cycle. A typical purchase order does not go through every purchase order status.

This table shows each status value that a purchase order can have with its possible receipt and match statuses. The receipt status refers to the extent to which the purchase order has been received. The match status refers to the extent to which the matching process has been completed.

Purchase Order Status	Receipt Status	Match Status
<i>Initial</i>	<i>Not Received</i>	N/A
<i>Open</i>	<i>Not Received</i>	<i>To be Matched</i>
<i>Pending Approval/Approved</i>	<i>Not Received</i>	<i>To be Matched</i>
<i>Approved</i>	<i>Not Received/Partially Received</i>	<i>Partially Matched</i>
<i>Dispatched</i>	<i>Not Received/Partially Received / Received</i>	<i>Partially Matched / Fully Matched</i>
<i>Canceled</i>	N/A	N/A
<i>Pending Cancel</i>	N/A	N/A
<i>Complete</i>	<i>Received</i>	<i>Matched</i>

A purchase order can have a status of *Initial* when you add it to the system manually, if it is a blanket purchase order that you created from a contract, or if it was created through purchase order reservation. A manually entered purchase order remains in *Initial* status until you specify a buyer. Each buyer has an associated default purchase order status of either *Open* or *Pending Approval*. When you specify the buyer, the status of the purchase order changes to the buyer's default purchase order status. When you create a purchase order using the PO Calculations (purchase order calculations) Application Engine process (PO_POCALC) and the Create Purchase Orders Application Engine process (PO_POCREATE), the purchase order begins its life cycle with the status that you defined in the buyer setup.

A purchase order cannot enter the approval process until it is in *Pending Approval* status. There are buttons on the Maintain Purchase Order - Purchase Order page and Buyer's WorkBench that can change the status from *Open* to *Pending Approval*. On the Buyer's WorkBench, there is also a button to reset purchase order statuses back to *Open*.

When the workflow approval process is complete, the purchase order status changes from *Pending Approval* to *Approved*. After it is approved, any change in amount or ChartFields causes the system to return the purchase order status to *Pending Approval*.

Approved purchase orders are available for the PO Dispatch/Print SQR Report process (POPO005). When you dispatch the purchase order, the status changes from *Approved* to *Dispatched*, if the purchase order has a valid budget header status and a valid document tolerance status.

After this point, one of three things can happen to the purchase order status:

- Creating a change order sets the status back to *Approved*.
- Running the Close Purchase Orders Application Engine process (PORECON) changes the status to *Complete*.
- Canceling the entire purchase order changes the purchase order status to *Canceled*.

Canceling a purchase order can be done using the Buyer's WorkBench. A purchase order does not have to be dispatched to be canceled. It can be canceled at any time during its life cycle until it has been received or invoiced. After the quantity has been received or invoiced, you cannot cancel it.

- Canceling a dispatched purchase order changes the purchase order status to *Pending Cancel*.

Re-dispatching the purchase order to the supplier will create a change order, subsequently budget checking (if required) and dispatching will set the purchase order status to *Canceled*.

Related Links

[Maintain Purchase Order - Purchase Order Page](#)

[Understanding the Close Purchase Orders Process](#)

[Running the PO Calculations Process](#)

[Understanding the Buyer's Workbench](#)

SUT Processing on the Purchase Order

PeopleSoft Purchasing supports two different methods for assigning tax rates and amounts on to purchase orders. If you use a third-party tax calculation package, such as Vertex or Taxware, SUT can be assigned to a purchase order schedule by calling the third-party application to perform the tax calculation. In addition, PeopleSoft also provides internal tables to maintain tax rates for instances where a third-party tax provider is not installed. In this case, the internal tax rate tables are used to store tax codes and calculate estimated tax amounts.

SUT rates are usually dependent on the location where the goods are to be used or shipped. For this reason, purchase order SUT amounts are calculated at the schedule level. Two factors that contribute to the calculation are the tax destination and applicability. If you are using PeopleSoft's tax tables, the tax destination and applicability, in addition to other optional factors, such as ultimate use code or category, determine the appropriate tax code, which consists of tax rates. If you use a third-party tax application, the tax destination, applicability, and tax product cross-reference fields (such as ultimate use code) are passed to the application to return tax rates and tax amounts for the schedule.

The tax destination appears by default from the ship to location to the purchase order schedule, where you can override it. The tax destination on the purchase order must be a valid ship to location. Each ship to location definition can include tax exception information, such as whether the location is exempt, direct pay, or active for tax processing.

Use this tax destination to derive the tax applicability. You can establish the tax options for each supplier location on the Tax Options page accessed from the Supplier - Location page. You can set the supplier tax applicability to none, sales, or use. You can also define tax applicability information on the ShipTo Supplier Order Location page. The values that you enter here override the values that you defined for the supplier location. This tax applicability appears by default on the purchase order schedule, where you can modify it.

Once you determine the tax destination and applicability, you can determine the tax rates and amounts for each schedule. If you are using PeopleSoft SUT tables, you will retrieve the tax code and calculate the tax rate. Establish the tax code for each ship to location on the ShipTo Sales/Use Tax Default page. These tax codes search for the entry that most closely matches the schedule line. If you use a third-party application to calculate tax rates and amounts, the tax code field is not required or used as the default on the schedule. PeopleSoft calls the third-party tax provider to return both the rates and the amounts for the appropriate taxing jurisdictions for each schedule.

For example, let's say that you defined a ship to location of ABC01 with ABC tax codes. Sales tax is applicable for all of the suppliers. When you have an order with a ship to location of ABC01, the system automatically calculates the ABC tax for the order. Using this functionality, you have to set up tax codes for suppliers only on an exception basis.

You can define tax codes and tax authorities on the Tax Code page and Tax Authority page.

Related Links

[“Understanding PeopleSoft Tax Solutions” \(PeopleSoft Supply Chain Management Integration\)](#)

[“Defining Ship To Locations” \(PeopleSoft Source to Settle Common Information\)](#)

[“Sales/Use Tax Page” \(PeopleSoft Source to Settle Common Information\)](#)

VAT Processing on the Purchase Order

To use VAT processing, establish the VAT environment and enable the business units for VAT. You can then create purchase orders that include tax amounts, exceptions, recoverable amounts, and rebate amounts. The PeopleSoft General Ledger business unit associated with the PeopleSoft Purchasing business unit must be established in the VAT entity setup in order for purchase orders to be eligible for VAT processing.

The ship from country and seller's VAT registration information appear by default from the supplier. The ship to country and buyer's VAT registration information by default come from the ship to location on the purchase order, which normally appears by default from the buyer. Key components used in VAT calculations (such as the VAT entity, applicability, exception types, transaction types, and treatments) are derived from the VAT setup.

You can view and modify default VAT information on the PO Header - VAT Information (purchase order header - value-added tax information) page. These defaults apply only to new lines. From this page, you can change either the seller's VAT registration country or the buyer's VAT registration country.

Most of the information that the system uses to retrieve and calculate VAT information is established on the purchase order schedule. This may appear by default from the header in combination with the VAT setup. From the schedule, you can view or modify default VAT information. Any changes made to the schedule affect only new distributions.

From the purchase order schedule, you can change the seller's VAT registration country, the buyer's VAT registration country, or the VAT treatment. To update the VAT default fields affected by any of these changes, click the **Adjust Affected VAT Defaults** button. Click the **Reset All VAT Defaults** button if you want the system to reset all of the VAT defaults, including any VAT default fields that you may have changed previously. The system calculates VAT at save time or upon request by clicking the **Calculate** button on the purchase order header.

The system calculates actual VAT amounts and stores this data on the purchase order distribution record. The system computes the VAT amounts in both the supplier's currency and the base currency on the PeopleSoft General Ledger business unit linked to the purchase order. The system adds VAT amounts for both goods and services to the merchandise amount as long as these amounts are not self assessed. VAT amounts are considered part of the purchase order total amount to be invoiced by the supplier.

Related Links

[Creating Purchase Order Headers](#)

[Creating Purchase Order Schedules](#)

[Preparing PeopleSoft Purchasing VAT Environments](#)

Vendor Rebate Processing on the Purchase Order

When creating a purchase order online, the system will automatically assign a vendor rebate agreement to the purchase order line if a vendor rebate agreement is applicable for the supplier and item, item category, or ad hoc item on the purchase order line.

The system uses the supplier on the purchase order or the manufacturer supplier for a group purchasing organization (GPO) manufacturer when assigning a vendor rebate agreement to the purchase order. If the purchase order line is associated with a GPO contract and a supplier has been specified, the system will use this supplier when assigning the vendor rebate agreement. If there is not a supplier associated with the GPO contract then the system will use the supplier on the purchase order. Whether you are using the purchase order supplier or the manufacturer supplier the vendor rebate agreement assignment process is the same.

If there are multiple vendor rebate agreements that could apply to the purchase order line, the system uses a default hierarchy strategy when assigning the vendor rebate agreement to the purchase order line. In all situations, these criteria must be met for the vendor rebate agreements to be available for automatic assignment to the purchase order line:

- Vendor rebate agreements must be approved.
- Vendor rebate agreements begin date and expire date must fall within the purchase order date.
- Vendor rebate agreements purchasing business unit must be the same as that on the purchase order or the vendor rebate agreements are identified as corporate agreements.

Plus, if supplier locations are specified on the purchase order then vendor rebate agreements that have that same supplier location are available for assignment to that purchase order. If no supplier locations are specified on the purchase order then the vendor rebate agreements are available for assignment irrespective of the supplier location.

This table describes the vendor rebate agreement default hierarchy strategy that occurs when assigning a vendor rebate agreement to a purchase order line:

Entry on Purchase Order Line	Vendor Rebate Agreement Default Hierarchy
<p>Item ID is entered.</p>	<ol style="list-style-type: none"> <li data-bbox="865 352 1468 548"> <p>1. Vendor rebate agreements specifically for this item.</p> <p>If a vendor rebate agreement exists just for this item, it will automatically be assigned to the purchase order line. If multiple vendor rebate agreements exist for this item, then the system assigns the vendor rebate agreement with the latest begin date as of the purchase order date.</p> <li data-bbox="865 579 1468 856"> <p>2. Vendor rebate agreements for an item category.</p> <p>If a vendor rebate agreement exists for an item category the system will verify whether the item entered is applicable for this item category. If so, this vendor rebate agreement will automatically be assigned to the purchase order line. If multiple vendor rebate agreements exist for this item category, then the system assigns the vendor rebate agreement with the latest begin date as of the purchase order date.</p> <li data-bbox="865 888 1468 1192"> <p>3. Vendor rebate agreements that are open item rebate agreements.</p> <p>If an open item vendor rebate agreement exists, the system will verify whether the supplier entered is applicable to this supplier agreement. If so, this vendor rebate agreement will automatically be assigned to the purchase order line. If multiple open item vendor rebate agreements exist, then the system assigns the vendor rebate agreement with the latest begin date as of the purchase order date.</p>
<p>Item ID is not entered but description and category are entered.</p>	<ol style="list-style-type: none"> <li data-bbox="865 1255 1468 1533"> <p>1. Vendor rebate agreements for an item category.</p> <p>If a vendor rebate agreement exists for this item category (Include Automatically PO Ad Hoc Items check box is selected on the vendor rebate agreement), it will automatically be assigned to the purchase order line. If multiple vendor rebate agreements exist for this item category, then the system assigns the vendor rebate agreement with the latest begin date as of the purchase order date.</p> <li data-bbox="865 1564 1468 1898"> <p>2. Vendor rebate agreements that are open item rebate agreements.</p> <p>If an open item vendor rebate agreement exists (Include Automatically PO Ad Hoc Items check box is selected on the vendor rebate agreement), the system will verify whether the supplier entered is applicable to this supplier agreement. If so, this vendor rebate agreement will automatically be assigned to the purchase order line. If multiple open item vendor rebate agreements exist, then the system assigns the vendor rebate agreement with the latest begin date as of the purchase order date.</p>

The automatic assignment of the vendor rebate agreement occurs not only when a purchase order line is created, but also when you create a purchase order by copying from other documents, namely requisition, contract, or purchase order. When a purchase order is created from another purchase order, the vendor rebate agreement will be assigned based on the purchase order date of the new purchase order and is not copied from the source purchase order lines.

In addition, the system will go through the vendor rebate agreement assignment process every time these fields are changed on the purchase order:

- Item ID.
- Category ID.
- Supplier ID.
- Supplier Location.
- Manufacturer ID.
- Unit of measure.
- GPO Contract ID.

Note: Changing the purchase order date will not trigger the reassignment of the vendor rebate agreement because the date can be manually overridden.

Finally, subcontracting purchase orders cannot be tied to a vendor rebate agreement. These are purchase orders that are created from PeopleSoft Manufacturing.

Vendor Rebate Security

The rebate security definition that you define for each user using the Procurement - Purchase Order Authorizations page, determines how the rebate ID field is rendered for the purchase order line on the Maintain Purchase Order - Purchase Order, Maintain Purchase Order - Details for Line, and Express Purchase Order - Details for Line pages.

If the Rebate ID Security Control value is *Update* then the **Rebate ID** field and the **Look Up Rebate ID** button appear on the page. The **Rebate ID** field is available for update and the **Look Up Rebate ID** button is active to assist you with vendor rebate agreement assignment.

If the Rebate ID Security Control value is *View Only* then the **Rebate ID** field and the **Look Up Rebate ID** button appear on the page. The **Rebate ID** field is not available for update, and the **Look Up Rebate ID** button is not active.

If the Rebate ID Security Control value is *Hidden* then the **Rebate ID** field and the **Look Up Rebate ID** button do not appear on the page.

Once the purchase order line has a receipt transaction or a vendor rebate accrual transaction associated with it the **Rebate ID** field is unavailable for modification using the Maintain Purchase Order - Purchase Order, Maintain Purchase Order - Details for Line, and Express Purchase Order - Details for Line pages. At this time you would use the Backdate Vendor Rebates page to modify the vendor rebate agreement association with the purchase order line.

Related Links

[“User Preferences – Purchase Order User Authorizations Page” \(Application Fundamentals\)](#)

[Creating Purchase Order Lines](#)

[Using Express Purchase Orders](#)

[Understanding the Backdate Vendor Rebates Component Processes](#)

Procurement Card Processing on the Purchase Order

When creating a purchase order online, the system will automatically assign a procurement card or supplier card to the purchase order from the supplier or buyer if applicable. After the procurement card is assigned by the system the buyer can override the procurement card with another card if they so choose and are authorized. A buyer that does not have a procurement card as a default may assign one given that they have the appropriate security.

If there are multiple procurement cards or supplier cards that could apply to the purchase order, the system uses a default hierarchy strategy when assigning the procurement card or supplier card to the purchase order. The default procurement card hierarchy strategy that occurs when assigning a procurement card to a purchase order is:

- If the supplier location on the purchase order has a supplier card defined for it then the system will assign the supplier card as the payment method on the purchase order.
- If no supplier card exists, then the system will assign the requesters procurement card to the purchase order as payment method if the purchase order was created from a requisition.
- Finally, if no supplier card exists for the supplier location and no procurement cards exist for the requester, then the system will assign the buyers procurement card as payment method on the purchase order.

Related Links

[Using Procurement Cards on Requisitions](#)

[Understanding the Procurement Card Business Process](#)

PeopleSoft Maintenance Management Work Order Processing on the Purchase Order

In PeopleSoft Purchasing you can only associate a PeopleSoft Maintenance Management work order to a purchase order for non-inventory and description only items. Once you make this association, the purchase order schedule is pegged to a work order. You will use the Pegging Workbench to associate work orders to inventory items on a purchase order.

Plus, if the purchase order line is marked as an *amount only* line, you cannot associate PeopleSoft Maintenance Management work order information to that purchase order line.

In PeopleSoft Purchasing there are a few different methods of defining a purchase order to support a PeopleSoft Maintenance Management work order. These methods are:

- PeopleSoft Maintenance Management creates the purchase order staging tables directly so that the PeopleSoft Purchasing sourcing processes (PO Calculations and Create Purchase Order processes) can generate the purchase order.

If the purchase order was created through the purchasing sourcing processes then the fields on Maintain Purchase Order - Schedules page will contain the work order information passed from PeopleSoft Maintenance Management.

- PeopleSoft Maintenance Management creates the requisition staging tables directly so that the PeopleSoft Purchasing Requisition Loader process can generate the requisition. From there the requisition can process through the PeopleSoft Purchasing sourcing processes and a purchase order is generated.

If the purchase order was created through the purchasing sourcing processes and the requisition originated in PeopleSoft Maintenance Management, then the fields on Maintain Purchase Order - Schedules page will contain the work order information passed from PeopleSoft Maintenance Management.

- PeopleSoft Purchasing creates a purchase order through the award RFQ (request for quote) process, and the requisition associated with the RFQ has PeopleSoft Maintenance Management work order information, then the work order information associated with the requisition is passed through the RFQ process and will appear here on Maintain Purchase Order - Schedules page.

Note: You cannot manually associate work order information to a RFQ it must come from a requisition associated with the work order information.

- You manually create the PeopleSoft Maintenance Management work order association directly when defining a purchase order in PeopleSoft Purchasing.

You manually associate PeopleSoft Maintenance Management work order information to a purchase order schedule by selecting existing work order information on Maintain Purchase Order - Schedules page. You can manually associate a maintenance work order to a purchase order schedule even though the item ID on the purchase order does not exist on the work order parts list. A negative price PO line cannot be associated with a Maintenance Management work order.

- You manually create a purchase order in PeopleSoft Purchasing by copying a requisition that is associated with a PeopleSoft Maintenance Management work order.

Using the **Copy From** field on the Maintain Purchase Order - Purchase Order page you can select to copy a requisition when creating a new purchase order. In this case, the work order information is copied from the requisition to the purchase order.

Work Order Modification

When modifying the PeopleSoft Maintenance Management work order information associated with a purchase order there are some things you should keep in mind.

If the purchase order is for a non-inventory item or description only item and is associated with a requisition and you want to change the work order information on the purchase order schedule, you will need to first clear the requisition information on the purchase order distributions by using the **Clear Requisition Information** button on the Maintain Purchase Order - Distributions for Schedule page.

See [Maintain Purchase Order - Distributions for Schedule Page](#).

Plus, if you change the work order information that is already associated with a purchase order schedule, the system will delete the existing purchase order distributions and copy in the work order distributions from the work order itself. Plus, the pegging information will be updated to reflect the new work order information.

Related Links

[Understanding the Purchase Order Sourcing Business Process](#)

[Understanding the Requisition Business Process](#)

[Creating Purchase Order Headers](#)

[Maintain Purchase Order - Schedules Page](#)

“Understanding Pegging” (PeopleSoft Supply Chain Management Common Information)

“PeopleSoft Maintenance Management Setup” (PeopleSoft Maintenance Management)

Purchase Order Consolidation

If you have requisition lines with the same business unit, supplier, and buyer, or just the same business unit and supplier, you can consolidate these lines onto single purchase orders. This feature is useful if you do not want to send multiple purchase orders to the same supplier for the same business unit.

If you consolidate the requisition lines onto a single purchase order, the supplier receives only one purchase order from each business unit (or each business unit and buyer combination) each time that you create purchase orders using the PO Calculations and the Create Purchase Orders processes. When you choose the consolidate option, lines for the same item ID (marked as consolidated) for multiple requisitions will be consolidated onto one line on the purchase order. However, the schedules do not get consolidated. You will see a separate schedule (along with its original distributions) for each schedule on the originating requisitions.

On the requisition, if you choose to consolidate the purchase orders on the Sourcing Controls page, when you order by item ID on a requisition, the requisition line is eligible for consolidation by default. You can override this setting.

When contracts are specified on requisition lines that are marked for consolidation (as allowed by a PO business unit setting), lines with the same item have to have the same contract information in order to be consolidated onto one purchase order line. Like items that do not share identical contract information will still be consolidated onto the same PO, but will occupy separate lines.

Based on the setting for the requisition line, the AutoSelect Requisitions process (PO_REQSORC) marks the line for consolidation when it creates the entry on the PeopleSoft Purchasing stage tables.

These other processes that load the PeopleSoft Purchasing stage tables always set the line on the stage table to *not* consolidated:

- PO Stage Load (PO_POSTAGE).
- Request for Quotes.
- Purchase Order Contracts (PO_POCNTRCT).
- Create Par Replenishment Requests (INPGCDMD).

You can override the consolidation method used by online requisition selection by selecting the **Define PO** (define purchase order) option on the Requisition Selection - Sourcing page. Select this option to create one purchase order for each supplier. Each requisition line that you select appears on its own line, even if it is for the same item. If you select the **Define PO** option, you must define the purchase order here. The PO Calculations process cannot override this setting even if you select the **Consolidation** option.

When you select the **Define PO** option, the information that you view on the Requisition Selection - Sourcing page is exactly what will appear on the purchase order. If you are sourcing to PeopleSoft Inventory or opt to not use the **Define PO** option, the system copies the requisition information to the stage table, and the PO Calculations process uses it.

The consolidation type that you select on the PO Calculations page determines whether purchase orders are consolidated by business unit, supplier, and buyer, or by business unit and supplier only. The consolidation method applies only to staged rows marked for consolidation.

For example, if you decide to consolidate by business unit and supplier only, then all the rows marked for consolidation that go to the same supplier within the same business unit are grouped onto one purchase order even if they have different buyers. If you decide to consolidate by business unit, supplier, and buyer, then all rows marked for consolidation that go to the same supplier within the same business unit and have the same buyer are grouped onto one purchase order.

If one of these conditions exists on the requisition, then consolidation cannot take place:

- You did not select the **Calculate Price** option on the requisition-related Line Details page.
- The supplier is specified on the requisition, and you did not select the **Override Suggested Supplier** option on the requisition-related Sourcing Controls page.
- The requisition item is an ad hoc item (order by description).

Schedules are not consolidated onto the purchase order. Therefore there is a schedule on the purchase order for each requisition schedule.

Staged rows that are not marked for consolidation create a new purchase order for each supplier used on a requisition or other staged entry. So, if two requisitions not marked for consolidation are sourced at the same time, and each requisition has two lines for two different suppliers, the PO Calculations process and the Create Purchase Orders process create four purchase orders.

Related Links

[Details for Line Page](#)

[Creating Requisition Lines](#)

[Automatically Selecting Requisitions for Sourcing](#)

[Creating Purchase Orders Using the Create Purchase Orders Process](#)

[Manually Selecting Requisitions for Sourcing](#)

[Running the PO Calculations Process](#)

Purchase Order Cancellation

You can cancel a purchase order entirely if all of these conditions apply:

- The purchase order is not on hold.
- You are authorized to cancel purchase orders on the User Preferences - Procurement: Purchase Order Authorizations page.
- You are authorized to cancel purchase orders for the buyer on the User Preferences - Procurement: Purchase Order Authorizations page.
- No schedules on the purchase order have been matched.
- No receipts have been recorded against the purchase order.
- No open vouchers have been recorded against the purchase order.
- No open or staged receipts against a blanket purchase order.

Once the system dispatches a purchase order, you can cancel the entire dispatched purchase order or you can cancel all lines without canceling the entire purchase order. On a dispatched purchase order, if you click the **Cancel PO** (cancel purchase order) button, the status of the purchase order changes to *Pending Cancel*. Then once you dispatch the purchase order again, the order is canceled.

Purchase Order Cancellation Processes

To cancel a purchase order not sourced from a requisition that does not require budget checking:

1. Display the purchase order on the Maintain Purchase Order - Purchase Order page.

The purchase order may be in a status of *Open*, *Pending Approved*, or *Approved*.

2. Click the **Cancel PO** button on the Maintain Purchase Order - Purchase Order page.

The system displays a message asking you to confirm the cancellation.

3. Click the **Yes** button to confirm the cancellation of the purchase order.

If the system was able to cancel the purchase order you'll receive a message stating successful cancellation on the Maintain Purchase Order - Cancel Purchase Order page.

If the system was not able to cancel the purchase order you'll receive a message stating that the cancellation was unsuccessful on the Maintain Purchase Order - Cancel Purchase Order page. An unsuccessful cancellation is mostly likely due to a system failure.

If you are canceling a dispatched purchase order, you'll receive a message stating that the purchase order has a pending cancel status and that you must dispatch the purchase order again to change the purchase order status to canceled.

4. Click the **Ok** button on the Maintain Purchase Order - Cancel Purchase Order page.

The system cancels the purchase order, changes the status on the purchase order to *Canceled*, and takes you back to the Add/Update POs component - Search page. Related quantities and amounts are adjusted on the manufacturer/distributor contract, and the released amounts are adjusted as well.

When canceling dispatched purchase orders, the system changes the purchase order status to *Pending Cancel* and takes you back to the Add/Update POs component - Search page. To change the purchase order status to *Canceled* you must dispatch the purchase order again.

To cancel a purchase order not sourced from a requisition that does require budget checking:

1. Display the purchase order on the Maintain Purchase Order - Purchase Order page.

The purchase order may be in a status of *Open*, *Pending Approved*, or *Approved*.

2. Click the **Cancel PO** button on the Maintain Purchase Order - Purchase Order page.

The system displays a message asking you to confirm the cancellation.

3. Click the **Yes** button to confirm the cancellation of the purchase order.

If the system was able to cancel the purchase order you'll receive a message stating that the purchase order was successfully canceled and that the purchase order requires budget checking. The system gives you the option to perform the budget checking process at that time on the Maintain Purchase Order - Cancel Purchase Order page.

If the system was not able to cancel the purchase order you'll receive a message stating that the cancellation was unsuccessful on the Maintain Purchase Order - Cancel Purchase Order page. An unsuccessful cancellation is mostly likely due to a system failure.

If you are canceling a dispatched purchase order, you'll receive a message stating that the purchase order has a pending cancel status but requires a budget check and that you must dispatch the purchase order again to change the purchase order status to canceled. The system gives you the option to perform the budget checking process at that time on the Maintain Purchase Order - Cancel Purchase Order page.

4. Complete the cancellation process.

- Click the **Budget Check** button on the Maintain Purchase Order - Cancel Purchase Order page to perform the budget checking process.

The system cancels the purchase order, changes the status on the purchase order to *Canceled*, performs a budget check, and takes you back to the Add/Update POs component - Search page.

When canceling dispatched purchase orders, the system changes the purchase order status to *Pending Cancel*, performs a budget check, and takes you back to the Add/Update POs component - Search page. Related quantities and amounts are adjusted on the manufacturer/distributor contract, and the released amounts are also changed. To change the purchase order status to *Canceled* you must dispatch the purchase order again.

- Click the **OK** button on the Maintain Purchase Order - Cancel Purchase Order page to not perform the budget checking process.

The system cancels the purchase order, changes the status on the purchase order to *Canceled*, and takes you back to the Add/Update POs component - Search page.

When canceling dispatched purchase orders, the system changes the purchase order status to *Pending Cancel* and takes you back to the Add/Update POs component - Search page.

To perform a budget check on this purchase order you will have to use the Budget Check Request run control page at a later date.

To cancel a purchase order sourced from a requisition that does not require budget checking:

1. Display the purchase order on the Maintain Purchase Order - Purchase Order page.

The purchase order may be in a status of *Open*, *Pending Approved*, or *Approved*.

2. Click the **Cancel PO** button on the Maintain Purchase Order - Purchase Order page.

The system displays a message asking you to confirm the cancellation.

3. Click the **Yes** button to confirm the cancellation of the purchase order.

- If the purchase order can be canceled the Maintain Purchase Order - Cancel Purchase Order page appears asking if you would like to open the requisition quantities to be sourced again. You have these options:

Yes - Re-source all of the requisitions.

No - Do not re-source the requisitions.

Specify the requisitions you want to re-source. If you select this option, select the requisitions you want to re-source in the **Requisitions Available for Re-Sourcing** group box.

- If the purchase order cannot be canceled the Maintain Purchase Order - Cancel Purchase Order page appears displaying the error messages why the purchase order cannot be canceled.

4. Select the requisition re-sourcing option and click the **Continue** button on the Maintain Purchase Order - Cancel Purchase Order page.

If the system was able to cancel the purchase order you'll receive a message stating that the purchase order was successfully canceled on the Maintain Purchase Order - Cancel Purchase Order page.

If the system was not able to cancel the purchase order you'll receive a message stating that the cancellation was unsuccessful on the Maintain Purchase Order - Cancel Purchase Order page. An unsuccessful cancellation is mostly likely due to a system failure.

If you are canceling a dispatched purchase order, you'll receive a message stating that the purchase order has a pending cancel status and that you must dispatch the purchase order again to change the purchase order status to canceled.

5. Click the **OK** button on the Maintain Purchase Order - Cancel Purchase Order page.

The system cancels the purchase order, changes the status on the purchase order to *Canceled*, and takes you back to the Add/Update POs component - Search page. Related quantities and amounts are adjusted on the manufacturer/distributor contract, and the released amounts are also changed.

When canceling dispatched purchase orders, the system changes the purchase order status to *Pending Cancel* and takes you back to the Add/Update POs component - Search page. To change the purchase order status to *Canceled* you must dispatch the purchase order again.

To cancel a purchase order sourced from a requisition that does require budget checking:

1. Display the purchase order on the Maintain Purchase Order - Purchase Order page.

The purchase order may be in a status of *Open*, *Pending Approved*, or *Approved*.

2. Click the **Cancel PO** button on the Maintain Purchase Order - Purchase Order page.

The system displays a message asking you to confirm the cancellation.

3. Click the **Yes** button to confirm the cancellation of the purchase order.
 - If the purchase order can be canceled the Maintain Purchase Order - Cancel Purchase Order page appears asking if you would like to open the requisition quantities to be sourced again. You have these options:
 - Yes - Re-source all of the requisitions.
 - No - Do not re-source the requisitions.
 - Specify the requisitions that you want to re-source. If you select this option, select the requisitions you want to re-source in the **Requisitions Available for Re-Sourcing** group box.
 - If the purchase order cannot be canceled the Maintain Purchase Order - Cancel Purchase Order page appears displaying the error messages why the purchase order cannot be canceled.

4. Select the requisition re-sourcing option and click the **Continue** button on the Maintain Purchase Order - Cancel Purchase Order page.

If the system was able to cancel the purchase order you'll receive a message stating that the purchase order was successfully canceled and that the purchase order requires budget checking. The system gives you the option to perform the budget checking process at that time on the Maintain Purchase Order - Cancel Purchase Order page.

If the system was not able to cancel the purchase order you'll receive a message stating that the cancellation was unsuccessful on the Maintain Purchase Order - Cancel Purchase Order page. An unsuccessful cancellation is mostly likely due to a system failure.

If you are canceling a dispatched purchase order, you'll receive a message stating that the purchase order has a pending cancel status but requires a budget check and that you must dispatch the purchase order again to change the purchase order status to canceled. The system gives you the option to perform the budget checking process at that time on the Maintain Purchase Order - Cancel Purchase Order page.

5. Complete the cancellation process.
 - Click the **Budget Check** button on the Maintain Purchase Order - Cancel Purchase Order page to perform the budget checking process.
 - The system cancels the purchase order, changes the status on the purchase order to *Canceled*, performs a budget check, and takes you back to the Add/Update POs component - Search page.
 - When canceling dispatched purchase orders, the system changes the purchase order status to *Pending Cancel*, performs a budget check, and takes you back to the Add/Update POs component - Search page. To change the purchase order status to *Canceled* you must dispatch the purchase order again.
 - Click the **OK** button on the Maintain Purchase Order - Cancel Purchase Order page to not perform the budget checking process.

The system cancels the purchase order, changes the status on the purchase order to *Canceled*, and takes you back to the Add/Update POs component - Search page.

When canceling dispatched purchase orders, the system changes the purchase order status to *Pending Cancel* and takes you back to the Add/Update POs component - Search page.

To perform a budget check on this purchase order you will have use the Budget Check Request run control page at a later date.

Related Links

[“User Preferences – Purchase Order User Authorizations Page” \(Application Fundamentals\)](#)

[Canceling a Purchase Order Online](#)

[Understanding the Buyer's Workbench](#)

[Understanding Commitment Control in PeopleSoft Purchasing](#)

[“Understanding the Budget Checking of Source Transactions” \(PeopleSoft Commitment Control\)](#)

Purchase Order Deletion

You can delete a purchase order line, schedule, or distribution by clicking the **Delete Row** button.

You can delete an entire purchase order by clicking the **Purchase Order Delete** button on the Purchase Order header panel. You can delete a purchase order entirely if these conditions exist:

- The purchase order is not on hold.
- The purchase order has never been successfully budget checked.
- The purchase order has never been dispatched.
- Purchase order deletion is allowed within the business unit on the Purchasing Business Unit Options page.
- You are authorized to delete purchase orders on the User Preferences - Procurement: Purchase Order Authorizations page.
- You are authorized to delete purchase orders for the buyer on the User Preferences - Procurement: Purchase Order Authorizations page.
- The purchase order is not a blanket purchase order.
- The purchase order is not a recurring purchase order voucher.
- There are no distribution lines on the purchase order that are sourced from a requisition.

The system deletes records from these tables when you delete a purchase order:

PO_HDR

PO_LINE

PO_LINE_SHIP

PO_LINE_DISTRIB

PO_LINE_DIST_NP
PO_COMMENTS
PO_APPROVAL
PO_VAL_ADJ
PO_DFLT_TBL
PO_ADDR_TBL
PO_LN_SHIP_MTCH
PO_FRT_SET
PO_FRT_CHRG
PO_EST_SHIP
PO_LN_SHIP_SUT
PO_LN_SHIP_SUTD
PO_LN_SHIP_EXS
PO_LN_SHIP_EXSD
PO_LN_DIST_EXS
PO_HDR_EXS

Related Links

[Establishing PeopleSoft Purchasing Business Units](#)

“User Preferences – Purchase Order User Authorizations Page” (Application Fundamentals)

Purchase Order Hold Processing

To place a purchase order on hold from further processing, select the Hold From Further Processing check box on a purchase order using the Maintain Purchase Order - Purchase Order page or the Express Purchase Order - Purchase Order page. After you place a purchase order on hold, PeopleSoft Purchasing prevents you from performing these actions at all levels of the document:

- Approving a purchase order.
- Dispatching a purchase order.
- Canceling a purchase order.
- Closing a purchase order.

You will not be able to delete a purchase order at the header level, but row level deletions are permitted.

In addition, if you have indicated hold from further processing on a purchase order, you will not be able to perform the rollover processes at budget period end for that purchase order.

Note: All buttons on the purchase order become unavailable for input except for the **Budget Check, Finalize Document, Undo Finalize Entire Document, Change Order, and Create Line Change** buttons.

Budget Checking a Purchase Order On Hold

When you perform budget checking for a purchase order, using the actual buttons on the Maintain Purchase Order - Purchase Order page or the Budget Check Request run control page, that process is also affected by the hold from further processing functionality.

Budget checking is now determined by the selection criteria that you define as part of the Source Transaction definition for the Commitment Control Budget Processor process and whether you have selected the Hold From Further Processing check box for the purchase order. You define the Source Transaction definition selection criteria using the Source Transactions - Selection Criteria page.

A purchase order that is on hold will not be budget checked as is currently delivered in the source transaction definition. To configure the system to enable budget checking for on hold purchase orders, you need to delete the HOLD_STATUS = N selection criteria for the source transaction definitions for purchase orders.

<i>Source Transaction</i>	<i>Source Transaction - Selection Criteria</i>	<i>Hold From Further Processing</i>	<i>Budget Checking</i>
PO_POENC (purchase order encumbrance)	HOLD_STATUS = N	Selected	Budget checking will not occur.
PO_POENC	HOLD_STATUS not entered as selection criteria.	Selected	Budget checking will occur.
PO_POENC	HOLD_STATUS = Y	Selected	Budget checking will occur for only those purchase orders on hold.
PO_POENCNP (purchase order (non prorate item) encumbrance)	HOLD_STATUS = N	Selected	Budget checking will not occur.
PO_POENCNP	HOLD_STATUS not entered as selection criteria.	Selected	Budget checking will occur.
PO_POENCNP	HOLD_STATUS = Y	Selected	Budget checking will occur for only those purchase orders on hold.

Processing Not Affected When a Purchase Order is Placed On Hold

If a purchase order has the Hold From Further Processing check box selected, you will still be able to:

- Create header and line changes.
- Run document tolerances.
- Run entry events.
- Finalize the various levels of the document or the entire document and undo finalize the various levels of the document or the entire document for commitment control purposes.

For example, if the purchase order is on hold and the requisition is not, finalizing the requisition is permitted.

- Attach procurement cards to a purchase order on hold and process through to a voucher.
- Create receipts and all other processes downstream from the receipt process such as, return To vendor and receipt accrual.
- Create vouchers and all other processes downstream from the create voucher process such as, budget checking, matching, and posting.

Related Links

[Creating Purchase Order Headers](#)

Creating Purchase Orders Online

Understanding the Purchase Order Business Process

With PeopleSoft Purchasing, you can create a purchase order online, in the background, or from another system that transforms purchase requests into purchase orders.

As purchase orders proceed from entry to dispatch, the system tracks details and collects analysis information to facilitate future purchases. In an integrated system, PeopleSoft Purchasing provides purchase order line information to PeopleSoft Payables for invoice payment.

A purchase order in PeopleSoft Purchasing has a tree structure whose key components are a header, lines, schedules, and distributions. A purchase order is identified by an ID that is unique within a PeopleSoft Purchasing business unit. The system generates a default purchase order ID number, but you can override it.

Warning! If you manually override the system assigned purchase order ID number with a custom purchase order ID, do not enter a custom purchase order ID that includes numbers only. If you need to create a purchase order ID that includes numbers only, use the "Next" feature. If you enter a purchase order ID manually that includes numbers only, the system may retrieve a number that is already used by the batch process, thus causing it to fail.

Term	Definition
Header	Contains information such as the purchase order type, tax exempt status, and supplier and buyer details. Header information pertains to the entire purchase order.
Lines	Contains information such as the item ID, item description, category, and quantity. Schedules and distributions are accessed through the purchase order line.
Schedules	Every purchase order line has one or more due dates and external delivery locations carried on a schedule. Create a schedule for each unique delivery address and due date.
Distributions	Contains information about how the item quantity is to be charged to the organization, as well as internal delivery locations. Distributions also contain interface information for PeopleSoft Inventory, Project Costing, Order Management, and Asset Management. You can have more than one distribution for each schedule.

Here is the basic flow of purchase orders in PeopleSoft Purchasing:

1. (Optional) Reserve a purchase order for future use on the Purchase Order Reservations page.
2. Create the purchase order through one of these methods:

- Directly online.

You can create purchase orders online using the Maintain Purchase Order - Purchase Order page or the Express Purchase Order - Purchase Order page.

- Purchase order sourcing processes.

Using the PO Calculations process (PO_POCALC) and the Create Purchase Order process (PO_POCREATE), purchase orders can be created from multiple sources: through requisition selection, as a contract release, as an RFQ award, or from sources external to PeopleSoft Purchasing, such as from PeopleSoft Supply Planning, PeopleSoft Strategic Sourcing (strategic sourcing event), or PeopleSoft Order Management (sales order).

When you manually create a purchase order, you can set up the system to automatically select the most appropriate contract to which to source the purchase order requisitions. During the process, the system searches for contracts to use on purchase orders, reducing the need for organizations to know the contract at the time of requisitioning. Requesters can ensure that the correct contract is selected and can override the contract.

Also, you can create a contract using a purchase order as the source transaction. This provides you the capability to make a contract available to automatically supply a purchasing requisition and purchase order transaction.

See “Contract Entry - Contract Page” (PeopleSoft Source to Settle Common Information).

See [Purchasing Definition - Business Unit Options Page](#).

3. Approve purchase order amounts and ChartFields on the purchase order approval pages (may be optional depending on the business practices).
4. Dispatch the purchase orders from the Purchase Order Dispatch/Print process (POPO005) or the Buyer's Workbench.
5. (Optional) Create change orders using the Maintain Purchase Order - Purchase Order page or batch change order processes.
6. Receive shipments (optional, except for purchase order lines that are set up to require receiving).
7. Create purchase order vouchers.
8. (Optional) Run the Matching process (AP_MATCH).
9. Reconcile and close the purchase orders using the Close Purchase Orders process (PO_PORECON).

This diagram illustrates the purchase order business process flow:

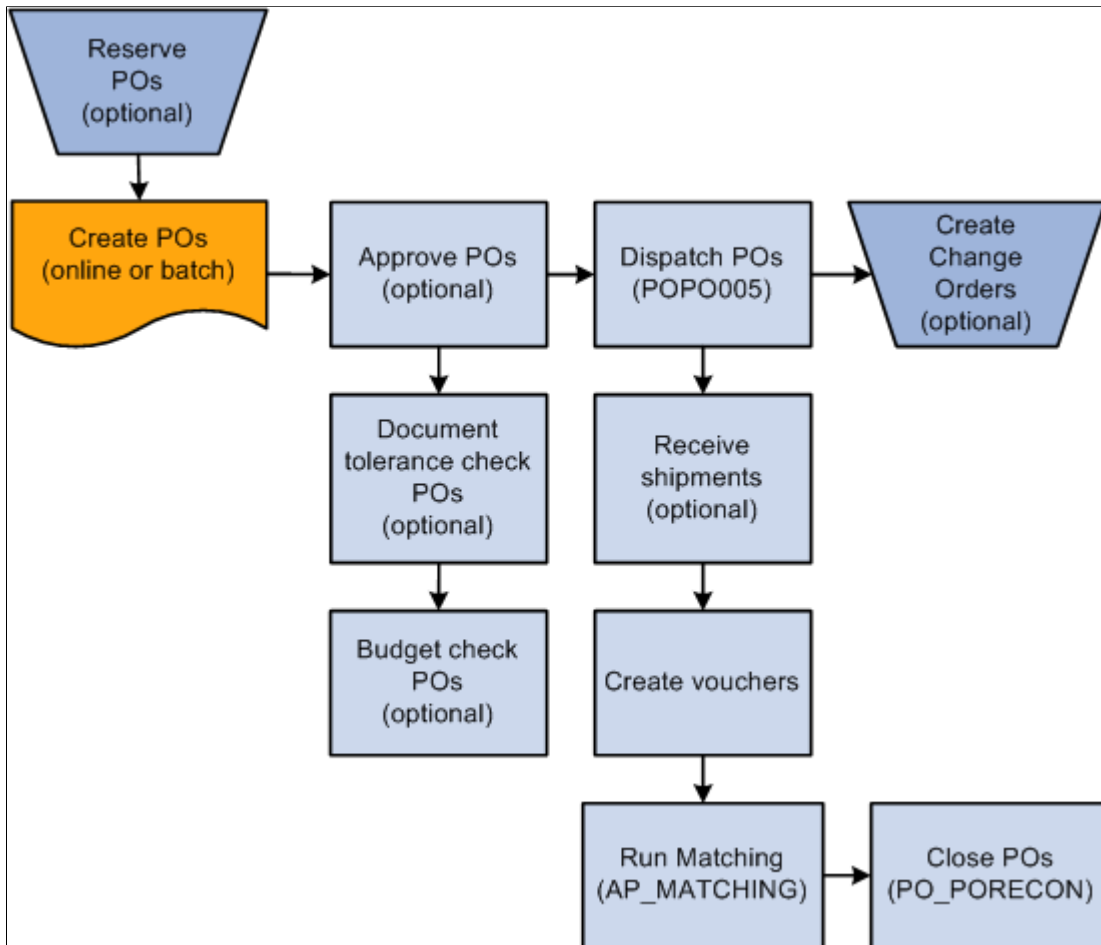

Using Procurement Contracts With Purchase Orders

The PeopleSoft Purchasing application is integrated with procurement contract functionality to streamline the use of contracts with requisitions, purchase orders, and vouchers. Using contract functionality for purchase orders, you can:

- Set up and use procurement contracts by line item, category, or open item reference.
- Specify whether the system automatically supplies a contract on a manual purchase order.
- Control whether the system automatically searches for contracts when sourcing a purchase order.
- Define price adjustments at the header level of the contract that you can apply to purchase orders that use the contract.

Overviews of these functions are provided in the *Creating Requisitions Online* topic and the *PeopleSoft Source to Settle 9.2*.

See “Defining Contract and Vendor Rebate Control Parameters” (PeopleSoft Source to Settle Common Information)

See [Understanding How to Apply Procurement Contract Prices to Transactions](#).

Procurement Contract Validation for Sourcing Purchase Orders

When searching for and validating contracts for purchase order sourcing, the system uses this validation process:

1. Checks to ensure that the **Auto Default** check box is selected on the contract header

The check box must be selected on the contract unless you are manually entering the contract reference

2. Ensures that the contract process option is purchase order, general, or release-to-single PO only.
3. Selects the contract version with the version status of Current and contract status of Approved.

If the two conditions are not met, the system does not use the contract.

4. Ensures that the supplier on the contract matches the transaction supplier and that the transaction date is within the contract begin and expire date.

If this condition is not met, the system:

- Generates a warning for manually entered requisitions.
- Generates an error for manually entered purchase orders.
- Does not select a contract for sourcing if the transaction date is outside of the contract dates.

5. Selects a contract reference type using these criteria:

- If the transaction line has an item ID and category specified, the system first checks for line-item type contracts.

If it does not find a matching contract, the system checks next for category contracts, and if it does not find one, checks for open item contracts for the selected supplier.

- If the transaction line has a category specified and not an item ID, the system first checks for category type contracts.

If the system does not find a category contract, it checks open-item contracts for the selected supplier.

6. Determines the use of a line-item contract for sourcing the purchase order.

The system uses this matching criteria:

- The contract item ID must match the transaction line's item ID.
- The contract line item amount (after adjustments) and quantity minimums and maximums must not exceed the contract limits.

This is an iterative process because you cannot check minimum and maximum until you've calculated a price. So, if multiple applicable contracts exist and the selected contract exceeds the minimum or maximum, then you need to try the next contract.

- The contract must not be for the amount only unless it is manually referenced on the transaction (PO only).

In this case, the item information (description, category) copies onto the purchase order from the contract, ensuring that the item on the contract is the same as the transaction.

7. Determines the use of a category contract for sourcing the purchase order.

The system uses this matching criteria:

- The category specified on the contract must match the transaction line's category.
- The item on the transaction must not be listed as a category item exclusion on the contract.
- The contract category maximum amount must not be exceeded.

8. Determines the use of an open-line contract for sourcing the purchase order.

The system does not allow the contract open-item maximum amount to exceed the contract's limit.

9. Determines requisition sourcing requirements for contracts.

If the transaction is order-by-description or is for amount only, the system does not reference the contract line items and only open-item and category contracts are valid.

10. Determines purchase-order sourcing requirements for contracts.

If the transaction is order-by-description, then the system can use open-item and category contract references. You can manually reference contract order-by-description line items on the purchase order, but the system copies the purchase order from the contract line item information (item description, category, and price) to ensure that the item on the contract is the same as on the purchase order.

11. If multiple contracts exist, then choose the one with the most recent (but not future) contract begin date.

12. After the system validates the contract reference and uses it on the transaction, it:

- a. Updates the released amounts and quantities.
- b. Creates a contract event.
- c. Updates the transaction with the contract information.

Related Links

[Maintain Purchase Order - Purchase Order Page](#)

[Express Purchase Order - Purchase Order Page](#)

[Understanding Purchase Order Approvals](#)

[Dispatch POs Page](#)

[Close Purchase Orders Page](#)

[Understanding the Buyer's Workbench](#)

[Manually Selecting Requisitions for Sourcing](#)

[PO Stage Load Page](#)

[Understanding How to Apply Procurement Contract Prices to Transactions](#)

Understanding Global Location Numbers and Global Trading Item Numbers

Global Location Numbers (GLNs) and Global Trading Item Numbers (GTINs) are two sets of industry-wide unique identification numbers for business locations and items respectively. Introduced in the healthcare world as voluntary industry initiatives, the idea of using GLNs and GTINs is to eliminate errors in conducting business due to duplicate or sometimes confusing use of codes to refer to locations and goods in different systems amongst trading partners. The use of GLNs and GTINs in purchasing transactions makes sure that the right goods are requested and delivered to the right locations.

Global Location Numbers (GLN)

A GLN is a 13-digit number that uniquely identifies a physical location or legal entity across the globe. GS1 maintains a central registry of locations and their associated GLNs, which are provided by and accessible to participants. In PeopleSoft Financials and Supply Chain Management, you can specify GLNs for business locations of purchasing organizations and their suppliers using the Location (LOCATION_TBL) component and the Supplier Information (VNDR_ID) component respectively.

GLNs are entered manually in the system as a one-time setup (no load utility to populate values automatically). Each location can only be assigned one GLN but the same GLN can be associated with multiple locations if you prefer. The reason for this flexibility is that, depends on how the locations are set up initially, you may have defined locations at a level that is lower than you want to assign GLNs. For example, you want to assign GLNs to locations at the city level but you have locations defined at the building level, one level below city. In this scenario, you enter the same GLN for all the building locations that are in the same city.

At runtime, GLNs are displayed on purchase orders and express purchase orders for the ship-to, bill-to and supplier locations that have GLNs assigned to them. Similarly, when you select to copy a purchase order from a contract, requisition or another purchase order using the Copy From field, GLNs (if available) for the bill-to and ship-to locations are displayed accordingly.

Due to the voluntary nature of the GLN initiative, companies and their suppliers should be in agreement with the use of GLNs on their EDI transactions. The PeopleSoft system provides needed fields in source tables to support EDI mapping, whereas the actual mapping needs to be done by the User Company or by their VAN (value added network) partner.

Note: The Purchase Order Dispatch and Purchase Order Acknowledgement messages and file layouts have been updated to support GLNs for bill-to, supplier and ship-to locations.

GLN values are not maintained on transactions; rather, they are maintained in the Supplier Master or Location table. When the system receives Purchase Order Acknowledgement messages, GLN values are archived in history tables.

Supplier GLN Defaulting

You can specify GLNs at the supplier and supplier location levels. At runtime, the system populates supplier GLNs on purchase orders and EDI transactions in this defaulting hierarchy:

- supplier location

- supplier

If a purchase order references a supplier that has GLNs specified at both levels, the system displays the supplier location GLN on the purchase order.

Supplier GLNs are not effective-dated.

Related Links

“Location - Detail Page” (Application Fundamentals)

“Entering Supplier Identifying Information” (PeopleSoft Source to Settle Common Information)

Global Trading Item Numbers (GTIN)

A GTIN is a 14-digit number that uniquely identifies a trade item, which is a product or service that is sold, delivered, and invoiced at any point in the supply chain. In PeopleSoft Financials and Supply Chain Management, you can specify GTINs for items using the Universal Item Identifier (ITM_MFG_UPN) component.

Refer to the *Using Universal Item Identifiers* section for steps on setting up the system to use GTINs and assigning GTINs to items. At runtime, GTINs are displayed (in the GTIN field on the Item Information Tab) on purchase orders and express purchase orders for items that have GTINs assigned to them.

Note: UPN details for the purchase order is taken from the matching contract. In the absence of a matching contract, UPN values from the requisition will be defaulted to the PO. If UPN details is not available for the requisition, then it will be taken from the UPN defaulting hierarchy.

GTIN Defaulting

When an item is added to a purchase order, the system populates the manufacturer ID to the purchase order line. The manufacturer ID either comes from the default value that is set on the supplier's Manufacturer Info page for the selected item and supplier, or, if the former value is blank, from the item's preferred manufacturer that is set on Manufacturer's Item page at the item master level. Then, it looks for a GTIN match for the item based on the item ID, UOM, manufacturer ID, and manufacturer's item ID that are available on the purchase order line, and displays it in the GTIN field.

Note: In order for GTIN defaulting to occur, the supplier that is selected on the purchase order must be UPN ready.

Here is how GTINs gets defaulted on purchase orders (assuming that item ID and UOM are specified):

1. If manufacturer ID and manufacturer item ID are present:
 - a. The system populates the GTIN that is assigned to this item ID-UOM-manufacturer ID-manufacturer item ID combination on the purchase order line.
 - b. If no matching is found, the system populates the GTIN that is assigned to the item ID-UOM-manufacturer ID combination (excluding manufacturer item ID) on the purchase order line.
 - c. If no matching is found, the GTIN value becomes blank.
2. If manufacturer ID is not present, the GTIN value is not populated on the purchase order line.

This defaulting mechanism applies to online and express purchase orders.

Related Links

“Using Universal Item Identifiers” (PeopleSoft Managing Items)

Common Elements Used in Global Location Numbers and Global Trading Item Numbers

<i>Field or Control</i>	<i>Description</i>
Alloc Method/Allocation Method	<p>Miscellaneous charge allocation method. If a value is not selected, charges are allocated based on the setting for each charge on the Header - Miscellaneous Charges page. Values are:</p> <p><i>Matl Value</i> (material value): Allocates charges based on the value of the items on the line.</p> <p><i>Quantity</i>: Allocates charges based on the quantity of items on the line.</p> <p><i>Volume</i>: Allocates charges based on the volume of the items on the line.</p> <p><i>Weight</i>: Allocates charges based on the weight of the items on the line.</p>
Amt/Amount	Total amount of the charge. You can override the default amount.
Budget Status	<p>Appears only if budget checking is enabled.</p> <p><i>Valid</i>: The purchase order has been successfully budget checked.</p> <p><i>Error</i>: The purchase order has failed budget checking.</p> <p><i>Not Checked</i>: The purchase order has not been budget checked.</p>
Cancel Distribution	Click this button to cancel the distribution. If the distribution that you cancel is sourced from a requisition, the system prompts you to see whether you want to increase the open requisition quantity and allow the requisition quantity to be re-selected. To cancel a distribution, you must have the proper authorization defined on the User Preferences - Procurement: Purchase Order Authorizations page.
Currency	Currency of the charge amount appears by default from the supplier location default currency when the supplier location is specified.

Field or Control	Description
Freight Charge Method	<p>Method by which freight is charged for the purchase order. This value can be overridden for the schedule on the Details for Schedule page. Values are:</p> <p><i>Volume:</i> Freight is charged by the volume of the shipped item.</p> <p><i>Quantity:</i> Freight is charged by the number of packages.</p> <p><i>Value:</i> Freight is charged by the value of the order.</p> <p><i>Weight:</i> Freight is charged by the weight of the items.</p>
Freight Trm/Freight Terms Code	Freight terms code that applies to the schedules for this purchase order.
Geocode	Nine-digit code used to identify the state, county, and city as a specific jurisdiction. Used for tax calculation by integrated third-party applications.
IN Unit (inventory unit)	<p>Inventory business unit for the item. At the distribution level, if the purchase order line is for an inventory item, this field appears by default from the ship to location on the Maintain Purchase Orders - Schedule page.</p> <p>If the item is an inventory item and an inventory business unit is entered on the first distribution line of the schedule, the due date on the Maintain Purchase Orders - Schedule page is validated against the inventory business unit calendar. This ensures that the inventory business unit is open to receive merchandise on that day.</p>
Location	Third-party supplier location.
Merch supplier (merchandise supplier)	<p>If selected, the charges are paid to the purchase order supplier and the Third-Party supplier link becomes unavailable.</p> <p>If you clear the check box, this indicates that the charges are from a third-party and will be paid on a separate voucher. For example, you would clear the check box for freight charges if the freight is billed separately by the carrier.</p>
Miscellaneous Charge/Charge Type	Miscellaneous charges are set up on the Misc Charge/Landed Cost Defn page (miscellaneous charge/landed cost definition page).
Origin	Origin for the purchase order. Origin codes are established on the Origin Codes page and help identify the origins of transactions.
PO Ref	Enter any reference information. The information that you enter here appears on the purchase order approval pages.

Field or Control	Description
Rate Date	Date of the rate used in the currency calculation.
Rate Type	Indicates the exchange rate type that the system uses to convert between the purchase order transaction currency and the purchase order business unit base currency.
Request BU (requesting business unit)	Business unit from which the purchase order requisition originated.
RTV Credit (return-to-vendor credit)	Select to credit this charge if a return is made to the supplier. This is available for merchandise-supplier charges only.
Sales/Use Tax Applicability	<p>Choose the correct sales and use tax applicability rules from these values:</p> <p><i>Item is Exempt:</i> Select if the item is exempt from sales and use tax.</p> <p><i>Purchaser Is Exonerated:</i> Select if you, as the purchaser, do not have to pay sales or use tax. Tax is not calculated on the purchase order and accounts payable does not pay taxes.</p> <p><i>Sales Tax Appl</i> (sales tax applicability): Select to calculate and apply sales tax on the purchase order.</p> <p><i>Direct Pay</i> (use tax applicability direct pay): Select if you do not want use tax calculated on the purchase order. The invoice is not created with use tax, but a line is written to the general ledger for the amount that you must pay the state directly.</p> <p>The use tax amount is calculated and displays on the Sales/Use Tax Information For Schedule page and the Sales/Use Tax Details For Distribution page. The use tax amount will not display on the Maintain Purchase Order - Purchase Order page or the PO Total Amount Details page.</p> <p><i>Use Tax Appl</i> (use tax applicability): Select to calculate and apply use tax on the purchase order.</p>
Ship From Country	Ship from country for the transaction.
Ship From State	Ship from state for the transaction.
Ship To Country	Country associated with the ship to location for the transaction.
Ship To State	State associated with the ship to location for the transaction.
Ship Via	Carrier or method of shipment.

Field or Control	Description
Tax Code SUT (tax code sales use tax)	Tax code for the schedule. A tax code consists of a group of tax authorities. For example, if a certain locality has a city tax, trade use tax, county tax, and state tax, you can create four tax authorities and group them into a single tax code. This is used when the PeopleSoft tax tables are used to calculate sales and use tax.
Third Party supplier	Third-party supplier billing the miscellaneous charge.
TRFT Rule (transport and freight rule)	Set the transport and freight rule code for the transaction. Can be overridden for the schedule on the Details for Schedule page.
VAT Applicability/ Applicability (value-added tax applicability/applicability)	<p>Select whether VAT should be calculated for this schedule. While most purchases may be subject to VAT for any of the VAT countries, there may be some items or item categories that are exempt or outside of scope for VAT. VAT Applicability is determined by an algorithm, but you can override the default value here. Values include <i>Exempt</i>, <i>N/A</i>, <i>Outside</i>, <i>Suspended</i>, <i>Exonerated</i> and <i>Taxable</i>.</p> <p>The VAT applicability is set on the Schedule VAT Information page.</p>
VAT Code	The VAT code is used to specify the tax rate associated with the transaction schedule line. The VAT code appears by default from the VAT defaults table, using the Purchasing VAT defaulting hierarchy.
VAT Transaction Type	<p>The VAT transaction type provides a way of categorizing the VAT transactions for reporting purposes.</p> <p>The VAT transaction type appears by default from the VAT defaults table, based on the Purchasing VAT defaulting hierarchy.</p>
VAT Reporting Entity	This is the level in the organization at which VAT returns are filed. Purchasing business units are VAT-enabled through their relationship with the General Ledger business unit. On a purchase order, this is the entity that reports the VAT for this transaction.

Field or Control	Description
VAT Treatment	<p>VAT treatment for the VAT calculation. VAT treatment is determined by a complex set of algorithms. Values include:</p> <p><i>Domestic Goods Purchase:</i> If the ship from and ship to countries are the same, and the supplier is registered for VAT, the transaction is treated as domestic.</p> <p><i>Domestic Services Purchase:</i> If the buyer and seller are both located in the country where the VAT is liable, the transaction is treated as domestic</p> <p><i>EU Goods Purchase:</i> If the ship from and ship to countries are different, the system determines whether both countries are located within the European Union. If so, the system looks at the VAT registration for each trading partner to determine whether the transaction should be treated as an intra-EU purchase, domestic, or outside the scope of VAT.</p> <p><i>EU Services Purchase:</i> If each trading partner is located and registered in different EU countries, and the VAT on a service is liable in the buyer's country, the transaction is treated as a self-assessed EU services purchase.</p> <p><i>Self-Assess Goods Import:</i> If the ship from country is different from the ship to country and either or both of the countries are located outside of the European Union, and the supplier is not registered in the ship to country, the transaction would be treated as an import. If the flag on the entry in the VAT Country table for the VAT reporting country indicates that VAT on imports should be self-assessed, the transaction will be treated as a self-assess goods import, and both input and output VAT will be recorded.</p> <p><i>Self-Assess Services Import:</i> If each trading partner is located and registered in different countries, and the VAT on a service is liable in the buyer's country, the transaction is treated as a self-assessed services import.</p> <p><i>Zero-rated Goods Import:</i> If the ship from country is different from the ship to country and either or both of the countries are located outside of the European Union, and the supplier is not registered in the ship to country, the transaction would be treated as an import. If the flag on the entry in the VAT Country table for the VAT reporting country indicates that only input VAT should be recorded on imports, the transaction will be treated as a zero-rated goods import.</p> <p><i>Outside of Scope:</i> If the supplier is not registered for VAT, or if the VAT is liable in a country other than the VAT reporting country, the transaction is treated as outside the scope of VAT.</p> <p><i>No VAT Processing:</i> For transactions where the physical nature is goods, if the ship to country has not been defined as a VAT country and the VAT reporting country on the transaction is blank, no VAT information will be recorded.</p>

<i>Field or Control</i>	<i>Description</i>
VAT Use Type/Use Type	Defines the percentages by which the usage of goods and services are taxable and exempt from VAT. This is used in the calculation of recoverable and rebate VAT.

Related Links

[Maintain Purchase Order - Schedules Page](#)

[Header - Miscellaneous Charges Page](#)

[VAT Information for a Schedule Page](#)

[Purchasing Options Page](#)

[Preparing PeopleSoft Purchasing VAT Environments](#)

“Setting Up Application-Specific Installation Options” (Application Fundamentals)

“PeopleSoft Global Options and Reports Overview” (PeopleSoft Global Options and Reports)

Using Purchase Order Reservations

This section provides an overview of how the system assigns purchase order IDs when reserving purchase orders and discusses how to reserve purchase orders.

Page Used to Reserve Purchase Orders

<i>Page Name</i>	<i>Definition Name</i>	<i>Usage</i>
Purchase Order Reservations Page	PO_RESERVE	Reserve a purchase order number or a sequence of purchase order numbers without having to enter the details of the purchase order. This enables you to enter and process the purchase order later while securing a purchase order number now. This functionality can be useful when you must give a purchase order number to a supplier over the phone, but you don't have time to enter a complete purchase order at that time.

Understanding How the System Assigns Purchase Order IDs When Reserving Purchase Orders

Using the Purchase Order Reservations page you can reserve a block of purchase order IDs. The system uses the purchase order ID that you enter and assigns different numbers depending on whether the initial purchase order ID entered is all numeric digits or if it contains alpha characters. If the PO ID is left at "NEXT" or if Standard Auto Numbering is in effect and a valid 3 character field is entered, the system will utilize auto-numbering to calculate the PO ID's This table illustrates the purchase order ID assignments that the system will create:

Initial Purchase Order ID Entered	Number of Purchase Orders to Create	Purchase Order IDs Created
1234	10	<ul style="list-style-type: none"> • 1234 • 1235 • 1236 • 1237 • 1238 • 1239 • 1240 • 1241 • 1242 • 1243
NEXT	3	<p>If a Beginning Sequence is not defined on the PO Business Unit for Purchase Orders, then Standard Auto Numbering is not in effect, so the system will start with the next available number. For example, if the Last Number Issued on the PO Business Unit was 0000000265, then these are the PO's generated:</p> <ul style="list-style-type: none"> • 0000000266 • 0000000267 • 0000000268 <p>If a Beginning Sequence has been defined on the PO Business Unit for Purchase orders, then Standard Auto Numbering is in effect and the system will start with the next available number from the Auto Numbering Table entry corresponding to the Beginning Sequence value. For example, if the Beginning Sequence has been defined as "ABC" and the Last Number Issued for "ABC" was ABC0000002, then these are the PO's generated:</p> <ul style="list-style-type: none"> • ABC0000003 • ABC0000004 • ABC0000005

Initial Purchase Order ID Entered	Number of Purchase Orders to Create	Purchase Order IDs Created
ABC_DIV	10	<ul style="list-style-type: none"> • ABC_DIV • ABC_DIV01 • ABC_DIV02 • ABC_DIV03 • ABC_DIV04 • ABC_DIV05 • ABC_DIV06 • ABC_DIV07 • ABC_DIV08 • ABC_DIV09
DEF	3	<p>If a Beginning Sequence has been defined on the PO Business Unit for Purchase orders, then Standard Auto Numbering is in effect and the system will start with the next available number from the Auto Numbering Table entry corresponding to the initial 3 character PO ID entered (regardless of whether this matches the Beginning Sequence entered on the PO Business Unit). For example, if the Beginning Sequence has been defined as "ABC" and a value of "DEF" has been entered as the PO ID initial value and an Auto Numbering Table entry exists for "DEF" and the Last Number Issued for "DEF" was DEF0000011, then these are the PO's generated:</p> <ul style="list-style-type: none"> • DEF0000012 • DEF0000013 • DEF0000014

The maximum number of purchase orders that can be reserved at one time is 99. If you enter nine or ten characters or digits for the first purchase order ID you will receive a warning message stating that you should enter a purchase order ID that is eight or less digits and explains the consequences if you continue. If you override the warning message, the system may have to truncate the last one or two characters or digits of the purchase order IDs if you request a range. If truncation is required, the system will use the truncated value as the first purchase order ID created. The system will create the subsequent purchase order IDs by appending a numeric value to the end of the truncated value.

Purchase Order Reservations Page

Use the Purchase Order Reservations page (PO_RESERVE) to reserve a purchase order number or a sequence of purchase order numbers without having to enter the details of the purchase order.

This enables you to enter and process the purchase order later while securing a purchase order number now. This functionality can be useful when you must give a purchase order number to a supplier over the phone, but you don't have time to enter a complete purchase order at that time.

Navigation:

Purchasing > Purchase Orders > Reserve PO IDs > Purchase Order Reservations

When accessing the page, you can enter a custom purchase order ID in the **PO ID** field on the Purchase Order Reservation prompt page. If you attempt to reserve a purchase order ID that is already in use, you receive an error.

<i>Field or Control</i>	<i>Description</i>
PO ID	<p>When you save this page and are not reserving a block of purchase orders, the single purchase order ID appears and is assigned to a purchase order containing default information based on the user ID and the information that you entered here.</p> <p>If you are reserving a block of purchase orders, the ID of the first purchase order in the sequence appears.</p> <p>New purchase orders are created with a status of <i>Initial</i> and are immediately available for modification.</p>
Number of PO's	<p>Enter the number of purchase order IDs that you want to reserve. The purchase order IDs that were created appear in the PO Range field.</p> <p>When Auto Numbering is not utilized, the PO ID that the user enters is the first PO ID reserved. The additional PO IDs generated will have a number appended to the first ID, starting either with 1 if the number of POs is 9 or less, or 01 if the number of POs is 10 - 99.</p>
PO Range	<p>This field appears if you are reserving more than one purchase order and displays the purchase order IDs generated.</p>
PO Date (purchase order date)	<p>Displays the current system date. You can select another date. The system uses this date for price calculation when the price date is defined as the purchase order date.</p>
Supplier	<p>Select the supplier for which you want to reserve a block of purchase order IDs. This field appears if you are reserving more than one purchase order and displays the purchase order IDs generated.</p>

Field or Control	Description
Supplier ID	Select a supplier to use with this reserved purchase order ID or group of IDs.
Supplier Loc (supplier location)	Select a specific supplier location for which to reserve purchase order IDs. When you enter the supplier ID, the default supplier location is populated automatically; however, you can override the value. When you create this purchase order, the system uses the supplier location that you specify in this field.
Buyer	Select the buyer who is responsible for the reserved purchase order IDs.
PO Reference (purchase order reference)	Enter the text that you want to appear as a default value on the Maintain Purchase Order - Purchase Order page and purchase order approval pages.
Origin	Select an origin for the purchase order. Origin codes are established on the Origin Codes page and help identify the origins of transactions.

Setting Up Procurement Groups for Asset Consolidation

To help identify procurement items belonging to an asset in accordance with the Governmental Accounting Standards Board (GASB), PeopleSoft provides functionality for grouping procurement transactions for asset consolidation. Asset-related procurement group fields are included in the Requisition, Purchase Order, and Receipt to identify which items are grouped for an asset. The asset-related procurement group information that is captured on the Requisition, flows through Purchase Order, Receipt, Payables, and then is loaded into Asset Management.

PeopleSoft Purchasing provides a setup page to establish Procurement Group IDs, which are used to associate multiple asset-related items that are purchased. The Procurement Group ID can be assigned to a group of procurement transaction lines on a single purchase order or across multiple purchase orders.

In addition, PeopleSoft provides a Procurement Group Inquiry page that is used for reviewing the various procurement document lines (Purchase Order, Requisition, Receipt, or Voucher) associated with a Procurement Group. Procurement Group IDs and their supporting details, such as Primary Unit and Unit Allocation Quantity or Unit Allocation Amount, can be added to asset applicable requisition and purchase order lines and then used to identify and group those documents and lines.

As items are received, the Receipt lines display the Procurement Group details associated with the corresponding purchase order line. The receiving process then allocates the received goods and services by asset for integration with Asset Management, properly capturing total asset cost of all related items that are grouped by Procurement Group ID with little or no manual intervention necessary.

Pages Used to Set Up Procurement Groups

<i>Page Name</i>	<i>Definition Name</i>	<i>Usage</i>
<u>Procurement Groups Page</u>	PO_GROUP_TBL	Establish Procurement Group IDs to be used in associating multiple asset-related items that are purchased so as to group related transactions throughout the procurement process for proper asset consolidation and valuation.
<u>Purchasing Options Page</u>	BUS_UNIT_OPT_PM	Define purchasing options, enable purchasing group options for transactions, and establish transaction processing criteria for each PeopleSoft Purchasing business unit. You can override some of these options during transaction processing.
<u>Procurement Group Inquiry Page</u>	PO_GRP_DOC_INQ	Review all related procurement documents (Requisitions, Purchase Orders, Receipts, and Vouchers) that are associated with a Procurement Group.

Procurement Groups Page

Use the Procurement Groups page (PO_GROUP_TBL) to establish Procurement Group IDs to be used in associating multiple asset-related items that are purchased so as to group related transactions throughout the procurement process for proper asset consolidation and valuation.

Navigation:

Purchasing > Purchase Orders > Procurement Groups > Procurement Groups

This example illustrates the fields and controls on the Procurement Groups page. You can find definitions for the fields and controls later on this page.

The screenshot shows the 'Procurement Groups' page with the following details:

- SetID: SHARE
- Procurement Group ID: PGRP1
- Procurement Group Detail: Find | View All | First 1 of 1 Last
- *Effective Date: 01/01/2012
- *Status: Active
- *Description: Procurement Group 1
- *Short Description: PGRP1
- Primary Unit Item ID: AM1000
- Description Only Item

Add Procurement Group IDs by SetID to be used for asset-applicable items throughout the procurement process. Supply an effective date and assign a status of Active or Inactive.

<i>Field or Control</i>	<i>Description</i>
Primary Unit Item ID	Select the item ID to represent the primary unit for a given consolidated asset within the procurement group.
Description Only Item	Select to indicate that a description-only item (item that is not in the Item Master) is to be the primary item for the procurement group (as opposed to a primary unit item ID).

See Also [Purchase Order Consolidation](#)

Purchasing Options Page

Use the Purchasing Options page (BUS_UNIT_OPT_PM) to define purchasing options, enable purchasing group options for transactions, and establish transaction processing criteria for each PeopleSoft Purchasing business unit. You can override these options during transaction processing.

Navigation:

Set Up Financials/Supply Chain > Business Unit Related > Purchasing > Purchasing Options

This example illustrates the fields and controls on the Purchasing Options (Page 1 of 2). You can find definitions for the fields and controls later on this page.

This example illustrates the fields and controls on the Purchasing Options (Page 2 of 2). You can find definitions for the fields and controls later on this page.

Field or Control	Description
Purchasing Group Option	Select this option to enable the Purchasing Group fields for transaction pages (Procurement Group link, Procurement Group ID, Primary Unit, Unit Allocation Quantity, and Unit Allocation Amount fields appear on the Requisition, Purchasing ,Receipt and Voucher transaction pages).
Allocate Purchasing Group	This option is only available for selection when the <i>Purchasing Group Option</i> is selected. Select this option to enable Online Receipts and the Receipt Push process to write Procurement Group asset data to the RECV_LN_ASSET and the INTFC_PRE_AM records for Asset Management. See “Consolidating Requisition and Purchase Order Lines for Asset Components” (Asset Lifecycle Management Fundamentals)“Consolidating Group Member Assets” (PeopleSoft Asset Management).

Note: Purchasing Group and Procurement Group are used interchangeably. They are synonymous.

Understanding Business Units in PeopleSoft Purchasing

Procurement Group Inquiry Page

The Procurement Group Inquiry page (PO_GRP_DOC_INQ) Review all related procurement documents (Requisitions, Purchase Orders, Receipts, and Vouchers) that are associated with a Procurement Group.

Navigation:

Purchasing > Purchase Orders > Review PO Information > Procurement Group Inquiry > Procurement Group Inquiry

This example illustrates the fields and controls on the Procurement Group Inquiry page. You can find definitions for the fields and controls later on this page.

The screenshot shows the 'Procurement Group Inquiry' page. At the top, it displays metadata: SetID: SHARE, Description: Procurement Group 1, Procurement Group ID: GRP1, Short Description: GRP1, and Primary Unit Item ID: AM1000. There is a checkbox for 'Description Only Items'. Below this is a 'Transactions' section with a table. The table has columns: Business Unit, Document Type, Document ID, Line, Sched, Item, Description, Qty UOM, Allocation Qty, Open Qty, and Primary Unit. Two rows are visible: 1 US001 (Purchase Order, ACCESSORY, Line 1, Sched 1, Item DSS_MOUSE, Description Wireless Optical Notebook Mouse, 3 button, Qty 1.0000 EA, Allocation 1.0000, Open 1.0000 N) and 2 US001 (Purchase Order, LAPTOP1, Line 1, Sched 1, Item AM1000, Description Laptop Computer, Qty 1.0000 EA, Allocation 1.0000, Open 1.0000 Y).

Transactions display in the following sort order: Business Unit, Document Type, Document ID, Line, and Schedule.

Line Details

Field or Control	Description
Document Type	Displays the type of transaction: Requisition, Purchase Order, Receipt, or Voucher.
Document ID	Displays the Requisition, Purchase Order, Receipt ID, or Voucher link. Click the link to access the corresponding source document.
Line	Displays the line number from the source document
Sched (schedule)	Displays the schedule number from the source document
Unit Allocation Qty (quantity)	Identifies the quantity of the item to allocate per asset for the Procurement Group. This quantity is available for non-amount only transactions. It is utilized during receiving and asset integration.

Field or Control	Description
Unit Allocation Amt (amount)	Identifies the amount of the item to allocate per asset for the Procurement Group. This amount is available for amount only transactions. It is utilized during receiving and asset integration.
Open Qty (quantity)	<p>If the Document Type is a:</p> <ul style="list-style-type: none"> • Requisition, the open quantity is the quantity not sourced. • Purchase Order, the open quantity is the quantity not received. • Receipt, the open quantity is the quantity not interfaced with Asset Management.
Primary Unit	<p>Identifies whether the listed item is the primary unit (value = Y) within a given procurement group.</p> <p>See procurement Groups Page Using Purchase Order Reservations</p>

More Details

Field or Control	Description
Date	<p>If the Document Type is a :</p> <ul style="list-style-type: none"> • Requisition, the date is the Request Date • Purchase Order, the date is the Due Date • Receipt, the date is the Receipt Date • Voucher, the date is the Voucher Date
Sourced to Inventory	This value is set to Y for Requisition items sourced from Inventory. These items are not included in the Asset Management interface tables from PO Receipts. Only those items with a value of N (not sourced from Inventory) are included in the Asset Management interface tables.

Amounts

Field or Control	Description
Amount Only	Indicates whether or not the transaction line is amount only.
Merchandise Amount	Displays the merchandise amount associated with the transaction line (or schedule).
Currency	The Currency Code displays only when there is a value in the Allocation Amt (amount) field. It is hidden if there is a value in the Allocation Qty (quantity).
Open Amount	For Requisitions, this displays the total distribution open amount that is associated with the schedule for Amount Only lines. For POs, this is the PO Schedule merchandise amount less the merchandise amount that is associated with the Receipt line. For Receipts, this is the Receipt line merchandise amount less the total merchandise amount interfaced to Asset Management.

“Understanding the PeopleSoft Asset Management Lifecycle” (Asset Lifecycle Management Fundamentals)

Creating Purchase Order Headers

This section discusses how to Create Purchase Order Headers.

Pages Used to Create Purchase Order Headers

Page Name	Definition Name	Usage
<u>Maintain Purchase Order - Purchase Order Page</u>	PO_LINE	Enter or change purchase order information.
Copy Purchase Order from Contract Page	PO_COPY_TMPLT	Select this option to access the Copy Purchase Order from Contract page, where you can copy the purchase order from an existing contract. <u>Maintain Purchase Order - Purchase Order Page</u>

Page Name	Definition Name	Usage
Copy Purchase Order from Purchase Order Page	PO_COPY_TMPLT	Select this option to access the Copy Purchase Order from Purchase Order page, where you can copy the purchase order from an existing purchase order. Maintain Purchase Order - Purchase Order Page
Copy Purchase Order From Requisition Page	PO_REQ_SOURCE	Select this option to access the Copy Purchase Order From Requisition page, where you can copy the purchase order from an existing requisition. Maintain Purchase Order - Purchase Order Page
Manage PO Acknowledgements - Acknowledgement Summary Page	PO_SS_POA_SUMMARY	View the status of the acknowledgement and transfer the buyer to the purchase order acknowledgement transaction to review and respond to any changes made by the supplier or to respond on behalf of the supplier if necessary. Maintain Purchase Order - Purchase Order Page
Supplier Search Page	VENDOR_LOOKUP_SEC	Search for suppliers. Maintain Purchase Order - Purchase Order Page
Supplier Details Page	PO_VENDOR	Enter exceptions to the default values for the Supplier such as, Supplier order location, address, contact, and salesperson.
Purchase Order Exceptions Page	KK_XCP_HDR_PO1	View budget check exceptions for purchase orders. Users with appropriate authority can override the budget exceptions on this page.
Purchase Order (NP) Exception Page	KK_XCP_HDR_PO1N	View budget check exceptions for non-prorated purchase orders. Users with appropriate authority can override the budget exceptions on this page.
PO Header Details Page	PO_HDR_DTL	Enter purchase order header details, enter rules for the entire order, and hold the purchase order from further processing.

Page Name	Definition Name	Usage
PO Header Details - Bill To Address Page	PO_ADDRESS	View address details for the location relevant to the page from which this page is accessed.
Exchange Rate Detail Page	EXCH_RT_DTL_INQ	View the rules used to calculate exchange rates for the transaction.
<u>Purchase Order Defaults Page</u>	PO_DEFAULTS	Override the defaults set at the business unit, buyer, or Supplier level and set defaults when none exist.
PO One Time Address Default Page	PO_DFLT_ADDR	Define a one-time ship to address for the selected transaction. The address entered serves as the default one-time address for all new lines and schedules on the transaction document.
<u>Retrofit field changes to all existing PO lines/schedule/distributions Page</u>	PO_DFLT_RETROFIT	Apply default field value changes to existing lines, schedules, and distributions.
<u>PO Header Comments Page</u>	PO_COMMENTS_SEC	Enter comments for a transaction. You can enter a unique comment or select from predefined standard comments.
Standard Comments Page	STD_COMM_SEC	Enter standard comments for the purchase order.
Purchase Order Activities Page	PO_ACTIVITY	Enter and track activities associated with a particular transaction. Keep the activity comments organized by logging the due date and by selecting the Done option. <u>Maintain Purchase Order - Purchase Order Page</u>
Activity Summary Page	ACTIVITY_SUMMARY	View the receiving, invoicing, matching, and returning activities that have been performed on the purchase order to date. <u>Maintain Purchase Order - Purchase Order Page</u>

Page Name	Definition Name	Usage
<u>Document Status Page - Requisitions</u>	PRCR_DOCSTAT_INQ	<p>Access and review information about transactional procurement documents associated with a purchase order.</p> <p>When you are using PeopleSoft Supplier Contract Management, this is not referring to an authored contract document.</p>
Maintain Purchase Order - Requisition Details Page	PO_HDR_REQ	<p>View the requisition details that were used to create the purchase order.</p> <p><u>Maintain Purchase Order - Purchase Order Page</u></p>
PO Ship To Comments Page	PO_COMMENTS_SEC	<p>Maintain ship to comments associated with the purchase order. If you defined ship to comments using the Ship To Locations page, those comments appear by default on this page, if you elected to have them copied to the purchase order.</p> <p><u>Maintain Purchase Order - Purchase Order Page</u></p>
<u>Maintain Purchase Order - Procurement Card Information Page</u>	CC_USE_HDR_DTL	<p>Review the existing procurement card information, add or update the procurement card information, or override the existing procurement card with another one.</p>
<u>PO Header - VAT Information Page</u>	PO_HDR_VAT	<p>View header VAT details.</p>
Create Backorder Page	PO_BACKORDER	<p>Apply backorder status, revised quantities, and delivery due dates to the dispatched purchase order schedule.</p> <p><u>Maintain Purchase Order - Purchase Order Page</u></p>
<u>Dispatch Options Page</u>	DISPATCH_OPTIONS	<p>Enter dispatch options for the purchase order and to dispatch a purchase order to the Supplier.</p>
PO Total Amount Details Page	PO_ADJ_BRKDWN	<p>View price adjustments broken down into individual amounts, such as freight, sales and use tax, miscellaneous charges, and value-added tax.</p> <p><u>Maintain Purchase Order - Purchase Order Page</u></p>

Page Name	Definition Name	Usage
Activity Log Page	PO_MAINT_POP	View basic transaction activity information. Maintain Purchase Order - Purchase Order Page
PO Matching Page	PO_MATCHING	Enter matching information for the purchase order.
PO Dispatched History Page	PO_DISP_DSPLY	View the dispatch history of the purchase order.
RTV Information Page	RTV_LN_DISP_SEC	If there is an existing RTV transaction for this purchase order, you can view the RTV information.
Commitment Control Page	KK_EXCPTN_OVER_SEC	View details about a commitment control transaction, such as the source transaction type and the amount type for the journal. You can also override budget checking for the transaction or run the Budget Processor for the transaction.
Document Tolerance Page	DOC_TOL_RUN_CNTRL	Request that the system check the transaction for document tolerances.
Document Tolerance Exceptions - Doc Tol Exception Page	DOC_TOL_EXCPT	View and update document tolerance exceptions.
Document Tolerance Override - Override Log Page	DOC_TOL_OVR_LOG	View and update document tolerance override history.
Change Reason Page	PO_CHNG_REASON	Assign purchase order change request reasons.

Maintain Purchase Order - Purchase Order Page



Use the Maintain Purchase Order - Purchase Order page (PO_LINE) to enter or change purchase order information.

Navigation:

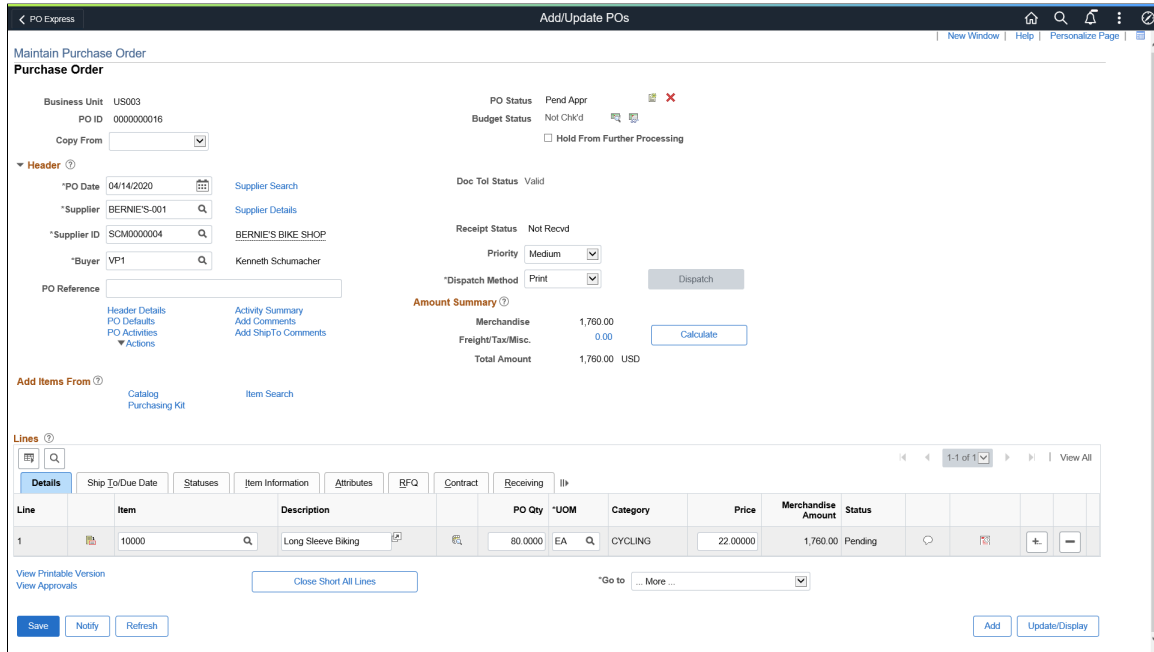

Purchasing > Purchase Orders > Add/Update POs > Maintain Purchase Order - Purchase Order



This example illustrates the fields and controls on the Maintain Purchase Order - Purchase Order page. You can find definitions for the fields and controls later on this page.





Field or Control	Description
<p>PO Status</p>	<p>Status of the entire purchase order. Values include <i>Initial</i>, <i>Open</i>, <i>Pending Approval</i>, <i>Approved</i>, <i>Dispatched</i>, <i>Canceled</i>, and <i>Complete</i>.</p>
	<p>Click the Acknowledge PO button if the buyer wants to acknowledge the POA for the supplier. When you click this button the POA status becomes <i>Acknowledged</i> and history is kept that the buyer accepted the purchase order as is on behalf of the supplier.</p> <hr/> <p>Note: This button only appears for purchase orders requiring acknowledgement and when the POA status is <i>Awaiting POA</i>.</p>
	<p>Click the Approve PO button to change the status of the purchase order to <i>Approved</i>. The purchase order receives an approved or pending approval status based on the purchase order approval rules defined for the PeopleSoft Purchasing business unit. After the status changes to <i>Approved</i> or <i>Pending Approval</i>, this button is no longer available. The Approve PO button is not available if you do not have the authority to approve a purchase order. Set up approval authority on the User Preferences - Procurement: Purchase Order Authorizations page.</p>

Field or Control	Description
	Click the Change Order button to create a change order revision number. When you click this button, fields within the Header group box become available for entry and the system tracks any change order information that you enter. This button is available for purchase orders in dispatched status, and if you specified fields on the PO Chng Ord Template (purchase order change template) page that are header-level changes.

Field or Control	Description
	<p>Click the Create Document button to create an authored document related to the purchase order using the authoring system in PeopleSoft Supplier Contract Management. Contact document authoring is not intended to replace the purchase order dispatch format; however, you can use authoring when you need to author a Microsoft Word contract document that is related specifically to one purchase order.</p> <p>Document authoring is provided for customers who are not using the transactional contract, and therefore need to author a contract document for specific purchase orders instead. The system provides warnings when you attempt to author a contract document that may not be appropriate for a purchase order. For example, if a purchasing transactional contract exists for a purchase order line item, then you should normally create the authored document against the transactional contract and not the purchase order.</p> <p>When you click the Create Document button, you access the Create Document page where you can define document details and author a related contract document. The authored contract document has its own life cycle and statuses independent of the purchase order status itself, including change orders. This enables you to choose to use the authoring system to create a contract document for contract execution and amendments, and depending on your situation, enable you to dispatch the purchase order as necessary for execution purposes.</p> <hr/> <p>Note: PeopleSoft Supplier Contract Management installation options must also be set up to enable purchase orders as source transactions.</p> <hr/> <p>See “Defining User Preferences and Installation Options for Document Approvals” (PeopleSoft Supplier Contract Management).</p> <p>After a document has been created for a purchase order, the Purchase Order page displays the Document Attributes group box and provides a Maintain Document button for updating the authored document.</p> <hr/> <p>Note: If you are making changes to a purchase order that requires document changes as well, such as an amendment, the document may need to be refreshed separately to reflect any changes of mapped purchase order data within the document.</p> <hr/> <p>See “Refreshing and Re-creating Documents” (PeopleSoft Supplier Contract Management).</p> <p>“Creating Contract Documents for Purchase Orders” (PeopleSoft Supplier Contract Management)</p>
	<p>Click the Cancel PO button to cancel the entire purchase order.</p> <p>See Canceling a Purchase Order Online.</p>

Field or Control	Description
Budget Status	<p>Appears only if budget checking is enabled. Values are:</p> <p><i>Not Chk'd</i> (not checked): The purchase order has not been budget checked.</p> <p><i>Valid</i>: The purchase order has been successfully budget checked.</p> <p><i>Error</i>: The purchase order has failed budget checking. The text is enabled as a link, which you can click to access the Purchase Order Exceptions page where you can view budget check exceptions for this purchase order. Users with appropriate authority can override the budget exceptions on the Purchase Order Exceptions page.</p>
	<p>Click the Budget Check button to run budget checking for this purchase order. This button is available if commitment control is enabled for PeopleSoft Purchasing.</p> <p>When you run budget checking, the Comm. Cntrl. Budget Processor (commitment control budget processor) process (FS_BP) runs to check the budget. This process updates the budget header status to either <i>Valid</i> or <i>Error</i>.</p>
	<p>Click the Budget Pre-Check button to perform a pre-budget check against the Budget Journal. The purchase order statuses of <i>Provisionally Valid</i> or <i>Error</i> indicate whether a budget is available. Using the button enables you to validate documents in work in progress mode without affecting budget balances.</p> <p>The button is visible only if the Commitment Control option and Check only Commitment Control option are selected for PeopleSoft Purchasing and the budget header status of the purchase order is Not Checked, Error, or Provisionally Valid. The button is not visible if the budget status is <i>Valid</i>.</p> <p>If you click the button and if the budget pre-check is valid, then the system sets the budget header status for the purchase order to <i>Prov Valid</i>. If the budget pre-check is not valid, then the system sets the budget header status to Error with a link to the Exception page.</p>
	<p>Click the Finalize Document button to finalize all referenced requisitions for the current purchase order. The system checks all line distributions in the purchase order for the associated predecessor requisition distributions.</p> <p>If multiple purchase order distribution lines are associated to the same requisition line distributions, the system only allows one line to be finalized.</p> <p>The system does not display this button if commitment control is not enabled, or if the purchase order is not sourced from a requisition and thus has no predecessor.</p>

Field or Control	Description
	<p>Click the Undo Finalize Entire Document button to reverse finalizing the referenced requisitions for this purchase order.</p> <p>The system does not display this button if commitment control is not enabled, or if the purchase order is not sourced from a requisition and thus has no predecessor.</p> <hr/> <p>Note: If you identify a distribution line as final for less, you must run budget checking afterwards.</p> <hr/>
	<p>Click the Budget Sts NP button to access the Purchase Order (NP) Exceptions page, where you can view budget check exceptions for non-prorated purchase orders. Users with appropriate authority can override the budget exceptions on the Purchase Order (NP) Exceptions page. This button only appears if there are non-prorated purchase orders with a budget status of <i>Error</i>.</p> <p><i>Not Checked:</i> The purchase order has not been budget checked.</p>
<p>Change Order</p>	<p>If applicable, displays the change order batch number for the purchase order.</p>

Field or Control	Description
POA Status	<p>Appears only if POAs are required for the given purchase order. Click the POA Status link to access the Manage PO Acknowledgements - Acknowledgement Summary page. Using this page the buyer can collaborate with the supplier using POAs. Values are:</p> <ul style="list-style-type: none"> • <i>Awaiting PO Dispatch:</i> Purchase order has not been dispatched. The next step in the POA process would be to dispatch the purchase order. • <i>Initial Dispatch Acknowledged:</i> If POAs are not required for change orders, this status will display for all change orders after the first dispatch is acknowledged by the supplier. • <i>Awaiting POA:</i> Purchase order has been dispatched. The buyer is waiting for a POA from the supplier. When this status appears the Acknowledge POA button becomes available. • <i>Responded, Awaits Review:</i> POA has been created by the supplier and is waiting review and approval by the buyer. • <i>Approved, Changes Pending:</i> Buyer approved the POA with the changes suggested by the supplier and the changes are waiting to be processed through the change order load processes. • <i>Acknowledged, with Changes:</i> Change order has been processed with all changes reflected and updated on the purchase order. • <i>Acknowledged:</i> POA has been acknowledged with no changes by the supplier.

Field or Control	Description
<p>Copy From</p>	<p>Select from these values:</p> <ul style="list-style-type: none"> • Contract • Purchase Order • Requisition <hr/> <p>Note: If the source purchase order, requisition, or contract has a mix of Ship To locations but the supplier or business unit settings currently indicate that the purchase order should be restricted to a single Ship To address, then you will not have the option to choose a Ship To location from the source transaction to apply to the entire purchase order. After you select a source transaction to copy, the system presents a new page for selecting a single Ship To location</p> <hr/> <p><i>Contract:</i> Select to access the Copy Purchase Order From Contract page, where you can copy the purchase order from an existing contract. Enter the contract SetID, contract ID, Supplier, Supplier ID, and master contract of the contract that you want to copy. You can copy multiple contracts into an existing purchase order. You have the option of manually entering the order quantity or using the scheduled ship quantity from the contract. Blanket purchase orders are not available for selection. Plus, the system will use the Supplier and location or the buyer from the copied contract to determine the valid procurement card information for the new purchase order.</p> <p><i>Purchase Order:</i> Select to access the Copy Purchase Order From Purchase Order page, where you can copy the purchase order from an existing purchase order. Enter relative information like purchase order ID, Supplier ID, and buyer information from the purchase order that you want to copy. The copy function only enables you to copy from one purchase order. If you attempt to copy more than one purchase order, the most recently copied purchase order overrides the previous purchase order information. Plus, the procurement card information is not copied over to the new purchase order. The system will redetermine the valid procurement card or Supplier card to be used on the new purchase order by looking at the Supplier and location or the buyer.</p> <p>When you copy a purchase order that has procurement group related information defined, the system does not copy these values to the new purchase order. The purchase order will have to be manually linked to the procurement group id.</p> <p>You can copy a canceled purchase order or a purchase order that has canceled lines to a new purchase order. If you copy a canceled purchase order all the lines from the canceled purchase order are copied over to the new purchase order and the status of the lines is made active. If you copy a purchase order that has one or more lines canceled, only the active lines from the existing purchase order are copied to the new purchase order.</p>

Field or Control	Description
	<p>Plus, if you are using the Vendor rebate agreement functionality, when a purchase order is created from another purchase order, the Vendor rebate agreement will be assigned based on the purchase order date of the new purchase order and is not copied from the source purchase order lines.</p> <p>Finally, if you are copying a purchase order that is associated with a PeopleSoft Maintenance Management work order, the work order information will not be copied to the new purchase order.</p> <p>If PeopleSoft Supplier Contract Management is installed, and you are copying a purchase order that has an authored contract document associated with it, the system displays a message when you save the copied purchase order. The message indicates that a document exists on the originating purchase order. You can select to copy the contract document to the new purchase order as an alternative to creating a new document from the beginning. This feature can be useful when you renegotiate a new purchase order with a contract document similar to a prior contract.</p> <hr/> <p>Note: When you copy an authored document, the system starts with the prior document and its content as well as changes from the original document. Then, it refreshes the new document against the copied document to update any references to transactional purchase order information, such as the Supplier and purchase order date, in the copied authored document. When copying a prior document at the start, the system does not start the newest content from the document library.</p> <hr/> <p>When you copy authored documents from a prior document, the baseline of changes for the new document is based on the current state of the document that is being copied. This means that initial document modifications will not be flagged for a copied document.</p> <p>See “Creating Contract Documents for Purchase Orders” (PeopleSoft Supplier Contract Management)</p> <p><i>Requisition:</i> Select this option to access the Copy Purchase Order From Requisition page, where you can copy the purchase order from an existing requisition.</p> <p>When you copy from a requisition, you are sourcing the requisition onto the purchase order. The Copy From field enables you to turn a requisition into a purchase order without going through sourcing. When you copy from a requisition into a purchase order, if the Calculate Price field is Y, then the line will be repriced. If the Calculate Price field is N, then the requisition price is used.</p> <p>If you want to partially source, split source, or consolidate requisitions, use the Requisition Selection component.</p> <p>If a blanket purchase order is specified on the requisition line, it cannot be sourced to the purchase order here.</p>

Field or Control	Description
	<p>Plus, the procurement card information will be copied over to the new purchase order if all the requisitions selected are using the same procurement card information. If the information between the requisitions is not the same, the procurement card will be blank or the buyer's procurement card will become the default value. If a Supplier card currently exists on the purchase order it will not be overridden by the requisitions procurement card information.</p> <p>If you are copying a requisition that is associated with a PeopleSoft Maintenance Management work order, the work order information will be copied to the new purchase order.</p> <p>Special Requisition Types such as Bill Only cannot be consolidated into a single PO. For example, Bill Only or Bill and Replace requisitions cannot be combined into one purchase order, or mixed with standard requisitions. A requisition type becomes a PO type when copied.</p> <p>Finally, if you are copying an amount only requisition, the amount only attribute will be copied to the new purchase order. You can override this field setting if you choose.</p> <hr/> <p>Note: You must enter a Supplier ID before you can copy the purchase order from an existing requisition.</p> <hr/>
Hold From Further Processing	<p>Select this option to temporarily prevent further processing of the purchase order. The purchase order will not be eligible for approval, unapproval, cancelation, closure, or dispatch processing.</p> <p>In addition, budget checking is now determined by the selection criteria that you define as part of the Source Transaction definition for the Commitment Control Budget Processor process and whether you have selected the Hold From Further Processing option for the purchase order.</p> <p>If the HOLD_STATUS = N for the Selection Criteria for the Source Transaction, and the Hold From Further Processing option is selected, and you perform budget checking, no budget checking will occur for the purchase order.</p> <p>If the HOLD_STATUS is not entered as Selection Criteria for the Source Transaction, and the Hold From Further Processing option is selected, and you perform budget checking the budget checking process will execute for the purchase order.</p> <p>If the HOLD_STATUS = Y for the Selection Criteria for the Source Transaction, and the Hold From Further Processing option is selected, and you perform budget checking, the budget checking process will execute but will only process the purchase orders that are marked on hold.</p> <p>See Purchase Order Hold Processing.</p>

Field or Control	Description
Current Change Reason	<p>Click to access the Change Reason page where you can view and maintain the change reason code. This link is available after a purchase order has been dispatched once and a change reason is required on the business unit options, any change to a change tracked field will cause the capture of a change reason.</p> <p>See Procurement Change Reason Codes Page.</p>

Document Attributes

This group box appears when a PeopleSoft Supplier Contract Management authored contract document exists for the purchase order.

Field or Control	Description
Status	Displays the status of the current version of the document.
Version	<p>Displays the current authored document version from PeopleSoft Supplier Contract Management.</p> <hr/> <p>Note: When you update an existing purchase order and the contract version on the purchase order is no longer the current version, you receive a prompt asking if you want to use the new version.</p> <p>If you opt for the new version, the system removes the old released amount from the old version and places the new released amount into the new version. This action could potentially drop an older version below its threshold amount. For batch updates, the system does not change the version.</p> <hr/>
Maintain Document	Click to access the Maintain Document page where you can view or edit the document, maintain document attributes, and send the document through collaboration and approvals. You can also finalize the contract document and create amendments for it.

See “Creating Contract Documents for Purchase Orders” (PeopleSoft Supplier Contract Management).

Header

Field or Control	Description
PO Date	Automatically changes to the current system date. You can override the purchase order date. This appears on the purchase order and is the date used for price calculation if the price date is defined as the purchase order date.
Supplier Search	Click to access the Supplier Search page where you can enter criteria to search for a specific Supplier or a group of suppliers from which you can select a Supplier for the purchase order.
Doc Tol Status (document tolerance status)	<p>If document tolerance checking is enabled, the system displays the document tolerance status. The system runs the Document Tolerance process before budget checking when you click the Budget Check button, or you can run the process separately. Document tolerance checks the change in percentage or a fixed dollar amount between the purchase order and requisition at the ChartField distribution level. Values are:</p> <p><i>V</i> (valid): The purchase order has passed document tolerance checking.</p> <p><i>N</i> (not checked): The purchase order requires document tolerance checking. If any amounts, quantities, or ChartFields are modified after the document tolerance is checked, the system resets the document tolerance status to <i>Not Checked</i>.</p> <p><i>E</i> (error): Exceptions were generated for the purchase order during document tolerance checking. You can override document tolerance exceptions on the Document Tolerance Exception page.</p>
Supplier	A purchase order can have only one Supplier. When you enter a Supplier, the Supplier order location, price location, primary buyer, freight terms, payment terms, Supplier currency, dispatch methods, and VAT option appear by default on the purchase order. You can override the defaults from the supplier on the supplier Details page.
Supplier Details	Click to access the supplier Details page where you can maintain supplier information such as contacts and addresses.

Field or Control	Description
Backorder Status	<p>Displays the backorder status. Values are:</p> <ul style="list-style-type: none"> • <i>None</i>. • <i>Backorder</i>. • <i>BO Recv</i> (backorder received).
Create Backorder	<p>Click to access the Create Backorder page where you can select to backorder the open (non-received) quantity for all or selected purchase order lines.</p> <p>See Creating and Viewing Purchase Order Backorders.</p>
Supplier ID	<p>Displays by default the supplier ID for the supplier that you selected. You can also select the supplier ID, and the system will populate the supplier field.</p>
Receipt Status	<p>Displays the receipt status of the purchase order. Values are:</p> <ul style="list-style-type: none"> • <i>Not Recvd</i> (not received). • <i>Partial</i> (partially received). • <i>Received</i> (fully received).
Buyer	<p>A purchase order can only have one buyer. Buyers available to a user are defined on the User Preferences - Procurement: Purchase Order Authorizations page.</p>
Priority	<p>Select the priority for the purchase order. Values include <i>High</i>, <i>Low</i>, and <i>Medium</i>. The field value is set to <i>Medium</i> by default. This value can be used on the Fluid Approval page to view transactions by priority.</p>
Dispatch Method	<p>Select the method that you want to use to dispatch this purchase order. Dispatch method values include:</p> <p><i>EDX</i>(electronic data delivery)</p> <p><i>EMAIL</i></p> <p><i>FAX</i></p> <p><i>PHONE</i></p> <p><i>PRINT</i></p>

Field or Control	Description
Dispatch	Click to dispatch the purchase order.
PO Reference (purchase order reference)	Enter free-form text that provides additional information for the purchase order.
Header Details	Click to enter purchase order header details, enter rules for the entire order, and hold the purchase order from further processing. See PO Header Details Page .
PO Activities	Click to enter and track activities associated with a particular transaction.
Add Comments	Click to access the PO Header Comments page. See PO Header Comments Page .
PO Defaults	Click to access the Purchase Order Defaults page. See Purchase Order Defaults Page .
Activity Summary	Click to view the receiving, invoicing, matching, and returning activities that have been performed on the purchase order to date. See Viewing Purchase Order Activity Summaries .
Add ShipTo Comments	Maintain ship to comments associated with the purchase order. If you defined ship to comments using the Ship To Locations page, those comments appear by default on this page, if you elected to have them copied to the purchase order.
Procurement Group	This link appears in the header area of the Purchase Order page if you enabled the Purchasing Group Option field on the Purchasing Options Page . Click to access the Procurement Groups page to add or update a procurement group ID. The Procurement Groups page is launched in a new instance of the browser so you can perform the necessary maintenance to the procurement group IDs. When changes are complete, you can close the browser instance and continue with the purchase order transaction. See Procurement Groups Page

Field or Control	Description
Federal Award Data	<p>Click to access the Federal Award Data page, where you can enter the PIID, Parent PIID, FAIN and URI fields.</p> <hr/> <p>Note: This link is available only when the Enable Procurement Fields or the Enable Financial Assistance Fields is enabled on the Installation Options – Federal Processing Option page and the Products option is either ‘PO’ or ‘PO and GL’.</p> <hr/>
Requisitions	<p>Click to view the requisition details that were used to create the purchase order.</p>
Document Status	<p>Click to access and review information about procurement documents associated with a purchase order.</p> <p>See Document Status Page - Purchase Order.</p>
Procurement Group	<p>Click to access the Procurement Groups page where you can create or update a procurement group ID.</p>
Actions	<p>Click to access Related Actions and Related Information. Once the Supplier, Buyer information has been entered, the user can view additional information using:</p> <p>Related Actions</p> <p>Supplier Hierarchy</p> <p>Related Information:</p> <ul style="list-style-type: none"> • Spend by Supplier • Recent POs • Overdue POs • Vendor / Supplier Returns

Amount Summary

Field or Control	Description
Merchandise	<p>Displays the merchandise amount according to the quantities and prices of the items on the purchase order.</p> <p>This field is not available if this purchase order is used with a recurring purchase order voucher.</p>
Freight/Tax/Misc (freight/tax/miscellaneous)	<p>Click the link associated with the Freight/Tax/Misc field.</p> <p>When you click this link the PO Total Amount Details page appears. Using this page you can view the total amount of adjustments made to this purchase order. This includes GST amount, custom duty, Tax amount, Miscellaneous charges, freight, Total Adj amount, and Total amount. See “Understanding the India Goods and Services Tax (GST)” (PeopleSoft Global Options and Reports)</p>
Calculate	Click to recalculate the freight total for this purchase order.
Total Amount	The total amount on the purchase order calculated from the merchandise and adjustment amounts appears.

Field or Control	Description
Encumbrance Balance	<p>Displays the encumbrance balance. When you use commitment control, the system deducts each type of financial obligation from the budget and tracks it according to obligation type. This enables you to determine the money that you have committed in encumbrances. The system extracts these values from commitment control tables by passing the business unit, document ID, and other key information that depends on the display. The system displays this field only when commitment control is enabled and if the document has been budget checked at least once. In addition, a default detail ledger must be identified so that the accounting entries can be summarized to display the respective encumbrance balance for the purchase order. Encumbrance balances are updated each time you budget check the purchase order</p> <p>When you generate a requisition, a pre-encumbrance is created in budget records by the budget-checking process. When a requisition is sourced to a purchase order, commitment control liquidates the pre-encumbrance from the requisition and establishes an encumbrance for the purchase order.</p> <p>Encumbrance balances display on the currency code for the balances in the transaction currency of the purchase order and is based on the transaction date rate. You can have an encumbrance currency value in a different currency than the supplier's currency. Balances can be partially or fully sourced from requisitions and can be for multiple purchase order lines, schedules, and distributions.</p> <p>You can view accounting details for the purchase orders. Click the Encumbrance Balance field link to access the Purchase Order Accounting Entries page. You use this page to view accounting information including the commitment control ledger group and transactions that have been performed against the purchase order.</p> <p>See “Viewing Budget Details and Transaction Activity” (PeopleSoft Commitment Control).</p>

Add Items From

Field or Control	Description
Purchasing Kit	Click to access the Enter Kit Items page where you can select a kit and a quantity to add to the purchase order.

<i>Field or Control</i>	<i>Description</i>
Catalog	Click to access the Order By Catalog page where you can select a catalog items to add to the purchase order.
Item Search	Click to access the Item Search Criteria page where you can define search criteria for items to add to the purchase order.

Select Lines to Display

<i>Field or Control</i>	<i>Description</i>
Line	Select a beginning line for a range of lines that you want to display in the Lines grid.
To	Select the ending line that you want to display.
Retrieve	Click to display the purchase order lines that you selected. If a line has changed, the system saves the changes before populating the Lines grid with the line.

For Information on PO Advanced Search See [Working with Large Purchase Orders](#)

Lines

Use the Lines grid box to view basic purchase order line information and to select additional tasks to perform against purchase order lines.

Additional Options

<i>Field or Control</i>	<i>Description</i>
View Printable Version	<p>Click this link to review the purchase order printout on the screen. Clicking this link does not print the purchase order. Be aware that the purchase order is saved prior to display. To preview the purchase order, you must enter header, line, schedule, and distribution information.</p> <p>If the Enable XMLP Publisher option is selected at the installation level, then the purchase order will be printed using the BI Publisher PO Online report. If the option is not enabled, then the system provide the POPO005.sqr version of the PO report.</p>

Field or Control	Description
Delete PO	<p>Click this button to delete the entire purchase order. When you click this button, you must confirm that you want to delete the purchase order. After you delete a purchase order, the same purchase order ID can be reused.</p> <p>You can only delete purchase orders if you have been authorized for purchase order deletion on the User Preferences - Procurement: Purchase Order Authorizations page.</p> <hr/> <p>Note: When using PeopleSoft Supplier Contract Management and a purchase order has an authored contract document associated to it, the deletion of the purchase order is only allowed if there is not an authored document present. If a document does exist, you should contact the contract specialist before deleting the authored document if it is in a status that allows deletion.</p>
View Approvals	Click to review who is required to approve this purchase order. This link displays when you are not the approver for this purchase order.
Purchase Order Approval	Click to review and approve this purchase order. This link displays when you are the approver for this purchase order.
Close Short All Lines	<p>Click to select or deselect all lines purchase order lines short. Closing a line short enables you to close future receiving for purchase order lines. When you select to close a purchase order line short and the close short processing requirements are met, the system reduces the quantity on the schedules for the purchase order line to the quantity that has been received. If there has been no receiving for the purchase order schedule, the system cancels the schedule instead of reducing the quantity to zero.</p> <p>When you click the button, the system either selects or deselects the Close Short option for each purchase order line. If the option is not available for a purchase order line, the system does not select or deselect that line.</p>
Go To	Select a feature that you want to access. When you select the feature, the system navigates to the corresponding page.

Related Links

[VAT Information for a Schedule Page](#)

[Details for Line Page](#)

[Maintain Purchase Order - Schedules Page](#)

[POPO005 - PO Dispatch/Print](#)

[Understanding Purchase Order Approvals](#)

[Purchasing Definition - Business Unit Definition Page](#)

[Document Status Page - Purchase Order](#)

[Understanding Document Tolerances](#)

[Purchase Order Header Status Values](#)

“Defining Document Tolerances” (PeopleSoft Source to Settle Common Information)

“Creating Change Templates” (PeopleSoft Source to Settle Common Information)

Federal Award Data page

Use the Federal Award Data page to enter information to the PIID, Parent PIID, FAIN and URI fields.

Navigation:

Click the Federal Award Data link on the, Maintain Purchase Order - Purchase Order page

This example illustrates the fields and controls on the Federal Award Data page. You can find definitions for the fields and controls later on this page.

Federal Award Data

PIID

Parent PIID

FAIN

URI

Exclude from DATA Act Reporting

Field or Control	Description
PIID	<p>Enter a value for the PIID. You must enter a PIID if the Parent PIID is defined. The value should be in between the length defined at the Installation page.</p> <p>This option is available only if the Enable Procurement Fields is enabled on the Installation Options page.</p>
Parent PIID	<p>Enter a value for the PIID. The value should be in between the length defined at the Installation page.</p> <p>This option is available only if the Enable Procurement Fields is enabled on the Installation Options page.</p>

Field or Control	Description
FAIN	<p>Enter a value for the FAIN. The value should be in between the length defined at the Installation page.</p> <p>This option is available only if the Enable Financial Assistance is enabled on the Installation Options page.</p>
URI	<p>Enter a value for the URI. The value should not exceed the length defined at the Installation page.</p> <p>This option is available only if the Enable Financial Assistance is enabled on the Installation Options page.</p>
Exclude from DATA Act Reporting	<p>Select this option to exclude the Purchase Order from DATA Act reporting for RSS File C. The PIID, FAIN, or URI are displayed based on the settings on the Installation Options page. By default this field is not checked.</p>

Supplier Details Page

Use the Supplier Details page (PO_Supplier) to enter exceptions to the default values for the Supplier such as, Supplier order location, address, contact, and salesperson.

Navigation:

Click the **Supplier Details** link on the Maintain Purchase Order - Purchase Order page.

Field or Control	Description
Location	Select the supplier location, if you want to override the default.
Supplier Location GLN (supplier location global location number)	Displays the global location number for the corresponding supplier location, if available.
Terms	<p>Specify payment terms for the supplier location, if you want to override the default.</p> <hr/> <p>Note: The payment terms on the purchase order voucher in PeopleSoft Payables are the payment terms from the purchase order header.</p> <hr/>
Basis Dt Type (basis date type)	<p>Defines the date that the system uses as the term basis date for scheduling payment and determining early payment discounts. Values include <i>Acct Date</i> (accounting date), <i>Doc Date</i> (constructive document receipt date), <i>Inv Date</i> (invoice date), <i>Recpt Date</i> (receipt date), <i>Ship Date</i>, and <i>User Date</i> (user specified date).</p>

Field or Control	Description
Basis Date	Select a basis date. This field is available when the basis date type is <i>User Date</i> .
Address	Select an address for this location. Click the Address Details link to view supplier location address details in the lower portion of the page.
Contact	Select a contact person for the supplier. Click the Contact Details link to view contact address details in the lower portion of the page.
Salesperson	Select a salesperson for the supplier. Click the Salesperson Details link to view salesperson address details in the lower portion of the page.

PO Header Details Page

Use the PO Header Details page (PO_HDR_DTL) to enter purchase order header details, enter rules for the entire order, and hold the purchase order from further processing.

Navigation:

Click the **Header Details** link on the Maintain Purchase Order - Purchase Order page.

This example illustrates the fields and controls on the PO Header Details Page. You can find definitions for the fields and controls later on this page.

PO Header Details x
Help

PO Details

Supplier

*PO Type Bill Only

*Billing Location Billing Address

Origin PO

Use One Ship To

PO Date

Budget Status

Tax Exempt

ID

Letter of Credit ID

Ship To

Currency

Currency Code Exchange Rate Detail

Rate Date

Rate Type

Base Currency

Exchange Rate

Process Control Option

Dispatch

*Method

Template ID

Acknowledgements required for

Accounting Date

Accounting Template

Custom Fields

Custom Character 1

Custom Character 2

Custom Date

Custom Field 1

Custom Field 2

Custom Field 3

Custom Field 4

PO Details

<i>Field or Control</i>	<i>Description</i>
PO Type	<p>Select the type of purchase order that you are creating from a user-defined selection list. This value, with the exception of Kanban, is not used in purchase order processing, but can be used for informational purposes.</p> <hr/> <p>Note: You cannot directly create a PO type of Bill Only or Bill and Replace. These types must come from a requisition.</p>
Billing Location	<p>Location code that designates the billing address displays.</p>
Tax Exempt	<p>Select if the purchase order is exempt from sales and use taxes. Exemption from VAT is handled through the VAT setup. If selected, enter a tax exempt ID in the ID field. The tax exempt ID prints on the purchase order.</p>

Field or Control	Description
Letter of Credit ID	<p>Select a letter of credit ID. This value is used as a reference on the purchase order and appears by default on the purchase order voucher pages.</p>
Use One Ship To	<p>Select to restrict the purchase order to a single Ship To location. If you select this option when multiple Ship To locations are present on the purchase order, the system displays an error. You must either make sure that all the ship to locations match or deselect the option before saving. The system also returns an error if any of the schedules has a one-time Ship To address or if there is a direct shipment or direct receipt or sourcing events on the PO</p> <hr/> <p>Note: During creation of PO for direct shipments the Use One Ship To indicator is turned off and the Ship To field displays “multiple”</p>
Ship To Location	<p>Displays whether or not there is a single Ship To location for this PO. Ship to Location displays “Multiple” when there are multiple ships to locations or if there is a one-time address or a direct shipment or direct receipt on the PO. Otherwise, it will display the single Ship To Location.</p>
GTC Number	<p>Enter or select the G-Invoicing General Terms and Conditions number. The invoice type (Standard or EZ) is auto-displayed based on the GTC number.</p> <hr/> <p>Note: This field is available if G-Invoicing is enabled in Installation Options and the Supplier is Federal.</p>
Order Number	<p>Enter or select the order number for G-Invoicing.</p> <p>For 7600EZ, the Order Number must be empty.</p> <hr/> <p>Note: This field is available if G-Invoicing is enabled in Installation Options and the Supplier is Federal.</p>

Currency

<i>Field or Control</i>	<i>Description</i>
Currency Code	The currency to use on the purchase order displays. The currency code can be changed only when the business unit allows multicurrency.
Rate Date	The date of the rate used in the currency calculation displays.
Rate Type	Displays the currency exchange rate the system uses to convert between the purchase order transaction currency code value and the purchase order business unit Base Currency value.
Exchange Rate	Displays the rate at which the currency exchange is performed, based on the rate date and rate type.

Procurement Card Dispatch Options

<i>Field or Control</i>	<i>Description</i>
Dispatch Option	<p>Select the procurement card dispatch option if you are using the procurement card functionality. Options are:</p> <ul style="list-style-type: none"> • <i>Charge to Card on File</i>: Select this option to have "Charge to credit card" print in the header portion of the PO Dispatch/Print SQR report (POPO005). • <i>Contact Buyer</i>: Select this option to have the buyer's name and phone number print in the header portion of the PO Dispatch/Print report. For example, "*Please contact John Smith 925-694-3863 for payment information." • <i>Contact Cardholder</i>: Select this option to have the card holder's name and phone number print in the header portion of the PO Dispatch/Print report. For example, "*Please contact John Smith 925-694-3863 for payment information." • <i>Include Masked Card Info</i> (include masked card information): Select this option to have the masked card number, card type, and expiration date appear in the header portion of the PO Dispatch/Print report. • <i>No Reference</i>: Select this option to have no procurement card information print on the PO Dispatch/Print report.

Field or Control	Description
Contact Name and Contact Phone	<p>These field are only available if you select a dispatch option of <i>Contact Buyer</i> or <i>Contact Cardholder</i>.</p> <p>If you select Contact Buyer the buyers name and phone number appear.</p> <p>If you select Contact Cardholder the cardholders name and phone number appear.</p>
Instructions	Enter additional procurement card instructions if you so choose.

Process Control Option

Field or Control	Description
Acknowledgements Required for	<p>Select whether purchase order acknowledgements are required by the supplier. The default values are retrieved from either the Procurement Options page associated with the Supplier location in the Supplier Information component or the POA Settings page in the Purchasing Options component. If no values are defined at the Supplier location level then the system retrieves the values associated with purchasing business unit. This value can not be changed once the purchase order has been dispatched. This value can be overridden here for the given purchase order. Values are:</p> <ul style="list-style-type: none"> • <i>All dispatches</i>: POAs are required by the supplier for all dispatched purchase orders and change orders. • <i>Initial dispatch only</i>: POA is only required by the supplier for the first dispatch of a purchase order. Change orders do not require POAs. • <i>Not required</i>: POAs are not required by the supplier.
Dispatch	Selected by default so that once the status of the purchase order is <i>Approved</i> , the purchase order is a candidate for the next dispatch process. To prevent the purchase order from being dispatched, clear this option.
Method	Override the default dispatch method by selecting <i>EDX</i> , <i>Fax</i> , <i>Phone</i> , <i>Email</i> , or <i>Print</i> .

Field or Control	Description
Email Address	When the dispatch method is email, this field is enabled to allow entry of an override email address for the dispatch of the current purchase order.
Prefix, Telephone, and Ext (extension)	When the dispatch method is fax, these fields are enabled to allow entry of an override fax phone number for the dispatch of the current purchase order.
Accounting Date	Determines the open period or allowable open date range for budget checking a purchase order when you are using commitment control. If the purchase order's accounting date falls before or after the open period date range, the system provides a message to prevent or warn you from running budget checking.
Accounting Template	Displays the accounting template for the purchase order. The accounting template is used to determine ChartField values that are used to offset one-sided transactions in PeopleSoft Purchasing.

Custom Fields

The user definable fields in this Custom Fields section are available when you check the Enter Custom Fields check box on the Purchasing Installation Options page. You can customize these fields for your use. The custom fields are informational only.

Custom fields are copied from other sources, such as requisitions. When copied from a Bill Only or Bill and Replace requisition, the header fields from the requisition are also copied, due to the one-to-one relationship. For all other types, header fields are not copied due to the fact that you can consolidate sources to a single PO.

For more information about Custom Fields, see [Understanding User-Definable Fields](#).

Related Links

[Approving Purchase Orders With PeopleTools Workflow Technology](#)

“Understanding Voucher Processing and the Voucher Life Cycle” (PeopleSoft Payables)

[Understanding Purchase Order Dispatch](#)

[PO Stage Load Page](#)

[POA Settings \(purchase order acknowledgements settings\) Page](#)

“Defining Supplier Locations” (PeopleSoft Source to Settle Common Information)

PO Header Comments Page

Use the PO Header Comments page (PO_COMMENTS_SEC) to enter comments for a transaction.

You can enter a unique comment or select from predefined standard comments.

Navigation:

Click the **Add Comments** link on the Maintain Purchase Order - Purchase Order page.

Field or Control	Description
Retrieve Active Comments Only	<p>Select this option to retrieve only active comments. In Add mode, this option is selected and cannot be cleared.</p> <p>Once you inactivate a comment line using the Inactivate button, save, and then re-enter the transaction, you cannot access the comment line when this option is selected. You can clear this option to retrieve the comment line that you inactivated, in addition to any active comment lines.</p>
Sort Method	<p>Select the method that you want to use to sort the comments retrieved:</p> <p><i>Comment Time Stamp:</i> Select to sort the comments by the time stamp assigned by the system when they were created or modified.</p> <p>Each time a comment is modified the comment time stamp is updated with the current date and time.</p> <p><i>Supplier Flag:</i> Select to sort by comments flagged to be sent to the Supplier.</p>
Retrieve	<p>Click this button to load existing comments into the comments text box. This button appears only if existing comments are available.</p> <p>For header and line comments, when you click the Retrieve button, previous comments that have been loaded may have been already worked. So retrieving the comments override all the comments that have been worked on. Any context that was previously saved as a standard comment is saved after the transaction is finished.</p>
Sort	<p>Click this button to sort comments according to the selections that you made in the Sort Method and Sort Sequence fields.</p>
Copy Standard Comments	<p>Click this link to copy standard comments to the purchase order header comments. When you click this link the Standard Comments page appears.</p> <p>See “Setting Up Standard Comments” (PeopleSoft Source to Settle Common Information).</p>

Field or Control	Description
Inactivate	<p>Click this button to inactivate the currently displayed comment. The comment is not actually deleted, but is set to an inactive status.</p> <p>You must clear the Retrieve Active Comments Only option in order to access any inactive comments.</p> <p>If you have inactivated a comment, you must select the Retrieve button to reselect the comments.</p>
Send to Supplier	<p>Select this option if you want comments to appear on purchase orders dispatched to suppliers. If the comments are for internal use only, clear the option. The Send to Supplier option applies to comments in the comment text box only, not to the documents that you attach using the Associated Document fields.</p>
Shown at Receipt	<p>Select if you want comments to appear on the receipt documents.</p>
Shown at Voucher	<p>Select if you want comments to appear on the vouchers.</p>

Associated Document

Use the fields in this group box to attach files to the transaction. You can attach any type of file. The documents that you choose to attach do not transmit with the purchase order to the Supplier.

Note: When deleting an attachment, the system checks that the attachment is not referenced on another transaction within Supplier Relationship Management products. The physical file attachment will only be deleted from the server if no other document is linked to it. After an attachment is confirmed as deleted from the server, the file is removed immediately.

Field or Control	Description
Attachment	<p>Displays the attachment ID. This field is unavailable for entry because the attachment is automatically assigned.</p>
Attach	<p>Click this button to attach a document to the comments. When you click the attach button you will be prompted to select a file for uploading. Select the file, and then click the Upload button.</p>
View	<p>Select this button to display an attachment that has already been linked to the comments.</p>

Field or Control	Description
Email	<p>Select this option if you want to email the attachment with dispatched documents. Attachments are only emailed as part of the purchase order email if the email flag is selected and the Dispatch Method is email. The attachment email process requires the system to download the attachment to a temporary directory. That temporary directory is by default c:\temp, but can be modified using the File Locations page.</p> <p>See “Defining Additional Common Information” (Application Fundamentals).</p>
Go To Source	<p>If the transaction's comments originated with another transaction, you can click this link to view the originating source transaction. This link is available only if a source is available.</p> <p>For example, if the requisition was copied from another requisition containing these comments, you can select this link to view the originating requisition.</p>

Purchase Order Defaults Page

Use the Purchase Order Defaults page (PO_DEFAULTS) to override the defaults set at the business unit, buyer, or Supplier level and set defaults when none exist.

Navigation:

Click the **PO Defaults** link on the Maintain Purchase Order - Purchase Order page.

This example illustrates the fields and controls on the PO Defaults page. You can find definitions for the fields and controls later on this page.

Purchase Order Defaults

Business Unit US001 PO ID NEXT Supplier ROBERTHALV-001

Default Options ?

Default If you select this option, the default values entered on this page are treated as part of the defaulting logic and are only applied if no other default values are found for each field. If default values already exist in the hierarchy, they are used, and the values on this page are not used.

Override If you select this option, all default values entered on this page override the default values found in the default hierarchy.

Line

Category Unit of Measure

Schedule

Ship To USA - New York Ultimate Use Code

Due Date Original Promise Date

Ship Via COMMON Freight Terms Code DES

Arbitration 1000000001 Freight Charge Method Order Quantity

*Distribute By Quantity One Time Address

Distribution

Accounting Tag

Distributions Personalize | Find | View All | First 1 of 1 Last

Chartfields Asset Information

Dist	Percent	GL Unit	Account	Alt Acct	Oper Unit	Dept	Program	Class	Fund	Bu
1	<input type="text"/>	US005	<input type="text"/>		<input type="text"/>	11000	<input type="text"/>	<input type="text"/>	<input type="text"/>	<input type="text"/>

If you make changes or add values to the defaults on this page, when you exit the page, you are prompted with the **Retrofit** field changes to all existing PO line, schedule, and distribution page.

Default Options

<i>Field or Control</i>	<i>Description</i>
Default	If you select this option, the new default value that you enter on this page is assigned to the given field if no other value is assigned from prior defaults.

Field or Control	Description
Override	<p>If you select this option, the new value that you enter on this page overrides any value that is assigned from prior defaults. Only non-blank values are assigned.</p> <hr/> <p>Note: If you are maintaining a purchase order that is associated with a PeopleSoft Maintenance Management work order, the system will not override the changes you make on this page for PeopleSoft Project Costing information (PC Business Unit, Project, and Activity fields) and asset information (AM Business Unit and Profile ID). The system does not apply project changes to the distribution rows because the work order is linked with projects information and we cannot change these values in PeopleSoft Purchasing. Plus, the asset information changes are not applied because distributions linked with a work order non-inventory cannot be received as assets.</p> <hr/>

Line

Field or Control	Description
Category	<p>Select a default category code for the purchase order. Selecting a default value here enables you to order ad hoc (description-only) items. The category entered here only applies to ad hoc (description only) lines.</p>
Unit of Measure	<p>Select a default unit of measure (UOM) for the purchase order. Selecting a default value here can facilitate the ability to order ad hoc items.</p>

Schedule

Field or Control	Description
Ship To	<p>Displays the default ship to location, which appears on the purchase order schedule as the location to which the Supplier ships the order. A change to the ship to location implies sales and use tax and VAT recalculations on the PO Header - VAT Information page.</p> <hr/> <p>Note: If you change the ship to location to a different inventory business unit that requires closure calendar validation and processing for receiving activities as defined on the Closure Calendar page, the system validates the Due Date value as a valid date for receiving. If it encounters an exception date, it uses the next valid future date as the due date.</p> <hr/>
Due Date	<p>Displays the default due date. The due date for each schedule has the default value of the purchase order date, plus the number of lead-time days defined for the item (or item category if an ad hoc item). You can override the due date by using the PO Defaults page. If the default option is <i>override</i>, the system uses the override value, and the lead time calculation is ignored. If the default option is <i>default</i>, the system calculates the due date based on the purchase order date plus the number of lead time days.</p> <p>When an item changes, the due date is updated to reflect the lead time days associated with the new item. If the category for an ad hoc changes, the due date is also updated to reflect the lead time days associated with the item category. If the purchase order defaults page is set to <i>override</i>, the override is applied.</p> <hr/> <p>Note: If the inventory business unit associated with the ship to location requires closure calendar validation and processing for receiving activities as defined on the Closure Calendar page and the Due Date value falls on a defined closure date, the system issues a warning. You can choose to keep the invalid date, or use the next valid date on the calendar.</p> <hr/>
Ship Via	Carrier or method of shipment.

Field or Control	Description
Distribute by	<p>You can either distribute by amount or quantity.</p> <p>When you select Override on this page, you can set up multiple distribution lines. You then enter the percentage for each distribution in the distribution details. The sum of the line distribution percentages must equal 100 percent.</p>
Liquidate by	<p>Liquidate the outstanding pre-encumbrance and encumbrance balances by amount or quantity.</p> <hr/> <p>Note: This field is only visible if commitment control is enabled, and you select Liquidate by Quantity on the Purchasing Definition - Business Unit Options page. If commitment control is not installed, or you do not select the option to liquidate by quantity on the purchase order business unit page, the budget processor balance liquidates by amount only.</p> <hr/>
Ultimate Use Code	<p>In most cases, sales tax is computed as a use tax based on the tax code applicable to the ship to or usage destination. However, how merchandise is ultimately used may also result in a different tax rate within the same ship to or usage destination. Enter an ultimate use code to override the default tax rate for a location.</p>
Original Promise Date	<p>Date on which the Supplier originally committed to deliver the item. The default due date appears by default in this field and is updated when the item or item category (ad hoc items) changes. If you override the due date on the PO Defaults page, the purchase order date plus the number of lead time days defined for the item or item category (ad hoc items) will be used, not the overridden due date. You can override the original promise date on the PO Defaults page.</p>
Freight Terms Code	<p>Freight terms code that applies to the schedules for this purchase order.</p>

Distribution

<i>Field or Control</i>	<i>Description</i>
SpeedChart	<p>Select a speed chart. The SpeedChart field enables you to use a code that contains preset distributions. This speed chart is not itself a defaulting element. Instead use it here to assist you in defining default chart field elements.</p> <hr/> <p>Note: The field is enabled only when the default option is set to <i>override</i>.</p> <hr/> <p>Note: Accounting Tags appear in lieu of Speedcharts when the Accounting Tag option is selected for Purchasing on the Accounting Tag Registration page. See “Setting Up Accounting Tags” (Application Fundamentals)</p>
Accounting Tag	<p>Enter an Accounting Tag to populate ChartFields on transaction distribution lines. The system automatically prorates the distribution amounts according to the proration percentages defined on the Accounting Tag.</p> <hr/> <p>Note: Accounting Tags appear in lieu of Speedcharts when the Accounting Tag option is selected for Purchasing on the Accounting Tag Registration page. See “Setting Up Accounting Tags” (Application Fundamentals)</p>

Distributions - Chartfields

<i>Field or Control</i>	<i>Description</i>
Budget Date	<p>If you are using commitment control, this field is available. The default date is the accounting date, but you can override it. When you save the purchase order, the system confirms that the budget date is within the valid open period date range for the general ledger business unit.</p>

Distributions - Asset Information

Select the Asset Information tab.

Field or Control	Description
AM Bus Unit (PeopleSoft Asset Management business unit)	<p>Select a PeopleSoft Asset Management business unit to associate with the asset item.</p> <hr/> <p>Note: If you consider an item to be an asset and plan to pass it to PeopleSoft Asset Management through the PeopleSoft Receiving business process, you must populate both the PeopleSoft Asset Management business unit and Profile ID fields.</p> <p>If both fields contain values, data is written to the PeopleSoft Asset Management staging tables. If only one of the fields is populated, the system will not consider the item an asset.</p> <hr/>
Profile ID	Select an asset profile ID.
Capitalize	Designates a capitalized item. A PeopleSoft Asset Management business unit must be selected in order for this option to be enabled. If the item is capitalized, it can be depreciated before being paid.
Cost Type	<p>Select the cost type associated with the item purchase, if applicable. Cost types represent components of the cost of an asset, such as materials, labor, and overhead. For example, you can differentiate between the cost of building an asset and its market value by allocating production cost to one cost type and the profit margin to another. Cost type, in combination with asset category and transaction code, determines which accounts the costs are entered into in the general ledger.</p> <p>See “Understanding the Manufacturing Standard Cost Foundation” (PeopleSoft Cost Management).</p>

Related Links

[Details for Schedule Page](#)

“Standard ChartField Configuration Page” (Application Fundamentals)

“Understanding PeopleSoft ChartFields” (Application Fundamentals)

“Ship Via Codes Page” (Application Fundamentals)

“Freight Terms Page” (Application Fundamentals)

“Defining Common Tables to Manage Assets” (Asset Lifecycle Management Fundamentals)

“Establishing Operation Closure Dates” (PeopleSoft Inventory)

“Defining Ship To Locations” (PeopleSoft Source to Settle Common Information)

“Defining SpeedCharts” (PeopleSoft Source to Settle Common Information)

[Define Accounting Tag](#)

Retrofit field changes to all existing PO lines/schedule/distributions Page

Use the Retrofit field changes to all existing PO lines/schedule/distributions page (PO_DFLT_RETROFIT) to apply default field value changes to existing lines, schedules, and distributions.

Navigation:

Exit the Purchase Order Defaults page after you have entered field value changes on the pages or any of the pages accessed from it, and you have a transaction line that contains item description and quantity information.

When accessed from the Purchase Order Defaults page, this page enables you to retrofit the default field value changes to lines, schedules, and distributions on a purchase order without having to apply them to each area. You can make the changes once and apply as many of them as you want to the transaction.

The option to apply these defaults is available whether you select the **Default** or **Override** option on the Purchase Order Defaults page.

Category and unit of measure defaults can be applied at the line level only for ad hoc item orders.

<i>Field or Control</i>	<i>Description</i>
Apply	<p>Select this option to apply the default field value change to the distribution line that appears in the Distrib Line field. For example, if you select Apply for distribution line 3, the change will be applied to each distribution line 3 that appears on the purchase order.</p> <p>If the Distrib Line field is blank, this means that the default field value change does not apply at the distribution level. In this case, select the Apply option to carry the default field value change to the line or schedule level instead.</p>
Distrib Line (distribution line)	Displays the distribution line affected by the field value change. If this field is blank, this means that the default field value change does not apply at the distribution level.
Apply to All Distribs (apply to all distributions)	<p>Select this option to apply the default field value change to all existing distribution lines on the transaction, regardless of the distribution line value that appears.</p> <p>A distribution percentage value (DISTRIB_PCT) is specific to an individual distribution line. Therefore, the Apply to All Distribs option is unavailable for this field value change.</p>

Related Links

[Purchase Order Defaults Page](#)

Maintain Purchase Order - Procurement Card Information Page

Use the Maintain Purchase Order - Procurement Card Information page (CC_USE_HDR_DTL) to review the existing procurement card information, add or update the procurement card information, or override the existing procurement card with another one.

Navigation:

Click the **Use Procurement Card** link on the Maintain Purchase Order - Purchase Order page.

Procurement Card used for payment

<i>Field or Control</i>	<i>Description</i>
Card Number, Card Type, and Expiration Date	Displays the procurement card information that will be used for payment on this purchase order. If no card is assigned no values appear in this group box.

Override with Procurement Card or Supplier Card

<i>Field or Control</i>	<i>Description</i>
Card Number	Select the procurement card or Supplier card that you want to use for the payment method on this purchase order. The card numbers that are available for selection are related to the buyer who has the rights to use a procurement card on a purchase order and the Supplier cards related to the Supplier and location. After you select a new card number it will override the existing card number.
Don't use Procurement Card	Click this option if you do not want to use a procurement card as the payment method on this purchase order.

PO Header - VAT Information Page

Use the PO Header - VAT Information page (PO_HDR_VAT) to view header VAT details.

Navigation:

Click the **Header VAT** link on the Maintain Purchase Order - Purchase Order page.

Many of the fields on the PO Header - VAT Information page are the same fields described on the VAT Information for a Schedule page.

See [VAT Information for a Schedule Page](#).

Dispatch Options Page

Use the Dispatch Options page (DISPATCH_OPTIONS) to enter dispatch options for the purchase order and to dispatch a purchase order to the Supplier.

Navigation:

Click the **Dispatch** button on the Maintain Purchase Order - Purchase Order page.

This example illustrates the fields and controls on the Dispatch Options page.

<i>Field or Control</i>	<i>Description</i>
Use One Ship To	Select to restrict the purchase order to a single Ship To location. If you select this option when multiple Ship To locations are present on the purchase order, the system displays an error. You must either make sure that all the ship to locations match or deselect the option before saving. The system also returns an error if any of the schedules has a one-time Ship To address or if there is a direct shipment or direct receipt on the PO.
Ship To	Displays (on saved POs) whether or not there is a single Ship To location for this PO. Ship to Location displays “Multiple” when there are multiple ships to locations or if there is a one-time address or a direct shipment or direct receipt on the PO. Otherwise, it will display the single Ship To Location.
Fax Cover Page	Enter the location of the fax cover page file.

Field or Control	Description
Test Dispatch	Select this option if you want to do a test dispatch and do not want to dispatch to the Supplier. The word <i>Unauthorized</i> prints at the bottom of the transaction document. The system dispatches the purchase order, but it doesn't update the purchase order status from <i>Approved</i> to <i>Dispatched</i> .
Print BU Comments (print business unit comments)	Select this option to have the comments (terms and conditions) that you defined for the purchasing business unit appear on the purchase order upon dispatch. These comments are assigned to the purchasing business unit by clicking the Comments link on the Purchasing Definition - Business Unit Definition page.
Server Name	Select the name of the server that you want to process the dispatch request.
Print Duplicate on PO (print duplicate on purchase order)	Select this option to print the word <i>duplicate</i> on the transaction document.
Output Destination Type	Select the dispatch method. Values are <i>FILE</i> , <i>PRINTER</i> , and <i>WEB</i> .
Print Changes Only	Select this option if you are dispatching a change order and want to print only the changes that were made to the purchase order.
Print PO Item Description	Select to print the item description from the Maintain Purchase Order - Purchase Order page, instead of from the Purchasing Attributes page. The item description stored on the purchase order is in the base language and may have been modified on the purchase order.
Output Destination Format	Select the appropriate format for the dispatched file, based on how you want to send the file to the Supplier. Values are: <i>CSV</i> , <i>HP</i> , <i>HTM</i> , <i>LP</i> , <i>Other</i> , <i>PDF</i> , <i>PS</i> , and <i>SPF</i> .
Print Copy	Select this option if you want to print a copy of the dispatched document. If any of the purchase orders are dispatched by phone, fax, email, or EDX, a hard copy is printed for review.
Print Closed Line Amount	Select this option to display closed lines in the PO Dispatch. Closed line amounts will be included in the purchase order total amount.

Field or Control	Description
Number of Copies	Enter the number of copies that you want of the report. This field appears when you select to the Print Copy option.
Template ID	Select the report template that you want to use to dispatch a purchase order. You use the report template to identify an BI Publisher report layout. The template provides a common report layout for dispatching purchase orders for both PeopleSoft eProcurement and Purchasing. The default value for the field is blank. See Dispatching Purchase Orders .
File Destination	Enter the location where you want to send the file,

Related Links

[Purchasing Definition - Business Unit Definition Page](#)

“Fax Cover Letters Page” (PeopleSoft Source to Settle Common Information)

PO Dispatched History Page

Use the PO Dispatched History page (PO_DISP_DSPLY) to view the dispatch history of the purchase order.

Navigation:

Select *02 - PO Dispatched History* in the **Go to** field on the Maintain Purchase Order - Purchase Order page.

This example illustrates the fields and controls on the PO Dispatched History page.

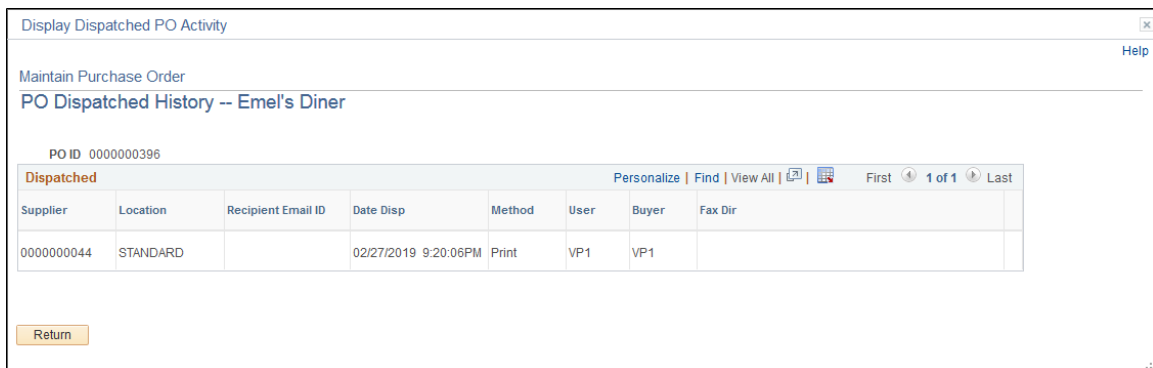

Field or Control	Description
Supplier	Displays the supplier ID associated with the dispatched purchase order.

Field or Control	Description
Recipient Email ID	Displays the email ID of the recipient associated with the dispatched purchase order.
Buyer	Displays the buyer associated with the dispatched purchase order.
Fax Dir (fax directory)	Displays the directory where the fax file is located. The file is generated during the dispatch process for purchase orders with a fax dispatch method.

PO Matching Page

Use the PO Matching page (PO_MATCHING) to enter matching information for the purchase order.

Navigation:

Select *11 - Matching* in the **Go to** field on the Maintain Purchase Order - Purchase Order page.

Match Status

Displays the match status. Values are *To Match*, *Part Matched*, or *Fully Matched*, based on the extent to which the matching process has been completed for the purchase order.

Match Options

Field or Control	Description
Match Action	Controls the type of match rules that you can add to this match rule control. Values include: <i>No Match</i> : No match required. <i>Standard</i> : Comprises two-way (purchase order to voucher), two-way (receipt to voucher), three-way, four-way, or ERS (evaluated receipt settlement) matching.
ERS Action	Values include: <i>Yes</i> : Matches receipts against purchase orders and generates vouchers without requiring an invoice. <i>No</i> .
Match Rule	Select a match rule.

Related Links

“Understanding the Matching Process” (PeopleSoft Payables)

Change Reason Page

Use the Change Reason page (PO_CHNG_REASON) to assign purchase order change request reasons.

Navigation:

Purchasing, Purchase Orders, Add/Update POs

Click **Save** after updating a field defined for change tracking.

When you save a purchase order that has been dispatched and that has had a change tracking field updated, the system prompts you to enter a change reason using this page. The change reason defaults from the business unit options default value to this page if it has been setup.

You can also access this page by clicking the **Current Change Reason** link on the Purchase Order page.

<i>Field or Control</i>	<i>Description</i>
Reason Code	Select a change request reason code. This field is required when reason codes are required for change requests.
Comment	Enter information about the reason for the change. This field is required when comments are required for change requests.
Use Same Reason Code	Select to indicate that you do not want the system to display this page the next time it saves the purchase order. If the option is deselected, the system continues to provide this page each time it saves the purchase order. In this case, each time that you change the change reason or change reason comment, the system creates a new change tracking reason transaction in the PO_CHNG_REASON record. The system associates the updated fields with the change reason code that you select on this page and for subsequent updates until a new change reason is specified or the purchase order is dispatched. Changes to tracked fields are available using the Review Change History component.

See [Procurement Change Reason Codes Page](#).

Creating Purchase Order Lines

This section discusses how to Create Purchase Order Lines

Pages Used to Create Purchase Order Lines

Page Name	Definition Name	Usage
<u>Maintain Purchase Order - Purchase Order Page</u>	PO_LINE	Enter or change purchase order information online.
Enter Kit Items Page	PO_KIT_ITEMS	Order an item by kit ID. The individual items in the kit become new lines on the purchase order.
Order By Catalog Page	ORD_BY_ITEM_CAT	Search for and select items to order from a catalog.
<u>Item Search Criteria Page</u>	ITEM_SEARCH_SP	Search for items.
<u>Details for Line Page</u>	PO_LINE_DTLS	Enter additional information for this line, such as contract and supplier item information, item manufacturer information, price calculation parameters, and you can specify whether the item requires receiving and inspection. Any changes that you make on this page apply only to the selected line.
Item Description Page	PO_ITEM_DESCR	Enter and view descriptions for a specific item.
Configuration Info Page	PO_LINE_CP	View item configuration codes for configured items. The item that you are querying must be defined as a configured item and have configuration codes created for it.
Item/Product Availability Page(inquiry)	ATP_SUMMARY_INV	View the availability of this item. PeopleSoft Inventory must be installed for this link to be active.
PO Line Comments Page	PO_COMMENTS_SEC	Enter comments for a transaction. You can enter a unique comment or select from predefined standard comments.
Maintain Purchase Order - Rebate Agreement ID Look Up Page	VRBT_SEARCH_SP	Search for available vendor rebate agreements.
Category Search Page	CAT_SEARCH_SEC	Search for and select an appropriate category ID for the item when entering an ad hoc item. The search for the category ID is done using a category hierarchy tree.

Page Name	Definition Name	Usage
View Category Hierarchy Page	CAT_PARENTAGE_SEC	View information about where a category resides in the entire catalog tree hierarchy.
<u>Contract Search Page</u>	CNTRCT_SRCH	Search for contracts.
<u>Contract Adjustment Page</u>	CNTRCT_ADJ_SEC	View contract detail information, such as item and/or item description, contract line number or category line number, remaining quantity and remaining line amount.
<u>Contract Price Information Page</u>	CNTRCT_UOMPRCN_SEC	View pricing and unit of measure details for the contract.
<u>Header Misc. Charges (header miscellaneous charges) Page</u>	PO_MISC_WRK	Apply miscellaneous charges that you add on the Header - Miscellaneous Charges page to the lines of the purchase order.
<u>Header - Miscellaneous Charges Page</u>	PO_HDR_MISC	Enter miscellaneous charges that you want to allocate to some or all of the lines on the purchase order using the Maintain Purchase Order - Purchase Order - Miscellaneous page.
Header - 3rd Party supplier Page	PO_HDR_MISC_3RD	Select the third-party supplier pertaining to the miscellaneous charge and specify the amount of the charge.
Exchange Rate Detail Page	EXCH_RT_DTL_INQ	View the rules used to calculate exchange rates for the transaction.

Maintain Purchase Order - Purchase Order Page

Use the Maintain Purchase Order - Purchase Order page (PO_LINE) to enter or change purchase order information online.

Navigation:

Purchasing > Purchase Orders > Add/Update POs > Maintain Purchase Order - Purchase Order

This example illustrates the fields and controls on the Maintain Purchase Order - Purchase Order page(1of2). You can find definitions for the fields and controls later on this page.

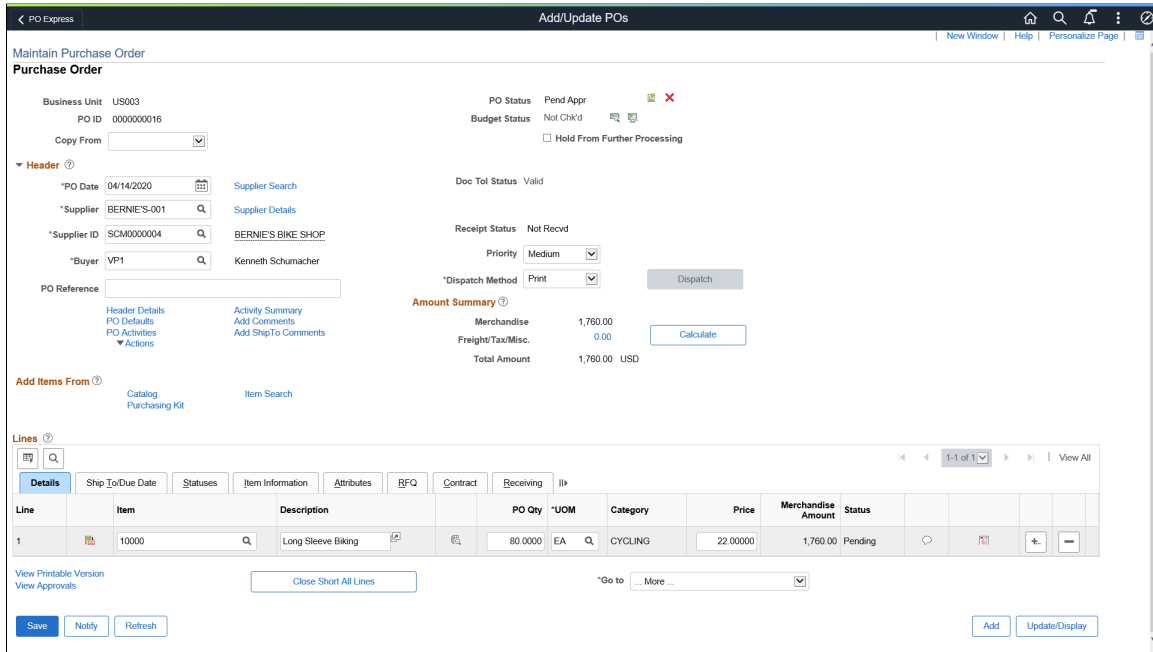



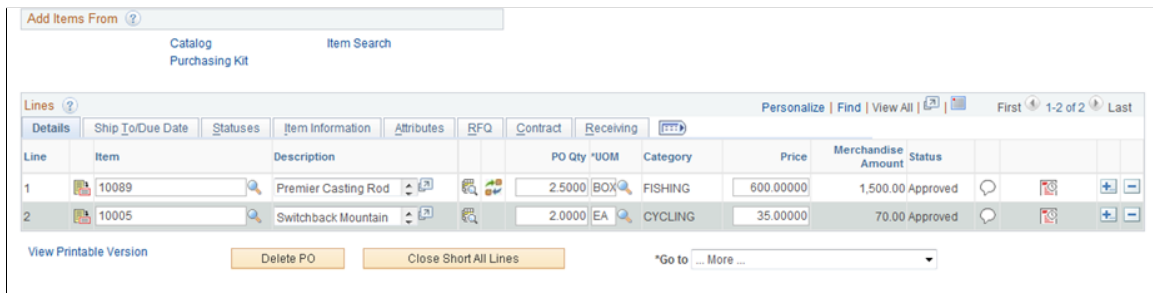

This example illustrates the fields and controls on the Maintain Purchase Order - Purchase Order page(2of2). You can find definitions for the fields and controls later on this page.



Details

Access the Details tab.

Field or Control	Description
	The icon will appear on the Details tab if there is a substitute item in use.
	Click the Line Details button to access the Details for Line page. See Details for Line Page .

Field or Control	Description
	<p>The Part of Line Group button displays when there is a group ID value and at least one of the schedules for the line has an event ID value. The button does not perform an action.</p>
<p>Item</p>	<p>Depending on how you set up PO Item Supplier Security on the Purchasing Definition - Business Unit Options page, the items available may be limited to predefined choices that you established for the selected supplier.</p> <p>When you select an item, the description, category, unit of measure, and price tolerances appear by default.</p> <p>You may also choose to order by description-only when an item is not defined in the system. Enter a description of the item in the Description field, a value in the Category field, and the item price on the Maintain Purchase Orders - Schedule page.</p> <p>Purchase orders can contain standard and stockless items, but you cannot mix them on the same purchase order.</p> <p>This field is not available if the purchase order is used with a recurring purchase order voucher.</p> <p>If you perform one of these actions on a purchase order line that is associated with a PeopleSoft Maintenance Management work order, the system will remove the work order information and the peg to the non-inventory work order:</p> <ul style="list-style-type: none"> • Change a description only or non-inventory item to an inventory item. • Change the category.
	<p>Click the Item Search button to access the Item Search Criteria page where you can define search criteria for items to add to the purchase order.</p>

Field or Control	Description
<p>PO Qty (purchase order quantity)</p>	<p>Enter the quantity of the item that you want to order.</p> <p>If you are using the order multiples functionality, when you enter the purchase order quantity the system will validate the line quantity against the order quantity multiple factor that you specified for this item supplier and unit of measure on the supplier's UOM & Pricing Information page. If the quantity you enter is not a multiple of the order quantity multiple factor, based on the rounding rule, the system will issue a warning message that the item should be ordered in multiples of this factor and it suggests the correct order quantity. You can accept the system suggested quantity at that time or keep the original quantity that you entered.</p> <p>Order quantity multiples are not validated and checked for these information:</p> <ul style="list-style-type: none"> • Non item Supplier UOMs. • Inventory item UOMs. • Adhoc or description only transaction lines. • Purchase orders that have a status of <i>Dispatched</i> or <i>Canceled</i>. <hr/> <p>Note: Order multiple checks are only applicable to item supplier UOMs.</p> <hr/> <p>If the purchase order line built by the PO Calculations (PO_POCALC) and Create Purchase Order (PO_POBUILD) processes references an RFQ and you change the purchase order quantity, the system prompts you asking whether you want to increase or decrease the RFQ order quantity. For example, if you decrease the purchase order quantity from 10 to 5 and want to award the difference to another supplier, choose to decrease the RFQ award quantity. This makes the remaining quantity of 5 available to be awarded to another supplier.</p> <p>If applicable, a similar prompt appears asking whether you want to increase or decrease the requisition line quantity.</p> <p>This field is not available for entry for amount only lines.</p>

Field or Control	Description
UOM (unit of measure)	Select the UOM of the item that you want to use to place the order. This field is not available if the purchase order is used with a recurring purchase order voucher.
Category	Displays the item's category. Category information helps reduce redundant data entry during item setup and requisition and purchase order processing. The purchasing attributes of an item category are assigned as defaults to any item in that category.
Price	Display the price of the item.
Amount	Purchase order quantity multiplied by the unit price. Appears in the transaction currency or the supplier preferred currency. If the line has been designated as an amount-only line on the Line Details page, you can edit this field. This field is not available if the purchase order is used with a recurring purchase order voucher.
Status	Status of the line appears. Values are: <i>Active</i> , <i>Canceled</i> , <i>Hold</i> , or <i>Closed</i> .



Ship To/Due Date

Access the Ship To/Due Date tab.

Field or Control	Description
Due Date	Displays the default due date for the schedule. This is the date the item is due at the ship to location.
Ship To	Displays the business unit to which the item is being shipped.

Statuses

Access the Statuses tab.

Field or Control	Description
Status	Displays the status of the purchase order line.
Backorder Status	Displays the back order status for this line.
	Click the Create Line Change button to make this purchase order line fields available for change. When you click the button, the system makes the fields that are eligible for change available. When you make changes and click Save , the Create Line Change button becomes available again for the saved line.
	Click the Cancel Line button to cancel the purchase order line only. Note: When you select this option the system cancels the associated purchase order line only. This option does not cancel the entire purchase order.

Item Information

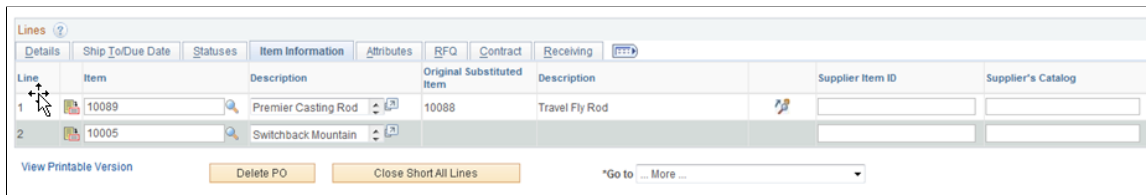

Use the Item Information tab to enter item information such as supplier and manufacturing information.

This example illustrates the fields and controls on the Item Information Page. You can find definitions for the fields and controls later on this page.



The Item Information Tab displays the new item sub fields:

Field or Control	Description
Original Substituted Item	Displays the original Item ID on a procurement transaction that is being substituted. Once an Original Substituted Item is designated for a procurement transaction, it is carried all the way through to the Receipt and cannot be changed. (This is also referred to as only 'Original Item' in some cases where the Item may or may not have been substituted.)

Field or Control	Description
Description	Displays the description associated with the original substituted item
	The icon will appear on the Item Information tab if there is a substitute item available.
	<p>Click the Item Search icon to access the Substitute Item page (SUB_ITM_SRCH), which you can use to view and select all items available to substitute.</p> <p>For Information on Substitute Item Search page Field descriptions See Understanding Item Substitution in Procurement</p>

Attributes

Use the Attributes tab to enter item pricing information.

Field or Control	Description
<p>Procurement Group ID</p>	<p>Select an existing Procurement Group ID for the item (search on partial or full values of the Procurement Group ID, Short Name or Description). When you select a Procurement Group ID, an edit enforces that the Receiving Required option is set. A save-time edit verifies that all items in the Procurement Group ID belong to the same Asset Management Business Unit value when the Allocate Purchasing Group to Assets option is selected on the Purchasing Options page. See Purchasing Options Page See also, Setting Up Procurement Groups</p> <p>At the time a Purchase Order is copied to create a new Purchase Order, the Procurement Group-related fields (Procurement Group ID, Primary Unit, Unit Allocation Quantity and Unit Allocation Amount fields) will be cleared on the new purchase order lines. At the time a Requisition line is copied to a Purchase Order, the Procurement Group-related field values found on the corresponding Requisition line populate the new Purchase Order line. When the Procurement Group ID is being copied from the Requisition to a PO, the Receiving Required field is selected for the PO line.</p> <hr/> <p>Note: When the Allocate Purchasing Group option is in effect, once the composition of a procurement group has been established, it should not be changed. If the composition (items that make up a procurement group) should change, then a new procurement group should be created and utilized instead. Since the Receipt Push process examines all of the purchase order lines and open requisition lines in determining the composition of the procurement group, if you create a new transaction with different items intending that only the new or different items replace those that make up the procurement group, the former items and the new items will be identified later as making up the procurement group. Hence, in the event the composition of a procurement group needs to change (and it is too late to disassociate all former transaction lines in the system from the procurement group), a new procurement group should be created for the new items</p>

Field or Control	Description
Primary Unit	<p>Select this item as the primary unit for the procurement group. If this item has already been designated as primary for the procurement group, then the primary unit check box is automatically selected when the item ID is entered on the transaction line. Only one Item ID (or Description-Only item) can be set as Primary Unit for a procurement group. If you try to select an item (or Description Only item) as the primary unit and one has already been designated for the group, this results in an error message that disallows selection. This edit spans all transactions for Requisitions, Purchase Orders, Receipts and Vouchers.</p> <p>When an Item is Serialized and set as the Primary Unit, the system forces a Unit Allocation Qty = 1. If the Primary Unit flag is selected after Unit Allocation Qty > 1, a message lets you know that the system is resetting the Primary Unit Allocation Qty to 1 because this is a serialized item. When an Item is Non-serialized and the Unit Allocation fields are blank, an error message informs you that the Unit Allocation fields are blank and you need to enter a Unit Allocation Qty or Allocation Amt.</p>
Unit Allocation Qty	<p>Enter a Unit Allocation Quantity if the Amount Only field is deselected. If the Allocate Purchasing Group option is enabled on the Purchasing Options page, the value in this field determines how many asset lines are generated (one asset line per each unit of allocation quantity until the sum totals the receipt line distribution quantity).</p>
Unit Allocation Amt	<p>Enter a Unit Allocation Amount when the Amount Only field is selected. If the Allocate Purchasing Group option is enabled on the Purchasing Options page, the value in this field will determine how many asset lines are generated (one asset line per each unit of allocation amount until the sum totals the receipt line distribution amount)</p>

RFQ

Use the RFQ (request for quote) tab to define a quote ID and line when a purchase order line originated from an RFQ.

Contract

You can use this tab to manually enter purchase order contract lines for line group items and to view contract details for the purchase order.

Field or Control	Description
	<p>Click the Contract Search button to access the Contract Search page, where you can perform advanced searches for contracts.</p> <p>See Contract Search Page.</p>
Contract ID	<p>Displays the contract associated with the corresponding line item.</p>
Contract Version	<p>Select a contract version. Versions enable you to create and maintain multiple versions of the contract in the system and to view information in older contract version. Contracts can only have one current version. The version that appears in this field is the version at the time that it was selected for the purchase order. Versions are only available if the Use Version Control check box is selected on the Contract and supplier Rebate Controls page.</p>
Contract Line	<p>Displays the contract line for this line item.</p>
Category Line Number	<p>Displays the contract line number to which this line item belongs.</p>
Release	<p>Displays the release number for the release. A release is the transaction for the contract. For example, a one-year lease contract with monthly payments would have 12 releases. This field appears for purchase order event types only.</p>
Milestone Line	<p>Identifies the milestone number that is associated with the release line. A milestone is a significant event in the life of a contract.</p>
GPO ID (group purchasing organization ID)	<p>Displays the GPO contract ID associated with the corresponding line item. The ID is a unique alphanumeric code assigned to each group purchasing organization.</p> <p>See Understanding GPO Contracts.</p>
GPO Contract (group purchasing organization contract)	<p>Displays the GPO contract associated with the corresponding line item. The contract is a unique alphanumeric code assigned to each contract from a group purchasing organization.</p>

Field or Control	Description
Group ID	<p>Displays the line group to which this line item belongs. A line group is a bundle of items that buyers use in PeopleSoft Sourcing to obtain better pricing for items. The system populates the Group ID field when:</p> <ul style="list-style-type: none"> • The line is being awarded from PeopleSoft Strategic Sourcing to the purchase order. • Purchase order sourcing selects a contract line that has a group ID assigned to it. <p>The group ID is copied from the contract line to the purchase line.</p> <ul style="list-style-type: none"> • A line group contract line is selected when you create a new purchase order and the group ID is copied from the contract line to the purchase order line. <p>When a purchase order line has a group ID value and the line was awarded by Strategic Sourcing to the purchase order line has a value and at least one of the line's schedules has an event ID, the system displays a warning message if you attempt to cancel the line, change the item ID, UOM, price, quantities, including schedule and distribution quantities that change the displayed quantity.</p> <p>If you select to continue to cancel or change the line, the system cancels the line if the purchase order has been dispatched. The system performs the same process on any other line on the purchase order that has the same group ID value. If the PO has never been dispatched, an error message will be issued to explain the change cannot be made. In this case the other option the user would have is to delete the PO.</p> <p>See “Line Groups” (PeopleSoft Strategic Sourcing).</p>

Field or Control	Description
<p>Rebate ID</p>	<p>Depending on the Rebate ID Security Control setting this field will appear or will be hidden. The approved vendor rebate agreement that matches what is being ordered on the purchase order line appears. You can only modify the vendor rebate agreement if the Rebate ID Security Control Setting field value is <i>Update</i>. Otherwise, you will only be able to view the vendor rebate agreement.</p> <p>In addition, once the purchase order line has a receipt transaction or a vendor rebate accrual transaction associated with it the Rebate ID field will no longer be available for modification. At this time you would use the Backdate Supplier Rebates page to modify the vendor rebate agreement association with the purchase order line.</p> <hr/> <p>Note: Vendor rebate agreements cannot be associated with subcontracting purchase orders generated through PeopleSoft Manufacturing.</p> <hr/>
<p></p>	<p>Depending on the Rebate ID Security Control setting the Look Up Rebate ID button will appear or will be hidden. This button is only active if the Rebate ID Security Control Setting field value is <i>Update</i>. Click this button next to the Rebate ID field to access the Maintain Purchase Order - Rebate Agreement ID Look Up page. Use this page to search for available vendor rebate agreements for what you are ordering on the purchase order.</p>

Receiving

Field or Control	Description
Receiving Required	<p>Select the value that you want to apply for receiving this line item. Values include:</p> <p><i>Do Not Receive:</i> Select to indicate that PeopleSoft Accounts Payable matching and receipt accrual are not applicable. Lines with this value are not eligible for closing short.</p> <p><i>Receiving is Optional:</i> Select to indicate that PeopleSoft Accounts Payable does not match receipt lines and the system does not accrue the receipt.</p> <p><i>Receiving is Required:</i> Select to indicate that PeopleSoft Accounts Payable matches receipt lines and the system accrues the receipt.</p> <hr/> <p>Note: Purchase orders generated from Bill Only requisition type and PeopleSoft Services Procurement work order will always have the Receiving Required field set to <i>Do Not Receive</i>. For Bill and Replace, this flag will be set to <i>Required</i>.</p> <hr/>
Inspection Required	<p>Select to require that this item be inspected upon receipt. When you select the check box, the Inspect ID check box becomes available for entry.</p>
Inspect ID	<p>Select an inspection ID for use with this line item. Inspect IDs contain instruction for inspecting an item. You define the ID using the Inspection Routing page.</p>

Field or Control	Description
Close Short	<p>Select to close short the corresponding purchase order line. Closing purchase order lines short is when you remove the remaining balances on a purchase order and close the order. The system applies the Close Short check box setting from this purchase order line to the receipt line. You can change the value as long as the receipt line has not been processed by the Receipt Push process.</p> <p>When you select this check box, the next time the system runs the Close Short process and all other requirements are met, the system either reduces the quantity of the line's schedule to what has been received or cancels the schedule if there has been no receiving activity.</p> <p>You can select the Close Short check box for a purchase order line if receiving is required for the line. Selecting the check box does not affect the value of the stockless item setting and the replenish code. The system automatically selects the Close Short check box for purchase order lines if the replenish code has a value of stockless. In this case, you cannot deselect the check box manually.</p> <p>You can analyze over due purchase order schedules using the PO Close Short Workbench. Using the workbench, you can also select the Close Short check box on the purchase order line or update the purchase order schedule due date from the workbench.</p> <p>The Online Purchasing PO and Express PO performs the following:</p> <ul style="list-style-type: none"> • You can select the close short flag on PO line only when the close short set option defaults as either “Sum of Receipt Quantity” or “Sum of Receipt Amount” for all the schedules of the PO line. • The close shot flag is grayed, when the PO line is stockless irrespective of the close short set option defaults. • The close short flag is grayed on the PO line for all other close short set option, except for the Sum of Receipt Quantity” or “Sum of Receipt Amount”. • If PO schedules with close short set option other than received quantity or amount is marked for close short on the workbench and applied to PO, when that PO is opened in online panel the close short flag on the particular PO line would be selected, but grayed.

Field or Control	Description
	<ul style="list-style-type: none"> • The close short flag on the PO line is grayed and deselected if the PO schedule has a Spro work order ID, as Spro does not allow changes on the PO. Any changes related to the PO must be coordinated from the SPro Workorder • Any changes made during the session to affect the Graying or Ungraying of the Close Short flag will not be evaluated until Save processing. • The close short flag will be unselected and grayed if there are multiple schedules on a PO and the matching options are different on the schedules.
Custom Fields	<p>The user definable fields in this Custom Fields section are available when you check the Enable Custom Fields checkbox on the Purchasing Installation Options page. You can customize these fields for your use. The custom fields are informational only. .</p> <p>For more information See Understanding User-Definable Fields</p>

Service Work Order

When a work order is attached to a purchase order, this tab is available for you to review and maintain work order details. When a work order is a multi-resource work order, the system creates the purchase order based on the top-line work order. Multi-resource services support a grouping of multiple unique services and service providers for PeopleSoft Services Procurement requisitions, sourcing, and work orders. Each individual service represents a part of the overall multi-resource service. The feature enables you to manage complex work at a more granular level PeopleSoft Services Procurement work orders have only one purchase order line and schedule. You create the purchase orders by running the Quicksourcer batch process.

See:

“Understanding Multi-Resource Services” (PeopleSoft Services Procurement)

“Creating Purchase Orders with the Quick Sourcer” (PeopleSoft Services Procurement)

Field or Control	Description
Work Order ID	<p>Click to access the work order where you can view details about the work order.</p> <p>See “Understanding Services Work Orders” (PeopleSoft Services Procurement).</p>

Field or Control	Description
Service Provider	Displays the service provider. This is the person who has been assigned to perform the service.
Service Coordinator	Displays the service coordinator. This is the person who has been assigned to source requisitions and work orders.

Related Links

[Defining Purchasing Item Categories](#)

[Understanding the UOM Conversion Hierarchy](#)

[“Defining Items at the SetID Level” \(PeopleSoft Managing Items\)](#)

[Purchasing Attributes -Item Supplier \(ITM_VENDOR\)Page](#)

[Supplier's UOM and Pricing Information \(Supplier's unit of measure and pricing information\) Page](#)

[Vendor Rebate Processing on the Purchase Order](#)

Details for Line Page



Use the Details for Line page (PO_LINE_DTLS) to enter additional information for this line, such as contract and supplier item information, item manufacturer information, price calculation parameters, and you can specify whether the item requires receiving and inspection.

Any changes that you make on this page apply only to the selected line.

Navigation:

Click the **Line Details** button associated with a purchase order line on the Maintain Purchase Order - Purchase Order page.

Field or Control	Description
	<p>Click the Chng Line (change line) button to change an attribute on the purchase order line. This button and functionality are available only if the purchase order is in <i>Dispatched</i> status.</p> <p>When you click this button, all fields defined on the PO Chng Ord Template (purchase order change template) page become available for entry and can be changed. If you are using supplier rebate functionality, changing the Rebate ID field will not create a change order.</p> <p>When you save the purchase order, a change order is created. If approval is required before dispatching it to the supplier, the change order must go through the approval process.</p>

Field or Control	Description
	<p>Click the Cancel Line button to cancel the purchase order line. This button is available if the purchase order status is <i>Dispatched</i>. If you cancel a dispatched line, a change order is created.</p> <p>This button is also available when the purchase order status is <i>Approved</i>, but only if the purchase order was previously dispatched and subsequently changed and approved.</p> <p>If you do not have the authority to cancel a purchase order, the Cancel Line button is not available. Set up the authority to cancel a purchase order on the User Preferences - Procurement: Purchase Order Authorizations page.</p>
	<p>Click the Undo Finalize Entire Document button to reverse finalizing the referenced requisitions for this purchase order.</p> <p>The system does not display this button if commitment control is off, or if the purchase order is not sourced from a requisition and thus has no predecessor.</p> <hr/> <p>Note: If you identify a distribution line as final for less, you must run budget checking afterwards.</p> <hr/>
	<p>Click the Finalize Document button to finalize all referenced requisitions for the current purchase order. The system checks all line distributions in the purchase order line for the associated predecessor requisition distributions. If there are multiple purchase orders referenced to the same requisition line distribution, all the other purchase orders must be budget checked successfully before you can finalize the referenced requisition.</p> <p>If the associated requisition has been finalized, you must run the budget processor to liquidate the outstanding pre-encumbrance. Once the requisition is finalized, the distribution line will be locked down, the quantity, amount, ChartFields can't be modified and the open requisition quantity can't be sourced to another purchase order. You can go back to the purchase order to undo the finalization of a requisition that reset the requisition to its original state.</p> <p>If multiple purchase order distribution lines are associated to the same requisition line distributions, the system only allows one line to be finalized.</p> <p>The system does not display this button if commitment control is off, or if the purchase order is not sourced from a requisition and thus has no predecessor.</p>

Line Details

Field or Control	Description
Amount to Receive	<p>Amount that is still open on the purchase order displays.</p> <p>When you change the purchase order quantity or amount by changing the price, the system verifies the distribution method and liquidation methods. If the distribution method is Amount or if the method is Quantity and the liquidation method is Amount, the system does not allow the quantity or amount to be reduced to less than the quantity or amount vouchered.</p> <p>Also when you change the price, the system does not allow you to make changes when there are vouchers matched to the line or schedule. The system provides a message that you should unpost and unmatch the voucher before it allows the change.</p>
Quantity to Receive	<p>Quantity that has not been received and is still open on the purchase order displays.</p>
Line Status	<p>The status of the line appears. Values are: <i>Active</i>, <i>Canceled</i>, or <i>Closed</i>.</p>
Backorder Status	<p>Backorder status displays. Values include:</p> <p><i>None</i>.</p> <p><i>Backorder</i>.</p> <p><i>BO Recv</i> (backorder received).</p>
Doc. Base Amt. (document base amount)	<p>Amount of the line in the purchase order business unit base currency. This amount is used for amount and ChartField approvals, if required.</p>

<i>Field or Control</i>	<i>Description</i>
Group ID	<p>Indicates that this purchase order line item belongs to a line group. A line group is a bundle of items that buyers use in PeopleSoft Strategic Sourcing to obtain better pricing for items.</p> <p>Changes are limited to line group item fields and these fields are grayed out:</p> <p>Item ID.</p> <p>PO Qty (purchase order quantity): This includes changes to the schedule or distribution quantities that affect the quantity value displayed for the line.</p> <p>UOM (unit of measure).</p> <p>PriceThis includes price changes for the line or on one of the schedules for the line.</p> <p>You can cancel a line directly on the line or indirectly by cancelling the schedules for the line.</p> <p>When the purchase order status is Dispatched, or it has been dispatched in the past, the system issues a warning message if you attempt to cancel a line associated to an event line grouping. You can select to continue with the cancellation or not to continue. If you continue, the line item and all other line items in the line group will be cancelled from this purchase order.</p>

Item Information

<i>Field or Control</i>	<i>Description</i>
Supplier's Catalog and Supplier Item ID	Supplier catalog and item ID assigned to the selected item-supplier combination appear. These values appear by default from the Purchasing Attributes - Item Supplier page.
Manufacturer ID	Displays the manufacturer ID.
Manufacturer's Item ID	Select a value that the manufacturer uses to identify the item.
UPN Type	Select applicable UPN Type Code.

Field or Control	Description
<p>UPN ID (Universal Product Number Identifier)</p>	<p>Select applicable universal product number that is defined by a unique combination of item ID, manufacturer ID, manufacturer item ID, and Unit of Measure.</p> <p>On selecting the UPN ID, the item line information associated with the selected UPN ID will be populated.</p> <p>For inventory items, UPN ID is set up on the “Universal Item Identifiers Page” (PeopleSoft Managing Items). If a UPN ID is set up for description-only or punchout items on a contract, search for the contract to apply the correct UPN ID.</p>
<p>Replenish Code</p>	<p>Displays the replenishment code setup for the line item if it is either a replenishment or stockless item. A purchase order can have either stockless or replenishment items only. You cannot have both types on the same purchase order.</p>

Field or Control	Description
Stockless Item	<p>Indicates if the line item is a stockless item. This value is supplied directly from the supplier and is based on a previously established agreement.</p> <p>If the item is defined as a stockless item on the item attribute's Purchasing Controls page, then the system initially displays this field as selected. In this case, you can deselect the field. If the item's stockless attribute is deselected on the Purchasing Controls page, the Stockless Item field is initially deselected, but you can select it. This enables you to order the item as a stockless item or as a stock item. However, you cannot order a stock item as a stockless item when the item is not selected as a stockless item.</p> <p>If a stockless item purchase order line cannot be fulfilled on the first receipt, the remaining quantity on the line is canceled. You can then run the Close Short process to close partially received stockless orders or orders that have not been received within a specified number of days.</p> <p>If approvals are not required for either the Approval Framework or Virtual Approver, the system automatically approves stockless item purchase orders. The orders are approved even if the Create POs in Approved Status option is deselected on the run control. The system ignores the buyer's purchase order creation status in the sourcing programs and only applies the run control value.</p> <p>If approvals are required, the system goes through the stockless item approvals the same as it does for any other type of item where it checks the exception codes to bypass approvals.</p>
Device Tracking	<p>Select this check box to indicate whether a line contains a device-tracked item.</p>
Withholding	<p>Select this check box to indicate that the voucher line that matches this purchase order line may be subject to withholding.</p> <p>Supplier defaults determine whether this option is checked or unchecked.</p>

Attributes

Field or Control	Description
Physical Nature	Select to indicate whether the object is a physical good or service.
Price Qty (price quantity)	<p>Quantity that the system uses to determine minimum order quantities and price adjustment quantities. Select <i>Line</i> or <i>Schedule</i>.</p> <p>If you set up an item-supplier relationship for the purchase order line item, there is a specific price for the item with that supplier, as well as a minimum quantity that you are required to purchase.</p> <p>If you have set up price adjustments for the item and supplier, they may depend on the purchase order quantity.</p>
Price Date	Date that the system uses to determine minimum quantity and price adjustment dates. Select <i>PO</i> (purchase order date) or <i>Due</i> (schedule due date). The price date works in conjunction with the value in the Price Qty field.

Field or Control	Description
Amount Only	<p>Select this check box to designate the line as an amount-only line. If selected, the purchase order quantity value on the line is set to 1 and the field becomes unavailable for entry.</p> <p>The Amount field on the line becomes available for entry. The line amount that you enter becomes the schedule price and amount.</p> <p>If you have an existing purchase order quantity value, line amount, schedule amount, and schedule price, and then select this option, each of these values is reset:</p> <ul style="list-style-type: none"> • The purchase order quantity value is overridden with value of 1. • The line amount, schedule amount, and schedule price are reset to the unit price of the item on the line but can be overridden. <p>If this check box is selected, the system will also determine and populate the Receiving Required field value for the purchase order line. The system will look first at the Default Amount Only PO to "Do Not Receive" check box setting you specify on the Purchasing Options page associated with the business unit. If that check box is selected, the system will populate the Receiving Required field with <i>Do Not</i> (do not receive). If that check box is clear, the system will then look at the item and then the item category to determine the Receiving Required field value for the purchase order line. Plus, the Inspection Required field will not be available for entry.</p> <p>This field is not available if the purchase order is used with a recurring purchase order voucher.</p>
Procurement Group ID	<p>Enter a procurement group ID to include this line in a procurement group. A procurement group gathers a group of line items on a requisition, purchase order, or receipt to help organize a larger item. For example, the Procurement Groups feature can be used in combination with PeopleSoft Asset Management to collect all item IDs that belong to a larger asset such as an air conditioning unit.</p> <p>See Understanding Procurement Groups in PeopleSoft</p>

Field or Control	Description
Primary Unit	Select this check box to choose this line item as the main item for an item-grouping in a procurement group; for example, an air conditioning unit could be the primary unit in a procurement group to create a complete asset. In order to use this check box, you must enter a value in the Procurement Group ID field on this page. If a primary unit item ID has already been selected on the Procurement Groups page then this field cannot change the primary unit.
Unit Allocation Qty	Enter the quantity of this item needed to complete a primary unit in a procurement group; for example, four brackets per air conditioning unit. If this page is for the primary unit item and it is serial-controlled then this quantity is restricted to one. This field is only available if you have not selected the Amount Only check box. It is utilized during receiving and asset integration.
Unit Allocation Amt	Enter the amount or price of this item needed to complete a primary unit in a procurement group; for example, 500 USD of installation services per air conditioning unit. This field is only available for amount-only transactions lines that have selected the Amount Only check box. It is utilized during receiving and asset integration.

RFQ

Field or Control	Description
RFQ ID (request for quote ID)	Appears if the purchase order line originated from an RFQ.

Contract

Field or Control	Description
	<p>Click the Contract Search button to access the Contract Search page where you can search for specific contracts. The system searches for active, effective contracts based on the search criteria that you enter and displays the results with the most recent contract first.</p> <p>You can also search based on the contract style</p> <p>See“Contract Style page” (PeopleSoft Source to Settle Common Information)</p> <p>When you select a contract, the system uses that contract reference for the requisition or purchase order. The price and other fields are not used. If you select a line item contract reference, the system uses the item ID for the requisition or purchase order in addition to the contract reference.</p> <p>If you enter an item ID before invoking the search page that item is used by the Search page, so that the search is limited to that item. If you leave item ID blank before invoking the search page, then the system includes all items for the category in the search.</p>
SetID	<p>Displays the SetID in which this purchase order was created. The SetID controls several contract features available for purchase orders.</p>

Field or Control	Description
Contract ID and Contract Line	<p>To associate a contract with this purchase order line, enter a contract ID and line number (for fixed-item contracts only) or category line number. If the contract is an open item contract, no line number or category line number reference is applicable. This brings information into the purchase order from the contract.</p> <p>You can enter a contract after selecting the item ID, or select a contract and line number, which copies the contract line information onto the purchase order line.</p> <p>The contract ID and line number or category line number are not available if the purchase order is used with a recurring purchase order voucher.</p> <p>If this purchase order is created for either a contract assigned to this specific purchase order (enhanced blanket purchase order) or a recurring purchase order voucher, the contract ID, line number and category line number are display only.</p> <p>Contracts may be used on a purchase order if:</p> <ul style="list-style-type: none"> • The contract status is approved and contract version status is current. • The contract supplier matches the purchase order supplier. • The contract is not expired and the begin and expire dates fall within the purchase order (header) date. <p>The minimum and maximum amounts and quantity on the contract are not exceeded.</p> <p>See “Understanding Voucher and Order Contracts” (PeopleSoft Source to Settle Common Information).</p>
Contract Version	<p>Displays the contract version when you are using version control. Contract versions enable contract administrators to create and maintain multiple versions of a contract in the procurement system. If the SetID in which this purchase order exists does not use version control, this field is not available.</p>
Category Line	<p>Select a contract category line number to indicate that the purchase order line is associated to a category on the contract. If there are any contract category price adjustments associated with the contract, the system reflects the adjustment on the purchase order line.</p>

Field or Control	Description
Release	<p>Contract release number. When you associate a contract with a purchase order line on this page, the purchase order line becomes a contract release. If the line is the first release to the contract, the release number is set to <i>NEXT</i>. When you save the purchase order, the system assigns the next available release number to the line and creates a contract event. This release number is calculated by incrementing by 1 from the last used release number.</p> <p>The contract ID, contract line number, and release number are joined to give you and the system enough information to tie the contract release to one specific purchase order and to view it in the Contract Events inquiry.</p>
Milestone Line	<p>Displays the contract line on which a milestone applies. Milestones are points in a contract cycle, such as a specified period of time or a percentage of contract fulfillment, at which an approval or reevaluation is made by contract participants.</p>
GPO ID (group purchasing organization ID)	<p>Group purchasing organization identifier.</p>
GPO Contract (group purchasing organization contract)	<p>Group purchasing organization contract number. Appears if the item selected is associated with a GPO contract.</p>
Group ID	<p>Displays the group ID to which this item belongs. When a PeopleSoft Strategic Sourcing event is awarded to a purchase order, and the event contains a group ID, that group ID appears in this field. If an item is awarded as part of a line group, the line group price applies when the item is ordered from that supplier.</p> <p>When a contract that has a group ID assigned to it is copied to the purchase order line, that group ID appears on the purchase order line. You can associate the contract reference manually or select to use the automatic search functionality by selecting the Default Contract on PO check box for the business unit. Or, you can select the <i>Contract</i> value in the Copy From field on the purchase order header.</p> <hr/> <p>Note: When a purchase order line has a group ID value and the line was awarded by PeopleSoft Strategic Sourcing to the purchase order and that line has a value and at least one of the line's schedules has an event ID, changes to the purchase order are limited after you dispatch the purchase order.</p> <hr/>

Field or Control	Description
Rebate ID	<p>Depending on the Rebate ID Security Control setting this field will appear or will be hidden. The approved vendor rebate agreement that matches what is being ordered on the purchase order line appears. You can only modify the vendor rebate agreement if the Rebate ID Security Control Setting field value is <i>Update</i>. Otherwise, you will only be able to view the vendor rebate agreement.</p> <p>In addition, once the purchase order line has a receipt transaction or a vendor rebate accrual transaction associated with it the Rebate ID field will no longer be available for modification. At this time you would use the Backdate Supplier Rebates page to modify the vendor rebate agreement association with the purchase order line.</p> <hr/> <p>Note: Vendor rebate agreements cannot be associated with subcontracting purchase orders generated through PeopleSoft Manufacturing.</p> <hr/>
Procurement Group ID	<p>Enter a procurement group ID to include this line in a procurement group. A procurement group gathers a group of line items on a requisition, purchase order, or receipt to help organize a larger item. For example, the Procurement Groups feature can be used in combination with PeopleSoft Asset Management to collect all item IDs that belong to a larger asset such as an air conditioning unit.</p> <p>See Understanding Procurement Groups in PeopleSoft</p>
Primary Unit	<p>Select this check box to choose this line item as the main item for an item-grouping in a procurement group; for example, an air conditioning unit could be the primary unit in a procurement group to create a complete asset. In order to use this check box, you must enter a value in the Procurement Group ID field on this page. If a primary unit item ID has already been selected on the Procurement Groups page then this field cannot change the primary unit.</p>
Unit Allocation Qty	<p>Enter the quantity of this item needed to complete a primary unit in a procurement group; for example, four brackets per air conditioning unit. If this page is for the primary unit item and it is serial-controlled then this quantity is restricted to one. This field is only available if you have not selected the Amount Only check box. It is utilized during receiving and asset integration.</p>

Field or Control	Description
Unit Allocation Amt	Enter the amount or price of this item needed to complete a primary unit in a procurement group; for example, 500 USD of installation services per air conditioning unit. This field is only available for amount-only transactions lines that have selected the Amount Only check box. It is utilized during receiving and asset integration.
	Depending on the Rebate ID Security Control setting this Look Up Rebate ID button will appear or will be hidden. This button is only active if the Rebate ID Security Control Setting field value is <i>Update</i> . Click this button next to the Rebate ID field to access the Maintain Purchase Order - Rebate Agreement ID Look Up page. Use this page to search for available vendor rebate agreements for what you are ordering on the purchase order.

Receiving

Field or Control	Description
Receiving Required	<p>Select the line item receiving requirement. Values are:</p> <ul style="list-style-type: none"> • <i>Do Not</i> (do not receive). • <i>Optional</i> (receiving is optional). • <i>Required</i> (receiving is required). <p>The system will default this field for you. This field will be set to <i>Do Not</i> on amount only lines, when the Default Amount Only PO to "Do Not Receive" check box is selected on the Purchasing Options page. If that check box is clear, or if it is not an amount only line, the system will look at the item and then the item category to determine the Receiving Required field value for the purchase order line.</p> <hr/> <p>Note: Purchase orders generated from Bill Only requisition type and PeopleSoft Services Procurement work order will always have the Receiving Required field set to <i>Do Not Receive</i>. For Bill and Replace, this flag will be set to <i>Required</i>.</p>

Field or Control	Description
Inspection Required	Select to indicate that inspection is required for the line item. If selected, enter an inspection routing ID for the item. <hr/> Note: Inspection Required cannot be selected for amount only lines. <hr/>

Related Links

[Purchasing Options Page](#)

[Creating and Viewing Purchase Order Backorders](#)

[Maintain Purchase Order - Purchase Order Page](#)

[Understanding GPO Contracts](#)

“Using Universal Item Identifiers” (PeopleSoft Managing Items)

“Using Device Tracking” (PeopleSoft Managing Items)

Contract Search Page

Use the Contract Search page (CNTRCT_SRCH) to search for contracts.

Navigation:

Click the **Contract Search** button on the Maintain Purchase Order page.

This example illustrates the fields and controls on the Contract Search Page. You can find definitions for the fields and controls later on this page.

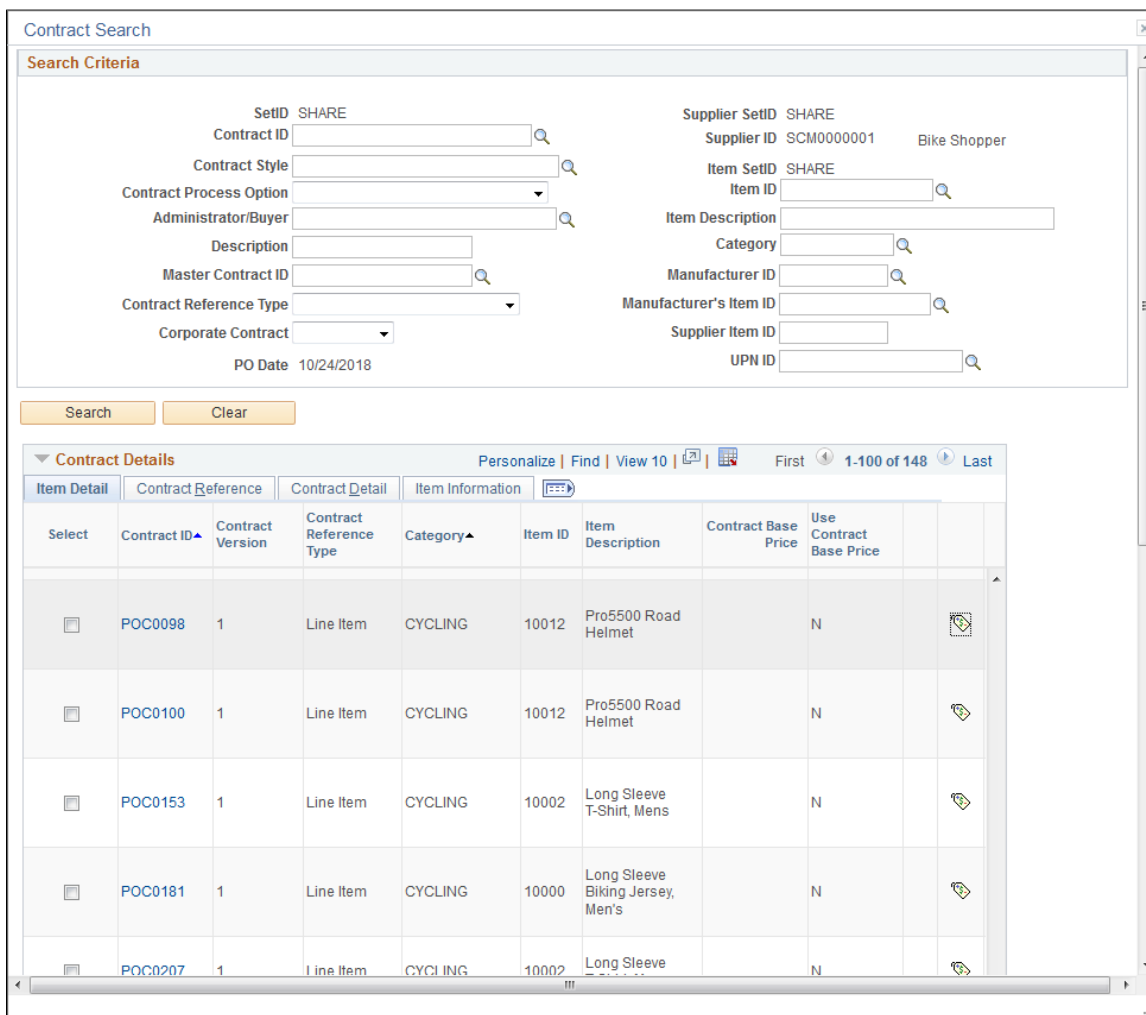

Use this page to find a contract and use its prices to populate purchase order values. The system automatically applies the contract price to the purchase order.

You can search for individual contracts by contract ID or limit the search to only those contracts for a specific contract process option. You can also search for manufacturer contracts—the system uses the Supplier ID you specify to search against the distributor contract supplier.

After you define contract search criteria, click the **Search** button. The system searches for active, effective contracts based on the search criteria that you entered and displays the results with the most recent contract first. For Ad Hoc Contract Lines based on Item Identification, Multiple Item Identifying criteria may be entered (or transferred from the transaction line), in which case Contract Lines with partial matching identifiers are retrieved. If you are using contract usage options to control which business unit, contract domain, or ship to location can be used with a contract, the system returns only those contracts with valid contract control values. The system populates the Contract Details grid with the results and includes these tabs:

- Item Detail
- Contract Reference

- Contract Detail
- Item Information



The tabs help you to identify the correct contract to select if there are multiples.

Click the **Clear** button to remove search criteria.

Field or Control	Description
Contract Style	Select a contract style. Values for contract style are user-defined using the “Contract Style page” (PeopleSoft Source to Settle Common Information).
Administrator/Buyer	Select an administrator or buyer related to the contract.
Master Contract ID	Select a master contract ID. Master contracts are groupings of several contracts for the same supplier and then tracked using one master contract ID.
Contract Reference Type	Select a reference type on which to base a search. A contract reference type indicates the source of item information contained in a contract. When you select items, the reference type is also included on the purchase order. Reference types include: <i>Cat Cntrct</i> (category contract): Searches for contract category lines that you can add to the purchase order. <i>Line Item</i> : Searches for contract line items. The search results will contain line item types that meet other criteria that you define. <i>Open Item</i> : Searches for items that are specified on the contract to be purchased against it.
Manufacturer ID	Enter a manufacturer related to the contract.
Manufacturer’s Item ID	Enter a manufacturer item related to the contract.
Supplier Item ID	Enter a supplier related to the contract.
UPN ID (Universal Product Number ID)	Enter a universal product number related to the contract.

Item Detail

To apply the contract item price to the purchase order price, select a value from the returned search and click the OK button. The system overrides the item, item description, contract ID, contract line, and contract version using the contract row of data that you select.

Field or Control	Description
Contract ID	Click to access the Maintain Procurement Contract page. You can use the page to view and update the contract. See “Understanding Voucher and Order Contracts” (PeopleSoft Source to Settle Common Information).
	Click the Contract Adjustment icon to access the Contract Adjustments page.
	Click the Unit of Measure Pricing icon to access the Contract Price Information page, where you can view pricing and unit of measure details for the contract.

Contract Reference

This tab provides supplementary details about the contract.

Contract Details

This tab provides details about the contract, such as the Contract Style selected, the begin date of the contract, and the type of Punchout Pricing option selected for a contract.

Item Information

This tab provides details about supplier and manufacturer items for the contract, such as manufacturer item ID, supplier item ID, and default universal product number from the contract line.

Contract Adjustment Page

Use the Contract Adjustment (CNTRCT_ADJ_SEC) page to view contract detail information, such as item and/or item description, contract line number or category line number, remaining quantity and remaining line amount. Remaining Amounts are calculated if a maximum quantity or maximum amount has defined on the contract.

Navigation:

Click the Contract Adjustment icon on the Contract Search page.

This example illustrates the fields and controls on the Contract Adjustment Page.

Contract Adjustments

Contract ID 000000000000000000000000000044 Contract Version 1
 Contract Line Nbr 1
 Item ID 10030 Folding Child Trailer
 Remaining Line Amount 0.000 USD
 Remaining Quantity 0.0000
 Calculation Method Sum All Adjustments
 Qty Type Current Order Quantity

Adjustment Details Personalize | Find | View All | [Print] [Refresh] First 1-3 of 3 Last

Sequence	Minimum Quantity	Maximum Quantity	Method	Percentage	Contract Price	Currency
1	2.0000	4.0000	Percentage	-5.0000	82.65000	USD
1	5.0000	9.0000	Percentage	-7.5000	80.47500	USD
1	10.0000	99999999.9999	Percentage	-10.0000	78.30000	USD

Return

Contract Price Information Page

Use the Contract Price Information (CNTRCT_UOMPRCN_SEC) page to view pricing and unit of measure details for the contract.

Navigation:

Click the Unit of Measure Pricing icon on the Contract Search page.

This example illustrates the fields and controls on the Contract Price Information page.

Contract Price Information

Contract ID POC0098 Supplier ID SCM0000001
 Contract Version 1 Supplier Name Bike Shopper
 Contract Line Nbr 1

Pricing Information

Use Contract Base Price Use Supp Price UOM Adjustments
 Price Can Be Changed on Order Use Supplier Price Shipto Adj
 Price Date PO Date Adjust Before Contract Adjustments
 Price Qty Line Quantity **Order By Amount**
 Amount Only
 Qty Type Current Order Quantity Merchandise Amount 20.00

UOM/Pricing Personalize | Find | View All | [Print] [Refresh] First 1 of 1 Last

Default UOM	UPN ID	UPN Type Code	Price Loc	UOM	Contract Base Price	Curr
<input checked="" type="checkbox"/>			MAIN	EA	29.50000	USD

Return

Header Misc. Charges (header miscellaneous charges) Page

Use the Header Misc. Charges (header miscellaneous charges) page (PO_MISC_WRK) to apply miscellaneous charges that you add on the Header - Miscellaneous Charges page to the lines of the purchase order.

Navigation:

Select *13 - Header Misc. Charges* in the **Go to** field on the Maintain Purchase Order - Purchase Order page.

All Charges

The **All Charges** group box displays information about the miscellaneous charges selected on the Header Miscellaneous Charges page.

The actions of these three items apply to the single miscellaneous charge that appears in the **All Charges** group box.

<i>Field or Control</i>	<i>Description</i>
Select All	Click this link to select all purchase order lines for allocation of the miscellaneous charge that appear in the All Charges group box.
Clear All	Click this link to clear the selection of all purchase order lines for the allocation of the miscellaneous charge that appears in the All Charges group box.
Allocate	Click this button to calculate charges to the selected purchase order lines for the miscellaneous charge that appears in the All Charges group box.

Current Charge

Use the **Current Charge** group box to allocate the selected miscellaneous charges to specific purchase order lines. Select the check box for lines to which you want to apply miscellaneous charges.

<i>Field or Control</i>	<i>Description</i>
Amount	Miscellaneous charge amount allocated to the purchase order line. The amount is populated based on the amounts of miscellaneous charges selected on the Header - Miscellaneous Charges page when you click the Misc Calculation buttons.

Related Links

[Header Misc. Charges \(header miscellaneous charges\) Page](#)

“Misc Charge/Landed Cost Defn Page” (PeopleSoft Source to Settle Common Information)

Header - Miscellaneous Charges Page

Use the Header - Miscellaneous Charges page (PO_HDR_MISC) to enter miscellaneous charges that you want to allocate to some or all of the lines on the purchase order using the Maintain Purchase Order - Purchase Order - Miscellaneous page.

Navigation:

Click the **Miscellaneous Charges** link on the Header Misc. Charges page.

<i>Field or Control</i>	<i>Description</i>
Template ID	Select the template of miscellaneous charges to apply to purchase order lines. Set up the templates on the Misc Chg/Landed Cost Template page (miscellaneous charge/landed cost template page). If you select a template, the grid is populated with the charges from the template. You can add or delete charges.

Related Links

[Header Misc. Charges \(header miscellaneous charges\) Page](#)

“Misc Charge/Landed Cost Defn Page” (PeopleSoft Source to Settle Common Information)

“Misc Charge/Landed Cost Defn Page” (PeopleSoft Source to Settle Common Information)

Creating Purchase Order Schedules

This section discusses how to Create Purchase Order Schedules:

Pages Used to Create Purchase Order Schedules

<i>Page Name</i>	<i>Definition Name</i>	<i>Usage</i>
Maintain Purchase Order - Schedules Page	PO_SCHEDULE	Specify ship to, quantities, due dates, comments, SUT, miscellaneous charges, price adjustments, and multiple distributions per schedule within a purchase order line.
Item Description Page	PO_ITEM_DESCR, PO_ITEM_DESCR2	Enter and view descriptions for a specific item. The item description link includes the first 30 characters of the item's description in the Transaction Item Description text box on the Item Description page.

Page Name	Definition Name	Usage
Details for Schedule Page	PO_SCHED_DTLS	Review or add schedule details to the selected schedule line.
<u>PO ShipTo Address Page</u>	PO_ONE_TIME_ADDR	Set up a one-time ship to address for the selected purchase order schedule. You cannot define a one-time address for direct shipment purchase orders. To change the address for a direct shipment you must go to the sales order in PeopleSoft Order Management and make the address change there.
Price Adjustments for Schedule Page	PO_VAL_ADJ	Adjust the price of a schedule.
Miscellaneous Charges for Schedule Page	PO_SCHED_MISC	Change miscellaneous charges on this schedule.
<u>Schedule - 3rd Party Supplier Page</u>	PO_SCHED_MISC_3RD	Select a third-party supplier to whom to pay the miscellaneous charge.
Sales/Use Tax Information for Schedule Page	PO_SCHED_SUT	Enter the SUT information for the schedule.
<u>VAT Information for a Schedule Page</u>	PO_SCHED_VAT	Review and update VAT details for this schedule. This page is accessible only if the General Ledger business unit on the Purchasing business unit links to a valid VAT entity.
Direct Shipment Page	PO_SCHED_OM	View sales order information about a drop-shipment purchase order. The purchase order must have a direct shipment. Drop-ship orders are not eligible for receiving in PeopleSoft Purchasing, because they are normally sent directly to a customer site and received there.
PO ShipTo Comments Page	PO_COMMENTS_SEC	Enter comments for a transaction. You can enter a unique comment, or you can select from predefined standard comments.
<u>Pegging Workbench Page</u>	IN_PEG_DETAIL_SP	Apply, change, or remove pegs from items.
<u>Pegging Inquiry Page</u>	IN_PEG_DETAIL_SP	View pegging information for line items.

Page Name	Definition Name	Usage
Qualified Distributions page	PO_DIST_PEG	Select the purchase order distribution that you want to maintain or view the pegging information for.

Maintain Purchase Order - Schedules Page

Use the Maintain Purchase Order - Schedules page (PO_SCHEDULE) to specify ship to, quantities, due dates, comments, SUT, miscellaneous charges, price adjustments, and multiple distributions per schedule within a purchase order line.



Navigation:

Purchasing > Purchase Orders > Add/Update POs > Maintain Purchase Order - Purchase Order

Click the **Schedule** button next to a purchase order line on the Maintain Purchase Order - Purchase Order page.

This example illustrates the fields and controls on the Maintain Purchase Orders - Schedules page. You can find definitions for the fields and controls later on this page.

The Schedules page displays header information for the purchase order, such as the purchase order ID, date, and status. The page also displays schedule details for purchase order lines. The Lines group box provides basic information about individual lines and the Schedules grid box provides detailed schedule information.

Field or Control	Description
	<p>Click the Finalize Document button to finalize all referenced requisitions for the current purchase order. The system verifies that all line distributions in the purchase order schedule have the associated predecessor requisition distributions. If the associated requisition has been finalized, the system de-associates the requisition from the purchase order before running budget checking to avoid over liquidating the pre-encumbrance.</p> <p>If multiple purchase order schedules are associated to the same requisition schedule, the entire requisition schedule may be finalized from any of the related purchase order schedules.</p> <p>The system does not display this button if commitment control is off or if the purchase order is not sourced from a requisition, and thus has no predecessor.</p>
	<p>Click the Undo Finalize Entire Document button to reverse finalizing the referenced requisitions for this purchase order.</p> <p>The system does not display this button if commitment control is off or if the purchase order is not sourced from a requisition, and thus has no predecessor.</p> <hr/> <p>Note: If you identify a distribution line as final for less, you must run budget checking afterwards.</p> <hr/>



Note: If a schedule is a PeopleSoft Order Management direct shipment, the system displays a warning when you change, delete, or cancel the schedule. Changes that you make to schedules here that are related to PeopleSoft Order Management do not update the related information in the PeopleSoft Order Management application. You can tell if you have a direct shipment, because the **Schedule Direct Shipment** button appears on the Maintain Purchase Order - Schedules page, instead of a **ShipTo Address** button.

Field or Control	Description
PO Status	Current status of the entire purchase order. Valid status values are <i>Initial, Open, Pending Approval, Approved, Dispatched, Canceled, and Complete.</i>
Description	Click the Item Description link to view a description of the item. The link displays in the Lines group box next to the item ID.
Add Ship To Address Comments	Click to access the PO ShipTo Comments page.





Details

Use the **Schedules** grid box to view and maintain a variety of schedule information for purchase order lines that appear in the grid box. The Details tab enables you to define basic schedule information for the purchase order line.





Field or Control	Description
Sched (schedule)	Displays the schedule number used by the system to track multiple schedules for a purchase order line. The system automatically assigns the number.
	<p>Click the Details button to access the Details page where you can view or maintain schedule details.</p> <p>See Details for Schedule Page.</p>
Due Date	<p>Displays the default due date for the schedule. If there is no default due date, the system calculates one by adding the lead-time days to the purchase order date. You can override the due date for each schedule as long as it is not earlier than the purchase order date.</p> <p>If the item is an inventory item and an Inventory business unit is entered on the first distribution line of the schedule on the Distribution Details page, the due date is validated against the closure calendar definition for the PeopleSoft Inventory business unit. This ensures that the business unit is open to receive merchandise on that day. If the date is not a valid date for that business unit, the system issues a warning for you to accept the date anyway or use the next available date.</p> <p>If the item is not an inventory item, the shipping due date is validated against the closure calendar definition for the PeopleSoft Purchasing business unit.</p> <p>When you create a change order by adding a line to the purchase order on a purchase order that has a due date in the past, the system will populate the due date for the new line with the current date plus lead time days, if a lead time exists for the category. Otherwise, the current date will appear in the Due Date field.</p> <p>When the purchase order is created using the copy from purchase order method, the due date is calculated again. If the resulting calculated date is greater than the due date copied from the copied purchase order, then the calculated date is set as the due date for the new purchase order. If the calculated date is less than the copied due date, the copied due date is retained as the due date in the new purchase order.</p>

Field or Control	Description
	<p>Click the Schedule Direct Shipment button to access the Direct Shipment page. Use the Direct Shipment page to view PeopleSoft Order Management sales order information related to the direct shipment.</p>
Ship To	<p>Ship to destination. A change to the ship to can result in a price change, a sales and use tax recalculation, or a VAT recalculation.</p>
Ship To GLM (ship to global location number)	<p>Displays the global location number for the corresponding ship to location, if available.</p>
	<p>Click the Ship To Address button to access the PO ShipTo Address page. Use this page to set up a one-time ship to address for the selected purchase order schedule.</p> <hr/> <p>Note: You cannot define a one-time address for direct shipment purchase orders. To change the address for a direct shipment you must go to the sales order in PeopleSoft Order Management and make the address change there.</p> <hr/>

Field or Control	Description
<p>PO Quantity</p>	<p>The purchase order quantity for the first schedule automatically changes to the entire line quantity. You can override the quantity with a lower number and insert a second schedule for the difference.</p> <p>The purchase order quantity for the second schedule automatically changes to the difference between the line quantity and the quantity on the first schedule.</p> <p>If you update the line quantity and have only one schedule, the system updates the schedule automatically. If you have multiple schedules, you must update the schedules manually so that the total schedule quantity equals the line quantity.</p> <p>Changing the schedule quantity never updates the line quantity. This field is not available for entry for amount only lines.</p> <p>When you change the purchase order quantity or amount by changing the price, the system verifies the distribution method and liquidation methods. If the distribution method is Amount or if the method is Quantity and the liquidation method is Amount, the system does not allow the quantity or amount to be reduced to less than the quantity or amount vouchered. Also when you change the price, the system does not allow you to make changes when there are vouchers matched to the line or schedule. The system provides a message that you should unpost and unmatched the voucher before it allows the change.</p>
<p>Price</p>	<p>The system calculates the price for the items.</p> <p>Price calculations can range from simple to complex, depending on the factors you set up.</p> <p>If there is a contract associated with the line, the system uses the contract rules to determine the price. Contract rules include whether to use the contract base price or the supplier price for the unit of measure on the purchase order. Contract rules also determine which sets of price adjustments the system considers (contract price adjustments and supplier base price adjustments) and in what order.</p> <p>If you are ordering items by description only, you must enter the price manually. While price is not required, if you have entered schedules without prices, you'll get a warning when you save the purchase order.</p> <p>This field is not available if the purchase order is used with a recurring purchase order voucher.</p>

Field or Control	Description
Amount	<p>The system calculates the extended amount as the schedule price multiplied by the schedule quantity. This is the merchandise amount of the schedule. It does not include other amounts associated with the schedule, such as freight and tax.</p> <p>You can override the schedule merchandise amount here, unless the item definition or contract definition for the item on the line does not allow the price to be changed on the purchase order.</p> <p>This field is not available if the purchase order is used with a recurring purchase order voucher.</p> <p>When you change the purchase order quantity or amount by changing the price, the system verifies the distribution method and liquidation methods. If the distribution method is Amount or if the method is Quantity and the liquidation method is Amount, the system does not allow the quantity or amount to be reduced to less than the quantity or amount vouchered. Also when you change the price, the system does not allow you to make changes when there are vouchers matched to the line or schedule. The system provides a message that you should unpost and unmatch the voucher before it allows the change.</p>
Status	Displays the status of the purchase order line schedule.
	<p>Click the Value Adjustment button to access the Price Adjustments page.</p> <p>See Price Adjustments for Schedule Page.</p>
	<p>Click the Miscellaneous Charges button to access the Miscellaneous Charges page where you can view and update price information.</p> <p>See Miscellaneous Charges for Schedule Page.</p>
	<p>Click the Sched Sales/Use Tax button to access the Sales/Use Tax Information page.</p> <p>See Sales/Use Tax Information for Schedule Page, Sales/Use Tax Information for Schedule Page.</p>
	<p>Click the Distributions/ChartFields button to access the Distributions page.</p> <p>See Creating Purchase Order Distributions.</p>

Statutes

Field or Control	Description
	<p>Click the Create Schedule Change button to change an attribute on the purchase order schedule. This button and functionality are available only if the purchase order is in <i>Dispatched</i> status.</p> <p>When you click this button, all fields defined on the Chng Ord Template (purchase order change template) page become available for entry and can be changed.</p> <p>When you save the purchase order, a change order is created. If approval is required before dispatching it to the supplier, the change order must go through the approval process.</p>
	<p>Click the Cancel Schedule button to cancel the purchase order schedule. This button is available if the purchase order status is <i>Dispatched</i>. If you cancel a dispatched schedule, a change order is created.</p> <p>This button is also available when the purchase order status is <i>Approved</i>, but only if the purchase order was previously dispatched and subsequently changed and approved.</p> <p>To cancel the schedule, you must have the authority to cancel purchase orders on the User Preferences - Procurement: Purchase Order Authorizations page.</p>
	<p>Click the Pegging Workbench button to access the Pegging Workbench page. Use this page to view and maintain the pegging information associated with this purchase order schedule.</p> <p>See Using Pegging with Requisitions in PeopleSoft Purchasing.</p> <p>See “Understanding Pegging” (PeopleSoft Supply Chain Management Common Information).</p>
	<p>Click the Pegging Inquiry button to access the Pegging Inquiry page. Use this page to view the demand for this purchase order.</p> <p>See Using Pegging with Requisitions in PeopleSoft Purchasing.</p> <p>See “Understanding Pegging” (PeopleSoft Supply Chain Management Common Information).</p>

Shipment

Use this tab to define purchase order line shipping details. This information is similar to fields used for the purchase order header. Refer to those fields for additional descriptions.

Field or Control	Description
Attention To	Displays the person to whom, or place to where the services or goods are to be delivered. If the purchase order's scheduled shipment originated from the requisition, the Attention To field value is carried onto the purchase order. When the purchase order schedule is manually entered, this field will be blank. This field value is <i>Multiple Recipients</i> if there are more than one person or place that this shipment is to be distributed to.
Revision	Displays the manufacturer's product revision number of the item ordered. If the ship to is a PeopleSoft Inventory business unit and the item is under revision control in that business unit, the revision number defaults to that revision number effective on the due date.
Time Due	Displays the time that the shipment is due.
Original Promise Date	Displays the date on which the supplier originally committed to deliver the item. The default due date appears by default in this field and is updated when the item or item category (ad hoc items) changes. If you override the due date on the PO Defaults page, the purchase order date plus the number of lead time days defined for the item or item category (ad hoc items) will be used, not the overridden due date. You can override the original promise date on the PO Defaults page.
Ship Date	Displays the actual date on which the line item was shipped by the supplier.
Custom Price	Select this check box to indicate that you entered a custom price on the schedule.
Zero Price	Select to indicate that the price for this item is zero.
Frozen (Planning)	Select to prevent PeopleSoft Supply Planning from changing the schedule. The two schedule changes that PeopleSoft Supply Planning can recommend include rescheduling the due date to ensure supply is on hand for a particular demand and canceling the schedule if demand does not exist.

Field or Control	Description
Ship Via	Displays the ship via code for a carrier or method of shipment. You define ship via codes for SetID using the Purchasing Options page.

Matching

Use the Matching tab to view and maintain default price tolerances for the PeopleSoft Payables Matching process (AP_MATCH) that matches purchase orders, receipts, and vouchers to verify supplier charges. If you do not specify tolerance values for the business unit, the system uses tolerance values defined for the item's purchasing attributes.

Field or Control	Description
Match Status	Displays the match status for this purchase order line.
Matching	Select a method for matching and verifying supplier charges at the line level. Methods include: <i>ERS</i> (evaluated receipt settlement): Select to indicate that the system matches the line based on the purchase order header match control. <i>Full Match</i> : Select to indicate that the system does not match the line. <i>No Match</i> : Select to indicate that the system matches the line.
Price Tolerance Over and Price Tolerance Under	Enter the amount over or under the individual item price that you plan to allow on the voucher and still have the transaction qualify for a match.
% Unit Price Tolerance Over (percent unit price tolerance over) and % Unit Price Tolerance Under (percent unit price tolerance under)	Enter a percentage amount over or under the individual price that you plan to allow on the voucher and still have the transaction qualify for a match.
Ext Price Tolerance (extended price tolerance) Ext Price Tolerance - Under (extended price tolerance - under) % Ext Price Tolerance % Ext Price Tolerance - Under	Enter the amounts or percentages over or under the extended item price (price multiplied by quantity) that you plan to allow on the voucher and still have the transaction qualify for a match.

Receiving

Use the Receiving tab to view and maintain receiving information.

Field or Control	Description
Reject Qty Over Tolerance (reject quantity over tolerance)	Select to reject a shipment at receiving time if the quantity received is over the tolerance set in the Qty Rcvd Tolerance % (quantity received tolerance percentage) field.
Qty Rcvd Tolerance % (quantity received tolerance percentage)	Displays the quantity received tolerance percentage for the item on the purchase order.
Close Under Quantity Percent	Enter the percentage that represents the under quantity tolerance for receiving this purchase order line. The percentage entered here is then used by PO close in determining if the PO line is eligible for closing.

Freight

Use the Freight tab to view and update information about freight terms for this schedule.

Field or Control	Description
Freight Terms	Displays the freight term code that applies to the schedules for this purchase order. You define the code for SetIDs on the Purchasing Options page.
Arbitration	Displays the freight and transportation arbitration plan for this business unit.
Charge Method	<p>Displays the method by which freight is charged for the purchase order. This value can be overridden for the schedule on the Details for Schedule page. Values are:</p> <p><i>Volume:</i> Freight is charged by the volume of the shipped item.</p> <p><i>Quantity:</i> Freight is charged by the number of packages.</p> <p><i>Value:</i> Freight is charged by the value of the order.</p> <p><i>Weight:</i> Freight is charged by the weight of the items.</p>
Freight Charge Override	Select this check box to override the freight charge set on the Purchase Order Defaults page with the values entered on this page.

RTV

Use the RTV (return to vendor) tab to define exchange returns to vendors associated with this purchase order line schedule. By assigning the RTV information, the PO schedule is identified as the order of the item being exchanged for the item on the return to vendor. A return to vendor for exchange will not be eligible for closing until the exchange item is identified on a PO schedule.

Note: When the due date is changed for a fully-received schedule, the system checks for any supplier returns for that schedule. If there is a return to vendor, the system prevents you from changing the date.

<i>Field or Control</i>	<i>Description</i>
BU RTV (business unit return to vendor)	Select a business unit to which the supplier return is going to be assigned.
RTV ID (return to vendor ID)	Select a RTV ID. You must first specify a business unit before you can select a RTV ID.
RTV Line (return to vendor line)	Select a RTV line. The available selections are based on the RTV ID that you enter.

Maintenance WO

Use the Maintenance WO (maintenance work order) tab to define information work order details.

Note: This will not appear on this page if PeopleSoft Maintenance Management is not installed.

If the purchase order was created through the PeopleSoft Purchasing sourcing processes the work order information fields on this page will already be populated with the values that came through the sourcing processes. If work order information does not already exist you can manually associate the work order information with the purchase order using the fields on this page. This page is used to associate non-inventory and ad hoc (description-only) items to purchase order schedules with a work order. If work order information is specified, then all distributions are associated with the work order specified. Use the Pegging Workbench to associate inventory items to a work order.

When you associate a work order with a purchase order the system will copy the distributions from the work order parts template, including distribute by method, distribution percentage, general ledger business unit, ChartFields, and projects information.

<i>Field or Control</i>	<i>Description</i>
Maintenance WO Unit (PeopleSoft Maintenance Management work order business unit)	Select the PeopleSoft Maintenance Management business unit.
Maintenance WO (maintenance work order)	Select the work order you want to associate with this purchase order.

Field or Control	Description
Task Number	Select the work order task number.
Resource Type	Select the type of resource you are defining a purchase order for. Values are: <ul style="list-style-type: none"> • <i>Labor.</i> • <i>Material.</i> • <i>Tools.</i>
Resource Line No. (Resource line number)	Select the resource line number associated with the work order, work order task, resource type entered. If the ad hoc (description only) item on the purchase order line doesn't exist on the work order, you can leave the resource line blank. At save, the system will add the ad hoc (description only) item to the work order task.
Custom Fields	The user definable fields in this Custom Fields section are available when you check the Enable Custom Fields checkbox on the Purchasing Installation Options page. You can customize these fields for your use. The custom fields are informational only. . For more information on Custom Fields See Understanding User-Definable Fields
Schedule Date	Displays the schedule date for the Maintenance Work Order This field is only displayed in update and display mode, and not visible in Add mode.
Amount	Displays the total amount for the Maintenance Work Order This field is only displayed in update and display mode, and not visible in Add mode.
Currency	Displays the currency for the Maintenance Work Order This field is only displayed in update and display mode, and not visible in Add mode.

The Schedule Date, Amount, and Currency fields are display fields from the WO schedule and not from the Purchase Order schedule details. If the Amount Only check box is selected for purchase order line and purchase order line is associated to Amount Only Work Order Schedule, only then the Schedule Date, Amount, Currency fields are displayed.

Changing Work Order Information

If the purchase order distributions are associated with a requisition, you must clear the requisition before you can change the work order information. Also, if the work order is associated with the purchase order schedule (non-inventory and ad hoc (description-only) lines), when you make a change to the purchase order and reopen the quantity back on the requisition, the system will reopen the requisition pegs to the work order. Changes that can cause this behavior are reducing quantity, canceling a distribution, and deleting a distribution. If the purchase order is for an inventory item, reopening the requisition quantity does not reopen the pegs. You must manually redo the pegging.

Related Links

[Maintain Purchase Order - Distributions for Schedule Page](#)

“User Preferences – Requisition Authorizations Page” (Application Fundamentals)

“Establishing Operation Closure Dates” (PeopleSoft Inventory)

“Direct Shipping Products” (PeopleSoft Order Management)

[PeopleSoft Maintenance Management Work Order Processing on the Purchase Order](#)

“Understanding Pegging” (PeopleSoft Supply Chain Management Common Information)

PO ShipTo Address Page

Use the PO ShipTo Address page (PO_ONE_TIME_ADDR) to set up a one-time ship to address for the selected purchase order schedule.

You cannot define a one-time address for direct shipment purchase orders. To change the address for a direct shipment you must go to the sales order in PeopleSoft Order Management and make the address change there.

Navigation:

Click the **Ship To Address** button on the Maintain Purchase Order - Schedules page.

Note: This page is not available for direct shipment purchase orders.

One Time Address

Field or Control	Description
Location Type	<p>Select an alternative location type other than the supplier location specified on the supplier Location page.</p> <p>The location type that you enter here automatically overrides the previous location defaults.</p> <p>Values include:</p> <p><i>Order of Acceptance:</i> In Taxware, this is also known as the Point of Order Acceptance (POA). This indicates the location that the order was accepted. In some states, the order of acceptance identifies tax applicability. For Taxware, this is the supplier location where the buyer order is approved and accepted. This is generally the order entry location.</p> <p><i>Point of Order:</i> This option applies to Taxware software only. Point of order is the supplier location where the buyer order is generally received. Values are:</p> <p><i>Ship From:</i> Location from which the order was shipped.</p> <p><i>Ship To:</i> Location for which the order will ship.</p> <p><i>Service Performed:</i> Location where the service will be performed.</p> <hr/> <p>Note: This field is only available when the Taxware software is installed.</p> <p>If you leave this field blank, the TaxCalc process derives the address information from supplier Location page.</p> <hr/>
GeoCode	Click this link to select a new geocode.

Sales/Use Tax Information for Schedule Page

Use the Sales/Use Tax Information for Schedule page (PO_SCHED_SUT) to enter the SUT information for the schedule.

Navigation:

Click the **Sched Sales/Use Tax** button on the Maintain Purchase Order - Schedules page.

Field or Control	Description
Tax Destination	<p>Location code on which the SUT calculation for the schedule should be based. This is also known as the tax basis.</p> <hr/> <p>Note: This option appears by default from the supplier Information - Tax Options, Purchasing Item Attributes, and Purchasing Item Category pages.</p>
Ultimate Use Code	<p>In most cases, sales tax is computed as a use tax based on the tax code applicable to the ship to or usage destination. However, how merchandise is ultimately used may also result in a different tax rate within the same ship to or usage destination. Enter an ultimate use code to override the default tax rate for a location.</p> <hr/> <p>Note: This option appears by default from the supplier Information - Tax Options, Purchasing Item Attributes, and Purchasing Item Category pages.</p>
Exception Type and SUT Excpn Cert (sales and use tax exception certificate)	<p>Appears by default from the ship to location for the SUT destination. SUT exception type values include <i>Direct Pay</i>, <i>Exempt/Exonerated</i>, and <i>None</i>.</p>

Field or Control	Description
Calculate SUT (calculate sales and use tax)	<p>Click this button to run the TaxCalc API process, which calculates the sales and use tax. Use this option when Vertex or Taxware is installed.</p>

Calculation Parameters

Field or Control	Description
Include VAT	<p>This setting is especially relevant if each line has separate tax code values for SUT and VAT, in which case it is possible to have both on a given line resulting in a tax-on-tax situation. In these instances, the system calculates VAT, then SUT, either on the net-extended amount for the line or on the sum of the net-extended amount and VAT amount.</p> <p>If this option is selected, it indicates that the VAT amount needs to be taxed and the system adds the VAT amount to the net-extended amount before calculating SUT.</p>
Include Freight	<p>If selected, indicates that the freight amount needs to be taxed and the system adds the freight amount to the net-extended amount before calculating SUT.</p>

Field or Control	Description
Include Misc Charges (include miscellaneous charges)	If selected, indicates that the miscellaneous charges need to be taxed and the system adds the miscellaneous charges to the net-extended amount before calculating SUT.

Note: The **Include Vat**, **Include Freight**, and **Include Misc Charges** calculation parameters appear by default from the Ship To Location Sales/Tax setup page.

Exception Handling

These exceptions apply to the Schedule Sales/Use Tax Information page:

- If the SUT exception type is exempt or exonerated for the ship to location, the system does not call the TaxCalc API to calculate the exception.
- If the SUT exception type is direct pay, the system updates the defaults on the SUT Excpn Cert (SUT exception certificate) with the direct pay permit from the ship to location and calls the TaxCAI API to update calculations.
- If the SUT applicability is sales and the exception type is none, then send the ship to, ship from, POA, POA address, and geocodes, along with the extended amounts, to the TaxCalc API. Sales tax amounts are updated accordingly and distributed to purchase order lines.
- If the SUT applicability is use and the exception type is none, then send the ship to, ship from, POA, POA address, and geocodes, along with the extended amounts, to the TaxCalc API. Set the transaction type to 1 - sales. Sales tax amounts are updated accordingly and distributed to purchase order lines.

Related Links

[SUT Processing on the Purchase Order](#)

“Establishing PeopleSoft-Only Sales and Use Tax Processing” (PeopleSoft Payables)

VAT Information for a Schedule Page

Use the VAT Information for a Schedule page (PO_SCHED_VAT) to review and update VAT details for this schedule.

This page is accessible only if the General Ledger business unit on the Purchasing business unit links to a valid VAT entity.

Navigation:

Click the **Schedule VAT** button on the Maintain Purchase Order - Schedules page.

Expanding and Collapsing Sections

To manage the VAT data more efficiently, you can expand and collapse sections on this VAT page making it easier to manage the information on this page.

Field or Control	Description
Expand All Sections	Click this button to scroll to and access every section on the page. You can also expand one or more sections by clicking the arrow next to the section's name.
Collapse All Sections	Click this button to collapse all sections displaying only the header information. If you expand one or more sections, you can click the arrow next to the section's name to collapse the section.

Physical Nature

Field or Control	Description
Physical Nature	Indicates whether an object is a good or a service. Many countries are required to report the sale and purchase of goods separately from services. The default comes from the customer location, customer or receivables business unit.
Change Physical Nature	Click to override the default physical nature for this item. The system resets all the VAT defaults.

VAT Locations

Field or Control	Description
Location Country	For services only, displays the PeopleSoft Purchasing business unit bill to location country.
Location State	For services only, displays the PeopleSoft Purchasing business unit bill to location state.
Supplier Location Country	For services only, displays the supplier's order from location country.
Supplier Location State	For services only, displays the supplier's order from location state.

Field or Control	Description
Service Performed Country	<p>The system sets the value for this field depending on the services performed flag setting in the product defaulting hierarchy (for example on the supplier or business unit):</p> <ul style="list-style-type: none"> • If the flag specifies the ship from location, this field is set to the supplier's ship from location country. • If the flag specifies the ship to location, this field is set to the ship to location country. • If the flag specifies the buyer's location, this field is set to the Purchasing business unit bill to location country. • If the flag specifies the suppliers location, this field is set to the supplier's order from location country.
Service Performed State	<p>The system sets the value for this field depending on the services performed flag setting in the PeopleSoft Purchasing defaulting hierarchy (for example on the supplier or business unit):</p> <ul style="list-style-type: none"> • If the flag specifies the ship from location, this field is set to the supplier's ship from location state. • If the flag specifies the ship to location, this field is set to the ship to location state. • If the flag specifies the buyer's location, this field is set to the Purchasing business unit bill to location state. • If the flag specifies the suppliers location, this field is set to the supplier's order from location state. <p>This appears only if the service-performed country requires that VAT be tracked by state or province.</p>
Ship From Country	<p>Displays the supplier's ship from location country. In the case of transactions involving goods or freight service transactions, this is used to determine the VAT treatment.</p>
Ship From State	<p>If the ship to country is defined as tracking VAT by state or province, it displays the supplier's ship from location state. In the case of transactions involving goods or freight service transactions, this is used to determine the VAT treatment.</p>
Ship To Country	<p>Displays the ship to location country. In the case of transactions involving goods or freight service transactions, this determines the VAT treatment.</p>

Field or Control	Description
Ship To State	If the ship to country is defined as tracking VAT by state or province, it displays the ship to location state. In the case of transactions involving goods or freight service transactions, this is used to determine the VAT treatment.

VAT Defaults

Field or Control	Description
Service Type	If the transaction is for a service, it displays <i>Freight</i> or <i>Other</i> as the VAT service type. The value in this field determines whether or not the special rules for freight transport within the European Union apply.
Place of Supply Driver	If the transaction is for a service, displays the usual place of supply (such as the place where VAT is usually liable) for the service. This value is used to help determine the place of supply country and the VAT treatment. Values are: <i>Buyer's Countries</i> , <i>Supplier's Countries</i> , or <i>Where Physically Performed</i> .
Reporting Country	Displays the country for which this VAT will be reported. This is the VAT entity VAT registration country and determines many of the VAT defaults.
Defaulting State	If the reporting country requires that VAT be tracked by state or province, this field displays the state within the reporting country that is used to retrieve values from the VAT Defaults table.
Supplier Registration Country and supplier Registration ID	Displays the registration country and ID of the supplier.
Exception Type	Displays the exception granted to the VAT entity. Values are: <i>None</i> , <i>Exonerated</i> , or <i>Suspended</i> . This value is specified on the VAT entity registration.
Certificate ID	If applicable, displays the ID of the VAT exception certificate that may have been issued to the VAT entity.

Field or Control	Description
Calculate at Gross or Net	<p>Indicates how VAT is calculated. Values are:</p> <p><i>Gross</i>: The system calculates VAT before it applies any early payment discounts.</p> <p><i>Net</i>: The system calculates VAT after it deducts early payment discounts. If there are two percentage discounts, the system uses the larger of the two when it calculates VAT. The system does not use discount amounts, only discount percentages.</p> <p>The default value comes from the VAT entity driver.</p>
Recalculate at Payment	<p>Select this check box to enable the recalculation of VAT at payment time to allow for any early payment discounts, if you are calculating VAT at gross. This causes the system to adjust the VAT amount at the time of payment if the discount has been taken. This is set on the VAT entity driver in the VAT defaults table.</p>
Declaration Point	<p>Appears for a good or service when you want VAT transaction information to be recognized for reporting purposes. Values are:</p> <ul style="list-style-type: none"> • <i>Invoice</i>: VAT is recognized at time of invoice. • <i>Payment</i>: VAT is recognized at time of payment. • <i>Delivery</i>: VAT is recognized on delivery. <p>This value may be set at several levels in the VAT hierarchy, that is, VAT entity registration, business unit options, supplier, or supplier location.</p>

Field or Control	Description
Rounding Rule	<p>Displays the VAT rounding rule. The value comes from the VAT country, VAT Entity, supplier, or supplier location drivers. Values are:</p> <p><i>Nat Rnd</i> (natural round): Amounts are rounded normally (up or down) to the precision specified for the currency code. For example, for a currency defined with two decimal places, 157.4659 would round up to 157.47 but 157.4649 would round down to 157.46.</p> <p><i>Down</i> (round down): Amounts are rounded down. For example, for a currency defined with two decimal places, 157.4699 would round down to 157.46.</p> <p><i>Up</i> (round up): Amounts are rounded up with a rounding precision to one additional decimal place. For example, for a currency defined with 2 decimal places, 157.4659 would round up to 157.47, but 157.4609 would round down to 157.46.</p>
Use Type	<p>Determines the split between recoverable (taxable) and non-recoverable (non-taxable) VAT.</p> <p>For the Canadian public sector, the use type also determines the rebate of the non-recoverable VAT. VAT rebates are calculated based on statutory rebate rates that are established for each public service body.</p> <p>The value comes from the VAT defaulting hierarchy, either from the item, item business unit, item category, supplier location, supplier, or purchasing options.</p>
Include Freight	<p>If selected, the system includes any freight amounts in the VAT basis by calculating VAT on the merchandise amount plus any freight amount. This option is only available for exclusive VAT calculation. The value comes from the VAT entity registration driver.</p>
Include Miscellaneous	<p>If selected, the system includes any miscellaneous charge amounts in the VAT basis by calculating VAT on the merchandise amount, plus any miscellaneous charge amount. This option is only available for exclusive VAT calculation. The value comes from the VAT entity registration driver.</p>
Place of Supply Country	<p>Displays the country in which the VAT liable (for services). Place of supply country is determined by algorithm.</p>

Field or Control	Description
Treatment	<p>Displays the VAT treatment. VAT treatment is determined by a complex set of algorithms. Values are:</p> <ul style="list-style-type: none"> • <i>Domestic Goods Purchase:</i> If the ship from and ship to countries are the same, and the supplier is registered for VAT, the transaction is treated as domestic. • <i>Domestic Service Purchase:</i> If the buyer and seller are both located in the country where the VAT is liable, the transaction is treated as domestic. • <i>EU Goods Purchase:</i> If the ship from and ship to countries are different, the system determines whether both countries are located within the European Union. If so, the system looks at the VAT registration for each trading partner to determine whether the transaction should be treated as an intra-EU purchase, domestic, or outside the scope of VAT. • <i>EU Service Purchase:</i> If each trading partner is located and registered in different EU countries, and the VAT on a service is liable in the buyer's country, the transaction is treated as a self-assessed EU Services Purchase. • <i>Self-Assess Goods Import:</i> If the ship from country is different from the ship to country and either or both of the countries are located outside of the European Union, and the supplier is not registered in the ship to country, the transaction would be treated as an import. If the flag on the entry in the VAT Country table for the VAT reporting country indicates that VAT on imports should be self-assessed, the transaction will be treated as a self-assess goods import, and both input and output VAT will be recorded. • <i>Self-Assess Service Import:</i> If each trading partner is located and registered in different countries, and the VAT on a service is liable in the buyer's country, the transaction is treated as a self-assessed services import. • <i>Zero-rated Goods Import:</i> If the ship from country is different from the ship to country and either or both of the countries are located outside of the European Union, and the supplier is not registered in the ship to country, the transaction would be treated as an import. If the flag on the entry in the VAT Country table for the VAT reporting country indicates that only input VAT should be recorded on imports, the transaction will be treated as a zero-rated goods import.

Field or Control	Description
	<ul style="list-style-type: none"> • <i>Outside of Scope</i>: If the supplier is not registered for VAT, or if the VAT is liable in a country other than the VAT reporting country, the transaction is treated as outside the scope of VAT. • <i>No VAT Processing</i>: For transactions where the physical nature is goods, if the ship to country has not been defined as a VAT country and the VAT reporting country on the transaction is blank, no VAT information will be recorded. <p>Within PeopleSoft, detail VAT treatment values on the transaction lines are used for applying the precise defaults applicable to the transaction lines. The treatment is determined based the rules applicable to the transaction.</p>
Applicability	<p>Displays the VAT status. Applicability is determined by an algorithm that makes use of the Applicable field in the VAT defaults table, the value of which may be set at almost every level in the PeopleSoft Purchasing VAT defaulting hierarchy. Values are:</p> <ul style="list-style-type: none"> • <i>Exempt</i> (not subject to VAT). • <i>Exonerated</i>. • <i>N/A</i> (not applicable): Valid only when VAT treatment is No VAT Processing. • <i>Outside</i> (outside scope of VAT). • <i>Suspend</i>. • <i>Taxable</i>.
VAT Code	<p>Displays the VAT code that defines the rate at which VAT is calculated for this schedule. The default value comes from the VAT country, purchase order options, supplier, supplier location, item category, and item levels in the PeopleSoft Purchasing VAT defaulting hierarchy.</p>

Field or Control	Description
Record Output VAT	Select this check box to enter vouchers where VAT is not included on the invoice but is payable to the VAT authority rather than the supplier. In this case, you account for both input and output VAT for the purchase. This is the case for an Intra-EU Acquisition or when you must account for output VAT on a service supplied by a foreign supplier. This is also referred to as self-assessing for VAT. The value comes from an algorithm that uses the treatment and applicability to retrieve the applicable value from the PeopleSoft-delivered VAT system setup data.
Transaction Type	Displays the code that categorizes and classifies this transaction for VAT reporting and accounting. The default value comes from the VAT entity registration, purchase order options, supplier, supplier location, item category, and item levels in the PeopleSoft Purchasing VAT defaulting hierarchy.

Adjust/Reset VAT Defaults

Any changes that you make to fields on this page may affect VAT defaults on this page. For accuracy and consistency, use these fields to adjust affected VAT defaults or to reset all VAT defaults. Adjusting or resetting VAT defaults only affects fields within the **VAT Defaults** group box.

Field or Control	Description
Adjust Affected VAT Defaults	<p>Click this button to have the system adjust the VAT defaults that are affected by the changes. All changes that you have made to VAT defaults on this page that affect other VAT defaults on this page will be retained.</p> <p>Click the i button to list the fields that are to be adjusted.</p> <hr/> <p>Note: You should always click the Adjust Affected VAT Defaults button after changing any defaults on the VAT page.</p> <hr/>
Levels	<p>Enables you to specify the levels to reset when you click the Reset All VAT Defaults button. Values are:</p> <p><i>All lower levels:</i> Resets all VAT defaults at lower levels for this page.</p> <p><i>This and all lower levels:</i> Resets all VAT defaults on this page and at any lower levels of this page.</p> <p><i>This level only:</i> Resets all VAT defaults on this page.</p>

Field or Control	Description
Reset All VAT Defaults	<p>Click to have the system reset the VAT defaults based on the Levels value that you selected. Any changes that you previously made to VAT defaults will be lost.</p> <hr/> <p>Note: Reset completely redetermines the VAT defaults. This does not necessarily mean they are reset to their original values. For example, the user may not have changed any VAT default values, but if a VAT driver field changes, you can click Reset All VAT Defaults to redetermine all defaults based on the new driver value.</p> <hr/>

Related Links

[Preparing PeopleSoft Purchasing VAT Environments](#)

Details for Schedule Page

Use the Details for Schedule page (PO_SCHED_DTLS) to review or add schedule details to the selected schedule line.

Navigation:

Click the **Schedule Details** button on the Maintain Purchase Orders - Schedule page.

This example illustrates the fields and controls on the Details for Schedule page. You can find definitions for the fields and controls later on this page.

Details for Schedule 1

Unit US001	Supplier PLANTINSUL-001
PO ID POSBI-05	Item 10000 Long Sleeve Biking Jersey, Men's
Line 1	Status Active ▲ ✖
Schedule 1	

Schedule Details

Due Date 03/16/2001 Time Due <input type="text"/> Ship To US001 Original Promise Date <input type="text"/> <small>BT</small> Ship Date <input type="text"/> <small>BT</small> Ship Via COMMON Common Carrier Freight Terms DES Destination Attention To <input type="text"/> Distribute By Quantity	<input type="checkbox"/> Custom Price - No Override <input type="checkbox"/> Zero Price Indicator No Charge <input type="checkbox"/> Frozen (Planning)
---	--

Amount Summary	
Schedule Qty	100.0000
Merchandise Amt	2,500.00 USD
Doc. Base Amount	2,500.00 USD

Expand All Collapse All

▶ Matching Controls

▶ Receiving Controls

▶ Freight Calculation Rule

▶ Return To Vendor / Supplier

▶ Maintenance &WO

Field or Control	Description
Status	Purchase order schedule status. Values are: <i>Active</i> , <i>Canceled</i> , or <i>Closed</i> .

Schedule Details

Field or Control	Description
Custom Price - No Override	Select this check box to indicate that you entered a custom price on the schedule. When the system needs to recalculate a price, it prompts you for approval before automatically recalculating the price. If you do not select this check box, but change the price on the schedule, the system selects it for you.

Field or Control	Description
Zero Price Indicator No Charge	Select this check box to indicate that this is a zero-priced line and is considered a no charge item.
Frozen (Planning)	<p>If selected, prevents PeopleSoft Supply Planning from changing the schedule. The two schedule changes PeopleSoft Supply Planning is allowed to recommend include:</p> <ul style="list-style-type: none"> • Rescheduling the due date to ensure supply is on hand for a particular demand. • Canceling the schedule if no demand exists.
Ship To Location	Displays the ship to destination selected for the purchase order.
Ship to GLN	<p>Displays the global location number for the corresponding ship to location, if available.</p> <hr/> <p>Note: If the associated item has a preferred ship to location, the system displays the global location number for that preferred location.</p> <hr/>
Original Promise Date	<p>Displays the supplier's original promised delivery date. Use this field to track when the supplier promised delivery against the date that the goods were actually received.</p> <p>Alternatively, you can use the due date on the schedule as the date against which to compare the receipt date for supplier performance tracking.</p>
Doc. Base Amount (document base amount)	Displays the document base amount. This is the Amount value converted to the base currency of the purchase order. The base currency is the currency of the PeopleSoft General Ledger business unit for this PeopleSoft Purchasing business unit.

Matching Controls

Field or Control	Description
Matching	Select the matching method for the schedule. Values are <i>ERS</i> , <i>Full Match</i> , and <i>No Match</i> .

Field or Control	Description
Match Status PO	<p>Displays the match status of the schedule. Values are <i>To Match</i>, <i>Part Matched</i>, <i>Fully Matched</i>, and <i>Unmatched</i>. These are set based on the extent to which the matching process has been completed for the schedule.</p> <p>The system updates the match status, both from the matching process and from online purchase order maintenance. Online purchase order activity affects the match status if a schedule has already been fully matched and you increase the quantity. In that case, the system resets the match status to reflect a partial match.</p>

Matching Tolerance

When you use matching to verify supplier charges, the system uses price tolerances to determine whether the purchase order and voucher prices are within the tolerances and thus whether the purchase order and purchase order voucher match.

If you leave any of the tolerance fields set to zero or blank, the system interprets this to mean a zero tolerance.

If you don't want to use the tolerance fields, set the amount fields to *99999999.99999* and the percentage fields to *100%*.

If you match vouchers against amount-only purchase order lines, multiple vouchers are likely to exist for the same purchase order schedule line. In this case, the under tolerance matching tolerances should not apply. To prevent under tolerance matching exceptions for non-received amount only lines you can do one of these options:

- Enter *99999999.99999* in the under tolerance fields for matching to a purchase order.
- Use Accounts Payable matching rules.

You can specify multiple matching rules on a purchase order, and on those rules, you can choose to use purchase order tolerances or not. You can modify existing delivered rules (by changing the SQL), or create your own rules that eliminate checking the purchase order lower tolerance percentages for amount only purchase order lines.

See “Establishing Matching and Document Association Options” (PeopleSoft Source to Settle Common Information).

Field or Control	Description
Unit Price Tolerance Over/Tolerance Under	Amount over and under the individual item price that you plan to allow on the voucher and still have the transaction qualify for a match.

Field or Control	Description
% Unit Price Tolerance Over/Tolerance Under	Percent over and under the individual price that you plan to allow on the voucher and still have the transaction qualify for a match.
Ext Price Tolerance Over/Tolerance Under (extended price tolerance over/tolerance under)	Amount over and under the extended item price (price multiplied by quantity) that you plan to allow on the voucher and still have the transaction qualify for a match.
% Ext Price Tolerance Over/Tolerance Under	Percent over and under the extended item price (price multiplied by quantity) that you plan to allow on the voucher and still have the transaction qualify for a match.

Receiving Controls

Field or Control	Description
Reject Qty Over Tolerance (reject quantity over tolerance)	Select this check box to reject a shipment at receiving time if the quantity received is over the tolerance set in the Qty Rcvd Tolerance % (quantity received tolerance percentage) field.
Early Ship Rjct Days (early shipment reject days)	If you want to reject goods that arrive too early, enter the number of days early a shipment needs to be to qualify for rejection. For example, enter 3 to reject shipments automatically that arrive three or more days early.
Qty Recv Tolerance % (quantity received tolerance percentage)	Displays the quantity received tolerance percentage for the item on the purchase order. This field appears by default from the supplier's UOM and Pricing Info page.
Close Under Quantity Percent	Enter the percentage that represents the under quantity tolerance for receiving this purchase order line.

Freight Calculation Rule

Field or Control	Description
Freight Charge Override	Select this check box to override the freight charge set on the Purchase Order Defaults page with the values entered on this page.

Maintenance WO (maintenance work order)

Displays the PeopleSoft Maintenance Management work order information that you previously entered on the Maintain Purchase Order - Schedules page. The Schedule Date, Amount, and currency fields are display fields from the WO schedule and not from the Purchase Order schedule details. If the Amount Only check box is selected for Purchase Order Line and Purchase Order Line is associated to Amount Only Work Order Schedule, only then the Schedule Date, Amount, Currency fields are displayed.

You can change the work order information field values on this page and the changed values will be reflected on the Maintain Purchase Order - Schedules page.

Note: The Maintenance WO section will not appear on this page if PeopleSoft Maintenance Management is not installed.

See [Maintain Purchase Order - Schedules Page](#).

Related Links

[Purchase Order Defaults Page](#)

Price Adjustments for Schedule Page

Use the Price Adjustments for Schedule page (PO_VAL_ADJ) to adjust the price of a schedule.

Navigation:

Click the **Value Adjustment** button on the Maintain Purchase Order - Schedules page.

Field or Control	Description
Adjusted Price	Displays the sum of all value adjustments, including base price.
Current Price	Displays the current price on the schedule.
Change Price	<p>Click this link to set the current price value to the adjusted price value. This difference in prices may have been introduced during a price override or if a custom price was set at on the schedule. This link is available only when the adjusted price is not equal to the current price.</p> <p>If you change the price directly on the schedule line, the current price reflects this change. If this change is made in error, you can click the Change Price link to change the current price back to the adjusted price.</p>
Sort Value Adjustments	Click this link to sort the value adjustments by sequence number.

Value Adjustments

Field or Control	Description
Seq (sequence)	<p>The order in which the system applies adjustments. This distinction can be important if there are percentage adjustments. The amount the percentage represents can vary depending on the order in which the adjustments are applied. You cannot change the sequence number of system-calculated adjustments for the base price of an item or supplier, nor for contract price adjustments.</p>
Type	<p>There are various types of adjustments available for purchase orders.</p> <p>Indicates the origin of the price adjustment amount. For example, the type is set to <i>CNT</i> (contract) if the purchase order line is associated with a contract and the contract has contract price adjustments defined.</p> <p>The system calculates some of the adjustments, including the base price adjustment. You can indicate whether the adjustment should be applied for all types, except the base price type.</p> <p><i>Base</i>: Base price from the item's Purchasing Attributes page. This is either the item and supplier price or the standard item price. The base price is always the first adjustment and cannot be deleted. Unless the base price adjustment type is user defined, you cannot change it. User-defined base price adjustment types are possible only if you are ordering by description. Values are:</p> <p><i>CNT</i>: The price adjustment is from the contract.</p> <p><i>TBL</i>: The price adjustment (discount or surcharge) is from the item's Price Adjustments page.</p> <p><i>FRT</i>: The price adjustment is from a freight charge.</p> <p><i>TAX</i>: The price adjustment is from an SUT amount.</p> <p><i>OTH</i>: Other miscellaneous adjustments. If selected, enter the adjustment description in the available text box.</p>

Field or Control	Description
Base Price Type	<p>Identifies where the starting price came from when the value in the Type field is <i>Base</i>. Values are:</p> <p><i>Contract</i>: From the contract for the item.</p> <p><i>Item Standard</i>: From the standard item price on the item's purchasing attributes.</p> <p><i>Supplier Std</i>: From the standard item and supplier pricing structure on the item Purchasing Attributes-Item/supplier page or Price Adjustments page.</p> <p><i>User</i>: When the user-defined price is used because the staged row is created without selecting the Calculate Price check box.</p>
Adj Meth (adjustment method)	<p><i>Pct</i> (percent): If selected, the Pct and Price To Base Percentage On fields become available for entry. Enter the adjustment percent and indicate whether you want the adjustment percentage applied to the base price or to the price as calculated.</p> <p>For example, suppose that you have a base price of 100 and two percentage adjustments of -10 percent each.</p> <p>If you select <i>Base</i>, the system applies each adjustment to the base price and totals the adjustments for a total adjustment of -20 and an adjusted price of 80.</p> <p>If you select <i>Calculated</i>, the system applies the adjustments incrementally according to the adjustment sequence number. The first adjustment of -10 percent is applied to the base price of 100 for an adjustment of -10 and an incremental price of 90. The second adjustment is applied to the calculated incremental price of 90 for an adjustment of -9 and an adjusted price of 81.</p> <p><i>Amt</i> (amount): Enter an adjustment amount.</p> <p>Amount and percent adjustments can be either positive (surcharge) or negative (discount).</p>

System Adjustment Info

If you have a contract or an item-supplier relationship on the line, there may be price adjustments associated with the item. The price adjustments associated with the item appears in the **System Adjustment Info** group box.

Field or Control	Description
Ship To	Location to which the adjustment pertains.
UOM	UOM for which the adjustment should be applied.
Qty Needed (quantity needed)	Displays the quantity needed to qualify for the adjustment.
Actual	Displays the actual quantity on the schedule.

Miscellaneous Charges for Schedule Page

Use the Miscellaneous Charges for Schedule page (PO_SCHED_MISC) to change miscellaneous charges on this schedule.

Navigation:

Click the **Miscellaneous Charges** button on the Maintain Purchase Order - Schedules page.

Field or Control	Description
Adjusted Price	Displays the price on the schedule including any price adjustment amounts.
Current Price	Displays the current price on the schedule.

Misc. Charges

Field or Control	Description
Calculation Method	If the charge type has appeared by default from the Miscellaneous Charges - Miscellaneous page, the calculation method associated with the default appears here. If the charge was entered on the schedule, the <i>% Value</i> method is selected and you can enter values in the Value % and Flat Amount fields.
Value % (value percentage)	If the miscellaneous charge is a percentage of the unit price, this is the percentage of the charge.
Flat Amount	If the miscellaneous charge is a flat amount, this is the amount of the charge.

More Details

Select the **More Details**.

Field or Control	Description
Actual Chrg (actual charge)	Select if this is an actual charge, rather than an estimate. The system displays the miscellaneous charge origin. Values are: <i>Allocated:</i> Charges are allocated from the header miscellaneous charges. <i>Calculated:</i> Charges are calculated from the item and supplier miscellaneous charges setup. <i>Entered.</i>
LC Comp (landed cost component)	If selected, indicates that the charge is a landed cost. This is a display-only field.

Related Links

[Miscellaneous Charges Selection Page](#)

“Defining Miscellaneous Charges and Landed Costs” (PeopleSoft Source to Settle Common Information)

Schedule - 3rd Party Supplier Page

Use the Schedule - 3rd Party supplier page (PO_SCHED_MISC_3RD) to select a third-party supplier to whom to pay the miscellaneous charge.

Navigation:

Click the **Third Party** link on the Miscellaneous Charges for Schedule page.

Field or Control	Description
Adjustment Amount	The amount of the miscellaneous charge from the Schedule - Miscellaneous Charges page appears.
Currency	Currency of the charge amount appears by default from the supplier location default currency when the third-party supplier location is specified.
Adj Base (adjustment base)	Adjustment amount expressed in the base currency.

Related Links

[Miscellaneous Charges for Schedule Page](#)

Creating Purchase Order Distributions

This section discusses how to Create Purchase Order Distributions

Pages Used to Create Purchase Order Distributions

Page Name	Definition Name	Usage
<u>Maintain Purchase Order - Distributions for Schedule Page</u>	PO_SCHED_DISTRIB	Define multiple distributions for each purchase order schedule.
Item Description Page	PO_ITEM_DESCR2	Enter and view descriptions for a specific item.
Multiple SpeedCharts Page	RUN_POSPCHARTS_OL	Add, append, and override speed charts for the purchase order schedule. <u>Maintain Purchase Order - Distributions for Schedule Page</u>
Multiple Accounting Tag Page		Append, and override accounting tags for the purchase order schedule. <u>Maintain Purchase Order - Distributions for Schedule Page</u>
PO Currency Information Page	PO_DIST_CURR_INFO	View the date, rate, and other currency information. <u>Maintain Purchase Order - Distributions for Schedule Page</u>
Exchange Rate Detail Page	EXCH_RT_DTL_INQ	Display the rules used to calculate exchange rates for the transaction.
Requisition Details Page	PO_DISTRIB_REQ	View the details of the requisition from which this purchase order distribution originated and clear the requisition from the distribution. <u>Maintain Purchase Order - Distributions for Schedule Page</u>
<u>Sales/Use Tax Details for Distribution Page</u>	PO_DISTRIB_SUT	View sales and use tax information pertaining to this purchase order distribution.
<u>VAT Details for Distribution Page</u>	PO_DISTRIB_VAT	Review the VAT details for this distribution and change the VAT transaction type.

Page Name	Definition Name	Usage
<u>Maintain Distributions Page</u>	PO_CF_DTLS	Enter distribution information directly which enables you to maintain a purchase order distribution directly without accessing the Maintain Purchase Order - Schedules page first.

Maintain Purchase Order - Distributions for Schedule Page

Use the Maintain Purchase Order - Distributions for Schedule page (PO_SCHED_DISTRIB) to define multiple distributions for each purchase order schedule.

Navigation:

Purchasing > Purchase Orders > Add/Update POs > Maintain Purchase Order - Purchase Order

Click the **Schedules** button on the Maintain Purchase Order - Purchase Order page.

Click the **Distributions/ChartFields** button from the Maintain Purchase Order - Schedules page.

This example illustrates the fields and controls on the Maintain Purchase Order Distributions for Schedule page. You can find definitions for the fields and controls later on this page.

Distributions for Schedule 1

Unit US001 Supplier EMELS-001
 PO ID NEXT Item 10002 [Long Sleeve T-Shirt, Mens](#)
 Line 1
 Schedule 1 Status Active

*Distribute By:

Accounting Tag: Multi-Accounting Tags

Schedule Qty
 Merchandise Amount USD
 Doc. Base Amount 0.00 USD

Distribution Personalize | Find | View All | | | First | 1 of 1 | Last

Dist	Status	Percent	PO Qty	Merchandise Amount	Currency	*GL Unit	*Account	Alt Acct	Oper Unit	Dept	Program	Clas
1	Open	<input type="text"/>	<input type="text"/>		USD	US005	131000		<input type="text"/>	11000	<input type="text"/>	<input type="text"/>

The settings of the **Override** and **Default** options on the PO Defaults page affect defaulting behavior on this page when you split distribution lines.

For example, suppose that you select the **Override** option, and you split 50 percent of distribution line 1 to distribution line 2, the system checks the purchase order defaults for a matching distribution line number (in this case, it is 2). If no match exists, it applies the value from distribution line 1. If no value exists on distribution line 1, the system looks to the next levels in the default hierarchy.

If you select the **Default** option and perform the same split, the system checks the default hierarchy first. If no values exist, the system checks the purchase order default values as described previously.

Field or Control	Description
Distribute by	<p>Select the method by which you want to allocate or charge the expense account distribution. Values are:</p> <p><i>Amount:</i> Select if the sum of all distribution amounts must equal the schedule amount (merchandise amount). Inventory items cannot be distributed by amount.</p> <p><i>Quantity:</i> Select if the sum of all distribution quantities must equal the schedule quantity.</p>
Liquidate by	<p>Liquidate the outstanding pre-encumbrance and encumbrance balances by amount or quantity. This field is only available on schedules that are set to distribute by quantity. Distributions that are set to distribute by amount will always be set to liquidate by amount.</p> <hr/> <p>Note: This field is only visible if commitment control is enabled, and you choose the Liquidate by Quantity option on the Purchasing Definition - Business Unit Options page. If commitment controlled is not installed, or you do not choose the option to liquidate by quantity on the purchase order business unit page, the budget processor balance liquidates by amount only.</p> <hr/>
SpeedChart	<p>If you charge by amount, you can define distributions using speed charts. Speed charts are templates that contain preset distributions. Select a speed chart and accept or override the default values. If a purchase order schedule has already been vouchered, you cannot override the value in this field.</p> <hr/> <p>Note: Accounting Tags appear in lieu of Speedcharts when the Accounting Tag check box is selected for Purchasing on the Accounting Tag Registration page. See “Setting Up Accounting Tags” (Application Fundamentals)</p> <hr/>
Multi-SpeedCharts	<p>Click to access the Multiple SpeedCharts page where you can add, append, and override speed charts for the purchase order schedule.</p> <hr/> <p>Note: Accounting Tags appear in lieu of Speedcharts when the Accounting Tag check box is selected for Purchasing on the Accounting Tag Registration page. See “Setting Up Accounting Tags” (Application Fundamentals)</p> <hr/>

Field or Control	Description
Accounting Tag	<p>Enter an Accounting Tag that will be used to populate ChartFields on transaction distribution lines. The system automatically prorates the distribution amounts according to the proration percentages defined on the Accounting Tag.</p> <p>If the purchase order is dispatched or vouchered, you cannot override the value in the Accounting field.</p> <hr/> <p>Note: Accounting Tags appear in lieu of Speedcharts when the Accounting Tag check box is selected for Purchasing on the Accounting Tag Registration page. See “Setting Up Accounting Tags” (Application Fundamentals)</p>
Multi-Accounting Tag	<p>Click to access the Multiple Accounting Tag page where you can append and override accounting tags for the purchase order schedule.</p> <hr/> <p>Note: If the purchase order is dispatched or vouchered, the override option will be disabled and the user can only use the append option.</p> <hr/> <p>Note: Accounting Tags appear in lieu of Speedcharts when the Accounting Tag check box is selected for Purchasing on the Accounting Tag Registration page. See “Setting Up Accounting Tags” (Application Fundamentals)</p>

Field or Control	Description
Doc Tol Status	<p>If document tolerance checking is enabled, the system displays the document tolerance status. The system runs the Document Tolerance process before budget checking when you click the Budget Check button, or you can run the process separately. Document tolerance checks the change in percentage or a fixed dollar amount between the purchase order and requisition at the ChartField distribution level.</p> <p>Values are:</p> <p><i>V</i> (valid): The purchase order has passed document tolerance checking.</p> <p><i>N</i> (not checked): The purchase order requires document tolerance checking. If any amounts, quantities or ChartFields are modified after the document tolerance is checked, the system resets the document tolerance status to <i>Not Checked</i>.</p> <p><i>E</i> (error): Exceptions were generated for the purchase order during document tolerance checking. You can override document tolerance exceptions on the Document Tolerance Exception page.</p>

Field or Control	Description
Doc Base Amount	Displays the document base amount. This is the Amount value converted to the base currency of the purchase order. The base currency is the currency of the PeopleSoft General Ledger business unit for this PeopleSoft Purchasing business unit.

Chartfields

Field or Control	Description
Status	The default distribution status is <i>Active</i> . This status is updated by the PO RECON process (PO_PORECON), or when a line is canceled.
Percent	Enter the distribution percentage for the line. If you distribute by amount or quantity and change either of the values, the percent is adjusted. If you change the percent, the amount or quantity is adjusted. In either case, the percent total must be 100.
PO Qty (purchase order quantity)	If you are distributing by quantity, enter a quantity.
Amount	If you are distributing by amount, enter an amount. The transaction currency of the distribution amount appears.
GL Unit (PeopleSoft General Ledger business unit)	Displays the PeopleSoft General Ledger business unit associated with the PeopleSoft Purchasing business unit. Note: If the purchase order schedule is associated with a work order, the general ledger business unit appears by default from the work order parts template.
ChartFields	If the purchase order schedule is associated with a work order, the ChartFields will appear by default from the work order parts template if you are procuring non-inventory or description-only items.
PC Business Unit, Project, and Activity	If the purchase order schedule is associated with a work order, the project information will appear by default from the work order parts template if you are procuring non-inventory or description-only items. If you are procuring inventoried items the projects information will not be sent.

Details/Tax

Select the **Details/Tax** tab.

Field or Control	Description
Base Amt (base amount)	Distribution amount expressed in the base currency. This amount is converted from the purchase order transaction currency to the base currency on the general ledger unit.
Commitment Control Close Flag	Displays as selected when the budget processor should fully liquidate the outstanding encumbrance when running budget checking on this purchase order.
Location	Internal destination of the item, once it is received. This can be different from the ship to location of the schedule. For instance, the ship to location of the schedule could be corporate headquarters, and the distribution location could be a particular floor's supply room.
IN Unit (inventory unit)	<p>PeopleSoft Inventory business unit for the item. At the distribution level, if the purchase order line is for an inventory item, this field appears by default from the ship to location on the Maintain Purchase Order - Schedules page.</p> <p>If the item is an inventory item and an inventory business unit is entered on the first distribution line of the schedule, the due date on the Maintain Purchase Order - Schedules page is validated against the inventory business unit calendar. This ensures that the inventory business unit is open to receive merchandise on that day. You can also enter a PeopleSoft Inventory business unit for items that are identified as stockless.</p> <p>The presence of an PeopleSoft Inventory business unit value in this field causes the items to be received and putaway to the selected PeopleSoft Inventory business unit. If you do not want the items to be received into inventory, be sure to clear this value.</p>
Consigned	If selected, the distribution contains a consignment item. If the inventory business unit is not defined, the consigned check box is clear and cannot be overridden.

This table illustrates the rules that determine the setting of the **Consigned** check box on this page.

<i>Item designated as consigned on BU_ITEMS_INV?</i>	<i>Supplier designated as consignment supplier?</i>	<i>Consigned check box setting</i>	<i>Effect</i>
Y	Y	Selected. Consigned check box is automatically selected by default, but this setting can be overridden.	Item purchased from this specific supplier can be purchased as either a consigned item or an owned item. The item can never be purchased as solely a non-owned item.
Y	N	Clear. Consigned check box is clear by default and the setting cannot be overridden.	When purchased from this specific supplier, item cannot be purchased as a consigned item.
N	N	Clear. Consigned check box is clear by default and this setting cannot be overridden.	Item can never be purchased as a consigned item.

Asset Information

Select the **Asset Information** tab.

Note: If the purchase order schedule is a non-inventory item and open description item and is associated with a PeopleSoft Maintenance Management work order you are unable to enter asset information for the distribution on this page.

Field or Control	Description
AM Unit (PeopleSoft Asset Management business unit)	<p>Select a PeopleSoft Asset Management business unit to associate with the asset item. If this field is populated by the system, the value appears by default from the PeopleSoft Purchasing business unit or the Purchase Order Defaults page.</p> <hr/> <p>Note: If you consider an item to be an asset and plan to pass it to PeopleSoft Asset Management through the PeopleSoft Receiving business process, you must populate both the PeopleSoft Asset Management business unit and Profile ID fields.</p> <p>If both fields contain values, data is written to the PeopleSoft Asset Management staging tables. If only one of the fields is populated, the system will not consider the item an asset.</p> <p>All of the information that you enter on this page is passed to PeopleSoft Asset Management.</p> <hr/>
Profile ID	Select an asset profile ID.
CAP# (capital acquisition plan number)	Select a CAP number defined for this item in PeopleSoft Asset Management. This is required only if the item is capitalized.
Sequence	Select a sequence number for the capital acquisition plan.
Tag Number	<p>Enter an asset tag number. The quantity on the distribution must be 1 to enter a tag number. This information becomes available on the Asset Information page once the asset data has passed on to PeopleSoft Asset Management.</p> <p>In addition, the system checks the tag number you enter on the purchase order to make sure it is not already assigned to an asset, when the Allow Dup Tags option is not set for the PeopleSoft Asset Management business unit. If the tag number has already been assigned to another asset the system will give you a warning message. The system only looks at the Assets table it does not look at the interface tables, previously entered receipts, purchase orders, or requisitions to see if the tag number has been assigned to another pending transaction.</p>
EmplID	Select an employee ID of the custodian for this item. This information corresponds to the employee ID number on the Asset Custodian/License/Manufacturer page.

Field or Control	Description
Capitalize	Designates a capitalized item. A PeopleSoft Asset Management business unit must be selected in order for this check box to be enabled. If the item is capitalized, it can be depreciated before being paid.
Cost Type	Select the cost type associated with the item purchase, if applicable. Cost types represent components of the cost of an asset, such as materials, labor, and overhead. For example, you can differentiate between the cost of building an asset and its market value by allocating production cost to one cost type and the profit margin to another. Cost type, in combination with asset category and transaction code, determines which accounts the costs are entered into in the general ledger. See “Understanding the Manufacturing Standard Cost Foundation” (PeopleSoft Cost Management).

Req Detail

Select the **Req Detail** (requisition details) tab.

Use this tab to view the details of the requisition from which this purchase order distribution originated. You can view the requisition business unit, line, schedule, distribution, as well as other requisition related purchase order distribution information.

Field or Control	Description
	Click the PO Distribution Worksheet icon to access the PO Distribution Worksheet page, where you can split PO distribution lines and maintain total split quantity to that of original line distribution quantity and add chartfields of your choice. The distribution lines that are split using PO Distribution Worksheet are available on the PO Distribution page with the same requisition information.

Field or Control	Description
	Click the Clear Requisition Info button to clear the requisition information from the purchase order distribution without changing the purchase order quantity. Information cleared from the purchase order distribution line includes the requisition business unit, requisition ID, requisition line number, requisition schedule number, and requisition distribution line number. The purchase order distribution remains, but is no longer sourced from the requisition. If you take this action, the system will increase the open quantity on the requisition by the quantity on this distribution. If you increase the open quantity on the requisition, you can source the quantity to another purchase order.
Attention To	Displays the person to whom, or place to where the services or goods are to be delivered. If the purchase order's scheduled shipment originated from the requisition, the Attention To field value is carried onto the purchase order. When the purchase order distribution is manually entered, this field is blank.

Note: If the purchase order is sourced from a requisition, click the related requisition links to access the requisition component.

Budget Information

Select the **Budget Information** tab.

Field or Control	Description
Status	<p>Distribution line status. Values are:</p> <p><i>Complete:</i> The distribution line is closed.</p> <p><i>Open:</i> The distribution line is open.</p> <p><i>Processed:</i> The distribution line has been processed and is unavailable for sourcing.</p> <p><i>Canceled:</i> The distribution line has been canceled.</p>

Field or Control	Description
Final	<p>Select this check box if you want to fully liquidate the predecessor requisitions pre-encumbrance balances. This check box will get selected based on a finalized action at any level of the purchase order.</p> <p>The system does not display this check box if commitment control is off or if the purchase order is not sourced from a requisition, and thus has no predecessor.</p> <hr/> <p>Note: If you identify a distribution line as final for less, you must run budget checking afterwards.</p> <hr/>
Budget Status	<p>When commitment control is on, the system displays whether this distribution has been budget checked. Values for the field include <i>Not Chekd</i> and <i>Valid</i>.</p>
Budg Dt (budget date)	<p>Displays the date used by commitment control to determine the budget period to which this item cost belongs.</p>
Encumbrance Balance	<p>Displays the encumbrance balance when commitment control is installed. When you create a purchase order, commitment control liquidates the pre-encumbrance balance from the requisition and establishes an encumbrance for the purchase order.</p> <p>You can view budget details for the purchase order. Click the Encumbrance Balance link to access the PO Accounting Entries Inquiry where you can select a General Ledger business unit and commitment control ledger group to use as a budget inquiry.</p> <p>See “Viewing Budget Details and Transaction Activity” (PeopleSoft Commitment Control).</p>
Currency	<p>Displays the currency code for the encumbrance amount at the distribution level of the purchase order. The code is in the currency of the default commitment control ledger group for the distribution level General Ledger business unit.</p>
Encumbered Base Balance	<p>When commitment control is on, the system displays the encumbrance balance in base currency.</p>
Base Currency	<p>When commitment control is on, the system displays the base currency of the encumbrance balance.</p>

Field or Control	Description
Expensed To Date	Displays the amount reflects the total expensed to date, not the remaining expense balance. This creates a relationship to the encumbrance balance.
Commitment Control Close Flag	Displays as selected when the purchase order associated with the requisition has been fully liquidated, thus indicating that the outstanding pre-encumbrance has also been fully liquidated. This option can also display as selected when the distribution has been canceled.
	Click the Cancel Distribution button to cancel the distribution. If the distribution that you cancel is sourced from a requisition, the system prompts you to see whether you want to increase the open requisition quantity and allow the requisition quantity to be re-selected. To cancel a distribution, you must have the proper authorization defined on the User Preferences - Procurement: Purchase Order Authorizations page.

Related Links

[Close Purchase Orders Page](#)

“Understanding PeopleSoft ChartFields” (Application Fundamentals)

“Defining SpeedCharts” (PeopleSoft Source to Settle Common Information)

[Define Accounting Tag](#)

PO Distribution Worksheet Page

Use the PO Distribution Worksheet Page (PO_SPLIT_DIST) to split PO distribution lines and maintain total split quantity to that of original line distribution quantity and add chartfields of your choice.

These split distribution lines are available on the PO Distribution page with the same requisition information.

Navigation:

Purchasing > Purchase Orders > Add/Update POs > Maintain Purchase Order - Purchase Order

Click the Schedules button on the Maintain Purchase Order - Purchase Order page.

Click the Distributions/ChartFields button from the Maintain Purchase Order - Schedules page. Click on the PO Distribution worksheet icon on the Req Details Tab.

This example illustrates the fields and controls on the PO Distribution Worksheet Page. You can find definitions for the fields and controls later on this page.

Split PO Distribution 1

Unit: US001		Req BU: US001
PO ID: 0000000263		Req ID: 0000000158
Line: 1		Req Line: 1
Schedule: 1		Req Sched: 1
Distribution: 1		Req Dist: 1

Distribute By: Qty Distrib Percent: 100.0000 Purchase Order Quantity: 10.0000 Merchandise Amount: 200.00 USD

Split Distributions										
Sequence	PO Qty	Merchandise Amt	*Account	Alt Acct	Oper Unit	Dept	Product	Class	Program	Bt
1	2.0000	40.00	500000			42000				
2	2.0000	40.00	500000			14000				
3	2.0000	40.00	500000			20000				
4	2.0000	40.00	500000			14000				
5	2.0000	40.00	500000			20000				

Users can perform several actions like adding, deleting lines and modifying the chartfields.

Note: The Amount field will be enabled only if the distribution method is amount, making the quantity field hidden. If the distribution method is quantity then user can split using quantity and the amount field is grayed out.

The PO Distribution Worksheet functionality is also applicable for the Express PO page and Maintain Distributions page.

Sales/Use Tax Details for Distribution Page

Use the Sales/Use Tax Details for Distribution page (PO_DISTRIB_SUT) to view sales and use tax information pertaining to this purchase order distribution.

Navigation:

Click the **Sales/Use Tax Information** button next to a distribution line on the Maintain Purchase Order - Distributions for Schedule page.

Select the **Details/Tax** tab.

Sales/Use Tax Information

<i>Field or Control</i>	<i>Description</i>
SUT Code Pct (SUT code percent)	This is the sum of the percentage rates of all the tax authorities contained within the selected SUT tax code.

VAT Details for Distribution Page

Use the VAT Details for Distribution page (PO_DISTRIB_VAT) to review the VAT details for this distribution and change the VAT transaction type.

Navigation:

Click the **Distrib VAT** button next to a distribution line on the Maintain Purchase Order - Distributions for Schedule page.

Select the **Details/Tax** tab.

VAT Controls

<i>Field or Control</i>	<i>Description</i>
Use Type	<p>Displays the use type entered on the schedule line, which determines the split between recoverable (taxable) and non-recoverable (non-taxable) VAT.</p> <p>For the Canadian public sector, the use type also determines the rebate of the non-recoverable VAT. VAT rebates are calculated based on statutory rebate rates that are established for each public service body.</p> <p>The value comes from the VAT defaulting hierarchy, either from the item, item business unit, item category, supplier location, supplier, or purchasing options.</p>
Apportionment Control	<p>Business unit that you want to use to retrieve VAT apportionment information for the distribution line. This value appears by default from the Purchasing business unit VAT driver in the VAT defaults table.</p> <p><i>Dist GL BU</i> (distribution general ledger business unit).</p> <p><i>TXN BU</i> (transaction business unit).</p> <p><i>TXN GL BU</i> (transaction general ledger business unit).</p>
Recovery Source	<p>Select whether the VAT recovery is <i>Automatic</i> or <i>Manual</i>. This value appears by default from the Purchasing business unit. If you select manual, enter a value in the VAT Recovery Percent field.</p>
Rebate Source	<p>Select whether the VAT rebate is <i>Automatic</i> or <i>Manual</i>. This value appears by default from the Purchasing business unit. If you select manual, enter a value in the VAT Rebate Percent field.</p>

Note: The **Recovery Source** and **Rebate Source** fields are only available when you select the **Allow Override Recovery/Rebate** option on the Purchasing Options VAT driver in the VAT defaults table.

VAT Treatments

Use this group box to review the VAT treatment for the distribution line.

<i>Field or Control</i>	<i>Description</i>
Treatment	Displays the VAT treatment. The value is copied from the schedule line.

VAT Details

Use this group box to review and change the VAT transaction type for the distribution line.

<i>Field or Control</i>	<i>Description</i>
Transaction Type	Displays the code that categorizes and classifies this transaction for VAT reporting and accounting. The value is copied from the schedule line, but you can override the default.

VAT Calculations

Use this group box to review the VAT calculations for the distribution line.

<i>Field or Control</i>	<i>Description</i>
Transaction Amount	Displays the amount of the transaction in the transaction currency.
Transaction Amount Base	Displays the amount of the transaction in the base currency.
Basis Amount	Displays the amount on which the VAT is calculated in the transaction currency. If VAT is being calculated at net, this amount is net of any discounts.
Basis Amount Base	Displays the amount on which the VAT is calculated in the base currency. If VAT is being calculated at net, this amount is net of any discounts.
Tax Rate	Displays the applicable VAT percentage.

Field or Control	Description
Recorded Amount	Displays the calculated VAT amount that is recorded for this transaction in the transaction currency.
Recorded Amount Base	Displays the calculated VAT amount that is recorded for this transaction in the base currency.
Recovery Percent	If recovery percent source is set to <i>Manual</i> , enter the recovery percent.
Rebate Percent	If rebate percent source is set to <i>Manual</i> , enter the rebate percent.
Recovery Amount	The amount of VAT that is recoverable in transaction currency.
Recovery Amount Base	The amount of VAT that is recoverable in base currency.
Rebate Amount	The amount of VAT that is available as a rebate in transaction currency.
Rebate Amount Base	The amount of VAT that is available as a rebate in base currency.
Recalculate	Click this button to recalculate the VAT for the line.

Related Links

“User Preferences – Purchase Order User Authorizations Page” (Application Fundamentals)
[Preparing PeopleSoft Purchasing VAT Environments](#)

Maintain Distributions Page

Use the Maintain Distributions page (PO_CF_DTLS) to enter distribution information directly which enables you to maintain a purchase order distribution directly without accessing the Maintain Purchase Order - Schedules page first.

Navigation:

Purchasing > Purchase Orders > Maintain Distributions

Field or Control	Description
	<p>Click the PO Distribution Worksheet icon to access the PO Distribution Worksheet page, where you can split PO distribution lines and maintain total split quantity to that of original line distribution quantity and add chartfields of your choice.</p> <p>The distribution lines that are split using PO Distribution Worksheet are available on the PO distribution page with the same requisition information.</p> <p>See PO Distribution Worksheet Page</p>
Budget Status	If commitment control is on, the system displays whether or not this distribution has been budget checked.
Final	<p>Select this check box to indicate that the purchase order distribution is final and, thus, can be liquidated. The system checks the current purchase order distributions for its predecessor requisition distribution. If the associated requisition has been finalized, the system disassociates the requisition from the purchase order before budget checking so that the pre-encumbrance is not over liquidated.</p> <p>If multiple purchase order distribution lines are associated to the same requisition distribution line, the system only finalizes one requisition distribution line.</p> <p>The system does not display this check box if commitment control is off or if the purchase order is not sourced from a requisition, and thus has no predecessor.</p>

Note: If you identify a distribution line as final for less, you must run budget checking afterwards.

Canceling a Purchase Order Online

This section discusses how to Cancel a Purchase Order Online:

Pages Used to Cancel a Purchase Order Online

Page Name	Definition Name	Usage
Maintain Purchase Order - Purchase Order Page	PO_LINE	Cancel a purchase order.

Page Name	Definition Name	Usage
Maintain Purchase Order - Cancel Purchase Order Page	PO_BUDG_CHECK	Displays whether a purchase order was successfully canceled and if a purchase order requires budget checking gives you the ability to initiate the budget checking process. Plus, if the purchase order was previously dispatched this page gives you additional instructions on how to complete the cancel process.
Maintain Purchase Order - Cancel Purchase Order Page	PO_CANCEL_RSLT	Make available the requisition quantities that are associated with the purchase order you are canceling so that they can be sourced again at a later date or this page displays the error messages giving you the reasons why the purchase order cannot be canceled.
Commitment Control Page	KK_EXCPTN_OVER_SEC	View details about a commitment control transaction, such as the source transaction type and the amount type for the journal. You can also override budget checking for the transaction or run the Comm Cntrl Budget Processor for the transaction. Maintain Purchase Order - Cancel Purchase Order Page

Related Links

[Purchase Order Cancellation](#)

[Understanding the Buyer's Workbench](#)

Maintain Purchase Order - Purchase Order Page

Use the Maintain Purchase Order - Purchase Order page (PO_LINE) to cancel a purchase order.

Navigation:

Purchasing > Purchase Orders > Add/Update POs > Maintain Purchase Order - Purchase Order

This example illustrates the fields and controls on the Maintain Purchase Order - Purchase Order page. You can find definitions for the fields and controls later on this page.

Maintain Purchase Order

Business Unit: US003 PO Status: Pend Appr
 PO ID: 0000000016 Budget Status: Not Chkd
 Copy From: [Dropdown] Hold From Further Processing

Header

*PO Date: 04/14/2020 Supplier Search
 *Supplier: BERNIE'S-001 Supplier Details
 *Supplier ID: SCM0000004 BERNIE'S BIKE SHOP
 *Buyer: VP1 Kenneth Schumacher
 PO Reference: [Text Field]

Doc Tol Status: Valid
 Receipt Status: Not Recvd
 Priority: Medium
 *Dispatch Method: Print

Amount Summary

Merchandise	1,760.00
Freight/Tax/Misc.	0.00
Total Amount	1,760.00 USD

Add Items From

Catalog Purchasing Kit Item Search

Lines

Line	Item	Description	PO Qty	UOM	Category	Price	Merchandise Amount	Status
1	10000	Long Sleeve Biking	80,000	EA	CYCLING	22.00000	1,760.00	Pending

View Printable Version View Approvals *Go to [Dropdown]

Field or Control	Description
	<p>Click the Cancel PO button to cancel the entire purchase order. When you click this button, you are prompted to confirm that you want to cancel the purchase order.</p> <p>If the purchase order references a request for quote (RFQ), you are prompted with a message to decrease the RFQ order quantity. If you decrease the ordered quantity, that quantity becomes available to be awarded to another supplier. If you do not decrease the award quantity, the quantity is not available to be awarded on another purchase order.</p> <p>You are also prompted to change the requisition quantity, so that it can be sourced again.</p> <p>If you don't have the authority to cancel a purchase order, the Cancel PO button is not available. Set up the authority to cancel a purchase order on the User Preferences - Procurement: Purchase Order Authorizations page.</p> <p>If the purchase order has already been dispatched to the supplier, the system navigates to the Maintain Purchase Order - Cancel Purchase Order page which contains additional instructions regarding the need to budget check the purchase order again (if commitment control is engaged) and to re-dispatch the purchase order.</p> <p>If you cancel a purchase order that is associated to a recurring purchase order voucher contract, the system changes the status of the contract to <i>Hold</i>. You can then copy the contract into a new contract if necessary.</p> <hr/> <p>Note: When a purchase order has an authored contract document associated to it, certain changes that occur when closing the purchase order could affect the authored document. You should contact the contract specialist or the buyer in case they need to update or amend the authored document as needed.</p> <hr/>

Related Links

“Understanding Source Transaction Type Setup” (PeopleSoft Commitment Control)
[Understanding Commitment Control in PeopleSoft Purchasing](#)

Maintain Purchase Order - Cancel Purchase Order Page

Use the Maintain Purchase Order - Cancel Purchase Order page (PO_BUDG_CHECK) to displays whether a purchase order was successfully canceled and if a purchase order requires budget checking gives you the ability to initiate the budget checking process.

Plus, if the purchase order was previously dispatched this page gives you additional instructions on how to complete the cancel process.

Navigation:

Click the **Cancel PO** button on the Maintain Purchase Order - Purchase Order page and then click the **Yes** button when you receive the cancellation confirmation message.

Click the **Continue** button on the Maintain Purchase Order - Cancel Purchase Order page after selecting the requisition resourcing option for a purchase order that was sourced from a requisition.

This example illustrates the fields and controls on the Maintain Purchase Order - Cancel Purchase Order page. You can find definitions for the fields and controls later on this page.

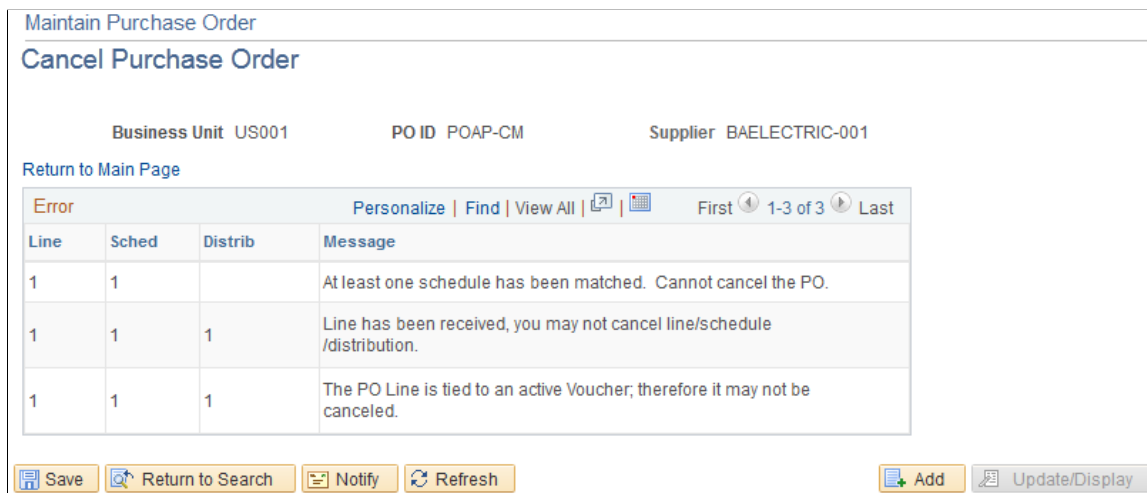

If the system determines a purchase order cannot be canceled, messages will appear on this page giving you the reasons why you cannot cancel a purchase order.

Maintain Purchase Order - Cancel Purchase Order Page

Use the Maintain Purchase Order - Cancel Purchase Order page (PO_CANCEL_RSLT) to make available the requisition quantities that are associated with the purchase order you are canceling so that they can be sourced again at a later date or this page displays the error messages giving you the reasons why the purchase order cannot be canceled.

Navigation:

Click the **Cancel PO** button on the Maintain Purchase Order - Purchase Order page for a purchase order that has been sourced from a requisition and then click the **Yes** button when you receive the cancellation confirmation message.

Click the **Continue** button after selecting the resourcing option for a purchase order that was sourced from a requisition on the Maintain Purchase Order - Cancel Purchase Order page.

This example illustrates the fields and controls on the Maintain Purchase Order - Cancel Purchase Order page. You can find definitions for the fields and controls later on this page.

Maintain Purchase Order
Cancel Purchase Order

Business Unit US001 PO ID 0000000101 Supplier BIKE-001

Would you like to open the Requisition quantity(ies) to be sourced again?

Yes, Re-Source all Reqs
 No, Do Not Re-Source Reqs
 Specify Reqs to Re-source

Requisitions Available for Re-Sourcing Personalize | Find | View All | [?] | [📅] First 1-20 of 24 Last

Re-Source Requisition?	Line Number	Schedule	Requisition ID	Requisition Line	Requisition Schedule
<input checked="" type="checkbox"/>	1	1	0000000128	1	1
<input checked="" type="checkbox"/>	1	2	0000000128	1	2
<input checked="" type="checkbox"/>	2	1	0000000128	3	1
<input checked="" type="checkbox"/>	2	2	0000000128	3	2

Field or Control	Description
Yes, Re-Source all Req (yes, re-source all requisitions)	Select this option to re-source all requisition quantities associated with the purchase order.
No, Do Not Re-Source Reqs (no, do not re-source requisitions)	Select this option if you do not want to re-source all requisition quantities associated with the purchase order.
Specify Reqs to Re-source (specify requisitions to re-source)	Select this option if you want to specify which requisitions associated with the purchase order that you want to re-source the quantities for. When you select this option the Requisitions Available for Re-Sourcing group box appears displaying all of the requisitions that are associated with the purchase order you are canceling.
Re-Source Requisition?	Select this check box next to each individual requisition and line that you want to re-source.
Continue	Click this button to have the system re-source the requisition quantities and continue on with the cancelation process.

Maintain Purchase Order - Cancel Purchase Order Page

Use the Maintain Purchase Order - Cancel Purchase Order page (PO_BUDG_CHECK) to displays whether a purchase order was successfully canceled and if a purchase order requires budget checking gives you the ability to initiate the budget checking process.

Plus, if the purchase order was previously dispatched this page gives you additional instructions on how to complete the cancel process.

Navigation:

Click the **Cancel PO** button on the Maintain Purchase Order - Purchase Order page and then click the **Yes** button when you receive the cancellation confirmation message.

Click the **Continue** button on the Maintain Purchase Order - Cancel Purchase Order page after selecting the requisition resourcing option for a purchase order that was sourced from a requisition.

This example illustrates the fields and controls on the Access the Maintain Purchase Order - Cancel Purchase Order page. You can find definitions for the fields and controls later on this page.

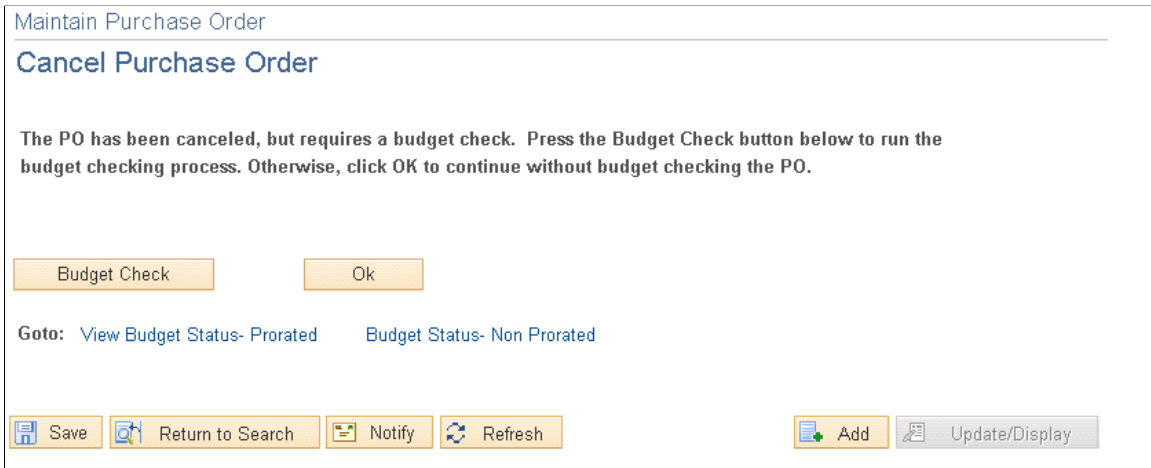

Field or Control	Description
Budget Check	Click this button to run the budget checking process for this purchase order. This button is available if commitment control is enabled for PeopleSoft Purchasing.
Ok	Click this button to continue with the cancelation of the purchase order without budget checking the purchase order.
View Budget Status - Prorated and View Budget Status - NProrated	Click these links to access the Commitment Control page where you can view details about a commitment control transaction, such as the source transaction type and the amount type for the journal. You can also override budget checking for the transaction or run the Comm Cntrl Budget Processor process for the transaction.

Related Links

[Understanding Commitment Control in PeopleSoft Purchasing](#)

“Understanding Source Transaction Type Setup” (PeopleSoft Commitment Control)

Using Express Purchase Orders

This section discusses how to enter express purchase orders.

Pages Used to Enter Express Purchase Orders

Page Name	Definition Name	Usage
<u>Express Purchase Order - Purchase Order Page</u>	PO_EXPRESS	Enter purchase orders using a <i>rapid-entry</i> version of the Maintain Purchase Order - Purchase Order page, where you can view line, schedule, and distribution information all on one page. However, when using the Express Purchase Order - Purchase Order page, you cannot distribute by amount or allocate header miscellaneous charges.
<u>Pegging Workbench Page</u>	IN_PEG_DETAIL_SP	Apply, change, or remove pegs from items.
<u>Pegging Inquiry Page</u>	IN_PEG_DETAIL_SP	View pegging information for line items.

Express Purchase Order - Purchase Order Page

Use the Express Purchase Order - Purchase Order page (PO_EXPRESS) to enter purchase orders using a rapid-entry version of the Maintain Purchase Order - Purchase Order page, where you can view line, schedule, and distribution information all on one page.

However, when using the Express Purchase Order - Purchase Order page, you cannot distribute by amount or allocate header miscellaneous charges.

Navigation:

Purchasing > Purchase Orders > Add/Update Express POs > Express Purchase Order

This example illustrates the fields and controls on the Express Purchase Order. You can find definitions for the fields and controls later on this page.

The screenshot shows the 'Express Purchase Order' form. At the top, it displays 'Business Unit US001' and 'PO Status Initial'. Below this, there are fields for 'PO ID NEXT' and a 'Copy From' dropdown menu. A 'Hold From Further Processing' checkbox is also present. The 'Header' section includes fields for '*PO Date' (10/07/2016), '*Supplier', '*Supplier ID', and '*Buyer' (VP1). There are links for 'Supplier Search', 'Supplier Details', and 'Kenneth Schumacher'. An 'Amount Summary' table is shown with columns for 'Merchandise', 'Freight/Tax/Misc.', and 'Total Amount', all with values of 0.00. The 'Total Amount' is listed as 0.00 USD. A 'Calculate' button is next to the table. Below the summary, there are links for 'Header Details', 'Activity Summary', 'PO Defaults', 'Add Comments', 'PO Activities', 'Add ShipTo Comments', and 'Federal Award Data'. The 'Add Items From' section has 'Catalog' and 'Item Search' options. The 'Lines' table has columns for 'Line', 'Item', 'Description', 'PO Qty', '*UOM', 'Category', 'Merchandise Amt', and 'Status'. The first line is visible with a quantity of 1 and a status of 'Approved'. There are also 'Expand All', 'Collapse All', and 'View Printable Version' options at the bottom.

This example illustrates the fields and controls on the Express Purchase Order — Purchase order (Page 2 of 2). You can find definitions for the fields and controls later on this page.

This is a close-up of the 'Add Items From' section. It shows three tabs: 'Purchasing Kit', 'Catalog', and 'Item Search'. Below the tabs is a table with columns: 'Line', 'Item', 'Description', 'PO Qty', '*UOM', 'Category', 'Merchandise Amt', and 'Status'. The first row shows 'Line 1', 'Item', 'Description', 'PO Qty', '*UOM', 'Category', 'Merchandise Amt 0.000', and 'Status Approved'. There are search icons and a 'Find' button. At the bottom, there are 'Expand All', 'Collapse All', 'View Printable Version', and 'Go to ... More ...' options.

This page is divided into areas that are similar to the Maintain Purchase Order - Purchase Order page.

Refer to the Maintain Purchase Order - Purchase Order page for the descriptions of the links, buttons, and fields on the Express Purchase Order - Purchase Order page.

Refer to [Federal Award Data page](#) for descriptions on the Federal Award Data page.

Refer to [PO Distribution Worksheet Page](#) for descriptions of distributions work sheet page.

Note: You can also create authored documents for express purchase orders the same as purchase orders. After you create a authored document for an express purchase order, the page provides information about the document and a **Maintain Document** button where you can view, edit, and maintain the document's attributes, collaboration, and approval details.

Related Links

[Creating Purchase Order Headers](#)

[Creating Purchase Order Lines](#)

[Creating Purchase Order Schedules](#)

[Canceling a Purchase Order Online](#)

Using Purchase Order Acknowledgements

This section provides overviews of the purchase order acknowledgement (POA) business process and the Electronic Data Exchange POA business process

Pages Used to Use Purchase Order Acknowledgements

<i>Page Name</i>	<i>Definition Name</i>	<i>Usage</i>
Manage PO Acknowledgements Page	PO_SS_POA_SEARCH	Select the POAs that you want to review by using the selection criteria on this page. When you use the search page, only values associated with POAs appear. Select a value from the search results to view the POA on the Manage PO Acknowledgements page.
Manage PO Acknowledgements - Header Page	PO_POA_HDRERR_STG	View header and line detail for purchase order acknowledgements associated with the entered search criteria.
Maintain Purchase Order - Purchase Order Page	PO_LINE	Modify the original purchase order. Manage PO Acknowledgements - Header Page
Acknowledgement Header Details Page	PO_POA_HDR_COMPARE	Compare the header of a purchase order acknowledgement with the header of the corresponding purchase order. You can make corrections to the acknowledgement. Manage PO Acknowledgements - Header Page
Acknowledgement Line Details Page	PO_POA_LN_COMPARE	Compare the lines of a purchase order acknowledgement with the lines of the corresponding purchase order. You can make corrections to the acknowledgement.
Manage PO Acknowledgements - Schedule Page	PO_POA_SHPERR_STG	View schedule detail for purchase order acknowledgements.
Acknowledgement Schedule Details Page	PO_POA_SHP_COMPARE	Compare the schedules for a purchase order acknowledgement line with the schedules for the corresponding purchase order line. You can make corrections to the acknowledgement.

Page Name	Definition Name	Usage
PO ShipTo Address Page	PO_SHIPTO_ADDR	View the purchase order ship to address information. Acknowledgement Schedule Details Page

Understanding the POA Business Process

The POA functionality in PeopleSoft is shared between PeopleSoft Purchasing and PeopleSoft eSupplier Connection. The buyer side of the POA functionality is addressed in PeopleSoft Purchasing where as the supplier side of the POA functionality is addressed in PeopleSoft eSupplier Connection.

Transaction flow leading to the Close Purchase Orders process

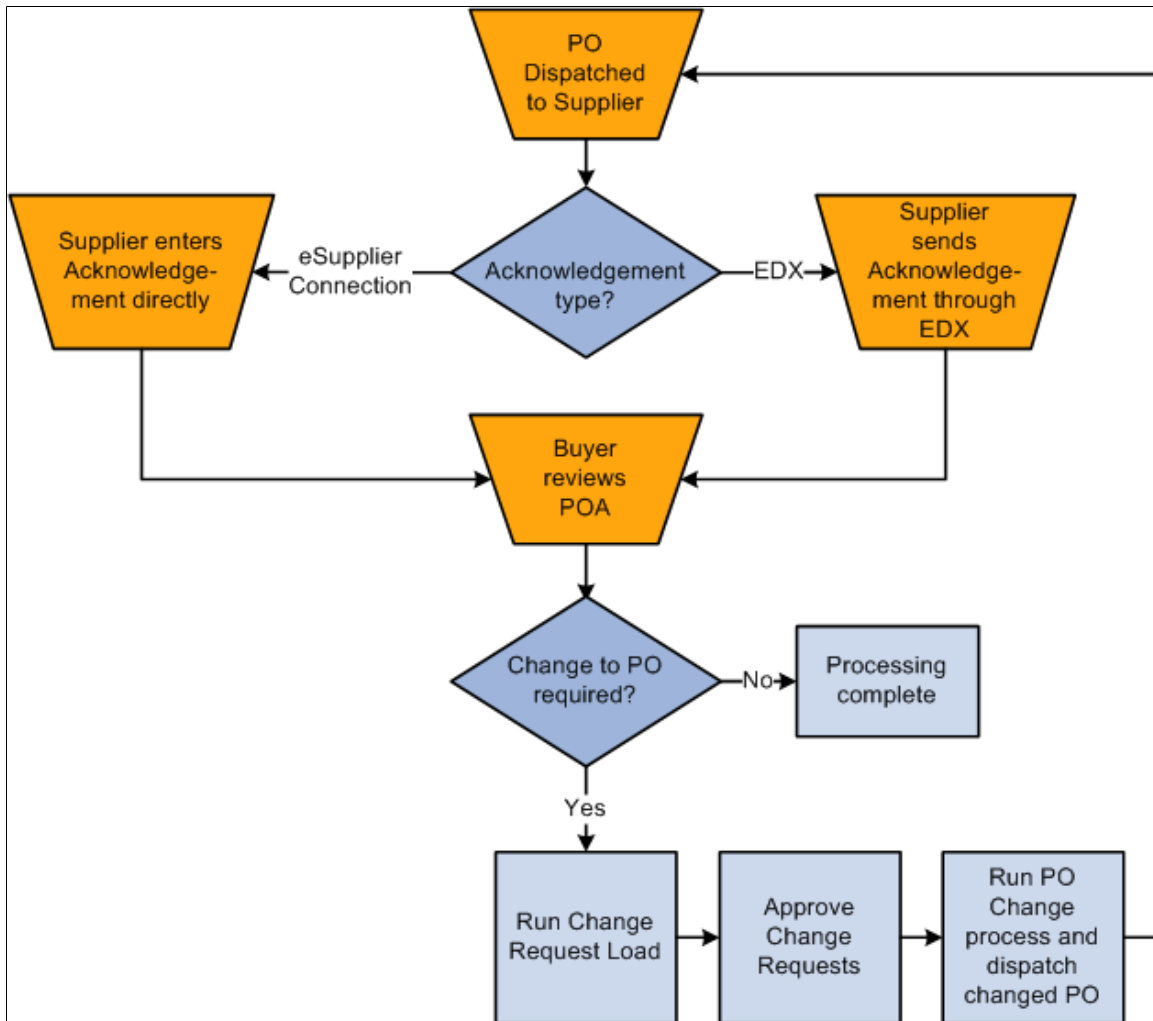

PeopleSoft enables you to create POAs using these methods:

- Supplier creates a POA online using the Acknowledge Purchase Orders component in PeopleSoft eSupplier Connection.

See “Understanding Online POAs” (PeopleSoft eSupplier Connection).

See “Creating Online POAs (Suppliers)” (PeopleSoft eSupplier Connection).

- Supplier creates a POA using an electronic data exchange (EDX) system.

The EDX Acknowledgements component in PeopleSoft Purchasing enables you to move back and forth between the purchase order and EDX POA to make any necessary changes and correction to either document.

See [Understanding the Electronic Data Exchange POA Business Process](#).

- Buyer creates a POA online for the supplier using the Manage PO Acknowledgements component in PeopleSoft Purchasing.

The buyer can create a POA on behalf of the supplier by using the awaiting acknowledgement option on the Manage PO Acknowledgements page.

See “Reviewing and Approving Online POAs (Buyers)” (PeopleSoft eSupplier Connection).

See “Responding on Behalf of the Supplier (Buyers)” (PeopleSoft eSupplier Connection).

Understanding the Electronic Data Exchange POA Business Process

PeopleSoft enables you to view information from a POA that you received from a supplier using an electronic data exchange (EDX) system, and compare it to the original purchase order. You can compare the purchase order and POA at the header, line, and schedule levels.

The EDX Acknowledgements component enables you to move back and forth between the purchase order and POA to make any necessary changes and corrections to either document.

Note: If the installation includes PeopleSoft eSupplier Connection, the suppliers can also enter their POAs directly into the system. The search page shows both EDX received POAs and any created by the suppliers online using PeopleSoft eSupplier Connection. You view online POAs using PeopleSoft eSupplier Connection pages.

The EDX POA business process follows these general steps:

1. The purchase order is dispatched to the supplier.
2. The supplier creates an EDX acknowledgement identifying any changes as appropriate.

Note: It is important if there are changes to any lines or header values that the status within the EDX file is set appropriately to a status that indicates there is a change (such as IC—accepted with changes). This status triggers the status in which the EDX POA starts. If there are no changes to the POA, (the status for all lines and the header row are AT) the status is automatically set to *Buyer Accepted* since there is nothing for the buyer to approve. However, in order to avoid processing an entire change order without any approvals, if the status is set incorrectly indicating no changes, and there were changes the change order stops between the load change request and process change order step and waits for an approval from the buyer using the Approve Change Orders transaction.

Note: A workflow option is included which sends notification to the buyer when an EDX POA specifying changes is received. To enable this workflow, activate the event Alert Buyer within activity PO_ACKNOWLEDGEMENT; this adds worklist entries for the buyer user associated to the purchase order that links to the buyer side PO Acknowledgement search page.

Note: If using POA tolerances defined at the supplier location or at the purchasing business unit options, if a supplier sends an EDX in with changes that are within those tolerances the POA will be set to approved automatically and step 3 below will be skipped.

3. The buyer uses the Acknowledge Purchase Orders component in PeopleSoft Purchasing to view EDX POAs that need an approval, and can:
 - a. Review the changes suggested by the supplier.
 - b. Approve a POA.

The POA can be changed at any time before you run the Change Request Load process. Once the process runs, the POA is display only. Approved POAs feed suggested changes such as quantity, price, and schedule date into the Change Request Load tables, which when approved, update the original purchase order.

Note: You can set up automatic approval for POA change requests on the Purchasing Definitions - Business Unit Options page. Once approved using the Purchase Order Acknowledgement pages, the changes won't need to be approved again between the Load Change Request and Process Change Orders processes. (The only exception to this, is if for some reason the EDX POA changes, but the status on the header or lines use the *Accepted* status (indicating no change). In order to avoid processing something that hasn't been approved, these orders are forced to stop for approval between the Change Request and Change Order processes.

4. You can run the Load Change Requests process (PO_CHNGLOAD) to load any POAs that are in *Buyer Accepted* status.
5. The buyer must approve any change request changes using the Approve Change Requests transaction, if the business unit option to approve POA change requests automatically is not activated.
6. The Process Change Orders process (PO_POCHNG) then loads any POAs that have been approved, either manually or because of the automatic approval option set at the business unit level, and updates the purchase order with the changes.

Note: Running the Process Change Orders Automatically process (PO_AUTO_CHNG) does Steps 4 through 6 all in one process run.

Manage PO Acknowledgements Page

Use the Manage PO Acknowledgements page (PO_SS_POA_SEARCH) to select the POAs that you want to review by using the selection criteria on this page.

When you use the search page, only values associated with POAs appear. Select a value from the search results to view the POA on the Manage PO Acknowledgements page.

Navigation:

Purchasing > Purchase Orders > Acknowledgements > Manage PO Acknowledgements

Note: When a purchase order has an authored contract document associated to it, certain changes here could affect the authored document. You should contact the contract specialist or the buyer in case they need to update the document.

Select the criteria with which to filter the search.

Field or Control	Description
From Date and To Date	Select the purchase order dispatch date range.
Current Acknowledgements	Select the status option of the POAs you want to search on. Values are: <ul style="list-style-type: none"> • <i>Awaiting Acknowledgement</i>: POAs that are pending a supplier response. • <i>Supplier Responded</i>: POAs that the supplier has submitted and are pending a buyer review. • <i>Buyer Accepted</i>: POAs that have already been approved.
View History	Select this option to display the supplier responded history for past POAs.
PO Status	Displays the change order revision if the line is a change order; otherwise, it indicates that the purchase order is being dispatched for the first time.
Source of Acknowledgement	Displays the source of the acknowledgement. Values are: <i>Online</i> or <i>EDX</i> . POAs created using PeopleSoft eSupplier Connection POAs are always created with a source of online. Within PeopleSoft Purchasing, online and EDX POAs are consolidated for review and approval on this page. Depending on the source of the POA, click the purchase order number to navigate the buyer to the Manage PO Acknowledgements page for online collaborative POAs or the Manage PO Acknowledgements - Header page for EDX which is not collaborative. See "Understanding Online POAs" (PeopleSoft eSupplier Connection).

Manage PO Acknowledgements - Header Page

Use the Manage PO Acknowledgements - Header page (PO_POA_HDRERR_STG) to view header and line detail for purchase order acknowledgements associated with the entered search criteria.

Navigation:

Purchasing > Purchase Orders > Acknowledgements > Manage PO Acknowledgements

Select the appropriate POA from the **PO Acknowledgement List** group boxes.

PO Header Details

<i>Field or Control</i>	<i>Description</i>
EIP Control ID (enterprise integration point control identifier)	Displays the identifier assigned to the acknowledgement.
Acknowledge Date (acknowledgement date)	Select the date on which the acknowledgement was created.
Received	Select the date on which the acknowledgement was received.
Reviewed	Select this check box to indicate that you reviewed the acknowledgement. The user ID and the current date appear. This value appears within the Approve Change Requests component to help identify those POAs that have been reviewed.
Acknowledgement Status	<p>Select the status for the POA header information. You can override it here if necessary.</p> <p>If the header information changes, you must select one of these to enable a change request. Values are:</p> <p><i>Ack - With Detail and Change</i> (acknowledged with detail and change).</p> <p><i>Accepted - Changes Made.</i></p> <p><i>Ack - Exception Detail Only</i>(acknowledged exception detail only).</p> <p><i>Reject With Detail.</i></p> <p><i>Rej - Exception Detail Only</i>(reject - exception detail only).</p> <p><i>Rejected - No Detail.</i></p> <p><i>Rejected With Counter Offer.</i></p> <hr/> <p>Note: Line and schedule changes generate a change request based online status, regardless of header status.</p> <hr/>

Field or Control	Description
Approve	Click this button to approve the selected purchase order acknowledgement. This changes the status to <i>Buyer Accepted</i> and the Load Change Requests process picks up the EDX POA for processing. If the business unit option is set to approve change requests automatically, then you don't need to use the Approve Change Requests component to move the POA along to the final step of processing the change order.

Supplier Tab

Select the Supplier tab.

Field or Control	Description
GTIN (global trade identifier number))	Displays the universal product number for the item.

Links

Field or Control	Description
Edit the PO	Click this link to access the Maintain Purchase Order - Purchase Order page, where you can edit the original purchase order.
Compare Header	Click this link to access the Acknowledgement Header Details page, where you can compare POA header information with the purchase order header information.
Compare Line	Click this link to access the Acknowledgement Line Details page, where you can compare POA line information with the purchase order line information.

Related Links

[Maintain Purchase Order - Purchase Order Page](#)

[Reviewing and Approving Change Order Requests](#)

“Using Universal Item Identifiers” (PeopleSoft Managing Items)

Acknowledgement Header Details Page

Use the Acknowledgement Header Details page (PO_POA_HDR_COMPARE) to compare the header of a purchase order acknowledgement with the header of the corresponding purchase order.

You can make corrections to the acknowledgement.

Navigation:

Click the **Compare Header** link on the Manage PO Acknowledgements - Header page.

Header Details

The **Header Details** group box enables you to compare purchase order and POA header information. Acknowledgement information can be modified on the left and original purchase order information appears on the right.

Acknowledgement Line Details Page

Use the Acknowledgement Line Details page (PO_POA_LN_COMPARE) to compare the lines of a purchase order acknowledgement with the lines of the corresponding purchase order.

You can make corrections to the acknowledgement.

Navigation:

Click the **Compare Line** link on the Manage PO Acknowledgments - Header page.

Line Details

The **Line Details** group box enables you to compare purchase order and POA line information. Acknowledgement information can be modified on the left and original purchase order information appears on the right.

Manage PO Acknowledgements - Schedule Page

Use the Manage PO Acknowledgements - Schedule page (PO_POA_SHPERR_STG) to view schedule detail for purchase order acknowledgements.

Navigation:

Purchasing > Purchase Orders > Acknowledgements > Manage PO Acknowledgements

Select the appropriate POA from the **PO Acknowledgement List** group box.

Select the **Schedule** tab.

Schedule Tab

Select the **Schedule** tab.

If you want to compare an acknowledgement schedule with its corresponding purchase order schedule, select the **Sel** (select) check box and click the **Compare Schedule** link to access the Acknowledgement Schedule Details page.

Acknowledgement Schedule Details Page

Use the Acknowledgement Schedule Details page (PO_POA_SHP_COMPARE) to compare the schedules for a purchase order acknowledgement line with the schedules for the corresponding purchase order line.

You can make corrections to the acknowledgement.

Navigation:

Click the **Compare Schedule** link on the Manage PO Acknowledgements - Schedule page.

Schedule Details

The **Schedule Details** group box enables you to compare purchase order and POA schedule information. Acknowledgement information can be modified on the left and original purchase order information appears on the right.

Reviewing Purchase Order Acknowledgements Using the PeopleSoft Fluid User Interface

This topic discusses how to review both Online and EDX purchase order acknowledgements that are routed to a buyer by various suppliers.

Pages Used to Review POAs in the PeopleSoft Fluid User Interface

<i>Page Name</i>	<i>Definition Name</i>	<i>Usage</i>
<u>PO Acknowledgements Page</u>	PTPG_NUI_VWR	View the list of POAs that are pending review.
<u>Purchase Order Acknowledgements – Details Page</u>	SCP_POABUY_TRAN_FL	Review suppliers' response to the purchase orders and proceed with appropriate actions.
<u>POA History page</u>	SCP_POAB_HISTPG_FL	View acknowledgement history of purchase orders.

PO Acknowledgements Page

Use the PO Acknowledgements page (PTPG_NUI_VWR) to view the list of POAs routed to the buyer for review.

Navigation:

Select the **PO Acknowledgements** tile on the Procurement Operations Fluid Home page.

This example illustrates the fields and controls on the PO Acknowledgements page.

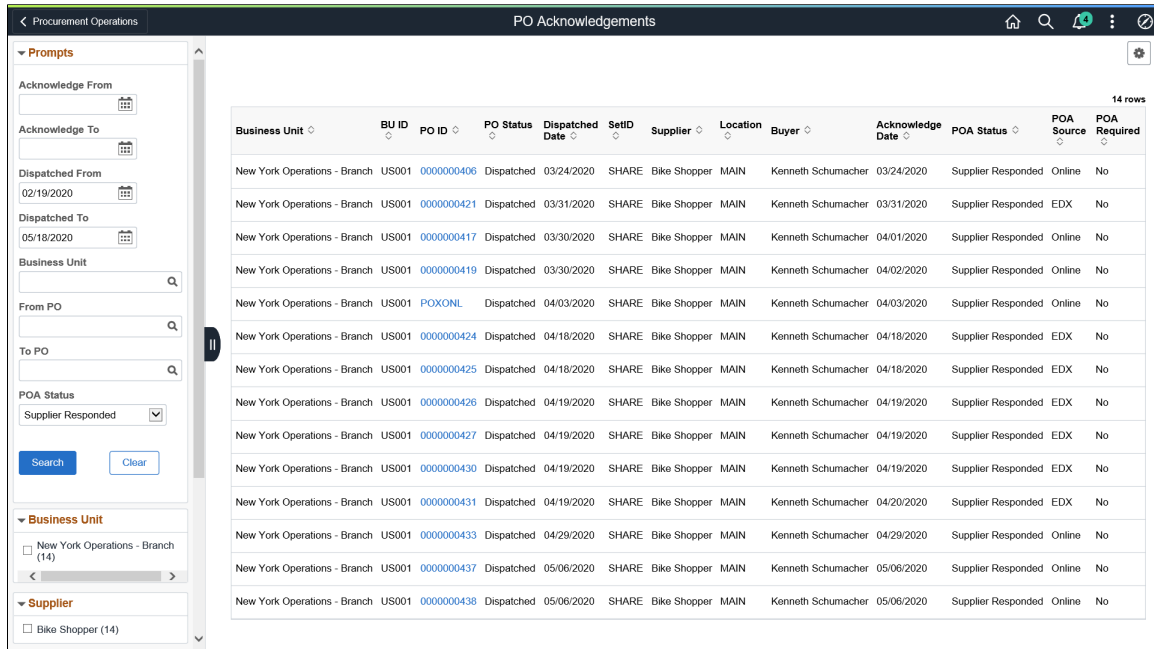

The left pane displays different filters that you can use to narrow down the POA list. By default, the page shows the purchase orders dispatched in the last 90 days. You can modify this setting by accessing the Procurement – PO Acknowledgements menu on the My Preferences page.

For more information about setting up user preferences, see [Procurement User Preferences - PO Acknowledgement Page](#).

Purchase Order Acknowledgements – Details Page

Use the Purchase Order Acknowledgements – Details page (SCP_POABUY_TRAN_FL) to review a supplier’s response to the selected purchase order and proceed with appropriate actions.

Navigation:

Select a purchase order on the PO Acknowledgements page.

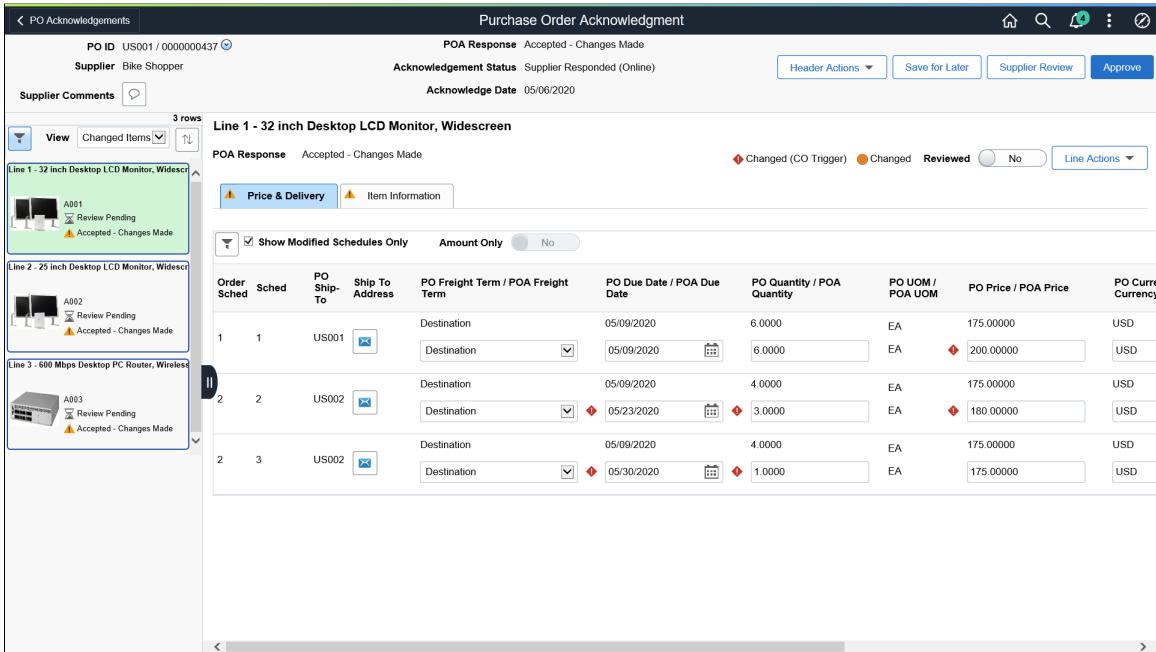

This example illustrates the fields and controls on the Purchase Order Acknowledgement – Details page. You can find definitions for the fields and controls later on this page.



The header displays the details, such as the PO ID, Supplier name, Supplier Comments, POA response, Acknowledgement Status, Acknowledge Date, and so on.

Field or Control	Description
 Related Actions icon	Click this icon to perform the following: <ul style="list-style-type: none"> • Print PO Document – Print the purchase order. • PO Business Unit Comments – Post any comments to the supplier. • PO Header Comments – Display any purchase order header comments or attachments associated with the selected purchase order. This action is available only when a comment or attachment is added. • Buying Organization Comments: View any comments that are associated to the buying organization (PeopleSoft Purchasing Business Unit). This action is available only when a comment is added.
Supplier Comments	Click to view the comments entered by the supplier and also to post any comments to the supplier.

The left pane lists the line items of the purchase order selected. Select an item to view its acknowledgement details.



Field or Control	Description
 Filter icon	Click to filter the list of purchase order lines based on: <ul style="list-style-type: none"> • Exclude Reviewed Lines • Item ID • Item Name • Supplier Item ID • Manufacturer ID • Manufacturer's Item ID • UPN Type Code • UPN ID
View	Displays the view option as defined on the User Preference page. The <i>Changed Items</i> option indicates that only the line items that have been modified by the supplier are listed. This helps you to directly review the changes and take necessary actions. The <i>All Items</i> option displays all the PO line items. For more information about setting up user preferences, see Procurement User Preferences - PO Acknowledgement Page .
 Change Indicator icon	This icon indicates that the supplier has modified the purchase order values during the acknowledgement process.

The right pane displays the details of the selected purchase order line on the **Price & Delivery** and **Item Information** tabs.

If the supplier modifies the purchase order values, an icon appears on the appropriate tab. By default, the focus is set to the tab with modified values. If both the tabs contain modified values, the Price & Delivery tab details are displayed first.

Price & Delivery tab

Field or Control	Description
Filter icon	Select this icon to filter the line items based on: <ul style="list-style-type: none"> • Status • PO Ship To • POA Ship To

Field or Control	Description
Show Modified Schedules Only	<p>This check box is selected by default so that you can quickly identify the modified schedules and review them. Deselect the check box to view all the schedules.</p> <p>If the schedules remain unchanged during the acknowledgement process, this check box is automatically cleared and displays all the schedules.</p>
Amount Only	Indicates that the purchase order line is an amount only line or not.
	Indicates that the supplier modifications to the PO values trigger a change order process. The tab displays both the original and modified values.
	Indicates that the supplier modifications to the PO values do not trigger a change order process.

Item Information tab

Select the Item Information tab to view the item details and acknowledgement information.

If the item details are not modified by the supplier, the tab displays all field values. In case of any changes to the item details, only those fields are displayed. Also, you can select or deselect the Show Modified Values Only check box to see the item information as required. The displayed values include Description, Acknowledge Value, PO Value, and Change Indicator.

The appearance of the Change Indicator varies based on the change type. If the supplier modification initiates a change order, it is *Changed (CO Trigger)*, else *Changed*.

After reviewing the POA details, you can perform the following actions to the line items:

Field or Control	Description
Reviewed	<p>Set the toggle button to <i>Yes</i> after your review is finished.</p> <p>In the left pane, the review status of the line item changes accordingly. When you revisit the page, you can use this button to filter only the line items that are pending review.</p>

Field or Control	Description
Line Actions	<p>Available only for Online POAs. To each line item, you can perform the following actions:</p> <ul style="list-style-type: none"> • Reset Item to PO values – Reset the POA values to the original purchase order values for renegotiating with the supplier. • Reject Item – Select this option to remove the item from your purchase order.

Besides the line actions, you can perform the following actions to the POA:

Field or Control	Description
Header Actions	<p>Includes the following:</p> <ul style="list-style-type: none"> • Header information – View additional header details such as EIP Control ID, PO Date, Acknowledge Date, Date Received, Reviewed, Reviewed On, and User ID. <p>For EDX POAs, in addition to the above values, the Compare Header section lists the Description, Acknowledge Value, PO value, and Change Indicator wherever applicable.</p> <p>The Change Indicator icon next to the Header Actions drop down and the Header Information option indicates any modification to the Compare Header section details.</p> <ul style="list-style-type: none"> • Reset to PO Values – Reset the POA values to the original PO values. You must confirm the action when the message displays. This option is available only for Online POAs. • Reject All Lines – Reject the line items for the selected PO. This option is available only for Online POAs. • POA History – View the acknowledgement history of the purchase order.
Save for Later	Click this button to save the POA and review it later.
Supplier Review	Click this button to send the POA back to the supplier for review through the Supplier Portal. This button is available only for Online POAs.

Field or Control	Description
Approve	<p>Click the Approve button to stage the POA for further processing, if the modifications are acceptable. Confirm the action in the displayed message.</p> <hr/> <p>Note: In the Save & Approve window, set the Run PO Auto-change to <i>Yes</i> to stage the acknowledgement changes and initiate a change order process. Else, set <i>No</i>. However, the approved POA can be further processed for Change order using a batch processes.</p>

POA History page

Use the POA History page (SCP_POAB_HISTPG_FL) to view the acknowledgement history of purchase orders. Acknowledgement summary is available for suppliers and buyers separately.

Navigation:

Select the POA History tile on the Procurement Operations Fluid Home page.

This example illustrates the fields and controls on the POA History page.

The screenshot shows the 'POA History' page with a table of 40 rows. The table columns are: Business Unit, PO Number, Dispatched Date/Time, PO Status, Responded Date/Time, Submitted by, Source of Acknowledgement, Buyer Name, Supplier SetID, Supplier ID, Short Supplier Name, Supplier Location, and View History. The data includes various PO numbers, dates, and statuses like 'Approved', 'Dispatched', and 'Change Order'.

Business Unit	PO Number	Dispatched Date/Time	PO Status	Responded Date/Time	Submitted by	Source of Acknowledgement	Buyer Name	Supplier SetID	Supplier ID	Short Supplier Name	Supplier Location	View History
US001	0000000428	04/19/2020 10:59:27PM	Approved	04/19/2020 11:08:41PM	Buyer	EDX	VP1 Kenneth Schumacher	SHARE	SCM0000001	BIKESHOPPE-001	MAIN	[View]
US001	0000000428	04/19/2020 10:59:27PM	Approved	04/19/2020 11:03:28PM	Supplier	EDX	VP1 Kenneth Schumacher	SHARE	SCM0000001	BIKESHOPPE-001	MAIN	[View]
US001	0000000432	04/20/2020 12:25:52AM	Approved	04/20/2020 12:32:01AM	Supplier	EDX	VP1 Kenneth Schumacher	SHARE	SCM0000001	BIKESHOPPE-001	MAIN	[View]
US001	0000000432	04/20/2020 12:25:52AM	Approved	04/20/2020 12:39:04AM	Buyer	EDX	VP1 Kenneth Schumacher	SHARE	SCM0000001	BIKESHOPPE-001	MAIN	[View]
US001	0000000406	03/24/2020 9:04:15PM	Dispatched	03/24/2020 9:37:12PM	Supplier	Online	VP1 Kenneth Schumacher	SHARE	SCM0000001	BIKESHOPPE-001	MAIN	[View]
US001	0000000407	03/26/2020 10:07:55AM	Change Order - 1	04/14/2020 9:43:21AM	Buyer		VP1 Kenneth Schumacher	SHARE	SCM0000001	BIKESHOPPE-001	MAIN	[View]
US001	0000000407	03/24/2020 9:39:39PM	Dispatched	03/26/2020 9:45:39AM	Buyer	Online	VP1 Kenneth Schumacher	SHARE	SCM0000001	BIKESHOPPE-001	MAIN	[View]
US001	0000000408	03/26/2020 10:15:35AM	Dispatched	03/26/2020 10:22:35AM	Buyer	Online	VP1 Kenneth Schumacher	SHARE	SCM0000001	BIKESHOPPE-001	MAIN	[View]
US001	0000000408	03/26/2020 10:15:35AM	Dispatched	03/26/2020 10:17:32AM	Buyer	Online	VP1 Kenneth Schumacher	SHARE	SCM0000001	BIKESHOPPE-001	MAIN	[View]
US001	0000000409	03/26/2020 10:16:20AM	Dispatched	03/26/2020 10:36:31AM	Buyer		VP1 Kenneth Schumacher	SHARE	SCM0000001	BIKESHOPPE-001	MAIN	[View]
US001	0000000410	03/26/2020 10:52:25AM	Dispatched	03/26/2020 10:54:31AM	Buyer		VP1 Kenneth Schumacher	SHARE	SCM0000001	BIKESHOPPE-001	MAIN	[View]
US001	0000000411	03/26/2020 11:00:11AM	Dispatched	03/26/2020 11:28:41AM	Buyer		VP1 Kenneth Schumacher	SHARE	SCM0000001	BIKESHOPPE-001	MAIN	[View]
US001	0000000412	03/26/2020 8:49:17PM	Dispatched	03/27/2020 12:14:47AM	Buyer		VP1 Kenneth Schumacher	SHARE	SCM0000001	BIKESHOPPE-001	MAIN	[View]

Select a purchase order to view its acknowledgement summary.

For more information, see “Manage PO Acknowledgements - Acknowledgement Summary Page” (PeopleSoft eSupplier Connection).

Creating and Viewing Purchase Order Backorders

This section discusses how to update the purchase order backorder status.

Suppliers can't always fulfill orders within the required time frames. You can now assign a backorder status, and the new quantity and delivery date information provided by the supplier to some or all of the purchase order schedules dispatched from PeopleSoft Purchasing when you know that they will not meet the specified delivery due date.

When you create a backordered line or schedule for a dispatched purchase order, the system changes the purchase order header **Backorder Status** field value from *None* to *Backorder*. The overall header, line, and schedule statuses remain the same (dispatched, active, and so forth).

The backorder status appears on these pages:

- Maintain Purchase Order - Purchase Order (PO_LINE).
- Maintain Purchase Order - Purchase Order Inquiry (PO_LINE_INQ).
- Line Details (PO_LINE_DTLS).
- Line Details Inquiry (PO_LINE_DTLS_INQ).
- Express Purchase Order - Purchase Order (PO_EXPRESS).
- Buyer's Workbench (PO_RC_WB).

Splitting Schedules and Distribution Lines

When a schedule is split due to a partial backorder, the system creates a new schedule for the remaining amount and identifies its original schedule number on these pages:

- **Create Backorder: Received and Matched** tab (PO_BACKORDER).
- Details for Schedule (PO_SCHED_DTLS_INQ).

When multiple distribution lines are associated with the split schedule, the system uses a last in first out (LIFO) method of associating distribution lines with the new schedule.

For example, suppose that the original purchase order schedule quantity is 100 and has two distribution lines with a quantity of 50 each, entering a partial backorder of 40 against the schedule results in a new schedule with a single distribution line. This distribution line references the same ChartField and distribution values as the original schedule distribution line two but with a quantity of 40. The original schedule still has two distribution lines, the first with a quantity of 50 and the second with an adjusted quantity of 10.

Note: Certain purchase order backorder changes (for example, creating a new schedule in response to a backorder or backordering the entire schedule quantity), do not automatically trigger a change order. However, depending on the purchase order change template settings, other modifications could trigger a change order.

Receiving Backordered Schedules

When you receive the backordered line or schedule, running the PO RECON (purchase order reconciliation) process (PO_PORECON) sets the backorder status to *BO Recv* (backorder received).

Viewing Backorder Details

Run the Backorder Status SQR report (POPO012) to view backorder details for a supplier, business unit, item, or buyer within user-defined date parameters.

Pages Used to Create and View Purchase Order Backorders

<i>Page Name</i>	<i>Definition Name</i>	<i>Usage</i>
Create Backorder Page	PO_BACKORDER	Apply backorder status, revised quantities, and delivery due dates to dispatched purchase order schedules.
Item Description Page	PO_BCKORD_ITM_DESC	Enter and view descriptions for a specific item. Create Backorder Page

Related Links

[Understanding the Close Purchase Orders Process](#)

[Purchase Order Header Status Values](#)

“Understanding Online POAs” (PeopleSoft eSupplier Connection)

“Creating Change Templates” (PeopleSoft Source to Settle Common Information)

Create Backorder Page

Use the Create Backorder page (PO_BACKORDER) to apply backorder status, revised quantities, and delivery due dates to dispatched purchase order schedules.

Navigation:

Purchasing > Purchase Orders > Create Backorders > Create Backorder

Note: Only purchase orders with a status of *Dispatched* are available for selection.

This section discusses how to:

- (Optional) Populate the page with current receipt and matching information.
- Apply backorder details to open purchase order schedules that have not been received.

(Optional) To populate the page with current receipt and matching information:

1. Select the impacted lines and schedules.
2. Click the **Get Received/Matched Quantity** button.

The system populates the **Received** and **Matched** fields with any received and matched quantities for the selected lines and schedules.

Note: When a purchase order has an authored contract document associated to it, certain changes here could affect the authored document. You should contact the contract specialist or the buyer in case they need to update the document.

To apply backorder details to a purchase order:

1. Select the impacted lines and schedules that the supplier has indicated will not be delivered by the due date.
2. Enter the backordered quantities for the selected lines and schedules:
 - Select **Apply Backorder to Open Quantity** check box to backorder the entire unreceived quantity.
 - Alternatively, enter a backordered quantity to backorder less than the quantity not received.
3. Enter due date for the selected lines and schedules:
 - Select a backorder due date in the default options. Using this field the system populates the **BO Due Date** (backorder due date) field for the selected schedules with the same expected arrival date. (You must first select the **Apply Backorder to Open Quantity** check box.)
 - Alternatively, enter the backorder due date for each backordered quantity by individual line and schedule.
4. Click the **Apply Backorder & Save** button.

If you have selected the **Apply Backorder to Open Quantity** check box:

- The system calculates and populates the **Backordered Qty** field with the open (unreceived) quantities.
- If you have also defined a backorder due date, the system populates the **Backorder Due Date** field for each individual line and schedule.
- For fully backordered schedules, the system:
 - Retains the originally scheduled quantity and schedule number.
 - It references itself as the schedule number that generated the backorder.
 - Updates the schedule due date.
 - Updates the purchase order header status to *Backorder*, and then clears the **Backorder Due Date** and **Backordered Qty** fields.
- For partially backordered schedules, the system:
 - Creates new schedules, and where appropriate, new distribution lines.
 - References the schedule number that generated the backorder.
 - Uses backorder due date and backordered quantity values to calculate revised due date and purchase order quantity values.

Updates the purchase order header status to *Backorder*, and then clears the **Backorder Due Date** and **Backordered Qty** fields.

Updating Purchase Orders With New Item Supplier UOM Conversion Rates

This section lists the page used to update purchase orders with the new item supplier UOM conversion rates.

Page Used to Update Purchase Orders With New Item Supplier UOM Conversion Rates

<i>Page Name</i>	<i>Definition Name</i>	<i>Usage</i>
Update Purchase Order Page	PO_EDUOM_UPDPO	Update existing purchase order schedules with the new effective-dated UOM conversion rate changes. This page is identical to the Update Purchase Order page that can be accessed from the Supplier's UOM & Pricing Info or Effective Dated UOM pages.

Accessing Purchase Order Related Content

This section provides an overview of related content and discusses how to access Purchase Order related information.

Pages Used to Access Purchase Order Related Information

<i>Page Name</i>	<i>Definition Name</i>	<i>Usage</i>
<u>Spend by Supplier Page</u>	PO_SPEND_BY_VENDOR	View spend by supplier related content.
<u>Recent PO's Page</u>	PO_RECENT_PO	View recent purchase order related content.
<u>Overdue PO's Page</u>	PO_OVERDUE_PO	View overdue purchase order related content.

Page Name	Definition Name	Usage
Vendor Returns Page	PO_VENDOR_RETURNS	View vendor returns related content. Recent PO's Page

Understanding Related Content

Using PeopleSoft Related Content Services Framework, you can configure services to appear on component pages without customizing PeopleSoft-delivered application pages. This framework provides immediate access to relevant, contextual information for PeopleSoft applications, such as Purchasing activities, without requiring any additional user effort. The framework ties together all types of content, such as Oracle Business Intelligence Enterprise Edition (OBIEE) analytics, queries, discussion threads, or any relevant non-PeopleSoft data, into PeopleSoft application pages.

For more information about using related content, see *PeopleTools: PeopleTools Portal Technology*.

See "Working with Related Content Services," *PeopleTools: PeopleTools Portal Technology*.

Setting Up Related Content

This section provides a brief overview of setting up related content. The next example illustrates that the **Related Information** link appears after you complete setting up related content services:

This example illustrates the fields and controls on the Example of the Related Information link. You can find definitions for the fields and controls later on this page.



In addition to using the *PeopleTools: PeopleTools Portal Technology* book, follow this list of steps to set up related content for PeopleSoft Purchasing:

1. Define the purchase order component type for each related content service.

To access the page, select **PeopleTools > Portal > Related Content Service > Define Related Content Service** and select or add a service ID.

Note: Related content service definitions are not delivered and must be entered manually. Use the *PeopleTools Portal Technology* book to add the services.

The following four Related Content Service components are delivered with PeopleSoft Purchasing. Enter them as four distinct related content definitions:

Description	Component name
Spend by Supplier	PO_SPEND_BY_VENDOR

<i>Description</i>	<i>Component name</i>
Recent POs	PO_RECENT_PO
Overdue POs	PO_OVERDUE_PO
Vendor Returns	PO_VENDOR_RETURNS

Here are guidelines for defining any of the related content services:

- The service ID can be identical to the component name.
- The service name appears on the Related Information tab.
- The URL type is PeopleSoft Component URL.
- The menu name is `MANAGE_PURCHASE_ORDERS`.
- For each service definition, add the following parameters exactly as spelled and shown in the next table. A misspelled parameter can cause unpredictable results:

<i>Parameter Name</i>	<i>Required Check Box</i>	<i>Components Using These Parameters</i>
BUYER_ID	Required	All four delivered components
VENDOR_SETID	Required	All four delivered components
VENDOR_ID	Required	All four delivered components
BUSINESS_UNIT	Required	All except Spend by Supplier
MAX_ROWS	Not Required	All except Spend by Supplier

2. Assign the related content service to the primary application page on the Assign Related Content page.

To access the page, select **PeopleTools > Portal > Related Content Service > Manage Related Content Service** and click the **Edit Configuration** button for the **Add/Update POs** content reference.

Note: When you are adding the first related content to a component, no component with an **Edit Configuration** button will exist, and you will have to assign to a new component and then navigate to it. Click the **Assign Related Content to Application Pages** link on the Manage Related Content Configuration page to initiate this process.

Use these steps to configure the purchase order related content services:

- a. Click the **Services at Page Level** button.
 - b. Assign any or all of the four services to page PO_LINE.
 - c. Assign a unique sequence number to each service for the order of appearance, such as the tab order.
3. Map the fields for each purchase order related content service using these guidelines:
 - Assign a fixed value to the MAX_ROWS value.
Enter a number or leave it blank to use the purchase order installation option.
 - Map all other parameters to page fields.
 - When selecting a page field, sort by **Field Name** first because it will likely match the parameter name defined earlier.

After completing the setup, you can access the related content pagelets by clicking the **Related Information** link at the top of the Maintain Purchase Order - Purchasing page.

For more information about the process, pages, and fields for using related content, see

"Working with Related Content Services," *PeopleTools : PeopleTools Portal Technology*.

Spend by Supplier Page

Use the Spend by Supplier page (PO_SPEND_BY_SUPPLIER) to view spend by supplier related content.

Navigation:

Purchasing, Purchase Orders, Add/Update POs, Related Information

Select the Spend by Supplier tab.

This example illustrates the fields and controls on the Spend By Supplier related content. You can find definitions for the fields and controls later on this page.



The Spend By Supplier related content displays historical and future supplier spend for the buyer. The reporting entity as well as the number of prior and future periods is defined in the dashboard display options for each buyer. The pagelet provides a bar chart that shows supplier spend by month.

When you click a bar, you access the **PO Detail** grid, where you can view a list of purchase orders for the time period along with information about the purchase order. Users will be taken to the page outlined

below that displays all purchase orders that made up the spends for the month. You can then click the **PO ID** link to view details about the purchase order.

Recent PO's Page

Use the Recent PO's page (PO_RECENT_PO) to view recent purchase order related content.

Navigation:

Select the Recent PO's tab on the Related Information page.

This example illustrates the fields and controls in the Recent PO's related content grid. You can find definitions for the fields and controls later on this page.

PO ID	Date and Time Dispatched	PO Status	POA Status	Supplier ID
000000189	04/17/2006 4:33:34PM	Dispatched	Not Required	SCM0000004
000000116	05/27/2005 12:35:55PM	Dispatched	Not Required	SCM0000004
APCLSP0006	05/26/2005 10:06:08AM	Dispatched	Not Required	SCM0000004
APCLSP0005	05/26/2005 10:05:35AM	Dispatched	Not Required	SCM0000004
APCLSP0004	05/26/2005 10:05:19AM	Dispatched	Not Required	SCM0000004

[Show All/Enhanced](#)

The Recent PO's related content grid displays purchase orders for which the scheduled due date is prior to today's date and the quantity still to be received is greater than zero. Click the **PO ID** link to access the Maintain Purchase Order - Purchase Order page. Use this page to view or maintain the purchase order. You can also click the **Show All/Enhanced** link to search for dispatched purchase orders using search criteria to limit the number of purchase orders.

Related Links

[Dispatching Purchase Orders](#)

Overdue PO's Page

Use the Overdue PO's page (PO_OVERDUE_PO) to view overdue purchase order related content.

Navigation:

Select the Overdue POs tab on the Related Information page.

This example illustrates the fields and controls in the Overdue PO's related content page. You can find definitions for the fields and controls later on this page.

Related Content										
Overdue PO's										
Last 5 Overdue PO's for Supplier										
PO ID	Line	Sched	Item ID	Description	Open Qty	UOM	Ship To	One Time Address	Due Date	
0000000001	1	1	BR4400	Yoke, Brake Subassembly	100.0000	EA	US008			07/26
0000000001	1	2	BR4400	Yoke, Brake Subassembly	100.0000	EA	US008			07/27
0000000001	1	3	BR4400	Yoke, Brake Subassembly	70.0000	EA	US008			07/27
0000000001	1	4	BR4400	Yoke, Brake Subassembly	600.0000	EA	US008			07/27
0000000006	1	2	MT3000	Mountain Bike, Womans	100.0000	EA	US008			08/30

The Overdue PO's related content grid displays purchase orders for which the scheduled due date is prior to today's date and the quantity still to be received is greater than zero. Click the **PO ID** link to access the Maintain Purchase Order - Purchase Order page. Use the page to view or maintain the purchase order.

You can also click the **Show All/Enhanced** link to search for overdue purchase orders using search criteria to limit the number of purchase orders.

Related Links

[Creating Purchase Order Headers](#)

Vendor Returns Page

Use the Vendor Returns page (PO_VENDOR_RETURNS) to view vendor returns related content.

Navigation:

Select the Vendor Returns tab on the Related Information page.

This example illustrates the fields and controls in the Vendor Returns related content grid. You can find definitions for the fields and controls later on this page.

Related Content										
Vendor Returns										
RTVs for Supplier										
RTV ID	Line	Item ID	Description	Action	Reason Code	Return Qty	Supp UOM	Status	PO ID	Receipt No
0000000001	1	10026	Patch Kit	Replace	FAL	5.0000	EA	Open	0000000011	0000000005

[Show All/Enhanced](#)

The Vendor Returns related content grid displays a list of returns to the supplier.

Field or Control	Description
RTV ID (return To vendor ID)	Click to access the Return To Vendor (Supplier)Inquiry - Return To Vendor (Supplier) page, where you can view all details about the return.
PO ID (purchase order ID)	Click to access the Maintain Purchase Order - Purchase Order page, where you can view all details about the return.

Field or Control	Description
Receipt No (receipt number)	Click to access the Receipts page to view details about the receipt.
Show All/Enhanced	Click to use search criteria to limit the number of supplier returns.

Related Links

[Understanding the RTV Business Process](#)

Working with Large Purchase Orders

Chunking controls the number of lines that the system initially loads when you open a purchase order. Using chunking functionality, you can initiate an advanced purchase order line search that eliminates system processing times for a purchase order with a large number of lines and provides a quick and easy method to retrieve specific lines in the purchase order.

Note: A chunk is not the same as a page full of data. It represents all of the rows that are in the scroll at a given point in time.

When you open an existing purchase order, if the number of purchase order lines exceeds the chunking limit defined on the Installation Options page for Purchasing and the new PO Installation setting specifies to display the Advanced Line Search first, the system does not initially load purchase order lines. Instead, a search page appears that you can use to view and load specific lines based on criteria that you designate.

The search can either pull lines directly into the Maintain Purchase Order page or show the results in a temporary summary grid from which you can select individual lines to load into the page.

“Securing ChartFields for PeopleSoft Grants Management” (Application Fundamentals)

Note: You can also access the Advanced Line Search page using the Search for Lines link on the Maintain Purchase Order page.

This procedure shows one way to set up and use advanced purchase order line searches for a business unit:

1. Open the Installation Option page for Purchasing “Installation Options - Purchasing Page” (Application Fundamentals).
2. Specify the maximum number of rows to retrieve for purchase order searches.
3. Select the Display Advanced Line Search Page option to define the initial advanced search behavior when the maximum number of rows has been exceeded for purchase order lines.
4. Search for a purchase order with lines that exceed the maximum number of rows to retrieve.

Note: If the purchase order lines do not exceed the maximum number of rows, the system accesses the Maintain Purchase Order page and does not initiate the advanced search.

5. Define search criteria to limit the search results and click the Search button.
6. Select the purchase order lines that you want to load into the Maintain Purchase Order page.
7. Click the Retrieve Selected Items link.

The system loads the lines and you can now maintain purchase order and schedule lines.

Maintain Purchase Order — Advanced Line Search Page

Page	Object Name	Navigation	Purpose
Maintain Purchase Order – Advanced Line Search	PO_HDR_CHUNK	Purchasing, Purchase Orders, Add/Update POs	Define advanced search criteria for purchase order lines.

Navigation:

Purchasing > Purchase Orders > Add/Update POs

This example illustrates the fields and controls on the Maintain Purchase Order — Advanced Line Search page. You can find definitions for the fields and controls later on this page.

Maintain Purchase Order
Advanced Line Search

Business Unit US001 PO ID POSBL-05

Search for PO Lines

From Line To Line Max Number of Rows in Scrolls

Item ID Supplier Item ID

Description Supplier's Catalog

Category Manufacturer ID

Ship To Location Mfg Item ID

From Due Date To Date UPN ID

Contract ID

Chartfields

Chartfields

GL Unit	Entry Event	Account	Alt Acct	Oper Unit	Fund	Dept	Program	Class	Bud Ref	Product	PC Bus
<input type="text"/>	<input type="text"/>	<input type="text"/>	<input type="text"/>	<input type="text"/>	<input type="text"/>	<input type="text"/>	<input type="text"/>	<input type="text"/>	<input type="text"/>	<input type="text"/>	<input type="text"/>

The Search button displays lines which can be individually selected for retrieval whereas the Search and Load button loads the lines directly into the component. Hit Cancel Search to return to the main page with no changes. Clear Results will merely clear the search results from this page. Click off Warn Before Autosaving to avoid a message that prior changes will be saved before loading in new lines.

Warn Before Autosaving

Search Results Personalize | Find | View All | First 1-2 of 2 | Last

Line	Item	Description	UOM	Category	Status	Merchandise Amount	Currency
<input type="checkbox"/>	1 10000	Long Sleeve Biking Jersey, Men's	EA	CYCLING	Approved	2500.00 USD	
<input type="checkbox"/>	2 10010	Mountain Bike Gloves, Women's	EA	CYCLING	Approved	3000.00 USD	

Select All
 Deselect All

Use the Advanced Line Search page to define purchase order line criteria on which to base the search. After defining search criteria, click the Search button to display the lines in the Search Results grid. The results include information about the line and additional actions that you can perform to load the lines. Select the More Details tab to see more information about the purchase order lines.

You can also load the lines into the Maintain Purchase Order page by clicking the Search and Load button. You can use all of the fields that are available for entry in the Search for PO Lines section and the Chartfields grid to filter the search results. The prompts that are available for the item ID, supplier item ID, supplier's catalog, category, manufacturer ID, ship to location, manufacturing item ID, and contract ID are for distinct values within existing purchase order lines. The system loads a PO line if at least one of the line's schedules matches any schedule criterion entered.

<i>Field or Control</i>	<i>Description</i>
Bypass Search	Click to return to standard system processing for chunking. When you click this button, the system accesses the Maintain Purchase Order page and displays the first set of purchase order lines based on chunking rules. The Bypass Search button appears only when the business unit installation setting specifies to display the Advanced Line Search page.

Search For PO lines

<i>Field or Control</i>	<i>Description</i>
From Line/To Line	Enter the range of line numbers for which you want to search. After performing the search, you can select the lines to retrieve and load into the Maintain Purchase Order page. Also, note that you can load only as many lines as defined in the Max PO Lines field.
Max Number of Rows in Scroll	Displays the maximum number of rows that is specified in the installation options for the business unit in the Maximum Rows to Retrieve setting for purchase orders. You can increase or decrease this value to load as many purchase order lines as you want. The maximum number that you can enter is 300.
Ship To Location	Enter a value with the intention of retrieving a PO line when at least one of the purchase order schedules for a particular line has a matching ship to location. The system retrieves the purchase order line and all of its children even if the other purchase order schedules belonging to the same purchase order line have a different ship to location.

Field or Control	Description
From Due Date/To Date	Enter from and to due dates to specify a range of dates during which a purchase order line is due. If one of the purchase order schedules falls within the due date range, the system loads the corresponding line and all of its schedules into the Maintain Purchase Order page even if one of the other purchase order schedules belonging to that same line does not match. If you enter a value in the From Due Date field, but not a value in the To Date field, the system doesn't load due dates that are later than the from due date. If you do not enter a value in the From Due Date field, but enter a value in the To Date field, the system does not load due dates that are earlier than the To Date field value.
UPN ID (Universal Product Number Identifier)	Select applicable universal product number that is defined by a unique combination of item ID, manufacturer ID, manufacturer item ID, and Unit of Measure. On selecting the UPN ID, the item line information associated with the selected UPN ID will be populated.

Chartfields

The Chartfields grid displays the ChartFields on the purchase order distribution level. Any combination of ChartField values that you enter must match the same values on at least one distribution line for the purchase order line to be loaded. The system loads the purchase order line even if other distributions that belong to that line do not match the exact ChartField combination entered.

Field or Control	Description
Search	Click to load purchase order lines that meet the search criteria into a temporary Search Results grid. If the number of rows that meet the search criteria exceeds 300, the system displays a message indicating that only the first 300 rows have been loaded and that you should narrow down the search results by changing the search criteria. If you do not clear search results, the system appends purchase order lines to any lines that have already been loaded into the search results.

<i>Field or Control</i>	<i>Description</i>
Search and Load	<p>Click to load all items that match the search criteria. This process skips the Search Results step and loads all items that match the search criteria directly into the Maintain Purchase Order page in one step. At a maximum, the system loads the first 300 rows that match the search criteria.</p> <p>Also, the system displays a message that only <nnn> number of lines have been loaded if the installation option for the maximum number of rows to retrieve is less than the number of lines selected for retrieval. The system displays a message when results are not found that meet the search criteria.</p>
Cancel Search	<p>Click to cancel the advanced line search and access the Maintain Purchase Order page. If purchase order lines have been loaded into the Search Results grid, they will remain the same as they were as if you had not accessed the Advanced Line Search page.</p>
Clear Results	<p>Click to remove the content of the Search Results grid so that you can perform a new search. If you do not clear the search results first, subsequent searches will cause new lines to be appended to the existing results.</p>
Warn Before Autosaving	<p>Select to have the system display a warning when users select to retrieve a new set of lines. The warning indicates that the purchase order will be saved automatically before the system retrieves the lines and that any changes made to the lines will be saved.</p> <p>The message appears when you click the Retrieve Selected Lines or Search and Load button. You can click the OK button on the warning to have the system save the purchase order changes or click the Cancel button to not save the changes. The check box is selected as the default value.</p>

Search Results

<i>Field or Control</i>	<i>Description</i>
Select All	<p>Click to select all lines that appear in the Search Results grid. If you select more lines than the number defined in the Max PO Lines field, the system displays a warning when you attempt to load the items. You must either deselect some rows or increase the value in the Max PO Lines field. This link is available after the system populates the Search Results grid.</p>

<i>Field or Control</i>	<i>Description</i>
Deselect All	Click to deselect all the lines in the Search Results grid. This link is available after the system populates the Search Results grid.
Retrieve Selected Lines	Click to load the selected purchase order lines into the purchase order. Before retrieving the new set of lines, the system saves the selected lines to preserve any changes that were made. After the purchase order is saved, the system removes the old lines from the page and then loads the new lines. If you do not select any rows, an error message appears. This button is available after the system populates the Search Results grid.

More Details

<i>Field or Control</i>	<i>Description</i>
UPN Type	Displays the UPN Type for the PO line.
UPN ID	Displays the UPN ID for the PO line.

Using Purchase Order Sourcing

Understanding the Purchase Order Sourcing Business Process

The purchase order sourcing business process creates purchase orders from item requests loaded to the PeopleSoft Purchasing staging tables from various sources.

This diagram provides an overview of the sourcing business process flow and illustrates item requests origins such as external data and PeopleSoft Inventory and Order Management:

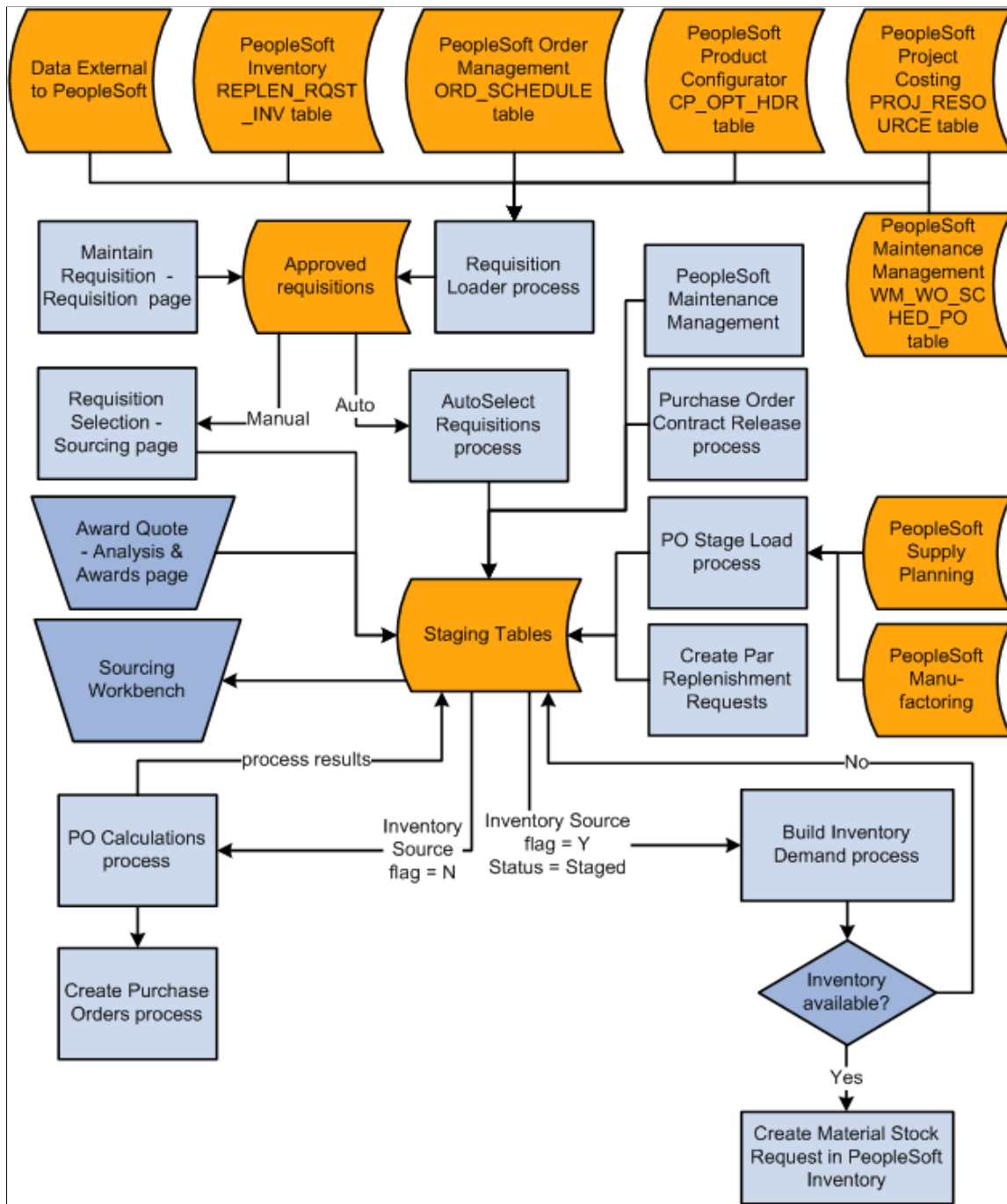

These business processes also feed into the sourcing processes and are covered in other sections of this book:

- Awarding requests for quotes (RFQs).
Awarded RFQs are loaded to the Purchasing staging tables for purchase order creation.
- Staging contract releases for purchase order creation.

- Staging par location (cart) replenishment requests for purchase order creation.

Primary Sourcing Staging Tables

The primary PeopleSoft Purchasing sourcing staging tables are:

Term	Definition
PO_ITM_STG	<p>This core staging table provides line and schedule level information destined for the purchase order. The information in the table may be derived from the requisition, requests for quotes, supply planning, manufacturing, par replenishment, or contracts. Many fields on this table are work fields and should be ignored.</p> <p>These fields in the PO_ITM_STG table are particularly important:</p> <p>PO_STG_TYPE: <i>R</i> (requisition) is used for the AutoSelect Requisitions process (PO_REQSORC) or for online requisition selection when the Define purchase order option is not selected. <i>O</i> (other) is used for any other process.</p> <p>PO_STG_ID: This is the same as the requisition ID when the PO stage type is <i>R</i>. This field is derived from INSTALLATION_PO.LAST_PO_STG_ID, when the purchase order stage type is <i>O</i>.</p> <p>PO_PROCESS_ID: Indicates the process that placed the row into the staging table.</p> <p>CONSOLIDATE_FLG: Indicates whether similar rows (same item and supplier) can be consolidated into a purchase order during the PO Calculations process (PO_POCALC).</p> <p>OVERRIDE_SUGG_VNDR: Indicates whether or not the PO Calculations process can override the suggested supplier with the preferred supplier.</p> <p>INVENTORY_SRC_FLG: Indicates whether a given row is destined for inventory demand or for a purchase order.</p>
PO_ITM_STG_UD	<p>The PO Calculations process takes the information from PO_ITM_STG and copies it, along with each possible supplier from whom the item can be sourced, to PO_ITM_STG_UD. Due to the addition of suppliers, PO_ITM_STG_UD may contain multiple rows for each row in PO_ITM_STG. As the PO Calculations process performs its calculations, it stores the updated information in PO_ITM_STG_UD, leaving the original request information in PO_ITM_STG untouched. Once the sourcing process is complete, the supplier and purchase order ID results update PO_ITM_STG.</p>

Term	Definition
PO_DISTRIB_STG	<p>This table provides distribution information. One row is placed here for each distribution destined for the purchase order. For requisitions, the information in this table comes directly from the requisition.</p> <hr/> <p>Note: RFQ, supply planning, manufacturing, par replenishment, and contract requests also populate this table. Information in this table is copied to the PO_LINE_DISTRIB table.</p> <hr/>
PO_HDR_STG	<p>This is an optional table built by online requisition selection, RFQs, and contract releases. It is used for manually consolidated requisitions to specify information destined for the Purchase Order Header table (PO_HDR).</p>

Related Links

[Automatically Selecting Requisitions for Sourcing](#)

[Manually Selecting Requisitions for Sourcing](#)

[Running the PO Calculations Process](#)

Stage Statuses

This table illustrates the possible stage statuses (STAGE_STATUS) in the PO_ITM_STG and PO_ITM_STG_UD tables:

STAGE_STATUS	Description	Explanation of Status
B	Ready to create	Set by the sourcing workbench pages once the selected supplier is approved, or by the PO Calculations process if the auto approve option is selected. Can be changed to R (recycle) or, for some sources, to X (reset and purge).
C	Completed	Set by the Create Purchase Orders process once a purchase order has been created successfully and processing is complete. No changes are allowed.
D	Inv demand (inventory demand in process)	Indicates that the Build Inventory Demand process is running. Set by the Build Inventory Demand process once started and while processing. No changes allowed.

STAGE_STATUS	Description	Explanation of Status
E	Error	Set by the PO Calculations process if any errors are found. Can be changed to R, or for some sources, to X.
I	In Process	Set by the AutoSelect Requisitions process and other processes, such as the PO Stage Load process while building the rows in PO_ITM_STG. No changes are allowed.
N	Pending (needs approval)	Set by the PO Calculations process once there are no errors and the purchase order is ready for building but still needs the supplier to be approved in the sourcing workbench pages. Can be changed to B (build), R, or for some sources, to X.
P	POCREATE in process	Indicates that the Create Purchase Orders process is running. Set by the Create Purchase Orders process once started and while processing. No changes are allowed.
R	Recycle (error recycle)	Set in the Sourcing Workbench pages once an error is reviewed and the user indicates that it should be recycled by the PO Calculations process. Can be changed for some sources to X.
S	Staged	Set by the AutoSelect Requisitions process, online requisition selection, and processes such as the PO Stage Load process once the process completes and the staged row is ready to be sourced. Can be changed for some sources to X.
V	POCALC in process	Indicates that the PO Calculations process is running. Set by the PO Calculations process once started and while processing. Can be changed to R, or for some sources, to X.
W	Warning issued	Set by the Create Purchase Orders process once a purchase order has been created but contains a warning, and processing is complete. No changes are allowed.

STAGE_STATUS	Description	Explanation of Status
X	Reset and purge	<p>Entered on the Sourcing Workbench - Selected Items page. This action is possible for some sources when the stage status is S, V, N, E, R, or B. Once the status is X, no changes are allowed.</p> <hr/> <p>Note: Only transactions built by certain processes can be set to the X stage status. To set the stage status to X, the row must have one of these process codes: SRC (reqsrc), OLS (online source), PLL (planning load), SFL (shop floor load), CRT (cart (par) replenishment), CON (contract release) or WKM (work order management). If the row was built by the RFQ Load process, you cannot use the X stage status.</p> <hr/>

Related Links

[Loading RFQ EDX Responses](#)

“Understanding Par Location Management” (PeopleSoft Inventory)

Qualifying Criteria for Requisition Selection

When selecting requisitions for sourcing either manually using the Requisition Selection - Sourcing pages or automatically using the AutoSelect Requisitions process, consider that a requisition must meet these conditions before it can be eligible for selection.

Record	Field	Value
REQ_HDR	IN_PROCESS_FLG	N (no)
REQ_HDR	HOLD_STATUS	N (no)
REQ_HDR	BUDGET_HDR_STATUS	V (valid)
REQ_LINE	IN_PROCESS_FLG	N (no)
REQ_LINE	SOURCE_STATUS	A (approved)
REQ_LINE	CURR_STATUS	A (approved)
REQ_LINE	RFQ_IND	N (no)
REQ_LINE_SHIP	BAL_STATUS	I (in balance)

Record	Field	Value
REQ_LINE_DISTRIB	QTY_OPEN or AMT_OPEN	> 0 (greater than 0)

Note: If the AMT_OPEN field value is > 0, QTY_OPEN can have a value other than > 0. If the QTY_OPEN field value is > 0, AMT_OPEN can have a value other than > 0. Only one of these two REQ_LINE_DISTRIB field values must be > 0.

If no requisitions appear on the Requisition Selection - Sourcing page, consider reviewing the selection criteria that you entered on the Requisition Selection page. The requisition must meet these conditions before it can be selected:

- The requisition line current status must be approved.
- The RFQ indicator on the requisition line must be *N* (no).
- The In Process flag on the requisition line must be *N*. When one line on a requisition is selected for sourcing, the In Process flag on the requisition line is set to *Y* (yes), indicating that the line cannot be touched until sourcing is complete. Once sourcing is complete, the In Process flag is turned off (set to *N*) and can be changed.
- The hold status on the requisition header must be *N*.
- The budget header status on the requisition header must be *V* (valid).
- The source status on the requisition line must be *A* (approved).
- The balance status on the requisition schedule must be *I* (in balance).
- The open quantity or open amount on the requisition distribution must be greater than zero.

If you have frequent problems with unselected requisitions, build a query that displays all fields used in the selection process to see why the requisition is not eligible for selection.

See the product documentation for *PeopleTools: Query*

Related Links

[Manually Selecting Requisitions for Sourcing](#)

Common Elements Used in Purchase Order Sourcing

Field or Control	Description
Business Unit	Select rows to be processed or selected based on the business unit that staged them.

Field or Control	Description
Date	Specify the exact date that you want to use in the date selection criteria. This field is required if you use the date selection option <i>S</i> ; otherwise, it is unavailable for entry.
Nbr Days (number of days)	Number of days for the before, equal to, or after selections in the Operand field. Applicable when you use Option field values <i>P</i> and <i>M</i> .
Operand	Use this field to indicate whether date selection range should include dates that are before, equal to, or after the selection date. For example, suppose that you want to include requisitions with source dates up to today and for the next three days, select date selection option <i>P</i> , date selection operand \leq , and number of days 3.
Option	<p>For the AutoSelect Requisitions process, use to specify the source date selection criteria for the requisition lines that you want to process or select.</p> <p>For the Purchase Order Stage Load process, use to specify release date selection criteria for planned purchase orders you want to process or select.</p> <p>For the Purge Stage Tables process, use to specify the release date selection criteria for requests that you want to process or select.</p> <p>Values are:</p> <p><i>C</i>: Use current date.</p> <p><i>M</i>: Current date minus number of days.</p> <p><i>N</i>: No date selection criteria.</p> <p><i>P</i>: Current date plus number of days.</p> <p><i>S</i>: Use a specified date. Enter a date in the Date field.</p>
PO Process that built row	<p>Select rows to be processed based on the process that staged them.</p> <p><i>CON</i> (contract purchase orders).</p> <p><i>CRT</i> (par location replenishment).</p> <p><i>OLS</i> (online source).</p> <p><i>PLL</i> (planning load).</p> <p><i>RFQ</i> (request for quotation).</p> <p><i>SFL</i> (manufacturing load).</p> <p><i>SRC</i> (autoselect)</p>

Field or Control	Description
Process Instance	Select rows to be processed and selected based on the process instance that staged them.
System Source	Select rows to be processed and selected based on their system source.

Manually Selecting Requisitions for Sourcing

This section provides an overview of the manual requisition selection process and discusses how to Manually Select Requisitions for Sourcing

Pages Used to Manually Select Requisitions for Sourcing

Page Name	Definition Name	Usage
<u>Requisition Selection - Sourcing Page</u>	PO_REQ_SOURCE	Enter search criteria and source requisitions to purchase orders or inventory demand.
<u>Requisition Selection - Procurement Card Information Page</u>	CC_USE_HDR_DTL_1	Maintain procurement card information such as, selecting a procurement card as payment method if one is not already assigned, viewing the existing procurement card information, and overriding the existing procurement card.
Item Description Page	PO_REQ_DESCR254	Enter and view descriptions for a specific item.
Requisition Details Page	PO_REQ_DTLS	View information about the requisition selected on the Requisition Selection - Sourcing page. The fields on this page appear on the Maintain Requisitions - Form page.
Header Comments Page	PO_REQ_COMMNTS_SEC	Enter header comments. You can enter a unique comment, or you can select from predefined standard comments.
Line Comments Page	PO_REQ_COMMNTS_SEC	Enter line comments. You can enter a unique comment, or you can select from predefined standard comments.

Page Name	Definition Name	Usage
<u>Override Selected Requisition Supplier Page</u>	PO_REQ_SUPPLIER	Update the supplier ID for all selected requisition lines on the Requisition Selection page.
<u>Requisition Selection - Staging Information Page</u>	PO_REQ_CREATE	View or modify a requisition before sourcing.
Requisition Selection - Procurement Card Information Page	CC_USE_HDR_DTL	Maintain procurement card information for the sourcing process.
<u>PO Item Staging Page</u>	PO_STG_RECV_INSPEC	View or change information about the receiving process for an item selected on the Requisition Selection - Staging page.
<u>PO Header Staging Page</u>	PO_HDR_STG_DTLS	View or change information about the requisition header selected on the Requisition Selection - Staging Information page.

Understanding the Manual Requisition Selection Process

Manually selecting requisitions for sourcing enables you to maintain a finer degree of control than available using batch requisition selection and purchase order creation. Manual selection provides you with these options:

- Source all items that are *not* identified for the AutoSelect Requisitions process.
This is not available using batch processing. Items that are not identified for automatic selection cannot be processed by the AutoSelect Requisitions process.
- Source individual items that you have ordered by description.
This is available using batch processing.
- Source inventory demand.
This is available using batch processing.
- Assign or change a supplier.
This is not available using batch processing.
- Add to an existing purchase order.
This is also available using batch process if associated blanket purchase orders are used or found.
- Define a purchase order header row.
This is not available using batch processing.

- Use the system to determine if it should check for price or use a contract on the purchase order, or both when sourcing requisitions in batch or processing online purchase orders.

Related Links

[Qualifying Criteria for Requisition Selection](#)

Requisition Selection - Sourcing Page

Use the Requisition Selection - Sourcing page (PO_REQ_SOURCE) to enter search criteria and source requisitions to purchase orders or inventory demand.

Navigation:

Purchasing > Purchase Orders > Stage/Source Requests > Requisition Selection > Requisition Selection - Sourcing

This example illustrates the fields and controls on the Requisition Selection - Sourcing page. You can find definitions for the fields and controls later on this page.

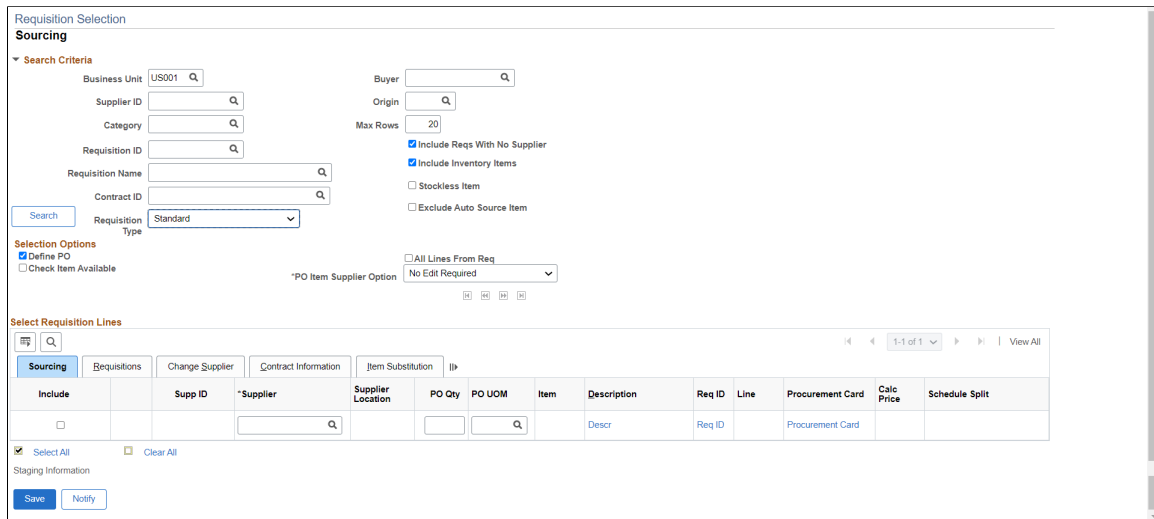

Search Criteria

Field or Control	Description
Buyer	Select a buyer on which to base the search. The buyer is the person responsible for the requisition.
Supplier ID	Select a supplier.
Origin	Select the origin for the requisition. Origin codes are established on the Origin Codes page and help identify the origins of transactions.

Field or Control	Description
Category	Select a category on which to base a requisition search. Requisitions that meet other search criteria and that are in the category you select appear in the search results.
Max Rows (maximum rows)	Enter the maximum number of rows that you want to display in the Select Requisition Lines grid box. These are the returned rows that match the criteria you enter.
Requisition ID	Select a requisition on which to base the search.
Include Reqs With No Supplier (include requisitions with no supplier)	Select to review requisitions with or without a suggested supplier.
Requisition Name	Select the name of the requisition. The name helps you identify the requisition as it flows through the system. If you are using PeopleSoft eProcurement, this value is carried from the eProcurement requisition to the Purchasing requisition when the requisition is created in eProcurement.
Include Inventory Items	Select to include requisition lines that would normally be sourced from PeopleSoft Inventory.
Contract ID	Select a contract ID. Only requisitions that specify the contract ID are returned.
Requisition Type	Only used with ePro requisitions. If enabled, select a Requisition Type (Standard, Bill Only, and Bill and Replace) to view the list of requisitions of the selected type. To enable the requisition type, see “ePro Installation Options Page” (PeopleSoft eProcurement).
Stockless Item	Select to retrieve requisition lines for stockless items.
Exclude Auto Source Item (exclude automatic source item)	Select to exclude items defined as automatic sourcing items. Items are flagged for AutoSourcing on the Purchasing Attributes - Purchasing Controls page by selecting the Auto Select check box under the Misc. Controls and Options section of that page.

Field or Control	Description
Search	<p>Click to search for the requisitions that match the criteria you entered. The system populates the Select Requisition Lines grid with requisitions that match the criteria you enter. To perform another search, change the criteria and click the Search button again.</p>

Selection Options

Field or Control	Description
Define PO	<p>Select to define purchase orders using the structure of requisitions as they appear on this page, instead of letting the system create it using the predefined rules.</p> <p>The PO Calculations process does not overwrite these purchase order configurations, even if the Consolidate with Other Reqs check box on the requisition is selected. In addition, you must specify the supplier for the purchase order, as the PO Calculations process does not select a supplier for you.</p> <p>If selected, the information that you view on the Requisition Selection - Sourcing page is exactly what will be on the purchase order and each requisition line that you source will be on its own purchase order line, even if others exist for the same item.</p> <p>If you want to use the Define PO check box, you must select this check box before selecting requisitions for sourcing. Similarly, if you don't want to use the Define PO check box, you must clear the check box before selecting requisitions for sourcing.</p> <p>If you are sourcing to PeopleSoft Inventory or do not select this check box, the information that you see on this page is either used for creating inventory demand in the Build Inventory Demand process (PO_REQINVS) or is updated in the PO Calculations process.</p> <hr/> <p>Note: If a line that you have selected for sourcing on this page has been sourced to a blanket purchase order contract, you will not be able to select the Define PO check box. Instead, you will receive a message that this option is not valid for the selected line. This check box only applies to lines that are selected by the Inc field after you select the Define PO check box.</p> <hr/>

The **Define PO** check box works in conjunction with the Override Preferred Supplier check box set on the User Preferences - Procurement: Requisition Authorizations page and the Override Suggested Supplier check box set on the Maintain Requisitions - Requisition page under the **Sourcing Controls** tab to determine when a purchase order is built using the priority (preferred) or suggested supplier.

Priority (preferred) suppliers are defined on the Purchasing Attributes - Item Supplier page.

Suggested suppliers are those entered manually on the requisition line or selected by the PO Calculations process.

When you select the **Define PO**, you can create purchase orders in whatever form you choose. The **Override Suggested Supplier** and **Consolidate with Other Reqs** check boxes are clear when the requisition lines are staged.

This table illustrates the different scenarios available when the **Define PO** check box is clear:

<i>Define PO</i>	<i>Override Preferred Supplier</i>	<i>Override Suggested Supplier</i>	<i>Supplier Used on PO</i>
No	No	Yes In this scenario, this value can never be set to No.	Priority
No	Yes	Yes	Priority
No	Yes	No	Suggested



<i>Field or Control</i>	<i>Description</i>
All Lines From Req (all lines from requisition)	Select to source all lines from the same requisition.
Check Item Available	Select this check box if you want to be informed that there is available stock for this item and that you have the option to source the selected requisition line from PeopleSoft Inventory. If there is enough available inventory, the system asks you whether you want to source this request from inventory. If you select <i>Yes</i> , the system sets the inventory source option accordingly.

Field or Control	Description
PO Item Supplier Option	<p>Select a purchase order supplier option. This value appears by default from the PO Item Supplier Security Option defined on the Purchasing Definition - Business Unit Options page for the PeopleSoft Purchasing business unit that you entered on the Requisition Selection - Sourcing page. Values are:</p> <p><i>No Edit Required:</i> The system does not verify whether selected items are defined for the current supplier on the item-supplier table. You can select a more restrictive rule, if necessary.</p> <p><i>Edit Required When Use Item ID:</i> The system verifies the item-supplier combination only for items with item IDs and not for those ordered by description only. This value cannot be changed.</p> <p><i>Edit Required Must Use Item ID:</i> The system requires item IDs and verifies item-supplier combinations. This value cannot be changed.</p>

Sourcing

Select the Sourcing tab.

Field or Control	Description
Include	Select to include the requisition line for sourcing. After you select a requisition line, it becomes unavailable for entry. To make any further changes to the requisition line, clear the check box, make the change, then select it again.
Supplier ID	Select the supplier that you want to use on the purchase order. The system stores the last supplier ID, whether entered or loaded from a requisition line. If you include a line without specifying a supplier ID, the system uses the last entered supplier ID as the default. If you include a line without specifying a supplier ID and the stored supplier ID is blank, the system issues an error message. You cannot change the supplier when a contract is specified.
Supplier Location	Select the supplier location used for ordering and determining the pricing location. The priority location appears by default from the item and shipto or from the item supplier. See Purchasing Attributes -Item Supplier (ITM_VENDOR)Page .

Field or Control	Description
PO Qty (purchase order quantity)	<p>Displays the purchase order quantity. The quantity appears as a default value from the requisition line.</p> <p>You can enter a purchase order quantity that exceeds the original requisition open quantity (oversourcing). You can also enter a quantity that is below the original requisition open quantity (partial sourcing), but only when all the requisition schedules for the line are charged by quantity.</p> <p>Partial sourcing and oversourcing is possible only when the Define PO check box is selected.</p>
PO UOM (purchase order unit of measure)	<p>Displays the UOM that you want to use on the purchase order. The UOM appears by default from the requisition line. If you are working with an ad hoc item, you can enter any UOM. If there is an item ID on the line, available UOMs are those in the INV_ITEM_UOM table.</p>
	<p>Click the View Related Links button to view details about the item. You can then select to view the item's availability or substitute items for the item.</p>
	<p>Identifies the item substitute is available</p>
Description	<p>Click to view a description of the item.</p>
Req ID (requisition ID)	<p>Displays the requisition ID to which this requisition line belongs. Click the link to access additional requisition details.</p>
Line # (line number)	<p>Displays the originating requisition line number.</p>
Procurement Card	<p>Displays the actual value of the procurement card assigned to the requisition or if no procurement card was assigned to the requisition as of yet it will display <i>Procurement Card</i>.</p> <p>Click the linked procurement card value to access the Requisition Selection - Procurement Card Information page. Use this page to override the current procurement card, view the current procurement card information or to assign a procurement card.</p>

Field or Control	Description
Calc Price (calculate price)	<p>Indicates whether the PO Calculations process should recalculate the price or use the price from the requisition. If set to <i>Y</i> (yes), the PO Calculations process recalculates the price. If set to <i>N</i> (no), the PO Calculations process uses the price from the requisition. This option is set to <i>Y</i> and cannot be changed when using an item ID and a contract is specified.</p> <hr/> <p>Note: If set to <i>N</i>, the PO Calculations process does not search for an available contract.</p> <hr/>
Schedule Split	Indicates that the quantity had been partially sourced.
Staging Information	Click to access the Staging Information page. The page displays staging information for the requisitions that you selected for staging.
Check for Contract	<p>Click to have the system search for and use appropriate contracts on manually entered purchase orders. This enables you to receive contract prices for requisition items and to more accurately track budgets, pre-encumbrance balances and control contract leakage and can be established at the business unit level.</p> <p>This button appears when you have selected to automatically default a contract onto a requisition. Select the Default Contract on Req check box on the Business Unit Options page.</p> <p>When you click the Check for Contract button, the system searches for manually entered purchase orders and requisitions and ensures that the correct contract is selected for use with the requisition. After locating possible contracts, the system copies them to transaction lines. The contract check takes place when the Supplier, Quantity, UOM, ShipTo, Item, or Item Description fields are created or changed. You can override contracts that have been selected by the system using the requisition header.</p>

Requisitions

Select the Requisitions tab.

Field or Control	Description
Req ID (requisition ID)	Click to access the Requisition Details page.
Req Line (requisition line)	Click to view details about the requisition line.
Req Sched (requisition schedule)	Displays the schedule line number that includes this requisition line.
Requisition Name (requisition schedule)	Displays the name assigned to the requisition when it was created. If you are using PeopleSoft eProcurement this value is carried from the eProcurement requisition to the Purchasing requisition. Requisition names assist you in identifying purchase orders associated with eProcurement requisitions.
UOM (unit of measure)	Displays the unit of measure for this requisition line.
Due Date	Displays the shipment due date to populate the requisition schedule. You define the due date when you create requisition header defaults.
Req Qty (requisition quantity)	Displays the number of items for this requisition line.
Amount Only	Indicates that this requisition line is specified as amount only.
Qty Req St (quantity requested standard)	Quantity ordered expressed in the item standard unit of measure.
% Prc Tol Under (percent price tolerance under) and Price Tol Under (price tolerance under)	The under-percentage and under-amount price tolerance per unit. This indicates the acceptable range within which the price can fall below that on the created purchase order. The tolerance appears by default from the Maintain Requisitions - Requisitions page under the Sourcing Controls tab for the requisition.

Change Supplier

Select the **Change Supplier** tab.

Field or Control	Description
Change Supplier	Select this check box to activate the Change Supplier link to access the Override Selected Requisition Supplier page, where you can change the supplier on all selected lines simultaneously.
Location	Supplier location used for ordering.
Item	Item ID from the requisition line. When you order an item that has a valid outstanding contract and the contract supplier is not selected for the line, the system displays a warning. You can decide to continue the transaction using the non-contract supplier.

Field or Control	Description
Select All	Click this link to select all lines on the page for sourcing.
Clear All	Click this link to clear the selection for all lines on the page.
Split Line	This button becomes available after you change the quantity on a line that you want partially sourced. Click to insert a new line with the unsourced requisition quantity. You can source the remaining requisition quantity to different suppliers.

Contract Information

Use the Contract Information tab to select contracts to include in requisition sourcing.

Field or Control	Description
Contract SetID	Displays the SetID to which the contract belongs.
Contract Version	Displays the contract version number. Procurement contract versions refer to the revision of the procurement contract transaction. Contract versions enable contract administrators to create and maintain multiple versions of a contract in the procurement system. To use contract versions, you must select the Use Version Control check box on the Contract and Vendor Rebate Controls page.

Field or Control	Description
Contract Line Nbr (contract line number)	Displays the contract line number to which this line item belongs. Contract line numbers represent each item that is on a contract.
Category Line Number	Displays the contract category line number. Categories enable you to specify groups of items on a contract, rather than having to enter the items one at a time.
Group ID	Displays the line group ID associated with the contract line number.
Use Contract if Available	Select to apply negotiated prices for purchases and transactions against the contract. The system searches for purchase order, general, and release-to-single-PO-only contracts. Batch processing uses a different set of rules and does not automatically apply contract prices to requisitions. See Establishing PeopleSoft Purchasing Business Units

Item Substitution

Select the Item Substitution Tab

Field or Control	Description
Item ID	This field is available for entry when the requisition line contains an ad hoc item (description only). This enables the buyer to enter an item ID, when appropriate, based on the ad hoc item description entered by the requester
Item Description	Displays the type of item
Original Substituted Item	Displays the original Item ID on a procurement transaction that is being substituted. Once an Original Substituted Item is designated for a procurement transaction, it is carried all the way through to the Receipt and cannot be changed. (This is also referred to as only 'Original Item' in some cases where the Item may or may not have been substituted.)

Field or Control	Description
Auto item Substitution	Select to uncheck the 'Auto Item Substitution' box on a Requisition Line when you wish to retain the current Item ID and do not want it automatically substituted during sourcing. Additionally, you will be able to reject a Substitute Item found by Auto Item Substitution on the online Requisition.

For information on the Item Search icon See Manual Substitution [Understanding Item Substitution in Procurement](#)

Related Links

- [Running the PO Calculations Process](#)
- [Establishing PeopleSoft Purchasing Business Units](#)
- [Understanding the UOM Conversion Hierarchy](#)
- [Purchase Order Consolidation](#)

Requisition Selection - Procurement Card Information Page

Use the Requisition Selection - Procurement Card Information page (CC_USE_HDR_DTL_1) to maintain procurement card information such as, selecting a procurement card as payment method if one is not already assigned, viewing the existing procurement card information, and overriding the existing procurement card.

Navigation:

Click the **Procurement Card** link on the Requisition Selection - Sourcing page.

Procurement Card used for payment

Field or Control	Description
Card Number, Card Type, and Expiration Date	Displays the procurement card information associated with the current procurement card on the requisition. Note: If a procurement card has not been previously assigned to the requisition then no procurement card information displays.

Override Procurement Card

<i>Field or Control</i>	<i>Description</i>
Card Number	Select the card number to override the current procurement card number on the requisition or select a procurement card that you want to assign to the requisition if a procurement card was not previously assigned. Only the valid procurement cards for the user who is making the requisition selection appear as valid procurement cards in the drop down list. This user must also have the access rights to use a procurement card on a requisition.
Card Type and Expiration Date	After you select an override procurement card these fields display the information associated with that procurement card.
Don't use Procurement Card	Select this check box if you do not want to use a procurement card as a payment method for this requisition that is being sourced to a purchase order. If you select this check box no procurement card will be associated with the purchase order.

Override Selected Requisition Supplier Page

Use the Override Selected Requisition Supplier page (PO_REQ_SUPPLIER) to update the supplier ID for all selected requisition lines on the Requisition Selection page.

Navigation:

Click the **Change Supplier** link on the Requisition Selection - Sourcing page.

Select a supplier to use by selecting the Change Supplier check box for the selected requisition lines on the **Change Supplier** tab of the Requisition Selection - Sourcing page.

<i>Field or Control</i>	<i>Description</i>
Supplier, Supplier ID, and Location	Select the supplier and location you want to override the current supplier with.
OK	When you click this button, the system updates the selected requisition lines with the supplier ID and location entered here and validates the item-supplier relationship. Once saved, the selected supplier is then staged into the purchase order staging tables.

Related Links

[Manually Selecting Requisitions for Sourcing](#)

Requisition Selection - Staging Information Page

Use the Requisition Selection - Staging Information page (PO_REQ_CREATE) to view or modify a requisition before sourcing.

Navigation:

Click the **Staging Information** link on the Requisition Selection - Sourcing page.

Header

Header information is available for modification only if you selected **Define PO** on the Requisition Selection - Sourcing page. This page is only accessible if **Define PO** was selected on the Requisition Selection - Sourcing page. You will not be able to access this page if the line has been sourced to a blanket purchase order.

Field or Control	Description
PO Date	Identifies the date to be used on the purchase order. This value can be changed if the system is assigned the purchase order date. If you are adding to an existing purchase order, the purchase order date appears by default from that purchase order.
User Assign ID	Select to source the requisition lines to the purchase order ID that you enter in the PO ID field. The purchase order must be an existing or reserved purchase order for the same supplier. If selecting an existing purchase order, only those in <i>Initial</i> , <i>Pending Approval</i> , or <i>Approved</i> status that have never been dispatched are available for selection.
Use Procurement Card	<p>Click this link to access the Requisition Selection - Procurement Card Information page. Use this page to maintain the procurement card information for the requisition being staged to become a purchase order.</p> <p>The procurement cards that appear for selection on this page are related to the buyer who also has the rights to use a procurement card on a purchase order. Plus, any supplier cards appear as well for the buyer and supplier and location if the supplier accepts procurement cards as a payment method.</p> <p>Procurement cards will be visible here if they came over from the requisition or set as a default from the supplier. The buyer has the ability to change this card information to a card that they are authorized to use.</p>

Line/Schedule

The line and schedule information appears by default from the requisition. If you selected **Define PO**, this information appears on the purchase order. If you did not select **Define PO**, the information listed here is passed to the appropriate sourcing process: PO Calculations or Build Inventory Demand.

<i>Field or Control</i>	<i>Description</i>
Line and Sched (schedule)	If you selected Define PO , this is the purchase order line and schedule number. If you did not select Define PO , this is the line and schedule number from the requisition.
Item ID	<p>This field is available for entry when the requisition line contains an ad hoc item (description only). This enables the buyer to enter an item ID, when appropriate, based on the ad hoc item description entered by the requester.</p> <p>When the requisition line contains an item ID, this field is unavailable for entry. The buyer may use the Substitute Items functionality to enter a substitute item.</p>
Price	<p>The unit price for this requisition line appears by default from the requisition and is used on the purchase order if the Define PO check box is selected. If the Calculate Price check box is selected on the requisition, the PO Calculations process recalculates the price.</p> <hr/> <p>Note: If you change the Price value for an ad hoc item and the new price exceeds tolerances defined for the requisition on the Maintain Requisitions - Requisition page under the Sourcing Controls tab, the ad hoc row is not rejected. Instead, the system recognizes that the price exceeds the defined tolerances, issues a warning, and gives you the option to accept the newly entered price or reset it to the price defined on the original requisition.</p> <hr/>

<i>Field or Control</i>	<i>Description</i>
Freight Terms	This field identifies the freight terms code associated with the purchase order's schedules.
Amount	Total line amount in the displayed currency.

Field or Control	Description
Distribute by	<p>The distribution method by which you allocate the expense account distribution appears by default from the requisition. Values include <i>Amount</i> or <i>Quantity</i>.</p> <p>If you select <i>Quantity</i>, the sum of all distribution quantities must equal the schedule quantity. Inventory items must be distributed using the quantity distribution method.</p> <p>If you select <i>Amount</i>, the sum of all distribution amounts must equal the schedule amount (merchandise amount).</p> <p>Both options enable you to distribute by percent.</p>

Distributions

The distribution information appears by default from the requisition. If you selected **Define PO**, this information appears on the purchase order. If you did not select **Define PO**, the system passes this information to the appropriate sourcing processes.

Field or Control	Description
PO Qty (purchase order quantity)	Identifies the quantity on the distribution. You can change the default distribution quantity. If the distribution method is <i>Amount</i> , the purchase order quantity is not available for entry.
Amount	Identifies the distribution amount. You can change the default distribution amount here. If the distribution method is <i>Quantity</i> , the amount is not available for entry.
Percent	Identifies the distribution percent. You can enter the distribution percent if the distribution method was either <i>Quantity</i> or <i>Amount</i> . If you change the amount or quantity, the percent is adjusted. If you change the percent, the amount or quantity is adjusted. In either case, the total must equal 100 percent.
Location	Represents the internal destination of the distribution, which can differ from the ship to location for the schedule. For example, the ship to location for the schedule might be corporate headquarters, and the distribution location might be a particular floor's supply room.

Click the **Save** button to copy this information into the PeopleSoft Purchasing stage tables, where it can be picked up by the PO Calculations process and then by the Create Purchase Orders process.

Related Links

[Creating Purchase Orders Using the Create Purchase Orders Process](#)

[Manually Selecting Requisitions for Sourcing](#)

[Running the PO Calculations Process](#)

PO Item Staging Page

Use the PO Item Staging page (PO_STG_RECV_INSPEC) to view or change information about the receiving process for an item selected on the Requisition Selection - Staging page.

Navigation:

Click the **Receiving/Inspection Information** link on the Requisition Selection - Staging Information page.

Field or Control	Description
Receiving Required	Select the receiving requirement for the item. Values are: <ul style="list-style-type: none"> • <i>Do Not Receive</i>: If selected, accounts payable matching and receipt accrual are not applicable. • <i>Receiving is Optional</i>: If selected, accounts payable will not match receipt lines and the system will not accrue the receipt. • <i>Receiving is Required</i>: If selected, accounts payable will match receipt lines and the system will accrue the receipt.
Inspect	Select this check box if inspection is required, and specify any inspection instructions for this item using the inspection routing ID.

PO Header Staging Page

Use the PO Header Staging page (PO_HDR_STG_DTLS) to view or change information about the requisition header selected on the Requisition Selection - Staging Information page.

Navigation:

Click the **Header Details** link on the Requisition Selection - Staging page.

Field or Control	Description
Tax Exempt Flag	Select this check box if sales tax does not apply to this transaction.

Matching Options

<i>Field or Control</i>	<i>Description</i>
Match Action	Indicate whether you want PeopleSoft Payables to perform matching before payment of the voucher.
Match Rule	Select a match rule from the available options. Match rules are defined on the Match Rules page and activated on the Match Rule Control page.

Payment Terms

<i>Field or Control</i>	<i>Description</i>
Payment Terms Basis Date Type	Specify the date that should be used to calculate the voucher payment terms in PeopleSoft Payables.

Process Control Option

<i>Field or Control</i>	<i>Description</i>
Dispatch	Select this check box to indicate that the purchase order should be dispatched upon creation.
Method	Select a dispatch method. Values are <i>Print</i> , <i>Fax</i> , <i>Email</i> , <i>EDX</i> , or <i>Phone</i> .

Related Links

“Establishing Matching and Document Association Options” (PeopleSoft Source to Settle Common Information)

Automatically Selecting Requisitions for Sourcing

This section provides an overview of the AutoSelect Requisitions process and discusses how to run the AutoSelect Requisitions process.

Page Used to Automatically Select Requisitions for Sourcing

<i>Page Name</i>	<i>Definition Name</i>	<i>Usage</i>
<u>Auto Requisition Selection Page</u>	RUN_PO_REQSORC	Enter the selection criteria for the AutoSelect Requisitions process and run the process.

Understanding the AutoSelect Requisitions Process

The AutoSelect Requisitions Application Engine process (PO_REQSORC), also referred to as AutoSelect, loads eligible approved requisitions into the PeopleSoft Purchasing stage tables for purchase order creation and is an alternative to selecting requisitions online using the Requisition Selection - Sourcing page. The AutoSelect process does not select or stage requisitions that have distribution lines that do not have an account number entered for each distribution line.

AutoSelect loads the PO_ITM_STG and PO_DISTRIB_STG tables, creating one row on the PO_ITM_STG table for every line and schedule combination and one row on the PO_DISTRIB_STG table for every requisition distribution. When AutoSelect has completed, it locks the requisition lines so that no further activity can take place while the actual sourcing is in process.

In order for AutoSelect to select the requisitions, the requisition line must be in *Approved* status and items with item IDs must have the **AutoSelect** check box selected on the Purchasing Attributes - Purchasing Controls page. Items ordered by description are also selected, as long as the **Item ID Required** check box on the AutoSelect Req page is clear.

After running the AutoSelect Requisition process, access the Sourcing Workbench page to verify that the intended requisition lines are in the staging tables by searching by the requisition ID or the process instance. If the requisition does not appear on the page, it was not selected.

Here are the results of the AutoSelect process:

- The requisition line In Process setting is selected.
- The requisition line SOURCE_STATUS is set to *Sourcing In Process*.
- The requisition line process instance is loaded with the current process instance.
- The requisition header process instance is loaded with the current process instance.

Note: Other applications and business processes, such as online requisition selection, requests for quotes, subcontracts from PeopleSoft Manufacturing, PeopleSoft Supply Planning, PeopleSoft Maintenance Management, and purchasing contracts populate the same staging tables used by the subsequent steps in the sourcing process.

Requisition Change Order Processing

You can use the AutoSelect Requisitions process to process a requisition change order for a requisition that was previously sourced to a purchase order. One additional process must be performed to ensure that the requisition does not exist on the autoselect staging tables. You must perform the Purge Stage Tables process (PO_POSTGPRG) using the Purge Stage Table page and then perform the AutoSelect process on

the requisition change order. If you do not perform the Purge Stage Tables process the change order for the requisition may not be recognized by the AutoSelect Requisitions process.

Related Links

[Manually Selecting Requisitions for Sourcing](#)

[Running the PO Calculations Process](#)

[Purging Purchasing Staging Tables](#)

Auto Requisition Selection Page

Use the Auto Requisition Selection page (RUN_PO_REQSORC) to enter the selection criteria for the AutoSelect Requisitions process and run the process.

Navigation:

Purchasing > Purchase Orders > Stage/Source Requests > Auto Requisition Selection

Field or Control	Description
Request Type	Select from these values: <i>Inventory</i> : Only those requisition lines for which the Inventory Source check box is selected are selected. <i>Purch Ord</i> (purchase order): Only those requisition lines for which the Inventory Source check box is clear are selected. <i>Both</i> : Requisition lines are selected for sourcing whether or not the Inventory Source check box is selected.
Item ID Required	Select this check box to load only those requisitions containing a valid item ID identified for AutoSelect. If this check box is clear, requisitions with item IDs and ad hoc items are both eligible for selection.
System Source	Use to limit the selection of requisition lines to those with a specific system source. For example, select WM (maintenance management) to select requisitions for sourcing to PeopleSoft Purchasing that were created in PeopleSoft Maintenance Management.
Business Unit	Select a purchasing business unit. Use to limit the selection of requisition lines to a single PeopleSoft Purchasing business unit.
Supplier SetID and Supplier	Select a supplier SetID and supplier ID to limit the selection of requisition lines to those for a specific supplier.
Contract SetID and Contract	Select a contract SetID and contract number to limit the selection of requisition lines to those for a specific contract.

Field or Control	Description
SetID and Category	Select a SetID and item category to limit the selection of requisition lines to those with items within a specific item category.
Requester and Buyer	Use to limit the selection of requisition lines to those associated with a specific requester or buyer.
Origin	Use to limit the selection of requisition lines to those with a specific origin.

Date Selection

Field or Control	Description
Option	<p>Select how you want the system to process date information. Depending on the value that you select, the system provides other fields for you to further define date information. Value include:</p> <p><i>C</i> (current date).</p> <p><i>M</i> (current date minus days).</p> <p><i>N</i> (no selection by date).</p> <p><i>P</i> (current date plus days).</p> <p><i>S</i> (specified date).</p>
Nbr Days (number of days)	Enter the number of days to apply to the operand that you select.
Operand	Select a value that indicates how the system processes a date. For example, you can select to include requisitions for sourcing that are dated greater than or equal to the selected date.
Date	Select a date. When the current date is used, it appears low-lighted in this field. You can select a date depending on the combined values that you select for the Option and Operand fields.

Sourcing by Region

This section provides an overview of regional sourcing.

Pages Used to Source by Region

<i>Page Name</i>	<i>Definition Name</i>	<i>Usage</i>
<u>Region Codes Page</u>	REGION_CD	Define the geographical sourcing region and establish supplier priority and supplier locations.
Region Codes Address Page	REGION_CD_ADDR	Define description and address information for the region code.
<u>Ship To Locations Page</u>	SHIPTO_HDR	Associate the sourcing region to the appropriate ship to location.
<u>Item Supplier by Region Page</u>	ITM_REGION_VNDR	Define supplier priority and supplier location by region.

Understanding Regional Sourcing

For large multinational organizations, purchases are often distributed across multiple purchasing locations. These purchasing locations are sometimes geographically dispersed, and may require that different suppliers or supplier locations (such as distribution centers or manufacturing plants) ship goods to different parts of the world. With the Regional Sourcing functionality, you can now define specific sourcing regions, group multiple supplier ship to locations into that region, prioritize suppliers and supplier locations, and source the requests to the preferred supplier within that region.

When searching for a supplier, the system retrieves the SHIPTO_ID field value from the first schedule; then, the system searches the ITM_SHIPTO_VNDR table using this SHIPTO_ID value. If no supplier is found, the system then searches the ITM_REGION_VNDR table using the REGION_CD field value from the SHIPTO_ID. If no supplier is found, the system then searches the ITM_SUPPLIER table.

Understanding the Regional Sourcing Process Flow

To set up PeopleSoft Purchasing to leverage regional suppliers during the sourcing process:

1. Set up Region Codes (for example North-CAL).

Use the Region Codes page to establish specific regions that are used to group suppliers and supplier locations.

2. Use the Ship To Locations page (SHIPTO_HDR) to associate the sourcing region to the appropriate ship to location.

Navigation — **Set Up Financials/Supply Chain Product Related Procurement Options**
Purchasing Ship To Locations

3. Use this page to link the ship to location to the appropriate region.
4. Use the Item Supplier by Region page (ITM_REGION_VNDR) to define supplier priority and supplier location by region.

Navigation —**Items Define Items and Attributes Item Supplier by Region**

5. Use the Procurement Region Supplier Order Location page (REGION_VNDR_LOC) to select an appropriate supplier SetID, supplier ID, and supplier location for a specific region.

Click the **Supplier Order Location** link on the Region Codes page.

Region Codes Page

Use the Region Codes page (REGION_CD) to define the geographical sourcing region and establish supplier priority and supplier locations.

Navigation:

Set Up Financials/Supply Chain > Common Definitions > Location > Region Codes

For more information, see “Region Codes Page” (Application Fundamentals) in the Application Fundamentals documentation.

Ship To Locations Page

Use the Ship To Locations page (SHIPTO_HDR) to associate the sourcing region to the appropriate ship to location.

Navigation:

Set Up Financials/Supply Chain > Product Related > Procurement Options > Purchasing > Ship To Locations

See “Ship To Locations Page” (PeopleSoft Source to Settle Common Information).

Item Supplier by Region Page

Use the Item Supplier by Region page (ITM_REGION_VNDR) to define supplier priority and supplier location by region.

Navigation:

Items > Define Items and Attributes > Item Supplier by Region

This example illustrates the fields and controls on the Item Supplier by Region. You can find definitions for the fields and controls later on this page.

Item Supplier by Region

SetID Item Bonefish Leaders, 12 Feet

Sourcing Region Locations Find | View All First 1 of 1 Last

*Region SetID *Region Code Description + -

List of Suppliers Personalize Find View All 1-2 of 2 Last							
*Supplier SetID	*Item Supplier Priority	*Supplier ID	Description	*Supplier Location	Lead Time	Lead Time Option	Include in Planning
<input type="text" value="SHARE"/>	<input type="text" value="1"/>	<input type="text" value="SCM0000002"/>	CAMPER'S WAREHOUSE	<input type="text" value="MAIN"/>	<input type="text" value="2"/>	<input type="text" value="Default"/>	<input checked="" type="checkbox"/>
<input type="text" value="SHARE"/>	<input type="text" value="2"/>	<input type="text" value="SCM0000003"/>	TRAILBLAZERS	<input type="text" value="MAIN"/>	<input type="text" value="4"/>	<input type="text" value="Default"/>	<input checked="" type="checkbox"/>

Field or Control	Description
Region Code	Select a region code to associate with this regional supplier.
Item Supplier Priority	Enter the priority order for which a supplier will be selected for regional sourcing.
Supplier ID	Select the supplier that you want to associate with this supplier region.
Supplier Location	Select the location for the supplier.
Lead Time	Enter the lead time that you want purchase order sourcing to use in determining the purchase order lead time. Item region is level two in the defaulting hierarchy after the item ship to supplier level. If you don't use this value, purchase order sourcing checks at level three in the defaulting hierarchy (Item/Supplier attributes).
Lead Time Option	Select the option that you want to use along with the lead time value. Select <i>Default</i> to use the next level lead time. Select <i>Use</i> to use the lead time defined at this level.
Include in Planning	Select to enable purchase options to be created in PeopleSoft Supply Planning for the PeopleSoft Inventory business unit related to this item supplier. The purchase option then enables the creation of new purchase orders through PeopleSoft Supply Planning for this PeopleSoft Inventory business unit.

Reviewing Regional Level Sourcing Methods

To use the regional hierarchy as part of the background sourcing process, you must select the **Override Suggested Supplier** check box on the Maintain Requisitions - Requisition page under the **Sourcing Controls** tab. If this check box is clear, the system uses the supplier provided on the transaction. The regional sourcing hierarchy is used only when you select the basic sourcing method.

Loading Staged Purchase Order Requests from PeopleSoft Supply Planning and Manufacturing

This section provides an overview of the PO Stage Load process and discusses how to Load Staged Purchase Order Requests

Page Used to Load Staged Purchase Order Requests from PeopleSoft Supply Planning and Manufacturing

<i>Page Name</i>	<i>Definition Name</i>	<i>Usage</i>
<u>PO Stage Load Page</u>	RUN_PO_POSTAGE	Enter the selection criteria for the PO Stage Load process and to run the process.

Understanding the PO Stage Load Process

The PO Stage Load process looks for purchase order requests in PeopleSoft Supply Planning and Manufacturing tables and loads them into the PeopleSoft Purchasing staging tables.

The PO Stage Load process accepts new requests from PeopleSoft Supply Planning and Manufacturing. The Change Purchase Order process (PO_POCHNG) handles change requests from PeopleSoft Supply Planning.

- The interface between PeopleSoft Supply Planning and PeopleSoft Purchasing uses the PL_PO_PLAN_ORD table.

The PO Stage Load process only processes rows with an approval status set to *Y* (yes) and a processed status set to *N* (no).

- The interface between PeopleSoft Supply Planning and PeopleSoft Purchasing uses the SF_OP_LIST table.

The PO Stage Load process only processes rows with a SUBPO_STATUS of *20* and a subcontracted setting of *Y*.

Before running the PO Stage Load process, establish defaults and a relationship between the PeopleSoft Inventory business unit from which the purchase order requests are coming and the PeopleSoft Purchasing business unit to which they are going. These defaults are set up on the PO Loader Defaults page.

Related Links

[Change Purchase Orders Page](#)

“Using Purchase Order Loader Defaults and Overrides” (PeopleSoft Source to Settle Common Information)

Reviewing, Approving, and Applying Planning Messages

PeopleSoft Supply Planning can generate purchasing messages containing recommendations for adding or rescheduling purchase orders. After a plan has been created and recommendations are made, the Approve Purchasing Updates (PL_POST) process creates the purchasing planning messages.

After you receive the messages, you can:

- Review and approve the purchasing messages using the Approve Purchasing Updates component.

This component contains pages from which you select the messages that you want to review, view the purchase order details, quantity and status details, and configuration code information, and select the messages that you want to approve.

- Review any exception messages generated when the purchasing messages are applied using the P Review Purchasing Post Errors component.

This component contains pages from which you select the exceptions that you want to review. Then look at the exception details, purchase order dates, and configuration code information.

- Load the purchasing messages to PeopleSoft Purchasing using the PO Stage Load process and Change Purchase Order process, which start the process of implementing the suggestions made by the Planning engine.

Related Links

[Change Purchase Orders Page](#)

[PO Stage Load Page](#)

PO Stage Load Page

Use the PO Stage Load page (RUN_PO_POSTAGE) to enter the selection criteria for the PO Stage Load process and to run the process.

Navigation:

Purchasing > Purchase Orders > Stage/Source Requests > PO Stage Load

<i>Field or Control</i>	<i>Description</i>
Inventory Unit	If you specify a PeopleSoft Inventory business unit, only items from PeopleSoft Supply Planning associated with that business unit are selected. If you leave this field blank, all PeopleSoft Inventory business units are considered.

Field or Control	Description
PO Business Unit (purchase order business unit)	If you specify a PeopleSoft Purchasing business unit, only items destined for this business unit are selected. If you leave this field blank, all PeopleSoft Purchasing business units are considered.
Process Planning Requests	Select this check box to process purchase requests from PeopleSoft Supply Planning. If this check box is clear, any purchase requests from these sources are ignored.
Group POs by Item - Planning	Select this check box to break down the purchase orders into one purchase order per supplier, per item. This can be desirable if the purchase orders are very large. If this check box is clear, you can generate purchase orders with multiple lines for the same supplier. To use this check box, you must select the Process Planning Requests check box.
Purchase Order Type	Select to indicate the type of requests that you want to load. To use this option, you must select the Process Planning Requests check box. Values are: <i>Existing Orders:</i> Change to an existing purchase order. <i>Planned Order:</i> New planned order.
Planner Code	If you select a planner code, only items from PeopleSoft Supply Planning with this value are selected. If you do not specify a code, all values are considered. To use this option, select the Process Planning Requests check box.
Process Production Requests	Select this check box to process purchase requests from PeopleSoft Manufacturing. If this check box is clear, purchase requests from PeopleSoft Manufacturing are ignored.
Group POs by Item - Production	Select this check box to break down the purchase orders into one purchase order per supplier, per item. This can be desirable if the purchase orders are very large. If this check box is clear, you can generate purchase orders with multiple lines for the same supplier. To use this check box, you must select the Process Production Requests check box.

See the product documentation for *PeopleTools: Process Scheduler*

Building Inventory Demand Transactions

This section provides an overview of the Build Inventory Demand process (PO_REQINVS) and discusses how to run the Build Inventory Demand process.

Page Used to Build Inventory Demand Transactions

<i>Page Name</i>	<i>Definition Name</i>	<i>Usage</i>
Inventory Demand Page	RUN_PO_REQINVS	Enter the selection criteria for the Build Inventory Demand process and run the process.

Understanding the Build Inventory Demand Process

This section discusses how to build inventory demand transactions from PeopleSoft Purchasing staging tables rows using the Build Inventory Demand process (PO_REQINVS).

At the start of processing, the Build Inventory Demand process reserves all rows in the staging tables that are identified for inventory demand (Inventory Source option set to *Y* (yes), have a stage status of *S* (staged), and meet the user-defined selection criteria.

The process then builds the demand table, IN_DEMAND, which is built at the distribution level; therefore, there is generally one row in the demand table for every selected, staged distribution. If partial quantities are allowed and the quantity on the distribution must be satisfied by more than one warehouse, there can be several rows on the demand table for one staged distribution.

Note: Partial sourcing is not allowed in the Build Inventory Demand process when the distribution is distributed by amount.

Because some distributions may be sourced entirely from inventory demand and others from a purchase order, distributions are renumbered by the Create Purchase Orders process, when necessary.

Most of the information for the demand table comes directly from the staging tables. All requisition keys are provided in the demand table to reference the requisition.

Reviewing How Inventory Demand is Sourced

The Build Inventory Demand process determines which warehouse (Inventory business unit) to use to fill demand by accessing the distribution network specified for the ship to location and evaluates the warehouses included in the network.

Note: The Build Inventory Demand process never sources demand from the PeopleSoft Inventory business unit that creates the request.

The Inventory Demand process also calculates available quantity.

To calculate available quantity, the Build Inventory Demand process takes the available quantity in BU_ITEMS_INV, then subtracts the sum of QTY_REQUESTED from all rows in IN_DEMAND with the same BUSINESS_UNIT and INV_ITEM_ID. If the demand is an interunit transfer, the interunit par quantity is also subtracted from the available quantity.

Transfer yield is calculated after the Inventory business unit is selected and the available quantity is checked. The requisition quantity is increased by the transfer yield percentage.

To see the requested quantity satisfied by inventory demand, check the **Qty Demand** field on the Sourcing Workbench - Sourcing Details page. You can also view the inventory demand created by the Build Inventory Demand process using the Update Unreserved Orders page.

The Build Inventory Demand process uses this logic to determine the method by which inventory demand should be sourced, as well as which warehouses to utilize:

1. The process first verifies that the requested item exists in the BU_ITEM_INV table for the inventory business units in the assigned distribution network.

If the item does exist and the process finds at least one Inventory business unit eligible for inventory demand sourcing, the process moves on to step 3.

2. If the item does not exist in the Inventory business units in the distribution network, the process continues with this logic using the settings of the **When Item Not Stocked in INBU** option on the Purchasing Options page.
 - If the Source to PO option is selected, the process sets the inventory source status for the request to *N*, so that the PO Calculation process can source it to a purchase order.
 - If the Error Out option is selected, the process sets the stage status to *Error* in PO Stage tables.
3. If the item does exist in the Inventory business units in the distribution network, the process continues with this logic using the settings of the **Check Inv Available Qty** and **Partial Qtys Can Ship** options on the Purchasing Options page.

These settings work together to create any of these processing scenarios when you run the Build Inventory Demand process.

- **Check Inv Available Qty** and **Partial Qtys Can Ship** are both clear.

If the process finds one eligible Inventory business unit, the entire requested quantity is sourced to the business unit regardless of the available quantity.

If the process finds multiple eligible Inventory business units, the entire requested quantity is sourced to the business unit with the highest priority ranking, regardless of the available quantity.

- **Check Inv Available Qty** is selected and **Partial Qtys Can Ship** is clear.

If the process finds one eligible Inventory business unit and it contains enough quantity, the entire requested quantity is sourced to the business unit.

If the process finds one eligible Inventory business unit, but it does not contain enough quantity, the entire requested quantity is sourced to a purchase order. The process sets the inventory source flag for the request to *N*, so that the PO Calculations process (PO_POCALC) can source it to a purchase order.

If the process finds multiple eligible Inventory business units with enough quantity, the entire requested quantity is sourced to the business unit with the highest priority ranking.

If the process finds multiple eligible Inventory business units, but none contain enough quantity, the entire requested quantity is sourced to a purchase order. The process sets the inventory source flag for the request to *N*, so that the PO Calculations process (PO_POCALC) can source it to a purchase order.

- **Check Inv Available Qty** and **Partial Qtys Can Ship** are both selected.

If the process finds one eligible Inventory business unit, the requested quantity is sourced from the Inventory business unit, with any outstanding quantity being sourced to a purchase order. The process sets the inventory source flag for the request to *N*, so that the PO Calculations process (PO_POCALC) can source it to a purchase order.

If the process finds multiple eligible Inventory business units, the requested quantity is sourced from each Inventory business unit in order of priority. Any outstanding quantity is sourced to a purchase order. The process sets the inventory flag status for the request to *N*, so that the PO Calculations process (PO_POCALC) can source it to a purchase order.

For example:

You have two requisitions, both with the **Check Inv Available Qty** and **Partial Qtys Can Ship** options selected:

- Requisition 100 for 80 units of item 10000.
- Requisition 200 for 40 units of item 10000.

Warehouse A and warehouse B are in the distribution network for the ship to location on the requisition and stock item 10000, as defined in BU_ITEMS_INV.

Warehouse A has 60 units and warehouse B has 40 units in inventory. The inventory quantity, unreserved demand, and available quantity before the Build Inventory Demand process runs are appear in this table:

<i>Warehouse</i>	<i>Inventory Quantity</i>	<i>Unreserved Demand</i>	<i>Available Quantity</i>
Warehouse A	60	0	60
Warehouse B	40	0	40

When the Build Inventory Demand process performs quantity checking for requisition 100 for 80 units, it sources 60 from warehouse A and 20 from warehouse B.

When the Build Inventory Demand process performs quantity checking for requisition 200 for 40 units, it calculates that there is unreserved demand in warehouse A from the first requisition and that there is no available quantity in warehouse A. It calculates that the available quantity in warehouse B is 20 units.

The quantities now look like this:

<i>Warehouse</i>	<i>Inventory Quantity</i>	<i>Unreserved Demand</i>	<i>Available Quantity</i>
Warehouse A	60	60	0
Warehouse B	40	20	20

There is not enough available quantity in the warehouses to fill the entire demand for requisition 200, so the Build Inventory Demand process sources 20 units from warehouse B and identifies the balance

of 20 units to be sourced to a purchase order. The purchase order is created in the next run of the PO Calculations and Create Purchase Orders processes.

The end result is that requisition 100 for 80 units, gets 60 units from warehouse A and 20 units from warehouse B. Requisition 200 for 40 units, gets 20 units from warehouse B and 20 units from a purchase order.

Once the Build Inventory Demand process runs successfully, these updates are made for rows fully converted, partially converted, and not converted to inventory demand transactions:

<i>IN Demand Created</i>	<i>PO_ITM_STG Stage Status</i>	<i>Req Line Source Status</i>	<i>IN Source Option</i>	<i>Req Line In Process Status</i>	<i>PO_ITM_STG Demand Qty</i>
Full	C (completed)	C (completed)	Y (yes)	N (no) Releases requisition line for updates by online and batch processes.	Quantity sourced to inventory demand, appears in requisition UOM.
Partial	S (staged) PO_POCALC and PO_POCREATE source the balance to a purchase order.	No update to the requisition.	N (no)	No update to the requisition.	Quantity sourced to inventory demand, appears in requisition UOM.
None	S (staged) PO_POCALC and PO_POCREATE source the balance to a purchase order.	No update to the requisition.	N (no)	No update to the requisition.	0

Backorders and the Build Inventory Demand Process

When the **Check Inv Available Qty** option is clear and the target Inventory business unit is set up for fulfillment, the Build Inventory Demand process sources unfulfilled quantities to a backorder, rather than to purchase orders.

For example, suppose that you have the previously described setup in place, and you have a requisition quantity of 10. The Distribution Network Inventory business unit has an available quantity of 6. When you run the AutoSelect Requisitions process and the Build Inventory Demand process, all 10 units are sourced from the Distribution Network Inventory business unit, where the 6 available units will be used to partially fulfill the resulting demand and the remaining 4 units are backordered until the Inventory Business Unit has a quantity available to fulfill the rest of the request.

Related Links

[Creating Purchase Orders Using the Create Purchase Orders Process](#)

[Creating Purchase Orders Using the Create Purchase Orders Process](#)

[Running the PO Calculations Process](#)

[Establishing PeopleSoft Purchasing Business Units](#)

“Distribution Network Page” (Application Fundamentals)

“Understanding Inventory Reservations” (PeopleSoft Inventory)

“Defining Business Unit Fulfillment Options” (PeopleSoft Inventory)

Running the PO Calculations Process

This section provides overviews of the PO Calculations process, sourcing methods, and procurement card assignment hierarchy and discusses how to run the PO Calculations process.

Page Used to Run the PO Calculations Process

<i>Page Name</i>	<i>Definition Name</i>	<i>Usage</i>
PO Calculations Page	RUN_PO_POCALC1	Enter the selection criteria for the PO Calculations process. Enter the run control criteria for the PO Calculations process and to run the process.

Understanding the PO Calculations Process

The PO Calculations Application Engine process (PO_POCALC) performs most of the processing necessary to create a purchase order. After running the PO Calculations process, you can review the results of the process and make changes using the Sourcing Workbench - Sourcing page before the purchase order is created. After you run the PO Calculations process, run the Create Purchase Orders process to create the purchase order.

If you select the **Pre-Approve Supplier** check box on the PO Calculations - Run Controls page, the system automatically approves the Supplier recommended by the PO Calculations process, so that you can run the PO Calculations process and the Create Purchase Order process without interruption. If you do not select the **Pre-Approve Supplier** check box, you must approve the Supplier manually in the Sourcing Workbench.

You can review the results of the PO Calculations process on the Sourcing Workbench - Sourcing Details page and change the recommended Supplier. If you change a Supplier through the Sourcing Workbench, run the PO Calculations process again to recalculate the staged row.

Various Functions of the PO Calculations Process

The PO Calculations process performs various functions:

1. Selects a Supplier using one of the four different sourcing methods.

When you select to override the suggested Supplier, the PO Calculations process recommends and selects the Supplier for purchase orders based on the sourcing method and the sourcing method settings for each item. You can select from four methods of Supplier selection: basic, flexible, schedule split, or cumulative split sourcing. All of these sourcing methods are available at the category level; and basic, flexible, and schedule split sourcing can be overridden at the item level. When a new item is created, the sourcing option appears by default from the category, but a different value can be specified at the item level. An option at the item level indicates whether you should use the item or the category sourcing method. The sourcing method to be used for each requisition is set based on the information at the item or category level at the time that the requisition is sourced, either online through the Requisition Selection - Sourcing page or through the AutoSelect Requisitions process.

2. Changes purchase order values using the business unit, Supplier, item, or contract, based on the PeopleSoft Purchasing default hierarchy.
3. Consolidates requisitions onto purchase orders when the Consolidate flag is *Y*.

Note: The PO Calculations process does not combine multiple requisition lines onto one purchase order line unless they have the same item ID and contract information. Requisition lines with different items or contract information are maintained as separate lines.

4. Calculates a due date if one is not provided.

The PO Calculations process calculates the due date based on the item Supplier lead time, if it is indicated; otherwise, it calculates the due date based on the item lead time. The PO Calculations process also validates the due date against the closure calendar and, if necessary, adjusts the due date based on the closure calendar.

5. Determines the purchase order currency.

When you add to an existing purchase order or when header level information is specified in the stage table, the PO Calculations process uses the currency from the headers. If no currency is specified, the PO Calculations process uses the currency from the Supplier location that is specified during online requisition selection when using **Define PO**. All prices, amounts, and price tolerances are converted to the purchase order currency. The PO Calculations process does not convert to the contract currency if it is different; the process does, however, convert to the contract currency when it updates contract release amounts.

6. Converts to the Supplier unit of measure (UOM) if necessary.

The PO Calculations process uses the transaction UOM whenever possible, but if you have elected to consolidate purchase requests, the process converts to the Supplier default UOM. The PO Calculations process also converts to the Supplier default UOM if you have chosen not to consolidate, but the Supplier location does not accept all UOMs and the transaction UOM is not a valid UOM for the Supplier. If the PO Calculations process finds a contract that indicates that the contract base price should be used and if that price is in a different UOM, then the PO Calculations process converts the contract price to the transaction UOM.

Note: No UOM conversion takes place for amount only lines. If a UOM conversion is necessary (conversion rate changed or requisition UOM is not valid for the Supplier) then an error will be issued.

7. Rounds to whole numbers, if indicated, on the item or item Supplier.

If you specify whole number rounding at the item or item Supplier level for the transaction or standard UOM, the PO Calculations process rounds the quantity to whole numbers. If both UOMs require whole numbers and if the transaction quantity has decimals after the PO Calculations process has rounded the standard quantity, then the transaction is rejected. If the rounded transactions were split sourced, the PO Calculations process ensures that the sum of the split-sourced quantities still adds up to the schedule quantity. If the sum of the split-sourced quantities does not add up to the schedule quantity, then the transaction is rejected. The PO Calculations process does not adjust source documents (such as requisitions) for changes in quantity due to rounding.

8. Finds a contract.

If a contract is not specified in the transaction and the transaction source is a requisition or Par Location Replenishment, then the PO Calculations process attempts to find the most recent effective contract for which the transaction item matches on item, category, or open item reference for the already determined Supplier. If the contract does not meet minimum or maximum requirements, the PO Calculations process goes to the next most recent effective contract.

The system looks for a contract that is assigned to a specific purchase order if:

a. The transaction does not contain a PO_HDR_STG row.

This ensures that the system does not override the selection of a purchase order header.

b. The purchase order uses a contract with items associated to a line group.

A line group is a bundle of items that buyers use in PeopleSoft Sourcing to obtain better pricing for items. When a sourcing event is awarded to a purchase order and the items awarded are part of a line group, the system applies contract pricing from that line group to the specified Supplier.

c. The contract price and UOM match the transaction price and UOM.

If the transaction does not meet these requirements, then the PO Calculations process goes to the next most recent effective contract.

Because the PO Calculations process has not calculated the price at this point, it uses the item or Supplier base price when editing against minimum or maximum requirements. The contract maximums are verified at the line level. If you have multiple lines in a purchase order with the same item ID, then the sum of those line quantities and amounts is verified against the contract line maximums.

The contracts that the PO Calculations process reviews are restricted to the specified business unit when the contracts are set up in the system by business unit.

If a contract is specified on the stage table row (through online requisition or a contract release), the PO Calculations process ensures that the contract is still effective and that the maximum amounts and quantities have not been exceeded. If the contract is not still effective or the maximum amount or quantity is exceeded, then the PO Calculations process rejects the transaction. If a contract ID is specified, the PO Calculations process does not search for a different contract.

The PO Calculations process updates the contract release amounts. If you make a change in the Sourcing Workbench, run the PO Calculations process again before you run the Create Purchase Orders process. When you run the PO Calculations process again, the related contract updates are reversed.

Note: The PO Calculations process does not search for contract lines for items ordered by description. However, the PO Calculations process uses a contract that allows open items for both description-only and item ID lines.

When the PO Calculations process runs for a requisition and the process finds a blanket purchase order to use to fulfill the request, the PO Calculations process reserves the blanket purchase order. If you run the PO Calculations process again before running the Create Purchase Orders process, and the process finds a request for which the same blanket purchase order applies, the request line is assigned an error status. This is because the blanket purchase order is reserved by the previous run of PO Calculations process and cannot be accessed for sourcing the current request. To resolve the error, run the Create Purchase Order process to release the reserved blanket purchase order and recycle the row in *Error* status through the PO Calculations process.

9. Finds a Vendor rebate agreement.

If you are using the vendor rebate functionality, this process will determine and assign the appropriate vendor rebate agreement to the purchase order line. The PO Calculations process uses the same default hierarchy strategy when assigning a vendor rebate agreement as when creating a purchase order online.

See [Vendor Rebate Processing on the Purchase Order](#).

10. Finds a procurement card or Supplier card to use as the payment method.

If you are using the procurement card functionality, this process will determine and assign the appropriate procurement card or Supplier card to the purchase order line. The PO Calculations process uses a hierarchy strategy when assigning the correct card number to a purchase order line.

See [Understanding the PO Calculations Process](#).

11. Calculates the price.

If you select the calculate price option, the PO Calculations process recalculates the price. The process begins with the price from the item. If it finds a contract or if a contract is specified, and the contract indicates to use the contract base price, the PO Calculations process uses the contract base price as the starting price instead of the item price. If no contract exists, or if the contract does not indicate to use the contract base price, and the PO Calculations process finds an item Supplier price, it uses the item Supplier price as the starting price instead of the item price.

When finding an item Supplier price, the PO Calculations process searches the item Supplier prices in this order and stops at the first place that it finds a price:

- Item Supplier price for the transaction UOM and transaction currency.
- Item Supplier price for the transaction UOM and Supplier location currency (the PO Calculations process converts it to the transaction currency).
- Item Supplier price for the default UOM and transaction currency (the PO Calculations process converts it to the transaction UOM).
- Item Supplier price for the default UOM and Supplier location currency (the PO Calculations process converts it to transaction UOM and transaction currency).

- Item price.

Once the PO Calculations process has the starting price, it then applies contract and Supplier price adjustments as indicated by the pricing rules. The process also creates value adjustments to show the starting price and each price adjustment.

The sourcing price tolerances are set at the business unit level on the Purchasing Definition - Business Unit Options page and follow the PeopleSoft Purchasing default hierarchy.

12. Calculates miscellaneous charges, freight, sales and use tax, and value-added tax (VAT).

13. Separates POs by Ship To Location

The PO Calculations process will separate POs by unique Ship To Location if the related Supplier / Business Unit setting indicates to do so with the following qualifications:

If the **Define PO** option is set (that is, via Requisition Selection) and the Supplier/BU setting is defined to create Separate POs based on Ship To, the resulting PO will have the same structure to match the Requisition structure even though the resulting PO schedules have a mix of Ship To Locations. In this case:

- The PO is not split.
- The PO Header “Use One Ship To” is turned off and the PO retains multiple Ship To’s.
- PO Create will later send the Enterprise Components Notification Framework message to the buyer alerting that the PO was not split.

For POs with One-time addresses or Direct Shipments containing one or more Ship To locations and the Supplier or BU setting is defined to create separate POs for each Ship To location:

- PO Calculations will split schedules based on unique Ship To locations with the **Use One Ship To** flag turned ON for each resulting PO.
- The One-Time Addresses, Direct Shipments, or both will be retained in a separate PO with the **Use One Ship To** flag turned OFF. Notifications for this type of scenario will not be sent.

14. If the Automatic Item Substitution is selected at the BU Level Option, and the **Auto Item Substitution** field is selected and the **Original Substitute Item** field in the staging record is populated, then the sourcing process will use this Item ID when searching for Substitute Items. However, if the **Original Substituted Item** field in the staging record is not populated, it will use the Item ID value when searching for Substitute Items.

The Sourcing process performs the Item Substitute Usage Rules to search for Substitute Items and determines the most appropriate Substitute Item to use for the Original Substituted Item.

For information on Item Substitute Usage Rules, see [Understanding Item Substitution in Procurement Item Substitute Usage Rules](#).

If a substitute item was specified in the Requisition and PO Sourcing found a different Item Substitute (perhaps with a different date), PO Sourcing uses the most valid substitute item for the purchase order. PO Sourcing will update the Original Substituted Item and Description if it finds a valid substitute. The system does not check for substitutes of substitutes.

PO Sourcing bypasses Item Substitution if a Procurement Group is associated with the line and the Item is the Primary Unit for the Procurement Group or the **Allocate Purchasing Group** option is enabled in the Business Unit Options table.

PO Sourcing will follow the same UOM Conversion and Pricing logic done for Online Requisitions.

Example: Item 10012 is selected in a requisition. An applicable item substitute item does exist for this item. Because the BU level option indicates to substitute requester's item with substitute, the item in the requisition is changed to 10012A. PO Sourcing will look to determine whether a valid substitute exists for item 10012, the original item in the requisition. If item 10012B is now the most valid item substitute, then this item will be used for the PO.

Technical Details of the PO Calculations Process

The PO Calculations process acts on the PO_ITM_STG table and creates PO_ITM_STG_UD and PO_ITM_STG_VND.

The PO_ITM_STG_UD table contains the recommended Supplier, any other eligible suppliers (for flexible sourcing), and the results of all the calculations (due date, price, UOM conversion, currency conversion, and so on). You can view the PO_ITM_STG_UD table data on the Sourcing Workbench - Sourcing Details page and change the recommended Supplier. If you use the Sourcing Workbench to change a Supplier, you must run the PO Calculations process on the staged row to recalculate values.

The PO_ITM_STG_VND table contains the details for the flexible sourcing method and can be viewed using the Flexible Sourcing page.

If the PO Calculations process has not run, PO_ITM_STG_UD and PO_ITM_STG_VNDR do not exist. If the PO Calculations process has run, but an error was encountered for a staged row, a row may or may not exist in PO_ITM_STG_UD and PO_ITM_STG_VND.

- For basic and cumulative split sourcing, if the PO_POCALC process runs and the staged row has no errors, then 1 row exists in PO_ITM_STG_UD for each row in PO_ITM_STG.

One row also exists in PO_ITM_STG_VND.

- For flexible sourcing, if the PO_POCALC process runs and the staged row has no errors, then multiple rows may exist in PO_ITM_STG_UD for one row in PO_ITM_STG, one row for each possible Supplier.

Each row is for the full quantity in PO_ITM_STG. PO_ITM_STG_VND also has a corresponding row for each Supplier.

- For schedule split sourcing, if the PO_POCALC process runs and the staged row has no errors, then multiple rows may exist in PO_ITM_STG_UD for one row in PO_ITM_STG.

Together, they add up to the full quantity in PO_ITM_STG or possibly more than the full quantity due to UOM rounding.

If the PO Calculations process does not return the expected results, confirm that you have set the **Define PO** option, **Inventory Source** option, and the price tolerances appropriately.

You can review requested prices and tolerances on the Sourcing Workbench - Sourcing Details page. Sourcing price tolerances are set at the business unit level on the Purchasing Definition - Business Unit Options page and can be overridden in the requisition.

Related Links

[Creating Purchase Orders Using the Create Purchase Orders Process](#)

[Manually Selecting Requisitions for Sourcing](#)

[Auto Requisition Selection Page](#)

[Establishing PeopleSoft Purchasing Business Units](#)

[Purchase Order Consolidation](#)

[VAT Processing on the Purchase Order](#)

[SUT Processing on the Purchase Order](#)

[“Closure Calendar Page” \(PeopleSoft Inventory\)](#)

[Sourcing Error Messages](#)

[Establishing PeopleSoft Purchasing Business Units](#)

[Understanding the UOM Conversion Hierarchy](#)

Understanding Sourcing Methods

To use these sourcing methods, select the **Override Suggested Supplier** option on the Sourcing Controls page. If this option is deselected, the system uses the Supplier provided in the transaction.

Basic Sourcing

Basic sourcing, also referred to as sourcing method basic, can be set at the category level and overridden at the item level.

Here is how the Supplier order location is determined:

- If a priority item ship to Supplier exists, the PO Calculations process uses this value for the Supplier ID and order location.
- If a priority item ship to Supplier does not exist, the PO Calculations process identifies the best Supplier by using the Item Region Supplier page, while getting the region from the Ship To Location (SHIPTO_TBL).
- If the item region Supplier does not exist, the system finds the best Supplier by using the priority Supplier from item Supplier definition (ITM_Supplier).
- Once a Supplier is determined and if the Supplier was not selected from the Item Ship To Supplier or the Item Region Supplier tables, the system must determine the appropriate Supplier location to associate with the staged line.

The Supplier location is first provided by default from the ship to order location.

- If the Supplier location is not in the Ship To Order Location table, the system checks the Region Order Location table (REGION_VNDR_LOC) to change the Supplier location associated with the ship to location's region.
- If a priority item Supplier exists, but neither the ship to order location or region order location exist for that Supplier, the PO Calculations process uses the priority item Supplier, with its default order location.
- If a Supplier still isn't found, the Supplier and Supplier order location are obtained from the category priority Supplier for the category.

In basic sourcing, the pricing location comes from the Supplier pricing location indicated by the order location.

Flexible Sourcing

Flexible Supplier sourcing, also referred to as sourcing method Flexible, can be set at the category level and overridden at the item level. With flexible sourcing, the PO Calculations process selects a Supplier based on best price, lead time, item Supplier, and ship to priority Supplier.

With flexible sourcing, the PO Calculations process calculates due dates, prices, item ship to, and item Supplier priority, and then determines the best Supplier for the item based on the weight that you give each criterion. The eligible suppliers come from the item Supplier.

The PO Calculations process bases the Supplier selection on these available criteria:

Term	Definition
Lead Time	The PO Calculations process assigns a percentage rank value to each Supplier based on the number of lead days. The percentage rank is calculated as this Supplier lead days divided by the total lead days for all eligible suppliers.
Price	The PO Calculations process assigns a percentage rank value to each Supplier in the order of price. The percentage rank is calculated as this Supplier price divided by the total price for all eligible suppliers.
Item Ship To Supplier Priority	The PO Calculations process assigns a percentage rank value to each Supplier in the order of item ship to Supplier priority. The percentage rank is calculated as this Supplier item ship to priority divided by the total item ship to priority for all eligible suppliers.
Item Supplier Priority	The PO Calculations process assigns a percentage rank value to each Supplier in the order of item Supplier priority. The percentage rank is calculated as the Supplier item Supplier priority divided by the total item Supplier priority for all eligible suppliers.

The weight of the criteria is set by percentage. You can select how much weight to give to lead time, price, ship to, and Supplier at the category level, at the item level, and on the PO Calculations page. The higher the percentage that you give to one of the criterion, the more weight that criterion has. For example, suppose that you want to select the Supplier based only on lead time, you can give lead time a percentage weight of 100 percent and the Supplier with the best lead time, regardless of price, ship to, or Supplier priority, is selected.

Once the PO Calculations process ranks the suppliers for each of the four criteria, it applies the ranking of each of these criteria to determine the best Supplier. In the case of a tie between suppliers, the process uses the item Supplier priority ranking as a tiebreaker.

The mathematical formula that the process uses is:

$$\begin{aligned} & ((\text{Lead Time} / \text{Sum of lead times}) * \text{Lead time User rank}) + ((\text{Price} / \text{Sum of prices}) * \text{Price User Rank}) \\ & + ((\text{Shipto Priority} / \text{Sum of Shipto Priorities}) * \text{User rank}) + ((\text{Supplier Priority} / \text{Sum of Supplier} \\ & \text{Priorities}) * \text{User rank}) \end{aligned}$$

Note: When you use flexible sourcing, method Flexible, pricing is always done at the schedule level, never at the line level.

Schedule Split Sourcing

Schedule split sourcing, also known as sourcing method Split, can be set at the category level and overridden at the item level. With schedule split sourcing, you can split orders to multiple suppliers at the schedule level, based on predefined percentages. For example, suppose that you want to source 60 percent of all orders for an item or category to Supplier A and 40 percent to Supplier B. Set the sourcing rules to define which suppliers supply this item or category and the percentage that goes to each Supplier.

The PO Calculations process selects suppliers for schedule split sourcing based on where the source method is set.

- If you specify the source method on the item, then the item suppliers are used along with their percentage allocation.
- If you specify the source method on the category, then the category suppliers are used with their percentage allocation.

You must select the **Use Category Source Controls** option at the item category level for the system to use category sourcing controls.

The other sourcing methods source 100 percent of the quantity to the selected Supplier. With schedule split sourcing, each schedule is split so that a portion of the quantity is sourced to each item Supplier.

If the Supplier minimum order quantity is not met, the transaction is rejected.

Note: If you are using the schedule split sourcing method, all established item Supplier relationships must be defined with an allocation value greater than zero and a cumulative total of 100. Schedule split sourcing splits orders among multiple suppliers, not among multiple Supplier locations. Schedule split sourcing cannot split orders among multiple locations for the same Supplier.

Cumulative Split Sourcing

Cumulative split sourcing, also referred to as historic split sourcing and sourcing method Cumulative, like schedule split sourcing, enables you to split orders to multiple suppliers based on predefined percentages. Unlike schedule split sourcing, this method sources the purchase order line to the first Supplier in the priority list until the Supplier's order percentage for the item category is met. Over time, the percentage sourced to each Supplier should be close to the percentage that you define on the Item Supplier Priority page.

Based on the setting in the **Accumulate Level** field on the Item Categories - Category Definition 3 page, the percentage that you define on the Item Supplier Priority page is accumulated based on each run of the PO Calculations process or based on each schedule. You can override this setting using the **Accumulate Level** field on the PO Calculations - Run Controls page.

If you select *Run*, all schedules for the item category being processed in the process run are grouped together when finding a Supplier. All schedules for the category are sourced from the same Supplier.

If you select *Schedule*, the process examines each schedule individually when finding a Supplier and accumulates the percentage for each Supplier based on each schedule. The schedules are assigned to the same Supplier until that Supplier's predefined percentage is met, then they are assigned to the next Supplier until the second Supplier's predefined percentage is met, and so forth through all the available suppliers. It then cycles back to the first Supplier. Each schedule could have a different Supplier.

The schedule accumulate level offers greater and more accurate control, while the run accumulate level offers better performance.

PeopleSoft Purchasing maintains records on historical order amounts to determine to which Supplier the purchase order line should be sourced. This is the only source method that is available only at the category level. The suppliers are selected from the category suppliers.

When you dispatch the purchase order, the total order amount is updated on the category Supplier and on the category to maintain the historical information. The Cumulative Sourcing Update process (PO_POHISTUD) maintains the historical information when you modify category or category-Supplier-level information.

Understanding the Procurement Card Assignment Hierarchy

The PO Calculations process determines the correct procurement card or Supplier card to use on the purchase order as a payment method if you are using the procurement card functionality. This table illustrates how the procurement card or Supplier card is assigned to a purchase order:

<i>If Consolidate Req Lines</i>	<i>If Suggested Supplier Can Be Overridden</i>	<i>If Chosen (or final) Supplier Accepts Cards</i>	<i>If Supplier Card is Available</i>	<i>If Use Procurement Card Specified on Req</i>	<i>Procurement Card That Will Appear on PO</i>
N	N Supplier must be entered in requisition.	N Chosen Supplier does not accept any cards.	N Supplier cannot accept Supplier card if they don't accept any cards.	Not applicable Supplier does not accept any cards.	None
N	Y	N	N	Not applicable Supplier does not accept any cards.	None
N	Y	Y Chosen Supplier accepts cards.	Y	Not applicable Supplier card is always used.	Supplier card

<i>If Consolidate Req Lines</i>	<i>If Suggested Supplier Can Be Overridden</i>	<i>If Chosen (or final) Supplier Accepts Cards</i>	<i>If Supplier Card is Available</i>	<i>If Use Procurement Card Specified on Req</i>	<i>Procurement Card That Will Appear on PO</i>
N	Y	Y	N	N	None Use buyer default procurement card if it is valid.
N	Y	Y	N	Y	Use the specified procurement card if it is valid. If none used, use the buyer default procurement card if it is valid.
Y	Y	N	N	Not applicable Supplier does not accept any cards.	None
Y	Y	Y	Y	Not applicable Supplier card is always used.	Supplier Card
Y	Y	Y	N	N	None Use buyer default procurement card if it is valid.
Y	Y	Y	N	Y	Use the specified procurement card if it is valid. If none used, use the buyer default procurement card if it is valid.

Related Links

[Running the PO Calculations Process](#)

[Defining Purchasing Item Categories](#)

[Defining Purchasing Item Attributes](#)

- [Capturing Item Miscellaneous Charges](#)
- [Understanding the Procurement Card Business Process](#)
- [Understanding the RTV Business Process](#)

Understanding How Contracts are Assigned on Purchase Orders

You can use pricing from contracts for requisitions and purchase orders. Using the **Default Contract on Req** and **Default Contract on PO** check boxes on the Business Unit Options page, you can make contracts available for use with requisitions and purchase orders.

For more information about how contracts are assigned pricing, see [Creating Requisitions Online](#).

See [Contract Pricing for Requisitions and Purchase Orders](#).

PO Calculations Page

Use the PO Calculations page (RUN_PO_POCALC1) to enter the selection criteria for the PO Calculations process.

Enter the run control criteria for the PO Calculations process and to run the process.

Navigation:

Purchasing > Purchase Orders > Stage/Source Requests > PO Calculations

This example illustrates the fields and controls on the PO Calculations page. You can find definitions for the fields and controls later on this page.

The screenshot displays the 'PO Calculations' web page. At the top, there are navigation links for 'Run Control ID', 'aa Report Manager', 'Process Monitor', and a 'Run' button. Below this is a section titled 'POCalculate Selection Criteria' containing several input fields: 'Process Instance', 'Business Unit', 'System Source', 'PO Process that built row', 'Buyer', 'Item SetID', 'Item ID', and 'Category'. To the right of these fields are 'To Business Unit' and a 'Sourcing Method' section with checkboxes for 'Basic', 'Flexible', 'Split', and 'Cumulative', along with an 'Accumulate Level' dropdown set to 'Run Level'. The next section is 'PO Calculate Process Options', which includes fields for '*Buyer' (set to 'VP1'), '*Consolidation Method' (set to 'Business Unit, Supplier'), 'Origin' (set to 'ONL'), 'Purchase Order Date', and 'Purchase Order Reference'. It also features checkboxes for 'Pre-Approve Supplier' and 'Build POs as Approved'. At the bottom, there are 'Save' and 'Notify' buttons on the left, and 'Add' and 'Update/Display' buttons on the right.

PO Calculate Selection Criteria

Selecting field values in this group box limits the selection of staged rows to those that meet the criteria selected. These fields are optional.

Sourcing Method

All sourcing methods are selected by default. The selected methods are included when you run the PO Calculations process. If you do not want to include a particular sourcing method, deselect the check box.

If you do not select any of the sourcing methods, only staged rows with a Supplier provided and the **Override Suggested Supplier** check box deselected are included when you run the PO Calculations process.

<i>Field or Control</i>	<i>Description</i>
Accumulate Level	<p>This is not a selection criteria for the process, but rather is used in conjunction with the cumulative sourcing method. Select a value to determine how to accumulate the percentages for cumulative split sourcing.</p> <p>Select <i>Schedule</i> level if you want each schedule to be examined individually when finding a Supplier. With this accumulate level, the schedules are assigned to the same Supplier until that Supplier's predefined percentage is met, then they are assigned to the next Supplier until the second Supplier's predefined percentage is met, and so forth through all the available suppliers. Then it cycles back to the first Supplier. Each schedule could have a different Supplier.</p> <p>Select <i>Run</i> if you want all schedules for that category being processed during the run to be grouped together when finding a Supplier. With the run accumulate level, all schedules for the category will be sourced from the same Supplier.</p> <hr/> <p>Note: The schedule accumulate level offers greater and more accurate control, but the run accumulate level offers better performance.</p> <hr/>

PO Calculate Process Options

Field or Control	Description
Buyer	<p>(Required) Select the buyer to be used on the purchase order header in the event that the PO Calculations process cannot determine the buyer.</p> <p>The buyer name is carried at the line level on the requisition, so a requisition can have multiple buyers. When the PO Calculations process creates the purchase order header, it must assign a buyer name.</p> <ul style="list-style-type: none"> • If all the staged lines that belong on one purchase order have the same buyer name, the PO Calculations process uses that name on the header. • If the staged lines that belong on the purchase order have different buyer names, or the process that created the staged entry did not specify a buyer name (you can force a buyer name in online requisition selection), the system uses the Supplier buyer name. • If the Supplier buyer name is blank, the system enters the buyer name on the purchase order header.
Consolidation Method	<p>Determines whether purchase orders are consolidated by business unit, Supplier, and buyer or by business unit and Supplier only. The consolidation method applies only to staged rows identified for consolidation.</p> <p>For example, suppose that you choose to consolidate by business unit and Supplier, then all rows with the same Supplier and business unit are grouped onto one purchase order.</p> <p>Alternately, if you add buyer to the consolidation criteria, all rows that have the same buyer, Supplier, and business unit are grouped on a purchase order.</p>
Origin	(Optional) Select an origin to be used on the purchase orders.
Purchase Order Date	Enter a date to be used on the purchase orders, for purchase orders that do not already have a date assigned. If you leave this field blank, the PO Calculations process uses the current system date.
Purchase Order Reference	(Optional) Enter a purchase order reference to be used on the purchase orders. This is a free-form field.

Field or Control	Description
Pre-Approve Supplier	<p>Select this check box to approve the Supplier that the PO Calculations process selects.</p> <p>If selected, the system automatically approves the Supplier recommended by the PO Calculations process, so that you can run the PO Calculations process and the Create Purchase Order process without interruption. If you do not select the Pre-Approve Supplier check box, you must approve the Supplier manually using the Sourcing Workbench.</p> <p>If you change a Supplier using the Sourcing Workbench, you must run the PO Calculations process again for the staged row to be recalculated.</p>
Build POs as Approved (build purchase orders as approved)	<p>Select this check box to have purchase orders created with an <i>Approved</i> status when you run the Create Purchase Orders process. If selected, the process examines auto approval criteria set at the business unit level. If the auto approval criteria are met, the status is set to <i>Approved</i>. If the auto approval criteria are not met, the status is set to <i>Pending Approval</i>, and the purchase order enters the workflow approval business process. If you do not select this check box, the purchase order is created with a status of <i>Open</i>.</p>

Flexible Sourcing Controls

Field or Control	Description
Lead Time Factor %, Ship to Priority Factor %, Price Factor %, and Supplier Priority Factor %	<p>Used for flexible sourcing. To override the category and item settings, enter the percentage weight that you want the PO Calculations process to give the lead time, ship to, price, and Supplier factors when the application process is evaluating suppliers for flexible sourcing. The sum of all four factor fields must add up to 100 percent.</p>

Related Links

[Creating Purchase Orders Using the Create Purchase Orders Process](#)

[Using the Sourcing Workbench](#)

[Purchase Order Consolidation](#)

[Understanding PeopleSoft Purchasing Workflow](#)

Using the Sourcing Workbench

This section provides an overview of the sourcing workbench.

Pages Used to Use the Sourcing Workbench

Page Name	Definition Name	Usage
Sourcing Workbench - Sourcing Details Page	PO_SRC_ANALYSIS	Select sourcing criteria and view the rows of data on the PO_ITM_STG table. Access pages to change the recommended supplier, quantities sourced to each supplier, or correct errors. Along with narrowing the search to specific criteria such as process instances, requisition IDs, purchase order ID, stages, and statuses, you can also search for specific contract SetIDs and contract IDs.
Supplier Information - Summary Page	VNDR_ID1_SUM	Access supplier information for the staged row. Sourcing Workbench - Sourcing Details Page
Item Definition - General: Common Page	INV_ITEMS_DEFIN1	Access inventory item information at the SetID level for the staged row. Sourcing Workbench - Sourcing Details Page
Item Description Page	PO_SRC_ITEM_DESCR	View descriptions for a specific item. Sourcing Workbench - Sourcing Details Page
Maintain Requisitions - Requisition Page	REQ_FORM	Review requisition information for the staged row. Sourcing Workbench - Sourcing Details Page
Maintain Purchase Order - Purchase Order Page	PO_LINE	Access a purchase order created for the staged row. Sourcing Workbench - Sourcing Details Page

Page Name	Definition Name	Usage
Sourcing Workbench - Sourcing Details Page	PO_SRC_ANLSYS_DTL	View further details about a staged row and how to change the supplier and stage status. Sourcing Workbench - Sourcing Page
Sourcing Workbench Page(contracts)	PO_SRC_CNTRCT	View details about the contract for an item. Sourcing Workbench - Sourcing Page
Eligible Suppliers Page	PO_SRC_VNDR_DTL	Select the supplier to use for the order. View details about each of the suppliers for this item.
Sourcing Workbench - Pricing Information Page	PO_SRC_PRICING	View details about the pricing of the item from the requisition.
Sales/Use Tax Page	PO_STG_SUT_INQ	View the sales and use tax information from the purchase order. Sourcing Workbench - Pricing Information Page
Sourcing Workbench - Value Adjustments Page	PO_VAL_ADJ_STG_INQ	View the value adjustments (discounts and surcharges) added to the base price of the item on the purchase order.
VAT Page(value added tax)	PO_ITM_STG_VAT_INQ	View the VAT information for the purchase order schedules. Sourcing Workbench - Pricing Information Page
Flexible Sourcing Page	PO_SRC_ANLSYS_VNDR	View how a supplier was chosen using the flexible sourcing method during the PO Calculations process. The supplier score section shows how the system rated each criteria.
Sourcing Workbench - PO Information (purchase order information) Page	PO_STG_SCHED_DTLS	View details about the purchase order that is going to be created.

Understanding the Sourcing Workbench

The Sourcing Workbench component provides you with a view of the results of each of the sourcing steps. The Sourcing Workbench enables you to view staged rows, along with any errors accompanying them. You can use the component to transfer from the staged row to the source transaction data, change

the status of the source record, correct the source, and recycle the staged row for reprocessing. In addition to working with individual rows, you can recycle and purge multiple rows at once.

In addition to working with individual rows, you can recycle and purge multiple rows at once. You cannot purge completed staged rows from the Sourcing Workbench.

You might want to review the contents of the staging tables before and after each step in the sourcing process. For example, you can use the Sourcing Workbench as described:

1. Run the AutoSelect Requisitions process (PO_REQSORC) and access the Sourcing Workbench to verify that the requisitions have been selected for sourcing.

You can determine whether the result of the requisition is an inventory demand transaction or a purchase order.

If the system creates a purchase order, you can define whether you want the PO Calculations process (PO_POCALC) to calculate a new price or select a supplier for you.

2. Run the PO Stage Load process (PO_POSTAGE) and access the Sourcing Workbench to review the staging tables again to determine whether rows were added.
3. Run the Build Inventory Demand process (PO_REQINVS) and access the Sourcing Workbench to review the staging tables to determine whether the requisition was fully or partially sourced using inventory demand.
4. Run the PO Calculations process and access the Sourcing Workbench to review the staging tables to determine which rows are ready for purchase order creation, which require supplier approval, and which have errors.

You can also review the supplier, price, value adjustments, currency, unit of measure, and other information destined for the purchase order.

5. Run the Create Purchase Orders process (PO_POCREATE) and access the Sourcing Workbench to review the staging tables to determine which rows were sourced to purchase orders and to determine the purchase order IDs for those rows.

Correcting Errors

Select rows that are in error from previous process runs by selecting the **Stage Status** field in the search criteria to *Error*. The error code and a plain text error message appear on the Sourcing Workbench - Sourcing Details page and the Eligible Suppliers page.

In many cases, the error is a result of the supplier defaults. For example, suppose that the supplier does not ship to the requested ship to location. If the error is supplier-related, change the supplier or location on the Sourcing Workbench - Sourcing Details page and update the stage status to *Recycle*, so that the PO Calculations process can reprocess the row.

Another common error is due to exceeded price tolerances. Use the Sourcing Workbench - Sourcing Details page to view the requested price, calculated price, value adjustments, and the tolerances that were used. Based on this information, you can take the appropriate actions to bring the transaction within tolerances.

You can also fix errors that are not a result of the choice of supplier and reset the rows for restaging. On the Sourcing Workbench - Sourcing Details page, update the stage status to *Reset/Purg* (reset/purge) to release the original requisition or contract release so that you can make changes to it. After you change

the status to *Reset/Purg* and purge the staged transaction, you can click the **Source Document** link in the Source Transaction Information section of the Sourcing Workbench - Sourcing Details page to access the source requisition or contract so you can make changes. You must restage the source document through its normal staging process.

Related Links

[Running the PO Calculations Process](#)

[Eligible Suppliers Page](#)

Common Elements Used in the Sourcing Workbench

Field or Control	Description
% Price Tol Over and %Under	Displays the tolerance percent price over and under. This tolerance percent is applied to the suggested price on the requisition and used in the PO Calculations process. If the purchase order price is outside of the tolerance, the PO Calculations process rejects the staged row.
Amount Only	If this check box is selected, the receipt is based on an amount, not a quantity. In an amount-only transaction, the price is set to 0 and the quantity is 1.
Base Price	Displays the price expressed in the base currency.
Calculate Price	If this check box is selected, the PO Calculations process calculates a price. If this check box is clear, the staged row price is used on the purchase order.
Due Date	Displays the due date for the purchase order. This is the date the items are due at the ship to location.
Instance	Displays the process instance of the PO Calculations process that last updated this row.
Location	Displays the Supplier location.
LT Days (lead time days)	Displays the lead time period between submitting the purchase order to the receipt of goods.
PO Stg ID/PO Stage ID	Displays the PO Stage ID. This is the same as the requisition ID when the PO stage type is <i>R</i> . It is taken from <code>INSTALLATION_PO.LAST_PO_STG_ID</code> when the PO stage type is <i>O</i> .
PO Stg Type/PO Stage Type	<i>Requisition</i> for the AutoSelect Requisitions process or online requisition selection when the Define PO check box is not selected. The system uses <i>Other</i> for any other process.

Field or Control	Description
Price	Displays the requisition price for the item.
Price Tol (price tolerance), Over , and Under	Displays the tolerance amount applied to the suggested price on the requisition and used in the PO Calculations process. The PO Calculations process calculates the correct price for a purchase order based on the item prices plus or minus any price adjustments. The sourcing unit price tolerance is applied to the suggested price on the staged row and is compared with the calculated purchase order price. If the purchase order price is outside of the tolerance, the PO Calculations process rejects the staged row.
Std Quantity (standard quantity)	Displays the requisition quantity expressed in the standard unit of measure for this item.
Quantity	Displays the requisition quantity being sourced to the selected supplier.
Requisition ID	If this row came from a requisition, the ID of the requisition appears.
Sched Num (schedule number)	Displays the schedule number on the original request.
Ship To	Displays the location where the items are being shipped.
Src Method (sourcing method)	Displays the sourcing method for this row. It determines how the supplier is selected for this line. Sourcing method appears by default from the item category or item ID. Values are <i>Basic</i> , <i>Flexible</i> , <i>Sched Split</i> (schedule split), and <i>Cumulative Split</i> .
Stg Status (stage status)	Displays the status of the staged row.
Sys Source (system source)	Displays the source of the purchase request. Values include <i>Planning</i> , <i>Production</i> , or <i>PO Online</i> (purchase order online).
Unit	Displays the business unit of the purchase request.
Use This Supplier	Select the supplier to use for this order. When there are multiple eligible suppliers, select the corresponding check box for the supplier of your choice. When you change the supplier, the Let POCalc Override Supplier check box on the Sourcing Workbench - Sourcing Details page is cleared to ensure that the PO Calculations process does not choose a different supplier. If you change the supplier on the Eligible Suppliers page or Flexible Sourcing page, you must rerun the PO Calculations process.

Field or Control	Description
Supplier	Displays the supplier to whom the row has been sourced.
Zero Price Ind (zero price indicator)	If this check box is selected, indicates that the price for this item is zero.

Related Links

[Automatically Selecting Requisitions for Sourcing](#)

[Manually Selecting Requisitions for Sourcing](#)

[Running the PO Calculations Process](#)

Sourcing Workbench - Sourcing Page

Use the Sourcing Workbench - Sourcing page (PO_SRC_ANALYSIS) to select sourcing criteria and view the rows of data on the PO_ITM_STG table.

Use pages to change the recommended supplier, quantities sourced to each supplier, or correct errors. Along with narrowing the search to specific criteria such as process instances, requisition IDs, purchase order ID, stages, and statuses, you can also search for specific contract SetIDs and contract IDs.

Navigation:

Purchasing > Purchase Orders > Stage/Source Requests > Sourcing Workbench > Sourcing Workbench - Sourcing

This example illustrates the fields and controls on the Sourcing Workbench — Sourcing. You can find definitions for the fields and controls later on this page.

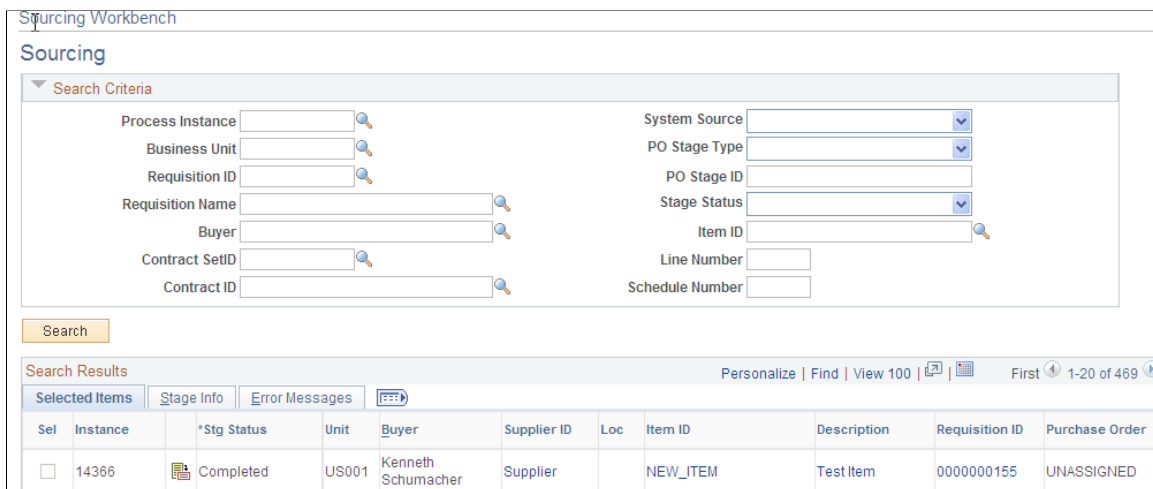

Use this page to define the criteria that you want to use to view or update a purchase order line and its sourcing details. After defining search criteria, click the **Search** button to view the search results based on the criteria. The system provides the search results in the lower portion of the page and you can click on links to view vendors, items, requisition, and purchase order details. You can also select the Stage Info tab to view additional details about the staged line, including for example, the contract SetID, contract

ID, and contract line if the row is associated with a contract. Finally, you select the Message tab to view messages for a row of data when its stage status is *Error*.

Field or Control	Description
Process Instance	Select the process instance related to the PO Calculations process.
System Source	Select a Purchasing Requisition Loader process system source. The process checks a source to determine if any transactions are available for requisition creation. Field values include: <i>IN Batch</i> (PeopleSoft Inventory batch) <i>PO Online</i> (purchase order online) <i>Planning</i> <i>Production</i> <i>sProcure</i> (PeopleSoft Services Procurement)
Business Unit	Select a business unit on which to base a search. If you do not make a selection, the system returns search results for all business units.
PO Stage Type (purchase order stage type)	Select to limit the search to a stage type. Values are <i>Requisition</i> for the AutoSelect Requisitions process or online requisition selection when the Define PO check box is not selected. The system uses <i>Other</i> for any other process.
Requisition ID	Select the requisition ID to which this requisition line belongs.
PO Stage ID	Displays the purchase order stage ID. This is the same as the requisition ID when the purchase order stage type is <i>R</i> .
Requisition Name	Select a name that is used to describe a requisition. If the requisition was created in eProcurement, the system uses that name with the core requisition.
Stage Status	Select the staged row status that you want to include in the sourcing search. If you do not enter a status, the system retrieves lines in all statuses that meet other search criteria. These statuses include for example: <i>Completed</i> , <i>Create PO</i> , and <i>Pending</i> .
Buyer	Select a buyer on whom you want to base the requisition search.
Item ID	Select an item ID to retrieve only staged rows for the item.

<i>Field or Control</i>	<i>Description</i>
Contract SetID	Select a SetID in which the contract that you want to retrieve is located. The value you select determines the contracts that are available for use in the Contract ID field.
Line Number	Enter a purchase order line number for which to retrieve staged rows.
Contract ID	Select the contract for which you want to retrieve staged rows.
Schedule Number	Enter a purchase order schedule number for which to retrieve staged rows.

After defining selection criteria, click the **Search** button and the system returns the item data rows that match the criteria.

Sourcing Workbench Search Results

The system displays the search results on the Selected Item, Staged Rows, and Message tabs. Using the tabs you can link to a variety of information about the staged item. Select the **Sel** (select) check box to mark a specific row of data for processing. You can only select the field if the row of data is available for updating.

Along with linking to staged row details, you can use this page to purge and recycle multiple rows in a staged status. You can only perform the recycle and purge actions against those rows of data that have not been greyed out. When the staged status for a row is in a status that cannot be recycled or purged, the system provides error messages when you attempt to set the row for purging or recycling.

After making your selections and clicking the **Purge** or **Recycle** button, click **Save**. The system applies the changes. When you select rows, but the system does not apply an action to the rows, the system deselects the rows after you perform the action.

Note: The system does not issue error messages for actions taken on multiple rows. Messages are only issued for single row changes.

<i>Field or Control</i>	<i>Description</i>
Select All	Select this check box to mark all eligible rows of data for processing. An eligible row is one with a Stg Status field that is not greyed out.
Unselect All	Click this link to clear selected rows of data.

Field or Control	Description
Purge	Click this link to remove selected transactions from the staging tables so that the transaction can be sourced again. When you click the Purge link, the system sets the status to <i>Reset/Purge</i> for the selected rows of data. You can purge data rows with a status of <i>Staged</i> .
Recycle	Select this check box to recycle the selected transactions through the sourcing process. When you click the Recycle link, the system updates the selected transactions that have a stage status of <i>Error</i> to as status of <i>Recycle</i> . The system does not update data rows with the status of <i>Stage</i> and leaves the status unchanged because staged rows cannot be recycled.

Sourcing Workbench - Sourcing Details Page

Use the Sourcing Workbench - Sourcing Details page (PO_SRC_ANLSYS_DTL) to view further details about a staged row and how to change the supplier and stage status.

Navigation:

Purchasing > Purchase Orders > Stage/Source Requests > Sourcing Workbench > Sourcing Workbench - Sourcing

Click the Sourcing Details button on the Sourcing Workbench - Sourcing page.

This example illustrates the fields and controls on the Sourcing Workbench - Sourcing Details page (1 of 2). You can find definitions for the fields and controls later on this page.

Sourcing Workbench

Sourcing Details

[Return to Sourcing Page](#)

Process Instance 972 Business Unit US001 Line 75 Schedule 1	Item ID 10088 Travel Fly Rod Original Substituted Item <input type="checkbox"/> Substitute Item found during Sourcing PO Stg Type Other PO Stage ID 000000031
--	--

[Expand All](#) [Collapse All](#)

Staging Information

*Stage Status PO Create In Process	PO Process Planning
Staged Supplier SCM0000003 TRAILBLAZE-001 Eligible Suppliers	System Source Planning
Supp Loc MAIN <input type="checkbox"/> Let POCalc Override Supplier?	Sourcing Method
Contract not Assigned PO ID UNASSIGNED	Pricing Information Schedule Details

This example illustrates the fields and controls on the Sourcing Workbench - Sourcing Details page (2 of 2). You can find definitions for the fields and controls later on this page.

<p>Source Transaction Information</p>	
<p>IN Unit US010</p>	<p>Source Document</p>
<p><input type="checkbox"/> Inventory Source Flag</p>	
<p>Qty Demand</p>	
<p>Physical Nature</p>	
<p><input type="checkbox"/> Consolidate with other Reqs</p>	
<p>Requested Price</p>	
<p>Ship To US001</p>	<p><input type="checkbox"/> Amount Only</p>
<p>Due Date 07/31/2000</p>	<p><input type="checkbox"/> Zero Price Ind</p>
<p><input checked="" type="checkbox"/> Calculate Price</p>	
<p>Quantity 2400.0000 EA</p>	<p>Price Tol Over 0.00000</p>
<p>Std Quantity 2400.0000 EA</p>	<p>Under 0.00000</p>
<p>Price 0.00000 USD</p>	<p>%Price Tol Over 999.99</p>
<p>Base Price 0.00000 USD</p>	<p>% Under 999.99</p>

Field or Control	Description
Original Substituted Item	Displays the original item ID on a procurement transaction that is being substituted. Once an Original Substituted Item is designated for a procurement transaction, it is carried all the way through to the receipt and cannot be changed. (The fieldname is also referred to as Original Item in some cases where the Item may or may not have been substituted.)
Substitute Item Found During Sourcing	Indicates whether or not the Substitute Item has been found specifically during the PO Sourcing batch process

Staging Information

Field or Control	Description
Stage Status	<p>Select a stage status. You can change the stage status from <i>Error</i> to <i>Recycle</i> or to <i>Reset/Purge</i> after you have corrected the error on this row, so that the PO Calculations process can reprocess the staged row.</p> <p>To recycle and purge multiple staged rows of a purchase order, click the Return to Sourcing Page link.</p> <p>If the PO Calculations process fails, change the status from <i>POCALC</i> to <i>Recycle</i> as long as the process is no longer running.</p> <p>If the length of federal award fields exceed the length values defined in the setup, or if you enter values into the PIID and Parent PIID is not defined, then the sourcing workbench stage status shows error.</p>

Field or Control	Description
PO Process (purchase order process)	Displays the sourcing process used to place the row of data into the staged table. Examples of the processes include contract purchase order, manufacturing load, and autoselected by the system.
Staged Supplier	<p>Select a different supplier. This field is available for entry when the stage status is <i>Staged</i>, <i>Pending</i> (pending approval), <i>Error</i>, or <i>Recycle</i>. An item supplier relationship must exist if the Accept Any Supplier option is <i>N</i> (no) at the business unit or item level.</p> <p>If you are using the <i>Flexible</i> sourcing method and have run the PO Calculations process, all eligible suppliers appear on the Eligible Suppliers page. Choose a supplier on the Eligible Suppliers page by selecting the Use This Supplier option.</p> <p>To make an informed decision about the supplier selection, use the Flexible Sourcing page to view all factors involved in the selection of the recommended supplier by the PO Calculations process.</p> <p>If you change the supplier for a schedule, there are other schedules on the same purchase order line, and the line is priced at the line quantity, the system issues a warning that all schedules must be priced again. If you choose to reprice the schedules, the stage status on each one changes to <i>Recycle</i>.</p> <p>When you change the supplier, the Let POCalc Override Supplier check box is clear, to ensure that the PO Calculations process does not choose a different supplier.</p>
Supplier Loc (supplier location)	You can enter a different supplier location under the same circumstances that you can change the supplier for this staged row.
Let POCalc Override Supplier	Select to allow the PO Calculations process to override the supplier for this line. To use the supplier that you select for this line, ensure that this check box is clear.
Contract ID	Displays the contract number associated with this process instance. Click the link to view details about the contract, including its SetID, contract ID, and contract line.

Field or Control	Description
Pricing Information	Click this link to access the Sourcing Workbench - Pricing Information page. The page provides details about the pricing of the item from the requisition. See Sourcing Workbench - Pricing Information Page .
PO ID (purchase order ID)	Displays the purchase order to which this line was sourced. If the line is split sourced and multiple purchase orders are created, the <i>Multiple</i> link appears.
Supplier Details	Click to access the Supplier Information page where you can search for and maintain supplier details.
Eligible Suppliers	Click this link to access a secondary page with details about the supplier for this item. Included in the details are the supplier ID, whether or not its a recommended supplier, the requisition quantity and the sourcing method. See Eligible Suppliers Page .
Schedule Details	Click this link to access the Sourcing Workbench - PO Information page where you can view details about the purchase order that is going to be created. See Sourcing Workbench - PO Information (purchase order information) Page .
Message	If you enter a value for the Federal award data that exceeds the length defined at the Installation page, the system will display an error message on the page. Also if you enter values into the PIID and Parent PIID is not defined, then the system will display the error message.

Source Transaction Information

Field or Control	Description
IN Unit (inventory unit)	Appears if this transaction is created through the PO Stage Load process. This is the PeopleSoft Inventory business unit from planning or manufacturing.

Field or Control	Description
Source Document	Click this link to access the transaction from which this line originated. If this line is sourced from a requisition, selecting the link accesses the requisition.
Inventory Source Flag	If this row is to be sourced from PeopleSoft Inventory rather than onto a purchase order, this check box is selected.
Qty Demand (quantity demand)	Quantity sourced from inventory demand through the Build Inventory Demand process. This quantity is always in the item's standard unit of measure.
Physical Nature	Displays whether the type of item is a goods or service item.
Consolidate with other Reqs (consolidate with other requisitions)	Appears selected if the row originated from a requisition configured to allow the row to be consolidated onto the same purchase order with other rows meeting select criteria, such as having the same item or supplier. The consolidation takes place during the PO Calculations process.

Note: Source information does not appear if the system source is Maintenance Management (WM).

Procurement Card For Payment

This group box will only appear if you are using a procurement card as a payment method for the purchase order.

Field or Control	Description
Card Number, Card Type, and Expiration Date	Displays the procurement card information that will be used for payment on the purchase order.

Requested Price

Field or Control	Description
Amount Only	Indicates that the source requisition has a requisition line specified as amount only. If this check box is selected, the Consolidate with other Reqs and the Inventory Source Flag check boxes are not available for entry.
Zero Price Ind (zero price indicator)	Indicates that the line item is zero-priced.

Field or Control	Description
Calculate Price	Indicates that the PO Calculations process recalculates the sourced purchase order price based on the supplier selected. If this check box is deselected, the requisition price is the purchase order price.
Message	A plain text warning or error message appears if the stage status is either <i>Error</i> or <i>Warning</i> .

Related Links

[Building Inventory Demand Transactions](#)

[Running the PO Calculations Process](#)

[Eligible Suppliers Page](#)

[Flexible Sourcing Page](#)

[Purchase Order Consolidation](#)

Eligible Suppliers Page

Use the Eligible Suppliers page (PO_SRC_VNDR_DTL) to select the supplier to use for the order.

View details about each of the suppliers for this item.

Navigation:

Click the **Eligible Suppliers** link on the Sourcing Workbench - Sourcing Details page.

Suppliers

Field or Control	Description
Supplier	Displays all suppliers that are eligible for this transaction.
Recommended Supplier	This check box is selected for the preferred supplier for this item based on the supplier selection method in use.

Field or Control	Description
Use This Supplier	<p>Enables you to select the supplier to use for this order. When there are multiple eligible suppliers, you can select a supplier by selecting this check box for that supplier. When you change the supplier, the Let PO Calc Override Supplier check box on the Sourcing Workbench - Sourcing Details page is cleared to ensure that the PO Calculations process does not choose a different supplier.</p> <hr/> <p>Note: If you change the setting of the Use This Supplier check box, you must rerun the PO Calculations process.</p> <hr/>

Field or Control	Description
Src Method (sourcing method)	Displays the method used to source to a supplier. To use sourcing methods, select the Override Suggested Supplier check box on the Sourcing Controls page. If the check box is deselected, the system uses the supplier provided on the transaction. Sourcing methods include basic, flexible, schedule split, and cumulative split sourcing.
Req Qty (requisition quantity)	Displays the quantity defined on the requisition.
PO No (purchase order number) PO Line (purchase order line)	Displays the purchase order number and line for the request , if the purchase order has already been created.
Contract ID and Version	Displays the contract ID and version number. If this is left blank, the contract ID and version will be uses as the default value from the sourcing process.

Related Links

[Sourcing Workbench - Sourcing Details Page](#)

Sourcing Workbench - Pricing Information Page

Use the Sourcing Workbench - Pricing Information page (PO_SRC_PRICING) to view details about the pricing of the item from the requisition.

Navigation:

Click the **Pricing Information** link on the Sourcing Workbench - Sourcing Details page.

Price

The **Price** tab displays one row for each eligible supplier.

Field or Control	Description
Price	The calculated unit price, plus any price adjustments appears.
Amount	The extended price for the item being purchased (unit price times the quantity) appears.

The currency in which the price is expressed also appears. The currency code is from the item Supplier's UOM & Pricing Info page. This currency is based on the combination of item ID, supplier ID, supplier location, and unit of measure.

Base/Std Info

Select the **Base/Std Info** tab.

Field or Control	Description
Qty Std UOM (quantity standard unit of measure)	Quantity ordered expressed in the standard UOM for this item appears.
Price Base	Unit price expressed in the currency of the PeopleSoft Purchasing business unit (base currency) appears.
Base Amt (base amount)	Monetary value of the line appears. This is the quantity multiplied by the unit price, expressed in the base currency for the business unit.

Contract

Select the **Contract** tab.

Field or Control	Description
Contract ID	Displays the contract ID from where the item price was obtained.
Version	Displays the version of the contract that determined the item price. Versions are available when the business unit is set up to use contract versions.

Field or Control	Description
Line	Displays the contract line that was used to determine the item price.
Release	Displays the release number for the contract.
Milestone Line	Milestone number associated with the selected contract line and release appears.

Related Links

[Sourcing Workbench - Pricing Information Page](#)

[Understanding Multicurrency Conversions](#)

[Understanding the Supplier Location Hierarchy and Multicurrency Pricing](#)

Sales/Use Tax Page

Use the Sales/Use Tax page (PO_STG_SUT_INQ) to view the sales and use tax information from the purchase order.

Navigation:

Click the **Tax Amount** button on the Sourcing Workbench - Pricing Information page.

Sales/Use Tax Info

Field or Control	Description
Sale/Use Tax Applicability	Displays the sales and use tax applicability rule. This indicates whether sales and use tax is applicable for the specific supplier location and how sales tax is applied. Values are: <i>Item is Exempt.</i> <i>Purchaser is Exonerated.</i> <i>Sales Tax Appl</i> (sales tax applicable). <i>Direct Pay.</i> <i>Use Tax Appl</i> (use tax applicable).
Sales/Use Tax Exception Type	The SUT exception type appears by default from the ship to location for the SUT destination code. Values are <i>Direct Pay</i> , <i>Exempt</i> , or <i>None</i> .

Field or Control	Description
Sales/Use Tax Exception Certif (sales/use tax exception certificate)	The SUT exception certificate ID appears by default from the ship to location for this SUT destination code.
Tax Code	Sales and use tax code that contains the various taxing authority information for this ship to location.
Include VAT	If this check box is selected, indicates that VAT should be included in the amount total before the SUT amount is calculated.
Include Freight	If this check box is selected, indicates that freight costs should be included in the amount total before the tax is calculated.
Include Misc Charges (include miscellaneous charges)	If this check box is selected, indicates that miscellaneous charges should be included in the amount total before the tax is calculated.

Related Links

[Sales/Use Tax Information for Schedule Page](#)

Sourcing Workbench - Value Adjustments Page

Use the Sourcing Workbench - Value Adjustments page (PO_VAL_ADJ_STG_INQ) to view the value adjustments (discounts and surcharges) added to the base price of the item on the purchase order.

Navigation:

Click the **Value Adjustment** link on the Sourcing Workbench - Pricing Information page.

Value Adjustments

Field or Control	Description
Type	<p>Displays the type of adjustment. Values are:</p> <p><i>Base</i>: The base price from the item's Purchasing Attributes page. This is either the item or supplier price or the standard item price.</p> <p><i>CNT</i>: The price is from a contract.</p> <p><i>TBL</i>: A price adjustment (discount or surcharge) from the item's Price Adjustments page.</p> <p><i>FRT</i>: Freight costs.</p> <p><i>TAX</i>: Sales or use tax.</p> <p><i>OTH</i>: Other miscellaneous adjustments.</p>
Base Price Type	<p>Displays the origin of the starting price when the value in the Type field is <i>Base</i>. Values are:</p> <p><i>Contract</i>: Originated from the contract for the item.</p> <p><i>Item Standard</i>: Originated from the standard item price on the item's Purchasing Attributes.</p> <p><i>RFQ</i>: Originated from the request for quote price.</p> <p><i>Supplier Std</i>: Originated from the standard item and supplier pricing structure on the item's Purchasing Attributes-Item/Supplier page or Price Adjustments page.</p> <p><i>User</i>: Originated when the user-defined price was used, because the staged row was created with the Calculate Price check box not selected.</p>
Adj Meth (adjustment method)	Displays whether the price adjustment is expressed in amount or percentage.
Pct (percentage)	If the adjustment is by percentage, the percentage of the adjustment displays.
Amt (amount)	If the price adjustment is by amount, the amount of the adjustment displays.

Field or Control	Description
Ship To	If this discount or surcharge is from the item's Price Adjustment page, this check box indicates whether the adjustment is based on the ship to used.
UOM (unit of measure)	If this discount or surcharge is from the item Price Adjustment page, this check box indicates whether the adjustment is based on the UOM used.
Min Qty (minimum quantity)	The minimum quantity needed for this adjustment to be applied to this line. This value appears by default from the Item Price Adjustment page. If there is a contract associated with the purchase order, this value could appear by default from the PO Line Price Adjustments page.

Related Links

[Price Adjustments for Schedule Page](#)

“Price Adjustments for Item Line Page” (PeopleSoft Source to Settle Common Information)

VAT (value added tax) Page

Use the VAT (value added tax) page (PO_ITM_STG_VAT_INQ) to view the VAT information for the purchase order schedules.

Navigation:

Click the **VAT** link on the Sourcing Workbench - Pricing Information page.

Value-Added Tax Info

Field or Control	Description
Applicability	<p>Indicates whether VAT should be calculated for this schedule. This appears by default from the Procurement VAT Defaults. While most purchases may be subject to VAT for any of the VAT countries, there may be some items or item categories that are VAT exempt or out of the scope for VAT. You can override the value on the requisition or purchase order. Values are:</p> <ul style="list-style-type: none"> • <i>Exempt.</i> • <i>Exonerated.</i> • <i>N/A: (not applicable).</i> • <i>Outside: (outside scope of VAT).</i> • <i>Suspend: (suspended).</i> • <i>Taxable.</i> • <i>VAT Only.</i>
Code (VAT code)	<p>Defines the VAT percentage and is used to retrieve VAT accounting ChartFields. This code determines how the VAT amount is calculated on a transaction and how that amount is accounted and reported.</p>
Use Type	<p>Indicates which VAT use type is to be used for this purchase order schedule. This code indicates which portion in terms of percent is taxable and which portion may be exempt. It appears by default from the purchasing attributes for the item or from the Purchasing options.</p>
VAT Tran Type (value-added tax transaction type)	<p>Provides a way of categorizing the VAT transactions for reporting purposes.</p>
Description	<p>Displays a description of the VAT transaction type.</p>
VAT	<p>The amount of VAT calculated for the schedule in the transaction currency.</p>
VAT Basis	<p>Indicates the amount on which the VAT was calculated, expressed in the transaction currency.</p>

Field or Control	Description
VAT Recvry (value-added tax recovery)	Indicates how much VAT you expect to recover.
VAT Rebate	Indicates the percentage of VAT that is not normally recoverable but which may be refunded in the form of a tax rebate.

Related Links

[VAT Information for a Schedule Page](#)

[Defining Purchasing Item Attributes](#)

“Understanding VAT” (PeopleSoft Global Options and Reports)

Flexible Sourcing Page

Use the Flexible Sourcing page (PO_SRC_ANLSYS_VNDR) to view how a supplier was chosen using the flexible sourcing method during the PO Calculations process.

The supplier score section shows how the system rated each criteria.

Navigation:

Click the **Flex Sourcing** link on the Sourcing Workbench - Sourcing Details page.

If you change the supplier on the Flexible Sourcing page, you must rerun the PO Calculations process.

Lead Time/Price Tab

Select the **Lead Time/Price** tab.

Field or Control	Description
Supplier Score	Ranking given to this supplier by the PO Calculations process using flexible sourcing.
Recommended Vndr (recommended supplier)	The supplier chosen by the PO Calculations process. Ratings for four criteria (lead time, price, ship to, and supplier priority) are added and the lowest scoring supplier is chosen as the recommended supplier.
Use This Supplier	Enables you to override manually and choose the supplier that you will use.

Field or Control	Description
LT Days (lead time days)	The lead time days value is the time period from submitting the purchase order to receipt of the goods. This appears by default from the item or item category and can be overridden on the requisition. This is one of the four criteria that can be used in flexible sourcing.
LT Factor % (lead time factor percent)	Entered on the item or item category and reflects the value that you have given the lead time days criteria in relation to the other three criteria (price, ship to, and supplier priority) for this item.
Lead Time Rank	Calculated (by item) using the supplier's lead time days divided by the lead time days for all eligible suppliers. This ranks the eligible suppliers based on lead time.
Lead Time Rating	Calculated using the LT Factor % value multiplied by the Lead Time Rank value.
Base Price in Std UOM (base price in standard unit of measure)	The supplier price (before any price adjustments) appears in the supplier standard UOM, along with the base currency code.
Pr Factor % (price factor percentage)	Entered on the item or item category and reflects the value that you have given the best price criteria in relation to the other three criteria (lead time days, ship to, and supplier priority) for this item.
Price Rank	Calculated (by item) using the supplier's base price divided by the base price for all eligible suppliers. This ranks the suppliers for this item based on price.
Price Rating	Calculated using the Price Factor % value multiplied by the Price Rank value.

Shipto/Supplier Priority Tab

Select the **Shipto/Supplier Priority** tab.

Field or Control	Description
Shipto Supplier Priority	Priority given to a supplier for an item for a ship to location. This is assigned by item on the Ship To Locations page.

Field or Control	Description
Shipto Factor %	Percentage that you entered on the item or item category and reflects the value that you have given the ship to supplier priority criteria in relation to the other three criteria (lead time days, price, and supplier priority) for this item.
Shipto Priority Rank	Calculated (by item) using the ship to supplier priority divided by the ship to supplier priorities for all eligible suppliers. This ranks the suppliers for this item based on ship to supplier priority.
Shipto Priority Rating	Calculated using the Ship To Factor % values multiplied by the Ship To Priority Rank value.
Item Supplier Priority	Number ranking of each supplier who supplies this item. This appears by default from the item or item category and can be overridden on the requisition. This is one of the four criteria that can be used in flexible sourcing.
Vndr Factor % (supplier factor percent)	Reflects the value that you have given to the item supplier priority in relation to the other three criteria (lead time, price, and ship to supplier priority) for this item.
Supplier Priority Rank	Calculated (by item) using the supplier's priority divided by the supplier priorities for all eligible suppliers. This ranks the suppliers for this item based on price based on supplier priority.
Supplier Priority Rating	Calculated using the Vndr Factor % value multiplied by the Supplier Priority Rank value.

Related Links

“Defining Ship To Locations” (PeopleSoft Source to Settle Common Information)

Sourcing Workbench - PO Information (purchase order information) Page

Use the Sourcing Workbench - PO Information (purchase order information) page (PO_STG_SCHED_DTLS) to view details about the purchase order that is going to be created.

Navigation:

Click the **PO Schedule Information** link on the Sourcing Workbench - Sourcing Details page.

This example illustrates the fields and controls on the Sourcing Workbench - PO Information page. You can find definitions for the fields and controls later on this page.

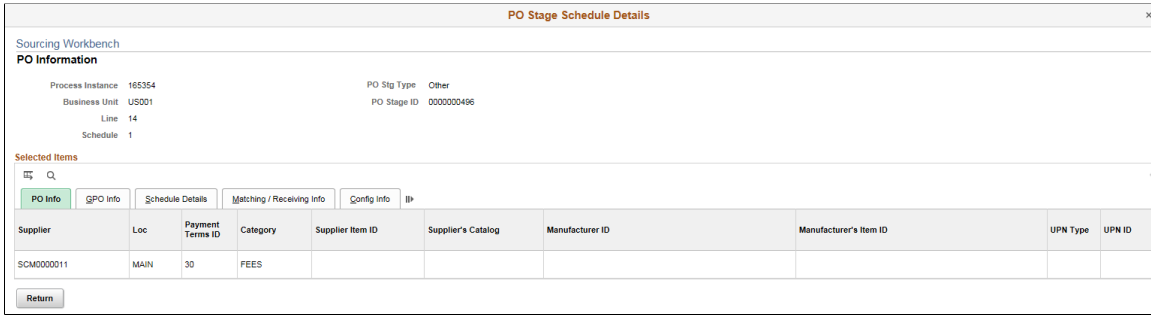

Field or Control	Description
Payment Terms ID	Identifies the payment terms that appear on the purchase order header.
UPN Type	Displays the UPN Type for the PO line.
UPN ID	Displays the UPN ID for the PO line.

GPO Info

Select the GPO Info tab.

Field or Control	Description
GPO ID	Displays the group purchasing organization ID.
GPO Contract Number	Displays the group purchasing organization contract number.

Schedule Details

Select the Schedule Details tab.

Field or Control	Description
Freight Terms	Identifies the freight terms code that applies to the schedules for the purchase order.
Replenish Code	Displays the PeopleSoft Inventory replenishment code for this distribution.

Field or Control	Description
Inspect	If this check box is selected, indicates that inspection is required for the line.

Matching/Receiving Info

Select the Matching/Receiving Info tab.

Field or Control	Description
Unit Price Tolerance and % Unit Price Tolerance	Indicates the amount and percentage variation allowed in the unit price of this item when matching the purchase order, voucher, and receipt.
Ext Price Tolerance (extended price tolerance) and % Ext Price Tolerance	Indicates the amount and percentage variation allowed in the extended price of this line when matching the purchase order, voucher and receipt. Extended price is the quantity ordered multiplied by the item unit price or the item supplier UOM price.
Rjct Ovr % (reject over percent)	Receiving cannot accept a shipment from the supplier that exceeds this percentage of quantity over shipped.
Receiving Required	Displays the receiving requirement for the item. Values are: <ul style="list-style-type: none"> <i>Do Not:</i> If displayed, accounts payable matching and receipt accrual are not applicable. <i>Optional:</i> If displayed, accounts payable will not match receipt lines and the system will not accrue the receipt. <i>Required:</i> If displayed, accounts payable will match receipt lines and the system will accrue the receipt.
Early Ship Rjct Days (early ship reject days)	Receiving cannot accept a shipment that is received early by the number of days indicated by this value.

Config Info (configuration information)

Select the Config Info tab.

Field or Control	Description
Template	The configuration code template ID appears if the item is a configured item.
Config Code (configuration code)	If this is a configured item, the configuration code appears.

Creating Purchase Orders Using the Create Purchase Orders Process

This section provides an overview of the Create Purchase Orders process and discusses how to run the Create Purchase Orders process.

Page Used to Create Purchase Orders Using the Create Purchase Orders Process

Page Name	Definition Name	Usage
Create Purchase Orders Page	RUN_PO_POCREATE	Enter the selection criteria for the Create Purchase Orders process and run the process.

Understanding the Create Purchase Orders Process

The Create Purchase Orders Application Engine process (PO_POCREATE) uses rows in the staging tables that have been processed by the PO Calculations process to create purchase orders. The Create Purchase Orders process maintains the purchase order groupings created by the PO Calculations process to create purchase orders.

The Create Purchase Orders process determines the purchase order ID, assigns line, schedule, and distribution numbers, and creates contract release information for staged rows in the PO_ITM_STG_UD table that meet the selection criteria and are in a *B* (Ready) status. When the Create Purchase Orders process is complete, PO_ITM_STG and PO_ITM_STG_UD are updated with a stage status of *C* and also reflect the assigned purchase order keys and supplier.

If you run the PO Dispatch/Print SQR Report process (POPO005) after this process, the system dispatches purchase orders that were configured on the run control page to be created in *Approved* status.

Related Links

[Creating Purchase Orders Using the Create Purchase Orders Process](#)

[Running the PO Calculations Process](#)

[Dispatch POs Page](#)

Create Purchase Orders Page

Use the Create Purchase Orders page (RUN_PO_POCREATE) to enter the selection criteria for the Create Purchase Orders process and run the process.

Navigation:

Purchasing > Purchase Orders > Stage/Source Requests > PO Creation

PO Creation Selection Criteria

<i>Field or Control</i>	<i>Description</i>
Process Instance	Enter the process instance related to the PO Calculations process. This process instance limits the selection of staged requisitions to those that were put into the PeopleSoft Purchasing stage table.

PO Creation Options

<i>Field or Control</i>	<i>Description</i>
Calculate PO Line Numbers	Select this check box to ignore staged entry line numbers when the Create Purchase Orders process creates new purchase orders and assigns sequential line numbers, beginning with one. If you do not select this check box, system performance may be better, but you may have purchase orders with nonsequential line numbers that do not begin with one.
Hold from Further Processing	Select to place the resulting purchase orders on hold and prevent further processing of the purchase orders.
Allow Dispatch When Appr (allow dispatch when approved)	Select to make the resulting purchase orders eligible for dispatch when you run the PO Dispatch/Print process.

Using the Automatic Purchasing Sourcing Process

This section provides an overview of the Automatic Purchasing Sourcing process

Pages Used to Run the Automatic Purchasing Sourcing Process

Page Name	Definition Name	Usage
PO Auto Sourcing - Objectives Page	RUN_PO_AUTOSRC1	Select the sources for generating purchase orders in order to configure the Automatic Purchasing Sourcing process to run multiple jobs in sequence for the same set of staging records.
PO Auto Sourcing - Options Page	RUN_PO_AUTOSRC2	Specify selection criteria and purchase order creation options that correspond with the selected sources.
PO Auto Sourcing - Results Page	RUN_PO_AUTOSRC_LOG	View the results of the Automatic Purchasing Sourcing process.
Processes Page	RUN_PO_AUTOSRC	(Optional) Select individual purchasing processes to run in sequence for the same set of staging records. PO Auto Sourcing - Objectives Page

Understanding the Automatic Purchasing Sourcing Process

The Automatic Purchasing Sourcing Application Engine process (PO_AUTO_SRC) enables you to select multiple sourcing processes that you want to run and runs the selected processes in the correct sequence on the same set of records. Use the Automatic Purchasing Sourcing process to run these processes:

- AutoSelect Requisitions
- PO Stage Load
- PO Contracts
- Build Inventory Demand
- PO Change
- PO Calculations
- Create PO
- Budget Check
- Doc Tolerance
- PO Dispatch

You have two options for configuring the Automatic Purchasing Sourcing process: you can select the sourcing processes to run and allow the system to identify the parameters that must be defined or you can choose to select the individual processes and enter the criteria manually. Either method results in the

Automatic Purchasing Sourcing process, performing all of the individual sourcing processes that you configure.

Use the PO Auto Sourcing - Objectives page to select the sources from which you want to build purchase orders. This option reduces the need to understand each of the technical processes involved in the Automatic Purchasing Sourcing process and automatically displays the additional criteria and options necessary to generate purchase orders or change orders for the selected sources.

To select each job by process name, click the **Select Individual Processes** link to access the Processes page. This page enables you to select specific processes and then access the criteria or options tab for each process selected. This option is available for users who are more familiar with the technical aspects of the Automatic Purchasing Sourcing processes. As an example, suppose that you select to run the AutoSelect Requisition, Build Inventory Demand, PO Calculations, and the Create Purchase Order processes. The selection criteria for the last three processes becomes unavailable for entry on the pages and the Automatic Purchasing Sourcing process uses the process instance from the AutoSelect Requisition process as the selection criteria.

Once you select the processes to run, enter available selection criteria and processing options for the processes on the appropriate tab from the Processes page. Click the **Run** button on any tab to run the Automatic Purchasing Sourcing process.

Related Links

[Automatically Selecting Requisitions for Sourcing](#)

[Building Inventory Demand Transactions](#)

[Loading Staged Purchase Order Requests from PeopleSoft Supply Planning and Manufacturing](#)

[Running the PO Calculations Process](#)

PO Auto Sourcing - Objectives Page

Use the PO Auto Sourcing - Objectives page (RUN_PO_AUTOSRC1) to select the sources for generating purchase orders in order to configure the Automatic Purchasing Sourcing process to run multiple jobs in sequence for the same set of staging records.

Navigation:

Purchasing > Purchase Orders > Stage/Source Requests > PO Auto Sourcing

This example illustrates the fields and controls on the PO Auto Sourcing — Objective Page. You can find definitions for the fields and controls later on this page.

You use the Objectives page to define the sources for generating purchase orders to configure the Automatic Purchasing Sourcing process to run multiple processes in sequence for the same set of staging records. Use the Create Purchase Orders From section to identify the sources from which you want to create purchase orders automatically.

Click the **Select Processes to Run** to access the Processes page where you can determine which process will be included in automatic sourcing.

See [Using the Automatic Purchasing Sourcing Process](#).

Field or Control	Description
Buyer	Select a buyer to be defined on the purchase order. The system uses this buyer when one is not found through staging tables.
Check Inventory First	Select this check box to have the system run the Build Inventory Demand process first and then run the PO Calculations and Create PO processes. In this case, items with or without sufficient on-hand quantity will all be processed through different channels.
Source From Inventory	Select this check box to have the system run only the Build Inventory Demand process. The system will not run the PO Calculations and Create PO processes afterwards.
Planning	Select to indicate that you want to use PeopleSoft Supply Planning changes.

<i>Field or Control</i>	<i>Description</i>
All Other Sources	Select to indicate that you want to use change requests from all other sources.

PO Auto Sourcing - Options Page

Use the PO Auto Sourcing - Options page (RUN_PO_AUTOSRC2) to specify selection criteria and purchase order creation options that correspond with the selected sources.

Navigation:

Purchasing > Purchase Orders > Stage/Source Requests > PO Auto Sourcing > Options

Processes Page

Use the Processes page (RUN_PO_AUTOSRC) to (Optional) Select individual purchasing processes to run in sequence for the same set of staging records.

Navigation:

Click the **Select Individual Processes** link on the PO Auto Sourcing - Objectives page.

This example illustrates the fields and controls on the Processes page. You can find definitions for the fields and controls later on this page.

Select Processes to Run

Based on the processes that you select, fields on each of the available process tabs become available and unavailable for entry.

Field or Control	Description
AutoSelect Reqs (ReqSore) (autoselect requisitions)	Select to run the AutoSelect Requisitions process.
PO Stage Load (POStage)	Select to run the PO Stage Load process.
PO Contracts (POCntrct)	Select to run the Purchase Order Contracts process.
Build Inv Demand (ReqInvs) (build inventory demand)	Select to run the Build Inventory Demand process.
PO Change (POChange)	Select to run the PO Change process.
PO Calculations (POCalc)	Select to run the PO Calculations process.
Create PO (POCreate)	Select to run the Create Purchase Order process.
Budget Check (FS_BP)	Select to run the budget checking process on the resultant purchase orders Note: This option is available when you enable Commitment Control for Purchasing in “Installation Options - Products Page” (Application Fundamentals)
Doc Tolerance (FS_DOC_TOL)	Select to run the document tolerance checking process on the resultant purchase orders. Note: This option is available when you select “Enable Document Tolerance” option in “Installation Options - Overall Page” (Application Fundamentals)
PO Dispatch (PO_DISPATCH)	Select to run the purchase order dispatch process on the resultant purchase orders.

Note: If the Create PO (POCreate) or the PO Change (POChange) process is not selected, then the Budget Check (FS_BP), Doc Tolerance (FS_DOC_TOL) and PO Dispatch (PO_DISPATCH) options will be hidden.

Purging Purchasing Staging Tables

This section provides an overview of the Purge Stage Tables process and discusses how to run the Purge Stage Table Application Engine process.

Page Used to Purge Purchasing Staging Tables

<i>Page Name</i>	<i>Definition Name</i>	<i>Usage</i>
<u>Purge Stage Tables Page</u>	RUN_PO_POSTGPRG	Enter the selection criteria for the Purge Stage Tables process and run the process.

Understanding the Purge Stage Tables Process

The Purge Stage Tables process (PO_POSTGPRG) purges entries on the PeopleSoft Purchasing staging tables. Only rows in *C* (completed), *E* (error), or *X* (ready to purge) status are eligible for purging.

For rows in an *E* (error) status, the Purge Stage Tables process only purges those that it can reset. This includes staged rows from requisitions or cart (par) replenishment, PeopleSoft Purchasing contract releases, PeopleSoft Supply Planning, and PeopleSoft Production Management. It cannot purge staged rows in error from RFQs.

The tables purged by the Purge Stage Tables process are:

- PO_ITM_STG
- PO_HDR_STG
- PO_DISTRIB_STG
- PO_ITM_STG_UD
- PO_ITM_STG_VND
- PO_VAL_ADJ_STG
- PO_SRC_TMP_BU
- PO_SRC_TMP_FRT
- PO_SRC_TMP_HDR
- PO_SRC_TMP_IVND
- PO_SRC_TMP_TAX
- PO_SRC_TMP_VNDR

PeopleSoft recommends that you run this process at least weekly. In very busy installations, you should consider running the Purge Stage Tables process daily. If you do not run the Purge Stage Tables process

regularly, the staging tables retain old data, which negatively affects performance of processes that act on the tables.

Before purging error rows, the Purge Stage Tables process removes the in process status on the requisition line, and sets the source status on the requisition line to *A* (available).

Requisitions in error status are identifies as in process, while they are in the staging tables. In process requisitions cannot be updated. Running the Purge Stage Tables process on error rows frees up requisitions for error correction.

If you run purge on a requisition in *Error* status on the Sourcing Workbench - Sourcing Details page, it frees the requisition, and sets the stage status on the stage tables to *X*, so it can be purged in this process. If you recycle an error, it has no effect on the requisition, but it sets the stage status on the stage tables to *R*, so the row can be picked up and processed again.

After you run the Purge Stage Tables process, rows in error status that have requisitions associated with them have these results:

- If the requisition was staged by the AutoSelect Requisitions process, the open quantity is reset to the requisition quantity.
- The in process setting is cleared from the requisition.
- Source status on the requisition line is returned to *A*.
- For PeopleSoft Purchasing contracts, it sets the release status back to *O* (open) so the contract can be rereleased.
- For PeopleSoft Supply Planning, it sets the subPO status to *20*, so it can be reselected by the PO Stage Load process.

Related Links

[Automatically Selecting Requisitions for Sourcing](#)

[Building Inventory Demand Transactions](#)

[Loading Staged Purchase Order Requests from PeopleSoft Supply Planning and Manufacturing](#)

[Running the PO Calculations Process](#)

Purge Stage Tables Page

Use the Purge Stage Tables page (RUN_PO_POSTGPRG) to enter the selection criteria for the Purge Stage Tables process and run the process.

Navigation:

Purchasing > Purchase Orders > Stage/Source Requests > Purge Stage Tables

<i>Field or Control</i>	<i>Description</i>
Purge Staged Rows in Error	Select to purge rows in error whose stage status is <i>E</i> (error). This also releases associated requisitions.

Field or Control	Description
Purge Completed Stage Rows	Select to purge completed stage rows and rows ready for purge whose stage status is <i>C</i> (completed), <i>W</i> (warning), or <i>X</i> (ready to purge).
PO Stage Record Type (purchase order stage record type)	Used in combination with purchase order build stage ID to limit the purging of the stage tables to rows originating from a particular staged entry.
PO Stage ID (purchase order stage ID)	Used in combination with the PO Stage Record Type field to limit the purging of the stage tables to rows originating from a particular staged entry.

Manually Constructing the Purchasing Staging Tables

This section discusses how to load the PeopleSoft Purchasing staging tables manually. However, PeopleSoft does not support this approach and is not able to offer further assistance beyond the information that is contained in this section. PeopleSoft Application Designer can provide more information about which fields are required.

These processes populate the PeopleSoft Purchasing stage tables:

- Online requisition selection.
- AutoSelect Requisitions.
- PO Stage Load.
- Requests for quotes.
- Purchase Order Contracts.
- Create Par Replenishment Requests.
- PeopleSoft Maintenance Management integration with PeopleSoft Purchasing for purchase order creation.

Insert a row into PO_ITM_STG for each item and ship to combination:

Field Name	Field Value or Description
PROCESS_INSTANCE	0
BUSINESS_UNIT	Purchase order business unit.
PO_STG_TYPE	0

Field Name	Field Value or Description
PO_STG_ID	INSTALLATION_PO.LAST_PO_STG_ID (<i>Next</i>).
LINE_NBR	Incoming line.
ADD_SCHED_FLG	<i>N</i>
AMT_ONLY_FLG	<i>Y</i> if no quantity is provided. The default is <i>N</i> .
BAL_STATUS	<i>I</i>
BCKORD_ORG_SCHED	Back order original schedule.
BUSINESS_UNIT_IN	(Optional) Normally only used by shop floor subcontracts in PeopleSoft Supply Planning.
BUYER_ID	Desired buyer ID. Can be blank but must be a valid buyer ID if entered.
CALC_PRICE_FLG	<p><i>Y</i> : If price calculation is requested. Must be <i>Y</i> if CONSOLIDATE_FLG is <i>Y</i>. The PO Calculations process expects all staged rows to be in the base currency whenever the CALC_PRICE_FLG or the CONSOLIDATE_FLG are set to <i>Y</i>. When CALC_PRICE_FLG is set to <i>Y</i>, base currency, base price, and base merchandise amount are required fields; and transaction currency, price, and merchandise amount fields are ignored.</p> <p><i>N</i>: If no price calculation is requested. No tolerance checking is performed, because the requisition and purchase order prices will be identical.</p>
CARRIER_ID	(Optional)
CATEGORY_ID	(Required) Incoming category ID.

Field Name	Field Value or Description
CHNG_SOURCE	See translate values. <ul style="list-style-type: none"> • BPA - Single PO • CRT - Cart Repln • DRP - Direct Ships • EDX - EDX • EPR - User • ONL - On-line PO • PLN - Planning • POC - PO Change • PRD - Production • Req - Req
CNTRCT_ID	Incoming contract ID if specified; otherwise, it's blank.
CNTRCT_LINE_NBR	Incoming contract line number if specified; otherwise, it's blank.
CNTRCT_RATE_DIV	Incoming contract rate divisor. Normally, used only by contract release process. The default is <i>1</i> , never <i>0</i> .
CNTRCT_RATE_MULT	Incoming contract rate multiplier. Normally, used only by Contract Release process. The default is <i>1</i> , never <i>0</i> .
CNTRCT_SETID	Incoming contract SetID if a contract is specified; otherwise, leave blank.
CNTRCT_SPEC_FLG	<i>Y</i> : If a contract is specified.
CONFIG_CODE	(Optional) Configuration Code. Normally, it is used only by PeopleSoft Product Configurator.
CONSOLIDATE_FLG	<i>Y</i> : If this PO_ITM_STG line can be merged with similar items on a purchase order. <i>N</i> : If this PO_ITM_STG line must be on its own purchase order.
CONVERSION_RATE	<i>I</i> : Used in the PO Calculations process for unit of measure conversion.

Field Name	Field Value or Description
CONVERT_UOM_FLG	<i>Y</i> : If you want the system to convert to the supplier UOM. Must be <i>Y</i> if the CONSOLIDATE_FLG is <i>Y</i> .
CP_TEMPLATE_ID	(Optional) Configurator Product Template ID. Normally used only by PeopleSoft Product Configurator.
CURRENCY_CD	Transaction currency code.
CURRENCY_CD_BASE	(Required) Purchasing business unit base currency.
DATETIME_MODIFIED	Current DATETIMESTAMP.
DESCR254_MIXED	(Required) Incoming item description.
DISTRIB_MTHD_FLG	<i>A</i> or <i>Q</i> from requisition lines, indicating whether distributions are by amount or quantity.
DOC_BUILT_FLG	<i>N</i>
DUE_DT	Incoming due date if provided or null.
DUE_TIME	Incoming due time if provided or null.
FREIGHT_TERMS	(Optional) Appears by default if not specified.
FROZEN_FLG	Appears by default as <i>N</i> .
INSPECT_CD	(Optional) Incoming inspection code.
INV_ITEM_ID	Incoming inventory item ID. Blank if ordered by description; otherwise, it is required.
INVENTORY_SRC_FLG	Directly from REQ_LINE. <i>Y</i> if an inventory item, otherwise, <i>N</i> .
ITM_ID_VNDR	(Optional) Incoming item ID supplier.
ITM_SETID	(Required) Incoming item SetID.
LEAD_TIME	<i>0</i>

Field Name	Field Value or Description
LIQUIDATE_METHOD	<i>A</i> (amount) <i>Q</i> (quantity)
MERCHANDISE_AMT	Schedule merchandise amount (PRICE_PO * QTY_REQ) in transaction currency.
MESSAGE_NBR	0
MESSAGE_SET_NBR	0
MFG_ID	(Optional) Incoming manufacturer ID.
MFG_ITM_ID	(Optional) Incoming manufacturer item ID.
MILESTONE_NBR	Incoming milestone number. The default is 0.
OP_SEQUENCE	(Optional) Normally, used only by shop floor subcontracts in PeopleSoft Supply Planning.
OPRID	From REQ_HDR.OPRID_ENTERED_BY.
OVERRIDE_SUGG_VNDR	This is required. <i>Y</i> : If SUPPLIER_ID can be overridden by AutoSourcing. <i>N</i> : If the specified supplier must be used.
PCT_UNIT_PRC_TOL	Incoming tolerance. Ceiling for the unit price tolerance. 0 means no variance is allowed.
PCT_UNIT_PRC_TOL_L	Incoming tolerance. Floor for the unit price tolerance. 0 means no variance is allowed.
PHYSICAL_NATURE	<i>G</i> (goods) <i>S</i> (services)
PO_BUILT_FLG	<i>Y</i> : If purchase order is specified. <i>N</i> : If purchase order is unassigned or blank.
PO_ID	Normally, <i>UNASSIGNED</i> appears by default. It can use an existing PO_ID, if PO_HDR_STG is also provided.

Field Name	Field Value or Description
PO_LINE_NBR	Work field. Leave zero.
PO_PROCESS_ID	See translate values. If you add a value, look for places in the application engine code where processing is governed by this value.
PRICE_PO	Specified price is required. PRICE_REQ appears by default. This is stated in transaction currency.
PRICE_REQ	Requested price. Required when ZERO_PRICE_FLG is <i>N</i> . This is stated in transaction currency.
PRICE_REQ_BSE	Specified price in base currency is required. This field is also used for tolerance checking.
PRODUCTION_ID	(Optional) Normally, used only by shop floor subcontracts in PeopleSoft Supply Planning.
PUR_USR_LIN_SBR	User-definable field.
PUR_USR_SHP_SBR	User-definable field.
QTY_DEMAND	Quantity sourced from demand. This should always be 0.
QTY_REQ	Incoming quantity requested.
QTY_REQ_STD	(Required) Same as QTY_REQ, but in standard unit of measure.
RECV_REQ	Receiving required. Values are: <ul style="list-style-type: none"> • <i>Y</i>: Receiving is Required • <i>N</i>: Receiving is Optional • <i>X</i>: Do Not Receive
RELEASE_NBR	Incoming contract release number. The default is 0.
REPLEN_OPT	(Optional) Incoming replenishment code.
REQ_ID	Incoming requisition ID if sourced directly from a requisition (not through an RFQ).

Field Name	Field Value or Description
REQ_LINE_NBR	Incoming requisition ID if sourced directly from a requisition (not through an RFQ).
REQ_SCHED_NBR	Incoming requisition ID if sourced directly from a requisition (not through an RFQ).
REVISION	Revisions.
RFQ_ID	Incoming RFQ ID.
RFQ_LINE_NBR	Incoming RFQ line number.
ROUTING_ID	(Optional) Appears by default if not specified.
SCHED_NBR	Incoming schedule sequence.
SEQ_NUM	Used for contracts. The default is 0.
SHIP_TYPE_ID	(Optional) Appears by default if not specified.
SHIPTO_ID	Incoming ship to ID.
SHIPTO_SETID	Incoming ship to SetID.
SOURCE_DATE	Date to be used for sourcing selection. The current date appears by default.
SRC_METHOD	Method to use to find supplier. Default is B for basic.
STAGE_STATUS	S (staged)
SUT_BASE_ID	(Required) Incoming sales and use tax base ID. It is usually the same as the ship to ID.
SYSTEM_SOURCE	See translate values.
ULTIMATE_USE_CD	(Optional) Incoming ultimate use code.
UNIT_MEASURE_STD	Standard unit of measure for item. UNIT_OF_MEASURE appears by default.

Field Name	Field Value or Description
UNIT_OF_MEASURE	If non-standard, conversion rate must exist for the preferred supplier or the inventory item.
UNIT_PRC_TOL	Incoming tolerance. Ceiling for the unit price percent tolerance. <i>0</i> means no variance allowed. Must be expressed in base currency. Tolerance checking takes place after transaction price and base price have been calculated, and then the converted base price is compared against the original requisition price.
UNIT_PRC_TOL_L	Incoming tolerance. Floor for the unit price percent tolerance. <i>0</i> means no variance allowed. Must be expressed in base currency.
SUPPLIER_ID	Incoming supplier ID required if OVERRIDE_SUGG_VNDR is <i>N</i> ; otherwise, it can be blank.
SUPPLIER_SETID	(Required) Incoming supplier SetID.
VNDR_CATALOG_ID	(Optional) Incoming supplier catalog ID.
VNDR_LOC	Supplier order location. Required if SUPPLIER_ID is specified.
WM_WO_SBR Contains BUSINESS_UNIT_WO, WO_ID, WO_TASK_ID, RSRC_TYPE, RES_LN_NBR	This subrecord contains PeopleSoft Maintenance Management work order business unit, work order ID, task number, resource type, and resource line number.
WORK_ORDER_ID	PeopleSoft Services Procurement work order ID.
ZERO_PRICE_IND	Must be <i>Y</i> if PRICE_PO on created purchase order must be <i>0</i> . If this is <i>Y</i> , set CALC_PRICE_FLG to <i>N</i> .

Optionally, insert a row into PO_HDR_STG for rows on PO_ITM_STG with the same PO_STG_TYPE and PO_STG_ID, and where CONSOLIDATE_FLG is equal to *N*. If PO_HDR_STG exists, all header information comes from this table; otherwise, it comes from the defaults or the purchase order assigned to the transaction during the PO Calculations process (for blanket purchase orders), if applicable. This table is optional, because it is only used to force information into the purchase order header.

Field Name	Field Value or Description
PROCESS_INSTANCE	Can be <i>0</i> or actual value.
BUSINESS_UNIT	(Required) Purchasing business unit.

Field Name	Field Value or Description
PO_STG_TYPE	(Required) Same as PO_ITM_STG.
PO_STG_ID	(Required) Same as PO_ITM_STG.
PO_DT	(Required) Desired purchase order date.
PO_REF	Desired purchase order reference.
PYMNT_TERMS_CD	(Required) Desired payment terms code.
BUYER_ID	Desired buyer ID.
ORIGIN	Desired origin.
ADDRESS_SEQ_NUM	(Required) Desired supplier order address sequence.
CNTCT_SEQ_NUM	(Optional) Desired contact sequence.
SALES_CNTCT_SEQ_N	(Optional) Desired sales contact sequence.
BILL_LOCATION	(Required) Desired bill to location.
TAX_EXEMPT	(Required) Desired tax status is <i>Y</i> or <i>N</i> .
TAX_EXEMPT_ID	Desired tax exempt ID, if applicable.
CURRENCY_CD	Desired currency code. Must be same as on PO_ITM_STG.
RT_TYPE	Desired currency rate type.
RATE_DATE	Used by the Contract Release process. All other processes should set it to purchase order date.
SUPPLIER_SETID	Specified supplier SetID (must match supplier SetID on PO_ITM_STG).
SUPPLIER_ID	Specified supplier SetID (must match supplier SetID on PO_ITM_STG).
VNDR_LOC	Specified supplier location (must match supplier location on PO_ITM_STG).

Field Name	Field Value or Description
PO_ID	UNASSIGNED, blank, or actual purchase order ID.
PO_BUILT_FLG	Y if the purchase order is specified. N if the purchase order is unassigned or blank.
PO_PROCESS_ID	See translate values. If you add a value, be sure to look for places in the application engine code where processing is governed by this value. Must match PO_PROCESS_ID on PO_ITM_STG.
DISP_ACTION	Desired dispatch action.
DISP_METHOD	Desired dispatch method.
PO_TYPE	Incoming purchase order type.
MATCH_ACTION	(Optional) Controls what type of match rules you can add to this match rule control.
MATCH_CNTRL_ID	(Optional) Controls the way matching operates for voucher, purchase order, receipt, and inspection information.
PAY_TRM_BSE_DT_OPT	(Optional) Defines which date the system uses as the terms basis date for scheduling payment and determining early payment discounts.
PUR_USR_HDR_SBR	User-definable field.
TERM_BASIS_DT	(Optional) Defines the basis date for scheduling payment and determining early payment discounts.

Insert a row into PO_DISTRIB_STG for each distribution for items on PO_ITM_STG. At least one row on PO_DISTRIB_STG must exist for each row on PO_ITM_STG.

Field Name	Field Value or Description
PROCESS_INSTANCE	Can be 0 or actual value.
BUSINESS_UNIT	Purchasing business unit.
PO_STG_TYPE	Same as on PO_ITM_STG.

Field Name	Field Value or Description
PO_STG_ID	Same as on PO_ITM_STG.
LINE_NBR	Incoming line.
SCHED_NBR	Incoming schedule sequence.
DISTRIB_LINE_NUM	Incoming distribution line number.
STAGE_STATUS	<i>S</i> (staged)
DISTRIB_PCT	Percent of schedule quantity.
QTY_PO	Incoming distribution quantity.
QTY_REQ	Incoming requisition quantity.
CURRENCY_CD	Transaction currency. Must be the same as on PO_ITM_STG.
CURRENCY_CD_BASE	Incoming currency code for the PeopleSoft General Ledger business unit on this distribution. This can be different from the purchase order base currency.
RT_TYPE	Desired currency rate type.
RATE_MULT	Incoming rate multiplier for conversion to PeopleSoft General Ledger business unit base currency for this distribution. Default is <i>1</i> , never <i>0</i> .
RATE_DIV	Incoming rate divisor for conversion to PeopleSoft General Ledger business unit base currency for this distribution. The default is <i>1</i> , never <i>0</i> .
MERCHANDISE_AMT	Incoming merchandise amount.
LOCATION	Incoming location.
ACCOUNT	Incoming account.
ALTACCT	Incoming alternate account.
CF16_AN_SBR	Should already be configured to the ChartFields.

Field Name	Field Value or Description
CHARTFIELD_STATUS	Incoming ChartField status.
BUSINESS_UNIT_GL	PeopleSoft General Ledger business unit.
BUSINESS_UNIT_REQ	Requisition business unit (if applicable).
BUSINESS_UNIT_PC	PeopleSoft Project Costing business unit (if applicable).
BUSINESS_UNIT_IN	PeopleSoft Inventory business unit (if applicable).
ACTIVITY_ID	Incoming activity ID.
ANALYSIS_TYPE	Incoming analysis type.
RESOURCE_TYPE	Incoming resource type.
RESOURCE_CATEGORY	Incoming resource category.
RESOURCE_SUB_CATEGORY	Incoming resource subcategory.
REQ_ID	Requisition ID for cross-reference if cross-referencing from the purchase order is required.
REQ_LINE_NBR	Requisition line for cross-reference if cross-referencing from the purchase order is required.
REQ_SCHED_NBR	Requisition schedule number for cross-reference if cross-referencing from the purchase order is required.
REQ_DISTRIB_NBR	Requisition distribution number for cross-reference if cross-referencing from the purchase order is required.
PROFILE_ID	Incoming asset profile ID.
TAG_NUMBER	Incoming tag number.
BUSINESS_UNIT_AM	Incoming PeopleSoft Asset Management business unit.
STATISTICS_CODE	Incoming statistics code.
DISTRIB_TYPE	From requisition line.

Field Name	Field Value or Description
FINANCIAL_ASSET_SW	(Optional)
CAP_NUM	(Optional)
CAP_SEQUENCE	(Optional)
EMPLID	(Optional)
COST_TYPE	Incoming cost type.
QTY_PO_STD	Purchase order quantity in standard unit of measure.
QTY_DEMAND	Quantity sourced from demand. This should be set to 0.
BUDGET_DT	Incoming budget date.
DEPTID	Department code.
ENTRY_EVENT	Entry event code.
PROJECT_ID	Project ID code.
PUR_USR_DST_SBR	User-definable field.

See the product documentation for *PeopleTools: Application Designer Developer's Guide*

Related Links

[“Replenishing Par Locations” \(PeopleSoft Inventory\)](#)

[Understanding User-Definable Fields](#)

[Manually Selecting Requisitions for Sourcing](#)

[Automatically Selecting Requisitions for Sourcing](#)

[Loading Staged Purchase Order Requests from PeopleSoft Supply Planning and Manufacturing](#)

Sourcing Error Messages

This table lists the error messages that you receive from the processes included in sourcing, the causes of the error messages, and their most common resolutions.

Error	Cause	Resolution
1 You must enter Run Control parameters before running this process.	The Application Engine can't find the run control data for this process.	Enter the run control data on the page that corresponds to the process that you are trying to run, save the page, and click the Run button.
2 Selection days are required when the Date Selection Option is <i>Plus</i> or <i>Minus</i> .	You have chosen the date selection option, indicating that you want to add or subtract days from the current date.	Specify the number of days in the Nbr Days field (number days field).
3 Date Selection operand is required when a Date Selection Option is selected.	You have not indicated whether the number of days in the range is plus or minus the purchase order source date, although you have requested the source date option.	The date selection option indicates that you want to select based on some version of current date. Specify whether the source document date should be equal to, greater than, or less than the selection date on the run control.
4 Supplier not found or specified supplier is inactive.	Either no supplier was found for this item, or the given or found supplier is inactive.	Change the supplier on the Sourcing Analysis page.
5 Unit of Measure not accepted by supplier.	Supplier does not accept all units of measure, and this UOM (unit of measure) has not been identified as the supplier's default UOM, or it is not defined as an acceptable supplier UOM.	Select the Accept any UOM flag on the Item Supplier page or change the UOM on the input record to match the UOM specified on the Item Supplier table. You could also change the supplier on the Sourcing Analysis page.
6 Ship To ID not accepted by Supplier.	The supplier does not ship to all ship to IDs, and the supplier does not allow this ship to ID.	Select the Accept any Ship To ID option on the Item Supplier page or change the ship to ID on the input record to match the ship to ID specified on the Item Supplier table. You could also change the supplier on this table.
7 Consolidation specified, yet the option prohibiting consolidation is also specified.	Row indicates that it is to be consolidated, yet one of the conditions exists, prohibiting consolidation: price-specified, UOM-specified, contract-specified when prohibited by the related PO Business Unit setting, item is order by description, or header level information is provided.	You could also change the supplier on this table. Correct the setting of the appropriate options on the staging table.
8 Item is order by description, yet a price calculation is requested.	Pricing calculations cannot be requested for order by description items, because there is no pricing information recorded for these items.	Set the Calculate Price flag to <i>N</i> on the staging table.

Error	Cause	Resolution
9 PO ID calculation option is selected, yet PO ID is specified, and so forth.	The PO Built flag indicates that no purchase order exists, yet a purchase order ID is specified, or the PO Built flag indicates that a purchase order does exist, and either the specified purchase order does not exist, or there is no PO_HDR_STG table for it.	Remove the purchase order ID or the PO Built flag on the staging table.
10 No PO ID could be calculated.	This error is usually caused by a missing Business Unit Options table.	When setting up the PeopleSoft Purchasing business unit, you must specify an option ID. Business unit options must exist for this option ID. <u>See Understanding the Purchase Order Business Process.</u>
11 Unit Price Tolerance exceeded.	The calculated purchase order price is outside the tolerance allowed for the requested price, plus or minus the unit price tolerance. Tolerance checking is done using base prices.	Either change the tolerances, requested price, or item price.
12 Percent unit price tolerance exceeded.	The calculated purchase order price is outside the tolerance allowed for the requested price, plus or minus the percentage unit price tolerance. Tolerance checking is done using base prices.	Change the unit price on the staged row, the tolerance, or the item price.
13 Price calculation requested, yet no price found.	Price calculation was requested, but no price was found, or the minimum quantity was not met. After searching the supplier item tables and item tables, the price was still zero.	Specify a standard price for the item on the Purchasing Attributes page.
14 Selection date is required when the Date Selection Option is <i>Specify</i> .	You have specified that you want to select input with a certain source date, yet you have not specified which source date to use.	Enter a source date on the selection criteria page.
15 Supplier Item relationship missing.	The Business Unit table indicates that a supplier item relationship must exist for the supplier and item ID.	You can establish the relationship using the Item Supplier page.
16 PO_HDR_STG_WRK table is missing.	The Create Purchase Order process could not build the PO_HDR_STG_WRK table. Typically, this is due to a missing Supplier Invoice table.	Normally the supplier Invoice table is automatically built when you add a supplier, so the probable cause is an incorrectly converted supplier.

Error	Cause	Resolution
17 CART Replenishment and RFQ sourced items cannot be reset.	You have requested that input transactions be reset for processing, but open quantities and amounts can only be backed out for requisition-related stage rows.	Do not attempt this option.
21 PO Price is zero.	No price calculation was requested, and the purchase order price is zero.	Enter a price on the staged row or the item price.
22 PO schedules are out of balance.	Purchase order schedule quantity or amount does not equal the sum of the distribution quantities or amounts.	You can change this imbalance in the purchase order page of your choice.
23 Contract Maximum Exceeded.	Contract pricing was not used, because contract maximums would be exceeded.	This is an information-only message. No action is required.
24 Item indicates that a contract is required.	Item attributes indicate that a contract is required for this item, yet no contract could be found.	Either remove that requirement from the item, or establish an effective contract.
25 PO Calculations calculated different price than Contract Release. Contract Release price used.	The PO Calculations process calculated a different price than the one used to update the contract amounts during the contract release process.	The supplier pricing was probably adjusted after the contract was released, but before the PO Calculations process completed. The contract price was used on the purchase order, but purchase order value adjustments show the purchase order calculated price. This is an information-only message. No action is required.
26 RFQ is Required.	This cannot be sourced to a purchase order, because the item indicates that an RFQ is required, and no RFQ is specified.	Perform the RFQ first.
27 Supplier Invoice Table is Missing.	Supplier Invoice table does not exist for the supplier specified on the staged row.	This could only happen for suppliers converted from another system. Be sure the conversion process creates this table.
28 Inventory Demand not created due to insufficient quantity. A purchase order will be created instead.	No IBU existed within the distribution network (other than the originating IBU) with sufficient available quantity to satisfy the requested quantity.	A purchase order will be created instead.

Error	Cause	Resolution
29 Item does not exist on Purchasing System.	The item ID isn't in the item tables.	Add the item into the item tables.
30 Supplier Minimum OR Maximum Quantity not met.	An item supplier option indicates whether quantity checking should be done at the line or schedule level. Based on this option, either the purchase order line or the purchase order schedule quantity is below the supplier minimum quantity or above the supplier maximum quantity. The supplier minimum and maximum quantities are specified at the item supplier unit of measure level.	Reset the requisition and increase the quantity to the supplier minimum, or lower the supplier minimum quantity.
31 Cannot convert currency from Item to Supplier.	Item price is being used, but a conversion rate does not exist from the item currency to the supplier currency.	Add a conversion rate.
32 Cannot convert currency from Supplier to Base.	A conversion rate does not exist from the supplier currency to the purchase order base currency.	Add a conversion rate.
34 GL Base Currency info not set up correctly.	Currency information is not set up for the PeopleSoft General Ledger business unit and default ledger group.	Set up currency information for the PeopleSoft General Ledger business unit and default ledger group.
35 Supplier does not support Stockless Inventory.	The purchase order indicates cart replenishment, but the supplier does not support stockless inventory.	Remove the cart replenishment option from the purchase order.
36 Sales/Use Tax Default Information is Missing.	There should be an entry in the Sales/Use Tax Defaults table for each ship to ID that does not exist. This information is required in order to proceed with building this purchase order item. This error also appears if there was a serious error in trying to obtain VAT information.	Add sales and use tax defaults for the ship to ID that you are using. Add these defaults to the Ship To Locations - Sales/Use Tax Defaults page. See "Defining Ship To Locations" (PeopleSoft Source to Settle Common Information).
37 Error in setting up for VAT processing.	An error was found in trying to determine VAT entity information, bill to VAT country, or bill from VAT country.	Check the VAT setup information on the VAT Entity page.

Error	Cause	Resolution
38 Error in VAT Calculation Module.	VAT calculation module (FSPVCRAE) was unable to calculate taxes for this item.	Review the VAT setup, and if no problems are found, contact the account representative.
39 Error in VAT Bill to defaulting.	Error in VAT module FSPBFPVT, which provides the default value for the bill to country.	Review the VAT setup, and if no problems are found, contact the account representative.
40 Error in VAT exception, treatment, and transaction defaults.	Error in VAT exception, treatment, and transaction defaults. An error was returned from one of the VAT programs: FSPVEPVT, FSPVTPVT, or FSPTXVVT.	Review the VAT setup, and if no problems are found, contact the account representative.
41 Error in VAT suspension or applicability defaults.	Error in VAT suspension or applicability defaults. An error was returned from one of the VAT programs: FSPNSPVT or FSPVCPVT.	Review the VAT setup, and if no problems are found, contact the account representative.
42 Error in Business Unit Setup.	There is an error in the business unit setup. The most common problem is that the process options do not exist for the process option ID specified on the Business Unit page, and for the appropriate SetID. Another possible problem is that the business unit specifies a currency that does not exist.	Correct the business unit setup.
43 No data selected for processing.	Nothing met the selection criteria; therefore, no data was found for processing.	Please review the selection criteria, and try again.
44 Category or Item specified but no SetID provided.	Category or item ID was specified as a selection criterion. When either of these fields are specified, the SetID must also be specified.	Specify the SetID.
45 Unit of Measure requires whole numbers yet transaction quantity has decimals.	The unit of measure for this transaction requires whole numbers. The transaction quantity has decimals and cannot be rounded to a whole number, because the difference exceeds the rounding tolerance.	Either adjust the quantity or the tolerance.
46 Error found in Schedule Split Sourced Supplier.	When split sourcing a schedule, if one of the split sourced transactions is rejected, they all must be rejected. This transaction has been rejected, because an error was found in another schedule split sourced transaction for the same schedule.	Correct the error on the other transaction that was split sourced.

Error	Cause	Resolution
47 Due to UOM Rounding, split sourced quantities do not add up to schedule quantity.	Split sourced transaction quantities must add up to the schedule quantity. This is a split-sourced transaction that has been UOM rounded. When you add up the UOM-rounded quantities for all transactions for this schedule, they do not add up to the schedule quantity.	Adjust at least one of the split-sourced quantities, so the summed quantities match the schedule quantity.
48 Contract SetID specified but contract was not entered.	The contract SetID was specified, but the contract was not entered. This may cause a problem when processing continues.	Enter the contract ID.
49 Invalid VAT Registration ID.	VAT registration ID is blank.	Correct the VAT registration ID for this country and VAT entity.
50 Cannot round transaction and standard quantities.	Both the transaction and standard quantities require whole numbers. When the standard quantity is rounded to a whole number, then reconverted back to the transaction quantity, the transaction quantity has decimals. Yet the transaction quantity also requires whole numbers.	Adjust the unit of measure rounding rules; reset this requisition and change the quantities so they can be rounded to whole numbers; or change the unit of measure so unit of measure conversion is not required.
51 Category SetID specified, but the category was not entered, and so forth.	If category is entered, category SetID must also be entered. If category is blank, category SetID must also be blank.	Enter both category SetID and category ID, or neither.
52 Error in VAT Bill from defaulting.	Error in VAT module FSPVFPVT, which provides the default value for the bill from country.	Review the VAT setup, and if no problems are found, contact the account representative.
53 Error in VAT treatment defaulting.	VAT defaulting routine returned an error value when trying to get VAT treatment.	Review the VAT setup, and if no problems are found, contact the account representative.
54 Error in VAT defaulting routine for recovery/rebate.	VAT defaulting routine returned an error value when trying to get VAT recovery and rebate defaults.	Review the VAT setup, and if no problems are found, contact the account representative.
55 Error in obtaining VAT bill to or bill from information.	There is a problem in the VAT setup as VAT bill to or bill from information could not be obtained.	Review the VAT setup, and if no problems are found, contact the account representative.

Error	Cause	Resolution
56 Revision is invalid.	Item revision does not exist.	Cancel the transaction and correct the revision code on the source document.
57 (Warning) Ship to country does not have VAT.	Ship to country does not have VAT; therefore, no registration entry was found for the VAT entity.	This message is only a warning. No action is required.
66 Only a process that isn't running can be Recycled.	You are trying to recycle a row on the stage table that is in process.	Wait until the process completes before trying to make this change.
67 Lower Unit Price Tolerance exceeded.	Calculated PO price is less than the requested price, minus the lower unit price tolerance.	Either change the tolerances, requested price, or item price.
68 Lower Percent Unit Price Tolerance exceeded.	Calculated PO price is less than the requested price, minus the lower percentage of unit price tolerance.	Either change the tolerances, requested price, or item price.
74 Enter a conversion rate for this item and unit of measure to the standard unit of measure.	Unit of measure conversion indicated, yet no conversion rate exists.	Enter a conversion rate for this item and unit of measure to the standard unit of measure.
75 Multiple suppliers were considered for this transaction and more than 1 had an error. Please see Eligible Vendors page for each error message.	Errors were found for multiple suppliers.	Please see Eligible Vendors page for each error message.
76 Buyer ID is a required field. This value is used as a default when creating the purchase order header.	Buyer ID is required.	Enter a buyer ID.
77 Contract is specified but is not effective during transaction due date. Modify due date, or modify contract effective dates.	Contract not effective.	Modify due date or modify contract effective dates.

Related Links

[Defining Purchasing Item Attributes](#)

Approving Purchase Orders

Understanding Purchase Order Approvals

Within PeopleSoft Purchasing, you can use workflow to approve purchase orders. This enables you to direct approvals to the correct people in the correct order. At the purchasing business unit level, you can choose one of two different workflow methods:

1. PeopleTools Workflow Technology documented in the *PeopleTools : Workflow Technology*. This workflow method enables you to approve the purchase order at the header level. You can route a purchase order for approval based on the amount, the ChartFields used, or both. When you use the PeopleTools Workflow Technology approval method, purchase orders are approved using workflow roles, rules, and routings. To implement workflow approvals, define the roles, rules, and routings using the PeopleSoft Application Designer, PeopleCode, and Workflow Administrator. Your system is delivered with basic approval rules already established.
2. PeopleSoft Approval Framework documented in the *PeopleSoft Approval Framework*. This workflow method enables you to approve the purchase order at the header level, line level, or both. You can also hold or pushback a purchase order or purchase order line. A pushback returns the transaction to the previous approval step, requiring the prior approver to reevaluate the approval. With proper authorization, an approver can add other approvers, called ad-hoc approvers, to the current or a later stage of the approval process. Reviewers and ad-hoc reviewers can be part of the workflow. Reviewers see the purchase order or purchase order line but do not approve it.

Regardless of the workflow method used, all approval requirements must be met before a purchase order is eligible for dispatch. You can prevent approved purchase orders from dispatching by performing one of these steps:

- Selecting the **Hold From Further Processing** check box on the Maintain Purchase Order - Purchase Order page.
- Clearing the **Dispatch When Approved** option on the Maintain Purchase Order - Purchase Order page.
- Clearing the **Dispatch** check box on the Maintain Purchase Order - PO Header Details page.
- Manually changing the status of the purchase order to *Open*.

Approvers or managers can use the Delegation Framework to delegate purchase order approval authority to other users. For more information about setting up and using Delegation Framework, see:

“Understanding Delegation” (Enterprise Components)

“Configuring Delegation Transactions” (Enterprise Components)

“Working with Self-Service Delegation” (Enterprise Components)

Related Links

[Understanding PeopleSoft Purchasing Workflow](#)

[PO Header Details Page](#)

Approving Purchase Orders With Approval Framework

This section discusses how to:

- Search for purchase orders requiring approval.
- Perform approval tasks related to purchase orders.
- View details about purchase order line items.

Pages Used to Approve Purchase Orders With Approval Framework

<i>Page Name</i>	<i>Definition Name</i>	<i>Usage</i>
Approve Purchase Orders page	PO_MASS_APPR	Enter search criteria to view purchase orders that require your approval or purchase orders that previously required your approval. This page can display multiple purchase orders and can be used to perform approval tasks such as approve or deny. On this page, you can use the mass approval feature to approve or deny multiple purchase orders at one time.
Purchase Order Approval Page	PO_APPROVAL	View an individual purchase order that requires your approval. This page displays the details of just one purchase order and can be used to perform approval tasks such as approve, deny, or pushback. If you are not the approver for this purchase order, the page name displays as "View Approvals".
Buyer's Workbench Page	PO_RC_WB	Submit purchase orders into the approval workflow process by selecting the PO and then clicking the Approve button. Purchase orders can also be unapproved.

Understanding Approval Task on Purchase Order

Use the purchase order approval pages to perform a number of approval tasks, including:

- Approving a purchase order or purchase order line. You can approve the entire purchase order at the header level or approve individual lines at the line level.

- Denying a purchase order (header level only). Once a purchase order is denied, the workflow stops.
- Holding a purchase order or purchase order line.
- Pushing back a purchase order or purchase order line. A pushback returns the transaction to the previous approval step. The meaning of push back is that the approver is questioning the prior step's approval and is requesting clarification.
- Adding or removing ad hoc approvers or reviewers. During the approval process, approvers can add other approvers or reviewers to the current or a later stage of the approval process. For example, if a buyer wants input from an inventory analyst, she can add the analyst as an approver. This action is called ad hoc approval, and it only applies to the approval instance in which the addition occurs and does not affect the underlying process definition used for other requests.
- Making comments to be viewed by other approvers or reviewers.
- View comments and attachments.
- Approving a purchase order that has been changed. When a purchase order is changed during or after the approval process, the approval framework can require re-approval of the changes using the same approval component as the original purchase order. When a purchase order line has been deleted, the entire purchase order must be resubmitted to prevent the purchase order line numbers and Approval Framework line numbers from being out of synch if line level approval was used on the purchase order. Because approved lines have the APPR_REQD flag set to N, approved lines are not rerouted for approval when the purchase order is resubmitted, and any lines that are not approved are rerouted for approval.
- Performing mass approvals. Using the Approve Purchase Orders page, you can select multiple purchase orders to be approved, denied, or put on hold. Use the Mark All icons to perform mass approval.
- Approving a purchase order using email rather than PeopleSoft pages.
- Self approval of purchase orders. This feature can be restricted or turned off.
- Alternate approvers who are assigned to receive emails and Worklist notifications for the primary approver when the primary approver is not available.

For a complete list of approval features, see the Understanding Approval Features section of the Understanding the Approval Framework of the PeopleSoft Approval Framework .

“Understanding the Approval Framework Feature” (Approval Framework)

Approve Purchase Orders page

Use the Approve Purchase Orders page (PO_MASS_APPR) to enter search criteria to view purchase orders that require your approval or purchase orders that previously required your approval.

This page can display multiple purchase orders and can be used to perform approval tasks such as approve or deny. On this page, you can use the mass approval feature to approve or deny multiple purchase orders at one time.

Approving a Purchase Order

To approve a purchase order use either the Approve Purchase Orders page or the Purchase Order Approval page.

On the Approve Purchase Orders page:

1. This page displays multiple purchase orders requiring approval. To approve individual purchase orders or lines, change the Action/Status field from *Pending* to *Approve*. To approve all purchase orders displayed in the search results, use the mass approval feature by clicking the Mark All: Approve link.
2. Click the Submit button.

Navigation:

Purchasing > Purchase Orders > Approve POs



This example illustrates the fields and controls on the Approve Purchase Orders page. You can find definitions for the fields and controls later on this page.

The screenshot shows the 'Approve Purchase Orders' interface. At the top, there is a search section with a 'Search' button and a 'Clear' button. Below this, there are several input fields for search criteria: Business Unit (set to US001), From PO ID, PO Date From, Supplier ID, Buyer, Approval Status (set to Pending), To PO ID, PO Date To, Supplier Name, and PO Reference. Below the search fields is a table of purchase orders. The table has columns for Action/Status, PO ID, PO Date, Buyer, PO Reference, PO Total, Supp ID, and Supplier Name. One row is visible with a status of 'Pending', PO ID '000000271', PO Date '01/15/2013', Buyer 'VP1', PO Reference, PO Total '207,774.00 USD', Supp ID '0000000045', and Supplier Name 'ROBERTHALF-001'. Below the table, there are 'Mark All:' buttons for 'Approve', 'Hold', and 'Deny'.

The Approve Purchase Orders page enables you to view and take action on purchase orders that require your approval or view purchase orders that do not require your approval.

Use this page to search for and view purchase orders needing your approval. Purchase orders displayed are based on the user ID of the person entering this page. You can limit the scope and number of purchase orders that appear on the page. For example, you can limit the search results to a specific buyer, date range, or approval status. After displaying the purchase orders, you can perform approval tasks on a group of purchase orders, one individual purchase order, or even separate PO lines. For more details on a particular purchase order, click the PO ID link to access the Purchase Order Approval page where you can view the details of one individual purchase order and perform approval tasks.

Field or Control	Description
Business Unit	Select a PeopleSoft Purchasing business unit containing the purchase orders that you want to review for approval.

Field or Control	Description
PO ID and To PO ID	Select a specific purchase order ID or range of purchase orders.
Approval Status	Select an approval status used by the purchase orders that you want to review for approval. Purchase orders that appear in the search results are those in the status you select and that meet the other search criteria you enter. Approval status values are: <i>Approved:</i> Displays all purchase orders that you have approved. <i>Denied:</i> Displays all purchase orders that you have denied. <i>On Hold:</i> Displays all purchase orders that you have placed on hold. <i>Pending:</i> Displays all purchase order that are waiting for your action. <i>Pushedback:</i> Displays all purchase orders you have pushed back to the previous approver.
PO Date From and PO Date To	Select a range of dates to select purchase orders to view.
Buyer	Select the buyer on the purchase orders.
Search	Click to initiate your search.
Clear	Click to erase your current search criteria in the Search group box.
	Click the Expand All icon to display purchase order detail including line and header level information.
	Indicates that there are lines pending approval for the purchase order.
PO ID	Click the PO ID link to access the Purchase Order Approval page where you can perform approval tasks for one individual purchase order. Approval tasks include approving, holding, or pushing back a purchase order.
	Indicates that a specific header or line is pending approval.

Field or Control	Description
Mark All	<p>Use this row to perform a mass approval action on several purchase orders at one time. After using the Mark All row, you must save (submit) the page to perform this action. Possible actions are:</p> <ul style="list-style-type: none"> • Click Approve to mark all displayed purchase orders as <i>Approve</i> in the Action/Status field. • Click Hold to mark all displayed purchase orders as <i>Hold</i> in the Action/Status field. • Click Deny to mark all displayed purchase orders as <i>Deny</i> in the Action/Status field.
Submit	Click this button to save and submit your changes on this page.

Holding a Purchase Order or Purchase Order Line

The hold action gives the approver time to research an issue and prevents the approval process from going to the next approval step until the approver takes action on the purchase order or purchase order line. When an approver uses the hold action, the system inserts an ad hoc reviewer at the current approval step and the approver can add a comment requesting more information. If multiple approvers are required to approve in this one approval step in the approval framework, then the other approvers of the same step can approve or deny the PO or PO line; however, the approval process does not move to the next approval step until the hold is removed by the approver who entered it. The approval hold is removed when either the approver chooses to approve or when the purchase order is updated in such a way that the approval process is restarted.

This page illustrates the results on the Purchase Order Approval page after the **Hold** button is used.

This example illustrates the fields and controls on the Hold on PO Line. You can find definitions for the fields and controls later on this page.

▼ Review/Edit Approvers

Line Level

▼ **Line 1: Pending**
 Long Sleeve Biking Jersey, Men's

🗨️ View/Hide Comments
➕ Start New Path

Fiscal Line Approval

Approved

✔️

Michael Buhler

Supervisor by UserId
01/15/13 - 9:53 PM

On Hold

📁

Kenneth Schumacher

Supervisor by UserId
01/15/13 - 9:55 PM

Information Request

🗨️

Anita Gardner

Information Request

Comments

Kenneth Schumacher at 01/15/13 - 9:55 PM

I need the RFQ paperwork before I can approve this PO line.

Michael Buhler at 01/15/13 - 9:53 PM

All the paperwork is complete for this purchase.

Pushing Back Purchase Orders

Once a purchase order line has been approved by at least one person, the next approver can push back the purchase order line in order to have the previous approver reconsider the approval. To pushback a purchase order line use the Purchase Order Approval page.

On the Purchase Order Approval page:

1. Select one or more lines that are pending approval. You can only pushback lines that have been previously approved within this approval step.
2. At the bottom of the page, use the Enter Approver Comments field to enter comments about the pushback.
3. Click the **Pushback** button below the Review Lines group box.

This page illustrates the results on the Purchase Order Approval page after the **Pushback** button is used.

This example illustrates the fields and controls on the Pushed back PO line. You can find definitions for the fields and controls later on this page.

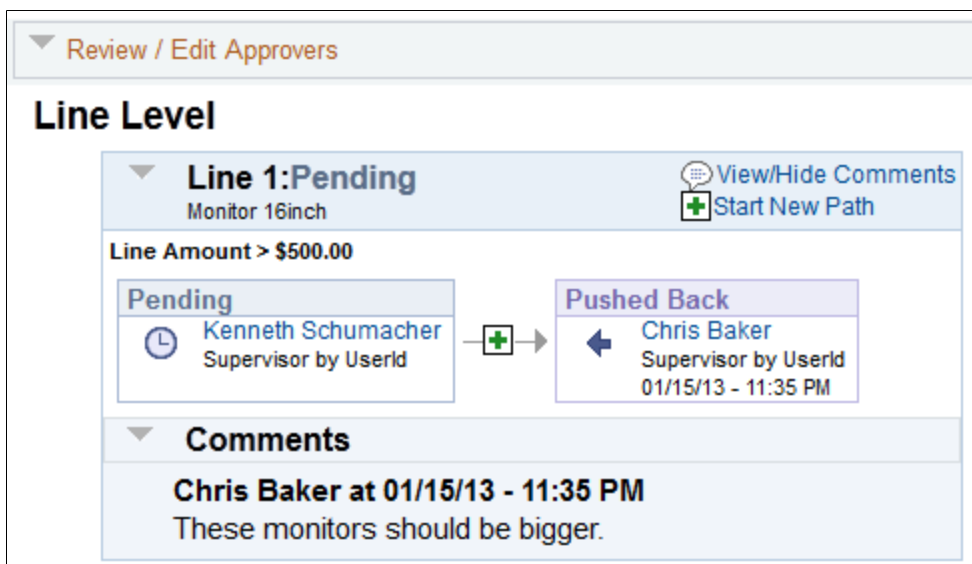

Insert Ad Hoc Approvers

Use the Purchase Order Approval page to insert ad hoc approvers and reviewers, in the Review/Edit Approvers group box, click the plus + symbol for a pending purchase order line. The Insert additional approver or reviewer window appears for you to select the user ID, and to indicate whether the person is an ad hoc approver or reviewer for this line.

You cannot change ad hoc approvers or reviewers; however, you can delete and add them again to indicate whether they are approvers or reviewers. To delete an approver or reviewer, click the minus – symbol. To add multiple approvers or reviewers click the plus + at the point where you want the additional approver or reviewer to receive the approval.

Use the **Ad Hoc User List** field on the Configure Transactions page to limit the users that can be added as ad hoc approvers and reviewers. If this field is left blank, then any active user can be added as an ad hoc approver or reviewer.

When you click the + symbol, the following window displays:

This example illustrates the fields and controls on the Insert additional approver or reviewer page. You can find definitions for the fields and controls later on this page.

This example illustrates the fields and controls on the Review/Edit Approvals section after an ad hoc approver has been added. You can find definitions for the fields and controls later on this page.

Purchase Order Approval Page

Use the Purchase Order Approval page (PO_APPROVAL) to view an individual purchase order that requires your approval.

This page displays the details of just one purchase order and can be used to perform approval tasks such as approve, deny, or pushback.

Navigation:

- **Purchasing > Purchase Orders > Approve POs.** In the search results, click the PO ID link.
- **Worklist > Worklist.** For the work item, Approval Routing, click the purchase order link on the row.
- **Purchasing > Purchase Orders > Add/Update POs.** On a saved purchase order, click the View Approvals link. If you are the current approver, the link displays as Purchase Order Approval.
- **Purchasing > Purchase Orders > Add/Update Express POs.** On a saved purchase order, click the View Approvals link. If you are the current approver, the link displays as Purchase Order Approval.

- Purchasing > Purchase Orders > Review PO Information > Purchase Orders.** On a saved purchase order, click the View Approvals link. If you are the current approver, the link displays as Purchase Order Approval.

This example illustrates the fields and controls on the Purchase Order Approval page 1 of 2. You can find definitions for the fields and controls later on this page.

Purchase Order Approval

Business Unit US003
 PO ID 000000003 View Printable Version
 PO Total 10,805.00 USD
 Supplier ID SCM000001 Bike Shopper
 Buyer CROTH
 PO Reference RC Quad x8996

PO Status Pend Appr
 PO Date 10/28/2014

Justification

[View Comments and Attachments](#)

[Edit PO](#)

Review Lines

Line Details Personalize | Find | View All | First 1-5 of 5 Last

Line	Item Description	Quantity	UOM	Price	Merchandise Amount	Currency	Original Substituted Item	Description
1	USB 2.0 High-Speed 4-Port Hub	10.0000	EA	28.00000	280.00	USD		
2	Laptop CPU 450Mhz, 64Mb RAM, CD-Rom	1.0000	EA	7,000.00000	7,000.00	USD		
3	32 inch Desktop LCD Monitor, Widescreen	1.0000	EA	175.00000	175.00	USD		
4	Memory Circuit Board, 128 MB	2.0000	EA	275.00000	550.00	USD		
5	On-Site Startup	2.0000	EA	1,400.00000	2,800.00	USD		

Select All Clear All [View Lines Details](#) [Approve](#) [Hold](#)

Review / Edit Approvers

Approval Comments

[Return to Purchase Order](#)

This example illustrates the fields and controls on the Classic Purchase Order Approval page 2 of 2. You can find definitions for the fields and controls later on this page.

Review / Edit Approvers

Line Level

Line 2: Pending [Start New Path](#)
 Laptop CPU 450Mhz, 64Mb RAM, CD-Rom
 Line Amount > \$500.00

Pending
 Kenneth Schumacher Supervisor by Userid → Michael Buhler Supervisor by Userid

Line 4: Pending [Start New Path](#)
 Memory Circuit Board, 128 MB

Line 5: Pending [Start New Path](#)
 On-Site Startup

Header Level

Purchase Order 000000003: Awaiting Further Approvals [Start New Path](#)
 PO Total > \$10,000.00

Not Routed Multiple Approvers Vice President
Not Routed Multiple Approvers Vice President

Approval Comments

[Return to Purchase Order](#)

Use this page to view the approval steps of a single purchase order. If your approval is needed, determined by your user ID, then the approval tasks are available. Based on your setup, the following options are available on this page:

- Approving a purchase order or purchase order line.
- Placing one or more purchase order lines on hold. This action inserts an ad hoc reviewer and requires you to enter comments.
- Push back a purchase order or purchase order line. A pushback action returns the transaction to the previous approval step.
- Add or remove ad hoc approvers or reviewers.
- Review an online purchase order that shows the layout of the printed version.
- Make comments to be viewed by other approvers or reviewers.

Note: If you select a line that does not require action, you receive a message telling you to select a line that is pending an approval.

Field or Control	Description
View Printable Version	Click this link to review an online purchase order report. This report shows the layout of the printed version. The purchase order opens up as a second window and can be printed. The Oracle BI Publisher is used to generate this report and you can customize it.
PO Total	Displays the total monetary value of the purchase order and the currency used.
Justification	Displays any comments entered at the purchase order header level to justify the need for this purchase order.
View Comments and Attachments	Select the view comments and attachments to view the collated header comments and attachments for the purchase order
Edit PO	Click this button to access the Maintain Purchase Order - Purchase Order page where you can review or change the purchase order. See Creating Purchase Order Lines .

Review Lines

The Review Lines displays information about lines within this purchase order, including : line number, approval status, item description, item quantity, unit price, and the total merchandise amount for each line. Users can perform approval tasks on one or more lines.

Field or Control	Description
Select	Select this check box to perform an approval action on a purchase order line. Once you have selected one or more lines, you can use the View Lines Details button, Approve button, Hold button, or Pushback button.
Select All / Clear All	Click to either select all lines or to clear all lines. You can select this check box to approve or deny all lines or select individual check boxes to approve or deny a subset of lines.
View Line Details	Click this button to view an online purchase order report for the selected lines. This report shows the layout of the printed version. The purchase order opens up as a second window and can be printed. The Oracle BI Publisher is used to generate this report and you can customize it.

Review / Edit Approvers

The Review / Edit Approvers displays the approval path for each line and the purchase order header. Use this section of the Purchase Order Approval page to review the approval flow, such as who approved the purchase order before you and who will approve it after you.

Click the plus + symbol to insert ad hoc approvers and reviewers. If you want to remove an ad hoc approver or reviewer click the minus — symbol.

Approval Comments

Use this section to enter comments about the purchase order when performing an approval action. If you deny the purchase order or purchase order line, the system requires that you enter a comment.

Field or Control	Description
Approve	Click to approve the selected purchase order lines. When you approve, the system routes the purchase order line to the next approver and updates the approval status for the line.
Hold	Click to hold the selected PO lines. You must enter a comment that is sent to the ad hoc reviewer.
Deny	Click to deny approval to the selected purchase order lines.

Field or Control	Description
Pushback	Select Pushback to return an approved line back to the previous approver with comments. This is possible only if there was a previous approver in the same path. You cannot push back a purchase order across stages.

Purchase Order Header Comments and Attachments

Navigation:

Click the View Comments and Attachments link on the Purchase Order Approval page.

This example illustrates the fields and controls on the PO Header Comments and Attachments page. You can find definitions for the fields and controls later on this page.

PurchaseOrder Header Comments and Attachments

Business Unit US003 PO Number 0000000010

▼ Comment 1

Add review.

Sequence	Attached File
1	hosts.txt

Return

Purchase Order Line Comments and Attachments page

Navigation:

Click on the Comments and Attachments icon on the Purchase Order Approval page line details section.

This example illustrates the fields and controls on the Purchase Order Line Comments and Attachments. You can find definitions for the fields and controls later on this page.

PurchaseOrder Line Comments and Attachments

Business Unit US003 PO Number 0000000003

Line Number 1

▼ Comment 1

review and send

Sequence	Attached File
1	Slide002_L01.htm

Return

See [Purchase Order Approval Page](#)

Note: Users having authority to access the Fluid approval pages, see [Approving Purchase Order Using PeopleSoft Fluid User Interface](#)

Approving Purchase Orders With Mobile Approval Framework

The section discusses how to set up and use Mobile Approval Framework in PeopleSoft Purchasing.

Mobile Approval Framework for Purchasing

PeopleSoft Mobile Approval Framework allows approver the flexibility to approve purchase orders on the go. For example, you can log into the PeopleSoft system from a mobile device, such as a tablet or smart phone, and do the following:

- Process purchase orders that are pending your header-level approval.
- Preview summary information for the purchase order, including budget checking when enabled.
- Review header-level approvals and view display-only line-level approvals in a graphical representation of the transaction approval flow.
- View justifications, alerts, and any comments that previous approvers have entered.

Note: Viewing attachments is not available for purchase orders in Mobile Approvals.

Prerequisites

In order to use Mobile Approvals, you must implement Approval Framework and configure approvals for Purchasing processes. Access to Mobile Approvals is granted by user. You can set up your own approver user list definition to accommodate your organizational needs. Also, verify that the proper approval roles are assigned to the approvers using the User ID – Roles page (PeopleTools, Security, User Profiles, User Profiles, Roles).

See [Setting Up the Approval Framework for PeopleSoft Purchasing](#)

For system-wide setup of Mobile Approval Framework, see Application Fundamentals documentation, “Understanding Fluid Approvals” (Application Fundamentals)

Mobile Approval Options

To set up PeopleSoft Mobile Approvals for approving purchase orders, select the Purchase Order transaction on the Mobile Approval Options page (Enterprise Components, Approvals, Approvals, Mobile Approval Options):

This example illustrates the fields and controls on the Mobile Approval Options page. You can find definitions for the fields and controls later on this page.

Mobile Approval Options

Display Attachments

Maximum Approvals Displayed:

Maximum Lines Displayed:

Actionable Approvals Only

Approval Transactions Personalize | Find | | First 1-5 of 5 Last

Included	*Order	*Transaction ID	*Transaction Name	*Process ID	*Transaction Handler Class	*Large Image
<input type="checkbox"/>	50	APVCH	Voucher	VoucherApproval	AP_APPROVAL:Voucher:MobileApprovalHandler	Image.FS_MBL_VOUC
<input type="checkbox"/>	10	EXER	Expense Report	ERApproval	EX_MOBILE_APPROVAL:ExpenseReport	Image.FS_MBL_EXPEN
<input type="checkbox"/>	20	GLJE	Journal Entry	GLJournalApproval	GL_APPROVAL:Journal:MobileApprovalHandler	Image.FS_MBL_JOURI
<input type="checkbox"/>	30	POPO	Purchase Order	PurchaseOrder	PO_APPROVAL:POMobileApproval	Image.FS_MBL_PURC
<input type="checkbox"/>	40	PVREQ	Requisition	Requisition	PV_APPROVAL:Requisition:MobileApprovalHand	Image.FS_MBL_REQU

Mobile Approval Home URL: http://rtdc78286qaemt.us.oracle.com/psc/ap920dvint/EMPLOYEE/ERP/s/WEBLIB_FIN_MBL.PAGES.FieldFormula.iScript_Home

Mobile Approval List URL: http://rtdc78286qaemt.us.oracle.com/psc/ap920dvint/EMPLOYEE/ERP/s/WEBLIB_FIN_MBL.PAGES.FieldFormula.iScript_ApprovalList

In the Approval Transactions grid, select the Included check box for Purchase Order Transaction ID *POPO* (Transaction Name is *Purchase Order*) on the Mobile Approval Options page. This will allow you to use mobile approval for Purchasing.

You also set up display options for mobile approval transactions on this page.

Note: Viewing attachments is not available for purchase orders in Mobile Approvals.

For more information on setting Mobile Approval options, see PeopleSoft Application Fundamentals documentation, “Understanding Fluid Approvals” (Application Fundamentals)

Approving Purchase Orders With PeopleTools Workflow Technology

This section provides an overview of approving purchasing orders using the PeopleTools Workflow Technology and discusses how to Approve Purchase Orders With PeopleTools Workflow Technology:

Pages Used to Approve Purchase Orders With PeopleTools Workflow Technology

<i>Page Name</i>	<i>Definition Name</i>	<i>Usage</i>
Purchase Orders - Approval Workflow Page	PO_APPR_WF	<p>Run the Pending PO Amount Approval Application Engine (purchase order amount approval application engine) process (PO_WFPOAMT) to submit purchase order amounts for approval using workflow.</p> <p>Run the Pending PO ChartField Approval Application Engine process (PO_WFPOCF) to submit purchase order ChartFields for approval using workflow.</p> <p>When using the batch Pending PO Amount Approval and Pending PO ChartField Approval processes, these processes do not look to verify who is logged in when running the process, therefore the User ID is irrelevant. Instead, these processes look to the buyer on the purchase order to see if they have approval authority.</p>
<u>Purchase Order Amount Approval Page</u>	PO_APPROVAL_AMT	<p>Approve purchase order amounts for purchase orders that require approval and view details.</p> <p>If you have a purchase order approval role in workflow, you can access this page when you select a purchase order from your worklist.</p>
<u>Purchase Order ChartField Approval Page</u>	PO_APPROVAL_CHRT	<p>Approve purchase order ChartFields for purchase orders that require approval and view details.</p> <p>If you have a purchase order approval role in workflow, you can access this page when you select a purchase order from your worklist.</p>

Understanding Approving Purchase Orders With PeopleTools Workflow Technology

PeopleTools Workflow Technology purchase order approvals are available in two areas. You can require approval of one or both of these items:

- Purchase order amounts.
- Purchase order ChartFields.

There are two types of approval methods:

- Automatic approvals.
- Workflow approvals.

When you use the PeopleTools Workflow Technology approval method, the system approves purchase orders by using workflow roles, rules, and routings. To implement workflow approvals, define the roles, rules, and routings by using the Workflow component. PeopleSoft delivers a system that includes basic approval rules.

This table lists the purchase order save statuses resulting from all possible setup configurations:

Approval Method	Buyer With Approval Authority	Buyer's Purchase Order Status Setting	Purchase Order Save Status
Automatic	Yes	<i>Pending</i>	<i>Approved</i>
Automatic	Yes	<i>Open (not recommended)</i>	<i>Open</i>
Automatic	No	<i>Pending</i>	<i>Pending</i>
Automatic	No	<i>Open</i>	<i>Open</i>
Workflow	Yes	<i>Pending</i>	<i>Pending</i>
Workflow	Yes	<i>Open (not recommended)</i>	<i>Open</i>
Workflow	No	<i>Pending</i>	<i>Pending</i>
Workflow	No	<i>Open</i>	<i>Open</i>

When you save a purchase order and the system is set up so that the purchase order's status is set to *Pending/Approved* as the default value, or when you select the **Approve** option on the Maintain Purchase Order - Purchase Order page, workflow verifies that you have the authority to approve the purchase order.

If you do not have the authority to approve the purchase order, workflow notifies the approver at the next level in the approval hierarchy that a purchase order needs approval and adds the purchase order to that approver's worklist. PeopleTools Workflow Technology routes the purchase order until it reaches an approver with proper approval authorizations.

You can set up PeopleTools Workflow Technology to search for purchase orders that require approval and to move those purchase orders to the appropriate users for approval.

Even if you choose to use workflow approvals, you still have the option not to invoke workflow and use the online pages to approve purchase orders manually.

You can use either of the following methods to send purchase orders into PeopleTools Workflow Technology:

- Use the PeopleSoft Application Engine processes.

PeopleSoft Pending PO Amount Approval process and the Pending PO ChartField Approval process use queries to determine which purchase order are eligible for workflow routings and approvals. To be eligible, a purchase order must have a status of *Pending Approval* and the approval status on the purchase order approval table must be *Initial*. The purchase order approval table tracks the approval status.

For eligible purchase orders, the Pending PO Amount Approval process sets statuses on the approval table to *In Process*, and the first worklist entries are created for the purchase order. The purchase order is now in workflow. The status remains as *Pending Approval*, until the purchase order completes its workflow cycle and the status changes to *Approved*.

- Perform manual steps on the purchase order approval pages.

If the purchase order requires workflow approval, setting the purchase order status to *Approved* on the Purchase Order Amount Approval page and the Purchase Order ChartField Approval page changes the status on the purchase order approval table to *In Process*, which triggers workflow approval. Whether you are using workflow or automatic approvals, you can use the PeopleSoft Purchasing online approval pages to approve qualified purchase orders.

You can also use the Buyer's WorkBench or Maintain Purchase Order - Purchase Order page to perform online purchase order approvals.

Using Automatic Approvals

When you use the automatic approval method, the system automatically approves purchase orders when they are saved by a user with proper authorizations. If a user without proper authorizations saves a purchase order, the status changes to the user's default purchase order save status, either *Open* or *Pending*. A qualified user must manually access and approve a purchase order by using the Approve Amounts and Approve ChartFields components.

If you choose to use automatic approvals, you must use the Workflow component to assign approval roles to buyers and requesters. This involves determining whether you need a system of multilevel approvals or just specific users who have the authority to approve everything. If you later decide to use workflow-based approvals, the basic infrastructure is already in place.

Examples of Approving a Purchase Order

This section discusses how to perform purchase order approvals in various scenarios.

Manual Purchase Order Approvals

This is an example of a manual approval using the purchase order approval pages.

To purchase the items that are requested on a purchase order, you must obtain your manager's approval prior to making the purchase. You submit the purchase order directly to your manager for her approval. She approves or cancels the purchase order using the Purchase Order Approval pages. If your manager approves the purchase order, she returns it to you for purchase.

When you approve a purchase order manually on the approval pages, the system verifies the authorizations.

When you select the purchase order from your worklist, the system accesses the same pages that you use to start the process manually (the amount or ChartField approval pages.) If you use the workflow process to get the approvals done, and you don't have the appropriate authority, the system uses the same pages for the next role in the approval hierarchy.

Workflow Purchase Order Approvals

This workflow routing scenario involves two roles working with a purchase order:

- A junior buyer who can approve purchase orders under 10,000.00 USD.

The junior buyer can also approve the ChartField distributions on the purchase order.

- A senior buyer who must approve purchase orders over 10,000.00 USD.

In this scenario, the business unit approval rules specify that both ChartFields and amounts require approval.

Case A: Purchase Orders That Are Less Than Approval Maximum

At the end of every day, all approved purchase orders are automatically dispatched. As the junior buyer creates and modifies purchase orders, she identifies their statuses as pending approval. If all of the junior buyer purchase orders are less than 10,000.00 USD on a given day, the save process changes the status of the purchase orders from *Pending Approval* to *Approved*. Because both amount and ChartField distributions are identified as *Approved*, the system changes the overall purchase order status to *Approved*, meaning that when the scheduled dispatch process runs at the end of the day, it automatically picks up those purchase orders.

Case B: Purchase Orders That Exceed Approval Maximum

If the junior buyer accesses and approves a purchase order for 10,000.00 USD, workflow routes the purchase order to the next higher role, which is set up as the senior buyer. The next time that the senior buyer logs on and checks her worklist, the purchase order appears in the worklist as needing approval. From the worklist, the senior buyer selects the worklist entry to access the Approval Amounts - Approval page and either approves or denies the request.

Case C: Immediate Approvals

In this scenario, the Pending PO Amount Approval process is set up to run at the end of the day. Therefore, the senior buyer cannot view the purchase order worklist entry until the beginning of the following day. If the senior buyer needs to view and approve the activity sooner, she must follow a different procedure.

To view and approve the activity immediately:

1. Manually submit a request for the Pending PO Amount Approval process and then act upon the results of the process.
2. Initiate the workflow process for specific purchase orders by using the approval pages.

If you are the approver, you can approve the purchase order on the Approve Amounts - Approval page, Approve ChartFields - Approval page. As an approver, you can approve, recycle, or deny an activity.

If the purchase orders are retrieved from the scheduled process the system looks at the buyer associated with the purchase orders and then references the approval rules associated with the buyer. If the purchase orders are retrieved on the online pages, the system looks at the user who is logged on and references the

approval rules associated with the user. If the junior buyer uses the Approve Amounts - Approval page to approve her purchase orders, the system recognizes that she doesn't have the authority to complete the approval, and workflow responds to this request by routing the activity to the senior buyer worklist.

When both amount and ChartField approvals are identified as complete, the system changes the overall status of the purchase order to *Approved*. Until then, the overall status remains as *Pending Approval*.

Note: If the business unit approval rules are set so that they do not require amount or ChartField approvals, the purchase order skips the workflow process.

You can also set up workflow so that activities are routed directly to the person with the proper authority, thus bypassing the incremental routing process up the chain of authority. In the previous example, workflow could have routed the activity directly to the president of the organization, because she is the only one with authority to approve the activity.

The following table is a list of the workflow notification events and workflow business process names that are related to approving purchase orders:

Workflow Notification Event	Workflow Notification Type	Business Process Name
Notify approver when a purchase order needs approval.	Worklist	Purchase Order Approvals
Notify previous approver that a purchase order has been denied or recycled.	Worklist and email (denied) Worklist (recycled)	Purchase Order Approvals

See the product documentation for *PeopleTools: Workflow Technology*

Related Links

[Maintain Purchase Order - Purchase Order Page](#)

Purchase Order Amount Approval Page

Use the Purchase Order Amount Approval page (PO_APPROVAL_AMT) to approve purchase order amounts for purchase orders that require approval and view details.

If you have a purchase order approval role in workflow, you can access this page when you select a purchase order from your worklist.

Navigation:

Purchasing > Purchase Orders > Approve Amounts PO

This example illustrates the fields and controls on the Purchase Order Amount Approval page. You can find definitions for the fields and controls later on this page.

Purchase Order Amount Approval

Business Unit US001 PO ID 000000042 Supplier ID SCM0000002

*Approval Action Approval Status In Process

Comment

PO Amount

Buyer Kenneth Schumacher

PO Reference

PO Date 01/15/2003

Merchandise Total Amount 20.00 USD Merchandise Total Base 20.00 USD

PO Total Value 20.00 PO Total Base 20.00

Lines Personalize | Find | View All | First 1 of 1 Last

Line	Sched	UOM	PO Quantity	Merchandise Amount	Currency	Merchandise Base Amount Base	Base Currency	More Information
1	1	EA	1.0000	20.00	USD	20.00	USD	Supplex Shorts, Men's

The amounts that appear are the amounts that you are approving. You can change these values on the Maintain Purchase Order - Purchase Order page and Maintain Purchase Order - Schedules page.

Field or Control	Description
Approval Action	<p>Select one of these actions. If you don't have the authority to complete the approval or if you deny or recycle the purchase order, the approval status remains <i>In Process</i> and routes to the next role user in the approval definition.</p> <p><i>Approve</i>: Select to approve the purchase order amount or ChartField. If requirements are met, the approval status changes to <i>Complete</i> when you save this page, and the purchase order is made available for dispatch. If workflow is implemented, the system sends an email to the buyer telling him or her that the purchase order has been approved.</p> <p><i>Deny</i>: Select to deny the amount or ChartField for this purchase order and deny dispatch. If this value is selected and workflow is enabled, the system generates a worklist entry and an email message to the buyer.</p> <p><i>Recycle</i>: Select to send the purchase order back to the buyer or previous approver. If this value is selected and workflow is enabled, the system generates a worklist entry to the last user who approved the purchase order amount.</p>
Approval Status	Displays the overall status of the purchase order.
View Printable PO (view printable purchase order)	Click this button to review the purchase order printout on the screen. This option does not print the purchase order directly to the printer; however, you can use the print feature from the browser to send the output to the printer.

Field or Control	Description
Comment	Enter comments pertinent to the approval action. These comments are saved with the purchase order and are visible only on the originating page, either the Approve Amounts - Approval page or Approve ChartFields - Approval page.
Chng Order (change order)	Displays the change order number when you approve a purchase order with a change order.

PO Amount

Field or Control	Description
PO Reference	Displays free-form text that appears by default from the Maintain Purchase Order - Purchase Order page.
Merchandise Total Amount	Displays the quantity of items multiplied by the unit price in the purchase order currency.
Merchandise Total Base	Displays the quantity of items multiplied by the unit price in the base currency for the business unit.
PO Total Value	Displays the merchandise total amount plus taxes, freight, and miscellaneous charges in the purchase order currency.
PO Total Base	Displays the merchandise total amount plus taxes, freight, and miscellaneous charges in the base currency for the business unit.

Related Links

[PO Header Details Page](#)

Purchase Order ChartField Approval Page

Use the Purchase Order ChartField Approval page (PO_APPROVAL_CHRT) to approve purchase order ChartFields for purchase orders that require approval and view details.

If you have a purchase order approval role in workflow, you can access this page when you select a purchase order from your worklist.

Navigation:

Purchasing > Purchase Orders > Approve ChartFields PO

This example illustrates the fields and controls on the Purchase Order ChartField Approval page. You can find definitions for the fields and controls later on this page.

Purchase Order ChartField Approval

Business Unit US001 PO ID 000000042 Supplier ID SCM0000002

*Approval Action Approval Status In Process

Comment

Distributions

Line	Sched	Distrib	GL Unit	Merchandise Amt	Currency	Account	Alt Acct	Oper Unit	Fund	Dept
1	1	1	US001	20.00	USD	212020				11000

Lines

Line	Sched	UOM	PO Qty	Merchandise Amt	Currency	Merch Amt Base	Base Currency	Description
1	1	EA	1.0000	20.00	USD	20.00	USD	Supplex Shorts, Men's

This page displays the ChartField values that you are approving. You can change these values on the Maintain Purchase Order - Purchase Order page and the Maintain Purchase Order - Distributions for Schedule page.

Field or Control	Description
Approval Action	<p>Select one of these actions. If you don't have the authority to complete the approval or if you deny or recycle the purchase order, the approval status remains <i>In Process</i> and routes to the next role user in the approval definition.</p> <p><i>Approve</i>: Select to approve the purchase order amount or ChartField. If requirements are met, the approval status changes to <i>Complete</i> when you save this page, and the purchase order is made available for dispatch. If workflow is implemented, the system sends an email to the buyer telling him or her that the purchase order has been approved.</p> <p><i>Deny</i>: Select to deny the amount or ChartField for this purchase order and deny dispatch. If this value is selected and workflow is enabled, the system generates a worklist entry and an email message to the buyer.</p> <p><i>Recycle</i>: Select to send the purchase order back to the buyer or previous approver. If this value is selected and workflow is enabled, the system generates a worklist entry to the last user who approved the purchase order amount.</p>
Approval Status	Displays the overall status of the purchase order.

Field or Control	Description
View Printable PO (view printable purchase order)	Click this button to review the purchase order printout on the screen. This option does not print the purchase order directly to the printer; however, you can use the print feature from the browser to send the output to the printer.
Comment	Enter comments pertinent to the approval action. These comments are saved with the purchase order and are visible only on the originating page, either the Approve Amounts - Approval page or Approve ChartFields - Approval page.
Chng Order (change order)	Displays the change order number when you approve a purchase order with a change order.

Related Links

[PO Header Details Page](#)

[Maintain Purchase Order - Distributions for Schedule Page](#)

Approving Purchase Order Using PeopleSoft Fluid User Interface

Pages Used to Approve Purchase Order in the PeopleSoft Fluid User Interface

Page Name	Definition Name	Usage
Pending Approvals - Purchase Order Page	EOAWMA_MAIN_FL	Review and approve multiple purchase orders. Access header details for a specific purchase order. For more information, see the “Understanding PeopleSoft Fluid User Interface” (Application Fundamentals).
Purchase Order - Approval Header Detail Page	EOAWMA_MAIN_FL	Review and approve a single purchase order entry. Access line item details for a specific line. For more information, see the “Understanding PeopleSoft Fluid User Interface” (Application Fundamentals).
Approval Line Detail Page	EOAWMA_TXNLDTL_FL	Review display-only line details.
PO Distribution Information Page	PO_FL_APPR_DISTRIB	Review distribution and chartfield information for a purchase order shipping line.

Page Name	Definition Name	Usage
Approvals History - Purchase Order (List) page	Not Available	Review a list of purchase order approvals. Access the approval history for a specific purchase order.
Approvals History - Purchase Order Page	Not Available	Review the approvals history for a single purchase order. Access line item details for a specific line.

Pending Approvals - Purchase Order Page

Use the Pending Approvals — Purchase Order page to review and approve multiple purchase orders. Access header details for a specific purchase order.

Navigation:

Employee Self Service homepage > Approvals tile > Select User Purchase Order in the approval list panel on the left side of the page.

This example illustrates the fields and controls on the Pending Approvals - Purchase Order page. You can find definitions for the fields and controls later on this page.

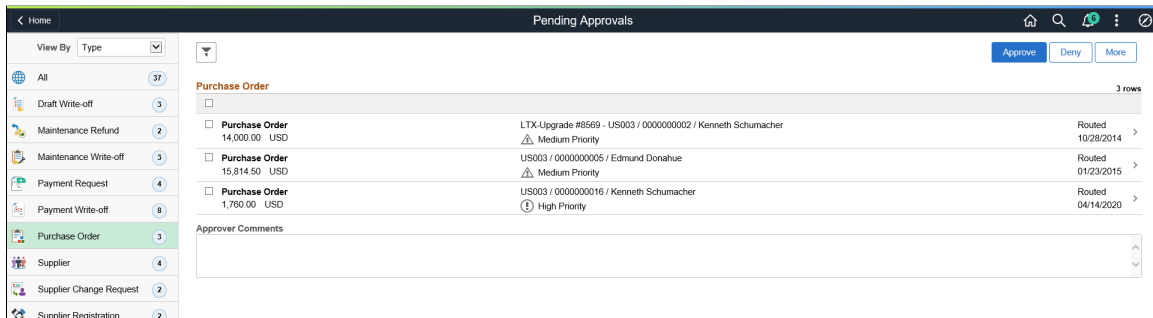

Review header information for the purchase orders currently routed for approval. To access header details for a particular transaction, select the header row for a particular purchase order. You can select all or several purchase orders on this page and perform a mass action on the selected purchase orders. Use the filter to narrow results on this page. You can select and review purchase orders by their priority. For more information about using the filter, see the “Understanding PeopleSoft Fluid User Interface” (Application Fundamentals).

Field or Control	Description
Approve, Deny	Perform a mass action by selecting multiple transactions, then selecting an approval action button.

Field or Control	Description
More	<p>On selecting the More button you can perform one of the two following actions:</p> <ul style="list-style-type: none"> • Pushback • Hold
Comments	Enter comments in the text entry field.

Oracle PeopleSoft delivers Notification Composer Framework to manage the setup and administration of notifications in one central location. Once you have adopted the Notification Composer feature, you must use it to create new notifications and manage your existing notifications.

For more information about Notification Composer Framework, see “Understanding Notification Composer” (Enterprise Components).

Related Links

“Working with Forms” (Enterprise Components)

Purchase Order - Approval Header Detail Page

Use the Purchase Order - Approval Header Detail page to review and approve a single purchase order. Access line item details for a specific line.

Navigation:

Select an individual Purchase Order row from the Pending Approvals - Purchase Order page.

This example illustrates the fields and controls on the Purchase Order - Approval Header Detail page. You can find definitions for the fields and controls later on this page.

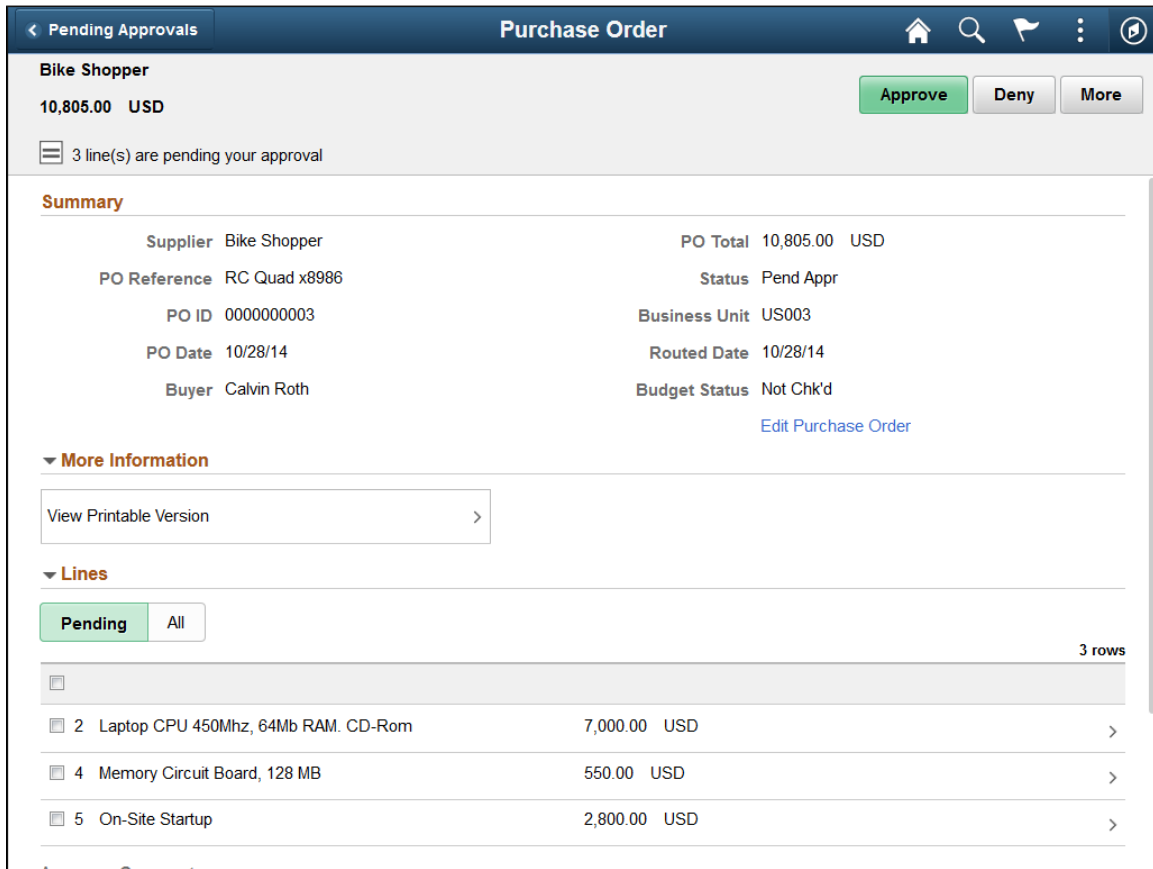

When viewing a purchase order on a smartphone, you must scroll down to view the approver comments and approval chain.

The approval chain reflects approval status generated by the Application Workflow Engine (AWE). For more information about using AWE workflows, see “Approval Framework Overview” (Approval Framework)

Field or Control	Description
Edit Purchase Order	Click to access the Add/Update PO page. Note: This link is not available for smartphones.
Approve, Deny	Perform an action on this purchase order by selecting an approval action button. Upon selecting an action, you have the option to select <i>Submit</i> to continue the action or <i>Cancel</i> to back out of the action. Upon submitting the action, the system generates a message that the action is successful.

Field or Control	Description
More	<p>On selecting the More button you can perform one of the two following actions:</p> <ul style="list-style-type: none"> • Pushback • Hold

More Information

Field or Control	Description
View Printable Version	Click this link to view all the PO information in a PDF format.

Lines

Use the Lines grid to select a purchase order line item and access details for the line. You can filter purchase order line items by selecting *Pending* or *All*.

Field or Control	Description
Approver Comments	Enter comments in the text entry field.
Approval Chain	Select to view the approval chain information. You can expand or collapse approval information for each line by selecting the glyph icon. You can also select the approver name to view approver details.
View Comments and Attachments	<p>Select the view comments and attachments to view the collated header comments and attachments for the purchase order.</p> <p>If there are no comments or attachments the View/ Comments and Attachments does not appear.</p>

This example illustrates the fields and controls on the Purchase Order Header Comments and Attachments page. You can find definitions for the fields and controls later on this page.

Purchase Order Header Comments and Attachments ✕

Business Unit US003

PO Number 0000000010

▼ **Comment 1**

Please notify us prior to delivery for over-sized deliveries.

Sequence	Attached File
1	 Large_Order.txt

Related Links

“Working with Forms” (Enterprise Components)

Approval Line Detail Page

Use the Approval Line Detail page to review display-only line details.

Navigation:

Select a purchase order line item in the Lines section on the Purchase Order - Approval Header Detail page.

This example illustrates the fields and controls on the Approval Line Detail page. You can find definitions for the fields and controls later on this page.

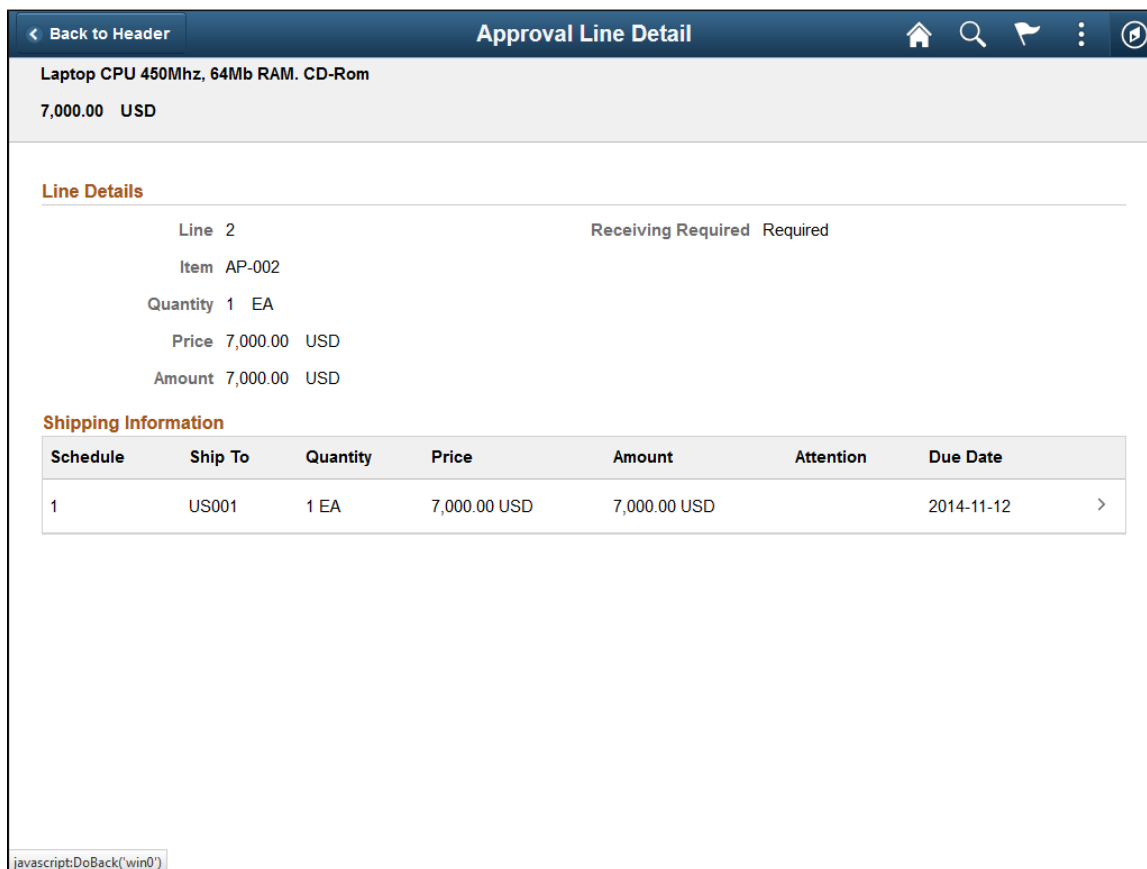

Line Details

Use this grid to view general details for the purchase order line, such as item ID, quantity, and price.

Note: The Item ID label will not display when a description only item is ordered.

Shipping Information

Use this grid to view shipping related details for the purchase order line, such as schedule, ship to, and due date.

Select a shipping line to access the PO Distribution Information page and view distribution and chartfield information for the shipping line.

PO Distribution Information Page

Use the PO Distribution Information page (EOAWMA_TXNLDTL_FL) to review distribution and chartfield information for a purchase order shipping line, such as distribution line, merchandise amount, and account.

Navigation:

Select a shipping line on the Approval Line Detail page.

This example illustrates the fields and controls on the PO Distribution Information page.

PO Distribution Information												
Fluid Approval Distribution												
Line 2												
Schedule 1												
Item Description Laptop CPU 450Mhz, 64Mb RAM. CD-Rom												
Merchandise Amt 7,000.00 USD												
Quantity 1.0000 EA												
Distribution Line	Purchase Order Quantity	Merchandise Amount	Currency Code	GL Business Unit	Attention To	Account	Alternate Account	Operating Unit	Fund Code	Department	Program Code	Class
1	1.0000	7000.00	USD	US003		631000				21000		

Approvals History - Purchase Order (List) page

Use the Approvals History- Purchase Order List page to review a list of purchase order approvals. Access the approval history for a specific purchase order

Navigation:

From any Pending Approvals page, select the Actions icon on the page banner. Select *Approvals History*. Then select *Purchase Order* on the View By - Type page.

This example illustrates the fields and controls on the Approvals History - Purchase Order (List) page. You can find definitions for the fields and controls later on this page.

Approvals History			
View By: Type			
All 3			
Purchase Order 3			
All 3 rows			
Purchase Order	34,000.00 USD	US003 / 0000000010 / Blake,Scott ⚠ Medium Priority ✅ Approved	Updated 07/11/2016 >
Purchase Order	10,805.00 USD	RC Quad x8986 - US003 / 0000000003 / Calvin Roth ⚠ Medium Priority 🔄 In Process	Updated 07/11/2016 >
Purchase Order	15,814.50 USD	US003 / 0000000005 / Edmund Donahue ⚠ Medium Priority 🔄 In Process	Updated 07/11/2016 >

Approvals History - Purchase Order Page

Use the Approvals History - Purchase Order page to review the approvals history for a single purchase order. Access line item details for a specific line.

Navigation:

Select a purchase order in the list on the Approvals History - Purchase Order list page.

This example illustrates the fields and controls on the Approvals History - Purchase Order (Header Approval) page. You can find definitions for the fields and controls later on this page.

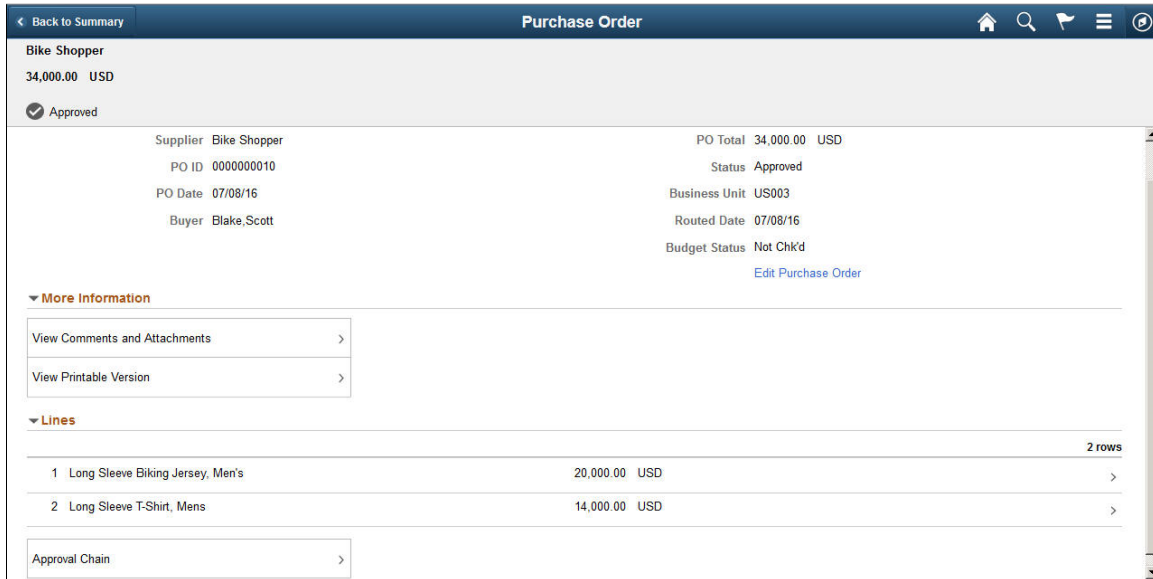

For fields and definitions see the More Information section under [Purchase Order - Approval Header Detail Page](#)

Note: Approval related actions are not available once a PO has been approved.

Dispatching and Printing Purchase Orders

Understanding Purchase Order Dispatch

With PeopleSoft Purchasing, you can dispatch and print purchase orders individually or in volume. You can dispatch purchase orders by printing, fax, phone, email, or electronic data exchange (EDX). You can also dispatch them from the online pages or through a batch process. A purchase order must have a status of *Approved* and have passed the commitment control budget check to be eligible for dispatch.

Dispatching Purchase Orders Using Online Pages

Use one of these pages to dispatch purchase orders individually:

- Maintain Purchase Order - Purchase Order page.
- Express Purchase Order - Purchase Order page.
- Buyer's WorkBench.

Here are the basic steps to dispatch purchase orders from an online page:

1. Access one of the online pages.
2. Click the **Dispatch** button on the page.
The Dispatch Options page appears.
3. Enter dispatch options for the purchase order.
4. (Optional) Select a report template if you are dispatching the purchase order using Oracle BI Publisher.

You have the flexibility of changing the purchase order formats by choosing different report template IDs for different types of purchase orders. The template ID for dispatched purchase order can be defined at the business unit level, on the run control for the dispatch process, or on the purchase order. To use the BI Publisher for purchase orders in both PeopleSoft eProcurement and PeopleSoft Purchasing, select the **Enable XML Publisher** check box on the Purchasing page of the Installation Options component.

The use of BI Publisher is based on whether the **Enable XML Publisher** check box is selected on the installation options Purchasing page. For batch processes, you can select to use BI Publisher or use the SQR from the Run Control page.

See *PeopleTools : BI Publisher for PeopleSoft* .

See [Dispatching Purchase Orders](#).

5. Click the **OK** button.

The system dispatches the purchase order using the method set up on the PO Header Details page.

Warning! If a purchase order is on hold, dispatching that purchase order from the Maintain Purchase Order - Purchase Order page, Express Purchase Order - Purchase Order page, or Buyer's WorkBench automatically removes the purchase order from hold and dispatches it. If a purchase order is on hold and you dispatch that purchase order through the PO Dispatch/Print process, the system does not dispatch the purchase order and it remains on hold.

Note: You can only print out a limited number of pages when dispatching comments.

Dispatching Purchase Orders Using a Batch Process

Use the Dispatch Purchase Orders page to schedule a background batch job that dispatches a single purchase order or multiple purchase orders that meet your selection criteria. After purchase orders are successfully dispatched, their statuses are updated to *Dispatched*.

Note: The PO Dispatch/Print process dispatches purchase orders associated with recurring purchase order vouchers; however, the PO_STATUS values on the purchase orders are never set to *D* (dispatched).

When you run the PO Dispatch/Print process from the Dispatch Purchase Orders page, the PeopleSoft Process Scheduler Request page offers you three options:

Term	Definition
PO Dispatch & Email multi-process job	Select to run the Single PO Dispatch/Print SQR Report process (POPO005) and then the Email Application Engine process (PO_PO_EMAIL).
PO Dispatch/Print process	Select to run only the PO Dispatch/Print SQR Report process (POPO005).
PO XMLP Dispatch	Select to run only the PO XMLP Dispatch process (PO_DISPATCH).
Email process	Select to run only the Email Application Engine process (PO_PO_EMAIL).

When you use the email dispatch method, the PO Dispatch/Print process creates an output file in the location that you specify on the File Locations page. The Email process picks up the output file from the specified location and sends out an email message with the purchase order as an attachment. When the dispatch method is fax, the dispatch process creates a purchase order file and a fax control file in the locations that you specify on the File Locations page.

The PO Dispatch/Print process contains business process logic and is responsible for retrieving data from the database, constructing purchase orders, and sending the output files to the proper locations. To actually deliver purchase orders to the recipients through designated channels, a separate process is required.

To dispatch by email, you first need to run the PO Dispatch/Print process to create the output files and to update the PO Email queue table. You then run the Email process.

The Email process is a PeopleSoft Application Engine process that picks up the email output file created by the PO Dispatch/Print process in the location specified on the File Locations page and generates an email message through the SMTP gateway to be delivered to the recipient through the internet. If you specify a supplier contact on the Supplier Details page on the purchase order, the Email process sends the email to the address that you specify in the **Email ID** field on the Supplier Information - Contacts page. If you do not specify a Supplier contact on the purchase order, the Email process sends the email to the address that you specify in the **Email ID** field on the Supplier Information - Address page. When a message is sent successfully, it is removed from the email queue table; however, the purchase order output files are not deleted.

To simplify dispatching by email, you can use the PO Dispatch & Email job on the PeopleSoft Process Scheduler Request page that you access from the Dispatch Purchase Orders page. The PO Dispatch & Email job automatically runs the PO Dispatch/Print process and then the Email process. For online dispatches, the system always schedules the PO Dispatch & Email job.

If you are using the fax dispatch method, you must use a third-party fax software to handle the output files.

If the dispatch method is EDX, the PO Dispatch/Print process does not create an output file, but it updates a series of EC outbound tables. These tables are updated: PS_PO_HDR_OUT_EC, PS_PO_LINE_OUT_EC, PS_PO_SHIP_OUT_EC, and PS_PO_SHIP_OUT_EC.

When you dispatch a purchase order by telephone, *Phone* must be selected as the dispatch method. This selection ensures that when you dispatch a purchase order either from one of the pages or using the PO Dispatch/Print process, the status of the purchase order updates to *Dispatched*.

An important factor to consider when you select an appropriate output format is the recipient. When you dispatch by email, you may want to select a dispatch output format of PDF or HTM, because these formats employ readers that are commonly found on user systems. When you dispatch by fax, you may want to consider that most fax software applications are compatible with Postscript - (PS) or PCL - (HP) encoded files.

When you generate the PO Dispatch/Print report from the Purchase Orders Print page, a hard copy of the purchase order prints, but the purchase orders are not dispatched. When you print the purchase order using the Purchase Orders Print page, the word *Unauthorized* prints on the purchase order to differentiate it from an actual dispatched purchase order.

Note: A purchase order cannot be dispatched using email or fax when the email ID or fax number is not available; in other words, they are either not specified on the document or they are not available from the supplier profile. Some purchase orders that are scheduled to be dispatched using the PO Dispatch/Print process may not be processed due to a missing email ID or fax number. Check the log file for those purchase orders that are not dispatched.

Dispatching Purchase Orders Using Oracle BI Publisher

The PO dispatch is available using Oracle BI Publisher through PeopleSoft Purchasing and eProcurement. This functionality provides you a seamless interface and consistent report format between Purchasing and eProcurement dispatches. You can print email, or fax the report as an attachment.

The Oracle BI Publisher feature is a template-based reporting solution that separates the data extraction process from the report layout and enables the reuse of extracted application data into multiple report

layouts. You can change the format or layout of a purchase order report without changing the underlying program that controls the business logic. The format and layout include the appearance of the report and the addition or removal of fields on the report as long as those fields are available as part of the purchase order dispatch data. You can create the reports using SQR or BI Publisher formats.

You can change purchase order report formats by selecting different report template IDs for different types of purchase orders. You can define the template ID for dispatched purchase orders at the business unit level, the run control for the dispatch process, or the individual purchase order.

To use the Oracle BI Publisher for purchase orders in both PeopleSoft eProcurement and PeopleSoft Purchasing, select the **Enable XML Publisher** check box on the Purchasing page of the Installation Options component. This PeopleSoft application is delivered with sample data already set up to generate an BI Publisher purchase order that uses a similar format as the SQR report. Use this data as a starting point to create your own layout for purchase orders using the BI Publisher. Sample data in Oracle BI Publisher (**Reporting Tools > BI Publisher**) includes:

- Report Definition: PO_DISPATCH
- Data Source ID: PO_DISPATCH
- Template File: PO_DISPATCH.RTF

When dispatching purchase orders, the system must identify the BI Publisher template ID. These steps describe how you use the system and the process the system uses for defining a template ID for a purchase order:

1. You enter the template ID for an individual purchase order using the PO Header Details page or the Dispatch Options page. If the **Template ID** field is blank on the purchase order, then the system checks the:
2. Run Control Page for the Dispatch Process: Enter the template ID for the individual process run of the dispatch process. This dispatch process is the PeopleSoft Job POXMLP and can be accessed from the Dispatch Purchase Orders page in PeopleSoft Purchasing. If the **Template ID** field is blank on this run control page, then the system checks the:
3. **Purchasing Business Unit:** Enter the template ID for all purchase orders dispatched within one business unit by entering the template ID on the Purchase Order Images page within the Purchasing Business Unit component (BUS_UNIT_PM). If the **Template ID** field is blank on the Purchase Order Images page, then the system uses the value that you enter for the purchase order.

See *PeopleTools: BI Publisher for PeopleSoft*.

Tips About Dispatching and Printing Transactions

Here are some tips about dispatching and printing transactions:

- The entry in the SQRDIR set in the PSSQR.INI (Microsoft Windows environment) or PSSQR.UNX (UNIX environment) file must be correctly defined and must point to the correct BINW where the SQR executables are installed.

This PeopleSoft application delivers an undefined (dummy) SQRDIR to enable you to install the SQRs in a location that best suits your configuration. If the SQRDIR is not pointing to the correct BINW directory, certain features do not work as designed. For example, CSV, enhanced HTM, and Postscript files are not produced correctly.

- The email dispatch method is designed to work with an SMTP gateway.

The settings for the SMTP gateway must be entered when you set up a PeopleSoft Process Scheduler server.

see the product documentation for

PeopleTools: Process Scheduler

Related Links

[Understanding Purchase Order Approvals](#)

[Express Purchase Order - Purchase Order Page](#)

[Dispatch Options Page](#)

[PO Header Details Page](#)

[Maintain Purchase Order - Purchase Order Page](#)

[Define Dispatch Options Page](#)

[Dispatch Method Page](#)

[Suppliers Page](#)

[Requisitions Inquiry Page](#)

[Dispatch Options Page](#)

[Understanding Commitment Control in PeopleSoft Purchasing](#)

[Understanding the Buyer's Workbench](#)

“File Locations Page” (PeopleSoft Source to Settle Common Information)

“Preparing to Dispatch by Fax and Email” (PeopleSoft Source to Settle Common Information)

“Entering Supplier Addresses” (PeopleSoft Source to Settle Common Information)

“Entering Supplier Contact Information” (PeopleSoft Source to Settle Common Information)

Dispatching Purchase Orders

This section discusses how to Dispatch Purchase Orders

Pages Used to Dispatch Purchase Orders

Page Name	Definition Name	Usage
Dispatch POs Page	RUN_DISP_POPO005	Run the PO Dispatch/Print process and dispatch purchase orders, run the Email process, or run the PO Dispatch & Email multiprocess job.
Select Purchase Order Page	PO_PICK_ORD2	Select a purchase order for processing.
Supplier Search Page	SUPPLIER_LOOKUP_SEC	Search for suppliers.

Dispatch POs Page

Use the Dispatch POs page (RUN_DISP_POPO005) to run the PO Dispatch/Print process and dispatch purchase orders, run the Email process, or run the PO Dispatch & Email multiprocess job.

Navigation:

Purchasing > Purchase Orders > Dispatch POs > Dispatch POs

This example illustrates the fields and controls on the Dispatch POs page. You can find definitions for the fields and controls later on this page.

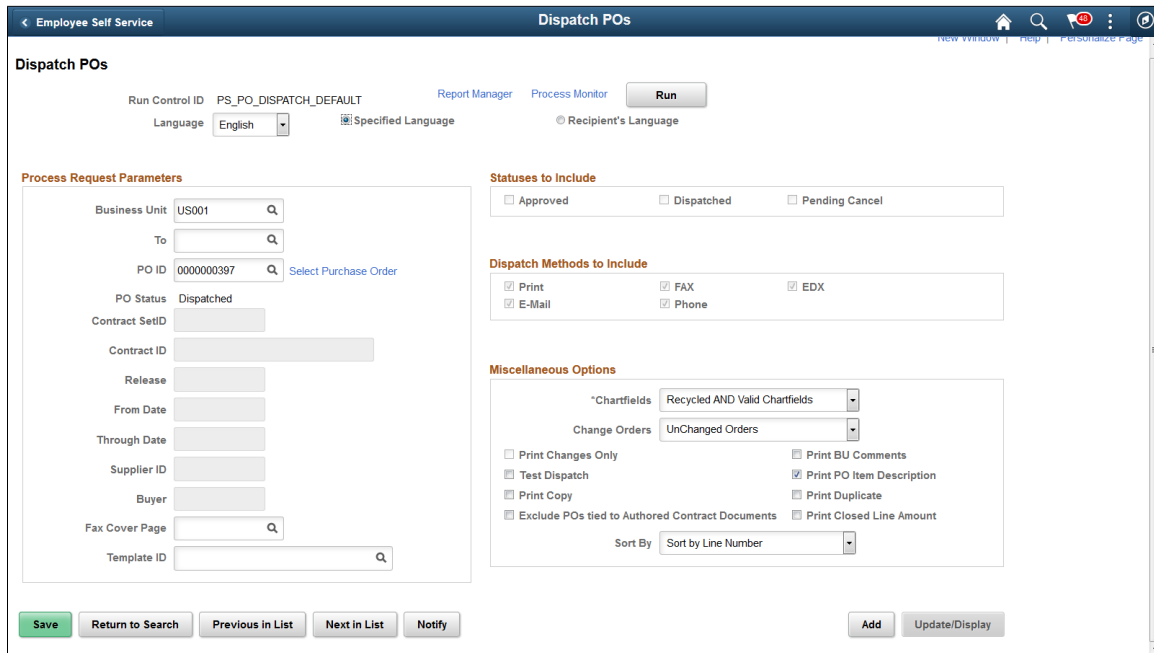

You can dispatch purchase orders based on the criteria that you enter on this page. You can also specify the language in which the printed report should appear.

Process Request Parameters

<i>Field or Control</i>	<i>Description</i>
Business Unit and To	Select a single business unit or a range of units for which you want to dispatch purchase orders.
PO ID (purchase order ID)	Select a single purchase order to dispatch. You can also populate the field by clicking the Select Purchase Order link and searching for and selecting a purchase order.
PO Status (purchase order status)	Displays the current status of the purchase order. The field appears when you select a purchase order.

Field or Control	Description
Select Purchase Order	Click to access the Select Purchase Order page, where you can define a search for purchase orders by business unit, supplier information, and start and end dates. You can only select a single purchase order for dispatching.
Contract SetID	Select a contract SetID if the purchase orders that you are to dispatch are associated with a contract.
Contract ID	Select a contract number if the purchase orders that you are to dispatch are associated with a contract.
Release	Select the release number of the contract.
From Date and Through Date	Select dates to dispatch purchase orders based on purchase order date values.
Supplier ID	Displays the purchase order supplier.
Buyer	Displays the purchase order buyer.
Fax Cover Page	<p>Select a fax cover page if some of the purchase orders that you are dispatching are to be sent by fax. Define fax cover letters in the system on the Fax Cover Letters page.</p> <p>The PO Dispatch/Print process writes to the fax control file the file name associated with the selected cover letter combined with the cover letter file extension that you defined on the Dispatch Configuration page.</p> <hr/> <p>Note: Support for fax cover pages is a function of the fax software that you use. Consult with the fax software supplier to identify the limitations and capabilities of the software fax cover page support.</p> <hr/>

Field or Control	Description
Template ID	<p>Select the report template that you want to use to identify the report layout that the dispatched purchase order format should appear as. The template provides a common report layout for purchase order dispatch for both PeopleSoft eProcurement and Purchasing.</p> <p>The default value for the field is blank. If the field is blank on this run control page, then the system checks the Purchasing business unit settings for a template. The field is available when the Enable XML Publisher check box is selected on the installation options Purchasing page.</p> <p>See <i>PeopleTools: BI Publisher for PeopleSoft</i> .</p> <p>See Understanding Purchase Order Dispatch.</p>

Statuses to Include

In the **Statuses to Include** group box, select whether to include purchase orders with Approved, Dispatched, or Pending Cancel statuses in this run of the dispatch. When a specific purchase order ID is not entered, you must select at least one option.

Field or Control	Description
Dispatched	Select to redispach a dispatched purchase order or to print copies of dispatched purchase orders.

Dispatch Methods to Include

Select which dispatch methods to include in this run of the process. Selected values are only used as a part of the data selection criteria. To change the method by which the purchase order is to be dispatched, you must modify the dispatch method on the Maintain Purchase Order - Purchase Order page.

Field or Control	Description
Print	Prints the purchase order and sets the purchase order status to Dispatched. You can select to format the printed purchase order using the SQR report (default) or BI Publisher.

Field or Control	Description
FAX	<p>The default output format from the PeopleSoft Process Scheduler Request page is PDF. If the fax software does not support the PDF file format, then select an output format that the fax software can handle.</p> <p>If the fax software does not support PDF files, we recommend that you process all of the purchase orders that are to be dispatched through fax together and that you do not print a hard copy at the same time. In the Dispatch Methods to Include group box, select the FAX method only and do not select the Print Copy check box. Then, on the Process Scheduler Request page, select the appropriate output format supported by your fax software.</p>
EDX	<p>Uses the dispatch process to update a series of EC outbound staging tables, including; PS_PO_HDR_OUT_EC, PS_PO_LINE_OUT_EC, and PS_PO_SHIP_OUT_EC. A service operation within the PeopleSoft Integration Broker is required to deliver purchase orders to the recipients through designated channels. The publishing of the outbound data (using a service operation) is sometimes a separate process and sometimes combined with the initial process.</p>
E-Mail	<p>Uses the dispatch process to set the purchase order status to Dispatched and to create a purchase order file in the location that you specify on the File Locations page. The Email process (PO_PO_EMAIL) picks up the output file from the specified location and sends an email message with the purchase order as an attachment.</p>
Phone	<p>Uses the dispatch process to change the purchase order status to Dispatched.</p>

Miscellaneous Options

Field or Control	Description
Chartfields	<p>Select <i>Recycled AND Valid ChartFields</i> to process purchase orders regardless of whether the ChartFields are valid or recycled.</p> <p>Select <i>Recycled Chartfields</i> to process only purchase orders with distribution lines whose ChartFields are identified as <i>Recycled</i>. (PO_LINE_DISTRIB.CHARTFIELD_STATUS = 'R').</p> <p>Select <i>Valid Chartfields</i> to process only purchase orders with distribution lines whose ChartFields are identified as <i>Valid</i>. (PO_LINE_DISTRIB.CHARTFIELD_STATUS = 'V').</p>
Change Orders	<p>Select <i>Changed Orders</i> to process only purchase orders that have been changed.</p> <p>Select <i>Changed and Unchanged Orders</i> to process changed and unchanged purchase orders.</p> <p>Select <i>Unchanged Orders</i> to process only purchase orders that have never been changed.</p>
Print Changes Only	<p>If you select to dispatch changed orders in the Change Orders field, the Print Changes Only check box becomes available. Select to dispatch only the changes to the purchase order, rather than the entire purchase order.</p> <p>If you create the purchase order from a contract with the Release To Single PO Only option selected, select this check box to have the system send only the latest changes to the supplier.</p>
Test Dispatch	<p>Select this check box to perform a test run of the dispatch. When you select this check box, the process runs, but the purchase orders processed do not appear in <i>Dispatched</i> status, and the purchase orders are printed with the word <i>Unauthorized</i> at the bottom of the page. Selecting this option enables you to test the EDX, email, or fax setup without updating the system.</p>
Print Copy	<p>Select this check box to produce a printed copy of each processed purchased order. If any of the processed purchase orders is done by phone, fax, email, or EDX, the system prints a hard copy for review.</p>

Field or Control	Description
Exclude POs tied to Authored Contract Documents (exclude purchase orders tied to authored contract documents)	Select to exclude purchase orders that are linked to authored contract documents from the dispatch process. These documents are created using the PeopleSoft Supplier Contract Management application. When a purchase order has an authored contract document associated to it, certain changes could affect the authored document. Selecting this check box prevents changes to those purchase orders with authored contract documents.
Print BU Comments (print business unit comments)	Select this check box to print comments (terms and conditions) defined for the PeopleSoft Purchasing business unit on the purchase order upon dispatch. Assign comments to the PeopleSoft Purchasing business unit by clicking the Comments link on the Purchasing Definition - Business Unit Definition page.
Print PO Item Description	Select this check box to print the item description from the Maintain Purchase Order - Purchase Order page instead of from the Purchasing Attributes page. The item description stored on the purchase order is in the base language and may have been modified on the purchase order.
Print Duplicate	Select this check box to print the word <i>Duplicate</i> on each purchase order.
Number of Copies	Enter the number of copies of the report that you want. The field becomes available when you select the Print Copy check box.
Print Closed Line Amount	Select this option to display closed lines in the PO Dispatch. Closed line amounts will be included in the purchase order total amount.
Sort By	Select whether to sort the lines on the dispatched purchase order by <i>Line No</i> (line number) or <i>ShipTo ID</i> .

Related Links

“Fax Cover Letters Page” (PeopleSoft Source to Settle Common Information)

“Dispatch Configuration Page” (PeopleSoft Source to Settle Common Information)

“Preparing to Dispatch by Fax and Email” (PeopleSoft Source to Settle Common Information)

“Using Recurring Purchase Order Vouchers” (PeopleSoft Source to Settle Common Information)

[Maintain Purchase Order - Purchase Order Page](#)

Purchasing Definition - Business Unit Definition Page
Defining Purchasing Item Attributes

Select Purchase Order Page

Use the Select Purchase Order page (PO_PICK_ORD2) to select a purchase order for processing.

Navigation:

Click the **Select Purchase Order** link on the Dispatch Purchase Orders page.

Note: Access the Buyer's WorkBench to select multiple purchase orders for dispatch.

<i>Field or Control</i>	<i>Description</i>
PO Unit	Select a business unit.
ID	Select a purchase order ID.
Start Date and End Date	Used as a comparison against the purchase order date to determine which schedules are retrieved. These values appear by default to the current date plus or minus the value in the Days +/- Today field.
Search	Click this button to display the purchase order lines and schedules that match the criteria that you entered.

In the **Retrieved Rows** group box, click the **Sel** check box next to a purchase order to work with that particular purchase order.

Note: After you dispatch the purchase order, the supplier's last activity date (SUPPLIER.LAST_ACTIVITY_DT) is automatically updated to reflect the current date. You can use the supplier's last activity date to deactivate suppliers that have had no activity in the previous fiscal year.

Related Links

“Understanding Supplier Maintenance” (PeopleSoft Source to Settle Common Information)

Using the Purchase Order Dispatch/Purchase Order Change Request EIP

This section provides an overview of the Purchase Order Dispatch/Purchase Order Change Request EIP.

Pages Used to Use the Purchase Order Dispatch/Purchase Order Change Request EIP

<i>Page Name</i>	<i>Definition Name</i>	<i>Usage</i>
“Dispatch Purchase Orders Page” (PeopleSoft Supply Chain Management Integration)	RUN_DISP_POPO005	Run the PO Dispatch/Print process and dispatch purchase orders, run the Email process, or run the PO Dispatch & Email multiprocess job.
“Publish Outbound Message Page” (PeopleSoft Supply Chain Management Integration)	IN_RUN_PUB_MSG	Initiate the outbound message publish process for outbound PeopleSoft Supply Chain Management service operations. .
<u>PO Dispatch Message Selection Criteria Page</u>	PO_RUN_POD	Launch the Purchase Order Dispatch Outbound transaction.

Understanding the Purchase Order Dispatch/Purchase Order Change Request EIP

The Purchase Order Dispatch/Purchase Order Change Request EIP sends purchase orders and purchase order change requests (change orders) to suppliers. This asynchronous batch publish EIP also supports flat-file processing for EDI transaction X.12 850.

Use this EIP to process change order request to the suppliers. You typically use EDI to process these transactions.

Run the PO Dispatch/Print process (POPO005) to stage the purchase order.

Use the common Publish Outbound Message page to initiate the PO_POD Application Engine process that processes the PURCHASE_ORDER_DISPATCH service operation.

Setting Up the Purchase Order Dispatch/Purchase Order Change Request EIP

Service operations in PeopleSoft Integration Broker are delivered with a default status of *Inactive*. You must activate each service operation before attempting to send or receive data from a third-party source or another PeopleSoft system, such as CRM.

Before you can use the Purchase Order Dispatch/Purchase Order Change Request EIP, you must:

1. Set up the service operation within PeopleSoft Integration Broker and Enterprise Components.

Use the information in the following table and refer to the setup instructions in the *PeopleSoft Supply Chain Management Integration 9.2 "Implementing Integrations"*, Setting Up Service Operations section.

See “Setting Up Service Operations” (PeopleSoft Supply Chain Management Integration).

Service Operation	Direction and Type	Handlers	Chunking Available?	Integrates With
PURCHASE_ORDER_DISPATCH	Outbound Asynchronous	ROUTERSENDHDLR	Yes	third-party system EDI transaction X.12 850

2. On the purchase order, specify EDX as the dispatch method.

See the product documentation for *PeopleTools: Integration Broker*

Related Links

“Setting Up Service Operations” (PeopleSoft Supply Chain Management Integration)

“Understanding EDI Integration with PeopleSoft” (PeopleSoft Electronic Data Interchange)

PO Dispatch Message Selection Criteria Page

Use the PO Dispatch Message Selection Criteria page (PO_RUN_POD) to launch the Purchase Order Dispatch Outbound transaction.

Navigation:

Select the **Purchase Order Dispatch** check box on the Publish Outbound Message page to enable the **Purchase Order Dispatch** link.

Click the **Purchase Order Dispatch** link to launch the PO Dispatch Message Selection Criteria page.

The field values on this page are the same fields that appear on the Request for Quote Release Selection Criteria page.

Refer to the section about Request for Quote Release Selection Criteria for more information.

See [RFQ Message Selection Criteria Page](#).

Creating Purchase Order Change Orders

Understanding the Purchase Order Change Order Business Process

When you update a purchase order that has been dispatched, you create or append a change order. With PeopleSoft Purchasing, you can create change orders online using the purchase order pages, or you can load and process change requests using the Change Load Application Engine process (PO_CHNGLOAD) and Change Purchase Order Application Engine process.

The Change Load process loads data from the PO_HDR_EC, PO_LINE_EC, and PO_LINE_SHIP_EC tables. These tables store supplier acknowledgements that arrived in the system using EDX or supplier-facing online acknowledgements. These acknowledgements may contain information that requires you to change the purchase orders.

Based on the Change Map template, the Change Load process compares staged source record fields and field values (PO_HDR_EC, PO_LINE_EC, PO_LINE_SHIP_EC) with target system record fields and field values (PO_HDR, PO_LINE, PO_LINE_SHIP). If a difference exists, the Change Load process creates change requests (CHNG_RSQT, CHNG_RQST_DTL).

Based on the purchase order change template, the Change Purchase Order process creates the necessary change orders from these change request tables. The Change Purchase Order process takes the change order information and creates change history records (PO_CHNG_HDR, PO_CHNG_LINE, PO_CHNG_SHIP) and updates target system records with the changes.

When you request a change to a purchase order that has been sourced from a PeopleSoft eProcurement or Services Procurement requisition, the system places the request in the PeopleSoft Purchasing CHNG_RQST and CHNG_RQST_DTL tables. Using the Change Purchase Order process, the system processes the change requests and updates the purchase order. For purchase orders that have already been dispatched, a change order could be created and dispatched to the supplier.

Note: Backorders entered through the supplier-facing online acknowledgements are also processed through the Change Load and Change Purchase Order processes.

Note: The Purchase Order Change Order business process updates most changed values on the purchase order, regardless of whether the fields exist on the purchase order change template. The purchase order change template determines fields that are tracked and recorded in change order history records, and does not determine the fields that can actually be changed on the purchase order. If you are using the vendor rebate functionality, changing the **Rebate ID** field on the purchase order will not create a change order.

Note: Batch changes to nondispatched purchase orders are stored in the change request tables. These requests are used by the Change Purchase Order process to update original purchase orders. However, these changes, as well as changes made directly to nondispatched purchase orders, are not stored in the change order tables and the change order batch number on the purchase order header is not incremented by 1.

Change requests can come from a variety of sources. If the change request is from a phone call, the best way to make the change is through the online purchase order pages. If the request is from another source, you can make the change online or run a batch process.

Note: If the installation includes PeopleSoft eSupplier Connection, the suppliers can enter their own purchase order acknowledgement (POA) changes directly into the PeopleSoft system. Upon buyer acceptance (online or automatic according to the business unit options flag), the Change Load process requests these online POAs in a similar way as EDX transactions.

Functions that generate change order requests that can be handled by batch processes include:

- EDX purchase order acknowledgments.
- Source requisitions to an existing purchase order.
- PeopleSoft eSupplier Connection online purchase order acknowledgements with a status of *Buyer Accepted*.
- PeopleSoft Order Management direct-shipped order changes.
- PeopleSoft Manufacturing subcontract changes.
- PeopleSoft Supply Planning planned order changes.
- Par location replenishment.
- Close Short Application Engine process (PO_CLSSHORT).
- PeopleSoft eProcurement change requests and change orders.

Change requests received using EDX or eSupplier Connection online acknowledgements are loaded into the Change Request table by the Change Load process. The other functions write directly to the Change Request table.

You can review EDX change requests or change requests from other functions in the system on the Approve Change Requests page. You approve the requests that you want processed by the Change Purchase Order process.

As part of processing purchase order changes from PeopleSoft eProcurement, the system also provides a message back to requesters if their changes cannot be updated for the purchase order. The message provides details at a specific line or schedule level and also indicates why the change could not be applied. The system uses the PO_CMMSGSEND batch program to process the messages.

During message processing if an error is detected during the PO Edit process and the source of the transaction is eProcurement (EPO), the system:

1. Updates purchase order change request transactions with error information.
2. Updates the PeopleSoft eProcurement change request (PV_CHNG_RST_DTL.PROCESS_FLG = E) with error information.
3. The PO Edit process will then:
 - a. Issue a message to the requester using the PO_CMMSGSEND batch program.

The message includes the requisition ID, line, and schedule, purchase order ID, line, and schedule, message description, and buyer name.

- b. Call the Requisition Update function to update the open quantity when the source of the change is a PeopleSoft eProcurement requisition and the change was an increase to quantity.

This makes the open quantity available for future sourcing.

- c. When the source of the change is a PeopleSoft eProcurement requisition and the change was either a quantity decrease or increase to an amount only line or increase to a line that is distributed by amount, the process:
 - Backs out the requisition change by calling the Requisition Update function.
 - Budget checks the requisition and purchase order when commitment control is in use.

Note: When purchase order change requests do not have errors, the system calls the Common PO Change process (PO_CMCHNG) to update the purchase order transactions.

Error messages for change requests are available under the Error Messages tab on the Change Requests page. To access the page, select **Purchasing > Purchase Orders > Manager Change Orders > Approve Change Requests** and click the **Show Detail Entry** link on the Change Requests page.

This diagram illustrates the Change Order process flow:

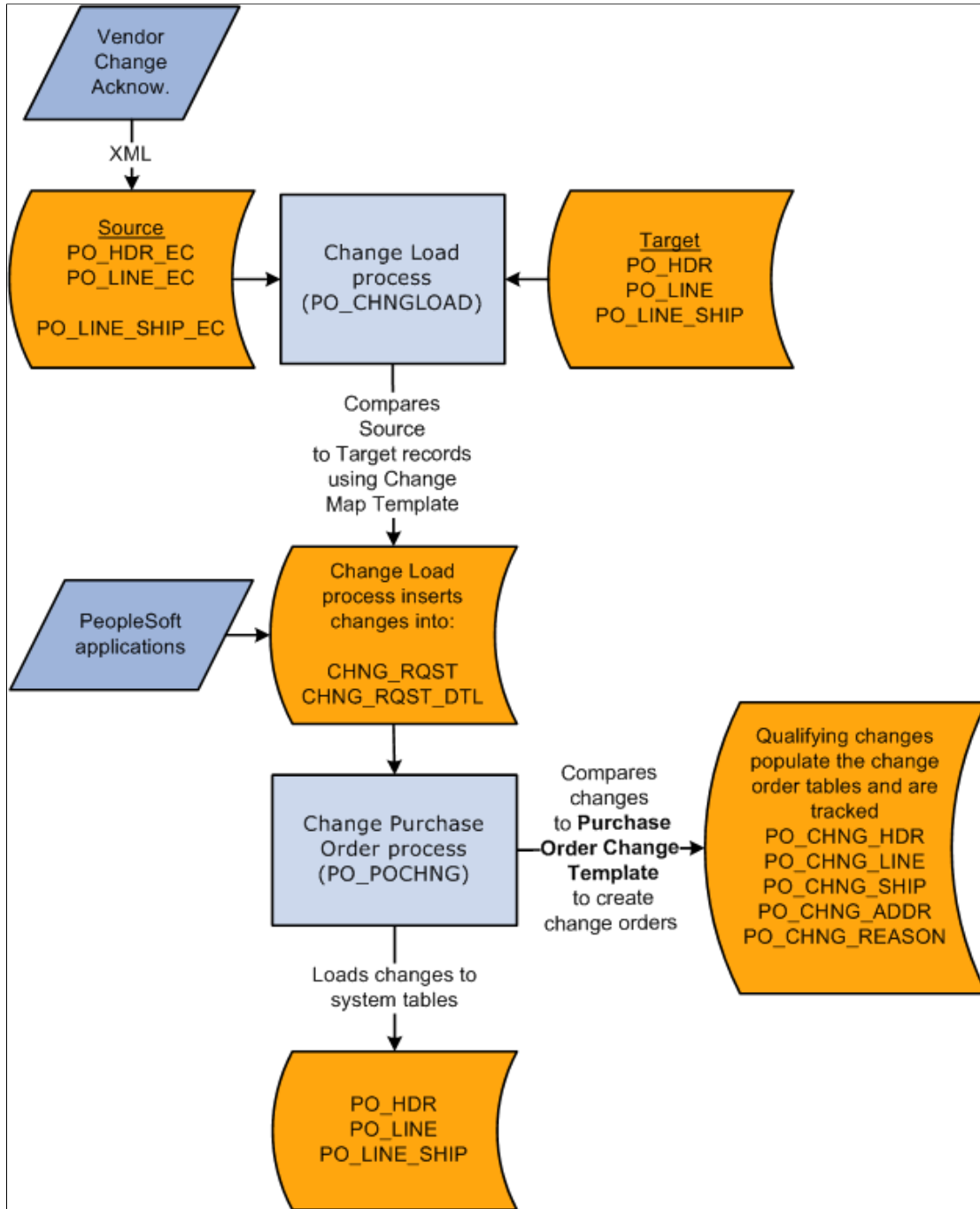

Note: Also, the system supports change requests to the ATTN_TO (Attention To) field in the PO_LINE_DISTRIB table. This is the only PO_LINE_DISTRIB table field for which change requests are processed.

When you use online pages or when you run the Change Purchase Order process to update previously dispatched purchase orders, two events take place:

- The actual purchase order is updated.

You make the change to the online purchase order manually or the Change Purchase Order process updates the purchase order when the change is not done manually.

- The change order tracking tables are updated with the change to the purchase order.

When you change the purchase order online, the system automatically updates the change order tracking tables. When the change is not done online, the Change Purchase Order process inserts the change into the change order tracking tables.

When processing change orders in batch processing, the system uses the default reason code and reason comment value. This step is in the PO_CHNGLOAD process to set the change reason code to the value of the change source when the transactions being loaded are from the change sources listed in the Purchase Order Change Order Fields table. Change source descriptions are listed in the Reason Description Default Value column in this table:

<i>When Change Source is:</i>	<i>Set Reason Code to:</i>	<i>Reason Description Default Value</i>
PLN	PLN	Planning System
EDX	EDX	PO Acknowledgement
POC	POC	PO Change Batch Process
PRD	PRD	Production/Shop Floor
CRT	CRT	PAR Location Replenishment
CST	CST	Close Short Purchase Orders

Common Elements Used in Purchase Order Change Order Business Process

Field or Control	Description
Change Order Source/Source	<p>Displays the source of the change requests. Values are:</p> <p><i>CRT</i> (cart replenishment): Par location replenishment.</p> <p><i>DRP</i> (order management direct ships): PeopleSoft Order Management direct-shipped order changes.</p> <p><i>EDX</i> (EDX change order): Electronic data exchange or supplier-facing online change order acknowledgements.</p> <p><i>EPR</i> (user change request): PeopleSoft eProcurement change requests and change orders.</p> <p><i>PLN</i> (planning system): PeopleSoft Supply Planning planned order changes.</p> <p><i>POC</i> (purchase order change batch process): Used internally by the Change Purchase Order process to distinguish rows picked up by the process from those created by the process.</p> <p><i>BPA</i> (blanket order): Used internally by the Change Purchase Order process for blanket purchase orders.</p> <p><i>PRD</i> (production/shop floor): PeopleSoft Manufacturing subcontract changes.</p> <p><i>PMC PO Buyer Mass Change</i></p>
UPN ID (universal product number identifier)	<p>Displays the universal product number identifier assigned to a unique combination of item ID, manufacturer ID, and unit of measure (UOM).</p>
Change Order Batch Number	<p>A grouping of changes to a transaction that use a unique batch number. For purchase orders, the batch number is incremented each time the purchase order is dispatched and you change the purchase order. The change order batch number is communicated to the supplier. For requisitions, the batch number is incremented for each set of changes after the requisition is approved, budget checked, or sourced, depending on the option specified for the business unit.</p>
Change Tracking	<p>An audit trail of changes made to a transaction. You can review purchase order changes that were made to tracked field using the Review Change History menu.</p>

Field or Control	Description
PO Change Order Batch Process (purchase order change order batch process)	A purchase order process that supports updating most of the common header, line, and schedule level information on purchase orders. The process also tracks changes after purchase orders have been dispatched and when the changed fields are set for tracking in the purchase order change template. The Purchase Order Change Order process updates purchase orders, but does not track change orders if the purchase order has not been dispatched.

Defining Change Order and Sequence Numbers

A change order number identifies the batch of changes that you submit to the supplier for a purchase order after its initial dispatch. The first time that you update a dispatched purchase order, the system displays *Change Order 1* next to the purchase order number in the purchase order header. Each time you update the purchase order after dispatching a batch of changes to the supplier, the change order number is increased by one.

A change sequence number tracks the sequence of changes made within each purchase order at the header, line, and schedule levels. After the initial dispatch of a purchase order, a change sequence number is assigned to each change. These sequence numbers don't appear on the purchase order, but appear in the purchase order history.

Example

Here is an example of batch changes:

1. You dispatch a purchase order containing three lines.
2. You create a change on line 1.

The header change order batch number is set to 1; the change sequence number for the first line is also 1.

Note: A historical row is created to store original values for line 1. The header change order batch number is 0 and change sequence number for the first line is 0.

3. After you dispatch the first batch of changes (change order batch number 1), you change lines 1 and 3.
 - The change order batch number is 2, because you are making changes after dispatching change order number 1.
 - Because this is the second time that you have changed line 1, its change sequence is 2.
 - Because you have changed line 3 for the first time, its change sequence is 1.

Note: The system creates a historical row to store original values for line 3. The header change order batch number is 0 and the change sequence number for the first line is 0.

This diagram illustrates how the PO_CHNG_LINE table helps track the batch and sequence changes discussed in the example:

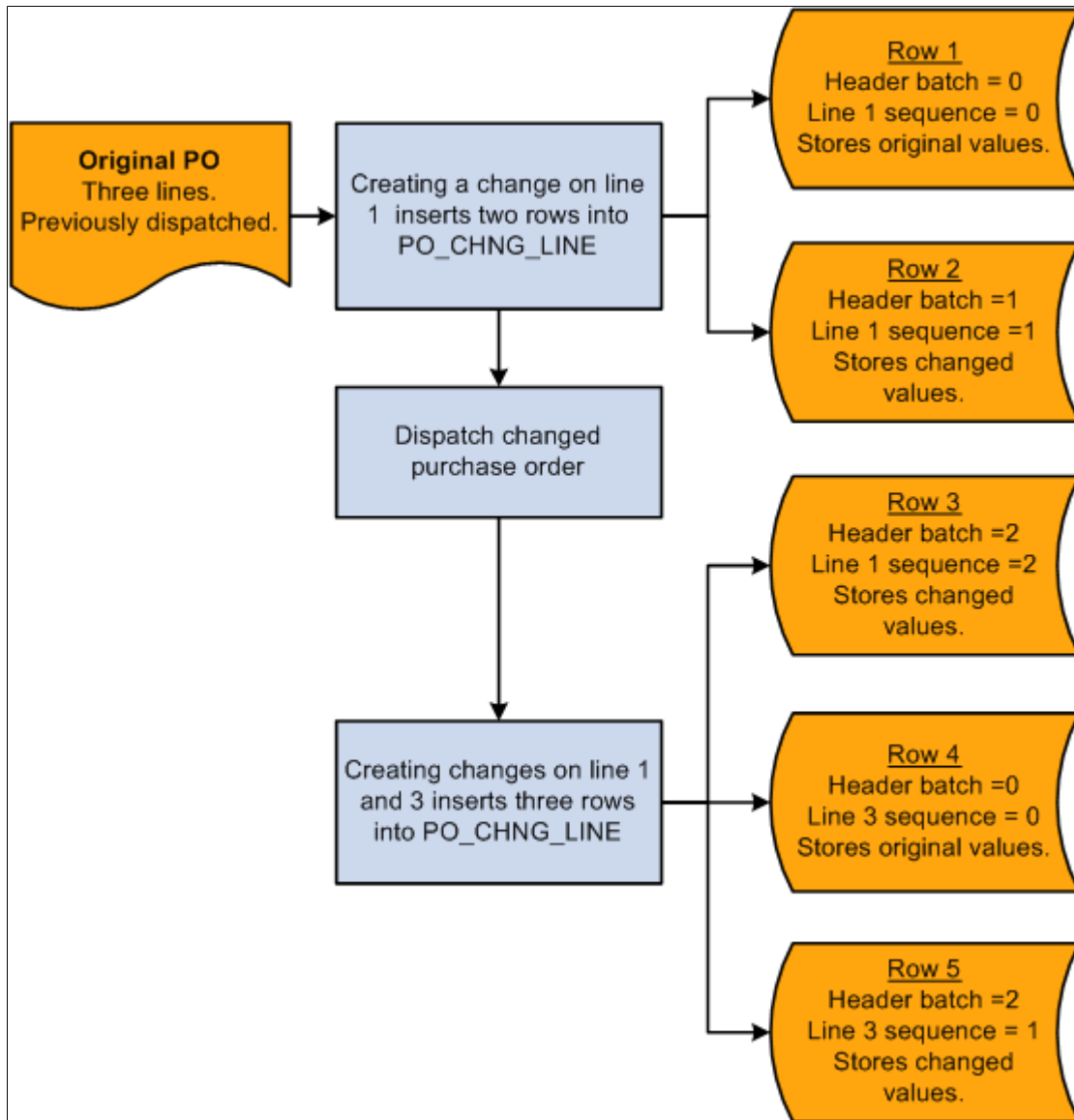

Similar changes are stored in PO_CHNG_HDR, PO_CHNG_SHIP, and PO_CHNG_ADDR tables when changes are made to header, schedule, and one time address fields that are eligible for change order tracking.

Related Links

[Reviewing and Approving Change Order Requests](#)

“Creating Change Templates” (PeopleSoft Source to Settle Common Information)

[Loading Change Orders Received Using EDXs or Supplier-Facing Online Acknowledgements \(PeopleSoft eSupplier Connection\)](#)

Setting Up Purchase Order Change Templates

Use the purchase order change template to define which fields, if modified on a previously dispatched purchase order, will trigger a change order. When you configure the change template, you define the fields that you want to track at the various change order levels.

When triggering a change order online, the purchase order considers all fields defined on the purchase order change template.

The Change Purchase Order process looks at a subset of the fields on the change template. The fields that are considered by the Change Purchase Order process are discussed in the overview of the purchase order change order business process.

Note: The Purchase Order Change Order business process updates changed values on the purchase order, regardless of whether the fields exist on the purchase order change template. The purchase order change template helps to determine fields that are tracked and recorded in change order history tables, and does not determine the fields that can actually be changed on the purchase order.

See the product documentation for *PeopleTools: Application Engine*

Related Links

[Understanding the Purchase Order Change Order Business Process](#)

“Creating Change Templates” (PeopleSoft Source to Settle Common Information)

Identifying Purchase Order Change Order Fields

This table lists all of the fields as delivered by the system that are eligible for change order tracking that can be processed by the Change Purchase Order process. You can modify this list by updating the purchase order change template.

Table	Field
PO_HDR	ACCOUNTING_DT
PO_HDR	ADDRESS_SEQ_NUM
PO_HDR	BACKORDER_STATUS
PO_HDR	BILL_LOCATION
PO_HDR	BUDGET_HDR_STATUS
PO_HDR	BUDGET_HDR_STS_NP

Table	Field
PO_HDR	BUYER_ID
PO_HDR	CC_DISP_OPTION
PO_HDR	CONTACT_NAME
PO_HDR	CONTACT_PHONE
PO_HDR	CNTCT_SEQ_NUM
PO_HDR	CURRENCY_CD
PO_HDR	CURRENCY_CD_BASE
PO_HDR	DISP_ACTION
PO_HDR	DISP_METHOD
PO_HDR	DOC_TOL_HDR_STATUS
PO_HDR	DST_CNTRL_ID
PO_HDR	ERS_ACTION
PO_HDR	HOLD_STATUS
PO_HDR	LC_ID
PO_HDR	MATCH_ACTION
PO_HDR	MATCH_CNTRL_ID
PO_HDR	MATCH_STATUS_PO
PO_HDR	ORIGIN
PO_HDR	PAY_TRM_BSE_DT_OPT
PO_HDR	POST_DOC

Table	Field
PO_HDR	POA_REQS
PO_HDR	POA_STATUS
PO_HDR	PO_DT
PO_HDR	PO_REF
PO_HDR	PO_STATUS
PO_HDR	PO_TYPE
PO_HDR	PREPAID_PO_FLG
PO_HDR	PYMNT_TERMS_CD
PO_HDR	RATE_DATE
PO_HDR	RT_TYPE
PO_HDR	SALES_CNTCT_SEQ_N
PO_HDR	SPLIT_PO_BY_SHIPTO
PO_HDR	TAX_EXEMPT
PO_HDR	TAX_EXEMPT_ID
PO_HDR	TEMPLATE_ID
PO_HDR	TERMS_BASIS_DT
PO_HDR	VENDOR_ID
PO_HDR	VNDR_LOC
PO_LINE	AMT_ONLY_FLG
PO_LINE	AUC_GROUP_ID

Table	Field
PO_LINE	BENEFIT_ID
PO_LINE	CANCEL_STATUS
PO_LINE	CATEGORY_ID
PO_LINE	CAT_LINE_NBR
PO_LINE	CLOSE_SHORT_FLG
PO_LINE	CNTRCT_ID
PO_LINE	CNTRCT_LINE_NBR
PO_LINE	CNTRCT_SETID
PO_LINE	CONFIG_CODE
PO_LINE	DESCR254_MIXED
PO_LINE	DESCR254_MIXED2
PO_LINE	GPO_CNTRCT_NBR
PO_LINE	GPO_ID
PO_LINE	INSPECT_CD
PO_LINE	INV_ITEM_ID
PO_LINE	ITM_ID_VNDR
PO_LINE	MFG_ID
PO_LINE	MFG_ITM_ID
PO_LINE	MILESTONE_NBR
PO_LINE	ORIG_INV_ITEM_ID

Table	Field
PO_LINE	PACKING_VOLUME
PO_LINE	PACKING_WEIGHT
PO_LINE	PHYSICAL_NATURE
PO_LINE	PO_GROUP_ID
PO_LINE	PRICE_DT_TYPE
PO_LINE	PRIMARY_UNIT
PO_LINE	QTY_TYPE
PO_LINE	RECV_REQ
PO_LINE	RELEASE_NBR
PO_LINE	REPLEN_OPT
PO_LINE	RFQ_ID
PO_LINE	RFQ_LINE_NBR
PO_LINE	ROUTING_ID
PO_LINE	UNIT_ALLOC_AMT
PO_LINE	UNIT_ALLOC_QTY
PO_LINE	UNIT_MEASURE_VOL
PO_LINE	UNIT_MEASURE_WT
PO_LINE	UNIT_OF_MEASURE
PO_LINE	VERSION_NBR
PO_LINE	VNDR_CATALOG_ID

Table	Field
PO_LINE	VRBT_ID
PO_LINE	WTHD_CD
PO_LINE	WTHD_SW
PO_LINE_SHIP	BCKORD_ORD_SCHED
PO_LINE_SHIP	BUSINESS_UNIT_IN
PO_LINE_SHIP	BUSINESS_UNIT_OM
PO_LINE_SHIP	BUSINESS_UNIT_RTV
PO_LINE_SHIP	CANCEL_STATUS
PO_LINE_SHIP	CARRIER_ID
PO_LINE_SHIP	COUNTRY_SHIP_FROM
PO_LINE_SHIP	COUNTRY_SHIP_TO
PO_LINE_SHIP	COUNTRY_VAT_BILLFR
PO_LINE_SHIP	COUNTRY_VAT_BILLTO
PO_LINE_SHIP	COUNTRY_VAT_SHIPTO
PO_LINE_SHIP	CURRENCY_CD
PO_LINE_SHIP	CURRENCY_CD_BASE
PO_LINE_SHIP	CUSTOM_PRICE
PO_LINE_SHIP	DISTRIB_MTHD_FLG
PO_LINE_SHIP	DUE_DT
PO_LINE_SHIP	DUE_TIME

Table	Field
PO_LINE_SHIP	EXT_PRC_TOL
PO_LINE_SHIP	EXT_PRC_TOL_L
PO_LINE_SHIP	FREIGHT_TERMS
PO_LINE_SHIP	FROZEN_FLG
PO_LINE_SHIP	FRT_CHRG_METHOD
PO_LINE_SHIP	FRT_CHRG_OVERRIDE
PO_LINE_SHIP	LIQUIDATE_METHOD
PO_LINE_SHIP	MATCH_LINE_OPT
PO_LINE_SHIP	MATCH_STATUS_LN_PO
PO_LINE_SHIP	MERCHANDISE_AMT
PO_LINE_SHIP	MERCH_AMT_BSE
PO_LINE_SHIP	ORDER_INT_LINE_NO
PO_LINE_SHIP	ORDER_NO
PO_LINE_SHIP	ORIG_PROM_DT
PO_LINE_SHIP	PCT_EXT_PRC_TOL
PO_LINE_SHIP	PCT_EXT_PRC_TOL_L
PO_LINE_SHIP	PCT_UNDER_QTY
PO_LINE_SHIP	PCT_UNIT_PRC_TOL
PO_LINE_SHIP	PCT_UNIT_PRC_TOL_L
PO_LINE_SHIP	PRICE_PO

Table	Field
PO_LINE_SHIP	PRODUCTION_ID
PO_LINE_SHIP	QTY_PO
PO_LINE_SHIP	QTY_RECV_TOL_PCT
PO_LINE_SHIP	REJECT_DAYS
PO_LINE_SHIP	RJCT_OVER_TOL_FLAG
PO_LINE_SHIP	RTV_ID
PO_LINE_SHIP	RTV_LN_NBR
PO_LINE_SHIP	SCHED_LINE_NBR
PO_LINE_SHIP	SHIPTO_ID When and only when ship to ID is selected for change tracking, changes made to the one time address will also be tracked.
PO_LINE_SHIP	SHIP_DATE
PO_LINE_SHIP	SHIP_TO_CUST_ID
PO_LINE_SHIP	SHIP_TYPE_ID
PO_LINE_SHIP	SUT_APPLICABILITY
PO_LINE_SHIP	SUT_BASE_ID
PO_LINE_SHIP	SUT_EXCPTN_CERTIF
PO_LINE_SHIP	TAX_CD_SUT
PO_LINE_SHIP	TAX_CD_VAT
PO_LINE_SHIP	TAX_FRGHT_FLG
PO_LINE_SHIP	TAX_MISC_FLG
PO_LINE_SHIP	TAX_VAT_FLG

Table	Field
PO_LINE_SHIP	TRFT_RULE_CD
PO_LINE_SHIP	ULTIMATE_USE_CD
PO_LINE_SHIP	UNIT_PRC_TOL
PO_LINE_SHIP	UNIT_PRC_TOL_L
PO_LINE_SHIP	VAT_APPLICABILITY
PO_LINE_SHIP	VAT_CALC_FRGHT_FLG
PO_LINE_SHIP	VAT_CALC_GROSS_NET
PO_LINE_SHIP	VAT_CALC_MISC_FLG
PO_LINE_SHIP	VAT_CALC_TYPE
PO_LINE_SHIP	VAT_DCLRTRN_POINT
PO_LINE_SHIP	VAT_EXCPTN_CERTIF
PO_LINE_SHIP	VAT_EXCPTN_TYPE
PO_LINE_SHIP	VAT_RCRD_INPT_FLG
PO_LINE_SHIP	VAT_RCRD_OUTPT_FLG
PO_LINE_SHIP	VAT_RECALC_FLG
PO_LINE_SHIP	VAT_RGSTRN_SELLER
PO_LINE_SHIP	VAT_ROUND_RULE
PO_LINE_SHIP	VAT_TXN_TYPE_CD
PO_LINE_SHIP	VAT_USE_ID
PO_LINE_SHIP	ZERO_PRICE_IND

Related Links

“Creating Change Templates” (PeopleSoft Source to Settle Common Information)

Reviewing Processing Rules for the Change Purchase Order Process

In addition to ensuring that the changed fields are valid change order fields, the Change Purchase Order process follows these rules when generating change orders.

Status-Related Rules

These are the status-related rules for the Change Purchase Order process:

- Purchase orders in initial, pending, cancel, or canceled status are not eligible for change requests.
- You can request only that the purchase order status be changed to *X* (canceled).
You cannot request that the purchase order status change to approved, completed, or dispatched. However, the process may change it to approved, pending approval, or open.
- The only change allowed against a schedule that is associated with a work order is Cancel.
- A change request cannot activate or close a line or schedule.
- The affected purchase order is set to *In Process* (PO_HDR.IN_PROCESS_FLG = Y), so no online activity can take place while the background change process is running.
- Purchase order status is set according to the rules that are defined on the PO Changes page.

The system uses the PO_APPROVAL table primarily for workflow approvals.

- APPROVAL_STATUS on the PO_APPROVAL table is set to A if PO_STATUS is A.
- APPROVAL_STATUS on the PO_APPROVAL table is set to I if PO_STATUS is O or PA.

Validation Rules

These are the validation rules for the Change Purchase Order process:

- The change request process assumes that a valid date is passed to it.
- Fields are edited against the prompt or translate values that are specified in the record layout.

Where a percentage edit table is specified in the record layout, the field is edited against the entire table.

- Validation against the Supplier and Item tables, to ensure that the UOM and ship to location are valid for that supplier or item, does *not* occur.

Cancellation Rules

These are the cancellation rules for the Change Purchase Order process:

- If you cancel a purchase order, all lines and schedules are canceled, with change records created for each line and schedule.
If you cancel a purchase order line, all schedules are canceled, and the system creates change records for each schedule.
- If you try to create a change order to cancel a line or a schedule that has already been partially or fully received, the system rejects the transaction.
- The only active schedule for a line cannot be canceled.

Price Change Rules

These are the price change rules for the Change Purchase Order process:

- You cannot change a price to 0 unless the zero price indicator is set to *Y*.
- If you change the price, the system does not perform a price calculation.
- If you change the item ID, UOM, due date, purchase order quantity, or ship to location, the system recalculates the price and, if necessary, the currency is converted.
- The system only reprices changed schedules.

For example, if pricing is done at the line-quantity level and a schedule-quantity change affects the price break, only that schedule receives the new price. The system does not force change requests for other schedules on the line.

Quantity Change Rules

These are the quality change rules for the Change Purchase Order process:

- The change order quantity becomes the updated quantity on the purchase order.
The change order quantity is not the quantity by which the prior quantity is increased or decreased.
- If a unit of measure changes with the change request, the system adjusts the quantity appropriately.

Distribution and Schedule Adjustment Rules

These are the distribution and schedule adjustment rules for the Change Purchase Order process:

- If the schedule quantity or amount changes, the distributions are updated by prorating the revised schedule quantity or amount across all distributions, using the distribution percent.
This is true regardless of whether the distributions have been received.
- If a distribution quantity or merchandise amount is updated, the distributions are rebalanced to ensure that they add up to the schedules.

Conversion Rate Rules

These are the conversion rate change rules for the Change Purchase Order process:

When you create a purchase order, the system updates this field if the conversion rate changes under these conditions:

- UOM or item ID changes.
- PeopleSoft Inventory is not installed and a change is made to the purchase order price or quantity.
- PeopleSoft Inventory is installed and you change the purchase order price or quantity, and the run control option *Use Current UOM Conv Rate* indicates that you are to use the new conversion rate.

Contract-Related Rules

If a contract is specified on the purchase order and a quantity changes, the system updates the contract release amounts and quantities. If a supplier minimum or maximum is not met or a currency conversion fails when pricing, the system issues an error message.

Tax-Related Rules

These are the tax-related rules for the Change Purchase Order process:

- The system updates the value-added tax (VAT) amounts and sales and use tax amounts as appropriate.
- If you change the ship to ID, it doesn't cause a change to the sales and use tax base ID.

BackOrder Rules

If a backorder is created for the purchase order through the supplier-facing acknowledgement component, the Change Purchase Order process automatically inserts the backorder schedule onto the purchase order and assigns the original schedule number to the **BCKORD_ORG_SCHED** field.

Also, for backorders created through the supplier portal, the system populates **PO_LINE_SHIP_EC.BCKORD_ORG_SCHED** with the original backorder schedule number.

Split PO by Ship To Rules

The Use One Ship To setting on the PO Header determines whether or not the PO should be restricted to a single Ship To Location. If the PO is identified as only allowing for one Ship To Location and the current change request is to update one of the Ship To Locations so that there ends up being a mix of Ship To Locations on the PO:

- If the Approve Change Requests page is being utilized, a message will appear indicating that the change of Ship To Location will result in a mix of Ship To Locations on the PO.
- If approved, the PO Change Order process will proceed with the update of the PO with the new Ship To Location.
- After updating the Ship To Location as usual, the process will proceed to update the PO Header 'Use One Ship To' setting to 'N' to signify that the PO now allows for multiple Ship To Locations
- The process will then update the Change Request Message Log with a message reflecting the Ship To situation
- Lastly, the PO Change Order process will issue an Enterprise Components Notification Framework message to the Buyer stating that the PO changed from only allowing one Ship To Location to allowing multiple Ship To Locations so the Buyer can be reminded to take action on the PO if they wish.

Related Links

[Creating Change Orders from Approved Change Requests](#)

[Understanding the UOM Conversion Hierarchy](#)

Generating Purchase Order Change Orders Online

To create a change order online, use the same pages that you use to update a purchase order, except that you'll be updating a dispatched purchase order. Fields that are eligible for change order tracking according to the purchase order change template are not available for entry on a dispatched purchase order. If you want to edit these fields, perform these actions:

- To make a header-level change, access the Maintain Purchase Order - Purchase Order page and click the **Change Order** button next to the **PO Status** field.

The fields that trigger change order generation become available for entry.

- To make a line level change, select the Statuses tab on the **Lines** grid of the Maintain Purchase Order - Purchase Order page and click the **Create Line Change** button.

Alternatively, access the Details for Line page and click the **Chng Line** button. The fields that trigger line-level change order generation become available for entry.

- To make a schedule-level change, click the **Create Schedule Change** button on the Statuses tab from the Maintain Purchase Order - Schedules page.

To access this page, click the **Schedule** button from the Details tab of the **Lines** grid on the Maintain Purchase Order - Purchase Order page. The fields that trigger change order generation become available for entry.

- Adding a line automatically creates a change order for the line and new schedules are added.
- If you change the quantity on a purchase order line, and only one schedule exists, the system automatically creates a change order for the schedule.

You do not have to click the **Create Line Change** button to make changes to the purchase order line quantity. The line quantity serves as a work field on the purchase order, so changes to its value are not tracked as changes. However, the system creates a schedule-level change order.

After you create a change order online, dispatch it as you would a regular purchase order.

When creating change orders using the online purchase order pages, if you attempt to cancel a line or a schedule that has been received (even partially), the system adjusts the quantity of the line or schedule and creates a change order.

For example, if the line quantity is 5, and two lines or schedules have been received, the line quantity becomes the received quantity, or 2 in this example. When the system transmits the change order to the supplier, the supplier sees that the quantity on the cancellation equals the quantity that he has already shipped, and he can cancel the remainder.

Note: When a purchase order has an authored contract document associated with it, certain changes made to the purchase order could affect the authored document. You should contact the contract specialist or the buyer in case they need to update the document.

Related Links

[Creating Purchase Order Headers](#)

[Creating Purchase Order Lines](#)

[Creating Purchase Order Schedules](#)

[Understanding Purchase Order Dispatch](#)

“Creating Change Templates” (PeopleSoft Source to Settle Common Information)

Loading Change Orders Received Using EDXs or Supplier-Facing Online Acknowledgements (PeopleSoft eSupplier Connection)

This section discusses how to run the Change Load process.

The Change Load process loads changes to purchase orders received using EDX or online acknowledgements into the Change Request table. You can review and approve these change requests on the Change Ord Rqsts page.

Page Used to Load Change Orders Received Using EDXs or Supplier-Facing Online Acknowledgements (PeopleSoft eSupplier Connection)

<i>Page Name</i>	<i>Definition Name</i>	<i>Usage</i>
Change Load Page	RUN_CHNG_LOAD	Run the Change Load process.

Related Links

[Identifying Purchase Order Change Order Fields](#)

[Reviewing and Approving Change Order Requests](#)

Change Load Page

Use the Change Load page (RUN_CHNG_LOAD) to run the Change Load process.

Navigation:

Purchasing > Purchase Orders > Manage Change Orders > Load Change Requests > Change Load

Field or Control	Description
Change Order Map Template	<p>Select the template to use for this process. <i>EDX</i> is the delivered option. You can create other templates on the Change Map Template page.</p> <hr/> <p>Note: For online acknowledgements, if the Buyer Accepted POA Sources check box is selected on the PO Change Options page in the business unit setup options for PeopleSoft Purchasing the change requests are created and automatically set as approved. This check box applies to buyer-approved online acknowledgements and EDX acknowledgements that have been reviewed. Auto approve change orders from all other sources apply to direct ship and planning. This enables you to bypass the Approve Change Request function.</p>

Related Links

“Creating Change Map Templates” (PeopleSoft Source to Settle Common Information)

Using the Purchase Order and Purchase Order Change Order Acknowledgement EIP

This section provides an overview of the Purchase Order and Purchase Order Change Order Acknowledgement EIP and discusses how to use the Purchase Order and Purchase Order Change Order Acknowledgement EIP.

Pages Used to Use the Purchase Order and Purchase Order Change Order Acknowledgement EIP

Page Name	Definition Name	Usage
<u>Change Load Page</u>	RUN_CHNG_LOAD	Run the Change Load process.
Data Collection Setup Page	BCT_SETUP_FS	Set the option to keep transaction log history for electronic data collection transactions and to set the default file suffix.
“Data Def Maint Page” (PeopleSoft Supply Chain Management Integration)	EO_EIP_CTL_MAINT	View data detail or correct errors for service operations that contain data rather than transactions

Understanding the Purchase Order and Purchase Order Change Order Acknowledgement EIP

The Purchase Order Acknowledgement and Purchase Order Change Order Acknowledgement EIP processes service operations that contain purchase order acknowledgements and change order acknowledgements from suppliers.

This asynchronous batch subscribe EIP also supports flat-file processing for electronic data interchange (EDI) transactions X.12 855 and 860.

Run the Change Load process (PO_CHNGLOAD) to move the data from staging tables to application tables.

Using the Purchase Order and Purchase Order Change Order Acknowledgement EIP

Oracle delivers the service operations in PeopleSoft Integration Broker with a default status of *Inactive*. You must activate each service operation before attempting to send or receive data from a third-party source or another PeopleSoft system, such as CRM.

Before you can use the Purchase Order and Purchase Order Change Order Acknowledgement EIP, you must:

1. Set up the service operation within PeopleSoft Integration Broker and Enterprise Components:

Use the information in the following table and refer to the setup instructions in the *PeopleSoft Supply Chain Management Integration 9.2 "Implementing Integrations"* topic, Setting Up Service Operations section.

Service Operation	Direction and Type	Handlers	Chunking Available?	Integrates With
PURCHASE_ORDER_ACKNOWLEDGEMENT	Inbound Asynchronous	Purchase Order Acknowledgement	No	third-party system EDI transactions X.12 855 and 860.

2. Run the Change Load process (PO_CHNGLOAD) to move the data from staging tables to application tables.
3. Use the Data Def Maint page to view service operation data and correct error messages that are picked up in the processing of the service operation.

See the product documentation for *PeopleTools: Integration Broker*

Related Links

“Setting Up Service Operations” (PeopleSoft Supply Chain Management Integration)

“Understanding EDI Integration with PeopleSoft” (PeopleSoft Electronic Data Interchange)

Using the Purchase Order Close Short Workbench

This section provides an overview of the Close Short job

Pages Used with the Purchase Order Close Short Workbench

<i>Page Name</i>	<i>Definition Name</i>	<i>Usage</i>
<u>PO Close Short Workbench - Purchase Orders Page</u>	PO_CLOSE_SHORT_WB	Use the PO Close Short Workbench.
<u>Process Request Options Page</u>	PO_CLS_SHORT_PRCS	Define Close Short process request options.

Understanding the Close Short Job

The Close Short job enables you to close short both stockless and nonstockless line items on a purchase order. When you run the Close Short job, the system runs both the PO_CLSSHORT AE process and the PO_POCHNG AE process and updates the purchase orders to reflect the close short processing. This is different than when you run the Close Short process by itself from the PO receiving menu, which creates the batch purchase orders change requests only and requires that you run the Process Change Orders program afterward.

If the PO Close Short is called from the receipt push process (PO_RECVPUSH), the Close Short Set Option will be determined by using the PO line – schedule’s receiving option, matching option, and Amount Only Indicator, along with the PO Close Short Rule ID of the PO business unit to identify the Rule in the PO Close Short Rule Defaults table. The assigned Close Short Set Option value will be used to determine the value for updating the PO. When the PO Close Short process is called from the receipt push process, only the PO lines where Receiving is Required, and the defaulted / assigned Close Short Set Option value of either ‘Received Quantity’ or ‘Received Amount’ are processed.

When the PO Close Short AE process is called from the PO Close Short WorkBench, the Close Short Set Option values on the PO Close Short Work scroll table are used to determine the value for updating the PO.

Note: You can also initiate the Close Short process at the time of receipt. The Close Short AE process (PO_CLSSHORT) is called by the PO_RECVPUSH process when the receipt header **Run Close Short** check box is selected and at least one of the receipt lines has the **Close Short** field selected.

When you run the Close Short process from the Run Control page, the system processes all purchase orders for the selected business unit.

Note: The PO_RECVPUSH process can initiate the PO_CLSSHORT process, but the PO_CLSSHORT process cannot initiate the PO_RECVPUSH process.

During the Close Short process, the system:

- Creates a PO Change order transaction, to set the purchase order schedule value equal to the total Receipt/Matched/Vouchered value for the purchase order schedule based on the close short set option, when the **Close Short** flag is selected for the corresponding Purchase order line.
- Creates a PO line, schedule Cancel transaction for line, schedules that have not had any Receiving/Matching/Vouchering activity when other line schedules on the PO have had activity, and the **Close Short** flag is selected for the PO line.
- Creates a PO line Cancel transaction if a PO has not had any Receiving/Vouchering/Matching activity, close days value has elapsed, and the **Close Short** flag is selected for the purchase order line.

The system can also call the Close Short process from the Receipt Push process that is submitted when you save the receipt. This occurs only if the RUN_CLOSE_SHORT check box is selected in the receipt header. To process the purchase orders, the system:

1. Processes only those purchase orders that are referenced in the current receipt.
2. Creates a PO Change order transaction, to set the purchase order schedule quantity equal to the total receipt quantity for the purchase order schedule, when the **Close Short** flag is selected on the corresponding Purchase Order line and the close short set option for the schedule is *Received Quantity/Amount* by default.
3. Does no further processing.

Generally, all other purchase order lines that are not referenced on the current receipt are automatically processed the next time the Close Short process is triggered from the Run Control page for the relevant purchase order business unit.

Note: The system uses the PO Change batch process to apply the quantity change and to cancel transactions for the purchase order.

The PO batch Change allows the PO value to be less than the received value if the change request source is PO Close Short. This would not include a value of zero or a cancel request for the line / schedule.

Create PO Close Short Default Rules Page

The PO Close Short Rules is defined by a Purchasing Rule ID. The Purchasing Rule ID can be assigned to one or more business units.

Rule	Amount Only Indicator	Receiving Option	Match Line Option	How PO Value Will Be Set During Close Short Processing (Close Short Set Option)
1	No	Receiving Required	Full Match	RQ) Sum of Receipt Quantity * MQ) Matched Quantity RMGQ) Greater value of Matched Quantity or the Sum of Receipt Quantity NA) Disable
2	Yes	Receiving Required	Full Match	RA) Sum of Receipt Amount * MA) Matched Amount RMGA) Greater value of Matched Amount or Sum of Receipt Amount NA) Disable
3	No	Receiving Required	ERS	MQ) Matched Quantity VQ) Sum of Vouchered Quantity RMGQ) Greater value of Matched Quantity or the Sum of Receipt Quantity RVGQ) Greater value of the Sum of Vouchered Quantity or the Sum of Receipt Quantity NA) Disable
4	Yes	Receiving Required	ERS	RA) Sum of Receipt Amount * MA) Matched Amount VA) Sum of Vouchered Amount RMGA) Greater value of Matched Amount or Sum of Receipt Amount RVGA) Greater value of the Sum of Vouchered Amount or the Sum of Receipt Amount NA) Disable

Rule	Amount Only Indicator	Receiving Option	Match Line Option	How PO Value Will Be Set During Close Short Processing (Close Short Set Option)
1	No	Receiving Required	Full Match	RQ) Sum of Receipt Quantity * MQ) Matched Quantity RMGQ) Greater value of Matched Quantity or the Sum of Receipt Quantity NA) Disable
5	No	Receiving Required	No Match	RQ) Sum of Receipt Quantity * VQ) Sum of Vouchered Quantity RVGQ) Greater value of the Sum of Vouchered Quantity or the Sum of Receipt Quantity NA) Disable
6	Yes	Receiving Required	No Match	RA) Sum of Receipt Amount * VA) Sum of Vouchered Amount RVGA) Greater value of the Sum of Vouchered Amount or the Sum of Receipt Amount NA) Disable
7	No	Receiving is Optional	Full Match	RQ) Sum of Receipt Quantity MQ) Matched Quantity * RMGQ) Greater value of Matched Quantity or the Sum of Receipt Quantity NA) Disable
8	Yes	Receiving is Optional	Full Match	RA) Sum of Receipt Amount MA) Matched Amount * RMGA) Greater value of Matched Amount or Sum of Receipt Amount NA) Disable

Rule	Amount Only Indicator	Receiving Option	Match Line Option	How PO Value Will Be Set During Close Short Processing (Close Short Set Option)
1	No	Receiving Required	Full Match	RQ) Sum of Receipt Quantity * MQ) Matched Quantity RMGQ) Greater value of Matched Quantity or the Sum of Receipt Quantity NA) Disable
9	No	Receiving is Optional	ERS	RQ) Sum of Receipt Quantity * MQ) Matched Quantity VQ) Sum of Vouchered Quantity RMGQ) Greater value of matched Quantity or the Sum of Receipt Quantity RVGQ) Greater value of the Sum of Vouchered Quantity or the Sum of Receipt Quantity NA) Disable
10	Yes	Receiving is Optional	ERS	RA) Sum of Receipt Amount * MA) Matched Amount VA) Sum of Vouchered Amount RMGA) Greater value of Matched Amount or Sum of Receipt Amount RVGA) Greater value of the Sum of Vouchered Amount or the Sum of Receipt Amount NA) Disable
11	No	Receiving is Optional	No Match	RQ) Sum of Receipt Quantity* VQ) Sum of Vouchered Quantity RVGQ) Greater value of the Sum of Vouchered Quantity or the Sum of Receipt Quantity NA) Disable

Rule	Amount Only Indicator	Receiving Option	Match Line Option	How PO Value Will Be Set During Close Short Processing (Close Short Set Option)
1	No	Receiving Required	Full Match	RQ) Sum of Receipt Quantity * MQ) Matched Quantity RMGQ) Greater value of Matched Quantity or the Sum of Receipt Quantity NA) Disable
12	Yes	Receiving is Optional	No Match	RA) Sum of Receipt Amount * VA) Sum of Vouchered Amount RVGA) Greater value of the Sum of Vouchered Amount or the Sum of Receipt Amount NA) Disable
13	No	Do Not Receive	Full Match	MQ) Matched Quantity * NA) Disable
14	Yes	Do Not Receive	Full Match	MA) Matched Amount * NA) Disable
15	No	Do Not Receive	No Match	VQ) Sum of Vouchered Quantity * NA) Disable
16	Yes	Do Not Receive	No Match	VA) Sum of Vouchered Amount * NA) Disable
17	No	Do Not Receive	ERS	VQ) Sum of Vouchered Quantity NA) Disable *

Rule	Amount Only Indicator	Receiving Option	Match Line Option	How PO Value Will Be Set During Close Short Processing (Close Short Set Option)
1	No	Receiving Required	Full Match	RQ) Sum of Receipt Quantity * MQ) Matched Quantity RMGQ) Greater value of Matched Quantity or the Sum of Receipt Quantity NA) Disable
18	Yes	Do Not Receive	ERS	VA) Sum of Vouchered Amount NA) Disable *

Note: (*) indicates Predefined setting.

The **Close Short** check box for PO Line / Schedules will be deselected and disabled once the user disables a rule. This holds true for PO Add / Update as well as the PO Close Short WorkBench.

Use the PO Close Short Rules page for maintaining the PO Close Short Rules. When a new Purchasing Rule ID is added, the 18 rules will be inserted with the Predefined settings as shown in the previous table. The Close Short Set Option can also be modified according to a desired value.

Note: A STANDARD rule ID would be delivered, which would be used as a template for any new rules to be created.

The 18 rules would be copied from the STANDARD template except for the Close Short Set Option, which would be provided by default as shown in the above table.

This example illustrates the fields and controls on the PO Close Short Rules page. You can find definitions for the fields and controls later on this page.

PO Close Short Rules

PO Rule Type: PO Close Short

PO Rule ID: STANDARD

Description:

Reset Default Values

Receiving Required	Amount Only	Match Line Option	*Close Short Set Option
1 Required	<input type="checkbox"/>	ERS	Received Quantity
2 Required	<input type="checkbox"/>	Full Match	Received Quantity
3 Required	<input type="checkbox"/>	Don't Match	Received Quantity
4 Required	<input checked="" type="checkbox"/>	ERS	Received Amount
5 Required	<input checked="" type="checkbox"/>	Full Match	Received Amount
6 Required	<input checked="" type="checkbox"/>	Don't Match	Received Amount
7 Do Not	<input type="checkbox"/>	ERS	Disable
8 Do Not	<input type="checkbox"/>	Full Match	Matched Quantity
9 Do Not	<input type="checkbox"/>	Don't Match	Vouchered Quantity
10 Do Not	<input checked="" type="checkbox"/>	ERS	Disable
11 Do Not	<input checked="" type="checkbox"/>	Full Match	Matched Amount
12 Do Not	<input checked="" type="checkbox"/>	Don't Match	Vouchered Amount
13 Optional	<input type="checkbox"/>	ERS	Received Quantity
14 Optional	<input type="checkbox"/>	Full Match	Matched Quantity
15 Optional	<input type="checkbox"/>	Don't Match	Received Quantity
16 Optional	<input checked="" type="checkbox"/>	ERS	Received Amount
17 Optional	<input checked="" type="checkbox"/>	Full Match	Matched Amount
18 Optional	<input checked="" type="checkbox"/>	Don't Match	Received Amount

<i>Field or Control</i>	<i>Description</i>
Reset Default Values	On selecting Reset Default Values, the default values for the rule in the rules table appear by default.

Using the PO Close Short Workbench

Whenever you select the **Close Short** check box for a row, either by copying it from the PO or selecting it on the page, the following conditions must be checked:

- If the **Close Short Set** option is *Matched Amount* and the matched amount for the row is zero, but the received amount is greater than zero. This will create a cancel request for the PO schedule, and the

cancellation will fail because of receiving activity. The **Close Short Set** option should be changed for the row.

- If the **Close Short Set** option is *Matched Quantity* and the matched quantity for the row is zero, but the received quantity is greater than zero. The condition will create a cancel request for the PO schedule, and the cancellation will fail because of receiving activity. The **Close Short Set** option should be changed for the row.
- If the **Close Short Set** option is *Received Amount* and the received amount for the row is zero, but the matched amount is greater than zero. The condition will create a cancel request for the PO schedule and the cancellation will fail because of matching activity. The **Close Short Set** option should be changed for the row.
- If the **Close Short Set** option is *Received Amount* and the received amount for the row is less than the matched amount. The condition will create an invalid change request for the PO schedule and will fail. The **Close Short Set** option should be changed for the row.
- If the **Close Short Set** option is *Received Quantity* and the received quantity for the row is zero, but the matched quantity is greater than zero. The condition will create a cancel request for the PO schedule and the cancellation will fail because of matching activity. The **Close Short Set** option should be changed for the row.
- If the **Close Short Set** option is *Received Quantity* and the received quantity for the row is less than the matched quantity. The condition will create an invalid change request for the PO schedule and will fail. The **Close Short Set** option should be changed for the row.
- If the **Close Short Set** option is *Vouchered Amount* and the vouchered amount for the row is zero, but the received amount is greater than zero. The condition will create a cancel request for the PO schedule because of receiving activity. The **Close Short Set** option should be changed for the row.
- If the **Close Short Set** option is *Vouchered Quantity* and the vouchered quantity for the row is zero, but the received quantity is greater than zero. The condition will create a cancel request for the PO schedule, and the cancellation will fail because of receiving activity. The **Close Short Set** option should be changed for the row.

PO Close Short Workbench - Purchase Orders Page

Use the PO Close Short Workbench - Purchase Orders page (PO_CLOSE_SHORT_WB) to use the PO Close Short Workbench.

Navigation:

Purchasing > Purchase Orders > Manage Change Orders > PO Close Short Workbench

This example illustrates the fields and controls on the PO Close Short Workbench - Purchase Orders page. You can find definitions for the fields and controls later on this page.

The Close Short Workbench provides a way to review purchase orders and determine whether outstanding purchase order lines should be set to close short. Using PO Close Short Workbench, you can run both the PO_CLSSHORT AE process and the PO_POCHNG AE process so that the purchase order is updated to reflect the Close Short processing.

The workbench page is divided into two sections. The top portion enables you to define search criteria for locating the purchase order schedules. The lower portion is a grid of the returned rows from the search. Each returned row contains a combination of purchase order header, line, and schedule information for your review and analysis.

Field or Control	Description
Business Unit	Displays the business unit associated with the purchase orders.
Workbench ID	Displays the name assigned to this grouping of purchase orders.
Workbench ID	Displays an extended description of the workbench ID.

Search Criteria

You can define a single purchase order or a list of purchase orders that are eligible for closing short. Enter the search parameters and click the **Search** button to retrieve the purchase orders. The system issues an error message if you perform the search without entering search parameters. You can search for eligible purchase orders based on a variety of search criteria, such as activity dates, supplier ID, item ID, and buyers. The Receiving option, Match Line option, Amount Only check box, and Match Status helps you refine purchase order searching. The **Amount Only** check box appears on all the grid tabs. The value is retrieved from the PO line.

The number of returned rows from the search depends on the value in the **Close Short Max Rows** field on the Installation Options page. If search results exceed that field value, the system displays an error message. You will have to change or add search criteria to narrow the results. If the **Close Short Max**

Rows field value is zero, the system does not set a limit and displays the rows, 6 or 100 at a time, and enables you to navigate from group to group.

When you click the **Search** button, the system displays the results in the **PO Close Short Worklist** grid. Search results are appended to any existing rows in the worklist. The system also saves both the search results and search criteria.

After completing a search, click the **Expand** button in the Search Criteria section to view the search criteria used for the search.

Field or Control	Description
Clear all rows from the list	Click to delete all worklist rows. This triggers an automatic save.
Select Close Short All	Click to select the Close Short check box for all rows in the worklist.
Clear Close Short All	Click to deselect the Close Short check box for all rows in the worklist.
Process Monitor	Click to access the Process Monitor.

Details

Use the Details tab to view line and schedule information for selected purchase orders.

This example illustrates the fields and controls on the PO Close Short — Details tab. You can find definitions for the fields and controls later on this page.

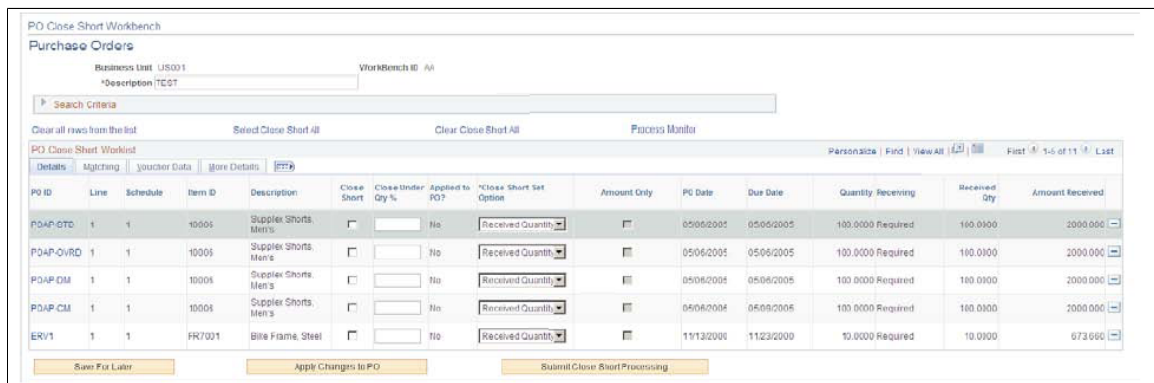

Field or Control	Description
PO ID (purchase order ID)	Click to view and update purchase order information.
Line	Displays the purchase order line number.

Field or Control	Description
Schedule	Displays the purchase order schedule number.
Item ID	Displays the item that is associated with the purchase order line number.
PO Date (purchase order date)	Displays the purchase order date. This value is retrieved from the purchase order header.
Due Date	Displays the schedule's due date.
Quantity	Displays the purchase order quantity from the purchase order schedule.
Receiving	Displays the line item receiving requirement indicator from the purchase order line. Values include <i>Required</i> , <i>Optional</i> , and <i>Do Not Receive</i> .
Received Qty (receiving quantity)	Displays the receipt quantity for the purchase order schedule. The system retrieves this value from the net receipt quantity for the receipt transactions. The system refreshes the quantity from the receipt transactions when you open an existing workbench or worklist.
Close Short	Indicates whether the Close Short check box on the purchase order line is selected. If you select or deselect the check box, the system applies the new value when you click the Apply Changes to PO button.
Close Under Qty % (close under quantity percentage)	Displays the close under percentage value from the purchase order schedule. You can enter a new value and click the Apply Changes to PO button to apply the change.
Applied to PO? (Applied to purchase order?)	Indicates whether changes have been made to the Close Short check box or the Close Under Qty % field and applied to the purchase order.

Field or Control	Description
Close Short Set Option	<p>The Close Short Set Option value will be provided by default on the PO Close Short Work List when the row is populated during search processing for the PO Close Short WorkBench. The PO line and schedule values for Amount Only flag, Receiving option, and Match Line option, along with the PO Close Short Rule ID of the PO business unit, will be used to find the PO Close Short Default Rule and retrieve the Close Short Set Option value.</p> <p>The close short set option would be set to either Received Quantity or Received Amount based on the Amount Only flag and grayed out irrespective of the close short rule; and the close short flag would be selected and grayed out if the PO line is stockless.</p> <hr/> <p>Note: If the close short set option is disabled for any of the PO schedule, then close short flag on all the rows listed for that particular PO line would be deselected and grayed out. If the close short override is not enabled on the PO Business unit, then the close short set option would be grayed out.</p> <hr/>
Amount Received	Displays the amount received for the PO schedule.
Save for Later	Click to indicate that you want to save the changes that you made to the search criteria, the worklist, or the run control parameters for the Close Short process. The system stores the values for the specific workbench ID and you can retrieve them by opening the workbench.
Apply Changes to PO (apply changes to purchase order)	Click to apply close short or close under quantity percent changes that you have made to purchase order lines and schedules.
Submit Close Short Processing	Click to access the Process Request Options page, where you can submit a batch Close Short process. If you do not apply the changes that you made on this page, the system displays an error message when you click the Submit Close Short Processing button.

Matching

Use the Matching tab to view line and schedule information for selected purchase orders.

This example illustrates the fields and controls on the PO Close Short — Matching Tabs. You can find definitions for the fields and controls later on this page.

PO ID	Line	Schedule	Item ID	Description	Close Short	Close Under Qty %	Applied to PO?	*Close Short Set Option	Amount Only	Merchandise Amount	Matching	Match Status	Amt Matched	Quantity Matched
POAP-STD	1	1	10005	Supplier Shorts, Men's	<input type="checkbox"/>		No	Received Quantity	<input type="checkbox"/>	2000.000	Full Match	Matched	2010.000	100.0000
POAP-OVRD	1	1	10005	Supplier Shorts, Men's	<input type="checkbox"/>		No	Received Quantity	<input type="checkbox"/>	2000.000	Full Match	Matched	2200.000	100.0000
POAP-CM	1	1	10005	Supplier Shorts, Men's	<input type="checkbox"/>		No	Received Quantity	<input type="checkbox"/>	2000.000	Full Match	Matched	2000.000	100.0000
POAP-CM	1	1	10005	Supplier Shorts, Men's	<input type="checkbox"/>		No	Received Quantity	<input type="checkbox"/>	2000.000	Full Match	Matched	2300.000	100.0000
ERY1	1	1	FR7001	Bike Frame, Steel	<input type="checkbox"/>		No	Received Quantity	<input type="checkbox"/>	673.659	Full Match	Matched	673.659	10.0000

Voucher Data

Use the Voucher Data tab to view line and schedule information for selected purchase orders.

This example illustrates the fields and controls on the PO Close Short — Voucher Tabs. You can find definitions for the fields and controls later on this page.

PO ID	Line	Schedule	Item ID	Description	Close Short	Close Under Qty %	Applied to PO?	*Close Short Set Option	Amount Only	Voucher Amount	Quantity Vouchered	Latest Voucher Date
POAP-STD	1	1	10005	Supplier Shorts, Men's	<input type="checkbox"/>		No	Received Quantity	<input type="checkbox"/>	2010.000	100.0000	05/09/2005
POAP-OVRD	1	1	10005	Supplier Shorts, Men's	<input type="checkbox"/>		No	Received Quantity	<input type="checkbox"/>	2200.000	100.0000	05/09/2005
POAP-CM	1	1	10005	Supplier Shorts, Men's	<input type="checkbox"/>		No	Received Quantity	<input type="checkbox"/>	2000.000	200.0000	05/09/2005
POAP-CM	1	1	10005	Supplier Shorts, Men's	<input type="checkbox"/>		No	Received Quantity	<input type="checkbox"/>	2300.000	100.0000	05/09/2005
ERY1	1	1	FR7001	Bike Frame, Steel	<input type="checkbox"/>		No	Received Quantity	<input type="checkbox"/>	1127.480	20.0000	11/15/2000

The **Amount Vouchered**, **Quantity Vouchered**, and **Latest Voucher Date** fields will only appear on the Voucher Data tab if the Close Short Set Option is using a Voucher value.

More Details

Use the More Details tab to view additional purchase order details.

Field or Control	Description
Buyer	Displays the buyer from the purchase order header.
Supplier ID	Displays the supplier for the purchase orders.
Contract ID	Displays the ID of the contract assigned to the purchase order schedule.

Field or Control	Description
GPO ID (group purchase order ID)	Displays the ID of the group purchase order assigned to the purchase order schedule.
Last Activity	Displays the date on which the last activity was performed against the purchase order. The system updates this date on the purchase order when you create a change order and save your work, and also when you cancel a purchase order through the Buyer's Workbench.

Process Request Options Page

Use the Process Request Options page (PO_CLS_SHORT_PRCs) to define Close Short process request options.

Navigation:

Click the **Submit Close Short Processing** button on the PO Close Short Workbench - Purchase Orders page.

You must either have specific authority or belong to the permission list to run this job. After you enter the required information, click the **OK** button. The system submits the Close Short Job to the process scheduler. The Close Short Job consists of the PO Close Short process and the PO Change Order process.

Field or Control	Description
Business Unit	Displays the business unit in which the purchase orders reside.
Close Days	Enter the number of days that a entire purchase order can remain open without receipt activity when the Close Short check box has been selected for the line. The system cancels those purchase order lines that exceed the close days value.
Server Name	Select a server on which to run the process.
Run Control ID	Select a run control ID.
Output Dest Type (output destination type)	Select the type of output in which you want to produce the job.
Output Dest Format (output destination format)	Select the output format in which you want to produce the job.

Reviewing and Approving Change Order Requests

This section provides an overview of the change request tables.

Pages Used to Review and Approve Change Order Requests

<i>Page Name</i>	<i>Definition Name</i>	<i>Usage</i>
<u>Approve Change Requests - Selection Criteria Page</u>	CHNG_RQST_SELECT	Enter the selection criteria for the change orders that you want to view on the Approve Change Requests page.
<u>Approve Change Requests Page</u>	CHNG_ORD_LOOKUP	Review and approve change header requests.
<u>Change Requests Page</u>	CHANGE_REQUEST	Review and approve line change requests.
Change Order Requester Detail Page	CHNG_RQST_REQUESTR	View information about the requester who entered the requisition change request that built this line.
Message Page	CHANGE_RQST_MSG	View change request error messages received during the Change Purchase Order process.
Purchase Order Inquiry - Purchase Order Page	PO_LINE_INQ	Review purchase order information such as the item, pricing, account code, Supplier name, and comments.

Understanding the Change Request Tables

The change request tables are used for background processing. To load data into these tables, use one of these business processes:

- EDX change order acknowledgments loaded by the Change Load process.
- Source requisitions to an existing purchase order.
- PeopleSoft Order Management direct-shipped order changes.
- PeopleSoft Manufacturing subcontract changes.
- PeopleSoft Supply Planning planned order changes.
- Par location replenishment
- Close Short process.

- PeopleSoft eProcurement change requests and change orders.
- PeopleSoft eSupplier Connection online POA changes loaded by the Change Load process.

The Change Request is divided into two tables:

- Change Request.

The key fields on the Change Request table are **Process Instance**, **Business Unit**, **Purchase Order ID**, **Change Source**, and **Date/Time**.

- Change Request Detail.

This is a child to the Change Request table and contains additional key fields such as **Line Number**, **Schedule Number**, and **Field** name that are to be changed.

Related Links

“Replenishing Par Locations” (PeopleSoft Inventory)

“PeopleSoft SCM Inbound EIPs” (PeopleSoft Supply Chain Management Integration)

[Updating Direct Shipment Information](#)

“Understanding Requisition Changes and Change Requests” (PeopleSoft eProcurement)

Approve Change Requests - Selection Criteria Page

Use the Approve Change Requests - Selection Criteria page (CHNG_RQST_SELECT) to enter the selection criteria for the change orders that you want to view on the Approve Change Requests page.

Navigation:

Purchasing > Purchase Orders > Manage Change Orders > Approve Change Requests

<i>Field or Control</i>	<i>Description</i>
Name	Enter the Supplier name for the Supplier for whom you want to view change order requests.
Purchase Order Reference	Enter the reference text entered on the purchase order for the change requests that you want to access.
Review Complete	Enter <i>Y</i> to access reviewed change requests. Enter <i>N</i> to access change requests that have not been reviewed.
PO Updated (purchase order updated)	Enter <i>Y</i> to access change requests that have been updated by the Change Purchase Order process. Enter <i>N</i> to access change requests that have not been updated.

Field or Control	Description
Change Order Source	Select the source transaction on which to base the search for purchase order change order approvals. Sources include: <i>BPA</i> : Contract Release to Single PO <i>CRT</i> : PAR Replenish/Close Backorders <i>DRP</i> : Order Management Referenced <i>EDX</i> : PO Acknowledgments <i>EPO</i> : eProcurement Change Request <i>EPR</i> : User Change Request <i>IMC</i> Inventory Mass Change <i>ONL</i> : On-line Purchase Order <i>PLN</i> : Planning System <i>PMC</i> : PO Buyer Mass Change <i>POC</i> : PO Change Batch Process <i>PRD</i> : Production/Shop Floor
Requisition ID From	Select a requisition ID or the beginning of a range of requisitions for which you want to manage the approvals. This field is available when you select <i>EPO</i> (eProcurement Change Request) in the Change Order Source field.
Requisition ID To	Select the last requisition within a range of requisitions for which you want to manage approvals.

Approve Change Requests Page

Use the Approve Change Requests page (CHNG_ORD_LOOKUP) to review and approve change header requests.

Navigation:

Click the **OK** button on the Selection Criteria page.

This example illustrates the fields and controls on the Approve Change Requests page. You can find definitions for the fields and controls later on this page.

Approve Change Requests

Approve Change Requests Personalize | Find | View All | | First 1-5 of 5 Last

Change Header		Change Reason							
Sel	Business Unit	PO ID	Approval Status	Change Order	Change Order Source	Date/Time	Reviewed	Reviewed On	Modified By
<input checked="" type="checkbox"/>	US001	0000000049	Approved	0	Direct Shp	04/24/2003 1:33:55PM	<input type="checkbox"/>		
<input type="checkbox"/>	US001	0000000057	Not Approved	0	User	08/19/2003 11:27:53AM	<input type="checkbox"/>		
<input type="checkbox"/>	US001	0000000204	Not Approved	0	ePro	06/22/2009 11:54:50AM	<input checked="" type="checkbox"/>	06/22/2009	MGEE
<input type="checkbox"/>	US001	0000000204	Not Approved	0	ePro	06/22/2009 11:54:50AM	<input checked="" type="checkbox"/>	06/22/2009	MGEE
<input type="checkbox"/>	US001	0000000265	Not Approved	0	ePro	01/12/2013 4:41:17AM	<input type="checkbox"/>		VP1

Search
[Show Detail Entry](#)
[Purchase Order Inquiry](#)

You can use this page and the Change Request page to manage approvals for change requests. Values you select on this page

Change Header

Select the Change Header tab.

Field or Control	Description
Approval Status	<p>Select the status you want to assign to the change order. Statuses include <i>Approved</i>, <i>Initial</i>, and <i>Denied</i>. If you select <i>Denied</i>, the system sets all of the unprocessed change request lines for this header to the Denied status. You can change the status until the change transaction has been processed by purchase order batch or deny change processing. If the change header is set to Approved, then all lines for the header with an approval status of Initial will be set to Approved. When you select to approve the request, the Change Purchase Order process can process the line.</p> <p>When <i>Denied</i> status is selected approver will encounter a message asking them to confirm denying the change request. On clicking <i>Yes</i> another message is displayed asking if the approver wants to revert the change back to the earlier value. Approver can select one of the given options:</p> <ul style="list-style-type: none"> • Select <i>Yes</i> to revert the changes back to the previous value. • Select <i>No</i> to retain the change, which will cause a new PO to be created for the difference between the previous value and the denied value. • Select <i>Cancel</i> to revert the approval status back to the previous approval status i.e. <i>Not Approved</i>. <hr/> <p>Note: If the change request is created from online POAs or EDX, the Change Load process checks the Auto Approve Buyer Accepted Online POAs check box for business unit options. If it is selected, the change request is created and automatically set as approved.</p>
Change Order	Displays the change order number. A change order is when you update a purchase order that has been dispatched.
Change Order Source	Displays the change order source for which a change order was submitted.
Date/Time	The date and time when the change request was created in the change request tables.
Reviewed	Select after reviewing the change request. The system populates the Reviewed On field with the current system date when you save the page.

Field or Control	Description
Modified By	Identifies the user who reviewed or approved the change request. The system updates this field when the page changes.
POA (purchase order acknowledgement)	Click this link to access the Manage PO Acknowledgements page. This value appears when purchase order acknowledgement exists for the purchase order.

Change Reason

Select the Change Reason tab.

Field or Control	Description
Reason Code	Displays the reason code used to make the purchase order change order.
Comment	Displays comments that were added when the reason code was used to justify the change request.

Related Links

[Creating Change Orders from Approved Change Requests](#)

[Defining Change Order and Sequence Numbers](#)

Change Requests Page

Use the Change Requests page (CHANGE_REQUEST) to review and approve line change requests.

Navigation:

Click the **Show Detail Entry** link on the Approve Change Requests page.

This example illustrates the fields and controls on the Change Requests Page. You can find definitions for the fields and controls later on this page.

Change Requests

Business Unit US001 PO ID 0000000049 Change Order 0

Change Details Personalize | Find | | First

Change Values	Requisition Details	Error Messages and Warnings						
Line	Sched Num	Approval Status	Change Type	Process Status	Proposed Change	Current Value	Adjust Type	Change Value
1	1	Approved	Change	Initialize	Due Date	2003-04-23	Replace	2003-04-23
1	1	Approved	Change	Initialize	Purchase Order Quantity	100	Replace	200

Approve All
Unapprove All
Deny All

This page displays all change requests for a purchase order with the same source and change time.

Change Values

Select the Change Values tab.

You can also use this tab to approve or deny the approval of all or individual change requests.

Field or Control	Description
Sched Num (schedule number)	Displays the schedule number for this row.
Approval Status	Select a status that you want to assign to the change request. The Approval Status is available until the change transaction has been processed. After you approve the change order, the Change Purchase Order process can process the line.
Change Type	Displays the kind of change made to the purchase order. Valid field values include <i>Changed</i> , <i>Inserted</i> , and <i>Cancelled</i> .
Process Status	<p>Displays the change request line status for the Purchase Order Change process. Values are:</p> <p><i>Initialize</i>: The change request has not been processed.</p> <p><i>Complete</i>: The change request has been processed successfully.</p> <p><i>Errors</i>: The change request has been processed, but errors were found.</p> <p><i>In Process</i>: The change request is being processed.</p> <p><i>Recycle</i>: When the status is <i>Error</i>, the user can change it to <i>Recycle</i> and rerun the process.</p>

Field or Control	Description
Proposed Change	Displays the description of the field affected by the change request.
Current Value	Displays the current value field on the purchase order.
New Value	Displays the value of the proposed field change.
Approve All	Select to mark all change requests as approved. Their status is updated to Approved.
Unapprove All	Select to change the approval status of all Approved change request to the Initial status.
Deny All	Select to set all rows that have not been processed to an approval status of Denied. When you select to deny the purchase order change, the page is refreshed and you can enter the denial reasons.

Requisition Details

Select the Requisition Details tab.

When the purchase order is associated to a requisition, this tab provides the requisition ID, line, schedule, and requester. Click the **Requester** link to access the Change Order Requester Detail page. This page provides information about the purchase order requester.

Error Messages and Warnings

Select the Error Messages and Warnings tab.

Field or Control	Description
Message Set Number and Message Number	Displays any error messages received during the Change Purchase Order process.
Messages	Click to access the Message page, where you can view change request error messages. The system displays a <i>No Message</i> value when there are no error messages for the change request.

Deny Reason(s)

Select the Deny Reason(s) tab.

When the page initially appears, and contains requests that require deny reasons, the cursor is positioned on the **Reason Code** field for the first row that needs a deny reason. The **Copy Previous Reason** check box is selected as the default value for all rows after the first row that were set to *Denied* as part of the Deny All processing.

If the change header is set to a Denied status, the system also sets all lines for the header with a change process status of Initialize, Error, or Recycle to the Denied status.

For each detail row with an approval status of Denied and when the source is EPO, the system sends a notification to the requester of the corresponding requisition. To set up the notification:

- Establish the notification (EOEN Interface) instance.
- Set the EOEN business unit properties.
- Create the EOEN context record (CHNG_EWN_CTX).

This record contains the requisition ID, line, and schedule, the purchase order ID, line, and schedule, buyer name, requester ID, and message description.

- Create the email or worklist entries for the notification.
- Set up a URL for the message.
- Insert a row into the REQ_CHNG_REASON table for each unique deny reason and reason description combination.
- Update the REASON_SEQ field on the PV_CHNG_RST_DTL record that is associated with the purchase order change detail (CHNG_RQST_DTL) to map to the new REQ_CHNG_REASON that contains the deny reason.

Field or Control	Description
Reason Code	The reason code field is available when the change request is in a Denied approval status. Select a reason code for denying the request. When you click the OK button for the page, for each row where the Copy Previous Reason check box is selected, the system copies the reason code and description from the previous row.
Copy Previous Reason	Select to indicate that you want to use the reason code defined for the previous row.
Description	Displays the description for the reason code. You can also enter more information in the field.
Copy Previous Reason Check Box	This section provides the Select All and Clear All links. You use the links to apply or remove the previous denial reason code for all selected change requests. The fields are made available when you select to the Deny All link and only apply to the Copy Previous Reason check box column.

Creating Change Orders from Approved Change Requests

This section discusses how to run the Change Purchase Order process.

The Change Purchase Order process creates change orders from approved change requests in the Change Request tables.

Page Used to Create Change Orders from Approved Change Requests

<i>Page Name</i>	<i>Definition Name</i>	<i>Usage</i>
<u>Change Purchase Orders Page</u>	RUN_PO_POCHNG	Select parameters for and run the Change Purchase Order process.

Change Purchase Orders Page

Use the Change Purchase Orders page (RUN_PO_POCHNG) to select parameters for and run the Change Purchase Order process.

Navigation:

Purchasing > Purchase Orders > Manage Change Orders > Process Change Orders

Chg Request Selection Criteria

<i>Field or Control</i>	<i>Description</i>
Source	<p>Select to identify a specific change request selection criteria. Values include:</p> <p><i>PAR Location Replenishment.</i></p> <p><i>EDX Change Order (From EDX or supplier-facing online acknowledgements).</i></p> <p><i>Order Management Direct Ship.</i></p> <p><i>PO Acknowledgments (purchase order acknowledgments).</i></p> <p><i>PO Buyer Mass Change</i></p> <p><i>Planning System.</i></p> <p><i>Production/Shop Floor.</i></p> <p><i>User Change Request.</i></p> <p><i>eProcurement Change Request</i></p>

Field or Control	Description
Business Unit and Business Unit To	Select to run the process for one or a range of business units.
PO ID (purchase order ID) and PO ID To (purchase order ID to)	Select to run this process for one or a range of purchase order IDs.

PO Update Options

Field or Control	Description
Override Dflt Buyer's PO Sts (override default buyer's purchase order status)	After a change order is created, the associated purchase order is usually set to the buyer's default purchase order status. Select this check box to override the default status with the purchase order status that you specify in the PO Status field if the current purchase order status is <i>D</i> (dispatched). Values are <i>Approved</i> , <i>Open</i> , and <i>Pending Approval</i> .

Field or Control	Description
Use Current UOM Conv Rate (use current unit of measure conversion rate)	Select to use the current UOM conversion rate. When this option is selected, the current conversion rate is used to calculate expected standard quantity. If you do not select this option, the system calculates the expected standard quantity using the purchase order conversion rate. Note: This option is available only when PeopleSoft Inventory is installed. If PeopleSoft Inventory is not installed, the current conversion rate is always used to calculate expected standard quantity.
PO Status (purchase order status)	Select a purchase order status that you want to use to override the default status. This field is available when you select the Override Dflt Buyer's PO Sts check box.

Purging Change Request Tables

This section provides an overview of the Purge Change Request process (PO_POCHGPRG) and discusses how to run the PO_POCHGPRG process.

Page Used to Purge Change Request Tables

<i>Page Name</i>	<i>Definition Name</i>	<i>Usage</i>
Purge Change Requests Page	RUN_PO_POCHGPRG	Select parameters for the PO_POCHGPRG process.

Understanding the Purge Change Request Process

The Purge Change Request process (PO_POCHGPRG) enables you to purge completed and error rows from these Change Request tables:

- PS_CHNG_RQST_DTL
- PS_CHNG_RQST
- PS_CHNG_RQST_MSGLG

Purge Change Requests Page

Use the Purge Change Requests page (RUN_PO_POCHGPRG) to select parameters for the PO_POCHGPRG process.

Navigation:

Purchasing > Purchase Orders > Manage Change Orders > Purge Change Requests

<i>Field or Control</i>	<i>Description</i>
Process Instance	Enter a process instance that you want to use to purge staged rows processed by that process instance of the Change Purchase Order process.

Viewing Purchase Order Change History

The PeopleSoft Purchasing system maintains a history of changes made to purchase orders. There are two ways to view purchase order changes to tracked fields that are identified in the purchase order change template. You can first view history by change order batch using the Review Change History menu. The second way is to view all tracked changes for a purchase order using the Review Change Order menu. The PO Change Order process updates purchase orders, but does not track change orders, if the purchase order has never been dispatched.

This section lists the pages that you use to view purchase order change history.

Pages Used to View Change Order History

Page Name	Definition Name	Usage
Review Change History - Batch Page	PO_CHANGE_BATCH	Review purchase order batch changes.
Review Change History - Header Changes Page	PO_CHANGE_HDR	Review change information about purchase order headers stored in the PO_CHNG_HDR table. Use the scroll area to view original values for values that have changed, as well as the changed values.
Review Change History - Line Changes Page	PO_CHANGE_LINE	Review change information about purchase order lines stored in the PO_CHNG_LINE table. Use the scroll area to view original values for values that have changed, as well as the changed values.
Review Change History - Ship Changes Page	PO_CHANGE_SHIP	Review change information about purchase order schedules stored in the PO_CHNG_SHIP table. Use the scroll area to view original values for values that have changed, as well as the changed values.
Review Change Orders - Header Changes Page	PO_CHANGE_HDR	Review change information about purchase order headers stored in the PO_CHNG_HDR table. Use the scroll area to view original values for values that have changed, as well as the changed values.
Review Change Orders - Line Changes Page	PO_CHANGE_LINE	Review change information about purchase order lines stored in the PO_CHNG_LINE table. Use the scroll area to view original values for values that have changed, as well as the changed values.
Review Change Order - Ship Changes Page	PO_CHANGE_SHIP	Review change information about purchase order schedules stored in the PO_CHNG_SHIP table. Use the scroll area to view original values for values that have changed, as well as the changed values.

Performing Mass Buyer Changes

PeopleSoft Purchasing provides a mass update method that enables you to make buyer changes for purchase orders in bulk rather than one purchase order at a time. For example, if a buyer leaves an organization, you can update that buyer's existing orders with a replacement buyer in one step, helping to prevent suppliers from losing touch with an organization's contact person when the organization makes personnel changes.

If the **Track Change** check box is selected for the **Buyer** field on a Purchasing change template, the system automatically creates change orders using the PO_POCHNG batch process. Mass changes to a buyer are also included in the change tracking history.

In addition, if the **Reapprove** check box is selected for the **Buyer** field on the change template, then the system initiates the Approval Framework workflow to route the change when the buyer is changed.

Note: The PO_POCHNG batch process does not reset the default values for the **Origin, Ship To ID, Department ID, and Location** fields when you make a change to the buyer.

Related Links

“Creating Change Templates” (PeopleSoft Source to Settle Common Information)

Pages Use to Perform Mass Buyer Changes

<i>Page Name</i>	<i>Object Name</i>
Buyer Mass Change (search)	PO_MASS_CHANGE
Buyer Mass Change	PO_MASS_CHANGE

Entering Buyer Search Criteria

Navigation:

Purchasing > Purchase Orders > Manage Change Orders > Buyer Mass Change

Use the Buyer Mass change page (PO_Mass_Change) to define a buyer and to replace one buyer with another. Also use it to provide criteria for the purchase orders that you want to change.

This example illustrates the fields and controls on the Buyer Mass Change page. You can find definitions for the fields and controls later on this page.

The screenshot shows the 'Buyer Mass Change' page. At the top, there are two input fields: '*Replace Buyer' and '*with Buyer', each with a magnifying glass icon. Below these is a 'Purchase Order Search Criteria' section containing:

- *Business Unit: US001 (with a magnifying glass icon)
- Supplier ID: (with a magnifying glass icon)
- As Of Date: (with a calendar icon)

 To the right of the search criteria is a 'PO Status Values' section with four checked checkboxes: Approved, Pending Approval, Dispatched, and Open. Below the search criteria is a 'Search' button.

Field or Control	Description
Replace Buyer	Select the original buyer that you want to replace in the purchase orders that match the search criteria you enter. The search results will include the purchase orders for this buyer and also those that match the remaining search criteria. This field is required.
with Buyer	Select the buyer that you want to replace the original buyer in the selected purchase orders. This field is required.

Use the **Purchase Order Search Criteria** group box to define the business unit, supplier, and effective date criteria for purchase orders. The **Business Unit** field is required.

You can also select which statuses you want to include in the search results. All of the status value check boxes are selected as default values.

When you click the **Search** button, the system displays the **Affect Purchase Orders** grid, which displays the results of the search. From those results, you can select the purchase orders to which you want to apply the buyer change.

Replacing a Buyer on Multiple Purchase Orders

Navigation:

Purchasing > Purchase Orders > Manage Change Orders > Buyer Mass Change Click the **Search** button.

This example illustrates the fields and controls on the Buyer Mass Change — Search Criteria page. You can find definitions for the fields and controls later on this page.

Purchase Order Search Criteria

*Business Unit

Supplier ID

As Of Date

PO Status Values

Approved Open

Pending Approval Initial

Dispatched

Affected Purchase Orders

Personalize | Find | View All |

Select For Change	Business Unit	PO ID	PO Date	Supplier ID	Supplier Name	Buyer Name	PO Status
<input type="checkbox"/>	US001	0000000089	10/16/2003	CAN0000002	ESCP-ENG-001	Chris Baker	Dispatched
<input type="checkbox"/>	US001	0000000058	08/12/2003	SCM0000001	BIKE-001	Chris Baker	Dispatched
<input type="checkbox"/>	US001	0000000037	01/08/2002	SCM0000001	BIKE-001	Chris Baker	Dispatched
<input type="checkbox"/>	US001	0000000127	06/10/2005	SCM0000002	CAMPER'S-001	Chris Baker	Dispatched
<input type="checkbox"/>	US001	0000000036	12/21/2001	SPN0000001	TEKA-INFO-001	Chris Baker	Dispatched
<input type="checkbox"/>	US001	0000000083	10/06/2003	USA0000026	LANDSCAPE-001	Chris Baker	Dispatched
<input type="checkbox"/>	US001	0000000081	10/06/2003	USA0000026	LANDSCAPE-001	Chris Baker	Dispatched
<input type="checkbox"/>	US001	0000000082	10/06/2003	USA0000037	ANDER-001	Chris Baker	Dispatched
<input type="checkbox"/>	US001	0000000080	10/06/2003	USA0000037	ANDER-001	Chris Baker	Dispatched
<input type="checkbox"/>	US001	0000000079	10/06/2003	USA0000037	ANDER-001	Chris Baker	Dispatched

Select/Deselect All

Selection Summary

You have selected to change Buyer CHRISBAKER to Buyer APA2 on 0 Purchase Orders. To complete this change, click the button below.

The **Affected Purchase Orders** grid displays the results of the search. You can select all the purchase orders or individual orders to which the buyer change applies. A link to the purchase order detail appears in the grid in the PO ID column. Click this link to open a new window that shows details about the selected purchase order.

The system also displays the **Selection Summary** group box, which indicates the original buyer, the replacement buyer, and the number of purchase orders selected for change. As you select purchase orders to change, the system updates the value in the message.

Click the **Process Change** button to initiate the PO_POCHNG batch application engine process. The system displays a message that a batch process is about to be initiated. You can either wait while the process runs, or you can manually check the process monitor for verification.

If you select to wait, the system indicates that the code is executing until the process is complete, after which the system displays a message indicating that the process is complete along with the process instance number. The system navigates to the Change Order History search page after the process is completed; from there, you can review and verify the purchase order changes.

Using the Buyer Workcenter and Dashboard

Understanding the Buyer WorkCenter and Dashboard

The Buyer WorkCenter and Dashboard is a central role-based navigational component that is designed for the end user. The goal of the WorkCenter is to help an end user become more efficient by accessing a variety of pages and information to perform daily tasks without navigating between different menus.

A WorkCenter can be configured to include the most frequently used internal menu items, external URLs, worklists, alert/warning notifications, queries, and reports. All WorkCenters are configurable at the system level and allow end-user personalization. Some system-defined entries include filters that the user can modify.

The Buyer WorkCenter is delivered as an empty shell. Your system administrator can setup the workcenter to reflect your user's needs. A Buyer Workcenter has been delivered as part of the sample data. Some links are related to workflow Worklists or alert/warning notifications, whereas others are associated with an Application Class. It is the responsibility of the system administrator from your organization to design and create links so that users can view and access specific information. When users click configured links in WorkCenter pagelets, the system renders information in a new window or in the transaction area. User access is controlled by user roles and permissions.

For information about setting up PeopleTools options for the WorkCenter, see *PeopleTools: Global Technology*.

The Buyer WorkCenter can include these primary tabs and pagelets:

- Main tab
 - My Work
 - Links
- Reports/Queries tab
 - Queries
 - Reports/Processes

Related Links

“Understanding PeopleSoft Classic WorkCenters and Dashboards” (Application Fundamentals)

“Understanding PeopleSoft Fluid WorkCenters” (Application Fundamentals)

Buyer WorkCenter Home Page

Use the Buyer WorkCenter Home page (PTPG_PGVIEWER) to manage requisitions, purchase orders, receipts, contracts, and related data.

Navigation:

Purchasing > Buyer WorkCenter

This example illustrates the fields and controls on a configured Buyer WorkCenter.

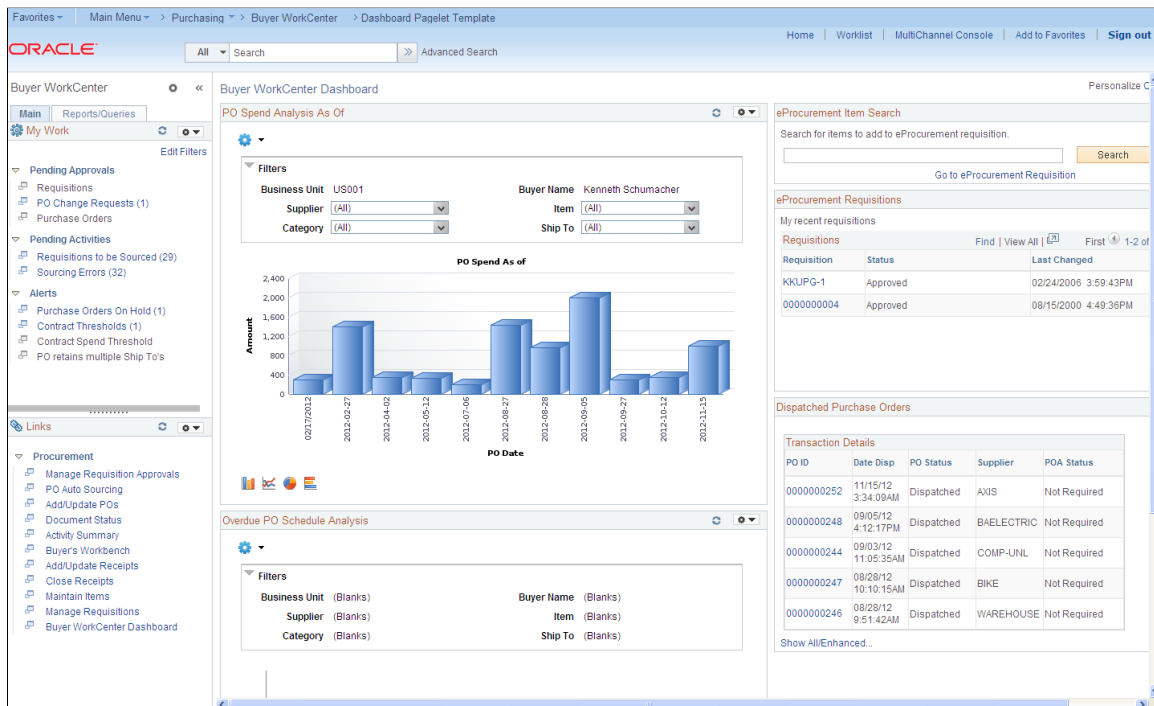

The WorkCenter pagelet area appears on the left side of the screen.

The Buyer WorkCenter Dashboard with summary information and charts appears on the right side of the screen. Transactional pages also display on the right side of the screen when a user clicks a pagelet link.

Field or Control	Description
	Click the New Window icon next to a link in the WorkCenter pagelet area to open transactional information in a window outside the WorkCenter and Dashboard. Alternately, click a link in the WorkCenter pagelet area to open transactional pages in the Dashboard frame.
Edit Filters	Click the Edit Filters link on the My Work pagelet to modify the filters on worklist links registered in the My Work pagelet.

For more information about the links that appear on the My Work pagelet, see [Using the BuyerWorkCenter - My Work](#).

For more information about the links that appear on the Links pagelet, see [Using the Buyer WorkCenter - Links](#).

For more information about the links that appear on the Queries and Reports/Processes pagelets, see [Using the Buyer WorkCenter - Queries, Reports, and Processes](#).

Related Links

“Understanding WorkCenters and Dashboards” (Enterprise Components)

“Configuring Pagelets” (Enterprise Components)

Understanding Dashboards and Pagelets

For more information about the pivot grids that you can add to the Buyer WorkCenter Dashboard, refer to the documentation for the SRM Dashboard and pagelets.

Related Links

“Viewing SRM Dashboard Pagelets” (PeopleSoft Source to Settle Common Information)

“Understanding PeopleSoft Classic WorkCenters and Dashboards” (Application Fundamentals)

“Understanding PeopleSoft Fluid WorkCenters” (Application Fundamentals)

Setting Up the Buyer WorkCenter Dashboard

Several buyer-facing and manager-facing pagelets are delivered with the Buyer WorkCenter Dashboard and can be accessed if PeopleSoft SRM applications are installed.

For a complete list of the cross-supply chain pagelets that you can add to the Buyer WorkCenter Dashboard, refer to the documentation for the SRM Dashboard and pagelets.

Related Links

“Understanding the SRM Dashboard” (PeopleSoft Source to Settle Common Information)

“Viewing SRM Dashboard Pagelets” (PeopleSoft Source to Settle Common Information)

“Defining Buyers” (PeopleSoft Source to Settle Common Information)

Using the BuyerWorkCenter - My Work

The My Work pagelet of the Buyer WorkCenter displays work items assigned to the user and, depending on setup, the number of transactions or items. After the user completes transactions, the user manually refreshes the pagelet to update the number of transactions or items shown in parentheses next to the My Work links.

Existing Worklist notifications as well as the Alert/Warning Notification processes can be registered into the My Work pagelet as the type of Worklist and Alert/Warning Notification, respectively.

Users can modify filters for several of these pagelet entries, however, some links in the My Work pagelet are Workflow entries. Workflow entries are displayed on the standard Worklist entry page.

The following table lists the worklists that can be registered into the My Work pagelet.

Existing Worklist	Drill to Details Page	Define Worklist Entry in My Work Pagelet Configuration¹
Contracts Expiry Threshold	Contract Entry	Contract Thresholds Contract Spend Threshold
Sourcing Events to Approve	Event Workbench	Approval Routing
Change Requests to Review	PO Change Request Approval	Change Request Approval
Late PO Acknowledgements	Manage POA	Overdue POAs
PO Acknowledgements (incoming from the supplier, need approval)	POA Approval	EDI PO Acknowledgement Online PO Acknowledgement Batch EDI PO Acknowledgement Batch Online PO Acknowledgement
Purchase Orders to Approve	PO Approval	Virtual Approvals (AWE): Approve Chartfields Worklist
		Approval Framework <ul style="list-style-type: none"> • Approval Error • Approval Escalation • Approval Hold • Approval Reassign • Approval Request Information • Approval Review Routing • Approval Routing
Requisitions to Approve	Requisition Approval	Virtual Approvals (AWE): Req Approval Worklist

Existing Worklist	Drill to Details Page	Define Worklist Entry in My Work Pagelet Configuration¹
		Approval Framework <ul style="list-style-type: none"> • Approval Error • Approval Escalation • Approval Hold • Approval Pushback • Approval Reassign • Approval Request Information • Approval Review Routing • Approval Routing

Note: ¹ Each Worklist Entry in the last column of this table appears as a separate link in the My Work pagelet.

The following table lists the events and notifications that can be registered into the My Work pagelet.

Notification Event	Process Name	Process Category
A claim associated with a vendor rebate agreement is generated	PO_VRBT_NOTIFY	NOTIFY_CLAIMS_MGR
A claim associated with a vendor rebate agreement is ready to be settled	PO_VRBT_NOTIFY	NOTIFY_SETTLEMENT_MGR
Inventory Manager notified of material awaiting return to Supplier*	PO_RTV_NOTIFY	NOTIFY_INV_MGR_ADJ NOTIFY_INV_MGR_ISSUE NOTIFY_INV_MGR_MSR
Change request from Requisition has been accepted or denied	PO_CHNG_NOTIFY	Notify requester of PO reject
Notify requestor that Requisition has been sourced to a PO	PO_QSRCD_NOTIFY	NOTIFY_REQUESTOR

The following table lists the system-defined Application Classes that can be registered into the My Work pagelet. All available Application Classes for the Buyer WorkCenter are defined in this root application package: SRM_PO_WORKCENTER_DASHBOARD. A user filter is available on the system-defined entries, as noted in the table.

Link Group and Link Text	Row Counts (in parenthesis)	Target/ Transaction Area	Alternate Navigation	Filtered By	My Work System Link ID - App Class Name
Alerts: Purchase Orders on Hold	Purchase Orders that are on hold	Purchase Orders On Hold page	None	Buyer, Business Unit	Purchase Orders On Hold - PO:POsOnHold
Pending Approvals: PO Change Requests	Purchase Order Change Requests pending approval	Approve Change Requests page	Purchasing > Purchase Orders > Manage Change Orders > Approve Change Requests	Buyer, Business Unit	PO Change Requests - PO:PoChgToApprove
Pending Approvals: Purchase Orders	Purchase Orders that are pending Approval Framework Approval activity	Approve Purchase Orders page	Purchasing > Purchase Orders > Approve POs > Approve Purchase Orders	Buyer, Business Unit	PO-PO:PoToApprove
Pending Approvals: Requisitions	Requisitions that are pending Approval Framework approval activity	Manage Requisition Approvals page	Purchasing > Purchase Orders > Manage Requisition Approvals > Manage Requisition Approvals	Business Unit, User ID, Approval Status	Requisitions - PO:ReqToApprove
Pending Activities: Requisitions to be Sourced	Requisition lines that are in Approved status; filtered by the user specified criteria values	Requisition Selection - Sourcing page	Purchasing > Purchase Orders > Stage/Source Requests > Requisition Selection > Requisition Selection - Sourcing	Business Unit, Buyer	Requisitions to be Sourced - PO:ReqToSource
Pending Activities: Sourcing Errors	PO Staged rows that are in Error status; filtered by the user specified criteria values	Purchasing > Purchase Orders > Stage/Source Requests > Sourcing Workbench	Sourcing Errors list	Business Unit, Buyer, Stage Status	PO Sourcing Errors - PO:PoSourceErrors

The sample Buyer WorkCenter shows the My Work pagelet as it might appear to a user.

This example illustrates the My Work pagelet on a sample Buyer WorkCenter.

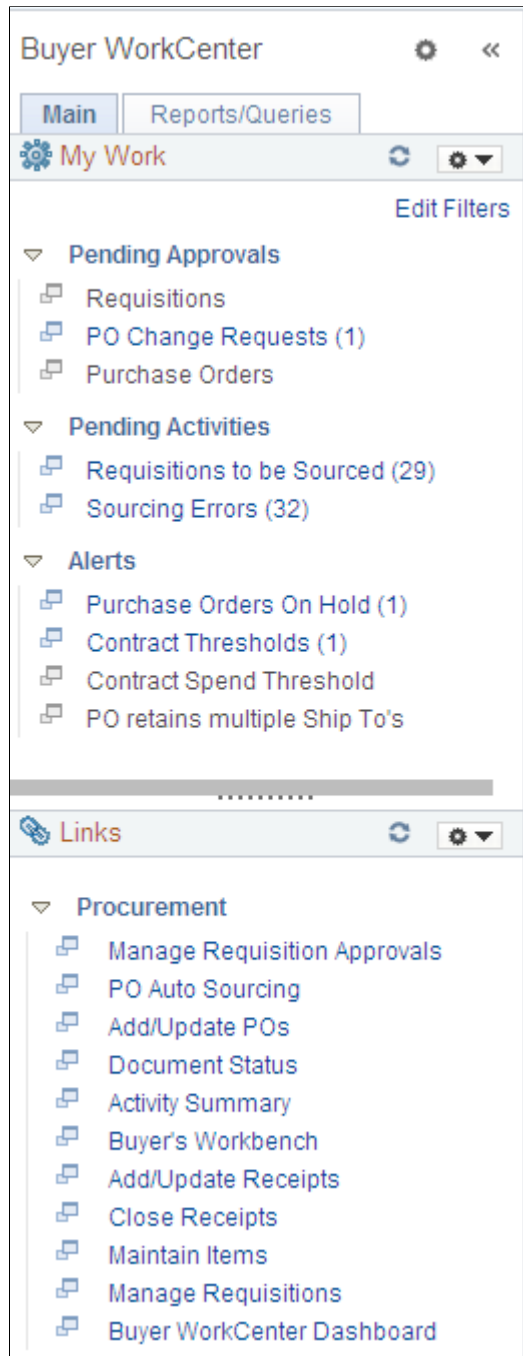

Edit Filters Page

Use the Edit Filters page (FSPC_MYWORK_FILTER) to modify filters on some worklist links registered in the My Work pagelet.

Navigation:

Click the **Edit Filters** link on the My Work pagelet.

This example illustrates the fields and controls on the Edit Filters page. You can find definitions for the fields and controls later on this page.

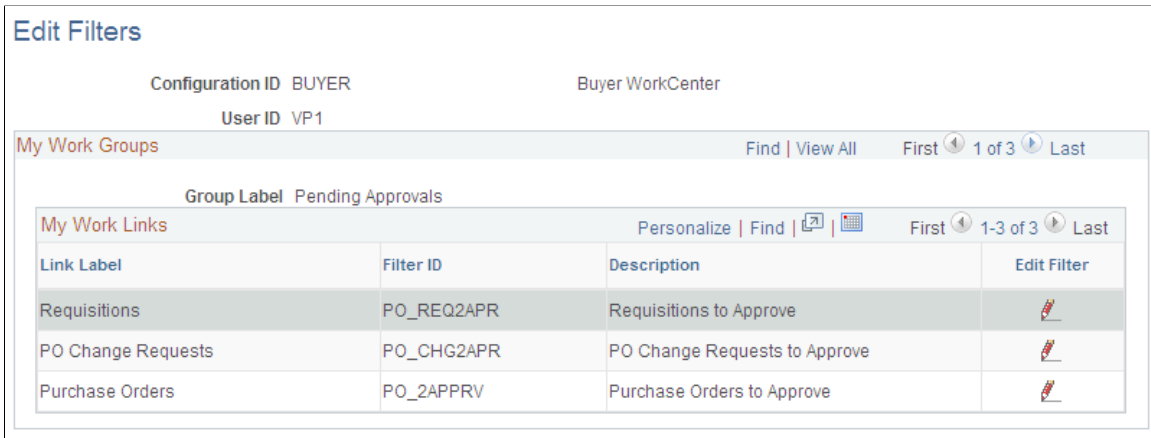

Field or Control	Description
	Click the Edit Filter icon to open the Configure Filter Values page, where you can modify the filter for the selected Filter ID.

On the Edit Filters page, click the Edit Filter icon of the filter you want to modify.

Note: Although the Configure Filter Values provided by PeopleTools uses the search parameter “in,” where you can provide a list of values like multiple Buyer IDs, the application components within SRM support only one value, so “=” must be used.

Purchase Orders on Hold Page

Use the Purchase Orders on Hold page (SRM_PO_WC_HDR) to display purchase orders on hold in a Buyer WorkCenter transaction list. An alternate navigation or existing component is not available; you must access this page through the Buyer WorkCenter.

Navigation:

Purchasing > Buyer WorkCenter > Main

Click the **Purchase Orders on Hold** link in the My Work pagelet.

This example illustrates the fields and controls on the Purchase Orders on Hold page.



Field or Control	Description
	Click the Refresh icon to reflect current transactions on hold.
Refine Filter Criteria	Click this link to open the Refine Search Criteria page, where you can select a different value for Buyer or Business Unit.
PO ID	Click the PO ID link to open the Maintain Purchase Order - Purchase Order page (PO_LINE), where you can edit the purchase order at the line level.

Using the Buyer WorkCenter - Links

Use the Links pagelet for registering and grouping the most frequently used navigational links. The configured Links pagelet can provide access to both internal menus and external URLs.

System administrators use the “Configuring Pagelets” (Enterprise Components) to set up the WorkCenter Links pagelet for end users.

End users use the “Working With and Personalizing the Classic Links Pagelet As an End User” (Application Fundamentals) to personalize the Links pagelet for personal use.

Sample Buyer WorkCenter - Add/Update POs Link

This example demonstrates the functionality on the Links pagelet. Use the Links pagelet to access frequently used links.

This example illustrates the Link pagelet on a sample Buyer WorkCenter.

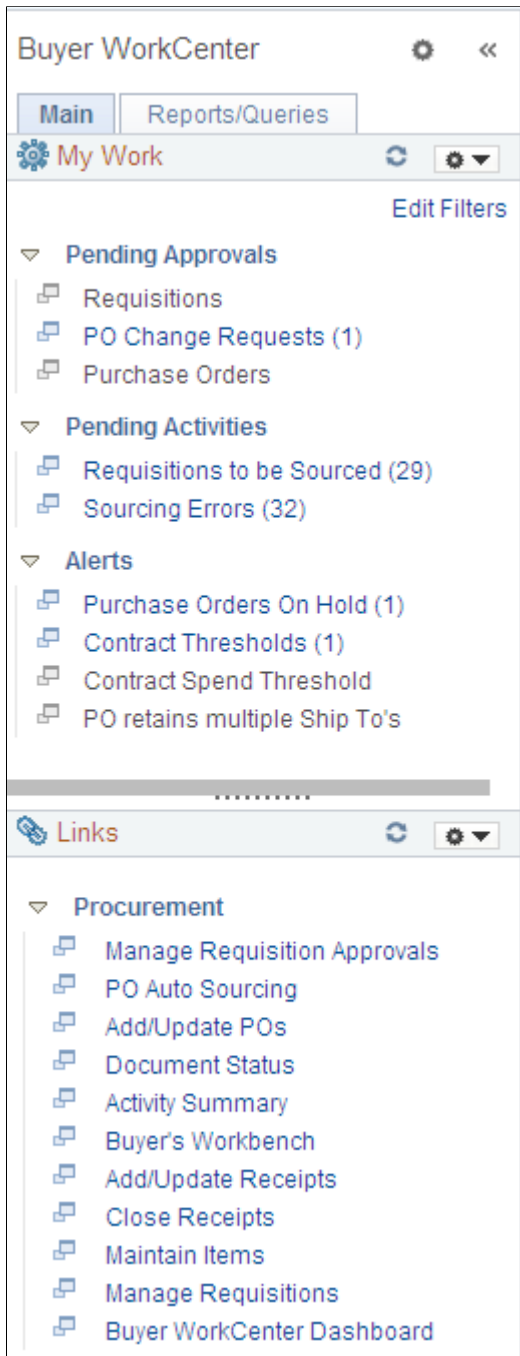

Click the Add/Update POs link in the Links pagelet to display the Purchase Order search page in the transaction area, where you can add a new purchase order or search for an existing purchase order. Click the New Window icon to the left of the link to open the same page in a new window.

Navigation:

- **Purchasing > Buyer WorkCenter > Main**

Click the **Add/Update POs** link in the Links pagelet.

- **Purchasing > Purchase Orders > Add/Update POs > Maintain Purchase Order**

See the documentation for [Creating Purchase Order Headers](#) and [Creating Purchase Order Lines](#).

Using the Buyer WorkCenter - Queries, Reports, and Processes

The Buyer WorkCenter provides the Queries and Reports/Processes pagelets for registering and grouping the most frequently used queries, reports, and processes. The Queries pagelet can provide access to public queries, private queries, and pivot grids.

System administrators use the “Configuring Pagelets” (Enterprise Components) to set up the WorkCenter Queries pagelet for end users.

End users use the “Working With and Personalizing the Classic Queries Pagelet As an End User” (Application Fundamentals) to personalize the Queries pagelet for personal use.

Sample Buyer WorkCenter - Past Due Receipts Query

This example demonstrates the functionality on the Queries pagelet. Use the Queries pagelet to access frequently used queries.

This example illustrates the Queries pagelet on a sample Buyer WorkCenter.

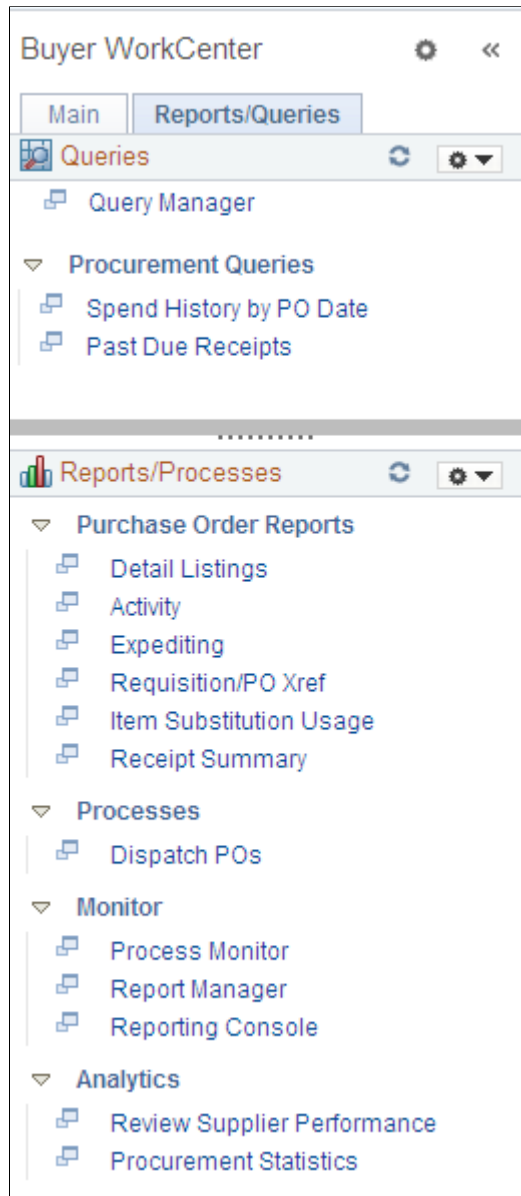

Use the Past Due Receipts link in the Queries pagelet to run the Past Due Receipts query (PO_LATE_RECEIPTS) and display the results in the transaction area.

Click the New Window icon to the left of the link to run the query and open the results in a new window.

Navigation:

Purchasing > Buyer WorkCenter > Reports/Queries

Click the **Past Due Receipts** link in the Queries pagelet.

This example illustrates sample query results from the Buyer WorkCenter.

PO_LATE_RECEIPTS- Past Due Receipts							
Download results in : Excel Spreadsheet CSV Text File XML File (2 kb)							
View All							First 1-14 of 14 Last
	Unit	Recv Nbr	EIP ID	Recv Date	Receipt Line	PO Unit	Due
1	GBR01	000000003		04/07/2006	1	GBR01	03/30/2006
2	US001	000000033		04/07/2006	1	US001	03/22/2006
3	US001	000000033		04/07/2006	2	US001	03/23/2006
4	US001	000000033		04/07/2006	3	US001	03/25/2006
5	US001	000000033		04/07/2006	4	US001	03/27/2006
6	US001	000000033		04/07/2006	5	US001	03/29/2006
7	US001	000000036		04/17/2006	1	US001	04/13/2006
8	US001	000000036		04/17/2006	2	US001	04/13/2006
9	US001	000000036		04/17/2006	3	US001	04/13/2006
10	US001	000000037		04/18/2006	1	US001	04/06/2006
11	US001	000000037		04/18/2006	2	US001	04/06/2006
12	US001	000000037		04/18/2006	3	US001	04/06/2006
13	US001	000000037		04/18/2006	4	US001	04/06/2006
14	US001	000000037		04/18/2006	5	US001	04/06/2006

Results can be downloaded to an Excel spreadsheet, CSV text file, or XML file.

Using the Buyer's Workbench

Understanding the Buyer's Workbench

Use the Buyer's Workbench to:

- Update a purchase order.
- Reset the approval status of a purchase order.
- Approve a purchase order.
- Dispatch a purchase order.
- Cancel a purchase order.
- Close a purchase order.
- View a purchase order draft.
- Inquire about a purchase order.
- Review purchase order summary activity.

You must have the authority to perform the particular activity that you select.

Access the Buyer's Workbench - Filter Options page before accessing the Buyer's Workbench. Use the Buyer's Workbench - Filter Options page to enter selection criteria for the purchase orders that you want to display on the Buyer's Workbench page. To save time and resources, enter some selection criteria to reduce the number of records retrieved, especially in a high-volume environment.

Related Links

[Creating Purchase Order Lines](#)

[Creating Purchase Order Schedules](#)

[Creating Purchase Order Distributions](#)

“User Preferences – Purchase Order User Authorizations Page” (Application Fundamentals)

Managing Purchase Orders Using the Buyer's Workbench

This section discusses how to Manage Purchase Orders Using the Buyer's Workbench.

Pages Used to Manage Purchase Orders Using the Buyer's Workbench

Page Name	Definition Name	Usage
<u>Buyer's Workbench - Filter Options Page</u>	PO_RC_WB_SRCH	Select attributes to search for purchase orders.
<u>Buyer's Workbench Page</u>	PO_RC_WB	Analyze, approve, dispatch, unapprove, cancel, close, and print preview purchase orders.
Document Status Inquiry Page	PRCR_DOCSTAT_INQ	View the document status.
<u>Buyer's Workbench - Purchase Order Lines Page</u>	PO_RC_WB_LN	View or select the lines associated with the selected purchase order.
<u>Buyer's Workbench - Purchase Order Schedules Page</u>	PO_RC_WB_SCHD	View the schedules associated with the selected purchase order.
Buyer's Workbench - Purchase Order Distributions Page	PO_RC_WB_DISTRIB	View the distribution associated with the selected purchase order.
Buyer's Workbench - Purchase Order Receipts Page	PO_RC_WB_RECV	View receipts against the selected purchase order.
Maintain Distributions Page	PO_CF_DTLS	Maintain distributions associated with purchase order schedule.
Activity Summary Page	ACTIVITY_SUMMARY	View the activity summary for the Buyer's Workbench.
Maintain Purchase Orders - Purchase Order Page	PO_LINE	Maintain purchase orders.
<u>Buyer's Workbench - Processing Results Page</u>	PO_RC_WB_RSLT	Review the results after taking action on selected purchase orders.
Buyer's Workbench - Processing Log Page	PO_RC_WB_MSG	View the message text stating why the purchase order was not qualified for processing.

Buyer's Workbench - Filter Options Page

Use the Buyer's Workbench - Filter Options page (PO_RC_WB_SRCH) to select attributes to search for purchase orders.

Navigation:

Purchasing > Purchase Orders > Buyer's Workbench > Buyer's Workbench - Filter Options

This example illustrates the fields and controls on the Buyer's Workbench - Filter Options page. You can find definitions for the fields and controls later on this page.

The screenshot displays the 'Buyer's Workbench Filter Options' page. At the top, it shows 'Business Unit US003' and 'WorkBench ID 123'. Below this is a 'Description' section with a search instruction: 'Enter search criteria and click on Search. Leave blank for all values.' The 'Search Criteria' section contains various input fields with search icons: Purchase Order, PO Date, Activity Date, Due Date, Request BU, Supplier ID, Item ID, Buyer, Contract SetID, Contract ID, Release Number, GPO ID, and GPO Contract. There are also 'To' fields for PO Date, Activity Date, Due Date, and Requisition ID, and a 'Contract Version' field. The 'Status' section includes checkboxes for Open, Pending Appr for more than 9 days, Approved, Denied, Dispatched, Cancelled, and Include Closed. The 'Receiving' section has a 'Recv Req' dropdown set to 'Optional' and radio buttons for All, Not Received, Partially Received, and Fully Received. The 'Matching' section has checkboxes for Required, Not Required and radio buttons for All, None, Partial Match, and Fully Matched. The 'Encumbrance' section has a checkbox for Open Encumbrances. The 'ChartFields' section includes a 'Personalize' link, 'Find', 'View All', and navigation buttons (First, 1 of 1, Last). Below this is a table with columns: GL Unit, Account, Alt Acct, Oper Unit, Dept, Program, Class, Fund, and Bud Ref. At the bottom, there are 'Search', 'Return to Buyer's WorkBench', 'Notify', and 'Refresh' buttons.

Search Criteria

<i>Field or Control</i>	<i>Description</i>
Buyer	Select the buyer you want to filter the purchase orders by. If you select a buyer that has the rights to use procurement cards on a purchase order, the Card Number field becomes available.

<i>Field or Control</i>	<i>Description</i>
Contract SetID	Select a contract SetID. When you search based on a SetID, the system returns the purchase orders that are in the SetID.
Contract ID	Select a specific contact on which to search. If no purchase orders are associated with the contract, the list of values is empty.
Contract Version	Select a specific version of the contract on which to search.
Release Number	Select a contract release number to limit contract information. If the purchase order is tied to a contract, the contract release number is available.
GPO ID (group purchasing organization identification)	Select a group purchasing organization ID.
GPO Contract	Select a group purchasing organization contract number.
Card Number	Select the procurement card number you want to filter purchase orders by. You must select a buyer that has the rights to use procurement cards on a purchase order for card numbers to be available.

Status

<i>Field or Control</i>	<i>Description</i>
Include Closed	Select this check box to select purchase orders that are in a status of closed. The system clears this check box each time the page is accessed.

Field or Control	Description
Pending Appr	<p>Select this check box to select purchase orders that are in a status of pending approval. You can cancel purchase orders that are in a pending approved status.</p> <p>When you select the Pending Appr checkbox an additional field becomes visible, which allows filtering of POs based on number of days a PO is pending for Approval. Enter the number of days to select purchase orders pending for approval with an Approver greater than the number of days entered.</p> <hr/> <p>Note: The Pending Approval checkbox and No of day's field will be made available if AWE is enabled in Business unit option for the BU and the no of day's field will be available when AWE is enabled and the Pending approval is checked. If Accessibility mode is enabled, the no of days will always be made available irrespective of the pending approval selection.</p> <hr/>

Encumbrance

Field or Control	Description
Open Encumbrances	<p>If you are using commitment control, click the Open Encumbrances check box to search for purchase orders with open encumbrances.</p> <p>When you use commitment control, the system deducts each type of financial obligation from the budget and tracks it according to obligation type. When you generate a requisition, a pre-encumbrance is created in your budget records by the budget-checking process. When a requisition is sourced to a purchase order, commitment control liquidates the pre-encumbrance from the requisition and establishes an encumbrance for the purchase order.</p>

Receiving

Use this section to define search criteria related to purchase order receipts, such as whether you want to retrieve purchase orders where receiving is required or optional for the purchase order.

Matching

Use this section to define search criteria related to purchase order matching controls, such as whether matching is required or not required on the purchase order.

ChartFields

You can enter multiple ChartField combinations as search criteria. For example, you can search for purchase orders in **GL Unit** (PeopleSoft general ledger business unit) US001 and **Account** 50000, as well as US005 and Account 1200.

Click **Search**, and the system retrieves the selected information that matches the selection criteria and displays it on the Buyer's Workbench page.

Related Links

“Understanding PeopleSoft ChartFields” (Application Fundamentals)

Buyer's Workbench Page

Use the Buyer's Workbench page (PO_RC_WB) to analyze, approve, dispatch, unapprove, cancel, close, and print preview purchase orders.

Navigation:

Click the **Search** button on the Buyer's Workbench - Filter Options page.

This example illustrates the fields and controls on the Buyer's Workbench page. You can find definitions for the fields and controls later on this page.

The screenshot displays the Buyer's Workbench interface. At the top, it shows the Business Unit as US003 and WorkBench ID as 123. Below this, there is a search field for Description with the value DSFSDF. The main section is titled "Select POs for Further Processing" and contains a table of purchase orders. The table has columns for Purchase Order, Doc Status, Hold, PO Status, No of Days pending, and Last Notified on. A context menu is open over the third row, showing options for View Approval and Send Reminder. Below the table, there are buttons for Select All, Clear All, and a row of action buttons: Approve, Unapprove, Cancel, Close, and Send Approval Remindr. At the bottom, there are links for Set filter options, Process Request Options, Process Monitor, and View Processing Results, along with a Save button.

Purchase Order	Doc Status	Hold	PO Status	No of Days pending	Last Notified on
<input type="checkbox"/> 0000000001		N	Dispatched		
<input type="checkbox"/> 0000000002		N	▼ Pend Appr	14	
<input type="checkbox"/> 0000000003		N	▼ Pend Appr	11	Friday, Feb 28, 2014 02:02 AM
<input type="checkbox"/> 0000000004		N	▼		(Multiple Values)
<input type="checkbox"/> 0000000005		N	▼		
<input type="checkbox"/> T850000000		N	Dispatched		

Approval

Select the Approval tab



Field or Control	Description
PO Status	<p>Displays the PO's status. If the status is Pending Approval or Approved, then the related action drop down will have the following options.</p> <ul style="list-style-type: none"> • View Approval — Displays PO line and approval workflow information. If the PO is pending at line level, List of Lines Pending will also be shown in addition to Approver information. The user can select lines for which the user wants to send reminder and click “Issue Approval reminder” in the PO List page. This action appears when the Approval Framework is enabled for the Business Unit and the PO status is Pending or Approved. • Send Reminder — Select to send reminders to all the Approvers with whom the PO is pending. Reminders will be sent in the form of email, worklist or both, depending on the set up in transaction configuration. This action appears when Can Send Approval Reminder is selected in the User Preference and the PO status is Pending. <hr/> <p>Note: The Send Reminder option in the drop down is available when using PeopleTools 8.54. Select lines and click on the button Send Approval Reminder when drop down option is unavailable.</p>
No of Days Pending	<p>Displays the number of days the PO has been pending with the current Approver. When multiple lines are pending approval and each line has the same number of days pending, the No of Days Pending will show the value. If any of the lines have a different number of days pending, "(Multiple Values)" will display.</p>

Line 1 (Pending days)	Line 2 (Pending days)	Line 3 (Pending days)	No of days displayed in PO grid
4	4	4	4
3	10	14	(Multiple Values)
0	0	0	0

Field or Control	Description
Last Notified on	Displays when the last notification was issued to the user. In case of escalations the latest notified date time will be displayed either through NEM or through Buyer's workbench, whichever is recent. If the last notified date is available, it will be displayed if Approvals are pending at the Header level. If notified date is not available, the field remains blank. "(Multiple Values)" will display when multiple lines are pending approval and each line has the same last notified date. This field will be blank if no notification is sent for the lines.



Detail

Select the Detail tab.

Field or Control	Description
Purchase Order	Click the purchase order number to access the purchase order inquiry for that purchase order number. Note: When a purchase order has an authored contract document associated to it, certain changes here could affect the authored document. If you make changes, you should contact the contract specialist or the buyer in case they need to update the document.
	Click the Doc Status (doc status) button for the selected purchase order to access the purchase order Document Status page in a new window for the purchase order.
	Click the Lines button for the selected purchase order to access the Buyer's Workbench - Purchase Order Lines page. Using this page you can view the lines associated with the purchase order or select individual lines to process the particular action for. You can cancel or close an individual line on a purchase order.

Other

Select the **Other** tab.

Field or Control	Description
	Click the Go To PO Activity Summary button for the selected purchase order to access the Activity Summary inquiry page in a new window.
	Click the Edit the PO button to access the Maintain Purchase Orders component in a new window so that you can edit the purchase order.

Actions

Field or Control	Description
Approve	Click this button to change the status of the selected purchase orders to <i>Approved</i> .
Unapprove	Click this button to change the status of the selected purchase orders to <i>Open</i> . <hr/> Note: You cannot unapprove dispatched purchase orders.
Cancel	Click to cancel the selected purchase orders. When you cancel a purchase order that is in a Dispatched status, the status changes to <i>Pend Cncl</i> (pending cancel). When canceling purchase orders, the system does create change orders. <hr/> Note: If you cancel a purchase order that is associated to a requisition that is pegged, the system will not reopen the requisition quantity or amount.
Close	Select to close the selected purchase orders from further processing. You can override unqualified purchase orders and make them available for closing, by selecting the purchase order IDs and clicking the Override button. To give a user the authority to override non-qualified requisitions, click the Override Non-Qualified POs for Close check box on the User Preferences - Procurement: Purchase Order Authorizations page. See “User Preferences – Purchase Order User Authorizations Page” (Application Fundamentals).

Field or Control	Description
Dispatch	<p>Select to dispatch the selected purchase orders, including all lines on the purchase order. Only purchase orders with approved or pending cancel statuses can be dispatched. If commitment control is enabled, the purchase order must also have a valid budget check status before it can be dispatched.</p> <hr/> <p>Note: Process Request Options must be established for the workbench before you will be able to dispatch the selected purchase orders.</p> <hr/>
Preview	Select to preview the selected purchase orders.
Budget Check	Click to initiate the Commitment Control Budget Processor process for the selected purchase orders. This button is available if commitment control is enabled for PeopleSoft Purchasing. When you click the Budget Check button, the Processing Results page appears. Use this page to review the selected purchase orders and select to proceed with order processing.
Budget Pre-Check	<p>Click to check the budget only. This button enables you to check whether a budget exists for a purchase order before the amount is committed to the pre-encumbrance or encumbrance and makes it possible to validate documents in work-in-progress mode without affecting budget balances. When performing budget pre-check only processing, the Budget Processor performs all of its budget checking and edits, but does so without committing changes to the ledger or other records. The statuses of <i>Provisionally Valid</i> or <i>Error</i> on the transaction pages indicate whether a budget is available. If you click the button and if the budget check is valid, then the system sets the budget header status for the requisition to <i>Prov Valid</i>. If the budget check is not valid, then the system sets the budget header status to <i>Error</i> with a link to the Exception page.</p> <p>The button is visible only if the Purchasing check box is selected in Enable Commitment Control section on the Installation Options - Products page and the Purchasing check box is selected in the Enable Budget Pre-check section on Installation Options - Commitment Control page. The button is not visible if the budget status is <i>Valid</i>.</p>

Go To Options

<i>Field or Control</i>	<i>Description</i>
Set filter options	Click to access the Buyer's Workbench - Filter Options page. Enter selection criteria for a new subset of purchase orders to review, modify, or take action on.
Process Request Options	Click to access the Buyer's Workbench - Process Request Options page. Use this page to define process request options for use by the dispatch process.
Process Monitor	Click to access the Process Monitor page, where you can view the status of purchase orders that you submitted to dispatch or preview.
View Processing Results	Click to access the Buyer's Workbench - Processing Results page, where you can view the results of the actions that you have performed.
Save	Click the button to save the search criteria that generated the list of purchase orders on the Buyer's Workbench page.

Related Links

[Creating Purchase Order Headers](#)

[Creating and Viewing Purchase Order Backorders](#)

[Understanding Document Status Inquiries](#)

[Viewing Purchase Order Activity Summaries](#)

Buyer's Workbench - Purchase Order Lines Page

Use the Buyer's Workbench - Purchase Order Lines page (PO_RC_WB_LN) to view or select the lines associated with the selected purchase order.

Navigation:

Click the **Lines** button for a purchase order on the Buyer's Workbench page.

This example illustrates the fields and controls on the Buyer's Workbench - Purchase Order Lines page. You can find definitions for the fields and controls later on this page.

Buyer's WorkBench
Purchase Order Lines

Business Unit US003 WorkBench ID 123
Description DSFSDF
Purchase Order 0000000006

Select POs for Further Processing

List of Purchase Order Lines Personalize | Find | View 1 | 1-4 of 4 | First | Last

Line	Status	Item ID	Description	Category ID	No of Days Pending	Last Notified On
<input type="checkbox"/> 1	Pending	10000	Long Sleeve Biking Jersey, Men's	00009	0	
<input type="checkbox"/> 2	Pending	10002	Long Sleeve T-Shirt, Mens	00009	0	
<input type="checkbox"/> 3	Pending	10004	Long Sleeve T-Shirt, Womens	00009	10	Saturday, Mar 01, 2014 08:03 AM
<input type="checkbox"/> 4	Pending	10005	Switchback Mountain Biking Shorts, Men's	00009	12	Saturday, Mar 01, 2014 08:03 AM

Select All Clear All

[Review Approvers](#)

When the approval is pending at the line level, the user will have to select from the List of Purchase Order Lines, and then click Send Approval Reminder in Buyer's Workbench page to send reminder approvals.

The system enables you to perform an action (close, cancel, and so on) for individual lines associated with the purchase order. For example, you can close individual lines associated with a purchase order or even override the nonqualified lines for closing.

Details

<i>Field or Control</i>	<i>Description</i>
Line	Click the line number to access the schedule for the line.

Contract Info

Select the Contract Info tab.

<i>Field or Control</i>	<i>Description</i>
GPO ID	Displays the group purchasing organization ID.

Field or Control	Description
GPO Contract Number	Displays the group purchasing organization contract number.

See [Understanding GPO Contracts](#).

Buyer's Workbench - Purchase Order Schedules Page

Use the Buyer's Workbench - Purchase Order Schedules page (PO_RC_WB_SCHD) to view the schedules associated with the selected purchase order.

Navigation:

Click a line number on the Buyer's Workbench - Purchase Order Lines page.

This example illustrates the fields and controls on the Buyer's Workbench - Purchase Order Schedules page. You can find definitions for the fields and controls later on this page.

Buyer's WorkBench

Purchase Order Schedules

Business Unit US001 WorkBench ID WB1
 Description Workbench
 PO Number 0000000001
 Line 1

Select POs for Further Processing

List of Purchase Order Schedules Personalize | Find | View All | First 1-4 of 4 Last

Sched	Status	Due Date	PO Qty	Close PO Under Percent Tol	Receiving	Merchandise Amt	Currency	Maintain Distributions
<input type="checkbox"/> 1	Active	07/26/2000	100.0000			2374.00	USD	
<input type="checkbox"/> 2	Active	07/27/2000	100.0000			2374.00	USD	
<input type="checkbox"/> 3	Active	07/27/2000	70.0000			1661.80	USD	
<input type="checkbox"/> 4	Active	07/27/2000	600.0000			14244.00	USD	

Select All Clear All

[Return to Purchase Order Lines](#)

Notify Refresh

Field or Control	Description
Sched (schedule)	Click a schedule line number to access the associated distribution.

Related Links

[Creating Purchase Order Distributions](#)

Buyer's Workbench - Processing Results Page

Use the Buyer's Workbench - Processing Results page (PO_RC_WB_RSLT) to review the results after taking action on selected purchase orders.

Navigation:

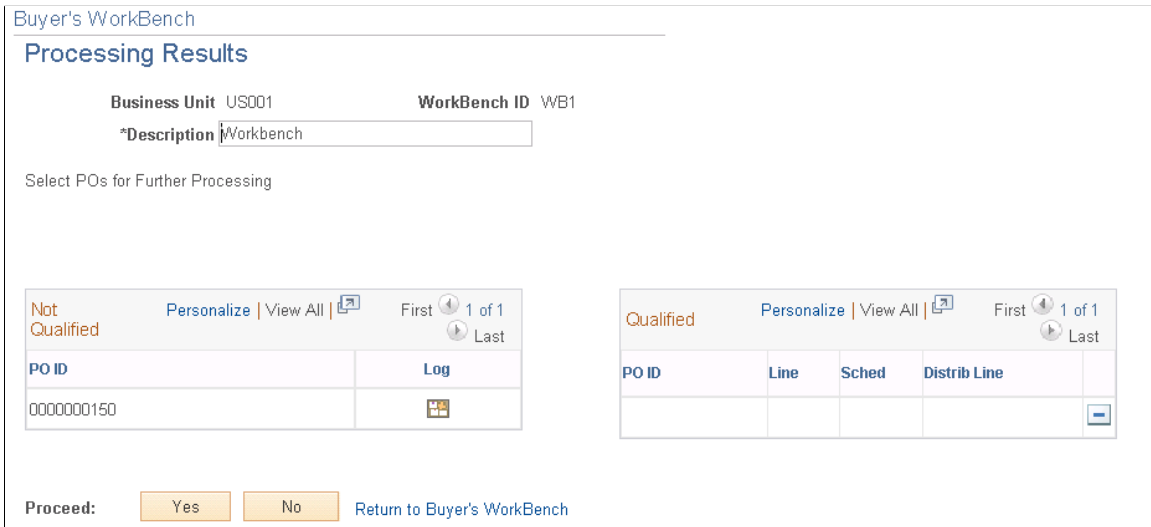

Perform an action on the Buyer's Workbench and the system displays the processing results.

This example illustrates the fields and controls on the Buyer's Workbench - Processing Results page. You can find definitions for the fields and controls later on this page.



The system reviews the documents for the action taken on the Buyer's Workbench page and determines whether the purchase orders are qualified for that action.

Field or Control	Description
	<p>Click the Override button to move nonqualified purchase orders in the Not Qualified group box to be qualified for the action in the Qualified group box.</p> <p>When closing purchase orders, the system displays this button that you can click to override the edits on selected lines that are not qualified if you have the authority to do so. This makes the lines available for closing and moves the lines to the qualified side.</p> <p>To give a user the authority to override nonqualified purchase orders, click the Override Non-Qualified POs for Close check box on the User Preferences - Procurement: Purchase Order Authorizations page.</p> <hr/> <p>Note: This button will only be available if the user has the authority to override nonqualified purchase orders for close.</p> <hr/> <p>See “User Preferences – Purchase Order User Authorizations Page” (Application Fundamentals).</p>

Field or Control	Description
Re-source Requisition?	<p>When canceling purchase orders that are sourced from requisitions, select this check box to transfer the purchase order quantities to the original requisition. This action enables you to source the original requisition again.</p> <p>If you cancel a purchase order that is associated to a requisition that is pegged, the system will not reopen the requisition quantity or amount.</p>
Accounting Date for Action	<p>This date is used to determine the open period or allowable open date range for budget checking a purchase order when you are using commitment control.</p> <p>In addition, whether you are using commitment control or not, the system updates the accounting dates with this date for the purchase orders being closed or canceled using the Buyer's Workbench.</p>
	Click the Log button to access the log for the selected nonqualified purchase order. The log states why the purchase order was not qualified for the previous processing action.
	Click the Delete Row button to remove qualified purchase orders from being sent for further processing.
Yes	Click this button to proceed with the processing on the qualified purchase orders. The system prompts you to confirm this selection.
Delete	Click this button to cancel the processing.

Related Links

[Understanding the Close Purchase Orders Process](#)

Using the Fluid User Interface for Buyer

This topic discusses how Buyers use the fluid buyer navigation collection. Fluid Buyer provides you a collection of buyer components.

Pages used to view Buyer pages using the Fluid User Interface

Page Name	Definition Name	Usage
Buyer Tile	NA	Access a collection of buyer components

Buyer Tile

Use the buyer tile to access a collection of buyer components.

Navigation:

Fluid > Procurement Operations Home page

This example illustrates the fields and controls on the Buyer Tile. You can find definitions for the fields and controls later on this page.

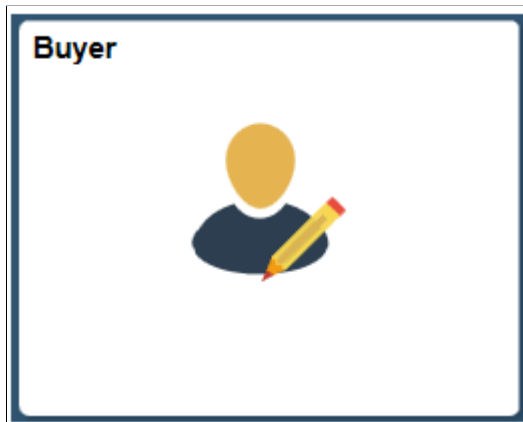

Click the buyer tile to access the buyer navigation collection.

Buyer page

This example illustrates the fields and controls on the Buyer page. You can find definitions for the fields and controls later on this page.

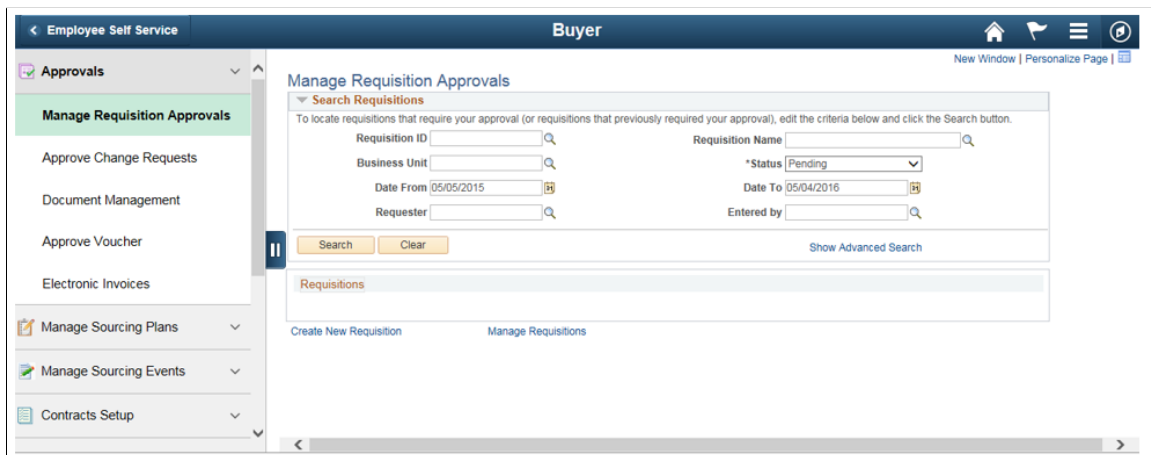

This navigation collection enables buyers to access frequently-used buyer components from one location. The left panel of this page lists the components collected under eleven categories :

- Approvals
- Manage Sourcing Plans
- Manage Sourcing Events

- Contracts Setup
- Requisitions
- Manage Contracts
- Purchase Orders
- Receipts
- Payments
- Dashboards
- Buyer WorkCenter

The right panel displays the component selected in the left panel.

Closing Purchase Orders

Understanding the Close Purchase Orders Process

Use the Close Purchase Orders Application Engine process (PO_PORECON) to close qualifying purchase orders that you no longer need to modify. When you run the Close Purchase Orders process, it reconciles various purchase-order-related settings and statuses to change the status of applicable purchase orders to C (completed).

To perform the Close Purchase Orders process you need to have the authorization to do so. To enable users to be able to close purchase orders, you must establish their authorizations using the Procurement - Purchase Order Authorizations page. Using this page you can give the user the ability to close purchase orders as well as override non-qualified purchase orders for close.

The benefit of this status change is that completed purchase orders no longer appear in your list of available purchase orders when you access purchase order pages in update and display mode. These completed purchase orders are also removed from the view in many of the other situations in which the available options have been set to exclude completed or canceled purchase orders. Removing these purchase orders improves system performance and decreases the time required to find purchase orders that you need to modify.

If commitment control is enabled, the Close Purchase Orders process resets the budget header and line statuses, and sets the close flags (KK_CLOSE_FLAG and PROCESS_MANUAL_CLOSE) on the purchase order distributions. This allows the Commitment Control Budget Processor process (FS_BP) to liquidate encumbrance budget amounts for outstanding purchase orders.

Although the Close Purchase Orders process is optional and you can set it to run at any time, running the process at the end of each month helps to improve the efficiency of your purchase order process. You can schedule this process to run automatically by using the PeopleSoft Process Scheduler or initiate it manually by using the Close Purchase Orders page.

The Close Purchase Orders process occurs at the end of the PeopleSoft Purchasing transaction life cycle. To understand the Close Purchase Orders process, it is important to know where the process fits in the PeopleSoft Purchasing transaction life cycle. This diagram illustrates the transaction flow around the Close Purchase Orders process:

This diagram illustrates the transaction flow around the Close Purchase Orders process:

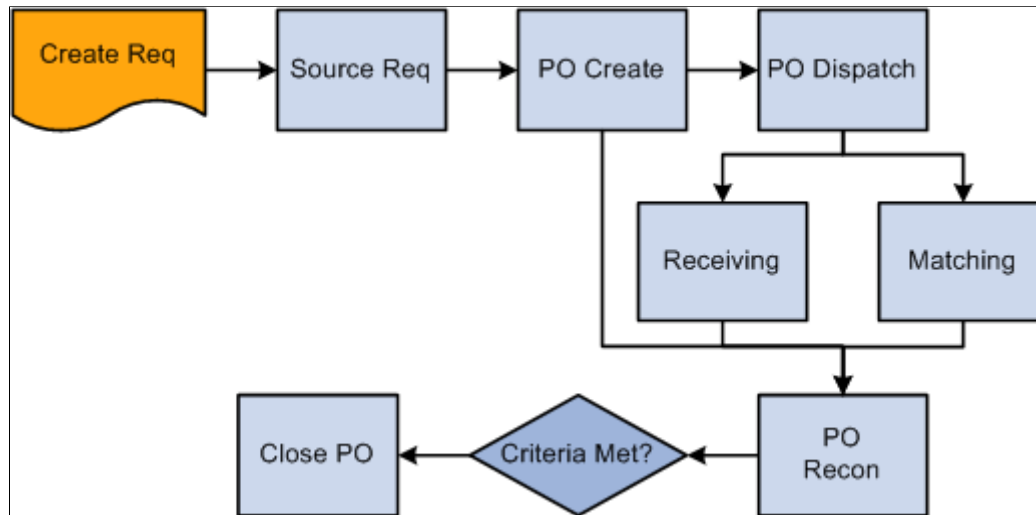

When you run the Close Purchase Orders process from the Close Purchase Orders page, you have three processing options on the Process Scheduler Request page:

- Select Close Purchase Order SQR Report (POPO008) to produce the Close Purchase Order report.
- Select Close Purchase Orders Application Engine process (PO_PORECON) to run the Close Purchase Orders process.
- Select Close Purchase Orders multiprocess job (PO_POREP) to run the Close Purchase Orders process and produce the Close Purchase Order report.

If necessary, you can run the Purchase Order Reopen process (PO_POREOPEN) to undo the changes made by the Close Purchase Orders process.

See the product documentation for *PeopleTools: Process Scheduler*

Related Links

[Reopening Purchase Orders](#)

[Understanding Commitment Control in PeopleSoft Purchasing](#)

“User Preferences – Purchase Order User Authorizations Page” (Application Fundamentals)

Purchase Order Close Criteria

To understand how the Close Purchase Order process functions, you must know the criteria that the process uses to close a purchase order. The process checks the settings and statuses of several criteria to determine that a purchase order is ready to be closed and that it does not need to be accessed for modifications in the future.

These tables detail the business-related criteria verified by the Close Purchase Orders process and the settings and statuses that must be met to qualify for closure. Each of the criteria discussed must be met for the Close Purchase Orders process to close a purchase order:

Business-Related Criteria	Qualifying Setting or Status
<p>Close Days</p> <p>The Close Days field on the Purchasing Definition - Business Unit Definition page specifies the number of days beyond a purchase order's last activity date during which the purchase order cannot be closed. The close days value creates a grace period during which you can change the purchase order before the purchase order closes. If you leave the Close Days field blank, the system uses zero close days.</p> <hr/> <p>Note: The Close Days value that you define for the business unit is for purchase order reconciliation and has no relationship to the close days value on the Close Short Run control pages.</p>	<p>The Close Purchase Orders process verifies that the number of close days defined for the purchase order's purchasing business unit has elapsed. The system adds the value for the Close Days field to the last activity date to determine whether the required number of grace period days has passed.</p> <p>For example, for a Close Purchase Orders process run date of August 31, 2006, suppose that the last activity date for the purchase order is August 25, 2006 and the value for the Close Days field is set to five days. In this example, the process closes the purchase order.</p> <p>You can view the value in the Close Days field by writing a Structured Query Language (SQL) statement against PS_BUS_UNIT_TBL_PM.</p>
<p>Cancel Days</p> <p>The Cancel Days field on the Purchasing Definition - Business Unit Definition page specifies the number of days beyond a purchase order last activity date during which the canceled purchase order cannot be closed. The value for the Cancel Days field creates a grace period during which a canceled purchase order cannot be closed. If you leave the field blank, the system uses zero cancel days. Cancel days is a business unit attribute; therefore, the system omits the calculation for the Cancel Days field when the Close Purchase Orders page specifies a specific purchase order number.</p>	<p>The value in the Cancel Days field works the same way in which the value in the Close Days field does but for canceled purchase orders. The Close Purchase Orders process verifies that the number of cancel days defined for the purchase orders purchasing business unit has elapsed. The system adds the value for the Cancel Days field to the last activity date to determine whether the required number of grace period days has passed.</p> <p>You can view the value in the Cancel Days field by writing an SQL statement against PS_BUS_UNIT_TBL_PM.</p> <hr/> <p>Note: The Close Purchase Order process does not change the line status from <i>Canceled</i> to <i>Complete</i>. However, it does change the header status to <i>Complete</i>. The purchase order line status remains <i>Canceled</i>, so that you can distinguish canceled lines from closed lines.</p>

Business-Related Criteria	Qualifying Setting or Status
<p>Close PO Under Percent Tolerance</p> <p>The Close PO Under Percent Tolerance value defines the acceptable percentage of the total purchase order quantity or amount that can be outstanding while still allowing the purchase order to be closed. This setting enables the Close Purchase Orders process to close a purchase order even if the received quantities or amounts are less than the purchase order quantity or amount.</p> <p>The Close Purchase Orders process compares the tolerances based on quantity or amount according to the distribution method on the purchase order.</p> <p>This value is set at these levels:</p> <ul style="list-style-type: none"> • The business unit specific attributes level on the Purchasing Attributes - Purchasing Controls page. • The purchasing attributes level when using the Item Master enterprise integration point on the Data Definition Maintenance - PO Attributes - Purchasing Controls 2 page. • The item categories level on the Item Categories - Category Definition 2 page. <hr/> <p>Note: These system levels are ordered from specific to generic. The percent tolerance value set at a more specific level in the hierarchy overrides the setting at the more generic level.</p> <hr/>	<p>The Close Purchase Orders process uses these calculations to verify that the Close PO Under Percent Tolerance value has been met so that the process can close the purchase order:</p> <ul style="list-style-type: none"> • $(Quantity\ Received) \geq (Quantity\ Ordered) - ((Quantity\ Ordered) \times (Percent\ Tolerance))$ • $(Amount\ Received) \geq (Amount\ Ordered) - ((Amount\ Ordered) \times (Percent\ Tolerance))$

This table details the record-level criteria that must be met for a purchase order to qualify for closure:

Record-Level Criteria	Qualifying Setting or Status
<p>PO Status</p>	<p>The Close Purchase Orders process verifies that the purchase order has a status of <i>D</i> (dispatched) or <i>X</i> (canceled).</p> <p>Statuses of <i>O</i> (open) and <i>A</i> (approved) enable the process to close a purchase order when other applicable criteria are met. The other criteria that must be met are:</p> <ul style="list-style-type: none"> • Receiving is not required for the purchase order. • Matching is not required for the purchase order. • The purchase order schedule date plus close days has already passed (last activity date <= system date). <p>Statuses of <i>I</i> (initial), <i>PA</i> (pending approval), and <i>C</i> (completed) do not enable the process to close the purchase order.</p> <p>You can view the purchase order status by writing an SQL statement against PS_PO_HDR.</p>
<p>Activity Date</p> <p>The system updates this date on the purchase order when you create a change order and save your work, and also when you cancel a purchase order through the Buyer's Workbench.</p>	<p>The Close Purchase Orders process uses these calculations to determine whether the purchase order's last activity date enables the process to close the purchase order:</p> <ul style="list-style-type: none"> • (Activity Date) ≤ (Current Date) - (Close Days). • (Activity Date) ≤ (Current Date) - (Cancel Days). <p>You can view the activity date value by writing an SQL statement against the PS_PO_HDR record and looking at the ACTIVITY_DATE field.</p>

Record-Level Criteria	Qualifying Setting or Status
Match Status	<p>The Close Purchase Orders process verifies that, if matching is required for the purchase order, the match status of the purchase order is <i>M</i> (matched), <i>N</i> (no match is required), <i>P</i> (partially matched), and <i>T</i> (to match).</p> <p>In cases where the MATCH_STATUS_PO and MATCH_STATUS_LN_PO never reaches a status of <i>M</i> (matched), the Close Purchase Orders process checks the purchase order schedule (PO_LN_SHIP_MTCH) for quantity matched.</p> <p>A matching status of <i>P</i> (partially matched) does not qualify the purchase order for closure.</p> <p>A purchase order with a header match status of <i>T</i> (to match) will be closed by the Close Purchase Orders process if the match status on the associated lines is <i>M</i> (matched) if matching is required.</p> <p>When matching is required on a purchase order, there can be several vouchers against a purchase order. One of the vouchers might be matched, but the status (MATCH_STATUS_PO) on the purchase order remains <i>P</i> (partially match) until the final voucher is matched. The purchase order status then changes to <i>M</i> (matched).</p> <p>The Close Purchase Orders process considers a purchase order fully matched and available for closure when the quantity ordered for each line on the purchase order is less than or equal to the total quantity received and matched.</p> <p>You can view the match status value by writing an SQL statement against the PS_PO_HDR table and viewing the value in the MATCH_STATUS_PO field.</p>
Distribution Line Status	<p>The Close Purchase Orders process verifies that the distribution line statuses for the purchase order are <i>O</i> (open), <i>P</i> (processed), or <i>X</i> (canceled).</p>
Amount Only	<p>The Close Purchase Orders process checks to see whether the Amount Only check box (AMT_ONLY_FLG) is selected for the purchase order line. If the purchase order line is to be received by amount only, the Close Purchase Orders process sums up the merchandise amounts in supplier currency recorded in receipt transactions and compares the total to the merchandise amount on the purchase order to determine whether the purchase order has been fully received.</p>
Receiving Required setting	<p>The Close Purchase Orders process verifies whether the Receiving Required field is <i>Receiving is Required</i> for the purchase order line on the Maintain Purchase Order - Details for Line page. The process uses this setting in conjunction with the due date value at the record level to determine whether it can close the purchase order.</p> <p>You can view the receiving required value by writing an SQL statement against the PS_PO_LINE.RECV_REQ field.</p>

Record-Level Criteria	Qualifying Setting or Status
Due Date	<p>The Close Purchase Orders process uses this calculation to verify that the due date on the purchase order schedule line (PO_LINE_SHIP.DUE_DT) is less than or equal to the calculated close date:</p> $(\text{Due Date}) \leq (\text{Current Date}) - (\text{Close Days})$ <p>The Close Purchase Orders process verifies that the due date value for purchase orders when the Receiving Required field is <i>Receiving is Optional</i> or <i>Do Not Receive</i>. This includes PeopleSoft Order Management direct shipments.</p>
Voucher Status	<p>The Close Purchase Orders process verifies that associated vouchers have been posted, deleted, or closed.</p> <p>If matching is not required for the purchase order (that is, the match status of the purchase order is <i>N</i>), then the purchase order can close even if the voucher is not posted.</p>
Entry Event Status	<p>If you enable commitment control, the Close Purchase Orders process verifies that you have checked the row for entry events.</p>

Additionally, you can view purchase order schedule information (PS_PO_LINE_SHIP), purchase order distribution information (PS_PO_LINE_DISTRIB), and purchase order receiving information (PS_RECV_LN_DISTRIB) by writing an SQL statement against the mentioned tables.

Related Links

[Close Purchase Orders Page](#)

[Details for Line Page](#)

[Establishing PeopleSoft Purchasing Business Units](#)

[Defining Purchasing Item Attributes](#)

“Editing Data Errors in the Item Loader Staging Tables” (PeopleSoft Managing Items)

Describing Close Purchase Order Changes to Purchase Order Statuses

The Close Purchase Orders process can close purchase order distribution lines, schedules, lines, and header in intervals. Distribution lines close first, followed by the schedules, lines, and finally the header. Therefore, it is possible to have a distribution line close before the rest of the purchase order.

For example, suppose that a purchase order contains 20 lines, each with two schedules. When the necessary distributions close, the schedule qualifies for closure. Once the two schedules close for a line, the line closes. When the 20 lines close, the purchase order closes.

If a purchase order meets the criteria described in the previous tables, the Close Purchase Orders process updates purchase order statuses as shown in these tables:

<i>PO Distribution Line (PO_LINE_DISTRIB)</i>	<i>Updated Status</i>
BUDGET_LINE_STATUS (if commitment control is used)	<i>N</i> (not budget checked)
KK_CLOSE_FLAG (if commitment control is used)	<i>Y</i> (yes)
PROCESS_MAN_CLOSE	<i>Y</i> (yes)
DISTRIB_LN_STATUS	<i>C</i> (completed)
PC_DISTRIB_STATUS	<i>N</i> (no)
PEG_STATUS	<i>CANCELED</i> (if the purchase order had no activity.) <i>COMPLETE</i> (if the purchase order was either partially or fully received, vouchered, and matched.)

<i>PO Distribution Line (PO_LINE_DIST_NP)</i>	<i>Updated Status</i>
BUDGET_LINE_STATUS (if commitment control is used)	<i>N</i> (not budget checked)
KK_CLOSE_FLAG (if commitment control is used)	<i>Y</i> (yes)
PROCESS_MAN_CLOSE	<i>Y</i> (yes)
DISTRIB_LN_STATUS	<i>C</i> (completed)

<i>PO Schedule</i>	<i>Updated Status</i>
CANCEL_STATUS	<i>C</i> (completed)

<i>PO Line</i>	<i>Updated Status</i>
CANCEL_STATUS	<i>C</i> (completed)

<i>PO Header</i>	<i>Updated Status</i>
PO_STATUS	<i>C</i> (completed)
ACTIVITY_DATE	<i>Run Date</i>

<i>PO Header</i>	<i>Updated Status</i>
BUDGET_HDR_STATUS (if commitment control is used)	<i>N</i> (not budget checked)
BUDGET_HDR_STS_NP (if commitment control is used)	<i>N</i> (not budget checked)
RECV_STATUS	<i>R</i> (fully received)

Purchase Order Closure and the Fully Received Status

When you receive goods against a dispatched purchase order, the received status changes to *P* (partially received). The Close Purchase Orders process changes the purchase order line item *O* (open) status to *R* (fully received), if any of these sets of criteria are met for a purchase order:

- Matching is not required.
- The line item status is *Open*.
- $(\text{Quantity Matched}) \geq (\text{Quantity Ordered})$.

or

- Matching is required.
- The line item status is *Open*.
- $(\text{Quantity Matched on PO_LN_SHIP_MTCH}) \geq (\text{Quantity Ordered}) \times (\text{Under Quantity Percent Tolerance})$.

or

- Receiving is not required or optional.
- The line item status is *Open*.
- $(\text{Scheduled Due Date}) \leq (\text{Current Date}) - (\text{Close Days})$.

or

- Receiving is required and:
 - The line item status is *Open*.
 - $(\text{Last Activity Date}) \leq (\text{Current Date}) - (\text{Close Days})$.
 - $(\text{Scheduled Due Date}) \leq (\text{Current Date})$.

Purchase Order Closure and the Complete Status

The Close Purchase Orders process closes a dispatched purchase order and sets its status to *Complete* if any of these sets of criteria are met for a purchase order:

- The purchase order is dispatched.
- The purchase order matched status is either *Matched* or *Not Required*.
- Receiving is required.
- All line items are fully received.
- $(\text{Last Activity Date}) \leq (\text{Current Date}) - (\text{Close Days})$.

or

- The purchase order is dispatched.
- The purchase order matched status is either *Matched* or *Not Required*.
- Receiving is not required or optional.
- $(\text{Shipment Due Date}) \leq (\text{Current Date})$.
- $(\text{Last Activity Date}) \leq (\text{Current Date}) - (\text{Close Days})$.

Closing Purchase Orders

This section discusses how to run the Close Purchase Orders process.

Note: You can use the Buyer's Workbench to preview the results of the Close Purchase Orders process on selected transactions. After you have confirmed that the process produces the results that you want, you can run the Close Purchase Orders process from the Buyer's Workbench.

Page Used to Close Purchase Orders

<i>Page Name</i>	<i>Definition Name</i>	<i>Usage</i>
<u>Close Purchase Orders Page</u>	RUN_PORECON	Run the Close Purchase Orders multiprocess job, or the Close Purchase Orders process and produce the Close Purchase Order report.

Related Links

[Understanding the Buyer's Workbench](#)

Close Purchase Orders Page

Use the Close Purchase Orders page (RUN_PORECON) to run the Close Purchase Orders multiprocess job, or the Close Purchase Orders process and produce the Close Purchase Order report.

Navigation:

Purchasing > Purchase Orders > Reconcile POs > Close Purchase Orders

This example illustrates the fields and controls on the Close Purchase Orders page. You can find definitions for the fields and controls later on this page.

Note: When a purchase order has an authored contract document associated to it, certain changes that occur when closing the purchase order could affect the authored document. You should contact the contract specialist or the buyer in case they need to update the authored document.

Process Request Parameters

Field or Control	Description
<p>PO Post Run Option</p>	<p>Determines which purchase orders are selected for the Close Purchase Orders process. Values are:</p> <p><i>1 Bus Unit</i> (one business unit): Reconciles all purchase orders within a single business unit. If you select this value, you may enter business unit and ChartField criteria.</p> <p><i>1 Document</i>: Reconciles a single purchase order within a single business unit. If you select this value, you may enter business unit, purchase order, and ChartField criteria.</p> <p><i>All BUs</i> (all business units): Reconciles all purchase orders within all business units. If you select this value, all other fields on the page are unavailable for entry.</p>

ChartField Criteria

Use the **ChartField Criteria** group box to select purchase orders for processing based on ChartField values. This option is useful if you are using commitment control and want to process purchase orders based on ChartField values.

Field or Control	Description
Accounting Date for Action	Displays the accounting date for action, which is used to determine the open period or allowable open date range for budget checking a purchase order when you are using commitment control. In addition, whether you are using commitment control or not the system updates the accounting date with this date for the purchase orders closed by the Close Purchase Orders process.
Use Current Date as Acct. Date	Select this check box if you want to use the current date as the accounting date during the close process. This check box appears only if you are using commitment control.
Update Budget Date Equal to Accounting Date	Select this check box if you want to update the budget date to be equal to the accounting date. This check box appears only if you are using commitment control.

Related Links

[POPO008 - Close Purchase Order](#)

Reopening Purchase Orders

This section provides an overview of the Purchase Order Reopen process and discusses how to run the Purchase Order Reopen process.

Page Used to Reopen Purchase Orders

Page Name	Definition Name	Usage
Reopen POs Page	RUN_PO_REOPEN	Initiate the Purchase Order Reopen process.

Understanding the Purchase Order Reopen Process

The Purchase Order Reopen Application Engine process (PO_POREOPEN) gives you the ability to reopen purchase orders. To perform the Purchase Order Reopen process you need to have the authorization to do so. To enable users to be able to reopen purchase orders, you must establish their authorization using the Procurement - Purchase Order Authorizations page. Using this page you can give the user the ability to reopen purchase orders.

Using the Purchase Order Reopen process you can reopen purchase orders by:

- Undoing changes made by the Close Purchase Orders process.

The process reverses the effects of the Close Purchase Orders process on the most recently processed group of purchase orders.

- Reopening any purchase order at any time.

This process enables to reopen a range of purchase orders, a specific purchase order, or all purchase orders associated with a business unit.

Note: A purchase order that has been canceled at the header level, is not eligible for reopening.

Note: Purchase orders that were closed prior to the PeopleSoft Purchasing 9.0 release are not reopened using this functionality.

Running this process resets several values associated with the purchase order. The Purchase Order Reopen process will reset these values:

<i>PO_HDR</i>	<i>Updated Value After Reopen</i>
PO_STATUS	Value saved at close
ACTIVITY_DATE	Current Date
BUDGET_HDR_STATUS (if commitment control used)	N
KK_TRAN_OVER_FLAG (if commitment control used)	N
BUDGET_HDR_STS_NP (if commitment control used)	N (if there are non-prorated distributions)
RECV_STATUS	Value saved at close
BACKORDER_STATUS	Value saved at close

<i>PO_LINE</i>	<i>Updated Value After Reopen</i>
CANCEL_STATUS	Value saved at close

<i>PO_LINE_SHIP</i>	<i>Updated Value After Reopen</i>
CANCEL_STATUS	Value saved at close

<i>PO_LINE_DISTRIB</i>	<i>Updated Value After Reopen</i>
BUDGET_LINE_STATUS (if using commitment control)	Value saved at close
KK_CLOSE_FLAG	Value saved at close
PROCESS_MAN_CLOSE	N
DISTRIB_LN_STATUS	Value saved at close
PC_DISTRIB_STATUS	N (if PeopleSoft Project Costing is installed)
PEG_STATUS	Value saved at close (for non-inventory distributions where complete quantity < peg quantity). Pegs that were canceled or completed will be reopened. The Purchase Order Reopen process will reopen the pegs and set the PEG_STATUS to <i>Open..</i>

<i>PO_LINE_DIST_NP</i>	<i>Updated Value After Reopen</i>
BUDGET_LINE_STATUS (if commitment control used)	Value saved at close
KK_CLOSE_FLG	Value saved at close
PROCESS_MAN_CLOSE	N
DISTRIB_LN_STATUS	Value saved at close

Related Links

“User Preferences – Purchase Order User Authorizations Page” (Application Fundamentals)

Reopen POs Page

Use the Reopen POs page (RUN_PO_REOPEN) to initiate the Purchase Order Reopen process.

Navigation:

Purchasing > Purchase Orders > Reconcile POs > Reopen POs

This example illustrates the fields and controls on the Reopen POs page. You can find definitions for the fields and controls later on this page.

Reopen POs

Run Control ID Reopen Report Manager Process Monitor
Run

Process Request Parameters

Last Close PO Run

Select POs to be Reopened

Reopen PO Selection Criteria

Reopen Request Specific Document

Business Unit US001

Purchase Order

PO Date All

Activity Date All

Supplier ID

Buyer

PO Reference

Accounting Date Option

Open with Specified Accounting Date 01/17/2013

Open with Existing Accounting Date

Reopen Associated Requisitions ?

Save
 Notify

Add
 Update/Display

Note: When a purchase order has an authored contract document associated to it, certain changes that occur when reopening the purchase order could affect the authored document. You should contact the contract specialist or the buyer in case they need to update the authored document.

Field or Control	Description
Last Close PO Run	Select this option if you want to reopen the purchase orders that were closed during the last run of the Close Purchase Orders process. When you select this option, the Reopen PO Selection Criteria group box is not available.
Select POs to be Reopened (select purchase orders to be reopened)	Select this option if you want to reopen any purchase order that has already been closed. After you select this option, enter the purchase order or purchase orders you would like to reopen in the Reopen PO Selection Criteria group box.

Reopen PO Selection Criteria

Field or Control	Description
Reopen Request	<p>Select the reopen request option. Values are:</p> <ul style="list-style-type: none"> • <i>Range of Documents:</i> Select if you want to reopen a range of purchase orders. After you select this option, select the purchase order range using the Purchase Order and To fields. • <i>Specific Business Unit:</i> Select if you want to reopen the purchase orders associated with a specific business unit. After you select this option, select the business unit using the Business Unit field. • <i>Specific Document:</i> Select if you want to reopen a specific purchase order. After you select this option, select the purchase order using the Purchase Order field.
PO Date	<p>Select a purchase order date option. Values are:</p> <ul style="list-style-type: none"> • <i>All:</i> Select if you want to reopen purchase orders for all purchase order dates. • <i>Range:</i> Select if you want to reopen purchase order for a certain date range. After you select this option, select the date range using the From and To date fields next to this field. • <i>Value:</i> Select if you want to reopen purchase orders for a specific date. After you select this option, select the date using the date field next to this field.
Activity Date	<p>Select an activity date option. Values are:</p> <ul style="list-style-type: none"> • <i>All:</i> Select if you want to reopen purchase orders for all activity dates. • <i>Value:</i> Select if you want to reopen purchase orders for a specific date. After you select this option, select the date using the date field next to this field.
Supplier ID	<p>Select the supplier ID. Purchase orders associated with that supplier will be reopened.</p>
Buyer	<p>Select the buyer. Purchase orders associated with that buyer will be reopened.</p>

<i>Field or Control</i>	<i>Description</i>
PO Reference	Enter the purchase order reference. Purchase orders associated with that purchase order reference will be reopened.

Accounting Date Options

<i>Field or Control</i>	<i>Description</i>
Open with Specified Accounting Date	Select this option if you want to reopen the purchase orders using the accounting date you specify. The current date appears by default in the date field but you can override it if you choose. This field only appears if you are using commitment control.
Open with Existing Accounting Date	Select this option if you want to reopen the purchase orders using the existing accounting date on the purchase orders. This field only appears if you are using commitment control.

Additional Criteria

<i>Field or Control</i>	<i>Description</i>
Reopen Associated Requisitions ?	<p>Select this check box if you want the Purchase Order Reopen process to reopen the requisition lines that are associated with purchase orders you are requesting to be reopened.</p> <p>For example, lets say you have a requisition that has five lines. You then create a purchase order associated to just one of the requisition lines. Then you close the purchase order. When you reopen the purchase order and if this check box is selected, the system will reopen just the one requisition line associated with the purchase order not the other requisition lines.</p> <p>If you are using commitment control, this check box must be selected.</p>

Chapter 39

Reviewing Purchase Order Information

Inquiring About Purchase Orders

This section lists the pages used to inquire about purchase orders.

Pages Used to Inquire About Purchase Orders

<i>Page Name</i>	<i>Definition Name</i>	<i>Usage</i>
Purchase Order Inquiry - Purchase Order Page	PO_LINE_INQ	View purchase order information. This is an inquiry version of the Maintain Purchase Order - Purchase Order page. The page displays purchase order header and line information and whether an authored document exists for the purchase order.
Purchase Order Inquiry - Supplier Details Page	PO_SUPPLIER_INQ	View supplier details.
Purchase Order Inquiry - PO Header Details Page	PO_HDR_DTL_INQ	View purchase order header details.
PO Header Details - Bill To Address Page	PO_ADDRESS	View billing address details for the billing location.
Exchange Rate Detail Page	EXCH_RT_DTL_INQ	View the rules used to calculate exchange rates for the transaction.
PO Header - VAT Information Page (purchase order header - value-added tax information)	PO_HDR_VAT_INQ	View purchase order value-added tax (VAT) information.
Return to Vendor Page	RTV_LN_DISP_SEC	View details about any RTV transactions associated with the selected purchase order.
Purchase Order Inquiry - PO Matching Page	PO_MATCHING_INQ	View purchase order-matching information.
PO Header Comments Page	PO_COMMENTS_IN_SEC	View comments for a transaction.

Page Name	Definition Name	Usage
PO Document Status Page	PRCR_DOCSTAT_INQ	Access and review information about procurement documents associated with a purchase order.
Purchase Order Inquiry - Procurement Card Information Page	CC_USE_HDR_DTL	View the procurement card or supplier card information that is being used as the payment method for the purchase order.
Review Change Orders - Header Changes Page	PO_CHANGE_HDR	View the change order history associated with a purchase order.
Purchase Order Inquiry - PO Total Amount Details Page	PO_ADJ_BRKDWN	View price adjustments broken down into individual amounts, such as freight, sales and use tax, miscellaneous charges, and value-added tax.
Item Description Page	PO_ITEM_DESCR_INQ	View descriptions for a specific item. The item description link is composed of the first 30 characters of the item's description in the Transaction Item Description text box on the Item Description page.
Details for Line Page	PO_LINE_DTLS_INQ	View purchase order line details. The rebate ID associated with the purchase order line displays on this page if the Rebate ID Security Control field value for the user is <i>Update</i> or <i>View Only</i> . Otherwise, the rebate ID will not display. The details include contract versions and lines and group and rebate IDs.
PO Line Comments Page	PO_COMMENTS_IN_SEC	View line comments for a transaction.
Purchase Order Inquiry - Schedules Page	PO_SCHED_INQ	View information about the purchase order schedule. This is an inquiry version of the Maintain Purchase Orders - Schedule page.
Purchase Order Inquiry - Details for Schedule Page	PO_SCHED_DTLS_INQ	View purchase order schedule details.
PO Ship To Comments Page	PO_COMMENTS_IN_SEC	View ship to comments for a transaction.

Page Name	Definition Name	Usage
Purchase Order Inquiry - PO ShipTo Address Page	PO_INQ_ADDR	View address details for the location relevant to the page from which this page is accessed.
Price Adjustments for Schedule Page	PO_VAL_ADJ_INQ	View schedule price adjustment information.
Miscellaneous Charges for a Schedule Page	PO_SCHED_MISC_INQ	View schedule miscellaneous charge information.
Sales/Use Tax Information for Schedule Page	PO_SCHED_SUT_INQ	View schedule sales and use tax information.
Schedule VAT Information Page	PO_SCHED_VAT_INQ	View schedule VAT information.
<u>Purchase Order Inquiry - Distributions for Schedule Page</u>	PO_SCHED_DIST_INQ	View purchase order distribution information.
Distribution Details Page	PO_DIST_DTLS_INQ	View distribution details.
PO Currency Information Page	PO_DIST_CURR_INQ	View purchase order currency information.
Sales/Use Tax Details for Distribution Page	PO_DISTRIB_SUT_INQ	View distribution sales and use tax details.
Distribution VAT Details Page	PO_DISTRIB_VAT_INQ	View distribution VAT details.
Requisitions inquiry Page	REQ_INQ_LOOKUP	View requisition information.

Purchase Order Inquiry Page

Use the Purchase Order Inquiry page (PO_LINE_INQ) to view purchase order information.

This is an inquiry version of the Maintain Purchase Order - Purchase Order page. The page displays purchase order header and line information and whether an authored document exists for the purchase order.

Navigation:

Purchasing > Purchase Orders > Review PO Information > Purchase Orders > Purchase Order Inquiry

This example illustrates the fields and controls on the Purchase Order Inquiry page. You can find definitions for the fields and controls later on this page.

Purchase Order Inquiry
Purchase Order

Business Unit US001 PO Status Dispatched
 PO ID SUMMARYPO

Header

PO Date 02/17/2012 Doc Tol Status Valid
 Supplier Name EB.TRAVEL-001 Backorder Status Not Backordered
 Supplier ID USA0000002 Supplier Details Receipt Status Not Recvd
 Buyer Hosking,Andrew Hold From Further Processing
 PO Reference

Amount Summary

Merchandise	100.00
Freight/Tax/Misc.	0.00
Total	100.00 USD

Header Details: All RTV, Matching
 Activity Summary: Header Comments, Document Status, Federal Award Data, Actions

Lines Personalize | Find | View All | First 1 of 1 Last

Line	Item ID	Item Description	Category	PO Qty	UOM	Merchandise Amount	Status
1		SUMMARY PO	MISC	10.0000	EA	100.00 USD	Approved

Return to Search Previous in List Next in List Notify Related Links

Refer to [Federal Award Data page](#) for descriptions on the Federal Award Data page.

Purchase Order Inquiry - Distributions for Schedule Page

Use the Purchase Order Inquiry - Distributions for Schedule page (PO_SCHED_DIST_INQ) to view purchase order distribution information.

Navigation:

Click the **Distributions/ChartFields** button on the Purchase Order Inquiry - Schedules page.

This example illustrates the fields and controls on the Purchase Order Inquiry - Distributions for Schedule page: Budget Information tab. You can find definitions for the fields and controls later on this page.

Distributions for Schedule 1

PO ID 000000216 Line 1 Sched 1 Item DSS_LAPTOP_PC Laptop Notebook PC; Wireless; DVD +/- RW

Status Active Sched Qty 20.0000
 Distribute By Quantity Merchandise Amount 34,000.00 USD
 Doc. Base Amount 34,000.00 USD

Distributions Personalize | Find | View All | First 1 of 1 Last

Chartfields Details/Tax Asset Information Req Detail **Budget Information**

Dist	Status	Percent	Budget Status	Budget Date	Encumbrance Balance	Currency	Encumbered Base Balance	Base Currency	Expensed To Date	Commitment Control Close Flag
1	Open	100.0000	Bypass	07/01/2008	0.00 USD		0.00 USD		0.00	<input type="checkbox"/>

Return

This page displays distribution information for a purchase order line, schedule, and item.

Field or Control	Description
	Click the Item Description button to view complete descriptions for items when descriptions have been added.

Field or Control	Description
Sched Qty (schedule quantity)	Displays the quantity of items on this schedule.
Distribute By	Displays the method used to allocate or charge the expense account distribution. Values are: <i>Amount:</i> Used when the sum of all distribution amounts must equal the schedule amount (merchandise amount). Inventory items cannot be distributed by amount. <i>Quantity:</i> Used when the sum of all distribution quantities must equal the schedule quantity.
Merchandise Amount	Displays the merchandise amount according to the quantities and prices of the items on the purchase order.
Doc. Base Amount (document base amount)	Displays the document base amount. This is the Amount value converted to the base currency of the purchase order. The base currency is the currency of the PeopleSoft General Ledger business unit for this PeopleSoft Purchasing business unit.

Select a tab to view additional information about a schedule's distribution.

See [Maintain Purchase Order - Distributions for Schedule Page](#).

Budget Information

Select the **Budget Information** tab.

Field or Control	Description
Dist (distribution line number)	Displays the distribution line number.
Status	Distribution line status. Values are: <i>Complete:</i> The distribution line is closed. <i>Open:</i> The distribution line is open. <i>Processed:</i> The distribution line has been processed and is unavailable for sourcing. <i>Canceled:</i> The distribution line has been canceled.
Percent	Displays the percentage of either the quantity or the amount that is to be distributed on this distribution line. The system calculates other distribution values based on the percentage value.

Field or Control	Description
Budget Status	When commitment control is on, the system displays whether this distribution has been budget checked. Values for the field include <i>Not Chekd</i> and <i>Valid</i> .
Budget Date	Displays the date used by commitment control to determine the budget period to which this item cost belongs.
Encumbrance Balance	<p>Displays the encumbrance balance when commitment control is installed. When you create a purchase order, commitment control liquidates the pre-encumbrance balance from the requisition and establishes an encumbrance for the purchase order.</p> <p>You can view budget details for the purchase order. Click the Encumbrance Balance link to access the PO Accounting Entries Inquiry where you can select a General Ledger business unit and commitment control ledger group to use as a budget inquiry.</p> <p>See “Viewing Budget Details and Transaction Activity” (PeopleSoft Commitment Control).</p>
Currency	Displays the currency code for the encumbrance amount at the distribution level of the purchase order. The code is in the currency of the default commitment control ledger group for the distribution level General Ledger business unit.
Encumbered Base Balance	Displays the initial value of the encumbered balance.
Base Currency	When commitment control is on, the system displays whether this distribution has been budget checked.
Expensed To Date	Displays the amount reflects the total expensed to date, not the remaining expense balance. This creates a relationship to the encumbrance balance.
Commitment Control Close Flag	Displays as selected when the purchase order associated with the requisition has been fully liquidated, thus indicating that the outstanding pre-encumbrance has also been fully liquidated. This option can also display as selected when the distribution has been canceled.

Viewing Purchase Order Activity Summaries

The Purchase Order Activity Summary pages are used to view the receiving, invoicing, matching, and returning activities that were performed on the selected purchase orders to date. The Activity Summary page displays the total purchase order merchandise amount, and the merchandise received, vouchered, and matched.

If receiving is not required for the purchase order, the **Open Quantity** and **Open Amount** field values are updated upon calculation of the purchase order. This eliminates the need to manually calculate the values.

Note: The quantity received on the Activity Summary pages reflect the purchase order quantity. For example, if you order an item in one unit of measure, the received quantity will also reflect that same unit of measure.

This section lists the pages used to view purchase order activity summaries.

Pages Used to View Purchase Order Activity Summaries

<i>Page Name</i>	<i>Definition Name</i>	<i>Usage</i>
Activity Summary Page	ACTIVITY_SUMMARY	View the receiving, invoicing, matching, and returning activities that have been performed on the selected purchase orders to date.
Receipts inquiry Page	RECV_INQ	View additional information about the receipt document. Activity Summary Page
Review RTVs Page	RTV_INQ	View additional information about the return to vendor document.

Activity Summary Page

Use the Activity Summary page (ACTIVITY_SUMMARY) to view the receiving, invoicing, matching, and returning activities that have been performed on the selected purchase orders to date.

Navigation:

Purchasing > Purchase Orders > Review PO Information > Activity Summary

This example illustrates the fields and controls on the Activity Summary Page. You can find definitions for the fields and controls later on this page.

Activity Summary

Business Unit	US001	PO Status	Dispatched
Purchase Order	SUMMARYPO	Supplier	East Bay Travel
Merchandise Amount	100.00 USD	Supplier Location	1
Merchandise Receipt	0.00 USD		
Merchandise Returned	0.00 USD		
Merchandise Invoice	0.00 USD		
Merchandise Matched	0.00 USD		

Lines

1-1 of 1 | View All

Details | Receipt | Invoice | Matched | RTV | ||

Line	Item	Item Description	UOM	Mfg Item ID	UPN Type	UPN ID	Order Qty
1		SUMMARY PO	EA				10.0000

<i>Field or Control</i>	<i>Description</i>
UPN Type	Displays the UPN Type for the PO line.
UPN ID (Universal Product Number Identifier)	Displays the UPN ID for the PO line. The data for this field is populated from the referred PO line.

Viewing Purchase Order Document Tolerance Information

This section lists the pages used to view purchase order document tolerance information.

Pages Used to View Purchase Order Document Tolerance Information

<i>Page Name</i>	<i>Definition Name</i>	<i>Usage</i>
Document Tolerance Exceptions - Doc Tol Exception Page	DOC_TOL_EXCPT	View and update document tolerance exceptions.
Document Tolerance Override - Override Log Page	DOC_TOL_OVR_LOG	View and update document tolerance override history.

Reviewing Purchase Order Accounting Line Entries

You can review both standard entries and supplemental (Entry Event) entries when commitment control is enabled on the Installation Options - Products page.

This section discusses how to Review Purchase Order Accounting Line Entries:

Pages Used to Review Purchase Order Accounting Line Entries

<i>Page Name</i>	<i>Definition Name</i>	<i>Usage</i>
<u>Selection Criteria (for purchase order accounting line entries) Page</u>	PO_ACCTG_LN_SELECT	Select the criteria that you want to view on the Purchase Order Accounting Entries page. Filter criteria by purchase order range, business unit, fiscal year range, purchase order status, and ChartField combinations.
<u>Po Acctg Ln Lookup (purchase order accounting line lookup) Page</u>	PO_ACCTG_LN_LOOKUP	Review accounting line entries.

Selection Criteria (for purchase order accounting line entries) Page

Use the Selection Criteria (for purchase order accounting line entries) page (PO_ACCTG_LN_SELECT) to select the criteria that you want to view on the Purchase Order Accounting Entries page.

Filter criteria by purchase order range, business unit, fiscal year range, purchase order status, and ChartField combinations.

Navigation:

Purchasing > Purchase Orders > Review PO Information > PO Accounting Entries > Selection Criteria

This inquiry displays standard or supplemental (Entry Event) entries. You can also choose to view both types.

To properly generate entry event accounting entries, you should run the entry event generator process each time that you run the budget check process. When you run the entry event generator process more than once, it does not replace the existing entries. Instead, it creates a new set of entries for that transaction by increasing the unpost sequence number instead. The entire entry event history for a transaction appears on the PO Accounting Entries page. The values in the **Unpost Seq** (unpost sequence) field display every entry event post process.

Standard accounting entries are created by the budget check process. When you run the budget check process again, it deletes the existing entries for that transaction and recreates a new set of entries for that transaction, so the value in the **Unpost Seq** field is always 0 (zero) for the standard entries.

Field or Control	Description
Accounting Line View Option	<p>Select from these types of views:</p> <p><i>Standard</i>: Select to view standard accounting entries.</p> <p><i>Supplemental (Entry Event)</i>: Select to view Entry Event accounting entries.</p> <p><i>View Both</i>: Select to view both standard and supplemental accounting entries.</p> <hr/> <p>Note: If entry events are disabled, the options in this field are not available; however, you are still able to inquire on standard accounting entries.</p>
Ledger Group	<p>Select the ledger group for which you want to view accounting lines. The available options are defined at the business unit level. If a commitment detail ledger has been selected for that commitment control ledger group on the Ledgers For A Unit - Commitment Control Options page, the selected commitment control ledger group appears as the default ledger group here.</p>

Po Acctg Ln Lookup (purchase order accounting line lookup) Page

Use the Po Acctg Ln Lookup (purchase order accounting line lookup) page (PO_ACCTG_LN_LOOKUP) to review accounting line entries.

Navigation:

Purchasing > Purchase Orders > Review PO Information > PO Accounting Entries > Po Acctg Ln Lookup

Note: If you delete a distribution line after a budget-period change, values for that distribution line's Line, Schedule, and Distribution fields appear on this page with blank values.

Accounting Entries

Field or Control	Description
Purchase Order ID	<p>Click this link to access the Purchase Order Inquiry page, where you can view the supplier ID and other purchase order details.</p>
Trans Type (transaction type)	<p>Displays either a journal template or a source transaction. If it is a standard accounting entry, a source transaction appears. If it is an entry event accounting entry, a journal template appears.</p>

Field or Control	Description
Unpost Seq (unpost sequence)	Indicates the number of times that you have run the entry event generator process. For standard entries, the value is always <i>0</i> . For supplemental entries, the value is <i>0</i> the first time that you run the entry event generator process, <i>1</i> the second time, and so on.
Monetary Amount	Click this link to access the Commitment Control Activity Log page, where you can view basic activity information.
Encumbrance Balance	<p>Displays the encumbrance balance. When you use commitment control, the system deducts each type of financial obligation from the budget and tracks it according to obligation type. When you generate a requisition, a pre-encumbrance is created in your budget records by the budget-checking process. When a requisition is sourced to a purchase order, commitment control liquidates the pre-encumbrance from the requisition and establishes an encumbrance for the purchase order.</p> <p>You can view budget details for the purchase order. Click the Encumbrance Balance link to access the PO Accounting Entries Inquiry where you can select a General Ledger business unit and commitment control ledger group to use as a budget inquiry.</p>
Closed Value	<p>Indicates whether the transaction has been closed. Values are:</p> <p><i>Y</i>: Closed.</p> <p><i>N</i>: Open.</p> <p>When a transaction is closed, the budget processor liquidates all of its remaining unliquidated commitment control ledger amounts.</p>
Journal ID	<p>For standard entries, displays the journal ID.</p> <p>For supplemental entries, displays the commitment control ID.</p>
Reference Reversal ID	Displays the voucher ID associated with the reversal accounting entry lines.

Related Links

[Understanding Entry Events in PeopleSoft Purchasing](#)
[Purchase Order ChartField Approval Page](#)

“Understanding PeopleSoft ChartFields” (Application Fundamentals)
 “Viewing the Activity Log” (PeopleSoft Commitment Control)

Inquiring about Procurement Groups

The Procurement Group Inquiry page enables you to track a procurement group through requisitions, purchase orders, receipts, and vouchers.

Page Used to Inquire About Procurement Groups

<i>Page Name</i>	<i>Definition Name</i>	<i>Usage</i>
Procurement Group Inquiry Page	PO_GRP_DOC_INQ	View requisition lines, purchase order lines, receipt lines, and voucher lines that are linked to a specific procurement group.

Procurement Group Inquiry Page

Use the Procurement Group Inquiry page (PO_GRP_DOC_INQ) to view requisition lines, purchase order lines, receipt lines, and voucher lines that are linked to a specific procurement group.

Navigation:

Purchasing > Purchase Orders > Review PO Information > Procurement Group Inquiry

The Procurement Group Inquiry page enables you to view requisitions, purchase orders, and receipts that are linked to a specific procurement group.

<i>Field or Control</i>	<i>Description</i>
Procurement Group ID	Displays the unique number or letter combination that identifies a procurement group created in the Procurement Groups page and assigned to requisition and purchase order lines.
Primary Unit Item ID	Displays the item ID defined as the primary unit for this procurement group. You can identify the primary unit on the Procurement Groups page or on a transaction line.
Description Only Items	Selected if the primary unit is a description-only item. This check box is defined on the Procurement Groups page.

Transaction

The Transaction group box displays information about the requisitions, purchase orders, and receipts that are linked to this procurement group ID.

Field or Control	Description
Business Unit	Displays the PeopleSoft Purchasing business unit for the transactions.
Document Type	Identifies the transaction line as a requisition, purchase order, or receipt.
Document ID	Displays the requisition ID, purchase order ID, or receipt ID. Click this link to access an inquiry page with more information about the transaction
Line and Sched	Displays the line and schedule line of the requisition, purchase order, or receipt that contains the procurement group ID.
Item	Identifies the item ID in the transaction line and linked to the procurement group.
Qty	Displays the order quantity for a requisition or purchase order line and displays the receipt quantity for a receipt line.
Allocation Qty	Displays the quantity of this item needed to complete a primary unit in a procurement group; for example, four brackets per air conditioning unit. If this row is for the primary unit item and it is serial-controlled then this quantity is restricted to one. This field is only available for rows that have not selected the Amount Only check box. It is utilized during receiving and asset integration.
Open Qty	This field displays: <ul style="list-style-type: none"> • For a requisition, the item quantity not yet sourced. • For a purchase order, the item quantity not yet received. • For a receipt, the item quantity not yet interfaced with PeopleSoft Asset Management.
Primary Unit	Selected to identify this item as the main item for an item-grouping in a procurement group; for example, an air conditioning unit could be the primary unit in a procurement group to create a complete asset.

Field or Control	Description
Date	<p>This field displays:</p> <ul style="list-style-type: none"> • For a requisition, the request date. • For a purchase order, the due date. • For a receipt, the receipt date.
Sourced to Inventory	<p>Displays Y if the item was retrieved from the organization's inventory. This field displays N if the item was placed on a purchase order and obtained from a supplier. This field must have a value of N to be included in the interface to PeopleSoft Asset Management.</p>
Supplier	<p>Displays the supplier for the transaction line.</p>
Invoice Number	<p>Displays the invoice number for PeopleSoft Accounts Payable.</p>
Amount Only	<p>Selected to designate the line as an amount-only line. If selected, the Allocation Amt field is populated.</p>
Merchandise Amount	<p>Cost of the total number of items ordered.</p>
Currency	<p>Displays the currency of the Allocation Amt field. This field only displays if there is a value in the Allocation Amt field.</p>
Allocation Amt	<p>Displays the amount or price of this item needed to complete a primary unit in a procurement group; for example, 500 USD of installation services per air conditioning unit. This field is only available for amount-only transactions lines that have selected the Amount Only check box. It is utilized during receiving and asset integration.</p>
Open Amount	<p>For an amount-only transaction line, this field displays:</p> <ul style="list-style-type: none"> • For a requisition, the amount or price not yet sourced. • For a purchase order, the amount or price not yet received. • For a receipt, the amount or price not yet interfaced with PeopleSoft Asset Management.

Using Stockless Items

Understanding Stockless Items in PeopleSoft Purchasing

Items supplied as stockless are typically provided by a primary distributor in an expedited manner. These arrangements are negotiated with the supplier to provide rapid delivery of goods upon the supplier's receipt of the dispatched purchase order. The supplier does not manage backorders for unfulfilled quantities. In order to receive stockless items in this expedited manner, these types of purchase orders are automatically approved and immediately dispatched to the supplier. In turn, the items are delivered to the buying organization within the negotiated delivery window. You can create requests for stockless items through the PeopleSoft Purchasing online pages and background processes.

The item is considered stockless in PeopleSoft Purchasing transactions if you select the Stockless Item check box on the Purchasing Attributes - Purchasing Controls or the Item Supplier page. The replenishment code for stockless items is 02. For standard replenishment items, the replenishment code is 01.

Purchase orders can have both stockless and nonstockless items. A **Close Short** check box is available on purchase order lines. If the replenish code on the purchase order line has a value of *Stockless*, the **Close Short** check box for line is set to selected and cannot be changed.

You can change the **Close Short** check box to selected for purchase orders that contain nonstockless lines. This does not affect the value of the stockless setting and the replenish code. Receiving must be required for the purchase order line select **Close Short** the check box.

If you have PeopleSoft Inventory installed, you can use stockless items to replenish par locations. When the quantity for a stockless item in a par location falls below the optimal level, the PeopleSoft Inventory Create Par Replenishment Requests process (INPGCDMD) automatically stages a purchase order in PeopleSoft Purchasing from PeopleSoft Inventory. This purchase order requires no approval processing.

Requisition requests are created in multiple places in PeopleSoft Inventory and picked up by the Purchasing Requisition Loader process (PO_REQLOAD). The Requisition Loader process marks the distribution lines that it creates based on whether the item is stockless or standard. For ad hoc replenishment requests, the replenishment code is standard (01) by default and needs to be validated.

When the distribution lines loaded by the Requisition Loader are processed from the stage tables by the PO Calculations process (PO_POCALC), standard items and stockless items are not placed on the same purchase order. This supports backward compatibility for prior releases of PeopleSoft Purchasing. However; you can combine standard and stockless items on a single purchase order using the Add/Update component. Stockless item purchase orders that you create using the PO Calculations process and Create Purchase Orders process (PO_POCREATE) are created in *Approved* status, and do not require approval processing.

The PO Dispatch/Print process (POPO005) includes information about whether the replenishment option for the item is stockless or standard.

Related Links

[Creating Purchase Order Distributions](#)

[Creating Requisition Lines](#)

[Capturing Item Miscellaneous Charges](#)

[Running the PO Calculations Process](#)

[Creating Purchase Orders Using the Create Purchase Orders Process](#)

[Requisition Loader Page](#)

Receiving Shipments

Understanding the Receiving Business Process

PeopleSoft Purchasing provides components that enable you to receive goods, create receipts, and enter receiving details. These components facilitate the tracking of receipt information such as distributions, assets, and serial IDs.

Receiving goods using PeopleSoft Purchasing can make the transfer of receipt information to PeopleSoft Inventory, PeopleSoft Asset Management, and PeopleSoft Manufacturing virtually seamless.

The PeopleSoft Purchasing receiving business process enables you to receive, inspect, return, and put away received goods. Receiving rules are defined in the business processes leading up to the actual receipt. These processes include setting up items and creating requisitions and purchase orders.

When stock arrives at the receiving location, you receive it using the PeopleSoft Purchasing Receiving component. You can receive inventory or non-inventory items, with or without associated purchase orders. Direct ship orders are not eligible for receiving in PeopleSoft Purchasing, because they are normally sent directly to a customer site and received there.

Here is the basic flow of the receiving business process:

1. Create receipts using online pages or batch processing.
 - Use the online Maintain Receipts - Receiving page to receive, accept, and reject shipment quantities. You can use this page to receive items with associated purchase orders or without associated purchase orders, as well as maintain existing receipts.
 - Use the Receive Load process (PO_RECVLOAD) to load batches of purchase order receipt information gathered using electronic data collection (EDC) and ASR EIPs, and, if your installation includes PeopleSoft eSupplier Connection, supplier-entered advanced shipping notices (ASNs).
2. If the stock is to be tracked as an asset, enter asset information, including serial, asset IDs, and asset tag information, using the Asset Management Information page.
3. Enter override putaway information for the stock using the Inventory Putaway Information page.

You can also use this page to enter serial ID and lot ID information.

4. Use the Inspection page to inspect the stock, if inspections are performed as a separate business process in the organization.

In this case, the **Insp Qty** field on the Maintain Receipts - Receiving page is unavailable for entry during the receiving transaction, and received stock is putaway to an inspection location where you will perform the inspection process.

If the organization performs inspections as a separate business process, you can enter override putaway information using the Inspection & Putaway Information page.

Note: If this is how you want the receiving agents to process shipments and receipts, you must select the **Separate Inspection** check box when setting up the purchasing definitions on the Purchasing Definition - Business Unit Options page.

5. Use the Delivery component to view and enter delivery details about the receipt for non inventory transactions.
6. Use the Receipt ChartFields - ChartFields page to view and enter distribution detail overrides for the receipt.
7. Use the Return to Vendor - RTV page to create and enter details for an RTV.

If you are already using the Inspection page, you may use the RTV Setup page to create the RTV without having to leave the component. However, to modify RTV detail information, you must be on the Return to Vendor - RTV page.

8. Use the Receive Interface Push process (PO_RECVPUSH) to transfer receipt information to the staging interface tables for use by the inventory putaway process, asset load process, and manufacturing routing process.

In conjunction with the process, the system can launch the Close Short process. If the **Run Close Short** check box is selected when the receipt is saved, and one or more of the receipt lines have the **Close Short** check box selected, the system calls the Close Short process when it runs the Receipt Push (PO_RECVPUSH) process. The Receipt Push process deselects the **Run Close Short** check box on the receipt header after the Close Short process has run.

The creation of receipt-landed cost transactions is another function performed by the PO_RECVPUSH process.

9. Use the Close Receipts process (PO_RECV_COM) to close receipt that have been interfaced to assets, inventory, or manufacturing (if required) and matched (if required).

Related Links

[Closing Receipts](#)

[Asset Management Information for Line Page](#)

[Inventory Putaway Information for Line Page](#)

[Maintain Receipts - Receiving Page](#)

[Receiver Load Page](#)

[Receiving Items Using EDC](#)

[Using the Receiver Interface Push Application Engine Process \(PO_RECVPUSH\)](#)

[Establishing PeopleSoft Purchasing Business Units](#)

[RTV Setup Page](#)

[Inspection Page](#)

[Inspection & Putaway Information Page](#)

[Entering RTV Transactions](#)

[ChartFields Page](#)

[Understanding Delivery Information](#)

“Processing Inbound EIPs” (PeopleSoft Supply Chain Management Integration)

Defining Receipt Statuses

Receipt statuses are maintained at the receipt header, line, and distribution levels. After you've entered the receipt header information, selected the purchase order lines and schedules to be received, entered the quantities, updated pertinent asset information, input putaway information, and saved the receipt, the save time editing on the receipt adjusts the appropriate receipt statuses.

Receipt Header Status Values	Status Definition
<i>Open</i>	Not all edits have passed. One or more receipt lines are in <i>Open</i> status.
<i>Received</i>	All edits have passed. All lines are in <i>Received</i> or <i>Canceled</i> status.
<i>Hold</i>	Receipt is on hold until released by user.
<i>Moved</i>	Receipt has been processed by RECV PUSH, which creates the landed cost transactions for new receipts, and may interface them to PeopleSoft Asset Management, PeopleSoft Inventory, or PeopleSoft Manufacturing.
<i>Closed</i>	All receipt lines have been moved and matched (when required). All interface requirements have been fulfilled and no further processing is required.
<i>Canceled</i>	All lines are canceled. Canceling cannot be reversed.

Receipt Line Status Values

At the line level, the status changes to *Received* only when all exceptions for the line have been addressed. This means that serializations have been completed and lot-control information has been provided. If the exceptions have not been addressed, the affected lines remain in *Open* status.

Only when all lines on the receipt have a status of *Received* does the receipt header have a status of *Received*. If any receipt lines have a status of *Open*, the receipt header has a status of *Open*.

Using Quantity Tolerances

When you save the Maintain Receipts - Receiving page, the system checks for over shipments of items for which the **Reject Quantity Over Tolerance** check box is selected on the purchase order schedule.

PeopleSoft Purchasing takes into consideration the purchase order schedule quantity, the current receipt quantity, and any quantity previously received for the purchase order schedule. When the quantity previously received, plus the current receipt quantity is greater than the purchase order quantity, the difference is compared to the value in the **Qty Rcvd Tolerance %** (quantity received tolerance percent) field, specified on the Purchase Order Schedule page.

When the tolerance percent is exceeded, the **Qty Status** (quantity status) field on the Line Status Details page is set to *Over Shipment*, and the system displays a message indicating a quantity not within tolerance. The tolerance check uses the accepted quantity, which is derived by subtracting the reject quantity from the received quantity.

The system performs this kind of edit for dates, serialization, and lot control, as well. You can save the receipt even if the appropriate action has not been taken. The line status remains *Open* until the serial and lot statuses have been completed and any other necessary adjustments have been made.

Related Links

[Maintain Receipts - Receiving Page](#)

[Maintain Receipts - Receipt Line Details for Line Page](#)

Using Shipment Date Edits

On the Purchasing Attributes - Purchasing Controls page, you can specify, at the item level, the number of days a receipt can vary from the scheduled due date indicated on the purchase order. If the receipt date is prior to the due date of the purchase order schedule minus this tolerance value, then the receipt line is identified as early. If the receipt date is past the due date of the purchase order schedule plus this tolerance value, then the receipt line is identified as late.

Using Partial Receipt Edits

Use the **Partial Qty** field on the Purchasing Attributes - Purchasing Controls page to specify the preference for how partial shipments are handled by PeopleSoft Purchasing. You can specify that you want to be able to accept partial shipments when receiving items. Valid options, as well as how they are handled by the system during receipt, are explained in the following table:

<i>Partial Receipt Flag Value</i>	<i>Result when Partial Quantity is Received</i>
<i>Recvd</i> (received)	No error and no warning are issued. Line status is set to <i>Received</i> .
<i>Recvd/Warn</i> (received/warning)	Warning message is issued. Line status is set to <i>Received</i> .
<i>Open</i>	No error and no warning are issued. Line status set to <i>Open</i> .
<i>Open/Warn</i> (open/warning)	Warning message is issued. Line status set to <i>Open</i> .
<i>Error</i>	Shipment cannot be received. Error message is issued. Line status set to <i>Open</i> .

Using Directed Putaway

Directed putaway is a method of putting away stock that helps optimize available storage space. Implementing directed putaway can also enable you to create more logical putaway plans. In designating stock for directed putaway, you can select very specific rules about the way in which stock should be put

away, such as according to volume and weight constraints. In addition, you can specify that similar items be stored together or that certain materials always be stored in the same area of the warehouse.

In PeopleSoft Receiving, you use the Directed Putaway Locations page to confirm default directed putaway information for an item or override the existing default rules.

Related Links

[“Calling Directed Putaway” \(PeopleSoft Inventory\)](#)

Prerequisites

Before you receive items on PeopleSoft Purchasing pages, you must:

- Provide users with the authority to enter receipt and inspection information.
- Define any necessary business rules and default values related to the receiving process.
- Establish the Interface Receipts defaults.

Related Links

[Establishing PeopleSoft Purchasing Business Units](#)

Common Elements Used in Receiving Shipments

<i>Field or Control</i>	<i>Description</i>
Area/Storage Area	<p>Identifies the segment of the warehouse in which this item is to be stored. If the item being received requires inspection, the chosen area must be associated with an inspection location.</p> <p>The available values that appear in the override storage location fields (Area/Storage Area and Lev 1 - 4) vary depending on the distribution's consigned and non-owned item values.</p> <ul style="list-style-type: none"> • If the item is owned, only owned storage locations appear. • If the item is non-owned and not consigned, both owned and non-owned storage locations appear. • If the item is received as non-owned and consigned, only non-owned storage locations appear.

Field or Control	Description
Distribute by	Value by which the line is to be distributed. If the material is being received by amount only, the default distribution method is <i>Amt</i> . <i>Qty</i> (quantity): Designates that the line is to be distributed by quantity. <i>Amt</i> (amount): Designates that the line is to be distributed by amount.
Dist Seq (distribution sequence)	Distribution sequence number associated with the selected asset or putaway row. These numbers are assigned to detail rows on the putaway, asset, manufacturing, and device tracking pages. These values can be greater than 1 if multiple lot numbers, serial IDs, or tag numbers exist.
IN Unit (inventory business unit)	Inventory business unit for the distribution. For non-purchase order receipts, this value appears by default from the ship to location. For purchase order receipts, this value appears by default from the purchase order distribution.
Lev 1 - 4 (level 1 - 4)	Identifies the next levels of storage within the storage area location.
PO Receipt	This check box is selected and unavailable when the receipt is purchase order-related. The check box is clear and unavailable when the receipt is non-purchase order-related.
Recv UOM (receiving unit of measure)	The receiving unit of measure.
Std UOM/Standard Unit of Measure	Unit of measure that reflects the most common unit of management for the item.
Stock UOM (stocking unit of measure)	Unit of measure used to put away stock. The stocking UOM is used to stock quantities in a UOM other than the standard UOM. You cannot change the stocking UOM for an item once the stock has been put away in PeopleSoft Inventory. Note: If you change the stock UOM, and the UOM conversion option selected for the item on the Business Unit Item Definition - Inventory: Shipping/Handling page is set to any value other than <i>Use Entered UOM</i> , continuing with the change limits the ability of certain batch functions to process the transaction. This includes functions such as the auto move of goods from an inspection location to a non-inspection location.
Vndr UOM (supplier unit of measure)	Item unit of measure assigned by the supplier and used on the purchase order line.

Receiving Purchase Order Items

To take advantage of the purchasing authorizations established during the requisition and purchasing process, goods and services received need to be referenced against a purchase order.

Steps in receiving a shipment against a purchase order might include:

- Selecting the purchase order.
- Receiving and rejecting shipment quantities.
- Viewing purchase order comments on receipt lines.
- Viewing receipt lines.
- Entering receipt header and line comments.
- Entering asset information.
- Entering receipt activities.
- Entering inventory putaway information.
- Entering serial, lot, and tag information.
- Entering device-tracking information.

Not all of these actions are required for every purchase order receipt. It depends on the items received and the method of receiving.

Receiving Non-Purchase Order Items

A non-purchase order receipt can be interfaced to the same products as a purchase order receipt, with the exception of PeopleSoft Manufacturing subcontracts, which must be received with a purchase order. Some information that would be copied from the purchase order for a purchase order receipt must be entered or selected when entering a non-purchase order receipt, while other information appears by default.

You add a non-purchase order receipt line on the Maintain Receipts - Receiving page in Add mode. You must complete the **Supplier ID**, **Supplier Location**, and **Ship To Location** fields in the Header section of the Maintain Receipts - Receiving page before entering other non-purchase order receipt information on the Maintain Receipts - Receiving page.

You can enter an item ID for the receipt line or, if you have the authority, a description of the item and category ID. If you have the authority to change a non-purchase order receipt price, you can enter just a description for the item that you want to receive and an associated category and you can also change the price associated with the item until the receipt line has been moved to PeopleSoft Inventory, moved to PeopleSoft Asset Management, or a voucher has been partially or fully matched in PeopleSoft Payables.

When you change the price of the description only item, the new price will be used to recalculate transaction and base merchandise amounts for the receipt line.

After you establish this part of the receipt, apply the expense portion of the receipt to the appropriate account by selecting the general ledger unit, account, department number, and distribution quantity on the Receipt Distributions for Line page.

Receipt lines with associated purchase orders cannot be added to non-purchase order receipts.

Related Links

[Maintain Receipts - Receiving Page](#)

[Maintain Receipts - Header Details Page](#)

[Maintain Receipts - Receipt Distributions for Line Page](#)

Receiving Items by Amount

You can receive items by amount rather than quantity. In some cases, receipt quantities for services may be difficult to calculate, whereas receipt amounts for services may be more easily calculated over the life of a purchase order or contract. As phases of the job are completed, you can receive and pay for services in partial amounts, rather than in quantities. This functionality also enables partial receipts, which accommodates the possibility that it may take several receipts to complete a service or project worth a large monetary amount.

When the **Amount Only** check box is selected on the associated contract or purchase order, the quantity field for the transaction is set to *1* and made unavailable for entry. The amount of the transaction row is entered in the price field. For amount-only transaction lines, the open amount and prior received amount are calculated instead of the open quantity and prior received quantity.

The distribution method for amount-only transactions is always by amount.

Amount Only transactions are always associated with a purchase order and cannot be an inventory-related transaction (targeted for an inventory business unit). The Amount Only functionality is not available for non-purchase order transactions, barcode receiving, inspections, and returns to vendor.

Managing Receipts

This section discusses how to Manage Receipts

Pages Used to Manage Receipts

<i>Page Name</i>	<i>Definition Name</i>	<i>Usage</i>
<u>Select Purchase Order Page</u>	PO_PICK_ORDERS	Search for and retrieve purchase order schedules against which to create receipts. Select the PO Receipt check box before entering the Select Purchase Order page. This page is not available when creating a receipt for non-purchase order items.
<u>Maintain Receipts - Receiving Page</u>	RECV_WPO	Create receipts for non-purchase order and purchase order line items.
Item Description Page	RECV_ITEM_DESCR, RTV_ITEM_DESCR_FS, PO_PICK_IT_DESCR	Enter and view descriptions for a specific item.
<u>Maintain Receipts - Header Details Page</u>	RECV_WPO_HDR	View and enter receipt header information.
Maintain Receipts - Receipt Header Comments Page	RECV_COMMENTS_SEC	View and enter comments for the receipt header level.
Maintain Receipts - Activities Page	RECV_ACTIVITY_SEC	Enter information that pertains to the receipt activity. You can use this page to record comments, due dates, and activity status.
Receipt DOC Status Page	PRCR_DOCSTAT_INQ	Access and review information about procurement documents associated with a receipt.
<u>RTV Information Page</u>	RTV_LN_DISP_SEC	View details about any RTV transactions created for the selected receipt.
<u>Accrue Receipt Page</u>	RUN_RECVACCR_OL	Run the Receipt Accrual process, the Miscellaneous Charges process, or both.
<u>Maintain Receipts - Receipt Line Details for Line Page</u>	RECV_WPO_DETAILS	View receipt line item details.

Page Name	Definition Name	Usage
<u>Asset Management Information for Line Page</u>	RECV_WPO_AM	View and enter information about asset purchases. This information is passed to PeopleSoft Asset Management. This page is available for entry only if the selected receipt is targeted for PeopleSoft Asset Management. One or more of the distributions must have a PeopleSoft Asset Management business unit and AM profile designated, and optionally, other asset management data.
<u>Inventory Putaway Information for Line Page</u>	RECV_WPO_PUTAWAY	View and enter overriding information used to put items away in inventory business unit storage locations. This page is available only if the receipt line is targeted for inventory (one or more of the distributions must have an inventory business unit assigned). This is applicable to purchase order and non-purchase order receipts.
Device Tracking Page	RECV_WPO_DEVICE	View and enter serial/component and lot/batch information. This page is only accessible for items that have been flagged for device tracking. This option is only available if you select device tracking for the receipt line. The device tracking value appears by default from the Item Master table.
Receipt Line Comments Page	RECV_COMMENTS_SEC	View and enter comments and attachments for the receipt line.
<u>Maintain Receipts - Receipt Distributions for Line Page</u>	RECV_WPO_DIST	View distribution information for the selected receipt.
PO Distribution Details Page	RECV_WPO_PO_DIST	View purchase order distribution information.
<u>Maintain Receipts - Manufacturing Information for Line Page</u>	RECV_WPO_MFG	Maintain manufacturing information for the receipt line.
<u>Inventory Item Information Page</u>	RECV_INV_ITEMS_SP	View detailed inventory information entered for an inventory-related item.

Page Name	Definition Name	Usage
<u>Storage Location Search Page</u>	RECV_STOR_LOC_SRCH	Search available storage locations for the material that you are receiving.
Putaway Locations Page	IN_PTWY_LOC_SP	Define directed putaway information for receipt items. This button is active only if you have enabled Directed Putaway for the business unit and defined putaway rules on the Putaway Rules page.
<u>Maintain Receipts - PRO Numbers Page</u>	RECV_WPO_PRO	Add receipt progressive numbers.
<u>PO Comments Page</u>	RECV_PO_LN_COMMENT	View purchase order header, line, and ship to comments for the associated purchase order line or purchase order schedule levels.
Pegging Workbench Page	IN_PEG_DETAIL_SP	View the pegging information.
Pre-AM 1 Page	INTFC_PRE_AM_01	Preview data in the Pre-Interface Pre-AM 1 table. You can correct information in the fields that are available for data entry.
Purge ASN History Page	RUN_PO_ASN_PURGE	To purge the EC rows when transaction is complete

Select Purchase Order Page

Use the Select Purchase Order page (PO_PICK_ORDERS) to search for and retrieve purchase order schedules against which to create receipts.

Select the PO Receipt check box before entering the Select Purchase Order page.

Navigation:

- Purchasing, Receipts, Add/Update Receipts, select a purchase order
- Click the **Select Purchase Order** link on the Maintain Receipts - Receiving page.

This example illustrates the fields and controls on the Select Purchase Order page. You can find definitions for the fields and controls later on this page.

Select Purchase Order

Search Criteria

PO Unit <input type="text" value="US001"/>	Days +/- Today <input type="text" value="30"/>
ID <input type="text"/>	Start Date <input type="text" value="08/29/2018"/>
Line / Schedule <input type="text"/> / <input type="text"/>	End Date <input type="text" value="10/28/2018"/>
Release <input type="text"/>	Supplier Name <input type="text"/> Supplier Lookup
Item ID <input type="text"/>	Supplier Item ID <input type="text"/>
Ship To <input type="text" value="US001"/>	Manufacturer ID <input type="text"/>
Ship Via <input type="text"/>	Manufacturer's Item ID <input type="text"/>
<input checked="" type="checkbox"/> Retrieve Open PO Schedules	UPN ID <input type="text"/>

Receipt Qty Options

No Order Qty
 Ordered Qty
 PO Remaining Qty

Retrieved Rows Personalize | Find | View All | First | 1-5 of 7 | Last

Sel	PO Unit	PO ID	Line	Sched	Release	Due Date	PO Qty	Prior Receipt	Item	Description
<input type="checkbox"/>	US001	0000001328	1	1	1	08/30/2018	1.0000		10002	Long Sleeve T-Shirt, Mens
<input type="checkbox"/>	US001	0000001331	1	1	3	08/30/2018	1.0000		10002	Long Sleeve T-Shirt, Mens
<input type="checkbox"/>	US001	0000001332	1	1	1	08/30/2018	1.0000		10002	Long Sleeve T-Shirt, Mens
<input type="checkbox"/>	US001	0000001353	1	1	1	09/02/2018	1.0000		10002	Long Sleeve T-Shirt, Mens
<input type="checkbox"/>	US001	0000001375	1	1	1	09/04/2018	1.0000	1.0000	10030	Folding Child Trailer

Select All
 Clear All

Note: This page is only available if you select the **PO Receipt** check box on the Add/Update Receipt dialog box.

The search functionality of this page enables you to perform a broad or narrow search on purchase orders based on a variety of search criteria. You can use one or all of the available fields. After the search retrieves a list of purchase order line and schedules that meet the search criteria, you can select the purchase order line and schedules and have the system place them on the transaction document.

Field or Control	Description
PO Unit (PeopleSoft Purchasing business unit)	Select the business unit.
ID	Enter the purchase order number or purchasing contract number. Entering a contract ID retrieves all of the purchase order schedules associated with the contract. Note: The open purchase order schedules is controlled by the Retrieve Open PO Schedules check box.
Line and /Sched Num (schedule number)	Enter the purchase order line and schedule numbers.
Release	Enter the release number of the contract associated with the item, if applicable.

Field or Control	Description
Retrieve Open PO Schedules	Select this check box to retrieve only purchase order schedules that haven't been fully received. If you do not select this check box, purchase orders that have been fully received appear in the search, as well as purchase order schedules that haven't been fully received.
Days +/- Today	Enter a value to further restrict or expand the number of purchase order schedules that appear within the start date and end date values. This value is added or subtracted from the current date to calculate the start date and end date values. The default value appears from the User Preferences - Procurement: Receiver Setup page. You may also enter the start date and end date. The system will select all schedules whose due date falls on or between the two dates.
Start Date and End Date	Used as a comparison against the purchase order due date to determine which schedules are retrieved. These values appear by default to the current date plus or minus the value in the Days +/- Today field.
UPN ID (Universal Product Number Identifier)	Enter a UPN ID, which is one of the search criteria to retrieve the PO Line.

Receipt Qty Options

Select **No Order Qty** (no order quantity), **Ordered Qty** (ordered quantity), or **PO Remaining Qty** (purchase order remaining quantity) to determine the receipt quantity to appear. These fields specify quantities to transfer to the receipt. Accessibility to these fields is determined by the user's blind receipt authorization set on the User Preferences - Procurement: Receiver Setup page.

Field or Control	Description
No Order Qty (no order quantity)	Select this option to signify that the receiver must enter the actual quantity received. This selection requires a live count of the items prior to receipt in the system. If selected, the copy function does not transfer order quantities to the receipt. You will need to manually enter all receipt quantities.
Ordered Qty (ordered quantity)	Select this option to automatically make the received quantity the purchase order quantity. This selection makes the receipt quantity the purchase order quantity regardless of any prior receipt quantity.
PO Remaining Qty (purchase order remaining quantity)	Select this option to have the receipt display the numeric difference between the quantity ordered and the current quantity received. Selecting this option replaces the received quantity with the quantity that has not yet been received.

<i>Field or Control</i>	<i>Description</i>
Search	Click this button to display purchase order lines and schedules that match the entered criteria in the Retrieved Rows group box.

Retrieved Rows

In this group box, all the purchase order lines and schedules that match the search criteria appear.

Selected Rows

<i>Field or Control</i>	<i>Description</i>
Sel (select)	Click this check box next to a purchase order line to work with a particular line. You can select multiple schedules at once when this page is accessed from the Maintain Receipts - Receiving and Return To Vendor pages.
Prior Receipt	Displays the number of items already received.

Shipping Related

Select the **Shipping Related** tab.

<i>Field or Control</i>	<i>Description</i>
Orig Prom (original promise date)	This values appears by default from the purchase order schedule and contains the purchase order schedule original due date.

More Details

Select the **More Details** tab.

<i>Field or Control</i>	<i>Description</i>
UPN Type	Displays the UPN Type for the PO line.
UPN ID	Displays the UPN ID for the PO line.

Field or Control	Description
PO Amount (purchase order amount)	Displays the monetary value of the merchandise on the selected purchase order line.
Recv Reqd (receiving required)	<p>Displays whether receiving is required for this item. Values are:</p> <ul style="list-style-type: none"> • <i>Y</i>:Receiving is Required. • <i>N</i>:Receiving is Optional. • <i>X</i>:Do not receive. <p>If receiving is required, the item is subject to any receiving tolerances defined for the item.</p>
Recv Tol % (receiving tolerance percentage)	If tolerance is activated for the receipt of this item, the tolerance percentage appears. This percentage determines how much of an over shipment is allowed without having to reject items.
Price	Displays the unit price of the item on the selected purchase order line.

Related Links

[Using ASRs](#)

[Maintain Receipts - Receiving Page](#)

[Receiver Load Page](#)

[Entering RTV Transactions](#)

Maintain Receipts - Receiving Page

Use the Maintain Receipts - Receiving page (RECV_WPO) to create receipts for non-purchase order and purchase order line items.

Navigation:

- (PO receipt) Select a purchase order line on the Select Purchase Order page and click the **OK** button.
- **(non-PO receipt) Purchasing > Receipts > Add/Update Receipts > Maintain Receipts - Receiving**

This example illustrates the fields and controls on the Maintain Receipts - Receiving Page. You can find definitions for the fields and controls later on this page.

Note: If a supplier sent you ASR information using electronic data exchange and the receipts have already been created by the Receive Load process, the receipt information appears in the scroll area for your review in Update/Display mode.

Field or Control	Description
Header Details	Click this link to access the Maintain Receipts - Header Details page. Use this page to view and enter receipt header information.
Receipt Status	Status of the receipt header. Values are: <i>Closed</i> (closed receipt) <i>Hold</i> (hold receipt) <i>Moved</i> (moved to destination) <i>Open</i> (open) <i>Received</i> (fully received) <i>Canceled</i> (canceled)
	Click the Cancel Receipt button to cancel the entire receipt. Canceling the transaction cannot be reversed.
Add/Edit Comments	Click the Add Comments link to access the Maintain Receipts - Receipt Header Comments page. Use this page to add header level comments that will be associated with this receiver ID. Once comments are added, the link will be displayed as Edit Comments. Click the link to add additional header level comments or to review existing ones.

<i>Field or Control</i>	<i>Description</i>
Activities	Click this link to access the Maintain Receipts - Activities page. Use this page to add or review activities associated with the receipt header.
Document Status	Click this link to access the Receipt DOC Status page. Use this page to review information about procurement documents associated with the receipt.

Header

<i>Field or Control</i>	<i>Description</i>
Supplier ID, Supplier Location, and Ship To Location	<p>Select the supplier ID, supplier location, and Ship To location for the non-purchase order receipt item. These fields must be entered before you can continue with a non-purchase order receipt.</p> <p>For purchase order receipts these fields are display only and appear by default from the purchase order.</p>

Field or Control	Description
<p>Close Short All Lines</p>	<p>Click to select the Close Short check box for all eligible receipt lines in the Receipt Lines grid box. Then, you can click the Run Close Short check box at the bottom of the page to initiate the closing of purchase orders at the time of receipt.</p> <p>If the Run Close Short check box is selected when the receipt is saved, and one or more of the receipt lines have the Close Short check box selected, the Receipt Push process (PO_RECVPUSH) process calls the Close Short (PO_CLSSHORT) process. The Receipt Push process deselects the Run Close Short check box after the Close Short process has run. You can also run the Close Short process using the Close Short menu option.</p> <p>You can also include receipts created using mobile devices when the Close Short process is run. When you save the receipt in the Mobile Inventory Management application and the Receipt Push process runs, the process calls the Close Short process to create the close short transactions for the purchase orders included in the receipt.</p> <p>See “Understanding How to Receive Stock in PeopleSoft Inventory Using Mobile Receiving” (PeopleSoft Mobile Inventory Management).</p> <p>You select the Run Close Short check box on the User Preferences Receiver Setup page to provide users with permission to close a purchase order.</p>
<p>Print Delivery Report</p>	<p>Click this button to save the currently entered receipt information and initiate the RECV_DEL multi-process job in the same business event. The RECV_DEL multi-process job contains the Receipt Delivery (PO_RECVDLV) application engine process that gathers data for the Receipt Delivery Detail report (receiving data along with purchase order header and line comments) and the Receipt Delivery Detail (POY5030) report that produces a report from the gathered information.</p> <hr/> <p>Note: This job can also be activated from a mobile device using the Mobile Inventory Management application.</p> <hr/> <p>See “Understanding How to Record Deliveries in PeopleSoft Purchasing Using Mobile Inventory Management” (PeopleSoft Mobile Inventory Management).</p>

Field or Control	Description
Run PO Receipt Accrual	<p>Click this button to access the Accrue Receipt page where you can run the Receipt Accrual process, the Miscellaneous Charges process, or both. The button is only available if the receipt has been saved and is eligible for accrual.</p> <hr/> <p>Note: An error will appear if <i>Do Not Generate Reversal</i> is not selected as the reversal code on the Journal Generator Template.</p> <hr/>
Select Purchase Order	Click this link to access the Select Purchase Order page. Use this page to search for and retrieve purchase order schedules against which to create a receipt.

Receipt Lines

Receipt lines display in this group box for the purchase order lines selected on the Select Purchase Order page.

Field or Control	Description
	Click the Details button to access the Receipt Line Details for Line page, where you can view details about the receipt. This page formats the information you see here and on the subsequent tabs in a single long page format.
Description	If you are receiving against a purchase order, the item selected and its description will be displayed. If you are entering a non-purchase order receipt, you can enter an existing item ID and a description and category will be displayed. If you have the authority to change a non-purchase order receipt price, you can enter just a description for the item you are receiving. After you enter the description for the item, the Category field is available for entry.

Field or Control	Description
	<p>This icon appears on a transaction line whenever the ‘Original Substituted Item field’ is populated. This indicator helps the Requester or Buyer to know whether the item has been substituted. If Original Substituted Item and Description are already displayed in the component, i.e. Requisition and PO, a text ‘Substitute Item in Use’ and the Original Substituted Item and Description fields will appear.</p> <p>If the Original Substituted Item and Description fields are not displayed anywhere in the component, click on the icon to view another page displaying these values</p>
<p>Original Substituted Item and Description</p>	<p>The ‘Original Substituted Item’ field displays the original Item ID on the transaction line that was replaced when a Substitute Item was found. Once the field is populated, the original Item ID will not be overridden with another Item ID</p> <p>If the Item ID field is changed directly by the Requester or Buyer, the ‘Original Substituted Item’ field is cleared out. Similarly, if the Supplier ID/Location field is changed by the Requester or Buyer, then the value in the ‘Original Substituted Item’ field is cleared and the value is moved back to the Item ID field</p> <p>These fields are displayed from the Requisition through to the PO. However, these fields do not appear in case of online update by the Requester or Buyer. The Original Substituted Item Description field displays the Item Description for the Original Substituted Item, if the field is populated</p> <p>When using ‘Copy From’ to copy a Requisition into a new Requisition or a Purchase Order into a new Purchase Order, the ‘Original Substituted Item’ for each transaction line is cleared out and the value is moved back to the Item ID field. When using ‘Copy From’ to copy a Requisition into a Purchase Order, values remain the same</p>

Field or Control	Description
Receipt Price	<p>When an item is received against the purchase order, the item's purchase order price is displayed in the receiving unit of measure. If you are entering a non-purchase order receipt and have specified an item ID, the item's purchasing item attributes price is displayed. If you have the authority to change a non-purchase order receipt price, you can make modifications here. Additionally, if you entered a description only item, you would enter the price here.</p> <p>When the price is changed the new price will be used to recalculate transaction and base merchandise amounts on the receipt line.</p> <hr/> <p>Note: The item description, price, and category will no longer be available for modification once the non-purchase order receipt line has been moved to inventory, moved to assets, or accounts payable matching has fully or partially matched a voucher.</p> <hr/>
Receipt Qty (receipt quantity) and Recv UOM (received unit of measure)	<p>Enter the quantity delivered and the UOM in which it was received. When you enter the receipt quantity for a line, the Accept Qty value is calculated by subtracting the rejected quantity from the receipt quantity.</p> <p>If you are using the supplier rebate functionality, you can still change the receipt quantity that was previously entered, even if there are accrued rebate transactions tied to this receipt with a vendor rebate claim. However, in this case the rebate accrual transaction won't be recalculated but a workflow and/or email notification will be sent to the rebate manager. After reviewing the changes, the rebate manager must decide whether manual actions, such as adjusting the subsequent claim amount, is required. If there are no accrued rebate transactions you can change the receipt quantity and the Rebate Accruals process will recalculate the rebate accrual transaction.</p>
	<p>Click the Copy quantity down button to enter the same Receipt Qty (received quantity) value on the selected line to all Receipt Qty fields for all subsequent lines.</p>
Accept Qty (accepted quantity)	<p>Displays the quantity of items accepted. When you enter a Receipt Qty value for a line, the accepted quantity is calculated by subtracting the rejected quantity from the receipt quantity.</p>

Field or Control	Description
Status	<p>Displays the status of the receipt line.</p> <p><i>Closed</i> (closed schedule)</p> <p><i>Hold</i> (hold schedule)</p> <p><i>Open</i> (open schedule)</p> <p><i>Received</i> (received schedule)</p> <p><i>Canceled</i> (canceled schedule)</p>
Category	<p>If you have entered a description only for a non-purchase order receipt line item, select the category to associate with the item.</p>
Close Short	<p>Select to indicate that you want to include this receipt line when the Close Short process is run. When you select the Run Close Short check box and if one or more receipt lines are selected, the Receipt Push process calls the Close Short process to create the close short transactions for the purchase orders. After the Close Short process is run, the system deselects the Run Close Short check box. To select all eligible receipt lines, click the Close Short All Lines button on the receipt header.</p>
Serial	<p>Identifies if the receipt line is serial controlled. If you are receiving a description-only purchase order line (no item ID) and the line is asset-related, the serial check box can be selected. For serial-controlled items, you must enter the serial ID at the time of receipt or the receipt line status stays in the <i>Open</i> status and is not eligible for interfacing to inventory or assets.</p>
Device Track	<p>Indicates whether a receipt line is device tracked. The default value is selected and unavailable for device-tracked items unless they are description only (no item ID). The field is available for items that are description only.</p>

Field or Control	Description
AM Status (asset management status)	<p>Displays the status of the item data in relation to PeopleSoft Asset Management. Values are:</p> <p><i>Pending:</i> Indicates that the receipt line is asset-related and is pending interface with PeopleSoft Asset Management. Click the link to access the Asset Management Information for Line page where asset information can be recorded.</p> <p><i>Moved:</i> Indicates that the receipt line has been interfaced to PeopleSoft Asset Management.</p> <p>If the receipt line is not asset-related this field is blank.</p>
INV Status (inventory move status)	<p>Displays the item status in relation to PeopleSoft Inventory. Values are:</p> <p><i>Pending:</i> Indicates that the receipt line is inventory-related and is pending interface with PeopleSoft Inventory. Click the link to access the Inventory Putaway Information for Line page where storage location information can be reviewed or entered.</p> <p><i>Moved:</i> Indicates that the receipt line has been interfaced to PeopleSoft Inventory.</p> <p>If the receipt line is not inventory-related this field is blank.</p>

More Details

Select the **More Details** tab.

Inspection processing may be performed as a separate business process for the organization. This involves receiving all goods, moving them to an inventory holding area, and then performing the inspection process. To have the receiving agents process shipments and receipts in this manner, select the **Separate Inspection** check box when setting up the purchasing definitions on the Purchasing Definition - Business Unit Options page. This makes the **Inspect Qty** field unavailable for entry during the receiving transaction. Inspections are performed in a separate inspection transaction using the Inspection page. If you want the receivers to be able to inspect items and enter inspection quantity at time of receipt, do not select the **Separate Inspection** check box.

Field or Control	Description
Inspect	If selected, this check box indicates that the receipt line requires inspection.

Field or Control	Description
Reject Qty (rejected quantity)	Enter the quantity of items to reject. The values in the Net Receipt Quantity (net received) and Accept Qty (accepted quantity) fields are calculated by subtracting the reject quantity from the receipt quantity.
Reject Action	<p>Select an action for the rejects. Values are:</p> <p><i>C</i> (return for credit)</p> <p><i>R</i> (return for replacement)</p> <p>When you enter or modify a rejection against a PeopleSoft Manufacturing receipt line, and the receipt has already been moved to PeopleSoft Manufacturing, the following adjustments apply when updating the Manufacturing interface table:</p> <ul style="list-style-type: none"> • If the reject action is for credit, the production receipt accepted quantity is decreased as long as the resulting quantity is greater than or equal to the sum of production accept quantity in the subcontract interface table and the completion quantities of unprocessed data collection completion transactions. The production receipt rejected quantity is increased as long as the resulting quantity is less than or equal to the production reject quantity in the subcontract interface table plus the scrap quantities of any unprocessed data collection completion transactions. . • If the reject action is returned for replacement, the production receipt accepted quantity is decreased as long as the resulting quantity is greater than or equal to the production accept quantity in the production interface table plus the completion quantity of any unprocessed data collection completion transactions. . The production receipt rejected quantity remains the same.
Reject Reason	<p>Select a reason for rejecting the item or subcontracted item.</p> <p>If the receipt line is subcontracted related, and you want to perform the streamline process, this reason code you select here must be a valid production scrap code if the reject action is return for credit.</p>

Field or Control	Description
RMA Number (return material authorization number) and RMA Line	If available, enter the RMA number the supplier assigned to the rejected item. Supplying this information helps you and the supplier to associate the rejected goods to the original purchase order. RMA information from any return-to-vendor transactions (RTVs) associated with the receipt line does not update the receipt RMA information.
Net Receipt Quantity	Displays the number of items received. This is the received quantity less the quantity of items rejected and returned. The quantity returned is included in this calculation if the RTV return action is return for replacement and the RTV Adjust Source check box is selected at the business unit level.
Allocation Type	<p>Displays the allocation type for the receipt. The method selected is used when the receipt quantity is less than the quantity ordered. This field appears by default from the Purchasing Definition - Business Unit Options page. Values are:</p> <p><i>FIFO</i>: (first-in-first-out): Allocations to the distribution quantities are fulfilled based on the sequence in which they are added to the purchase order schedule for purchase order receipts or the receipt line for non-purchase order receipts.</p> <p><i>Prorate</i>: The receipt amount is prorated across the distributions for the schedule based on what percentage the receipt amount is to the total purchase order schedule's distribution amount. For example, if 50% of the required items were received, each distribution line would be allocated 50 percent of its required quantity.</p> <p><i>Specify</i>: The user will specify the quantity received for each distribution line.</p> <p><i>Split Distributions</i>: The receipt quantity is allocated to the distributions in the same manner as the prorate type and the resulting receipt asset lines are all assigned to the same asset. For serialized items, each individual unit is split across all the distributions and grouped together under a separate asset.</p>
Ship To	Displays the location to which the supplier delivered the items.
Attention To	Displays the person to whom, or place to where the services or goods are to be delivered. This value is copied from the purchase order and can originate from a requisition.

Links and Status

<i>Field or Control</i>	<i>Description</i>
Line Comments	Click the Comments icon to access the Maintain Receipts - Receipt Line Comments page. Use this page to add line level comments that will be associated with this receiver ID. Click the link to add additional line level comments or to review existing ones.

Item / Mfg Data

Select the **Item / Mfg Data** tab.

<i>Field or Control</i>	<i>Description</i>
	Click the Manufacturing Info button to access the Maintain Receipts - Manufacturing Information for Line page. Use this page to maintain the inventory putaway information related to the receipt line for the manufactured item when the related subcontracted operation is the last operation on the operation list.
UPN Type	Displays the UPN Type for the receipt line.
UPN ID (Universal Product Number Identifier)	Displays the UPN ID for the receipt line.

Note: The UPN Type and UPN ID field values defaults from the referred PO line for a PO receipt. In case of a non-PO receipt, the values for these fields are taken from the UPN defaulting hierarchy.

Optional Input

Select the **Optional Input** tab.

<i>Field or Control</i>	<i>Description</i>
Hold	Select this check box to put the receipt line on hold. When selected, the receipt line status is set to <i>H</i> (hold).

Field or Control	Description
Invoice Number	Enter the invoice ID assigned by the supplier. The invoice ID from the receipt header appears by default to the receipt lines. If no invoice ID is assigned to the receipt header or line, the packing slip value will be copied to the invoice ID when the receipt is saved. An invoice ID is required for ERS processing of the receipt.
Packing Slip	Enter the packing slip ID for the received merchandise. The packing slip appears by default from the receipt header.
Pro Number (progressive number)	Enter the tracking number assigned to the shipment in which the material arrived. This progressive number appears by default from the receipt header. If multiple progressive numbers exist for this receipt line, you cannot change the value in the field. Click the Multiple Pro link to access the Maintain Receipts - PRO Numbers page where you can change the numbers.
Multiple Pros (multiple progressive numbers)	Click to access the Maintain Receipts - PRO Numbers page where you can view or add additional progressive numbers. Using the page, you can specify progressive numbers or you can add them using an auto-sequence function to create numbers.
Origin Country	Select the country from which the received items were shipped. This value is used for Intrastat reporting.
Replacement	Indicate that a shipment is a replacement for a prior return. This is used for Intrastat reporting. <i>NA</i> (not applicable) <i>RN</i> (replaced goods not returned): Indicates that this shipment is a replacement for goods that were not returned to the supplier. <i>RR</i> (replacement of returned goods): Indicates that this shipment is a replacement for goods that were returned to the supplier.

Field or Control	Description
Intrastat Distribution Status	<p>Used for Intrastat reporting and indicates whether this receipt has been processed by the Intrastat reporting process. Valid values are:</p> <p><i>Distribute</i> (Distributed)</p> <p><i>Ignore</i> (Ignored)</p> <p><i>Archive</i> (Archival entry)</p> <p><i>Reversal</i> (Reversal entry)</p> <p><i>Undefined</i> (Undefined)</p>

Source Information

Select the **Source Information** tab.

Field or Control	Description
Original Substituted Item	Displays the original item ID on a procurement transaction that is being substituted. Once an Original Substituted Item is designated for a procurement transaction, it is carried all the way through to the receipt and cannot be changed. (The field name is also referred to as Original Item in some cases where the Item may or may not have been substituted.)
	Click the Pegging Inquiry button to access the Pegging Workbench page. Use this page to view details associated with the pegged line.
Procurement Group ID	<p>(Display only) Displays the Procurement Group ID for the item if the purchasing group options are enabled and if you selected a procurement group for your purchase order.</p> <p>See Purchasing Options Page and Setting Up Procurement Groups.</p>
Primary Unit	(Display only) Displays as selected if this item is the primary unit for the Procurement Group ID, if applicable.
Unit Allocation Qty	(Display only) Displays if applicable. If the receipt distribution quantity exceeds the allocation quantity, the system repeats the first RECV_LN_ASSET row for the remainder of the allocation quantity until it totals the distribution quantity.

Field or Control	Description
Unit Allocation Amt	<p>(Display only) Displays if applicable. If the receipt distribution amount exceeds the allocation amount, the system repeats the first RECV_LN_ASSET row for the remainder of the allocation amount until it totals the distribution amount.</p> <p>You can also view the Procurement Group data on the Receipt Line Details page.</p>

Additional Information

Field or Control	Description
Interface Receipt	<p>This check box setting appears by default from the selection of this field on the User Preferences - Procurement: Receiver Setup page. Select this check box if you want to automate the passing of inventory, asset, and manufacturing information through the receiving process.</p> <p>If the Interface Receipt check box is selected on the receipt, then one of the multiprocessing jobs is submitted to the process scheduler upon saving the receipt. The type of receipt related lines determine which job is submitted by the system.</p>
Run Close Short	<p>Select to run the Close Short process when you save this receipt. When you select the check box and save the receipt, and one or more of the receipt lines have the Close Short check box selected, the Receipt Push process (PO_RECVPUSH) process calls the Close Short (PO_CLSSHORT) process. The Receipt Push process deselects the Run Close Short check box after the Close Short process has run. You can also run the Close Short process using the Close Short menu option.</p> <p>You select the Run Close Short check box on the User Preferences Receiver Setup page to provide users with permission to close a receipt short.</p>

Field or Control	Description
<p>Subcontract Streamline</p>	<p>This check box will appear at the bottom of the page if one or more of the receipt lines is subcontracted related. This check box indicates you want to use the streamline processing between purchasing receiving and subcontract completions in manufacturing. If selected during online receiving, the system will perform the purchase order receipt and the production completion in one step rather than multiple steps.</p> <p>If the receipt is subcontracted related, this check box setting appears by default from the selection of this field on the User Preferences - Procurement: Receiver Setup page.</p> <p>This check box will be cleared and unavailable if:</p> <ul style="list-style-type: none"> • The SetID for the receiving business unit does not exist in Data Collection setup. • None of the subcontract related lines on the receipt have a manufacturing move status of pending. • This field is unchecked on the User Preferences - Procurement: Receiver Setup page. <p>Also, you will not be able to change this check box setting if the source for the receipt is data collections.</p> <p>If the Interface Receipt check box and the Subcontract Streamline check box are both selected on the receipt, then one of the multiprocess jobs is submitted to the process scheduler upon saving the receipt. The type of receipt related lines determine which job is submitted by the system.</p>
<p>Interface Asset Information</p>	<p>Click this link to access the Pre-AM1 page. Use this page to preview and correct data that is being sent to PeopleSoft Asset Management.</p>

Note: The SAC_PO_RECV_CI is not designed to work with Excel to CI or the Handler Tester.

Related Links

[Accrue Receipt Page](#)

[Processing Receipts](#)

[“Understanding User Preferences” \(Application Fundamentals\)](#)

[POX5030 - Receipt Delivery Detail](#)

[Defining Purchasing Item Attributes](#)

[Understanding Inspections](#)

[Performing Inspections](#)

[“Understanding EDI Integration with PeopleSoft” \(PeopleSoft Electronic Data Interchange\)](#)

Understanding Receipt AccrualItem Rejection Versus Item Returns

“Define Item - Inventory: Shipping/Handling Page” (PeopleSoft Managing Items)

“Using Device Tracking” (PeopleSoft Managing Items)

“Using Universal Item Identifiers” (PeopleSoft Managing Items)

“Using Item Quantity UOM” (PeopleSoft Managing Items)

“Understanding How PeopleSoft Asset Management Integrates with Other Applications” (Asset Lifecycle Management Fundamentals)

Purchasing Definition - Business Unit Options Page

Maintain Receipts - Header Details Page

Use the Maintain Receipts - Header Details page (RECV_WPO_HDR) to view and enter receipt header information.

Navigation:

Click the **Header Details** link on the Maintain Receipts - Receiving page.

You will find the Custom Field on clicking on the Header Details link. Click the Custom Field to access the Custom Page to enter the custom detail information.

Field or Control	Description
Receive Source mobile receiving	Identifies the method used to create the receipt. Included in the field values is <i>Mobile</i> . When this value appears, the receipt was created using a mobile device in the PeopleSoft Mobile Inventory Management application. The other values for Receive Source are: 'On-line' when created by Add / Update receipt component, 'ASN' when created by receipt load from Advanced Shipment Receipts, and 'Data Collect' when created by receipt load from Data Collection transactions. Using the application, you can receive items with or without a purchase order. See .“Understanding How to Receive Stock in PeopleSoft Inventory Using Mobile Receiving” (PeopleSoft Mobile Inventory Management)
Receipt Date	Indicates the date when you physically received the material.
Receipt Time	Indicates the time that you physically received the material.
User ID	Identifies the operator who entered or is entering the transaction.
Last Change Date	Displays the date and time of the last change to the receipt.
Last User to Modify	Displays the last user to modify the receipt.

Shipping Information

Field or Control	Description
Ship Date	Select a shipping date for this receipt.
Carrier ID	Enter the Carrier ID. This identifies the carrier who delivered the shipment.
Vehicle ID	Enter a Vehicle ID. This identifies the vehicle that delivered the shipment.
Driver ID	Enter a Driver ID. This identifies the driver who delivered the shipment.
Bill of Lading	Enter the bill of lading. The bill of lading that you enter here appears by default onto the receipt lines.
Pack Slip	Enter the packing slip. The pack slip value that you enter here appears by default to the packing slip on the receipt line. The field becomes unavailable when the match status on the receipt is <i>Matched</i> or <i>Partially Matched</i> .
Shipment Number	Enter the shipment number assigned to the shipment.
Pro Number (progressive number)	Enter the carrier's tracking number for this delivery of materials. The progressive number that you enter here appears by default to the progressive number on the receipt line.
Container ID	Enter a Container ID. This identifies the container in which the goods were shipped.
Nbr Cartons (number of cartons)	Enter the number of cartons received.
Pallets In	Enter the number of pallets delivered.
Pallets Out	Enter the number of empty pallets returned in exchange.
Port of Unloading	For international shipments when Intrastat reporting is required, identify the port of unloading. This is the actual shipping port where the goods were first unloaded when arriving in the destination country.

Field or Control	Description
Ship From Country	Select the country from which the goods were shipped.
Ship From Location	Identifies the location from which the goods were shipped.

Match Options

Field or Control	Description
Invoice	The supplier-assigned invoice ID for the shipment. The value that you enter here appears by default as the invoice number on the receipt line.
Invoice Dt Op (invoice date options)	This value is used in PeopleSoft Payables voucher processing to determine the invoice date for ERS vouchers. Values are: <i>Frnt Terms</i> (freight terms): Use freight terms to determine the invoice date. <i>Recv Date</i> (receipt date): Use the receipt date to determine the invoice date.
Freight Terms	Enter receipt freight terms, if applicable. The freight terms reflect who holds legal responsibility for the material until ownership has passed.
Allow ERS (allow evaluated receipt settlement)	If this check box is selected, the receipt can be used by PeopleSoft Payables for ERS (evaluated receipt settlement).
Match Status	Displays the receipt's matching status. Values are: <i>Matched</i> (fully matched) <i>No Match</i> (no match) <i>Partial</i> (partially matched) <i>To Match</i> (to be matched) <i>Vouchered</i> (vouchered)
Match Rule	Displays the match rule assigned to the receipt, if applicable.

Receipt Hold Options

<i>Field or Control</i>	<i>Description</i>
Hold Receipt	Select this check box to hold processing of this receipt in PeopleSoft Purchasing.
Hold Inventory	Select this check box to hold any received inventory items from moving to PeopleSoft Inventory for putaway processing.
Hold Assets	Select this check box to hold any received items with asset management information from moving to PeopleSoft Asset Management for further processing.

Custom Field

The user definable fields in this Custom Fields section are available when you check the Enable Custom Fields checkbox on the Purchasing Installation Options page. You can customize these fields for your use. The custom fields are informational only. .

For more information See [Understanding User-Definable Fields](#)

Related Links

“Match Rule Control Page” (PeopleSoft Source to Settle Common Information)

“Rule Definition Page” (PeopleSoft Source to Settle Common Information)

“Understanding the Matching Process” (PeopleSoft Payables)

Maintain Receipts - Receipt Line Details for Line Page

Use the Maintain Receipts - Receipt Line Details for Line page (RECV_WPO_DETAILS) to view receipt line item details.

Navigation:

Click the **Details** button under any of the tabs of the Maintain Receipts - Receiving page.

Receipt Quantity

<i>Field or Control</i>	<i>Description</i>
Receipt Qty (receipt quantity)	Displays the quantity received on the receipt line.
Reject Qty (reject quantity)	Displays the quantity rejected on the receipt line.
Accept Qty (accept quantity)	Displays the quantity accepted on the receipt line.

Field or Control	Description
Return Qty (return quantity)	Displays the quantity returned on the receipt line.
Inspect Qty (inspected quantity)	Displays the quantity inspected on the receipt line.
Recv UOM (receiving unit of measure)	Displays the unit of measure in which the items were received.
Vndr UOM (supplier or ordering unit of measure)	Displays the unit of measure in which the items were ordered from the supplier.
Std UOM (standard unit of measure)	Displays the standard unit of measure for the item.
Stock UOM (stocking unit of measure)	Displays the unit of measure in which the items are to be stocked in inventory.

Conversion Rate

Field or Control	Description
Convert to PO	Displays the conversion rate applied to the receipt UOM quantity to determine the purchase order UOM quantity.
Convert to Stock	Displays the conversion rate applied to the receipt UOM quantity to determine the stocking UOM quantity to put away the item.
Supplier to Std Rate	Displays the conversion rate applied to the supplier / purchase order UOM quantity to determine the standard UOM quantity for the receipt line.
Convert Stock to Standard	Displays the conversion rate applied to the stocking UOM quantity to determine the standard UOM quantity for the receipt line.

Receipt Status

Field or Control	Description
Asset Applicable	<p>Designates whether the receipt line is an asset related line, along with its status. Values are:</p> <p><i>Moved</i>: The receipt line has been interfaced to PeopleSoft Asset Management.</p> <p><i>N/A</i> (not applicable): The receipt line is not asset-related.</p> <p><i>Pending</i>: The receipt line is an asset item that has not been moved to the assets staging area and is pending interface with PeopleSoft Asset Management.</p>
Intrastat Distribution Status	<p>Used for Intrastat reporting and indicates whether this receipt has been processed by the Intrastat reporting process. Values are:</p> <p><i>Distribute</i> (distributed)</p> <p><i>Ignore</i> (ignored)</p> <p><i>Archive</i> (archival entry)</p> <p><i>Reversal</i> (reversal entry)</p> <p><i>Undefined</i> (undefined)</p>
Inventory	<p>Designates whether the receipt line is an inventory related line, along with its status. Values are:</p> <p><i>Moved</i>: The receipt line has been interfaced to PeopleSoft Inventory.</p> <p><i>N/A</i> (not applicable): The receipt line is not inventory-related.</p> <p><i>Pending</i>: The receipt line is inventory-related and is pending interface with PeopleSoft Inventory.</p>

Field or Control	Description
Mfg Applicable (manufacturing applicable)	Designates whether the receipt line is a PeopleSoft Manufacturing related line, along with its status. Values are: <i>Moved</i> : The receipt line has been interfaced to PeopleSoft Manufacturing (production management). <i>N/A</i> (not applicable): The receipt line is not manufacturing-related. <i>Pending</i> : The receipt line is manufacturing-related and is pending interface with PeopleSoft Manufacturing (production management).
Serial Control	Designates whether the receipt line is serial controlled, along with one of the following statuses: <i>Complete</i> or <i>Incomplete</i> .
Inspection	Designates whether the receipt line item requires inspection, along with one of the following statuses: <i>Complete</i> or <i>Incomplete</i> .
Process Complete	Displays <i>Y</i> if the Receiver Interface Push process has completed for the receipt line. This includes the creation of receipt-landed cost transactions and receipt-notification transactions.
Lot Control	Designates whether the receipt line item is lot controlled, along with one of the following statuses: <i>Complete</i> or <i>Incomplete</i> .
Ship Date Status	Displays the status of the ship date. Values are: <i>Date OK</i> (passes date check): Shipment date passed the ship date tolerance check. <i>Early Ship</i> (early shipment): Shipment date was too early to pass the ship date tolerance check. <i>Late Ship</i> (late shipment): Shipment date was too late to pass the ship date tolerance check.
Due Date	Displays the requested due date and due time of the receipt line.

Field or Control	Description
Quantity Status	<p>Displays the tolerance status of the receipt line item's received quantity. Values are:</p> <p><i>Qty OK</i> (passes quantity check): Received quantity passed the quantity tolerance check.</p> <p><i>Over Ship</i> (over shipment): Received quantity was greater than the quantity tolerance.</p> <p><i>Under Ship</i> (under shipment): Received quantity was less than the quantity tolerance.</p>
Ship Days	Displays the number of days the shipment was late.
Matching	Indicates whether matching is required for the receipt line.
Ship Qty Pct (ship quantity percentage)	Displays the percentage of items that were overshipped.
Match Status	<p>Displays the receipt line matching status. Values are:</p> <p><i>Matched</i> (fully matched)</p> <p><i>No Match</i> (no match)</p> <p><i>Partial</i> (partially matched)</p> <p><i>To Match</i> (to be matched)</p> <p><i>Vouchered</i> (vouchered)</p>

Manufacturer Information

Field or Control	Description
IN Unit (PeopleSoft Inventory business unit)	Displays the PeopleSoft Inventory business unit value used for PeopleSoft Manufacturing-related transaction.
Operation Sequence	Displays the operation sequence of the PeopleSoft Manufacturing-related transaction. This is the manufacturing subcontracted operation for which the outside processing service was performed.

Field or Control	Description
Production ID	Displays the production ID of the PeopleSoft Manufacturing-related transaction. This is the production ID for which the outside processing services were performed.
Revision	Displays the revision number of the item if applicable.
Manufacturer ID	Displays the item's manufacturer ID.
Manufacturer	Displays the name of the manufacturer.
Model	Displays the model of the item.
Mfg Itm ID (manufacturing item ID)	Displays the manufacturer item ID for the item.
Configuration Code	Displays the identification code assigned to specific configuration details for the items, if applicable.

Optional Data

Click on the Optional Data Tab and select a line, you will see the Custom Fields link. Click on the Custom Field Link to enter the Custom Details Information.

The user definable fields in this Custom Fields section are available when you check the Enable Custom Fields checkbox on the Purchasing Installation Options page. You can customize these fields for your use. The custom fields are informational only. .

For Custom Details See [Understanding User-Definable Fields](#)

Field or Control	Description
Hold	Displays the line hold status. <i>Y</i> if on hold and a <i>N</i> if not on hold.
Bill of Lading	Displays the bill of lading for the receipt line.
Replacement	Identifies if the receipt line is for goods returned for replacement. Possible values are <i>Replacement of Returned Goods</i> , <i>Replace Goods Not Returned</i> , and <i>Not Applicable</i> .
Pro Number	Displays the progressive number of the receipt line.

Field or Control	Description
Origin Country	Displays the country from which the receipt line item originated.
Invoice ID	Displays the supplier assigned invoice ID assigned to the shipment for the receipt line.
Packing Slip	Displays the shipment packing slip for the receipt line.

Source Information

Field or Control	Description
PO Unit (PeopleSoft Purchasing business unit)	Displays the PeopleSoft Purchasing business unit of the purchase order schedule associated with the receipt line.
PO Amount	Displays the merchandise amount of the purchase order schedule associated with the receipt line.
PO ID	Displays the purchase order ID of the purchase order schedule associated with the receipt line.
PO Type	Displays the type of purchase order from which the receipt line was created. This is a user-defined value. Types are not used in purchase order processing, with the exception of <i>Kanban</i> ; however, you can use them for tracking and reporting purposes.
PO Line	Displays the purchase order line number of the purchase order schedule associated with the receipt line.
PO Schedule	Displays the purchase order schedule number of the purchase order schedule associated with the receipt line.
Amount Only	If <i>Y</i> , indicates that the receipt line is to be received by amount only.
Distribute by	Displays the distribution method used for the receipt line. The method can be by quantity or by amount.

Field or Control	Description
Procurement Group ID	(Display only) Displays the Procurement Group ID for the item if the purchasing group options are enabled and if you selected a procurement group for your purchase order. See Purchasing Options Page Setting Up Procurement Groups
Primary Unit	(Display only) Displays as selected if this item is the primary unit for the Procurement Group ID, if applicable.
Unit Allocation Qty	(Display only) If the Allocate Purchasing Group option is enabled on the Purchasing Options page, the value in this field determines how many asset lines are generated: one asset line per each unit of allocation quantity until the sum totals the receipt line distribution quantity. If the receipt distribution quantity exceeds the allocation quantity, the system repeats the first RECV_LN_ASSET row for the remainder of the allocation quantity until it totals the distribution quantity.
Unit Allocation Amt	<p>(Display only) If the Allocate Purchasing Group option is enabled on the Purchasing Options page, the value in this field determines how many asset lines are generated: one asset line per each unit of allocation amount until the sum totals the receipt line distribution amount. If the receipt distribution amount exceeds the allocation amount, the system repeats the first RECV_LN_ASSET row for the remainder of the allocation amount until it totals the distribution amount.</p> <hr/> <p>Note: The Receipt Load batch process, unlike online Receipts, will not load Receipts that have ties to procurement groups if the Allocate Purchasing Group option is enabled on the Purchasing Options page.</p> <hr/>
PO Quantity (purchase order quantity)	Displays the purchase order quantity available for this receipt line. This field does not appear when the Blind Receiving Only check box is selected for the user on the User Preferences - Procurement: Receiver Setup page.
PO Merchandise Amount (purchase order merchandise amount)	Displays the purchase order merchandise amount for this receipt line. This field does not appear when the Blind Receiving Only check box is selected for the user on the User Preferences - Procurement: Receiver Setup page.

Field or Control	Description
Total Qty Received (total quantity received)	Displays the total quantity that has been received for this receipt line. This field does not appear when the Blind Receiving Only check box is selected for the user on the User Preferences - Procurement: Receiver Setup page.
Total Received Amount	Displays the total amount that has been received for this receipt line. This field does not appear when the Blind Receiving Only check box is selected for the user on the User Preferences - Procurement: Receiver Setup page.
Total Open PO Qty (total open purchase order quantity)	Displays the total open purchase order quantity for this receipt line. This field does not appear when the Blind Receiving Only check box is selected for the user on the User Preferences - Procurement: Receiver Setup page.
Total Open PO Amount (total open purchase order amount)	Displays the total open purchase order amount for this receipt line. This field does not appear when the Blind Receiving Only check box is selected for the user on the User Preferences - Procurement: Receiver Setup page.
Procurement Group ID	<p>Displays a procurement group ID to include this line in a procurement group. A procurement group gathers a group of line items on a requisition, purchase order, or receipt to help organize a larger item. For example, the Procurement Groups feature can be used in combination with PeopleSoft Asset Management to collect all item IDs that belong to a larger asset such as an air conditioning unit.</p> <p>See Understanding Procurement Groups in PeopleSoft.</p>
Primary Unit	Displays as a selected check box if this line item is the main item for an item-grouping in a procurement group; for example, an air conditioning unit could be the primary unit in a procurement group to create a complete asset
Unit Allocation Qty	Displays the quantity of this item needed to complete a primary unit in a procurement group; for example, four brackets per air conditioning unit. If this page is for the primary unit item and it is serial-controlled then this quantity is restricted to one. This field is only available if the Amount Only field is N. It is utilized during receiving and asset integration.

<i>Field or Control</i>	<i>Description</i>
Unit Allocation Amt	Displays the amount or price of this item needed to complete a primary unit in a procurement group; for example, 500 USD of installation services per air conditioning unit. This field is only available for amount-only transactions lines that have Y in the Amount Only field. It is utilized during receiving and asset integration.

Custom Fields

The user definable fields in this Custom Fields section are available when you check the Enable Custom Fields checkbox on the Purchasing Installation Options page. You can customize these fields for your use. The custom fields are informational only. .

For Information on Custom Fields See [Understanding User-Definable Fields](#)

Related Links

“Using Item Quantity UOM” (PeopleSoft Managing Items)

Asset Management Information for Line Page

Use the Asset Management Information for Line page (RECV_WPO_AM) to view and enter information about asset purchases.

This information is passed to PeopleSoft Asset Management. This page is available for entry only if the selected receipt is targeted for PeopleSoft Asset Management. One or more of the distributions must have a PeopleSoft Asset Management business unit and Asset Management profile designated, and optionally, other Asset Management data.

Navigation:

Click the Asset Management Status **Pending** or **Moved** link under the Receipt Lines tab of the Maintain Receipts - Receiving page.

If available, this link appears in the **Asset Management Status** column in the grid section of the Maintaining Receipts - Receiving page.

Example of Asset Management Information for Line Page for Split Distributions.

This example illustrates the fields and controls on the Asset Management Information for Line page. You can find definitions for the fields and controls later on this page.

Dist Seq	AM Business Unit	Status	Quantity	Tag Number	Serial ID	Asset ID	Number	Profile ID
1	US001	Open	0.3000	TNO1	SRN1	NEXT	1	COMPUTERS
2	US001	Open	0.3000	TNO2	SRN2	NEXT	2	COMPUTERS
3	US001	Open	0.3000	TNO3	SRN3	NEXT	3	COMPUTERS

Note: If the defaults for the asset purchases are setup in such a way that you do not need to override them during the receiving process, it is not necessary to access the Assets pages in PeopleSoft Asset Management. These rows are generated and populated with defaults at save time. However, if the receipt line is serial controlled, you must supply the appropriate required information.

If the purchase order distribution has a PeopleSoft Asset Management business unit and asset profile ID specified, the receipt items are identified as asset purchases. Use this page to enter or override default asset information to be sent to PeopleSoft Asset Management.

- If the item being received requires serialization, the number of rows generated is equal to the distribution quantity converted to the standard unit of measure.
- If the item does not require serialization, then one row is generated with a quantity equal to the distribution quantity.
- The asset rows populate automatically when the receiving agent accesses the Asset Management Information for Line page.

Use this page to accommodate split-funded assets. For example, if you purchased a vehicle to be shared by three departments, use this page to split-fund the vehicle between the departments. This can occur only if the purchased vehicle is an asset and is not inventory-related, meaning there is no inventory business unit specified for it on the purchase order distribution. In this scenario, a single asset tag number is assigned to the vehicle and associated with each of the three department distributions

In addition, if the receipt line is serial controlled, the system verifies the following for the selected receipt line:

- The sum of interface record quantities for any given serial ID is 1.
- Only one Asset ID is assigned to any given serial ID on the receipt line.

- Only one tag number is assigned to any given serial ID on the receipt line.

Field or Control	Description
Next Asset ID	<p>Click this button to temporarily assign a value of <i>AUTO-ASSIGN</i> as the line item asset ID value. This value is replaced with the next available asset ID value upon saving the receipt.</p> <hr/> <p>Note: This button is hidden when the Split Distributions receipt allocation type is in effect since the grouping of assets requires special handling for Split Distributions.</p> <hr/>
Use One Asset ID	<p>Click this button to group multiple receipt distribution lines into a single Asset Identification.</p> <hr/> <p>Note: This functionality is not available if the receipt line has a single distribution only. Furthermore, this button is hidden when the Split Distributions receipt allocation type is in effect since the grouping of assets requires special handling for Split Distributions.</p> <hr/>

Distribution Information

Field or Control	Description
Business Unit	<p>PeopleSoft Asset Management business unit associated with the selected distribution line. The PeopleSoft Asset Management unit can be entered for new non-purchase order receipts, but cannot be changed once the receipt has been saved.</p>
Profile ID	<p>Displays the identifier for the receipt item product profile defined in PeopleSoft Asset Management.</p>
CAP # (capital acquisition planning number)	<p>Displays the capital acquisition plan identifier. This identifier is defined in PeopleSoft Asset Management.</p>
Cost Type	<p>Displays the cost type code for the receipt item, if applicable. Cost types represent different components of the cost of an asset, such as materials, labor, and overhead. For example, you can differentiate between the cost of building an asset and its market value by allocating the cost of production to one cost type and the margin of profit to another cost type. Cost type, in combination with asset category and transaction code, determines into which accounts the costs are entered in the general ledger.</p>

Field or Control	Description
Capitalize	Designates whether or not the receipt item is capitalized. Values are: <i>Non Cap</i> (not a capitalized asset) <i>Capitalize</i> (capitalized asset)
CAP Sequence (capital acquisition planning sequence)	Displays the sequence number for the capital acquisition plan.

Apply to All Distributions

(Displayed for FIFO, Prorate, and Specify allocation types)

Field or Control	Description
Assign Tag ID and Assign Serial ID	If the receipt line is serial controlled, both the Assign Serial ID and Assign Tag ID options are available. If the receipt line is not serial controlled, only Assign Tag ID is available.
Enter Starting Number	If you assign serial IDs, this represents the starting serial ID, which is assigned to the first detail row and is indicated by the Start Row field. If you assign tag IDs, this represents the starting tag ID, which is assigned to the first detail row and is indicated by the Start Row field.
Multiplier	Enter the number multiplier. The system used this value to increment the starting number from detail row to detail row.
Start Row	This is a required field and automatically changes to a value of 1. Indicate the detail row to use as the starting point for assigning values that are determined by the starting number and multiplier.
Overwrite existing numbers	Select to override existing values in the detail grid rows for either the tag ID or serial ID, depending on which action is selected (Assign Tag IDs or Assign Serial IDs).

Field or Control	Description
Apply	<p>Click this button to assign values to the detail rows in the grid.</p> <p>When you click this button, the system uses the Starting Tag and/or Starting Serial ID's and/or Starting Asset ID to the receipt asset lines under first distribution and then repeat the exact same assignment across the remaining distributions associated with the receipt line.</p>

Apply to All Distributions

(Displayed for Split Distributions allocation type)

Field or Control	Description
Starting Asset ID	Enter the Asset ID to be applied to the first asset line on all the distributions for the receipt line.
Starting Tag Number	Enter the tag number to be applied to the first asset line on all the distributions for the receipt line.
Starting Serial ID	Enter the Serial ID to be applied to the first asset line on all the distributions for the receipt line.
Multiplier	Enter the number multiplier. The system used this value to increment the starting number from detail row to detail row.
Start Row	This is a required field and automatically changes to a value of 1. Indicate the detail row to use as the starting point for assigning values that are determined by the starting number and multiplier.
Overwrite existing numbers	Select to override existing values in the detail grid rows depending on which starting IDs or numbers are entered (Starting Asset ID and/or Tag Number and/or Serial ID).

Field or Control	Description
Apply	<p>Click this button to assign values to the detail rows in the grid</p> <p>When you click this button, the system uses the Starting Asset ID and/or Starting Tag and/or Starting Serial ID, the multiplier, and the start row values to determine how values are assigned to the grid. The system assigns the values to the asset lines under the first distribution and then repeats the same assignment across the remaining distributions associated with the receipt line so that each split unit is assigned the same values.</p>

Asset Information

Field or Control	Description
AM Business Unit (PeopleSoft Asset Management business unit)	Displays the PeopleSoft Asset Management business unit.
Status	Displays the receipt asset row status. Identifies whether or not this specific asset row has been passed to the PeopleSoft Asset Management system. One asset row can have a status of <i>Moved</i> and another row on the same distribution can have a status of <i>Open</i> .
Quantity	<p>Displays the quantity assigned to the asset row. If the receipt line is serial controlled, the quantity is not available for change.</p> <hr/> <p>Note: The sum of the quantities on the asset rows must equal the distributed quantity on the receipt.</p> <hr/>
Tag Number	<p>Enter the asset tag number for the asset row. If you enter the tag number value on the purchase order distribution, those values appear by default from the purchase order distribution.</p> <p>In addition, the system checks the tag number that you entered on the receipt to make sure it is not already assigned to an asset, when the Allow Dup Tags option is not set for the PeopleSoft Asset Management business unit. If the tag number has already been assigned to another asset the system gives you a warning message. The system only looks at the Assets table it does not look at the interface tables, previously entered receipts, purchase orders, or requisitions to see if the tag number has been assigned to another pending transaction.</p>

Field or Control	Description
Serial ID	Serial ID for the distribution sequence. This field is available for entry only when the Serial option is selected for the selected line on the Maintain Receipts - Receiving page.
Asset ID	<p>Asset ID for the asset row. The default value is <i>NEXT</i>. If you do not override this value, <i>NEXT</i> is passed to PeopleSoft Asset Management, where the next asset ID is assigned. You may choose to override the <i>NEXT</i> value and manually enter an asset ID or assign one by using the Next Asset ID button.</p> <p>If the Asset ID value is anything other than <i>NEXT</i> and the same Asset ID value is assigned to multiple asset rows for the selected receipt line, then these asset rows must all have the same custodian, location, model, and manufacturer values as well.</p>
Number (sequence number)	When the Asset ID is <i>NEXT</i> , this field facilitates the grouping of multiple asset lines under the same asset. All asset lines across all distributions with the same number in this field will be assigned to the same asset.
Profile ID	Identifier for the receipt item product profile. This value is not available for change by the receiving agent and is populated by the value on the receipt distribution.
	<p>Click the Cancel Row button to cancel this asset row information. This row is a child of the distribution line. If the receipt has not been interfaced, this asset row is not be interfaced and is deleted during receipt interface processing.</p> <p>If the receipt has been interfaced, then a retirement asset transaction is passed to PeopleSoft Asset Management.</p>

More Details

Select the **More Details** tab.

Field or Control	Description
VIN	<p>(Optional) Enter the VIN number for each individual serial receipt. Only one VIN can be assigned to each serial ID.</p> <hr/> <p>Note: This field is available only if you are receiving a serial-controlled item and the Asset Type associated with the item and asset profile is <i>FLEET</i>.</p> <hr/>

Field or Control	Description
Custodian	Enter the recipient of the asset item on the selected distribution sequence. If the asset ID value is anything other than <i>NEXT</i> and the same asset ID value is assigned to multiple asset rows for the selected receipt line, then this value must be the same on those same asset rows.
Location	Select the delivery location for the distribution sequence. If the asset ID value is anything other than <i>NEXT</i> and the same asset ID value is assigned to multiple asset rows for the selected receipt line, this value must be the same on the asset rows.
Mfg ID (manufacturer ID)	The manufacturer ID for the item appears by default from the manufacturer ID assigned to the purchase order line using the Maintain Purchase Order - Details for Line page. You can also select a manufacturer ID if one is not displayed. Once you select a manufacturer ID the description for the manufacturer appears in the Manufacturer field.
Model	<p>The model appears by default from the model associated with the item on the Purchasing Attributes - Purchasing Attributes page.</p> <p>If a model does not appear, you can modify or select the model of the product. If the asset ID value is anything other than <i>NEXT</i> and the same asset ID value is assigned to multiple asset rows for the selected receipt line, this value must be the same on the asset rows.</p>
Manufacturer	<p>Select the manufacturer of the product. If the asset ID value is anything other than <i>NEXT</i> and the same asset ID value is assigned to multiple asset rows for the selected receipt line, this value must be the same on the asset rows.</p> <hr/> <p>Note: If a manufacturer ID is entered for the line then you will not be able to select a Manufacturer. If the manufacturer ID field is blank then you can select a manufacturer using this field.</p> <hr/>
Capitalize	Displays whether or not the receipt item is capitalized. Appears by default from the value of the parent distribution row, but can be overridden by validation edits.

PO Comment

Displays the purchase order line comments for the selected item. Information such as the asset tag numbers can be entered upon creation of the order.

Validations Edits

Edits and validations are performed when you click the **OK** button on the Asset Management Information for Line page. Capitalization to asset ID cross-edits ensures that the capitalization flag is either on or off for all asset rows for a given asset ID. Rows with an asset ID of *AUTO-ASSIGN* or *NEXT* are not included in the edit. However, the row with an asset ID of *NEXT* and a sequence number value (*NEXT1*, *NEXT2*, and so forth) will be included in the edit. If a combination of on and off capitalization flags are detected for one asset ID, a message appears requiring an action to be selected.

If you select Yes on the message prompt, the system turns on the capitalization flag for all asset rows with the same asset ID.

If you select No on the message prompt, the system turns off the capitalization flag for all asset rows with the same asset ID.

The original capitalization flag value copied from the purchase order distribution remains on the receipt distribution. Only the receipt line asset row changes.

The system performs edits on the **Tag Number, Custodian, Location, Model, and Manufacturer** fields to ensure that these fields contain consistent values for the same asset ID within the receipt line.

Additional edits and validations are performed at receipt save time to ensure that a specific asset ID assignment has only one profile ID, serial ID, and tag number value.

Split Distributions

For serialized items, the Split Distributions receipt allocation type directs online Receipts to split each unit (i.e. quantity of 1) across all the distributions according to the distribution percentage. Each split unit will automatically be assigned the same asset grouping sequence number so PeopleSoft Asset Management will assign the same Asset ID to each fractional unit.

Example of Split Distributions for Serialized Items

If the receipt line has a quantity of 3 and there are 2 distribution lines with the first allocating 70% to fund F100 and the second allocating 30% to F200, each unit will be split so that a quantity of .7 is assigned to the receipt asset line for the first distribution and .3 is assigned to the receipt asset line under the second distribution.

After the quantity is split across all the distributions, the system will then automatically assign a Number (i.e. asset sequence number) of 1 to the asset lines which represent the first unit so that they are assigned to the same asset ID downstream by PeopleSoft Asset Management. The remaining 2 units are broken down the same way and assigned the next sequence number (i.e. 2 and 3). The end result is 3 receipt asset lines under the first distribution with a quantity of .7 and an asset sequence number of 1 through 3, and 3 receipt asset lines under the second distribution with a quantity of .3 and an asset sequence of 1 through 3 as well. In other words, there will be 3 assets assigned to each split unit.

<i>Distribution</i>	<i>Asset Line</i>	<i>Asset Line Qty</i>	<i>Fund</i>	<i>Tag</i>	<i>Serial ID</i>	<i>Asset ID</i>
1	1	0.7	F100	T1	S1	NEXT1
1	2	0.7	F100	T2	S2	NEXT2
1	3	0.7	F100	T3	S3	NEXT3
2	1	0.3	F200	T1	S1	NEXT1
2	2	0.3	F200	T2	S2	NEXT2
2	3	0.3	F200	T3	S3	NEXT3

Note: The Asset ID in the table above represents the default value of NEXT appended to the Number field on the Asset Management Information page. In the example above, there are to be 3 separate system generated Asset IDs.

Non Serialized Items

For non-serialized items, the Split Distributions receipt allocation type behaves just like prorate in distributing the quantity across the distributions according to the distribution percentage. Unlike the prorate option, however, the Split Distributions type will ensure that all the asset lines are grouped together under the same asset. The system will default the asset line 'Number' field to 1. If the Asset ID has been manually entered, the system will verify that the Asset ID is the same across all the asset lines.

Procurement Groups and Split Distributions

With Procurement Groups, one or more items are assigned the same Procurement Group ID and one of the items is marked as the primary item. Each item in the group has its own Unit Allocation Quantity (or amount) which defines how much of the item must be received in order to make up a complete set of that Procurement Group. Each set becomes a single asset in Asset Management and the Serial and Tag IDs are only taken from the primary item per asset.

For more information See [Understanding Procurement Groups in PeopleSoft](#)

Split Distributions within Procurement Groups is dependent on the Unit Allocation Quantity (or Amount) and this is best described in the following 3 scenarios:

- When Unit Allocation Quantity (or amount) is equal to Line Quantity (or amount) or the item is serialized and the Unit Allocation Quantity is 1.
- When Unit Allocation Quantity (or amount) is less than the Line Quantity (or amount).
- When Unit Allocation Quantity (or amount) is greater than the Line Quantity (or amount).

1. When Unit Allocation Quantity (or amount) is equal to Line Quantity (or amount) or the item is serialized and the Unit Allocation Quantity is 1

For Procurement Groups, the asset is associated with the primary unit (i.e. primary item) only and the unit allocation quantity determines the number of assets created. If the unit allocation quantity (or amount) is equal to the receipt line quantity (or amount), the receipt asset lines generated for Split Distributions automatically reflect a single procurement group unit for that item and, as such, do not require further parsing. The same can be said for serialized items where the unit allocation quantity is 1 since serialized items are automatically split across the distributions for each unit in that case.

The asset sequencing arranged by Split Distributions in the Add/Update Receipts component for both primary and non-primary items in the procurement group is ineffectual since the primary item determines the asset, and the asset sequencing for procurement groups is handled by the Receipt Push process.

On the other hand, the Receipt Push process does maintain the integrity of the Split Distributions by grouping the procurement group asset lines across the distributions rather than sequentially in preparation for the PeopleSoft Asset Management Interface Processes.

2. When Unit Allocation Quantity (or amount) is less than the Line Quantity (or amount)

This is somewhat similar to serialized items where each unit (or quantity of 1) is split across the distributions. The difference is that the unit allocation quantity, for example, does not have to be 1. Thus, instead of dividing 1 across the distributions, the unit allocation quantity is split across the distributions.

- Assume there is a single line with a non-serialized item and a line quantity of 20 and having a 50/20/30 split across the distributions with a unit allocation quantity of 5.
- In the table below, each unit allocation quantity of 5 is divided across the distributions according to the distribution percentage. As a result, the distribution percentage is preserved both in terms of the total asset quantity per distribution as well as the individual asset line quantity across the distributions.

Formula to calculate Asset Line Quantity:

$$\text{Asset Line Quantity} = ((\text{Distribution Quantity}) * (\text{Unit Allocation Quantity})) / (\text{Line Quantity})$$

<i>Distribution</i>	<i>Asset Line</i>	<i>Asset Line Qty</i>	<i>Fund</i>	<i>Tag</i>	<i>Asset ID Grouping</i>
1	1	2.5	F100	T1	NEXT 1
1	2	2.5	F100	T2	NEXT 2
1	3	2.5	F100	T3	NEXT 3
1	4	2.5	F100	T4	NEXT 4
2	1	1.0	F101	T1	NEXT 1

<i>Distribution</i>	<i>Asset Line</i>	<i>Asset Line Qty</i>	<i>Fund</i>	<i>Tag</i>	<i>Asset ID Grouping</i>
2	2	1.0	F101	T2	NEXT 2
2	3	1.0	F101	T3	NEXT 3
2	4	1.0	F101	T4	NEXT 4
3	1	1.5	F102	T1	NEXT 1
3	2	1.5	F102	T2	NEXT 2
3	3	1.5	F102	T3	NEXT 3
3	4	1.5	F102	T4	NEXT 4

- When Unit Allocation Quantity (or amount) is greater than the Line Quantity (or amount).

In the event that the unit allocation quantity is greater than the line quantity, the system has to wait for the same item to come in on another receipt in order to complete the procurement group unit (and set of items). This is standard behavior for Procurement Group allocation and the entire quantity (or amount) will be subject to the Split Distributions for that receipt line.

Note: It is recommended for users to verify that multiple receipts with the same procurement group items with incomplete assets like this utilize the same 'Split Distributions' receipt allocation type. It is also recommended for users to verify that the receipt distributions for these incomplete assets are identical.

Related Links

[Maintain Receipts - Receipt Line Details for Line Page](#)

“Understanding Asset Processing” (Asset Lifecycle Management Fundamentals)

“Setting Up Asset Profiles” (Asset Lifecycle Management Fundamentals)

[Purchasing Attributes Page](#)

Inventory Putaway Information for Line Page

Use the Inventory Putaway Information for Line page (RECV_WPO_PUTAWAY) to view and enter overriding information used to put items away in inventory business unit storage locations.

This page is available only if the receipt line is targeted for inventory (one or more of the distributions must have an inventory business unit assigned). This is applicable to purchase order and non-purchase order receipts.

Navigation:

Click the INV Status **Pending** or **Moved** link under the Receipt Lines tab of the Maintain Receipts - Receiving page.

If available, this link appears in the **IN Status** column in the grid section of the Maintain Receipts - Receiving page.

Note: If the defaults for the inventory purchases are set up in such a way that you do not need to override them during the receiving process, it is not necessary to access the Putaway pages. These rows are generated and populated with defaults at save time. However, if the receipt line is serial controlled or lot controlled, you must supply the appropriate required information.

Companies typically accept items through receiving and then route them to a staging area. In PeopleSoft Purchasing, items are staged until you initiate material putaway. The putaway process assigns the items to appropriate inventory business unit storage locations.

If purchase order distributions have an inventory business unit specified, the **Inventory** field on the Line Status Details page is set to *Y*. When receiving items are identified as inventory purchases, you can override the default information for the putaway process on this page.

Distribution Information

<i>Field or Control</i>	<i>Description</i>
Distributed Quantity	Displays the number of items being received for this distribution line. This value is dependent on the value entered in the Quantity field.
Merchandise Amt (merchandise amount)	Displays the merchandise amount allocated to this distribution, expressed in the transaction currency. This value is dependent on the value entered in the Quantity field.
Base Amt (base amount)	Displays the distribution merchandise amount in the PeopleSoft General Ledger business unit currency. This value is dependent on the value entered in the Quantity field.
Default Location	Displays the location designated as the default putaway location for this item. This is not required on the receipt. You can enter an override location on the receipt or assign a default location in inventory before running the Putaway process after the Receiver Interface Push process (PO_RECVPUSH).
Consigned	If this check box is selected, indicates that the distribution items are consignment items. Consigned items can only be putaway in non-owned locations.

Field or Control	Description
Non-Owned Item	If this check box is selected, indicates that the distribution items are non-owned. Non owned items can only be putaway in non-owned locations.

Apply to Details

This group box is only available when the receipt is serial controlled or lot controlled.

Putaway Information

Field or Control	Description
Status	Displays the receipt putaway row status. Identifies whether the specific putaway row has passed to the PeopleSoft Inventory system. One putaway row can have a status of <i>Moved</i> , while another row on the same distribution can have a status of <i>Open</i> .
Quantity	Enter the number of items being received for the distribution sequence. The value in this field determines the values that appear in the Distributed Quantity , Merchandise Amt , and Base Amt fields. If the receipt line is serial controlled, the quantity is not available for change. Note: The sum of the quantities on the putaway rows must equal the distributed quantity on the receipt distribution.
Serial ID	Enter the serial ID for the distribution sequence. This field is only available for entry if the Serial check box is selected for the receipt line on the Maintain Receipts - Receiving page.
Lot ID	Enter the lot ID for the distribution sequence. This field is only available when lot control is <i>Y</i> (yes) for the receipt line on the Maintain Receipts - Receiving page. If the item being received for inventory is lot controlled, then a lot ID has to be specified on the receipt putaway page. If the target inventory business unit Allow Auto-Add of New Lots check box is selected, a lot ID that does not exist within inventory may be specified. Otherwise, enter an existing lot ID or select a lot ID from the list of values. If you enter a new lot ID and the business unit does not permit the automatic adding of new lots, the system validates the lot ID against the existing list. You can use the Lookup button to find existing lot IDs.

Field or Control	Description
Supplier Lot	<p>Enter the identifier assigned to the item's lot by the supplier. This field is only available when the lot control status is <i>Y</i> (yes) for the receipt line on the Maintain Receipts - Receiving page.</p> <p>The system checks for duplicate serial IDs for all serial-controlled lines on a receipt document. This edit is only for serial ID assigned within the receipt document.</p> <hr/> <p>Note: The supplier lot value defaults to the value that you enter for the lot ID.</p>
Expiration Date	<p>Expiration date for a lot-controlled item. If the item is a non-inventory receipt line (subcontract, expense only, or an asset only interface receipt), then this field is left blank. If the item lot ID has been assigned an expiration date, this value cannot be changed. If the item lot ID doesn't have an assigned expiration date, the item shelf-life value (if greater than zero) is added to the receipt date to calculate the expiration date. You can override this value. You must enter a value if the item's shelf life is zero.</p> <hr/> <p>Note: When you enter an expiration date on the ASN, the ASR carries it over, and the load receipt process populates the same expiration date in the receipt.</p>

Field or Control	Description
	<p>Click the Cancel Row button to cancel the putaway row of the distribution line. If the receipt has not been interfaced, this putaway row is not to be interfaced and is deleted during receipt interface processing. If the receipt has been interfaced, the putaway rows are removed from inventory at receipt save time.</p>

Putaway Location

Select the **Putaway Location** tab.

Field or Control	Description
IN Unit (PeopleSoft Inventory business unit)	Identifies the PeopleSoft Inventory business unit for the distribution. For non-purchase order receipts, this value appears by default from the ship to location. For purchase order receipts, this value appears by default from the purchase order distribution.
Container ID	Displays the container with which the received item is associated.
Kanban ID	Displays the identification code assigned to the Kanban card associated with the putaway of this item. This code appears by default from the kanban details.

Using the Receiving Putaway Integration

These conditions control the receiving putaway integration after PO_RECVPUSH has processed the receipt transaction and set the status to moved:

- If the receipt has not started the putaway process, then all putaway fields on the Inventory Putaway Information for Line page (quantity, serial ID, lot ID, container, and putaway location) are available for entry, and any changes are immediately propagated to the appropriate STAGED_INF_INV row.
- If the receipt has gone through the Load Staged Items process, but an error was found, all putaway fields on this page are available for entry, and any change is immediately propagated to the STAGED_ITEM_INV row.

An example of such an error is when information in STAGED_ITEM_INV/STAGED_COST_INV has a putaway status of 3. No data validation is necessary, because the Load Staged Errors process validates the information.

- If the receipt has gone through the Load Staged Items process without errors, then the only fields available for entry on the Inventory Putaway Information for Line page are the **Quantity** field and the **Cancel Row** button.

All other fields are unavailable for entry. This is necessary, because the original putaway information has already gone through validation and cannot be validated again.

- If you made a mistake entering the lot ID, serial ID, container, or putaway location on the Inventory Putaway Information for Line page, cancel the original putaway row by clicking the **Cancel Row** button for the row and then inserting a new row with the correct information.

This row goes through the Process Receipts process that writes the information to STAGED_INF_INV. The canceled row is deleted from STAGED_ITEM_INV.

- If there are multiple staging rows in STAGED_ITEM_INV for a given receipt line and distribution sequence number, a warning appears before the quantity change is propagated to the Staging table.

This may happen if a user on the putaway side splits a receipt quantity over multiple storage locations. For a quantity increase, the change is made to the original STAGED_ITEM_INV row; that is, the

row with the smallest STAGED_NUM. For a quantity decrease, the change is made starting with the original row (smallest STAGED_NUM) and continuing with each subsequent STAGED_NUM row, until the total quantity decrease has been applied. If a row's quantity becomes 0, it is deleted from the table.

- If a receipt is on a putaway plan (that is, if it has been assigned a putaway plan ID and line) or if it has already been flagged for putaway, a warning appears when a quantity change is made or when you click the **Cancel Row** button.
- If the receipt has gone through the full putaway process, the only putaway fields that are available for entry on the Inventory Putaway Information for Line page are the **Quantity** field and **Cancel Row** button.

All other fields are unavailable for entry. If you need to change other fields, cancel or decrease the quantity of the original row and insert a new one. The new rows will go through the regular Process Receipts process, which then writes the information to STAGED_INF_INV.

- If the quantity is increased, the appropriate PHYSICAL_INV, LOT_CONTROL_INV (if the item is lot controlled), and BU_ITEMS_INV rows are updated to reflect this change.

A row is written to the transaction history table (TRANSACTION_INV) with the quantity increase and a transaction group 010 or 020, depending on whether or not the item requires inspection. If the item is standard costed, the PPV (purchase price variance) should be calculated and a row written to TRANSACTION_INV. If the item is average costed, the average cost should be recalculated. If the quantity increase should go through the putaway process, insert a new row on the Maintain Receipts - Receiving page. This enables you to decide for yourself how you want quantity increases to be handled.

- If the quantity is decreased, the appropriate inventory tables are searched to determine whether the change is allowed.

If the quantity decrease is allowed, the corresponding tables are updated to reflect this change. A row is written to the transaction history table with the quantity decrease.

- If there are multiple rows in PHYSICAL_INV corresponding to the receipt line/distribution sequence number, then a warning appears before the quantity change is propagated to PHYSICAL_INV.

For a quantity increase, the change is made to the PHYSICAL_INV row corresponding to the smallest STAGED_NUM. For a quantity decrease, the change is made starting with the original row (smallest STAGED_NUM) and continuing with each subsequent STAGED_NUM row until the total quantity decrease has been applied.

- If part of the receipt quantity is still in STAGED_ITEM_INV while the rest has been put away, then the STAGED_ITEM_INV rows reflect this change.

If the changes cannot be fully transferred to the staging table, then the quantity that has already been put away should be updated. For quantity increases, only the first STAGED_ITEM_INV row is updated. For quantity decreases, STAGED_ITEM_INV is updated first, then if there is an additional quantity to decrease, the putaway quantity is updated.

Related Links

[Maintain Receipts - Receiving Page](#)

[Asset Management Information for Line Page](#)

[Processing Receipts](#)

Using the Receiver Interface Push Application Engine Process (PO_RECVPUSH)

“Receiving Consigned Stock” (PeopleSoft Inventory)

“Understanding Receiving and Putaway Processing” (PeopleSoft Inventory)

“Define Item - Inventory: Tracking/Description Page” (PeopleSoft Managing Items)

“Using Item Quantity UOM” (PeopleSoft Managing Items)

Inventory Item Information Page

Use the Inventory Item Information page (RECV_INV_ITEMS_SP) to view detailed inventory information entered for an inventory-related item.

Navigation:

- Click the **Item Detail** link on the Inventory Putaway Information for Line page.
- Click the **Item Detail** link on the Maintain Receipts - Manufacturing Information for Line page.

<i>Field or Control</i>	<i>Description</i>
Shlf Life (shelf life)	Displays the item shelf life expressed in days. PeopleSoft Inventory calculates the lot-expiration date by adding the value of the shelf life to the creation date of the lot. The shelf-life value appears by default from the value defined on the Business Unit Item Definition - Inventory: Shipping/Handling page.
MSDS ID (material safety data sheet ID)	If this item requires an MSDS, the appropriate MSDS ID appears.
Hazard Code	As required for business needs, the appropriate code appears. This field is informational only.

Related Links

“Define Item - Inventory: Shipping/Handling Page” (PeopleSoft Managing Items)

“Define Item - General: Classifications Page” (PeopleSoft Managing Items)

Storage Location Search Page

Use the Storage Location Search page (RECV_STOR_LOC_SRCH) to search available storage locations for the material that you are receiving.

Navigation:

- Click the **Storage Location Search** button under the Putaway Location tab of the Inventory Putaway Information for Line page.
- Click the **Storage Location Search** button under the Putaway Location tab of the Maintain Receipts - Manufacturing Information for Line page.

Field or Control	Description
Storage Location and Storage Level 1 - 4	Select storage location areas and levels to search.
Search	Click the Additional Search Criteria button to search on the storage location values that you entered in the Storage Location and Storage Level fields. The search results appear in the scroll area.

Maintain Receipts - Receipt Distributions for Line Page

Use the Maintain Receipts - Receipt Distributions for Line page (RECV_WPO_DIST) to view distribution information for the selected receipt.

Navigation:

Click the **Distribution** button under the Links and Status tab of the Maintain Receipts - Receiving page.

You can also access the Custom Field by clicking the Distribution button. The Custom Field link appears on the Details Tab. You can click the Custom Field to enter the custom related information.

The user definable fields in this Custom Fields section are available when you check the **Enable Custom Fields** check box on the Purchasing Installation Options page. You can customize these fields for your use. The custom fields are informational only.

This example illustrates the fields and controls on the Maintain Receipts - Receipt Distributions for Line page. You can find definitions for the fields and controls later on this page.

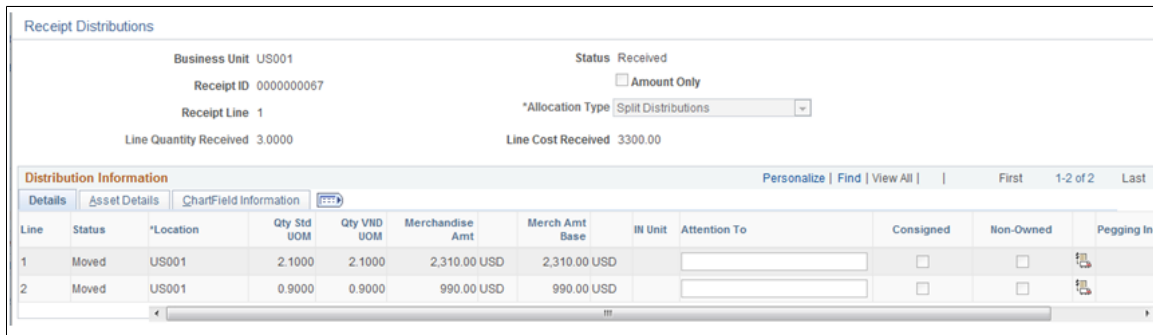



For More information See [Understanding User-Definable Fields](#)

Field or Control	Description
Allocation Type	<p>Displays the allocation type for the receipt. This field appears by default from the Maintain Receipts - Receiving page. This field becomes available if there are multiple distributions for a schedule. Values are:</p> <p><i>FIFO</i> (first-in-first-out): Allocations to the receipt distributions are fulfilled based on the sequence in which they are added to the purchase order schedule for purchase order receipts or the receipt line for non-purchase order receipts.</p> <p><i>Prorate</i>: Allocate the receipt amount across the distributions for the schedule based on what percentage the purchase order distribution amount is of the purchase order schedule amount for purchase order receipts.</p> <p><i>Specify</i>: Allocate the receipt amount or quantity across multiple distributions for the schedule based on the quantity or amount that you enter for the distribution lines. When you select this value, the Qty Std UOM or the Amount field become available for entry.</p> <p><i>Split Distributions</i>: This behaves just like the prorate type for non-serialized items. The receipt quantity is allocated to the distributions in the same manner as the prorate type and the resulting receipt asset lines are all assigned to same asset. For serialized items, each individual unit is split across all the distributions and grouped together under a separate asset.</p> <hr/> <p>Note: The <i>Prorate</i> and <i>Split Distributions</i> allocation types are hidden when the item is designated for inventory.</p> <hr/>

Details

Field or Control	Description
Line	Displays the distribution line number.
Status	Displays the status of the distribution row.
Location	Enter the location to where the goods are to be delivered.
Qty Std UOM (quantity in the standard unit of measure)	<p>Displays the quantity of items being distributed, expressed in the standard UOM.</p> <p>If you select an allocation type of <i>Specify</i>, enter the quantity received across the multiple distribution lines.</p>
Qty VND UOM (quantity in the supplier's unit of measure)	Displays the quantity of items being distributed, expressed in the supplier UOM.

Field or Control	Description
Amount	Displays the merchandise amount for the distribution row in the transaction currency. If you select an allocation type of <i>Specify</i> , enter the amount received across the multiple distribution lines.
Currency	Displays the transaction currency code.
Base Amt (base amount)	Displays the merchandise amount for the distribution row in the base currency code.
Currency	Displays the base currency code which is used by general ledger, inventory, and asset integration.
IN Unit (PeopleSoft Inventory business unit)	If the item is an inventory item, it displays the PeopleSoft Inventory business unit associated with the item.
Attention To	Enter the name of the person who should receive the line item. This field defaults to the name entered in the Attention To field on the PO Distribution Line page when the purchase order was created.
Consigned	Designates whether the item is consigned or not. You may override the setting on this page for non-purchase order items only. This setting can only be overridden if it appears by default from the item as consigned. If the setting changes to not consigned, this setting cannot be overridden.
Non-Owned	Designates whether an item is owned or non-owned. This value is set at the item level. An item is non-owned if it is maintained in inventory but is not owned by the associated business unit.

Field or Control	Description
	<p>Click the PO Distribution Details button to access the PO Distribution Details page where you can view the details of the purchase order distribution and also set up the Custom Field. Click on the Custom field link to access the Custom Field page to set up the custom details.</p> <p>The user definable fields in this Custom Fields section are available when you check the Enable Custom Fields checkbox on the Purchasing Installation Options page. You can customize these fields for your use. The custom fields are informational only. .</p> <p>For more information on Custom Fields See Understanding User-Definable Fields</p>
	<p>Click the Pegging Inquiry button to access the Pegging Workbench page. Use this page to view details associated with the pegged distribution.</p>

See [Pegging Inquiry Page](#).

See “Understanding Pegging” (PeopleSoft Supply Chain Management Common Information).

Asset Details

Select the **Asset Details** tab.

You can also access the Custom Field from the Asset Detail Tab. The Custom Field Links appears on the More Details Tab of Asset Line. You can click the Custom Field Link to modify the custom settings.

The user definable fields in this Custom Fields section are available when you check the Enable Custom Fields checkbox on the Purchasing Installation Options page. You can customize these fields for your use. The custom fields are informational only. .

For more information on Custom Fields See [Understanding User-Definable Fields](#)

Field or Control	Description
<p>AM Business Unit (PeopleSoft Asset Management business unit)</p>	<p>Displays the PeopleSoft Asset Management business unit assigned to the purchase order for the selected receipt items by the originating PeopleSoft Purchasing business unit.</p>
<p>Profile ID</p>	<p>Identifier of the item's asset management profile.</p>
<p>Capitalize</p>	<p>Displays the capitalize asset indicator. Values are <i>Capitalize</i> or <i>Non Cap</i>.</p>

Field or Control	Description
Cap #	Displays the asset's capital acquisition plan number.
Cap Sequence	Displays the asset's capital sequence number.
Employee ID	Displays the employee ID associated with the asset.

Maintain Receipts - Manufacturing Information for Line Page

Use the Maintain Receipts - Manufacturing Information for Line page (RECV_WPO_MFG) to maintain manufacturing information for the receipt line.

Navigation:

Click the **Manufacturing Info** button under the Item / Mfg Data tab of the Maintain Receipts - Receiving page.

This example illustrates the fields and controls on the Maintain Receipts - Manufacturing Information for Line. You can find definitions for the fields and controls later on this page.

Manufacturing Information for Line 1

Business Unit US001	Status Received
Receipt ID 0000000004	Item EX2007 White Board, 3 x 4
Receipt Line 1	Standard UOM EA
Inventory Unit US001	Last Op Seq
Production ID	Operation Sequence

Distribution Information Find | View All First 1 of 1 Last

Distribution Line 1	Merchandise Amount 650.00
Distributed Quantity 10.0000 Item Detail	Base Amount 650.00
	Default Location

This page contains three types of information. At the top of the page, the details for the receipt line pertaining to manufacturing appear. In the Distribution Information group box, the receipt distribution details appear along with the default inventory putaway location and other inventory details.

Note: The Putaway Information grid appears only when the **Operation Sequence** field and the **Last Op Seq** (last operation sequence) field are equal.

Field or Control	Description
Item	Displays the item related to the manufacturing information. When the receipt line is subcontracted related, the assembly item ID (manufactured item) and its description appear.
Last Op Seq (last operation sequence)	Displays the last operation sequence for the production ID.



Field or Control	Description
Operation Sequence	Displays the operation sequence for the subcontracting operation on the production ID.
Production ID	Displays the manufacturing production ID. When the receipt line is subcontracted related, the production ID that contains the subcontracting operation appears.

Distribution Information

Field or Control	Description
Item Detail	Click this link to access the Inventory Item Information page. Use this page to view the detailed inventory information entered for an inventory-related item.
Default Location	Displays the default inventory putaway location for the inventory business unit and item ID.



Putaway Information

Use this section of the page to enter the putaway inventory information for a receipt that is subcontracted related.

Field or Control	Description
Status	Displays the status of the last operation. Values are: <i>Open</i> or <i>Canceled</i> .
Serial ID	Select the serial ID for the assembly. This field is not available for non-serial controlled items.
Lot ID	Select the lot IDs for the assembly. This field is not available for non-lot controlled items.
	Click the Cancel Row button to cancel the detail row.
	Click the Add a New Row button to add a row to the putaway information grid. This button is available for non-serial controlled items that do not have a status of canceled. It also enables you to split the quantity received between lot IDs or different storage locations.

Putaway Location

Select the **Putaway Location** tab.

<i>Field or Control</i>	<i>Description</i>
	Click the Storage Location Search button to access the Storage Location Search page. Use this page to search for available storage locations for the material that you are receiving.
	Click the Putaway Locations button to access the Storage Location Search page. Use this page to define directed putaway information for the receipt items.

Maintain Receipts - PRO Numbers Page

Use the Maintain Receipts - PRO Numbers page (RECV_WPO_PRO) to add receipt progressive numbers.

Navigation:

Click the **Multiple Pros** link under the Optional Input tab of the Maintain Receipts - Receiving page.

You can assign multiple progressive numbers on receipt lines for multiple receipts for each line.

<i>Field or Control</i>	<i>Description</i>
Starting Number	Enter a starting value for progressive numbers. The system assigns this value to the progressive number row that you specify in the Start Row field. When you click the Apply button, the system applies the values that you define to the rows in the Pro Numbers grid box.
Overwrite existing numbers	Select to override existing values in the Pro Number grid rows with the new values that you enter. The numbers are overridden when you click the Apply button.
Start Row	Enter the first row to which you want to apply the values you define. For example if you have 10 rows and you want to replace the rows starting with row seven, you would enter 7 in the Start Row field. When you apply the new values, the system applies your updates starting with row seven.
Multiplier	Enter the number multiplier. The system uses this value to increment the starting number from detail row to detail row.
Apply	Click to assign values that you have entered to the detail rows in the Pro Numbers grid box.

Field or Control	Description
Pro Number	Enter a progressive number value. You can enter as many values as needed. You can manually enter a value or use the Apply to Details section to define a range of values.

PO Comments Page

Use the PO Comments page (RECV_PO_LN_COMMENT) to view purchase order header, line, and ship to comments for the associated purchase order line or purchase order schedule levels.

Navigation:

Click the **PO Comments** button under the Source Information tab of the Maintain Receipts - Receiving page.

The purchase order header, line, and ship to comments that are related to the receipt line appear.

Field or Control	Description
Send to Supplier	If this check box is selected, designates that these comments were sent to the supplier as a part of the purchase order dispatch.

RTV Information Page

Use the RTV Information page (RTV_LN_DISP_SEC) to view details about any RTV transactions created for the selected receipt.

Navigation:

Click the **Return To Vendor Data** link on the Maintain Receipts - Receiving page.

All RTV lines associated with the receipt ID appear.

Field or Control	Description
Status	The status of the RTV line.
Action	Return action designated for the returned item.
Disposition	Method of disposal designated for the returned item.
Reason Code	The return reason code for the returned item.
Rev (revision)	Displays the item's revision number, if applicable.

Field or Control	Description
Return Qty (return quantity)	Number of items being returned in the supplier unit of measure. This does not include any quantities rejected before receipt.
Ship Qty (ship quantity)	Number of items being shipped back to the supplier in the supplier unit of measure. This does not include any quantities rejected before receipt.
Price	The per supplier unit of measure price.
Supplier UOM	The supplier unit of measure used on the receipt.

Related Links

[Item Rejection Versus Item Returns](#)

[Return To Vendor Page](#)

Accrue Receipt Page

Use the Accrue Receipt page (RUN_RECVACCR_OL) to run the Receipt Accrual process, the Miscellaneous Charges process, or both.

Navigation:

Click the **Run PO Receipt Accrual** button on the Maintain Receipts - Receiving page. The button is only available if the receipt has been saved and is eligible for accrual.

This page enables you to enter parameters to initiate a process request.

Field or Control	Description
Accounting Date	(Required) Select the accounting date. The current date appears by default. An error appears when you click the OK button, if the date used is not in an open period.

Field or Control	Description
Default Entry Event Code	<p>Displays only if entry events are enabled on the Installation Options - Entry Event page, and cannot be left blank if entry events are required. The values available are set at the business unit level. A warning appears when you click the OK button if this is not a purchase order receipt and entry events are optional and the field is blank.</p> <p>For purchase order receipts with no entry event code on the purchase order distribution line, the value selected here populates the expense and accrual accounting lines. The encumbrance line is blank.</p> <p>If there is already an entry event code on the purchase order distribution line, it is not to be replaced by the value selected on this page and the entry event code populates expense, accrual, and encumbrance accounting lines.</p> <p>For non-purchase order receipts, the value selected here populates the expense and accrual accounting lines.</p>

See [Receipt Accrual Criteria Description](#).

Purge ASN History

Use the Purge ASN History Page (RUN_PO_ASN_PURGE) to purge the EC rows when transaction is complete

Navigation:

Main menu > Purchasing > Receipts > Purge ASN History

This example illustrates the fields and controls on the Purge ASN History page. You can find definitions for the fields and controls later on this page.

The screenshot shows the 'Purge ASN History' page. At the top, there is a 'Run Control ID 12345' and buttons for 'Report Manager', 'Process Monitor', and 'Run'. Below this is a checkbox for 'Purge blank BU Rows'. The main section is titled 'Process Request Parameters' and includes a search bar for 'Receiving Business Unit'. A dropdown menu for 'ASR Status' is open, showing options: Canceled, Error, New, Processed, Ready, and Validated. Other fields include 'ASR Received Date From' and 'Date To'. At the bottom, there are buttons for 'Save', 'Notify', 'Add', and 'Update/Display'.

Field or Control	Description
Receiving Business Unit	Provides the Receiving Business unit the user is authorized for.
ASR Status	<p>Used for selection criteria. This is an optional field.</p> <p>The ASR Statuses are as follows:</p> <ul style="list-style-type: none"> • Error • New • Processed • Ready • Validated • Cancelled <hr/> <p>Note: If you do not specify a status, the statuses, 'Processed' and 'Cancelled' are considered for deletion.</p> <hr/>
ASR Received Date From and Date To	Used for selection criteria. This is an optional field.
Purge blank BU's row	<p>Processes the blank Receipt BU rows.</p> <p>The process deletes rows from the following tables after the successful execution.</p> <ul style="list-style-type: none"> • RECV_ADDR_EC • RECV_AOHD_EC • RECV_AOLN_EC • RECV_AOLS_EC • RECV_ASHD_EC • EO_EIP_CTL

Modifying Receipt ChartFields

This section discusses how to modify receipt ChartField values.

Note: While it is unusual for the receiving department to change distribution information copied directly from the purchase order, PeopleSoft Purchasing has built this flexibility into the system should your business practices require this functionality.

Page Used to Modify Receipt ChartFields

<i>Page Name</i>	<i>Definition Name</i>	<i>Usage</i>
ChartFields Page	RECV_ACCOUNT	Modify ChartField values for receipt distribution lines.
Item Description Page	RECV_ITEM_DESCR_FS	Enter and view descriptions for a specific item.

ChartFields Page

Use the ChartFields page (RECV_ACCOUNT) to modify ChartField values for receipt distribution lines.

Navigation:

Purchasing > Receipts > Maintain ChartFields > ChartFields

Receipt Lines

<i>Field or Control</i>	<i>Description</i>
Vndr Rcpt Qty (supplier receipt quantity) and Vndr Accept Qty (supplier accept quantity)	Displays the received and accepted quantities expressed in the supplier UOM.

Account Lines

<i>Field or Control</i>	<i>Description</i>
Dist Qty (distribution quantity)	Displays the distribution quantity to be charged to the ChartField combination.

Related Links

[“User Preferences – Receiving and RTV Page” \(Application Fundamentals\)](#)

[“Understanding PeopleSoft ChartFields” \(Application Fundamentals\)](#)

[Receiving Items by Amount](#)

Tracking Receipt Activity

This section lists the pages that are used to track receipt activities.

Pages Used to Track Receipt Activity

<i>Page Name</i>	<i>Definition Name</i>	<i>Usage</i>
Activity Page	RECV_ACTIVITY	Enter and track activities associated with a receipt. You can set up reminders for receiving activities and activities that should be done after the goods are received. Enter as many activities as necessary.
Receipt Header Comments Page	RECV_COMMENTS_SEC	View and enter header-level comments for the selected receipt.
Receipt Line Comments Page	RECV_COMMENTS_SEC	View and enter line-level comments for the selected receipt. To access this page, enter the appropriate receipt line in the Receipt Line field.

Using ASRs

This section discusses how to Use ASRs

Note: If the installation includes PeopleSoft eSupplier Connection, the suppliers can enter advance shipment notifications directly into the PeopleSoft system. Once a supplier's ASN is submitted, it becomes an ASR in PeopleSoft Purchasing.

Pages Used to Use ASRs

<i>Page Name</i>	<i>Definition Name</i>	<i>Usage</i>
<u>ASR Review Page</u>	RECV_AOLN_EC	Access information about receipts received using the ASR Enterprise Integration Point (EIP) or created by supplier-entered ASNs.
Item Description Page	RECV_AOLN_IT_DESCR	Enter and view descriptions for a specific item. <u>ASR Review Page</u>
<u>Header Details Page</u>	RECV_AOHD_EC	View purchase order header details for the selected ASR.
<u>Shipment Header Page</u>	RECV_ASHD_EC	View shipment details for the selected ASR.

Page Name	Definition Name	Usage
<u>Address Page</u>	RECV_ADDR_EC	View shipping address details for the selected ASR.
<u>Lot/Serial Page</u>	RECV_AOLS_EC	Enter lot and serial ID information for lot- and serial-controlled items.
<u>Select Purchase Order - Search Criteria Page</u>	PO_PICK_ORDERS	Select purchase order items and attributes that you want to reconcile with a receipt received by ASR.

Related Links

“PeopleSoft SCM Inbound EIPs” (PeopleSoft Supply Chain Management Integration)

“PeopleSoft SCM Inbound EIPs” (PeopleSoft Supply Chain Management Integration)

“PeopleSoft Electronic Data Interchange” (PeopleSoft Electronic Data Interchange)

Common Elements Used in ASR Information

Field or Control	Description
ASR Item	If the ASR uses a different item ID, such as the supplier item ID, that item ID appears.
ASR Seq (ASR sequence)	If multiple ASRs were sent in the same transmission, designates the sequence in which they were inserted.
ASR Stat (ASR status)	<p>Displays the ASR status. Values are:</p> <p><i>Error</i> (ASR error): Indicates that there was an error in processing the transaction. Click the Error Message Text link to access details about the error.</p> <p><i>New</i> (ASR new): Designates a new transaction that has not been processed by the Receive Load process.</p> <p><i>Processed</i> (ASR processed): Indicates that the transaction has been processed by the Receive Load process and a receipt has been created.</p> <p><i>Ready</i> (ready for processing): Indicates that the transaction has been reset from <i>Error</i> status after corrections were performed.</p> <p><i>Validated</i> (ASR validated): The ASR is being processed by the Receive Load process. This is the only time at which the ASR will have this status.</p> <p><i>Canceled</i> (ASR canceled): Indicates that the transaction has been canceled.</p>



Field or Control	Description
Msg (message)/ Message Number	If the ASR status is set to <i>Error</i> , it displays the message number that identifies the type of error that occurred.
Order No (order number)	Displays the order number assigned by the supplier that sent the ASR.
Pro Number (progressive number)	Displays the tracking number assigned to the package in which the material was delivered.

ASR Review Page

Use the ASR Review page (RECV_AOLN_EC) to access information about receipts received using the ASR Enterprise Integration Point (EIP) or created by supplier-entered ASNs.

Navigation:

Purchasing > Receipts > Review Receipt Information > Advanced Shipment Receipts > ASR Review

Field or Control	Description
EIP Control ID (enterprise integration point control ID)	Displays the identifier assigned to the service operation that imported the selected batch of ASRs. <hr/> Note: If the installation includes PeopleSoft eSupplier Connection, the system assigns an EIP control ID when a supplier submits a supplier ASN using the Advance Shipment Notification component. <hr/>
	Click the Cancel button to cancel the ASR. Canceling an ASR cannot be reversed.
	Click the Reset Error Status button to reset the status from <i>Error</i> to <i>New</i> after data correction has been made. This would be used to reset the status after a missing purchase order line was added.

ASR Lines

Field or Control	Description
PO Unit (PeopleSoft Purchasing business unit)	Displays the PeopleSoft Purchasing business unit associated with the ASR. You can override the purchase order unit by changing the PO Business Unit value on the Header Details page. You can change the value for one purchase order line on this page or change the information on the Header Details page to populate the change to all purchase order lines at once.
PO Number	Select the purchase order number associated with the ASR. You can use this field to correct purchase order key information. You can change the value for one purchase order line on this page or change the information on the Header Details page to populate the change to all purchase order lines at once.
Line	Select the purchase order line number associated with the ASR. You can use this field to correct purchase order key information.
Sched Num (schedule number)	Select the purchase order schedule number associated with the ASR. You can use this field to correct purchase order key information.

More Line Data

Select the More Line Data tab.

Field or Control	Description
Shipment Unit of Measure	Displays the unit of measure used for the shipment.
Unit of Measure	Displays item unit of measure used on the purchase order.
Qty Shipped (quantity shipped)	Displays the quantity shipped expressed in the shipment unit of measure.
Rev Override (revision override)	Select this check box to enter a value if the revision on the ASR is different from the revision value on the purchase order.
Revision	Select the revision number associated with the item ID, if applicable.

<i>Field or Control</i>	<i>Description</i>
Invoice ID	<p>Enter the invoice identification number that is to be assigned to the receipt line , if applicable.</p> <hr/> <p>Note: When you enter an invoice ID value in this field, ASR processing loads that information into the PO Receipt line transaction.</p> <hr/>
Supplier Contract ID	Enter the identification code assigned to any associated supplier contract, if applicable.

Related Links

[Maintain Receipts - Header Details Page](#)

Header Details Page

Use the Header Details page (RECV_AOHD_EC) to view purchase order header details for the selected ASR.

Navigation:

Click the **Header Details** link on the ASR Review page.

<i>Field or Control</i>	<i>Description</i>
Shipment Number	Displays the shipment number assigned by the supplier or supplier to the ASR shipment.
PO Business Unit (PeopleSoft Purchasing business unit)/ PO Number	PeopleSoft Purchasing business unit and purchase order associated with the ASR. Changes that you make to the values in these fields are reflected on the ASR Review page.

Related Links

“Understanding Supplier ASNs” (PeopleSoft eSupplier Connection)

[Shipment Header Page](#)

Shipment Header Page

Use the Shipment Header page (RECV_ASHD_EC) to view shipment details for the selected ASR.

Navigation:

Click the **Shipment Header** link on the ASR Review page.

Shipment Header

Field or Control	Description
EC Primary Event Code (electronic collection primary event code)	Displays the EDC primary event code generated by the system when the service operation is processed.
EC Secondary Event Code (electronic collection secondary event code)	Displays the EDC secondary event code. This is an internally assigned value.
OM Unit (PeopleSoft Order Management business unit)	Displays the PeopleSoft Order Management business unit associated with the ASR, if applicable.
Customer ID	Displays the identification code assigned to the organization by the supplier.
Inventory Unit	Displays the PeopleSoft Inventory business unit associated with the ASR, if applicable.
Process Instance	Displays the identification code assigned to the process instance that loaded the ASR.
ShipTo Set	Displays the ship to address SetID assigned to the shipment.
Ship To	Displays the ship to address assigned to the shipment.
Location	Displays the supplier location code.
Device ID	Displays the identification code assigned to the device that generated the ASR. This is an information-only field value that can be supplied on the input transmission.
DtTime (date and time)	Displays the date and time that the ASR was received.
Cancel ASR	Select this check box to cancel the entire ASR. Canceling a receipt cannot be reversed.

Address Page

Use the Address page (RECV_ADDR_EC) to view shipping address details for the selected ASR.

Navigation:

Click the **Address** link on the ASR Review page.

Field or Control	Description
Demand Line No (demand line number)	Displays the demand line number from the supplier shipping system. This value is informational only.
Customer Address Type	Indicates the type of customer address that appears on the page. Values are <i>H</i> (ship to customer) and <i>S</i> (sold to customer).

Lot/Serial Page

Use the Lot/Serial page (RECV_AOLS_EC) to enter lot and serial ID information for lot- and serial-controlled items.

Navigation:

Click the **Lot/Serial** link on the ASR Review page.

Field or Control	Description
Lot Seq No (lot sequence number)	Number assigned to give a record a unique identifier for processing purposes.
Shipping	Unit of measure used to ship the ASR items.
Lot ID	If the item is lot controlled, enter the lot ID assigned to the item.
Serial ID	If the item is serial controlled, enter the serial ID for the item.
Expiration Date	<p>Click to enter the expiration date. The expiration date should not be less than or equal to the current date.</p> <hr/> <p>Note: When you input an expiration date on the ASN, it automatically populates this field. When you are creating the ASR using XML upload, you can add the expiration date in the XML file, skipping the supplier ASN creation. The created ASR will reflect the expiration date.</p> <hr/>

Related Links

“Define Item - Inventory: Tracking/Description Page” (PeopleSoft Managing Items)

Receiving Items Using EDC

This section provides an overview of entering receipts using EDC, lists common elements, and discusses how to Receive Items Using Electronic Data Collection

Pages Used to Receive Items Using Electronic Data Collection

Page Name	Definition Name	Usage
<u>Purchasing Receiving - Receiving Page</u>	BCT_PO_RECEIVING	Complete five receiving-specific electronic data collection transactions.
Transaction Maintenance Page	BCT_CTL_UPD	View EDC receiving transactions in the transaction log. The transaction log provides access to transaction detail pages that enable you to correct transaction errors.

Understanding Entering Receipts Using EDC

You can use EDC to enter receipts in PeopleSoft Purchasing. Use the Purchasing Receiving - Receiving page to complete five receiving-specific transactions using an EDC system. You can also choose to enter data manually on this page to create receiving data that could have been automatically entered using an EDC device.

When you save an EDC transaction page, the page clears so that you can enter another transaction immediately. These transactions are saved in the transaction log until they are picked up by the background processes. These background processes can be set up to continually scan the transaction log.

When you enter the transaction data using these data collection pages, selected pieces of information on the page trigger edits that validate the data entered. In addition, the background processes validate all information before any updates are performed.

Common Elements Used in Entering Receipts Using EDC

Field or Control	Description
Area	Identify the segment of the warehouse in which this item is to be stored. If the item being received requires inspection, the area chosen must be associated with an inspection location.
Device ID	Identification code assigned to the device that scanned the transaction.
End Trans (end of transaction)	Set to <i>Y</i> to signal the end of the transaction.
Lev 1 – 4 (level 1 – 4)	Identify the next levels of storage within the area location in which you want the items stored.
Number	Identifies the number of records scanned during the transaction.

Field or Control	Description
Tag Number	If this is an item that is tracked as an asset, the asset tag number is required.
Trans Nbr (transaction number)	The last number assigned to the last record that was inserted in the transaction log.
Supplier Lot	For a lot-controlled item, identifies the supplier-assigned lot ID associated with the item.

Purchasing Receiving - Receiving Page

Use the Purchasing Receiving - Receiving page (BCT_PO_RECEIVING) to complete five receiving-specific electronic data collection transactions.

Navigation:

SCM Integrations > Create Transactions > Receiving > Purchasing Receiving > Receiving

Note: Fields on this page hide and appear depending on the electronic data collection transaction code that you enter in the **Transaction Code** field.

Field or Control	Description
Transaction Code	<p>Select one of these transaction codes to access the associated page function. Values are:</p> <ul style="list-style-type: none"> • <i>0101 - Receipt Total Shipment by ID:</i> Select this transaction code to update an ASR status staged by the Receive Load process. • <i>0102 - Receipt Total PO w/Plan or BC:</i> Select this transaction code to receive an entire purchase order. • <i>0103 - Receipt PO Lines w/Plan or BC:</i> Select this transaction code to receive a purchase order line. • <i>0104 - Receipt PO Schedules w/Plan:</i> Select this transaction code to receive a purchase order schedule. • <i>0105 - Receipt PO End Tran:</i> Select this transaction code to end the receiving transaction.

Updating ASRs Using EDC

Access the Purchasing Receiving - Receiving page and select transaction code *0101* in the **Transaction Code** field.

Use this version of the page to update an ASR status previously staged by the Receive Load process.

<i>Field or Control</i>	<i>Description</i>
Container ID	Enter the container that holds the items being received.
Shipment Number	(Required) Enter the shipment number assigned to the ASR shipment.

Receiving an Entire Purchase Order Using EDC

Access the Purchasing Receiving - Receiving page and select transaction code *0102* in the **Transaction Code** field.

Use this version of the page to receive all lines of the specified purchase order.

Receiving a Purchase Order Line Using EDC

Access the Purchasing Receiving - Receiving page and select transaction code *0103* in the **Transaction Code** field.

Use this version of the page to receive a specific purchase order line.

Receiving a Purchase Order Schedule Using EDC

Access the Purchasing Receiving - Receiving page and select transaction code *0104* in the **Transaction Code** field.

Use this version of the page to receive a specific purchase order schedule.

Ending an EDC Receiving Transaction

Access the Purchasing Receiving - Receiving page and select transaction code *0105* in the **Transaction Code** field.

Use this version of the page to end the transaction when you have finished receiving a shipment.

Using the ASR EIP

This section provides an overview of the ASR EIP and discusses how to use the ASR EIP.

Pages Used to Use the ASR EIP

<i>Page Name</i>	<i>Definition Name</i>	<i>Usage</i>
<u>Receiver Load Page</u>	RUN_RECVLOAD	Run the Receive Load process.

Page Name	Definition Name	Usage
Data Collection Setup Page	BCT_SETUP_FS	Set the option to keep transaction log history for electronic data collection transactions and to set the default file suffix.
“Data Def Maint Page” (PeopleSoft Supply Chain Management Integration)	EO_EIP_CTL_MAINT	View data detail or correct errors for service operations that contain data rather than transactions.

Understanding the ASR EIP

The ASR EIP enables you to upload a supplier's advanced shipment notice. This asynchronous batch subscribe service operation also supports flat-file processing for EDI transaction X.12 856.

Run the Receive Load Process Application Engine process (PO_RECVLOAD) to move the ASR service operation data from the staging tables to application tables.

Using the ASR EIP

PeopleSoft delivers the service operations in PeopleSoft Integration Broker with a default status of *Inactive*. You must activate each service operation before attempting to send or receive data from a third-party source or another PeopleSoft system, such as CRM.

Before you can use the ASR EIP, you must:

1. Setup the service operation within PeopleSoft Integration Broker and Enterprise Components:

Use the information in the table below and refer to the setup instructions in the *PeopleSoft Supply Chain Management Integration 9.2*.

Service Operation	Direction and Type	Handlers	Chunking Available	Integrates With
ADVANCED_SHIPPING_RECEIPT	Inbound Asynchronous	Advanced Shipping Receipt	No	third-party system EDI transaction (X.12 856)

2. Run the Receive Load process to move the ASR service operation data from the staging tables to application tables.
3. Use the Data Def Maint page to view service operation data and correct error messages that are picked up in the processing of the service operation.

Related Links

“Setting Up Service Operations” (PeopleSoft Supply Chain Management Integration)

“PeopleSoft Electronic Data Interchange” (PeopleSoft Electronic Data Interchange)

Using the Purchase Order Receipt EIP

This section provides an overview of the Purchase Order Receipt EIP and discusses how to use the Purchase Order Receipt EIP.

Pages Used to Use the Purchase Order Receipt EIP

<i>Page Name</i>	<i>Definition Name</i>	<i>Usage</i>
<u>Receiver Load Page</u>	RUN_RECVLOAD	Run the Receive Load process.
Data Collection Setup Page	BCT_SETUP_FS	Set the option to keep transaction log history for electronic data collection transactions and to set the default file suffix.
“Transaction Maintenance Page” (PeopleSoft Inventory)	BCT_CTL_UPD	View all electronic transactions in the transaction log and access the detail pages that enable you to correct transaction errors.
“Data Def Maint Page” (PeopleSoft Supply Chain Management Integration)	EO_EIP_CTL_MAINT	View data detail or correct errors for service operations that contain data rather than transactions

Understanding the Purchase Order Receipt EIP

The Purchase Order Receipt EIP processes a service operation that contains receipt information from the Warehouse Management System (WMS) partners and PeopleSoft CRM. This asynchronous batch subscribe EIP updates the status of purchase order receipts in PeopleSoft to indicate whether the quantity on the receipt has been received in the WMS system.

Run the Receive Load Application Engine process (PO_RECVLOAD) to move the service operation data from staging tables to application tables.

Using the Purchase Order Receipt EIP

PeopleSoft delivers the service operations in PeopleSoft Integration Broker with a default status of *Inactive*. You must activate each service operation before attempting to send or receive data from a third-party source or another PeopleSoft system, such as CRM.

Before you can use the Purchase Order Receipt EIP, you must:

1. Setup the service operation within PeopleSoft Integration Broker and Enterprise Components:

Use the information in the table below and refer to the setup instructions in the *PeopleSoft Supply Chain Management Integration 9.2*.

Service Operation	Direction and Type	Handlers	Chunking Available?	Integrates With
PURCHASE_ORDER_RECEIPT	Inbound Asynchronous	PurchaseOrderReceipt	No	third-party system PeopleSoft CRM Warehouse Management System (WMS)

2. Run the Receive Load process to move the data from staging tables to application tables.
3. Use the common Transaction Maintenance or Data Def Maint pages to view service operation data and correct error messages that are picked up in the processing of the service operation.

See the product documentation for *PeopleTools: Integration Broker*

Related Links

“Setting Up Service Operations” (PeopleSoft Supply Chain Management Integration)

“PeopleSoft SCM Inbound EIPs” (PeopleSoft Supply Chain Management Integration)

Using the Purchase Order Expected Receipts EIP

This section provides an overview of the Purchase Order Expected Receipts EIP.:

Pages Used to Use the Purchase Order Expected Receipts EIP

Page Name	Definition Name	Usage
“Publish Outbound Message Page” (PeopleSoft Supply Chain Management Integration)	IN_RUN_PUB_MSG	Initiate the outbound service operation publish process for outbound PeopleSoft SCM service operations that use the batch publish design pattern.
PO Expected Receipts Selection Criteria Page	PO_RUN_POER	Launch the PO Expected Receipts Outbound Transaction.

Understanding the Purchase Order Expected Receipts EIP

The Purchase Order Expected Receipt EIP processes expected receipts against a dispatched or changed purchase order to Warehouse Management System applications.

This asynchronous batch publish service operation provides the Warehouse Management System with a list of expected receipts that have not been received for a dispatched purchase order.

Use the common Publish Outbound Message page to initiate the PO_POEROUT_AE Application Engine process that processes the PO_EXPECTED_RECEIPT_BUS_UNIT and PO_EXPECTED_RECEIPT_SHIPTO service operations.

Setting Up the Purchase Order Expected Receipt EIP

PeopleSoft delivers the service operations in PeopleSoft Integration Broker with a default status of *Inactive*. You must activate each service operation before attempting to send or receive data from a third-party source or another PeopleSoft system, such as CRM.

Before you can use the Purchase Order Expected Receipt EIP, you must:

1. Setup within other PeopleSoft applications:

- Select the PO Expected Receipts check box for the shipto location to publish by the shipto location, and select the Use External Warehouse Control option on the inventory business unit definition to publish by the inventory business unit option.

If you publish by ship to location, the PO expected receipts process should check the ship to PO expected receipt setting and should not check the inventory business unit Use External Warehouse Control setting. If you publish by inventory business unit, the PO expected receipt process should check the inventory business unit Use External Warehouse Control setting and should not check the PO expected receipt setting on the shipto location. By having both settings, you can publish using either the inventory business unit or ship to location.

- Establish the item and supplier relationship for the item and supplier for the purchase order.
- Address any special setup steps defined for this EIP.

2. Setup the service operation within PeopleSoft Integration Broker and Enterprise Components:

Use the information in the next table and refer to the setup instructions in the *PeopleSoft Supply Chain Management Integration 9.2*.

Service Operation	Direction and Type	Handlers	Chunking Available?	Integrates With
PO_EXPECTED_RECEIPT_BUS_UNIT	Outbound Asynchronous	ROUTERSENDHDLR	Yes	third-party system Warehouse Management System (WMS)
PO_EXPECTED_RECEIPT_SHIPTO	Outbound Asynchronous	ROUTERSENDHDLR	Yes	third-party system Warehouse Management System (WMS)

3. Create or change a purchase order by one of these methods stages the purchase order for processing by the Purchase Order Expected Receipt EIP:

- Create purchase orders online using the Maintain Purchase Order - Purchase Order page.
- Close Purchase Orders process (PO_PORECON).
- Change Purchase Order process (PO_POCHNG).
- Buyer's Workbench.

See the product documentation for *PeopleTools: Integration Broker*

Related Links

“Setting Up Service Operations” (PeopleSoft Supply Chain Management Integration)

PO Expected Receipts Selection Criteria Page

Use the PO Expected Receipts Selection Criteria page (PO_RUN_POER) to launch the PO Expected Receipts Outbound Transaction.

Navigation:

Select **PO Expected Receipts** check box on the Publish Outbound Message page to enable the **PO Expected Receipts** link. Click the **PO Expected Receipts** link to initiate the PO Expected Receipts Selection Criteria page.

See [RFQ Message Selection Criteria Page](#).

Using the Purchase Order Receipt Notification EIP

This section provides and overview of the Purchase Order Receipt Notification EIP

Page Used to Use the Purchase Order Receipt Notification EIP

<i>Page Name</i>	<i>Definition Name</i>	<i>Usage</i>
Process Receipts Page	RUN_PO_RECEIPT	Define parameters to run the Receiver Interface Push process, Receipt Push Inventory multiprocess job, Receipt Push Assets multiprocess job, and the Receipt to Inventory & AM multiprocess job.

Understanding the Purchase Order Receipt Notification EIP

The Purchase Order Receipt Notification EIP processes purchase order receipt information to external systems such as surgical resource software applications.

Use this EIP to notify suppliers about purchase order receipt information. For example, receiving material against a purchase order in the PeopleSoft Purchasing Receiving component triggers the publication

of the Purchase Order Receipt Notification EIP to the POU supplier. This service operation identifies all direct-purchase items and quantities that have been received and are being delivered to specified locations.

Run the Receiver Interface Push Application Engine process (PO_RECVPUSH) to stage the PO_RECEIPT_NOTIFICATION service operation data.

Setting Up the Purchase Order Receipt Notification EIP

PeopleSoft delivers the service operations in PeopleSoft Integration Broker with a default status of *Inactive*. You must activate each service operation before attempting to send or receive data from a third-party source or another PeopleSoft system, such as CRM.

Before you can use the Purchase Order Receipt Notification EIP, you must setup the service operation within PeopleSoft Integration Broker and Enterprise Components:

Use the information in the table below and refer to the setup instructions in the *PeopleSoft Supply Chain Management Integration 9.2*.

Service Operation	Direction and Type	Handlers	Chunking Available?	Integrates With
PO_RECEIPT_NOTIFICATION	Outbound Asynchronous	ROUTERSENDHDLR	Yes	third-party system surgical resource software point of use (POU) supplier

Processing the Purchase Order Receipt Notification EIP

Run the Receiver Interface Push process to process the Purchase Order Receipt Notification EIP.

Receiving material against a purchase order in the PeopleSoft Purchasing Receiving component triggers the processing of a service operation to the POU supplier using the Purchase Order Receipt Notification EIP. This service operation identifies all direct-purchase items and quantities that have been received and are being delivered to specified locations. The Receiver Interface Push process loads the stage table (RECV_PUSH_NTIFY). If a chunking rule for the service operation exists, then the system creates staging records for only those par location receipt transactions where the par location is defined on the par location chunking table (IN_BU_PAR_EOC). If the chunking rule does not exist, then staging records is created for all par location receipt transactions. Once the stage table is loaded, it calls the program that in turn processes the receipt notification service operation.

Loading Receipts Received Using EIPs and EDC

This section provides an overview of the Receive Load process

Pages Used to Load Receipts Received by EIPs and EDC

<i>Page Name</i>	<i>Definition Name</i>	<i>Usage</i>
<u>Receiver Load Page</u>	RUN_RECVLOAD	Run the Receive Load process.
Select Purchase Order	PO_PICK_ORD2	Select purchase order items and attributes that you want to process through the Receive Load process. <u>Receiver Load Page</u>

Understanding the Receive Load Process

The Receive Load Application Engine process (PO_RECVLOAD) enables you to load transactions into the PeopleSoft Purchasing tables. Receipts can be received through the following methods:

- ASR enterprise integration point (EIP).
- PO Receipts EIP.
- Electronic data collection (EDC) system.
- Supplier-entered advance shipping notifications (PeopleSoft eSupplier Connection is required).

These transactions enable you to bypass manual receipt entry using the Maintain Receipts - Receiving page.

The Receive Load process requires that a purchase order exists before a receipt can be created and that receiving is required for the purchase order line. The Receive Load process excludes purchase order lines that have receiving required as *X* Do Not Receive. Therefore, it is only able to create purchase order-related receipts. The process does not load non-purchase order receipts.

Loading ASR Transactions

When you load ASR transactions, the Receive Load process uses the purchase order number, line, and schedule number on the ASR transaction to select the PO schedule to be received. The quantity on the ASR transaction is used as receipt quantity as long as the PO schedule is open for receipt

Note: ASR transactions can include supplier-created ASNs from PeopleSoft eSupplier Connection. Cascading is not applicable in loading ASR transactions.

Loading EDC Transactions

When we load EDC transactions, the Receive Load process uses the purchase order line number and line quantity to allocate or cascade quantities to all open or not received schedules. Allocations are done on a sequential basis. If the purchase order line quantity is 100:

- Schedule 1 quantity is 20, status is open.
- Schedule 2 quantity is 30, status is closed or already received.

- Schedule 3 for a quantity of 20, status is open.
- Schedule 4 for a quantity of 30, status is open.

If the EDC is for a quantity of 100:

- 20 will be allocated to schedule 1.
- 20 will be allocated to schedule 3.
- 60 will be allocated to schedule 4, which will result in an over shipment.

If you are using an EDC system to load receiving transactions, load the receipt data to the data collection transaction log.

Loading WMS Transactions Using the PO Receipts EIP

If you use a warehouse management system (WMS) application, the transactions are loaded from the WMS application like the EDC transactions. However, in the receipt confirmation transaction from the WMS application, the inventory business unit can be included to associate receipts to the appropriate distribution line. If the inventory business unit is included, the receipt quantity is applied to that business unit distribution line. If you have selected the Allow Receipt Load Cascade check box on the Purchasing Definition - Business Unit Options page, the receipt quantity is applied against the next schedule. This applies only to WMS 0103 transactions.

If the receipt confirmation transaction from the WMS application includes a storage location, the storage location sent from the WMS application overrides the default storage location for the putaway of the item.

Receiver Load Page

Use the Receiver Load page (RUN_RECLOAD) to run the Receive Load process.

Navigation:

- **Purchasing > Receipts > Load Receipts > Receiver Load**
- **SCM Integrations > Process Transactions > Load Purchase Order Receipts > Receiver Load**

<i>Field or Control</i>	<i>Description</i>
Receiver Load Options	<p>Fields on this page hide and appear depending on the value that you enter in the Receiver Load Options field. Select one of the following options in the Receiver Load Options field to access the associated page function.</p> <p><i>Load Data Collect Trans</i> (load data collection transactions): Select to process data collection transactions that are in the transaction log. This includes transaction data received using EDC and WMS systems.</p> <p><i>Load ASR Transactions</i> (load ASR transactions): Select to load ASR transactions, also known as ASN transactions, into the purchasing tables.</p>

Field or Control	Description
Use Current UOM Conv Rate (use current unit of measure conversion rate)	<p>Select this check box to use the current unit of measure conversion rate. If you do not select this check box, the system calculates the standard quantity using the purchase order conversion rate.</p> <hr/> <p>Note: This check box is only available when PeopleSoft Inventory is installed. When Inventory is not installed, the system always calculates the standard quantity using the current conversion rate.</p>
Use PO Unit as Receipt Unit (use purchase order unit as receipt unit)	<p>Select to set the receipt business unit value on the ASN transactions equal to the purchase order business unit value. When the system inserts the receipt later in the process, the receipt business unit will have the same value as the purchase order business unit. The receipt load default values for the receipts being loaded will be those in the Business Unit record for the receipt business unit value.</p>

Loading EDC Transactions Using the Receive Load Process

Access the Receiver Load page and select *Load Data Collect Trans* in the **Receiver Load Options** field (Purchasing, Receipts, Load Receipts, Receiver Load).

Use this version of the page to process data collection transactions in the transaction log.

The Load Data Collection Transactions process, like the other data collection processes, is set up to scan the transaction log continuously as long as there are transactions in the log. If no transactions are in the log when a process scans the log, the process shuts down and can be restarted by the PeopleSoft Process Scheduler. Use of PeopleSoft Process Scheduler with this background process ensures that it runs continuously.

Loading ASR Transactions Using the Receive Load Process

Access the Receiver Load page and select *Load ASR Transactions* in the **Receiver Load Option** field (Purchasing, Receipts, Load Receipts, Receiver Load).

Use this version of the page to load ASR transactions into the Purchasing tables.

Processing Receipts

This section provides an overview of the receipt processes and discusses how to:

- Use the Receiver Interface Push Application Engine process (PO_RECVPUSH).
- Use the Receipt to Inventory & AM multiprocess job (RECV_03).
- Use the Receipt + INV + MFG + AM multiprocess job (RECV_07).

- Use additional receipt processes.

Page Used to Process Receipts

<i>Page Name</i>	<i>Definition Name</i>	<i>Usage</i>
<u>Process Receipts Page</u>	RUN_PO_RECEIPT	Define parameters to run the Receiver Interface Push processes.

Understanding the Receipt Processes

PeopleSoft Purchasing provides several multiprocess jobs to use when processing receipts. Working together, these processes load receipt information into PeopleSoft application tables managed by the PeopleSoft Inventory putaway process, PeopleSoft Asset Management asset load process, and PeopleSoft Manufacturing routing and completions update process.

Depending on individual receipt characteristics, each receipt transaction should be processed by at least one of these processes. A receipt's status changes from *Received* to *Moved* once it has been successfully processed.

Note: These processes also generate receipt landed cost transactions and any applicable receipt notification messages. For this reason, it is important to run these processes on all receipts.

Using the Receiver Interface Push Application Engine Process (PO_RECVPUSH)

The Receiver Interface Push process moves data to the PeopleSoft application interface table, where it is picked up by the different batch processes. This process is one of the processes in all of the receipt multiprocess jobs.

Before a receipt can be a candidate for the independently run Receiver Interface Push process, the following criteria must be true:

- The **Items for Auto-Putaway** check box on the User Preferences - Inventory page must be selected. If this check box is not selected, the item is staged for inventory.
- The receipt's status must be *Received*.
- The **Hold Receipt** check box on the Maintain Receipts - Header Details page must be clear.
- The **Interface Receipt** check box on the User Preferences - Procurement: Receiver Setup page must be selected. If the user's option for interface receipt is set to *Y*, then the value on the receipt changes to *Y*, and unless overridden on the receipt, the Receiver Interface Push process is invoked when the receipt is saved.

You can also run the Receiver Interface Push processes from the Process Receipts page.

Multiple Requisition and Purchase Order Lines Consolidated for Assets

The Receiver Interface Push (PO_RECVPUSH) process accommodates the use of Procurement Groups. When an item is flagged as a primary item, a separate transaction is inserted into the INTFC_PRE_AM record in increments of the unit allocation quantity or amount if the Allocate Purchasing Group option is enabled on the Purchasing Options page. [Purchasing Options Page](#)

The allocation quantity (or amount) units have already been parsed in the Receipt Asset Lines (by online Receipts) by this point (also contingent on the Allocate Purchasing Group option). The Receiver Interface Push process then moves that data to the INTFC_PRE_AM record, reconciles remainders (fractional allocation quantities or amounts), and assigns each transaction a Procurement Group Sequence. Each non-primary item in the procurement group is assigned the Procurement Group Sequence that is associated with the primary unit

See “Consolidating Requisition and Purchase Order Lines for Asset Components” (Asset Lifecycle Management Fundamentals).

Using the Receipt to Inventory & AM Multiprocess Job (RECV_03)

The Receipt to Inventory & AM process processes receipts that contain inventory-related lines, asset-related lines, or lines that contain both.

The Receipt to Inventory & AM multiprocess job runs these processes automatically:

- Receiver Interface Push process.
- PeopleSoft Inventory Load Staged Items process (INPSSTGE).
- PeopleSoft Inventory Putaway Plan report (INS3500).
- PeopleSoft Inventory Putaway process (INPPPTWY).
- PeopleSoft PO/AP/AM Interface process (AMPS1000).
- PeopleSoft Asset Transaction Loader (AMIF1000).

Also, other receipt multiprocess jobs are provided to assist you with receiving receipts that contain inventory related lines only or asset related lines only. These processes are:

- Receipt Push Inventory multiprocess job (RECV_01).

This process runs these processes automatically:

- Receiver Interface Push process.
 - PeopleSoft Inventory Load Staged Items process (INPSSTGE).
 - PeopleSoft Inventory Putaway Plan report (INS3500).
 - PeopleSoft Inventory Putaway process (INPPPTWY).
- Receipt Push Assets multiprocess job (RECV_02).

This process runs these processes automatically:

- Receiver Interface Push process.
- PeopleSoft PO/AP/AM Interface process (AMPS1000).
- PeopleSoft Asset Transaction Loader (AMIF1000).

Note: Care should be taken when modifying the PeopleSoft Job Definitions used to process receipts. PS Job RECV_INV must be the second job in the PS Job submitted to process any inventory related receipts. Otherwise the receipt transactions will not be processed by the inventory processes. This rule applies to PS Jobs RECV_01, RECV_01G, RECV_03, and RECV_03G. Modifications to PS Job RECV_INV should only be done with PeopleSoft Inventory product support direction.

Before a receipt can be a candidate for the Receipt to Inventory & AM multiprocess job, the following criteria must be true:

- Criteria discussed in the Processing Receipts and Using the Receiver Interface Push Application Engine Process sections must be met.
- The **Hold Inventory** check box on the Maintain Receipts - Header Details page must be clear to enable the process to move received items to PeopleSoft Inventory.
- The **Hold Assets** check box on the Maintain Receipts - Header Details page must be clear to enable the process to move received items to PeopleSoft Asset Management.

The Receipt to Inventory & AM multiprocess job inserts any applicable putaway rows from the receipt and loads them into the Putaway staging table for the inventory putaway segment of the process.

When a receipt requires corrections to asset-applicable lines, assets previously interfaced can have their quantities both increased or decreased. In addition, if an asset row is canceled on the receipt, a retirement transaction is created and sent to PeopleSoft Asset Management.

Notifications of the receipt of subcontracted purchases are routed to PeopleSoft Manufacturing through the Receipt to Inventory & AM multiprocess job. The identifying keys of the Production ID from the original request, along with details about the receipt are passed to the Manufacturing receipt process. When a subcontracted receipt is updated, the Manufacturing receipt process is notified of any changes to the accepted and rejected quantities.

When processing a receipt for a subcontract line that is marked for subcontract streamline and that has a data collection receipt source, transaction log entries are created that are later processed by PeopleSoft Manufacturing batch processing. When processing a last operation receipt, Subcontract Receipt to Stock (0112) transactions are created. Otherwise, Subcontract Receipt Operation (0113) transactions are created.

The successful completion of this process generates landed cost transactions. After these transactions are generated, the process complete status on the receipt line is set to *Yes*. In addition, receipt notification messages are generated for applicable PeopleSoft Inventory par locations for non-inventory receipt.

You can run the Receipt to Inventory & AM multiprocess job from the Process Receipts page.

Related Links

“Understanding How PeopleSoft Asset Management Integrates with Other Applications” (Asset Lifecycle Management Fundamentals)

“Understanding Receiving and Putaway Processing” (PeopleSoft Inventory)

Using the Receipt + INV + MFG + AM Multiprocess Job (RECV_07)

The Receipt + INV+ MFG + AM process processes receipts that contain inventory-related lines, asset-related lines, and subcontracted related lines.

The Receipt + INV + MFG + AM multiprocess job runs these processes automatically:

- Receiver Interface Push process.
- PeopleSoft Inventory Load Staged Items process (INPSSTGE).
- PeopleSoft Inventory Putaway Plan report (INS3500).
- PeopleSoft Inventory Putaway process (INPPPTWY).
- PeopleSoft Manufacturing Completions and Scrap Update process (SFPDCDRV).
- PeopleSoft Asset Management PO/AP/AM Interface process (AMPS1000).
- PeopleSoft Asset Management Transaction Loader (AMIF1000).

Also, other receipt multiprocess jobs are provided to assist you with receiving receipts that contain subcontracting related lines only, subcontracting and asset related lines only, or subcontracting and inventory related lines only. These processes are:

- Receipt Push + MFG multiprocess job (RECV_04).

This process runs these processes automatically:

- Receiver Interface Push process
 - PeopleSoft Manufacturing Completions and Scrap Update process (SFPDCDRV).
- Receipt + INV + MFG multiprocess job (RECV_05).

This process runs these processes automatically:

- Receiver Interface Push process
 - PeopleSoft Inventory Load Staged Items process (INPSSTGE).
 - PeopleSoft Inventory Putaway Plan report (INS3500).
 - PeopleSoft Inventory Putaway process (INPPPTWY).
 - PeopleSoft Manufacturing Completions and Scrap Update process (SFPDCDRV).
- Receipt + MFG + AM multiprocess job (RECV_06).

This process runs these processes automatically:

- Receiver Interface Push process
- PeopleSoft Manufacturing Completions and Scrap Update process (SFPDCDRV).
- PeopleSoft Asset Management PO/AP/AM Interface process (AMPS1000).

- PeopleSoft Asset Management Transaction Loader (AMIF1000).

If the Interface Receipt check box and the Subcontract Streamline check box are both selected on the receipt, then one of the multiprocess jobs is submitted to the process scheduler upon saving the receipt using the Maintain Receipts - Receiving page. The type of receipt related lines determine which job is submitted by the system.

Related Links

“Understanding Asset Management Business and Cash Generating Units” (Asset Lifecycle Management Fundamentals)

“Understanding Asset Processing” (Asset Lifecycle Management Fundamentals)

“Understanding Receiving and Putaway Processing” (PeopleSoft Inventory)

“Understanding Recording Completions and Scrap” (PeopleSoft Manufacturing)

Using Additional Receipt Processes

Use additional receipt processes to process receipts that contain inventory-related lines, asset-related lines, or subcontracted related lines. Use PeopleSoft Process Scheduler to run one or more of the following additional receipt multiprocess jobs:

- Assets Interface (RECV_AM).
- Inventory Putaway (RECV_INV).
- Recv Push and Accrual (RECV_00G)
- Recv Push and Accrual (RECV_GL).
- Receipt Accrual and Inventory Interface (RECV_01G).
- Receipt Accrual and AM Interface (RECV_02G).
- Recv Push and Accrual to Inventory and Asset Management (RECV_03G).
- Receipt Accrual (RECV_G).
- Receipt Push + MFG + Accrual (RECV_04G).
- Receipt + INV + MFG + Accrual (RECV_05G).
- Receipt + MFG + AM + Accrual (RECV_06G).
- Receipt + INV + MFG + AM + Accrual (RECV_07G).

Note: Job names ending in the letter G means the receipt accrual process is being requested as well.

Process Receipts Page

Use the Process Receipts page (RUN_PO_RECEIPT) to define parameters to run the Receiver Interface Push processes.

Navigation:

Purchasing > Receipts > Process Receipts

<i>Field or Control</i>	<i>Description</i>
Autogenerate Labels	Select this check box to generate labels for the receipt using the PO Receipt Labels report page.

Running the Close Short Process

This section discusses how to submit the Close Short process.

Page Used to Run the Close Short Process

<i>Page Name</i>	<i>Definition Name</i>	<i>Usage</i>
<u>Close Short Page</u>	RUN_RECV_CLOSE_BO	Submit the Close Short process for a specified business unit.

Close Short Page

Use the Close Short page (RUN_RECV_CLOSE_BO) to submit the Close Short process for a specified business unit.

The Close Short process (PO_CLSSHORT) creates the batch purchase order change requests, but does not update the purchase order. The Process Change Orders batch program must be run subsequently to update the purchase orders. The Close Short process creates the change order transactions for the purchase orders.

You define close short settings for receipt lines using the Receiving page. Use the Receiving tab on the Purchase Order page or the Close Short Workbench to define close short settings for purchase orders. You can run the Close Short process from this page, from the Purchase Order page, or using the Close Short Workbench job.

Navigation:

Purchasing > Receipts > PO Close Short Process

<i>Field or Control</i>	<i>Description</i>
Business Unit	Enter the business unit for which you want to run the Close Short process.

Field or Control	Description
Close Days	Enter the number of days that an entire purchase order can remain open without receipt activity when the Close Short check box has been selected for the line. The system cancels those purchase order lines that exceed the close days value.

Working with Landed Costs on Receipts

This section provides an overview of landed costs on Receipts

Pages Used to Work with Landed Costs on Receipts

Page Name	Definition Name	Usage
LC Manual Close (landed cost manual close) Page	CM_LC_MANU_CLOSE	View and enter details about landed costs applied to a receipt and the vouchers created to pay for them. Perform manual overrides, closing individual or all landed cost lines associated with the selected receipt line.
Voucher Details Page	CM_LC_MANU_CLS_VC	View voucher details for the selected landed cost applied to the receipt line.

Understanding Landed Costs

Landed costs are miscellaneous charges that you can add to a purchase order in addition to sales and use tax and VAT. If PeopleSoft Cost Management is installed, you can use the landed cost charges in PeopleSoft Cost Management to calculate the actual cost of an item.

If PeopleSoft Cost Management is not installed, you can still define a landed cost miscellaneous charge on the Misc Charge/Landed Cost Defn page. You can then set up PeopleSoft Purchasing to calculate the landed cost automatically based on items and item suppliers using the Miscellaneous Charges - Miscellaneous page, or you can manually add landed costs charges on the purchase order. Receipt lines generated at receiving push time are assigned these estimated landed costs from their associated purchase order schedules.

PeopleSoft provides landed cost reports, such as the Estimate vs. Actual Landed Cost report (CMS3000), Total Purchase Variance report (CMS3010), and Standard Purchase Variance report (CMS3020) to assist you in landed cost analysis.

Related Links

[Understanding Miscellaneous Charges](#)

LC Manual Close (landed cost manual close) Page

Use the LC Manual Close (landed cost manual close) page (CM_LC_MANU_CLOSE) to view and enter details about landed costs applied to a receipt and the vouchers created to pay for them.

Perform manual overrides, closing individual or all landed cost lines associated with the selected receipt line.

Navigation:

Purchasing > Receipts > Close Landed Costs > LC Manual Close

Receipt Line Charges

Field or Control	Description
Close	Select this check box at the header level to close all landed cost lines for the selected receipt. Select at the line level to close an individual landed cost line.
LC Status (landed cost status)	Displays the landed-cost status of the selected receipt line. Values are: <i>Open:</i> The landed cost status for the receipt line remains in an <i>Open</i> status until all landed cost voucher lines have a <i>Closed</i> status. <i>Closed:</i> The landed cost status for the receipt line changes to <i>Closed</i> when all of the landed cost voucher lines have a <i>Closed</i> status.
Misc Chg (miscellaneous charge)	Displays the miscellaneous charge code assigned to the landed cost charged to the receipt line. Click this link to access the Voucher Details page.
Charge Amount	Displays the estimated landed costs from the purchase order schedule.
Voucher Amt (voucher amount)	Displays the actual amount paid on the voucher for the landed cost. This value appears by default from the accounts payable system.
Voucher Qty (voucher quantity)	Displays the actual landed cost item quantity accounted for on the voucher. This value appears by default from the accounts payable system.

Field or Control	Description
Amount Variance %	Displays the percentage by which the landed cost charge amount value varies from the landed cost voucher amount value.
Quantity Variance %	Displays the percentage by which the landed cost accept quantity value varies from the landed cost voucher quantity value.
Amount Tolerance %	Displays the percentage by which the actual landed cost (voucher amount value) can be more or less than the estimated landed cost (charge amount value). This value enables the charge to be automatically closed for landed costs when the voucher amount is within tolerance of the charge (purchase order) amount.
Quantity Tolerance %	Displays the percentage by which the actual landed cost quantity (voucher quantity value) can be more or less than the estimated landed cost quantity (accept quantity value).

Note: A receipt cannot be reconciled unless the amount and quantity variances are within the amount and quantity tolerances.

Voucher Details Page

Use the Voucher Details page (CM_LC_MANU_CLS_VC) to view voucher details for the selected landed cost applied to the receipt line.

Navigation:

Click the **Misc Chg** link on the LC Manual Close page.

Matching Vouchers

Field or Control	Description
Voucher Qty Converted (voucher quantity converted)	Displays the original quantity of items received on this receipt line.
Charge Amount Converted	Displays the original estimated landed cost charge from the purchase order schedule.

Field or Control	Description
Charge Amount	Displays the actual landed cost charge paid on the voucher converted from the estimated landed cost on the purchase order schedule using the voucher currency and UOM (unit of measure).
UOM Vchr (unit of measure voucher)	Displays the unit of measure assigned to the landed cost quantity on the voucher.
Quantity Vouchered	Displays the landed cost quantity vouchered after conversion to the UOM of the voucher.

Closing Receipts

This section provides an overview of the Close Receipts process and lists the page used to run the Close Receipts process.

Page Used to Close Receipts

Page Name	Definition Name	Usage
Close Receipts Page	RUN_PO_RECV_COM	Run the Close Receipts process.

Understanding the Close Receipts Process

Use the Close Receipts Application Engine process (PO_RECV_COM) to close and assign a *Closed* status to receipt schedules that have been interfaced to assets, inventory, or manufacturing (if required) and matched (if required).

When you add a new run control or change the business unit value, the system derives the **Close Days** field default value from the PeopleSoft Purchasing business unit table (BUS_UNIT_TBL_PM.RCPT_CLOSE_DAYS). The numeric value can then be changed. The Receipt Close process then uses the **Close Days** field value from the run control when determining if a receipt is eligible for closing. The process subtracts the **Close Days** value from the current date time value and compares it to the receipt header **Last Change Date** field value. The system does not change the receipt status to a Complete status unless the last change date on the receipt header is less than or equal to the current date minus the **Close Days** field value.

Closing a receipt prevents maintenance from being performed on the receipt because the receipt is no longer visible in the receipt update option. You can use the Receipts inquiry page to view closed receipts.

The receipt line has a *Closed* status when all the required interfaces for the line have been satisfied (moved to inventory, assets, and / or manufacturing, as well as matching). The receipt header has a *Closed* status when all line items have been identified *Closed*. A receipt can have some lines in an *Open* status

and other schedules and lines that have been *Closed*. Canceled lines are ignored in determining the status of the receipt.

Generating Receiving Labels

This section provides an overview of barcode label generation and lists the page used to generate receiving labels.

Page Used to Generate Receiving Labels

<i>Page Name</i>	<i>Definition Name</i>	<i>Usage</i>
PO Receipt Item Usage Labels Page	RUN_PORC_USG_LBL	Define parameters for the PO Receipt Item Usage Labels flat file that you want to produce.

Understanding Barcode Label Generation

Use the PO Receipt Item Usage Labels page to generate the Receipt Item Usage Label SQR Report (PORC920). This report provides for barcode scanning in the warehouse, on the manufacturing floor, or later in the supply chain. You can print barcode labels from PeopleSoft through an in-house or third-party bar code label product.

Note: PeopleSoft SCM applications do not support the printing of bar codes from processes running on OS390 servers. You should run your SQRs that print barcodes on a process scheduler server that is running on a non-OS390 operation system.

To generate barcode labels:

1. Set up the attributes for each label type on the Data Collection Label Setup page.
2. Generate a flat file containing the label data by running a PeopleSoft Process Scheduler SQR program from the label-specific run control page.
3. Pass the flat file to an in-house or a third-party barcode label product to print the labels.

In PeopleSoft Purchasing, you can use the PO Receipt Item Usage labels page to create:

- A flat file to produce receipt labels that are used to track received items.

Receiving labels can be generated for each item on a receipt.

- A flat file to produce item usage labels for items that are to be delivered to point-of-use locations directly upon receiving.

Using the Receiver's Workbench

Understanding the Receiver Workbench

Receiver Workbench provides users with the ability to analyze, review, and manage receipts in a workbench. The user can define the criteria to search for receipts to review, select those into the workbench, perform validation and identify the receipts are qualified for further processing. You can manage selected receipts to be further processed through the Receipt Interface, Receipt Accruals, and closing receipts.

You can setup the **Receipt Close Delay Days** on the PO Business Unit to indicate how many days to close the receipt since it was last updated. This is used in determining when to close the receipt. Users can close non qualified receipts if the **Override Non Qualified Receipt for Close** field is enabled on the **Receiver/RTV Setup** link in the User Preference - Procurement page. An example would be if the good or services have been received and AP matching is required on the receipt, but for some reasons the AP voucher is not matched to the receipt. This will keep the receipt from closing and appearing on the receipt accrual account. You will be able to force close these receipts.

The Receiver Workbench can be used to also reopen selected closed receipts if the receipt were closed early. The user can also use the Workbench to cancel selected receipts.

Managing Receipts Using the Receiver Workbench

This section discusses how to manage receipts in Receiver Workbench.

Pages Used to Manage Receipts in Receiver Workbench

<i>Page Name</i>	<i>Definition Name</i>	<i>Usage</i>
<u>Receiver Workbench – Search Page</u>	PO_RECV_WB	Enter selection criteria for the receipts that you want to display on the Receiver Workbench
<u>Receiver Workbench – Process Request Options</u>	PO_RECV_WB_PRCS	Use to set the run control and processing action specific values.
<u>Receiver Workbench – Processing Results Page</u>	PO_RECV_WB_PRCS	View which receipts are qualified and which are not qualified before submitting them for final processing

Page Name	Definition Name	Usage
<u>Receiver Workbench – Workbench Log Page</u>	PO_RECV_WB_LOG	View the message text stating why a receipt was not qualified for processing.

Receiver Workbench – Search Page

Use the Receiver Workbench – Search page (PO_RECV_WB) to enter selection criteria for the receipts that you want to display on the Receiver Workbench page.

Navigation:

Purchasing > Receipts > Receiver Workbench

This example illustrates the fields and controls on the Receiver Workbench - Search page. You can find definitions for the fields and controls later on this page.

Receiver Workbench

Business Unit US001
WorkBench ID 1001

*Description

Search Criteria

Receipt ID From <input type="text"/>	Receipt ID To <input type="text"/>
From Receipt Date <input type="text"/>	To Receipt Date <input type="text"/>
Shipment Number <input type="text"/>	Supplier ID <input type="text"/>
Receipt Status <input type="text"/>	Ship To Location <input type="text"/>
Receive Source <input type="text"/>	<input checked="" type="checkbox"/> PO Receipt
PO Business Unit <input type="text"/>	PO ID <input type="text"/>
Bill of Lading <input type="text"/>	User ID <input type="text"/>
Item ID <input type="text"/>	Description <input type="text"/>
Category Code <input type="text"/>	Supplier Item ID <input type="text"/>
Manufacturer's Item ID <input type="text"/>	Process Complete <input type="text"/>
Procurement Group ID <input type="text"/>	AM Move Status <input type="text"/>
Receipt Line Status <input type="text"/>	Mfg Move Status <input type="text"/>
Inventory Move Status <input type="text"/>	Serialization Status <input type="text"/>
Lot Assigned Status <input type="text"/>	ERS Status <input type="text"/>
Matching <input type="text"/>	Receipt Match Status <input type="text"/>
Inspection Status <input type="text"/>	Packing Slip Number <input type="text"/>
UPN ID <input type="text"/>	Invoice Number <input type="text"/>
<input type="button" value="Search"/>	<input type="button" value="Clear All"/>

This example illustrates the fields and controls on the Receiver Workbench - Search Results. You can find definitions for the fields and controls later on this page.

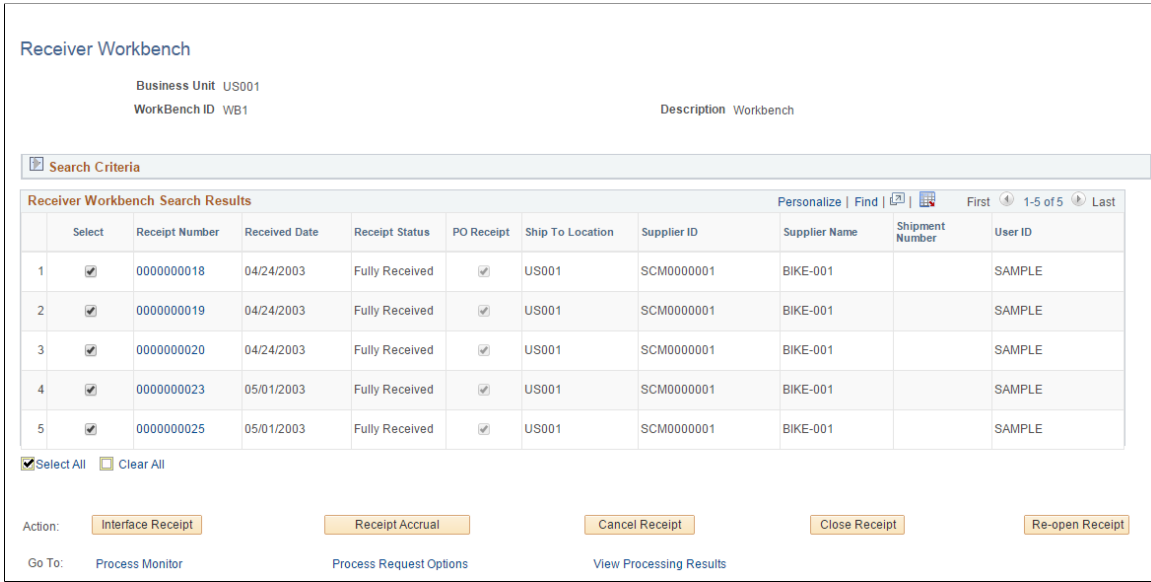

Search Criteria

Use this page to define search criteria for the receipts you want to retrieve. The **Action** buttons will be made available after you enter the values and click on the **Search** button. In case there are no results derived from the search results the message “No matching rows were found” will be displayed.

The rows retrieved will be limited to the “Max rows to retrieve for Receiver Workbench” in the Installation set up.

Field or Control	Description
Search	Push to search for receipts based on the search criteria entered.
Clear All	Push to clear all search results and search criteria.

Action

Field or Control	Description
Interface Receipt	Select to submit the Process Receipts jobs to the process scheduler for the selected receipts. The process receipts (RECV_07) will only process those receipts where there is unprocessed data. For example, it will not push a receipt line to inventory if it was already processed in a previous execution.

Field or Control	Description
Receipt Accrual	Select to submit the Receipt Accrual process to the process scheduler for the selected receipts.
Cancel Receipt(s)	<p>Select to cancel the selected receipts. The cancel receipt functionality is equivalent to the header level receipt cancel on the online receipt page.</p> <p>The receipts that have not been interfaced to other products will be placed in the "Qualified" list on the Processing Results page.</p> <hr/> <p>Note: The Cancel Receipt process uses CI PO_RECV_WB_VAL_CI and PO_RECV_WB_CNCL_CI. Users who need to perform this Cancel Receipt action will also need security access to these CIs.</p>
Close Receipt	<p>Select to perform close processing on the selected receipts.</p> <p>Receipts that have been fully interfaced and meet the Receipt Close Delay Days requirement will be placed in the "Qualified" list on the Processing Results page. To be fully interfaced all lines on the selected receipts should have:</p> <ul style="list-style-type: none"> • Process Complete equal to "Yes" after the Process Receipt job completed (PO_RECVPUSH) • Asset Management Move status equal to "Moved" or "N/A" • Inventory Move status equal to "Moved" or "N/A" • Manufacturing Move status equal to "Moved" or "N/A" • Receipt Match Status equals to "Matched" if Matching is required for the receipt line. <hr/> <p>Note: The Receipt Close process saves the current status from the receipt header, line, distribution, and asset records in a Previous Close Status field on corresponding tables RECV_WB_HDR, RECV_WB_LN_SHIP, RECV_WB_DISTRIB, and RECV_WB_ASSET. You can view the Previous Close Status on the Receipt Inquiry pages.</p>

Field or Control	Description
Re-open Receipt	<p>Select to reopen closed receipts. Receipts that have been cancelled will not qualify for reopening.</p> <hr/> <p>Note: The Receipt Reopen functionality sets the current status on the receipt header, line, asset and distribution records to the Previous Close Status from corresponding tables RECV_WB_HDR, RECV_WB_LN_SHIP, RECV_WB_DISTRIB, and RECV_WB_ASSET. The data on these tables for the reopened receipts is then deleted.</p> <hr/>

Go To Options

Field or Control	Description
Process Monitor	Click to access the Process Monitor page, where you can view the status of the submitted receipt process.
Process Request Options	Click to transfer to the Process Options page, where the run control and processing action specific values can be set.
View Processing Results	Click to access the Processing Results page, where you can view the results of the most recent, pending action taken. This link is only visible when there are pending processing results from the prior action taken. Processing results are pending when the user has pressed the 'Return to Receiver Workbench' link on the Processing Results page rather than elected to proceed or not proceed with the most recent action.

Receiver Workbench – Process Request Options

Use the Receiver Workbench - Process Request Options Page (PO_RECV_WB_PRCS) to set the run control and processing action specific values.

Navigation:

Purchasing > Receipts > Receiver Workbench > Process Request Options

This example illustrates the fields and controls on the Receiver Workbench – Process Request Options Page. You can find definitions for the fields and controls later on this page.

Process Request Options

Business Unit US001

WorkBench ID TEST

Run Control ID

Server Name 

Receipt Close

Receipt Close Delay Days

Receipt Accrual

Accounting Date 

Default Entry Event Code 

Receipt Close

<i>Field or Control</i>	<i>Description</i>
Receipt Close Delay Days	Indicates the minimum number of days that must pass since a receipt was last updated to make it eligible for closing.

Receipt Accrual

<i>Field or Control</i>	<i>Description</i>
Accounting Date	Enter the accounting date.
Default Entry Event Code	Select this option to use the entry event default value.

Receiver Workbench – Processing Results Page

Use the Receiver Workbench - Processing Results page (PO_RECV_WB_PRCs) to view, which receipts are qualified and which are not qualified before submitting them for final processing.

Navigation:

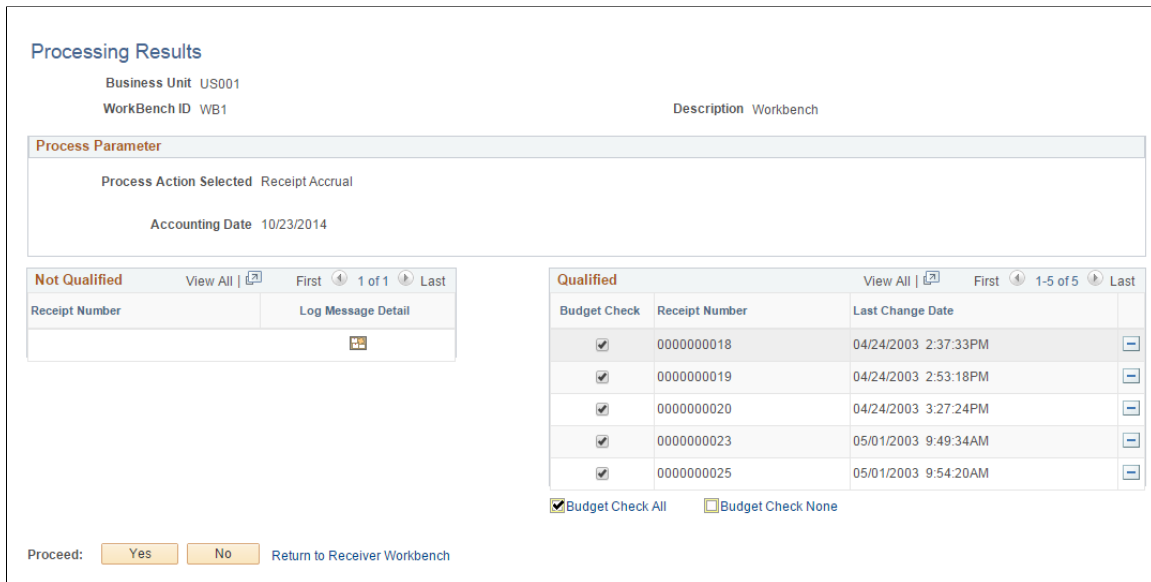

Purchasing > Receipts > Receiver Workbench > View Processing Results

This example illustrates the fields and controls on the Receiver Workbench - Processing Results page. You can find definitions for the fields and controls later on this page.



The system reviews the selected receipts for the action taken on the Receiver Workbench search page to determine whether they are qualified for that action.

Field or Control	Description
	Click the Log Message Detail icon to access the Receiver Workbench - Processing Log page. This page is a log for the selected receipts that are not qualified for the previously selected action.
Yes	Click this button to proceed with the processing of the qualified receipts.
No	Click this button to cancel the processing of the receipts. The data in the Processing Results page will be removed and then the user will be returned to the Search page.
Return to Receiver Workbench	Click to transfer to Receiving Workbench Search page.
Budget Check	Select Budget Check next to a receipt to direct the Receipt Accrual process to call the Budget Checking process for the accruals created for that receipt. The checkbox is available for the Receipt Accrual action provided that Commitment Control is enabled for Receipt Accrual
Budget Check All	Select to turn on the Budget Check check box for all rows in the Qualified grid.

Field or Control	Description
Budget Check None	Select to turn off the Budget Check check box for all rows in the Qualified grid.
	Click the Override Icon (arrow) to move selected receipts from the Not Qualified grid to the Qualified grid for further processing. Currently, this icon is only available for the Close Receipts action and is used to force close receipts provided that the user has the authority. The authority to 'Override Non-Qualified Receipts for Close' can be granted on the User Preferences - Procurement: Receiver / RTV page. <hr/> Note: Any accrual related accounting entries will have to be corrected manually on force closed receipts.
	Click to display the receipt cancel warnings for a receipt <hr/> Note: The Warning button will be displayed only in case of Cancel Action. The log page would display the warning message only when the Log/Warning buttons are pressed for cancel action.

Receiver Workbench – Workbench Log Page

Use the Receiver Workbench – Workbench Log Page (PO_RECV_WB_LOG) to view the message text stating why a receipt was not qualified for processing.

Navigation:

Purchasing > Receipts > Receiver Workbench











Click on the **Log** icon.

This example illustrates the fields and controls on the Receiver Workbench Log page.

Receiver WorkBench Log

Business Unit US001 WorkBench ID E-R-WB

Receipt ID 0000000031

Log				Personalize Find View All  	First  1-3 of 3  Last
Receipt Line	Message Number	Message			
1	1	105 Receipt line not eligible to close, requires matching and Match Status is not Matched.			
2	2	105 Receipt line not eligible to close, requires matching and Match Status is not Matched.			
3	3	105 Receipt line not eligible to close, requires matching and Match Status is not Matched.			

Working with Delivery Information

Understanding Delivery Information

The pages in the PeopleSoft Purchasing Delivery component enable you to identify the final destination for received goods, as well as view location and ship to information relevant to the delivery of the received goods. The information maintained on these pages exists at the receipt distribution level and originated from either the requisition or the purchase order. Delivery information becomes available only after the item has been received.

Also integrating with the Delivery component is the Mobile Inventory Management application. The application provides tools to integrate mobile devices to the PeopleSoft Supply Chain Management system including mobile deliveries. This enables you to take advantage of the cost savings and efficiency improvements inherent in processes driven by mobile devices.

When stock arrives at the receiving location, remote users can receive it using the Mobile Receiving. After receiving the stock, they can use Mobile Delivery, to record the final destination for delivered items, view location and ship to information relevant to the delivery of the items, and to whom the items were delivered. Delivery information exists at the receipt distribution level and originates from either a requisition or purchase order. The recorded results of deliveries are sent back to the PeopleSoft system using a component interface based on the RECV_DELIVERY component.

The Delivery Inquiry supports deliveries made with mobile devices through PeopleSoft Mobile Inventory Management.

Related Links

“Understanding How to Record Deliveries in PeopleSoft Purchasing Using Mobile Inventory Management” (PeopleSoft Mobile Inventory Management)

Accessing Delivery Information

This section discusses how to access delivery information:

Pages Used to Access Delivery Information

<i>Page Name</i>	<i>Definition Name</i>	<i>Usage</i>
Maintain Delivery Information - Delivery Location Page	RECV_DELIVERY1	Designate material as being delivered. You can also enter the delivery date and name of the person to whom the delivery was made.

Page Name	Definition Name	Usage
Item Description Page	RECV_ITEM_DESCR_FS	View descriptions for a specific item. Maintain Delivery Information - Delivery Location Page
Maintain Delivery Information - Location Comments Page	RECV_DELIVERY2	View comments entered for the delivery location of the material, which may include standard routing instructions for delivery. Maintain Delivery Information - Delivery Location Page
Maintain Delivery Information - Ship To Comments Page	RECV_DELIVERY3	View ship-to comments entered for the internal delivery location of the material, which is the final destination to which the item should be routed. For example, if the ship-to value is Company Headquarters Building B but the delivery location is the fourth floor mail room of Building E, then the comments could be instructions as to which mail slot to use in the fourth floor mail room, receiving dates and times, or special delivery instructions. Maintain Delivery Information - Delivery Location Page
Delivery Detail Page	RECV_DEL_INQ	Review summarized delivery information for a receipt.
Delivery Detail Page	RECV_DEL_INQ_DTL	Review detailed delivery information for a receipt. Delivery Detail Page
Life Cycle Inquiry Page	REC_DEL_INQ_CYCLE	View the life cycle of a delivery.

Maintain Delivery Information - Delivery Location Page

Use the Maintain Delivery Information - Delivery Location page (RECV_DELIVERY1) to designate material as being delivered.

You can also enter the delivery date and name of the person to whom the delivery was made.

Navigation:

Purchasing > Receipts > Maintain Delivery Information > Delivery Location

Field or Control	Description
Delivered	<p>Select to indicate that the line item was delivered.</p> <hr/> <p>Note: Use caution when deselecting this check box. It may impact PeopleSoft Mobile Inventory Management. If signatures are required for the Purchasing business unit, then a signature appears in the Delivery Signature area after the item is delivered. If a user deselects this check box, the system clears the Delivery Signature area as well as other delivered fields, such as the Date, Time, and Delivered To fields.</p> <hr/> <p>Note: If this checkbox is deselected, a pop-up message appears to alert that unchecking this checkbox will delete the comments and attachments. Select Yes to make the item undelivered and delete the comments and attachments for it. If the same comments and attachments are added for multiple items, then deselecting this check box deletes the comments and attachments only for the selected line item. Other items will contain the same comments and attachments. If No is selected, the Delivered flag will be checked again.</p>

Delivery Detail Page

Use the Delivery Detail page (RECV_DEL_INQ) to review summarized delivery information for a receipt.

Navigation:

Purchasing > Receipts > Review Receipt Information > Delivery Inquiry

This example illustrates the fields and controls on the Delivery Detail page. You can find definitions for the fields and controls later on this page.

The screenshot shows the 'Delivery Detail' page with the following fields and values:

- Due Date:** 07/10/2000
- Ship To:** US001
- Distribution Qty:** 10.0000 EA
- Delivered Flag:**
- Date:** (empty)
- Requester:** Kenneth Schumacher
- Location:** US001 USA - New York
- Address 1:** 144 North Street
- Address 2:** (empty)
- Address 3:** (empty)
- Address 4:** (empty)
- City:** New York
- County:** (empty)
- Postal Code:** 10168
- State:** NY
- Attention To:** (empty)
- Delivered To:** (empty)
- Delivery Cart ID:** (empty)
- Distribution Line:** 1
- Building #:** (empty)
- Floor #:** (empty)
- Telephone:** (empty)
- Extension:** (empty)
- Fax:** (empty)
- Delivery Feedback:** (text area)

To access this page, you provide search criteria to limit the results of a search. You can also search by other data fields, such as, **Requester**, and Attention To. After completing the search criteria, click the **Search** button to populate the **Receipt Line Information** grid and then select a receipt.

The Delivery Detail page provides information about the receipt and receipt line that you selected on the Delivery Inquiry page. The page also includes the location and detailed address and contact information. The delivery information is updated when a receipt or receipt line has been delivered.

Note: Deliveries provided through the PeopleSoft Mobile Inventory Management application Mobile Delivery task flow are also included in Delivery inquiries.

Field or Control	Description
Delivered Flag	<p>Displays whether the delivery has been delivered. When the check box is selected, the receipt line distribution has been delivered. When the field is selected, the status of the receipt is delivered.</p> <p>Other statuses for which you can create Delivery inquiries are:</p> <ul style="list-style-type: none"> • <i>Both:</i> Provides both delivered and not delivered receipt deliveries. The Delivered Flag is not selected for this status. • <i>Not Delivered:</i> Provides receipt deliveries that have not been delivered. The Delivered Flag is not selected for this status. <p>If this check box is deselected, then the Delivery Signature image, as well as other delivered fields, is cleared.</p>

Field or Control	Description
Date	Displays the date on which the delivery was made.
Attention To	Displays the person to whom or the place to which the services or goods are to be delivered. If the purchase order's scheduled shipment originated from the requisition, then the Attention To field value is carried onto the purchase order.
Deliverer	Displays who delivered the item.
Delivered To	Displays to whom the receipt line item was delivered.
Delivery Cart ID	Displays the delivery cart ID if the line item was delivered using PeopleSoft Mobile Inventory delivery carts. see, "Setting Up and Using Mobile Delivery Carts in the PeopleSoft Fluid User Interface" (PeopleSoft Mobile Inventory Management).
Delivery Feedback	Displays comments provided by the person accepting or signing for the delivery.
Delivery Life Cycle	Click to access the Life Cycle Inquiry page, where you can view all transactions for the receipt. See "Life Cycle Inquiry Page " (PeopleSoft Mobile Inventory Management).
Delivery Signature	Displays the signature of the person who received a delivery if your organization uses PeopleSoft Mobile Inventory, requires delivery signatures, and the items were delivered.

Life Cycle Inquiry Page

Use the Life Cycle Inquiry page (REC_DEL_INQ_CYCLE) to view the life cycle of a delivery.

Navigation:

From the **Delivery Detail** page, click the **Delivery Life Cycle** link.

Use this page to view the life cycle of a received item from receipt to delivery.

The Source column indicates from where the transaction originated. *Online* indicates that the transaction is from a PeopleSoft application. *Mobile* indicates that the transaction came from a mobile device.

Inspecting Received Items

Understanding Inspections

PeopleSoft Purchasing offers an inspection component that provides detailed inspection instructions that have been established by your item administrator. One set of inspection instructions can be used for multiple items. When you use the Inspection page, these instructions are pulled into the receipt for your reference.

To be eligible for inspection, an item on the receipt line must be defined as requiring inspection. You can select the **Inspection Required** check box on the following pages:

- Item Categories - Category Definition 2.
- Purchasing Attributes - Purchasing Controls.
- Purchasing Business Unit Attributes.
- Requisition Line Details.
- PO Line Details (purchase order line details).

The item receipt does not have to be related to a purchase order to be eligible for inspection.

Related Links

[Details for Line Page](#)

[Defaults for Line Page](#)

[Matching Options Page](#)

[Purchasing Business Unit Attributes Page](#)

Using Separate Inspections

Performing inspections by using the PeopleSoft Purchasing Inspect Receipts component maps closely to a business process where receiving is done in one stage, followed by a separate inspection process. Implementing a separate inspection process by using the inspection component in conjunction with PeopleSoft Inventory enables you to track the receipt of inventoried items in an inspection location.

To indicate that your organization is using a two-step receive-then-inspect business process, select the **Separate Inspection** check box on the Purchasing Definition - Business Unit Options page.

When this check box is selected, the **Inspect Qty** (inspect quantity) field on the Maintain Receipts - Receiving page is unavailable for entry, and inspection must be done by using the inspection component.

If the **Separate Inspection** check box is clear, the **Inspect Qty** field on the Maintain Receipts - Receiving page is available for entry. Inspection is done and verified at that point, but it can still be performed by using the inspection component.

The default inspection location identified for an item is used as the putaway location at the time of receipt, unless an overriding inspection location is specified on the Inventory Putaway Information page.

The quantity accepted upon receipt appears by default as the received quantity, and the accepted quantity in the stocking **unit of measurement** (UOM) is moved to the designated inspection location by using the Receipt Push Inventory multiprocess job (RECV_01). If the goods are moved to an inspection location other than their original inspection destination, the inspection location can be updated in the system to reflect the true location to which the goods were moved.

The separate inspection process is then used to inspect the items that are now in the inspection location. Any goods that pass inspection are moved from the original inspection location to the default final putaway location. This default final putaway location can be changed to another noninspection location. The move from inspection to final putaway location is described in more detail later in this topic.

If items are rejected during inspection at the inspection location, there is a tight integration with the Return to Vendor process, and return transactions are generated automatically.

Inspecting and Moving Goods to Their Final Putaway Locations

To perform separate inspections and move goods to their final putaway locations:

1. Create a receipt by using the Maintain Receipts - Receiving page.
2. Run the Receipt Push Inventory multiprocess job.

This step is necessary if the receipt is inventory-related. This process moves goods into the default inspection location unless you defined different default locations when you created the receipt.

3. Perform inspections by using the Inspect Receipts component.

Access the Inspection & Putaway Information page to change (if necessary) the default final putaway location.

4. To perform manual bin-to-bin transfers, click the **Manual Bin to Bin Transfer** link on the Inspection page.

This provides access to the Transfers page, where you can choose to move the item from the inspection location manually to its final putaway location.

5. To perform Auto Bin to Bin transfers (a batch process), ensure that the **Auto Bin to Bin** option is selected for the Inventory putaway locations.

This process stages the item information into the Data Collection tables (BCT_DTL). To verify that the information has populated the table and is ready to be picked up by the batch process, access the Transaction Maintenance page. The final step of the Auto Bin to Bin process is to run the Inventory Transfer process (INPTTRFR). This process moves your inventory from the inspection location to the final putaway location.

Note: To run the Inventory Transfer process, you must define values for the following fields on the Data Collection Setup page, even if bar coding is not being used: **Transaction Number** and **History Options**. If barcode processing is not used, there is no need to provide a value for the **File Suffix** field.

Related Links

[Inspection & Putaway Information Page](#)

[Establishing PeopleSoft Purchasing Business Units](#)

[Understanding the RTV Business Process](#)

[Maintain Receipts - Receiving Page](#)

[Inventory Putaway Information for Line Page](#)

Performing Inspections

This section discusses how to perform inspections:

Pages Used to Perform Inspections

<i>Page Name</i>	<i>Definition Name</i>	<i>Usage</i>
Select Receipt Page(search criteria)	PO_PICK_ORDERS	Select receipt lines to put through the inspection process.
Supplier Search Page	SUPPLIER_LOOKUP_SEC	Search for suppliers.
Item Description Page	PO_PICK_IT_DESCR	Enter and view descriptions for a specific item.
Inspection Page	RECV_INSPECT	Put receipt line items through the inspection process. The Inspection Required check box must be selected for the item on the receipt line.
Maintain Receipt Asset Details Page	RECV_WPO	To view or update the asset-related information in a receipt.
Item Description Page	RECV_INSP_IT_DESCR	Enter and view descriptions for a specific item.
Inspect Instructions Page	RECV_INSP_INSTRUCT	View inspection instructions associated with the item on the receipt line and enter batch sequence, run time, and inspect ID information.
Inspection & Putaway Information Page	RECV_INSP_PUTAWAY	Specify a putaway location override for an item. This page is available only if the receipt line is targeted for inventory.

Page Name	Definition Name	Usage
Storage Location Search Page	RECV_STOR_LOC_SRCH	Perform a search on available storage locations for the material that you are receiving.
Putaway Locations Page	IN_PTWY_LOC_SP	Define directed putaway values for receipt items.
Line Details Page	RECV_INSP_DETAILS	View details about the item at the receipt line level.
RTV Setup Page	RECV_INSPECT_RTV	Enter RTV details for inspected items. This information is used to generate an RTV transaction automatically.
Quality Data Entry - Subgroup Method or Quality Data Entry - Sample Method Page	QS_DE_GUI_S	Enter quality inspection detail results for the item on the purchase order line.

Inspection Page

Use the Inspection page (RECV_INSPECT) to put receipt line items through the inspection process.

The Inspection Required check box must be selected for the item on the receipt line.

Navigation:



Purchasing > Receipts > Inspect Receipts > Select Receipt



Enter search criteria on the Select Receipt page and click the **Search** button.

Click the **Sel** check box next to a receipt line and click the **OK** button.

This example illustrates the fields and controls on the Inspect Receipts page. You can find definitions for the fields and controls later on this page.



Inspect Receipts

Ship To Location Business Unit  

Receipt Lines Personalize | Find | View All |  |  First 1 of 1 Last

Receipt Lines	More Line Data								
Item	Description	Insp Qty	Recv UOM	Status	Recv Qty	Reject Qty	Return Qty	Sample%	
<input checked="" type="checkbox"/>	10020 Hand Pump, Frame Attachment	<input type="text"/>	EA	Incomplete	100.0000			100.00	

[Select Receipt](#) [Inspect Instructions](#) [Inspection Putaway Information](#) [Manual Bin to Bin Transfer](#)
[View Detail](#) [RTV Setup](#) [Transfer to Quality](#)

Field or Control	Description
	Click the RTV Create button to create an RTV transaction, and update the Return Qty field with RTV data that you entered on the RTV Setup page. The RTV transaction is now accessible on the Return to Vendor - RTV page, where you can view and modify detailed information for the RTV transaction.
	Click the Automatic Bin to Bin Transfer button to move items from their inspection locations to their putaway locations. The transaction to move items from inspection to putaway locations is written to the electronic data collection log files, where it is picked up by a background process, enabling the move to be completed automatically. This function is available only if you are using an electronic data collection batch update process. The Auto Bin to Bin check box on the Inspection & Putaway Information page is selected for items that are available for use with this function.

Receipt Lines

Select the Receipt Lines tab.

Field or Control	Description
Insp Qty (inspected quantity)	Enter the quantity of items inspected.
Status	<p>The status of the inspection process appears. Values are <i>Complete</i> and <i>Incomplete</i>.</p> <p>When the quantity inspected for the receipt line is equal to or greater than the Sample% of the receipt quantity (Recv Qty) the status is set to <i>Complete</i>. Otherwise, the status is set to <i>Incomplete</i>.</p>

More Line Data

Select the More Line Data tab.

Field or Control	Description
IN Unit (inventory business unit)	Displays the inventory business unit. If the item is an inventory item, this is the inventory business unit associated with the item. If the receipt line is targeted for Manufacturing (subcontract), this is the inventory business unit associated with the production ID and operation sequence displayed.

Field or Control	Description
Production ID	If the item is associated with a PeopleSoft Manufacturing production kit, this field displays the item associated production ID.
Operation Sequence	Displays the number designating the order in which this material is used in the production sequence.
INV Stat (inventory status)	<p>Designates if the receipt line item is an inventory item, along with its status. Values are:</p> <ul style="list-style-type: none"> • <i>Moved</i>: Indicates that the receipt line has interacted with PeopleSoft Inventory. • <i>N/A</i> (not applicable). • <i>Pending</i>: Indicates that the receipt line has been staged and is pending interaction with PeopleSoft Inventory.
AM Status	<p>Displays the asset information review status – <i>Pending</i> or <i>Moved</i>. This link is displayed only if the asset details are specified on the Distribution for Schedule page at the time of purchase order creation.</p> <p>Click the <i>Pending</i> link of a receipt line to access the Maintain Asset Receipt Details page, where you can enter asset details for the selected receipt line. If you access the Maintain Asset Receipt Details page using the AM Status link, the <i>Interface Receipt</i> check box and the <i>Interface Asset Information</i> link are hidden.</p> <p>For more information, see Maintain Receipt Asset Details Page.</p> <hr/> <p>Note: If you navigate to the Maintain Asset Receipt Details page without saving your modifications, an error message displays indicating that there are unsaved changes and you must save them.</p> <hr/>

Field or Control	Description
Transfer to Quality	<p>Click to create a quality data entry session and transfer to the PeopleSoft Quality Data Entry - Subgroup Method page or Data Entry - Sample Method page, depending on the data entry method that you specified when you created the quality control plan. Use this page to pass applicable receipt items on to PeopleSoft Quality for in-depth inspection.</p> <p>Prior to transferring to PeopleSoft Quality, the receipt inspection function updates the hierarchy and trace field values that are passed to PeopleSoft Quality, as well as the inspection quantity, which is passed on to Quality as SGRP size. The inspection quantity to be passed on to PeopleSoft Quality is determined by multiplying the receipt quantity for the line by the sample inspection percent for the item, less the current inspection quantity.</p> <p>Upon returning to receipt inspection on the Inspection page, if the SGRP size was updated by PeopleSoft Quality, it is retrieved and added to the current inspection quantity field value. If the inspection quantity is large enough to satisfy the inspection sample percent for the item, the inspection status is set to <i>Complete</i>.</p> <p>Upon returning to receipt inspection on the Inspection page, if the PeopleSoft Quality fail count is greater than zero, the count is moved to the receipt inspection's return quantity. The reject action is set to <i>Replacement</i> and the reject reason is set to <i>Failed Inspection</i> by default.</p> <hr/> <p>Note: If the reject reason of <i>Failed Inspection</i> is not set up for the SetID, the system will issue an error message at save time. To correct this error situation access the RTV Setup page for the line and correct the error.</p> <hr/> <p>At save time, you have the option to generate an RTV transaction automatically for the returned quantity.</p>

Related Links

[RTV Setup Page](#)

[Inspection & Putaway Information Page](#)

[Return To Vendor Page](#)

[Item Rejection Versus Item Returns](#)

“Using Subgroup and Sample Methods to Enter Data” (PeopleSoft Quality)

“Integration With Other PeopleSoft Applications” (PeopleSoft Quality)

“Integration With Third-Party Systems” (PeopleSoft Quality)

Maintain Receipt Asset Details Page

Use the Maintain Receipt Asset Details page (RECV_WPO) to view or update the asset-related information in a receipt. The page displays all the receipts, which contain asset information.

Navigation:

Purchasing > Receipts > Maintain Receipt Asset Details

Or

Click the *AM Status* link from the Inspection page.

This example illustrates the fields and controls on the Maintain Receipt Asset Details page. You can find definitions for the fields and controls later on this page.

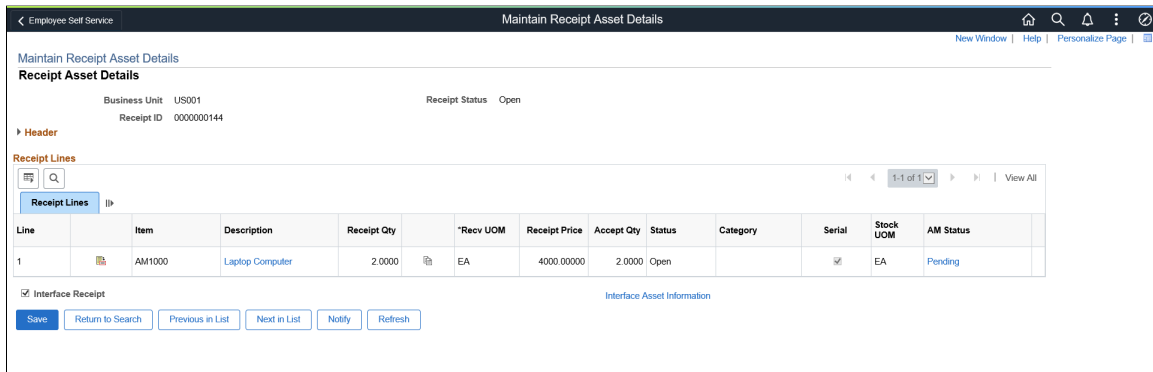

Field or Control	Description
AM Status link	<p>Displays the status of the item data in relation to PeopleSoft Asset Management.</p> <p>Values are:</p> <ul style="list-style-type: none"> • Pending - Indicates that the receipt line is asset-related and is pending interface with PeopleSoft Asset Management. Click the link to access the Asset Management Information for Line page where asset information can be recorded. <p>For more information, see Asset Management Information for Line Page.</p> <ul style="list-style-type: none"> • Moved - Indicates that the receipt line has been interfaced to PeopleSoft Asset Management. <p>If the receipt line is not asset-related, this field does not display.</p>
Interface Receipt	<p>Select this check box to automate the passing of asset information through the receiving process.</p> <p>If you access the Maintain Receipt Asset Details page from the inspection page, this check box does not display.</p>

<i>Field or Control</i>	<i>Description</i>
Interface Asset Information	<p>Click this link to access the Pre-AM1 page, where you can preview and correct data that is being sent to PeopleSoft Asset Management.</p> <p>If you access the Maintain Receipt Asset Details page from the inspection page, this link does not display.</p>

Select Receipt (search criteria) Page

Use the Select Receipt (search criteria) page (PO_PICK_ORDERS) to select receipt lines to put through the inspection process.

Navigation:

- **Purchasing > Receipts > Inspect Receipts > Select Receipt**
- Click the **Select Receipt** link on the Inspection page.

<i>Field or Control</i>	<i>Description</i>
Search	Click to retrieve information to the lower portion of the page based on your selection criteria.

More Details

<i>Field or Control</i>	<i>Description</i>
Price	Displays the unit price of the item on the purchase order line.

Inspect Instructions Page

Use the Inspect Instructions page (RECV_INSP_INSTRUCT) to view inspection instructions associated with the item on the receipt line and enter batch sequence, run time, and inspect ID information.

Navigation:

Click the **Inspect Instructions** link on the Inspection page.

You define inspection instructions at the item level on the Inspection Routing page. This inspection instruction information is captured upon receipt and can be modified or overridden at the time of inspection.

Field or Control	Description
Batch Seq (batch sequence)	Designates when in the inspection routing sequence this inspection occurs. This field is set to 1 by default for the first inspection operation defined, and it increments with each subsequent operation added for the inspection routing.
Inspect ID (inspection ID)	Displays the inspection ID for the items that you are inspecting.
Run Time	Displays the estimated time required for each inspection.
Time Type	Select the type of inspection on which the runtime is based. Values are: <ul style="list-style-type: none"> <i>Per Batch</i>: Designates that the inspection operation should be performed on a batch of items, perhaps on a representative sample from an entire shipment. <i>Per Unit</i>: Designates that the inspection operation should be performed on single items.
Total Std (total standard)	Displays the estimated time required for the inspection of all items, based on the Run Time value and the number of items that are being inspected.
Total Act (total actual)	Enter the actual time required for the inspection of all items.
Instructions	Displays detailed instructions for the inspection of the items.

Related Links

“Defining Inspection Procedures” (PeopleSoft Source to Settle Common Information)

Inspection & Putaway Information Page

Use the Inspection & Putaway Information page (RECV_INSP_PUTAWAY) to specify a putaway location override for an item.

This page is available only if the receipt line is targeted for inventory.

Navigation:

Click the **Inspection Putaway Information** link on the Inspection page.

After the receiving department receives items, the system moves them to the inspection department to be inspected, if required. At this time, the item has been put away to an inspection location. Once the items pass inspection, they need to be transferred from the inspection location to a location where they can be used for order fulfillment.

If the item original inspection location was used, and if the item's default putaway location will be used, then entering data on this page is optional. The purpose of this page is to specify an override putaway location.

Field or Control	Description
Serial	<p>Indicates whether or not the item is serial controlled. The item serial-controlled status also appears. Values are:</p> <ul style="list-style-type: none"> • <i>Complete</i>: Serial numbers have been assigned. This is the default value for a non-serial-controlled item. • <i>Incomplete</i>: Serial numbers have not been assigned.
Std UOM (standard unit of measurement)	Displays the UOM assigned to the item that reflects the most common unit of management for the item.

Putaway Location

Field or Control	Description
Area	Identifies the segment of the warehouse in which to store this item. This location depends on the inspection status of the receipt line. If the inspection status is <i>Incomplete</i> , this location must be an inspection location. If the inspection status is <i>Complete</i> , then it must be a noninspection location.
Lev 1 - 4 (levels 1–4)	Identifies the next levels of storage within the area location. This level number may represent aisles, shelves, bins, and so on. Enter as much or as little information that is needed depending on the different storage configurations available.

Field or Control	Description
Status	<p>Displays the receipt status. Values are:</p> <ul style="list-style-type: none"> • <i>C</i> (closed receipt): Item has been moved and matched, when required. No further processing is required. • <i>H</i> (hold receipt): Receipt on hold until released by user. • <i>M</i> (moved to interface): Item has interacted with PeopleSoft Asset Management, PeopleSoft Inventory, or PeopleSoft Manufacturing. • <i>O</i> (open receipt): Not all edits have passed. One or more receipt lines are in an <i>Open</i> status. • <i>R</i> (received): All edits have passed. All lines are in a <i>Received</i> or <i>Canceled</i> status. • <i>X</i> (canceled receipt): All lines and schedules are canceled. A <i>Cancel</i> status action cannot be reversed.
Auto Bin to Bin (automatic bin to bin)	<p>If you are using an automated electronic data collection system and this check box is selected, the <i>move from inspection to putaway</i> transaction can be moved by using the electronic data collection log files, where it is picked up by a background process. The move is completed automatically. If this field is selected and you clear it, the check box becomes unavailable for entry and the line is not eligible for automove. After clicking the Automatic Bin to Bin Transfer button on the Inspection page, this check box is cleared and no longer available for entry.</p>

Putaway Information

Field or Control	Description
Serial ID	<p>Displays the serial number for the material being received. This is required for a serial-controlled item.</p>
Lot ID	<p>Displays the lot ID number for the material being received. This is required for a lot-controlled item.</p>
Cntr ID (container ID)	<p>Displays the container ID associated with the item.</p>
Consigned	<p>If selected, designates that items being put away are consignment items.</p>

Field or Control	Description
Non-Owned	If selected, the item has been designated as a non-owned item.
Line Inv Qty (line inventory quantity)	Inventory quantity of the item on the original receipt line. Displays the quantity originally passed to inventory.
Total Inv Qty (total inventory quantity)	Displays the total inventory item quantity on the receipt. This is a sum of all the current distribution quantities for the receipt line. The value reflects any adjustments that have been made to the receipt distributions, such as RTVs. If the item has an associated RTV transaction, your business unit options are set to adjust for RTV, and the RTV action is return for replacement, this field displays the inventory item quantity less the return quantity.

Line Details Page

Use the Line Details page (RECV_INSP_DETAILS) to view details about the item at the receipt line level.

Navigation:

Click the **View Detail** link on the Inspection page.

Field or Control	Description
Status	Displays the status of the selected receipt line.
Inventory	Indicates whether the item has already been passed on to PeopleSoft Inventory. Values are: <ul style="list-style-type: none"> <i>Moved</i>: Item has interacted with PeopleSoft Inventory. <i>N/A</i> (not applicable): Item does not have any interface requirements. <i>Pending</i>: Item has not yet interacted with PeopleSoft Inventory.
Insp DTTM (inspection date and time)	Indicates the date and time of the item's inspection.

Related Links

[Defining Receipt Statuses](#)

RTV Setup Page

Use the RTV Setup page (RECV_INSPECT_RTV) to enter RTV details for inspected items.

This information is used to generate an RTV transaction automatically.

Navigation:

Click the **RTV Setup** link on the Inspection page.

You cannot create an RTV transaction for a receipt that has inventory or asset management interface requirements until it has a moved status.

When you enter RTV information on this page, you must create your RTV before saving your inspection transaction on the Inspection page. To create an RTV, click the **RTV Create** button on the Inspection page.

If you do not create your RTV before saving your inspection transaction, the system prompts you to create the RTV. Select *Yes* to create the RTV automatically and return to the Inspection page. The **Return Qty** field on the Inspection page is now populated with the RTV quantity.

If you select *No*, the system returns you to the Inspection page to enable you to modify your RTV information. RTV data that you enter is lost if you do not create the RTV *before* exiting the Inspection page.

Field or Control	Description
Vndr Returned Qty (supplier returned quantity)	Displays the quantity returned based on the UOM assigned to the item by the supplier.
Std Returned Qty (standard returned quantity)	Displays the quantity returned based on the standard UOM for the item.
Vndr UOM (supplier unit of measurement)	Displays the UOM assigned to the item by the supplier.
Std UOM (standard unit of measurement)	Displays the UOM assigned to the item that reflects the most common unit of management for the item.
Reason Code	Select a reason for returning the product to the supplier. These values are defined on the Reason Codes page.
Rej Action (rejection action)	Select one of the following return action values for the rejected item: <ul style="list-style-type: none"> <i>C</i> (return for credit): You return the items to the supplier and do not request replacement of these returned goods. <i>R</i> (return for replacement): The supplier ships replacement goods, and you receive them against the original purchase order.

Related Links

“Defining Additional Common Information” (Application Fundamentals)

Managing Vendor Returns

Understanding the RTV Business Process

There are a variety of business reasons for initiating a supplier return. You may receive defective materials, too many items, items shipped in error, or items that you no longer require. When you return goods or services purchased from a supplier, you enter an RTV transaction in PeopleSoft Purchasing. Typically, this RTV transaction specifies the purchase order from which the materials were acquired; however, returns can be processed in PeopleSoft Purchasing without referencing the original purchase order if this detail is no longer available.

To initiate the RTV process, identify the items being returned to the supplier by entering descriptive information such as the supplier ID and supplier RMA (return material authorization) number in the RTV component. These pages provide various selection criteria that enable you to locate the correct purchase order or receipt line and other information to process the return. An RTV transaction can impact other areas such as inventory levels, payables credits, assets, and supplier performance statistics. You can use a streamlined RTV process for inventory and subcontracting transactions.

These are the basic steps in RTV transaction processing:

1. If available, determine the source purchase order and receipt to associate with the RTV.
2. Create the RTV using the Return to Vendor page and related pages.
3. Ship the return to the vendor.

Close the RTV transaction using the RTV Reconciliation Application Engine process (PO_RTVRECON). This prepares the RTV for PeopleSoft Payables processing.

4. Run the Voucher Build Application Engine process (AP_VCHRBLD) to stage the adjustment voucher.
5. Create the adjustment voucher in PeopleSoft Payables.

This diagram illustrates a more detailed view of the process:

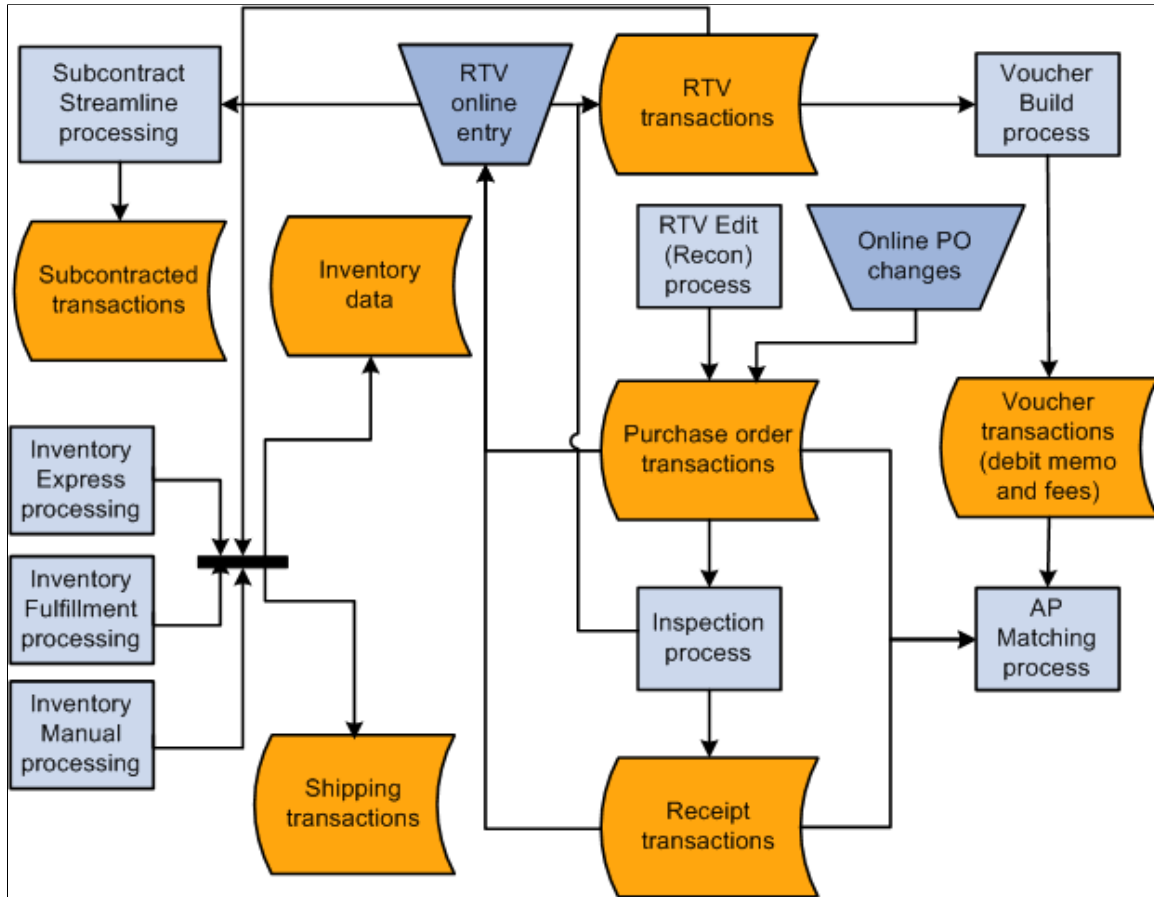

Related Links

[Return To Vendor Page](#)

[Reconciling RTV Transactions](#)

Item Rejection Versus Item Returns

In PeopleSoft Purchasing, rejecting an item is different than returning an item using a RTV transaction.

When you reject an item during receiving, the item is never recognized as a part of the accepted quantity in the system. For example, suppose that one of the items delivered to the receiving dock has been crushed beyond recognition, you reject the item, and have the carrier take it back. This item quantity is entered into the system as a rejected quantity and is not included in the accepted quantity.

When you return an item using an RTV transaction, the item has already been entered into the system as a part of the accepted quantity. As an example, suppose that you received, accepted, and moved an item to an inspection location. If this item fails inspection, return it to the supplier by creating an RTV transaction.

There are two reject actions in PeopleSoft Purchasing: credit and replace. When you enter a rejected quantity, the purchase order schedule remains open in anticipation of receiving the replacement items for the rejected quantity. Both the credit and replace reject actions result in the same action to the receipt (receipt quantity minus the reject quantity equals the accepted quantity). No further processing

is associated with the action. As a result, neither RTV transactions nor debit memos are generated for receipts where the items are *rejected* on the receipt.

There are three return actions in PeopleSoft Purchasing used by RTV transactions: credit, exchange, and replace. You can create a debit memo for the returned item during the RTV process. You can define this option while defining a supplier's procurement options. At the supplier location and at the PeopleSoft Payables business unit level on the Payables Definition - Voucher Build page. To view the default settings, see the Return To Vendor Defaults page. Based on these settings, the payment process either creates a separate debit memo or adds the debit to the supplier balance and lists the debit on the remittance advice.

See [Return To Vendor Defaults Page](#).

The **RTV Debit Memo** check box does not impact the creation of the adjustment voucher in PeopleSoft Payables. You create the RTV transaction based upon the setting for the **RTV Adjustment Option** field on the Payable Definition - Voucher Build page, where you can specify the voucher build criteria for the business unit.

Values are:

- *No Adj*: The Voucher Build process does not select or create an adjustment voucher from the RTV transaction.
- *Create*: The Voucher Build process selects and creates an adjustment voucher from the RTV transaction.
- *Stage*: The Voucher Build process selects and stages an adjustment voucher from the RTV transaction.

The adjustment voucher is staged or held in the Quick Invoice Entry component until you update the adjustment vouchers build status to *To Build* on the Quick Invoice page.

Note: If you reject items and also return the same items originating from the same source purchase order, the net receipt quantity is reduced twice. The reject quantity that you enter at receiving is deducted from receipt accept quantity and the net receipt quantity. The return quantity is updated for RTV transactions during inspection, or the RTV process updates the receipt return quantity and may be deducted from the net received quantity on the receipt depending on the return action and the **RTV Adjust Source** check box selection. Because the reject has already been accounted for in its own transaction, do not include it in the RTV transaction.

Related Links

[Return To Vendor Defaults Page](#)

“Understanding PeopleSoft Payables Business Units” (PeopleSoft Payables)

“Running the Voucher Build Process and Reviewing Messages” (PeopleSoft Payables)

“Understanding Quick Invoices and Summary Invoices” (PeopleSoft Payables)

Return Actions Review for RTV Transactions

The PeopleSoft Purchasing RTV business process supports three types of return actions: return for credit, return for exchange, and return for replacement. You can make these types of returns against closed purchase orders.

To enter adjustment fees for the RTV transactions, select the **RTV Adjust Fees** check box on the Purchasing Definition - Business Unit Options page.

If you select the **RTV Adjust Source** or **RTV Adjust Fees** check box, this is reflected on the Return To Vendor Defaults page.

Return for Credit

A return for credit involves returning the items to the supplier without requesting replacements. When you designate a supplier return as a return for credit, you can elect to have the system automatically create a debit memo, eliminating the need for manual intervention.

A return for credit is not available for receipts which originate from a purchase order that is using a procurement card as the payment method.

Return for Exchange

This type of return indicates that a different item is being substituted in exchange for the original item ordered. This enables you to exchange item A for item B from the same supplier or exchange item A for the same item from a different supplier. When you return an item for exchange, the return portion of the exchange is handled like a return for credit. If you want, the return can be made against a closed purchase order. Then, manually enter the order portion of the exchange on a purchase order. You can order the item on a new purchase order or on a new line of an existing purchase order. The return for exchange remains open in the system until it is matched with the new purchase order or new purchase order line.

Return for Replacement

This type of return indicates that the supplier is shipping the same items to replace the original returned goods. You receive these replacements against the original purchase order. For replacement returns, select the **RTV Reopen PO** check box on the Purchasing Definition - Business Unit Options page to reopen the affected purchase order.

For replacement returns, select the **RTV Adjust Source** check box on the Purchasing Definition - Business Unit Options page to adjust the net received quantity on the receipt automatically. You can also select the **RTV Adjustment Voucher** field on the Payables - Voucher Build page, as well as on the Return To Vendor Defaults page.

Note: If you process either a Return for Credit or a Return for Exchange action for a contract line item, and the original purchase order (either the purchase order selected or the purchase order associated with the receipt selected on the RTV document) references that contract, the RTV Reconciliation process updates the line amount and quantity to reflect the return.

If you process either a return for credit or a return for exchange action for a contract category line, and the original purchase order, either the purchase order selected or the purchase order associated with the receipt selected on the RTV document, references that contract category line, the RTV Reconciliation process updates the category released amount and quantity to reflect the return.

If you process either a Return for Credit or a Return for Exchange action for a contract with open references, and the original purchase order (either the purchase order selected or the purchase order associated with the receipt selected on the RTV document) references those open references, the RTV Reconciliation process updates the open item reference amount.

The RTV Reconciliation process updates the contract total amount once the RTV line status changes to shipped.

Related Links

[Return To Vendor Defaults Page](#)

[Inquiring About RTVs](#)

[Establishing PeopleSoft Purchasing Business Units](#)

RTV Data Change Review

When you save an RTV record, the system performs several edits and updates:

- An RTV ID is assigned to the return.

The RTV ID along with the PeopleSoft Purchasing business unit is used to identify the return transaction uniquely to PeopleSoft Purchasing and to retrieve information within the system.

- If the return is for replacement, the net quantity received on the receipt for each item associated with the return is updated if you selected the **RTV Adjust Source** check box on the Purchasing Definition - Business Unit Options page.

The quantity returned on the receipt is adjusted by the quantity returned, and the original receipt quantity is retained in the **Quantity Received** field for audit and analysis purposes. The receipt accept quantity remains unchanged, as it is used by PeopleSoft Payables matching.

This table lists the system actions that are invoked by saving an RTV transaction with various combinations of return actions and adjustment defaults. Adjustment defaults appear on the Return To Vendor Defaults page.

<i>RTV Adjust Source</i>	<i>RTV Adjustment Voucher</i>	<i>Return Action</i>	<i>System Action</i>
Y	Y	Credit or Exchange	The return quantity on the receipt record increases according to the quantity returned. An adjustment voucher is created.
N	N	Credit or Exchange	The return quantity on the receipt record increases according to the quantity returned.
Y	N	Credit or Exchange	The return quantity on the receipt record increases according to the quantity returned.

RTV Adjust Source	RTV Adjustment Voucher	Return Action	System Action
N	Y	Credit or Exchange	<p>The return quantity on the receipt record increases according to the quantity returned.</p> <p>An adjustment voucher is created.</p>
Y	Y	Replacement	<ul style="list-style-type: none"> • The net received quantity on the receipt record decreases according to the quantity returned. • The return quantity on the receipt record increases according to the quantity returned. • If you select the RTV Reopen PO check box on the Purchasing Definition - Business Unit Options page and the purchase order is closed, the header status changes to <i>Dispatched</i>. The line, schedule, and distribution statuses change to <i>Open</i>. • An adjustment voucher is created.
N	N	Replacement	<p>The return quantity on the receipt record increases according to the quantity returned.</p> <p>If you select the RTV Reopen PO check box on the Purchasing Definition - Business Unit Options page and the purchase order is closed, the header status changes to <i>Dispatched</i>. The line, schedule, and distribution statuses change to <i>Open</i>.</p>

<i>RTV Adjust Source</i>	<i>RTV Adjustment Voucher</i>	<i>Return Action</i>	<i>System Action</i>
Y	N	Replacement	<ul style="list-style-type: none"> The net received quantity on the receipt record decreases according to the quantity returned. The return quantity on the receipt record increases according to the quantity returned. If you select the RTV Reopen PO check box on the Purchasing Definition - Business Unit Options page and the purchase order is closed, the header status changes to <i>Dispatched</i>. The line, schedule, and distribution statuses change to <i>Open</i>.
N	Y	Replacement	<ul style="list-style-type: none"> The return quantity on the receipt record increases according to the quantity returned. If you select the RTV Reopen PO check box on the Purchasing Definition - Business Unit Options page and the purchase order is closed, the header status changes to <i>Dispatched</i>. The line, schedule, and distribution statuses change to <i>Open</i>. An adjustment voucher is created.

Inventory Return Records

If you installed PeopleSoft Inventory and the items to be returned to the supplier are in PeopleSoft Inventory, an inventory issue transaction is required to ship the items back to the supplier. When the RTV line disposition is *Ship*, inventory personnel use the Express Issue page to specify and record the exact inventory being returned, including the current material storage location. If the RTV line value is *Destroy*, the goods are removed from inventory using the inventory adjustment function instead of an express issue.

Items designated for supplier returns may be physically stored separately from other stock. This material may have been determined to be defective or inadequate after inspection, and subsequently stored in quarantined or return staging areas until the supplier grants authorization to return the goods.

When goods are returned from PeopleSoft Inventory, an RTV transaction is recorded in the Inventory Transaction table. Running the Transaction Costing process creates a costed transaction line, and if appropriate, creates a Purchase Price Variance transaction.

A streamlined (express) process for returning goods to suppliers is also available for inventory-related transactions. This process eliminates the need to go back and forth between PeopleSoft Purchasing and Inventory when processing returns to vendors.

Related Links

“Creating Online Orders Using Express Issue in PeopleSoft Inventory” (PeopleSoft Inventory)

“Making Stock Location Transfers Online” (PeopleSoft Inventory)

Return to Vendor Streamline Processing

You can use return to vendor streamline processing options when returning goods to suppliers for inventory-related transactions. This process eliminates the need to go back and forth between PeopleSoft Purchasing and Inventory and simplifies several inventory reduction options to a single step. Also, return to vendor transactions between PeopleSoft Purchasing and Production Control subcontracts can use streamline processing. Subcontracting is a production process where components or end items are sent to outside suppliers for end-item processing, such as a rework or an inspection. When a supplier return is necessary, the subcontracting process applies the return as scrap when the return is for credit.

Note: The RTV Streamline feature is an optional feature, and you can still use the manual multistep method of returning inventory or subcontract items to the supplier.

Using streamline processing for supplier returns, you can:

- Use the *Express* option and ship or scrap goods immediately using the Source Information tab on the Maintain Return To Vendor page in Purchasing.

This is the RTV process option that by creating data-collection transactions causes the inventory issue (automatic issue) or adjustment (automatic adjustment) action to be performed from the PeopleSoft Purchasing RTV component.

- Use the *Fulfillment* option to schedule the fulfillment process and generate a pick plan for warehouse personnel to pick and ship goods back to the supplier.

This is the RTV process option that by creating material stock request transactions causes the RTV transaction to be processed through the PeopleSoft Inventory fulfillment process.

- Create data-collection transactions for subcontract related transactions that cause the subcontract completions or negative completions action to be performed from the PeopleSoft Purchasing RTV and Receiving components.

Subcontract or outside processing for items represent services provided by suppliers. These items can be noninventory items that represent the actual supplier contribution in the build process. The subcontract item appears on the purchase order and accounts payable invoice. Subcontracting is the manufacturing environment where part of the manufacturing process is processed outside or subcontracted. This is when a customer maintains and manages an internal manufacturing environment, dealing with production IDs, bills of materials, and routings.

- Send automatic notifications to warehouse personnel when the *Manual* option is being used for inventory lines on the RTV.

The Events and Notifications function generates and issues the email notification messages and worklist entries. When the inventory manager has been notified, the system updates the notification status on the RTV.

Using the *Express* inventory process option on the RTV line and when the RTV line disposition is Ship, the RTV component creates the material stock request in a Shipped status, creates shipping documents, such as the packing list, and dispatches the RTV transactions to the supplier, all in one step. When the return line disposition is Destroy, you can use express processing to create the Inventory return to vendor, adjust inventory balance, and dispatch the return transactions to the supplier at the same time. The system makes parallel changes in PeopleSoft Inventory for the processing of issue and adjustment transactions related to PeopleSoft Purchasing RTV express processing.

Note: The RTV Streamline feature is not enabled when the PeopleSoft Inventory business unit uses an external warehouse control (Warehouse Management System (WMS)). The system cannot synchronize balances for express issue and adjustment functions performed within PeopleSoft Inventory. You use the Inventory Business Unit Options page to set external warehouse control for an Inventory business unit.

To set up RTV Streamline functions, you begin by defining user preferences and business unit options. These settings define default values that the system uses for RTV express processing. After you establish default values, you use the Add/Update RTV component to maintain the dispatch option and source information for express processing.

Using the dispatch option, you define how to dispatch the RTV. This can be either manually or when the RTV is shipped. Manual processing requires that you submit the RTV Dispatch/Print process from the Process Scheduler. When *RTV is shipped* value is selected, the system automatically submits the RTV Dispatch/Print process when the RTV status is set to Shipped.

Source information includes the PeopleSoft Inventory process and status, and subcontract details. The Inventory process defines how the system processes each RTV line in PeopleSoft Inventory. When you use manual processing, you must use the PeopleSoft Inventory Express Issue component to issue Inventory returns being shipped to the supplier when the line disposition line is Ship. Or, when the line disposition is Destroy, you must use the Inventory Adjustment component to adjust balances for PeopleSoft Inventory returns.

The Express Inventory process enables RTV Streamline processing for a RTV line that is based on the line disposition. The system performs parallel processing in PeopleSoft Inventory with the express option. An Inventory Fulfillment process is also available when the line disposition is Ship. This enables parallel processing for material stock requests in PeopleSoft Inventory.

A subcontract streamline option is also available when the production ID has a value. Subcontract processing is described in the next section.

See “User Preferences – Receivables Data Entry 1 Page” (Application Fundamentals).

See [Purchasing Definition - Business Unit Options Page](#).

See [Entering RTV Transactions](#).

This list provides a high-level overview of how you would set up and use the RTV Streamline feature to complete a purchase order receipt inspection that requires a return to vendor. You:

1. Set the user preference **RTV Inventory Ship Option** field value to *Express*.
2. Create and dispatch a purchase order for an inventory-related line that requires an inspection.
3. Receive the purchase order and putaway the stock to inventory.
4. Open the receipt using the PeopleSoft Purchasing Inspect Receipts component, and enter the receipt quantity as the inspection quantity.
5. Click the **RTV Setup** link and complete the fields on the RTV Setup page.

Information on this page includes the RTV quantity, reason code, and rejection action.

6. Click the RTV Create button and the system creates the RTV.
7. Access the RTV using the RTV Add/Update component.

The system displays the RTV you created using the Inspect Receipts component. The **Inventory Process** field value is *Express* and the **INV Status** field value is *Processing*.

You can now dispatch the RTV and process PeopleSoft Purchasing and Inventory transactions in parallel.

The diagram illustrates the streamlined process flow for RTV goods where, based on inventory details, you can ship, destroy, or fulfill returns to vendors:

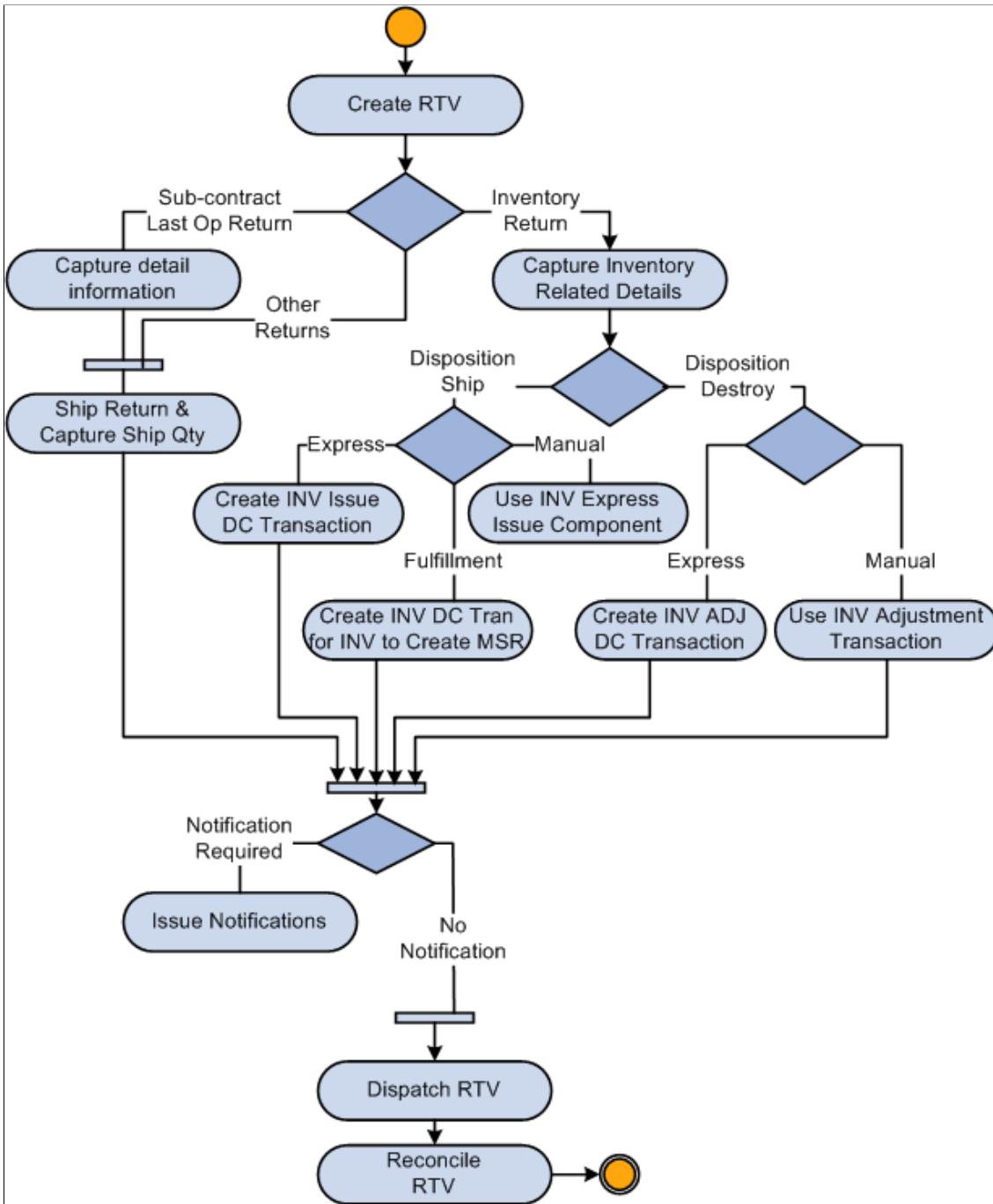

Streamline Subcontract Processing

In manufacturing environments where part of the manufacturing process is subcontracted, you generally maintain and manage an internal manufacturing environment that processes production IDs, bills of materials, and routings. You can use Purchasing RTV express processing where data-collection transactions, such as subcontract completions or negative completions, can be processed at the same time for PeopleSoft Purchasing and the Receiving component. Subcontract items represent services provided by a supplier. These items can be noninventory items that represent the actual supplier contribution in

the build process. The subcontract item appears on the purchase order and PeopleSoft Accounts Payable invoices.

To use streamline subcontract processing, the system provides:

- A Subcontract Streamline feature setting in user preferences.
- A **Streamline** check box on the RTV line when the production ID has a value.

The system automatically deselects the **Streamline** check box if the SetID for the RTV business unit does not exist in the data collection setup.

- Validation routines to ensure that values such as serial ID, lot ID, and production ID are valid in the PeopleSoft Inventory business unit.
- A link to storage locations so that storage areas and storage levels for inventory-related RTV detail rows so that you can specify the picking location.
- Support for negative production completion and scrap streamline for subcontract RTVs so that you can process the RTVs when completions are finished for the associated receipt.

This is accomplished using data-collections functionality to process subcontract-related RTV lines. You enable the functionality using the **Receiver / RTV Setup** link on the Procurement User Preferences page. Select the Subcontract Streamline check box option on the Receiver Setup page. The RTV component creates data-collection transactions for negative production completion and production scrap for the operation that you are returning against. The system automatically submits the Production Completion process to the Process Scheduler to complete the return.

When the source for a RTV line is a receipt line that is serial or lot controlled, you must select the appropriate receipt detail row that contains the serial or lot ID from the time of receipt. That value is then copied to the RTV detail row. The system copies the serial and lot control indicators from the receipt line to the RTV line, after which you cannot change the RTV line. The serial and lot control is always deselected for subcontract RTV lines when the operation sequence is not the last operation sequence.

The serial ID and lot ID appear for lot- and serial-controlled items when the operation sequence is the last operation for the production ID. The item ID that the system uses for serial and lot validation is the assembly item ID, not the item ID from the purchase order line, receipt line, or RTV line.

See [Entering RTV Transactions](#).

Asset Return Records

If you have installed PeopleSoft Asset Management, and the item that you are returning is designated as an asset, information about this return must be communicated to PeopleSoft Asset Management.

The RTV Reconciliation process produces this notification when it closes the asset-related RTV transaction and creates a retirement transaction that is sent to the interface table in PeopleSoft Asset Management, if the original asset receipt transaction in the interface table has already been processed. If it has not yet been processed, then the unprocessed asset receipt information in the table is adjusted to reflect the returned goods, and a retirement transaction is not required.

Note: The update of the asset transaction is only done if an adjustment voucher is not to be created. In the case where PeopleSoft Payables creates an adjustment voucher, PeopleSoft Payables will create the transactions to update the assets.

The RTV Reconciliation process recognizes a return as an asset item, if the source receipt has a PeopleSoft Asset Management business unit and a profile ID assigned.

Related Links

“Understanding Asset Retirement” (PeopleSoft Asset Management)

Common Elements Used in Vendor Returns

Field or Control	Description
IN Unit (PeopleSoft Inventory business unit)	If the item is an inventory item, displays the inventory business unit that applies to the item.
Lot ID	If the item is lot-controlled, displays the lot ID assigned to the item.
PO/Purchase Order	Displays the purchase order associated with the receipt against which you are creating the supplier return.
PO Unit (PeopleSoft Purchasing business unit)	Displays the PeopleSoft Purchasing business unit associated with the purchase order.
Receipt Line	Displays the receipt line associated with the items that you want to return.
Receipt No (receipt number)	Displays the receipt number associated with the items that you want to return.
Receipt Unit/BU Recv (receipt unit/business unit receiving)	Displays the receiving business unit associated with the receipt against which you are creating the supplier return.
Recv Date/Received Date	Displays the date on which the item was received.
Rev/Revision	Displays the revision number associated with the item ID, if applicable.
Serial ID	If the item is serial-controlled, displays the serial ID assigned to the item.
Supplier/Supplier ID	Displays the supplier that supplied the item being returned.
Supplier UOM/Supplier Unit of Measure	Displays the unit of measure assigned to the item by the supplier.

Setting Up RTV Processing Options

To set up RTV processing options:

1. Define RTV processing options for the Purchasing business unit on the Purchasing Definition - Business Unit Options page.

Relevant fields are **RTV Adjust Source**, **RTV Adjust Fees**, and **RTV Reopen PO**. For RTV express processing you also need to define values for these fields:

- **Notify Inventory Manager**
- **RTV Dispatch Option**
- **RTV Inventory Ship Option**
- **RTV Inventory Destroy Option**

2. Define user preference options for RTV Streamline processing on the Procurement - Receiver Setup page

These fields include: **RTV Dispatch Option**, **RTV Inventory Ship Option**, and **RTV Inventory Destroy Option** fields.

3. Define RTV voucher build options for the PeopleSoft Payables business unit on the Payables Definition - Voucher Build page. Select the **RTV Debit Memo** check box and the appropriate **RTV Adjustment Option** field value.

PeopleSoft provides the ability to automatically create adjustment vouchers in the PeopleSoft Payables system from supplier returns. These adjustment vouchers can be either processed automatically or staged for review and approval. Set up the default options for each PeopleSoft Payables business unit that will be processing adjustment vouchers from supplier returns. When processing RTV adjustment vouchers, the system first considers the supplier information (be it user-defined or system-defaulted). If no supplier information is available, the system then goes to the next higher level in the default hierarchy, the PeopleSoft Payables business unit.

Note: You can override these options at the supplier level.

4. Define RTV miscellaneous charges and fees that apply to supplier returns on the Misc Charge/Landed Cost Defn page.

Once you define miscellaneous charge codes, set up the supplier-specific RTV fee information. You can set up RTV fee information for all of the suppliers on the Supplier's Return To Vendor Fees page or for specific item-supplier relationships on the Supplier Item Return Fees page.

5. Define RTV processing options for each supplier, if required.

PeopleSoft provides the ability to override default options that were defined for the PeopleSoft Payables business unit by setting up RTV processing options at the supplier level. You can complete this setup when defining a supplier and supplier location and specifying the RTV options as part of the procurement set up.

Related Links

“Defining Miscellaneous Charges and Landed Costs” (PeopleSoft Source to Settle Common Information)

Creating RTV Transactions Without Purchase Orders

PeopleSoft Purchasing enables you to perform free-form RTV entry. You can return items by creating RTVs without source purchase orders or receipts. Acceptable return actions for RTVs without purchase orders are return for credit and return for exchange.

This return method enables items to be returned to a vendor other than the original supplier of the order. You can use this method to return goods that were received using a customer RMA where the supplier is willing to accept the goods.

Accomplish the return by entering detailed RTV information, such as serial IDs and the department and account that should be credited for the return.

To enter free-form supplier returns:

1. Access the Return to Vendor page in *Add* mode.

Do not select a purchase order or receipt against which to apply the supplier return.

2. Enter the appropriate RTV header information, such as supplier, buyer, and so forth.
3. Enter the items and quantities that you want to return.

The price used to cost the return is the last purchase order price paid for the item.

4. If necessary, enter the appropriate distribution ChartField values to be credited for the return. If the item is an inventory item, enter the PeopleSoft Inventory business unit from where inventory items are to be shipped or destroyed.

Related Links

[Return To Vendor Page](#)

Creating RTV Transactions Against Closed Purchase Orders

The PeopleSoft Purchasing RTV process enables you to return items against closed purchase orders.

If the return action is return for credit or return for exchange, the purchase order does not reopen, but you are able to continue with the return.

In the case of returns for replacement, if commitment control is disabled, you can reopen the affected purchase orders automatically. To do this, select the **RTV Reopen PO** check box on the Purchasing Definition - Business Unit Options page.

When you enter a return for replacement with this check box selected, you receive a warning message notifying you that the purchase order is to be reopened. If you approve, the purchase order header status changes to *Dispatch*. The purchase order line and schedule statuses change to *Active* and the Distribution status changes to *Open*.

Related Links

[Understanding Business Units in PeopleSoft Purchasing](#)

Selecting RTV Source Details

Use the Select Source Details pages to retrieve and choose the distribution information against which you are returning a product. The appropriate distribution selection page opens to display the distribution line information that corresponds to the current purchase order or receipt line. This enables the RTV process to accurately credit the appropriate distributions.

If the receipt has already been moved to PeopleSoft Inventory or PeopleSoft Asset Management, the appropriate source selection page displays lot, serial, and asset information to help you identify the correct receipt. If you are returning against a serialized receipt, select the serial ID being returned.

The returned quantity can be split across multiple purchase order or receiving distribution lines. If there is only one distribution, you do not need to access this page. The distribution is automatically selected from the originating transaction and you can click the **RTV Details** link to access the Distribution Details page.

To access the appropriate Select Source Details page, click the **Select Source Details** link on the Return to Vendor page.

The page you access depends on what you are returning against:

- If you are returning against a purchase order distribution, the Select Purchase Order Distribution page appears.
- If you are returning against a receipt that is a noninventory receipt, the Select Receipt Distribution page appears.
- If you are returning against an inventory-related receipt, the Select Receipt Assets page appears.

Once the appropriate purchase order or receipt distribution records are selected, you can enter the return quantity on the Distribution Details page.

Related Links

[Return To Vendor Page](#)

[Select Receipt Assets Page](#)

[Select Receipt Distribution Page](#)

Entering RTV Transactions

This section discusses how to Enter RTV Transactions

These rules are enforced during the selection process to select the appropriate purchase order or receipt lines on the Return to Vendor page:

- A return against a one-time supplier is not allowed.

To process the return, the supplier type must be changed to regular or permanent in the Supplier Information component.

- If the purchase order line is designated as receipt required, the return must be specified against the receipt document.

If only the purchase order number is known, you can select the receipt line by purchase order number using the Select Receipt page.

Pages Used to Enter RTV Transactions

Page Name	Definition Name	Usage
<u>Return To Vendor Page</u>	RTV	Enter RTV information.
Item Description Page	RTV_ITEM_DESCR, RTV_RECV_IT_DESCR	Enter and view descriptions for a specific item.
Distribution Details Page	RTV_LN_DISTRIB	Enter distribution information for the item that you want to return. If there is only one distribution for the selected purchase order or receipt line, the distribution is automatically selected. If you are returning a serialized item, the quantity is set to 1 and the quantity field is unavailable for entry.
Source Details Page	RTV_SOURCE_DTL	View source purchase order and receipt information for the selected RTV distribution line.
Return To Vendor Line Comments Page	RTV_COMMENTS_SEC	Enter comments at the RTV line level. You can enter a unique comment, or you can select from predefined standard comments.
<u>Select Receipt Page</u>	RTV_PICK_RECV_WRK	Enter search parameters to retrieve receipt lines that you want to transfer to the Return to Vendor page. If receiving is required, use the Select Receipt page accessed from the Return to Vendor page. Use the Pick Purchase Order page only if receiving is not required for the purchase order.
<u>Receipt Details Page</u>	RTV_RECV_QTY	View details of the RTV transaction at the purchase order schedule level.

Page Name	Definition Name	Usage
<u>Return To Vendor Defaults Page</u>	RTV_DEFAULTLS	View details regarding how the RTV adjustments are to be handled. View the method by which the supplier is to be notified of the RTV transaction.
<u>Override Supplier Address Page</u>	RTV_ADDR_DTL	Override the supplier's ship to address for this return. You may want to do this if the supplier has a return address that is different than the ordering address. You can enter an address for an entirely different supplier. You may want to do this if you have ordered an item from one supplier and can exchange it with a different supplier.
Select Purchase Order Distribution Page	RTV_PICK_PO_DIST	If you are returning against a purchase order distribution, the Select Purchase Order Distribution page appears. Retrieve and select the distribution information against which you are returning a product.
<u>Select Receipt Distribution Page</u>	RTV_PICK_ASSET	If you are returning against a receipt that is a noninventory receipt, the Select Receipt Distribution page appears. Retrieve and select the distribution information against which you are returning a product.
<u>Select Receipt Assets Page</u>	RTV_PICK_ASSET	If you are returning against an inventory-related receipt, the Select Receipt Assets page appears. Retrieve and select the distribution information against which you are returning a product.
<u>Storage Location Search Page</u>	RTV_STOR_LOC_SRCH	Search for storage locations.
<u>Return to Vendor Fees Page</u>	RTV_LN_FEE	View the fees that appear by default onto the RTV transaction from the supplier, supplier-item, and the receipt. If you select the RTV Adjust Fees check box, you can enter additional fees. You can enter a restocking fee that some suppliers charge for returning items using this same functionality.

Page Name	Definition Name	Usage
<u>Select Purchase Order Page</u>	PO_PICK_ORDERS	Search for and retrieve purchase order schedules against which to create RTVs. Only purchase orders that do not require receipts are available for selection. If the purchase order that you are returning against requires receiving, use the use the Select Receipt page to retrieve receipt lines against which to create the supplier returns.
<u>Return to Vendor Header Details Page</u>	RTV_HDR_DTLS	Enter RTV header details, including shipping information.
Return to Vendor Header Comments Page	RTV_COMMENTS_SEC	Enter comments at the RTV header level. You can enter a unique comment, or you can select from predefined standard comments.
<u>Return To Vendor Pro Numbers Page</u>	RTV_LN_SHP_DSP_SEC	Update or insert multiple progressive numbers for noninventory RTV lines.
Document Status Page	PRCR_DOCSTAT_INQ	Review information about procurement documents associated with this supplier return.

Return To Vendor Page

Use the Return To Vendor page (RTV) to enter RTV information.

Navigation:

Purchasing > Return To Vendor > Add/Update RTV

This example illustrates the fields and controls on the Return to Vendor page: RTV Lines tab. You can find definitions for the fields and controls later on this page.

Maintain Return To Vendor / Supplier
Return To Vendor / Supplier

Business Unit US001
RTV ID 000000002
Status Open



*Supplier SCM0000003 TRAILBLAZERS
Supplier Name TRAILBLAZE-001
Location MAIN
*Buyer VP1 Kenneth Schumacher
Dispatch Option Manual

Header Details Select Receipt
RTV Defaults Select PO
Header Comment
Override Supplier Address
Document Status

RTV Lines Personalize | Find | View All | First 1-3 of 3 | Last

Line	*Action	*Disposition	*Reason	RMA Number	RMA Line	Item ID	Description	Return Qty	Ship Qty	Ship Date	Supp UOM	Std UOM	Status
1	Credit	Ship	DAM	R117A1	1	10014	Cadence Kit	1.0000			EA	EA	Open
2	Replac	Ship	FAL	R117A1	2	10016	TC8799 Cyclometer	2.0000			EA	EA	Open
3	Exchan	Ship	WRG	R117A1	3	10020	Hand Pump, Frame Attachment	3.0000			EA	EA	Open

Save Return to Search Previous in List Next in List Notify Refresh Add Update/Display

Field or Control	Description
Supplier Name	Select a supplier to whom you are returning goods. The system displays the short supplier name assigned to the supplier.
Supplier	Displays the supplier ID used by the system to define a supplier. Along with the supplier ID, the system displays a link for the supplier's name. Click the link to access address and phone information for the supplier.
Status	<p>Displays the status of the RTV header. Values are:</p> <p><i>Open:</i> This status appears by default when the supplier return is initiated. Designates that one or more RTV lines are open.</p> <p><i>Shipped:</i> Once all of the distributions for a line are in <i>Shipped</i> status, the line status changes to <i>Shipped</i>. A line is considered shipped when the line's shipped quantity equals the returned quantity. When all of the lines are in <i>Shipped</i> status, this header status changes to <i>Shipped</i>. Once the header is in <i>Shipped</i> status, you can no longer select the RTV for this function.</p> <p><i>Closed:</i> All of the RTV lines have been closed by the RTV Reconciliation process.</p> <p><i>Cancelled:</i> All RTV lines have been canceled.</p>
Location	Displays the location code to which you are returning the goods.
	Click the Ship RTV button to designate that all of the noninventory RTV merchandise for the selected line and associated distributions has been shipped. This sets the shipped quantity on the RTV transaction and distribution lines to a value equal to the return quantity. The RTV line and distribution statuses are then set to <i>Shipped</i> . Set the shipped quantity for inventory RTV lines on the Express Issue page.
Cancel RTV 	Click to cancel all of the RTV lines and associated distributions. The RTV header status is set to <i>Cancelled</i> . You can only cancel an RTV with a status of <i>Open</i> . Canceling an RTV cannot be reversed.
Buyer	Displays the buyer responsible for the return.

Field or Control	Description
Dispatch Option	<p>Select an option for dispatching an RTV inventory-related line. The dispatch option determines how the system processes the dispatching of the return to the supplier. Values available in the field are based on the value defined for the RTV Dispatch Option field on the Procurement - Receiver Setup page for user preferences.</p> <p>If the RTV Dispatch Option field setting is <i>Manual</i> or <i>Dispatch When Shipped</i>, then it is the default value for this field. If the user preference RTV dispatch option is <i>Default to Business Unit</i>, then the system uses the value defined for the RTV Dispatch Option field on the Purchasing Definition-Business Unit Options page.</p> <p>Field values include:</p> <p><i>Default to Business Unit</i>: Select to use the value defined for RTV dispatching at the business-unit level.</p> <p><i>Dispatched</i>: You cannot select this value. The system automatically sets this as a default value after running the RTV Dispatch/Print process.</p> <p><i>Dispatch When Shipped</i>: Select to indicate that the system should automatically submit the RTV Dispatch/Print process when all lines on the RTV have been shipped.</p> <p><i>Manual</i>: Select to submit the RTV Dispatch/Print process using the Process Scheduler.</p>
Header Details	<p>Click this link to access the Return to Vendor Header Details page. You use this page to make changes to header details such as the voucher adjustment status, and freight terms and custom fields.</p> <p>See Return to Vendor Header Details Page.</p>
RTV Defaults	<p>Click this link to access the Return to Vendor Defaults page where you can maintain default information such as indicating to notify the inventory manager during inventory processing of the return and defining the dispatch and notification methods.</p> <p>See Return To Vendor Defaults Page.</p>
Select Receipt	<p>Click this link to access the Select Receipt page where you can define search criteria for the receipt, such as the business unit, receipt number, or receipt start and end dates.</p> <p>See Select Receipt Page.</p>
Select PO	<p>Click this link to access the Select Purchase Order page where you can define search criteria for retrieving a purchase order.</p>





Field or Control	Description
Header Comment	Click this link to access the Return To Vendor Header Comments page where you can add or update comments for the RTV.
Override Supplier Address	Click this link to access the Return to Vendor Address Details page where you can add or update address and contact information for the supplier. See Override Supplier Address Page .
Document Status	Click this link to access the Document Status page to view information about procurement documents associated with a supplier return. See Understanding Document Status Inquiries

RTV Lines

Select the RTV Lines tab to view and update basic information for a Return To Vendor item.

Field or Control	Description
Action	Select the return action for the returned merchandise. This selection determines valid selections for the other options on the page. <hr/> Note: A <i>Credit</i> action is not available for receipts which originate from a purchase order that is using a procurement card as the payment method. <hr/>
Disposition	Displays the disposition for the returned merchandise. <i>Ship</i> appears by default. <i>Ship</i> : Indicates that the RTV goods are to be shipped back to the supplier. Use the Express Issue page function to process inventory-related transactions. <i>Destroy</i> : Indicates that the RTV goods are to be destroyed. Use the inventory adjustment function to remove the goods from inventory, if the transaction is inventory-related.

Field or Control	Description
Reason	Select the reason for returning the product to the supplier. These values are defined on the Reasons Codes page in the Set Up Financials/Supply Chain component. During the reason validation, the system verifies that a PeopleSoft Inventory adjustment reason also exists for use with express RTVs when the RTV line is PeopleSoft Inventory-related, and the disposition status is Destroy. The system performs additional edits to verify that the return reason value exists as a PeopleSoft Inventory adjustment reason code. The system displays an error message when an adjustment reason code is not found for the code you select in the Reason field. You define PeopleSoft Inventory adjustment types using the Return Type Codes page for Inventory product-related settings in the Set Up Financials/Supply Chain component.
RMA Number	Enter the return material authorization number typically provided by the supplier.
RMA Line	Enter the RMA Line number provided by the supplier if multiple items are being returned against a single RMA number.
Item ID	Displays the item being returned to the supplier.
Description	Click to view more information about the item description.
Return Qty (returned quantity)	Displays the quantity to be returned to the supplier. This value appears by default from the value that you entered in the Return Qty field on the Distribution Details page.
Ship Qty (shipped quantity)	Displays the quantity shipped back to the supplier. This value appears by default from the value that you entered in the Ship Qty field on the Distribution Details page. If the RTV line is not inventory related and there is only one distribution you can enter the ship quantity at the line level, eliminating the need to go to the distribution details page to enter the quantity value.
Ship Date	Represents the ship date from the distribution details page. If the RTV line is not inventory related and there is only one distribution, you can enter the ship date the line level, eliminating the need to go to the distribution details page to enter the ship date value.

Field or Control	Description
Vndr UOM (supplier unit of measure)	Displays the UOM assigned to the item by the supplier. This value appears by default from the supplier UOM defined for the item on the Supplier's UOM & Pricing Info page when the supplier return is created without a source purchase order or receipt. If the supplier return is created with a source purchase order or receipt line, the supplier UOM appears by default from the appropriate document.
Std UOM (standard UOM)	Displays the UOM that reflects the most common UOM for the item. This value appears by default from the standard UOM defined for the item on the Purchasing Attributes page.
	Click to access the Select Receipt Details page for supplier returns. See Select Receipt Distribution Page .
	Click to access the Distribution Details page for supplier returns. See Distribution Details Page .
	Click to access the Return To Vendor Line Comments page for supplier returns. This page is similar to the comments page used to make comments about the purchase order. See PO Header Comments Page .
	Click to access the Return To Vendor Fees page. See Return to Vendor Fees Page .
	Click to access the Return to Vendor Pro Numbers page for supplier returns. See Return To Vendor Pro Numbers Page .

Field or Control	Description
Custom Field	<p>Click on the Custom Field to enter the custom details. You can access the Custom fields from the Pro Numbers page</p> <p>The user definable fields in this Custom Fields section are available when you check the Enable Custom Fields checkbox on the Purchasing Installation Options page. You can customize these fields for your use. The custom fields are informational only.</p> <p>For more Information See Understanding User-Definable Fields</p>
Status	<p>Displays the status of the RTV line. Values are:</p> <p><i>Open:</i> This status appears by default when the supplier return is initiated.</p> <p><i>Shipped:</i> The line has been shipped. A line is considered shipped when the line's Ship Qty equals the Return Qty.</p> <p><i>Closed:</i> The line has been closed.</p> <p><i>Cancelled:</i> The line has been canceled.</p>
Cancel Line 	<p>Click this button to cancel the selected RTV line and associated distributions. You cannot reverse the canceling of an RTV line.</p>

Optional Input

Select the Optional Input tab. You use the tab to define shipping methods, carrier, lading information, and custom fields.

Field or Control	Description
RTV (revision)	Displays the revision associated with the item ID, if applicable.

Note: You will see the Custom Field link for both the RTV Line and RTV Schedule by clicking Optional Input Tab. Click on the Custom Field Link to enter the custom details.

Return Amounts

Select the Return Amounts tab.

Field or Control	Description
Price	Displays the unit price of the item. This value appears by default from the Last PO Price defined for the item on the Purchasing Attributes page if the supplier return is created without a source purchase order or receipt. If the supplier return is created with a source purchase order or receipt line, the price appears by default from the appropriate document.
Merchandise Amt (merchandise amount)	Displays the total price of the items being returned, along with the currency in which it is expressed.

Source Information Tab

Select the **Source Information** tab.

Field or Control	Description
PO ID (purchase order ID)	Displays the purchase order when the return is related to a purchase order.
Receipt No (receipt number)	Displays the receipt number.
IN Unit (inventory business unit)	If the item is associated with a subcontracted operation, this field displays the item's inventory business unit. This field only appears for subcontracted related RTVs.
Production ID	<p>Displays the item's production ID when the item is associated with a subcontracted operation. When the RTV is against the last operation for the production ID and the subcontract value is <i>Streamline</i>, the system uses the field values from the Source Information tab to process the RTV in PeopleSoft Inventory. These values include, for example, the storage location, serial ID, and lot ID .</p> <p>When the RTV line is subcontract related, the Streamline check box is selected, and the return action is for Credit, the system checks to ensure that the return reason value exists as a production scrap code. You define PeopleSoft Inventory adjustment types using the Return Type Codes page in Inventory product-related settings in the Set Up Financials/ Supply Chain component.</p> <hr/> <p>Note: The production ID status must be In Process to create an RTV for a subcontracted receipt.</p> <hr/>

Field or Control	Description
Operation Sequence	Displays the operation sequence for the subcontracted operation.
Last Op Seq (last operation sequence)	Displays the last operation sequence performed for this production ID.
Assembly	Displays the assembly item ID (manufactured item) and description for a subcontracted related RTV line. This field only appears for subcontracted related RTVs.
UOM (unit of measure)	Displays the UOM for the production ID associated with the subcontracted related RTV line. This field only appears for subcontracted related RTVs.
Inventory	Displays whether the item is an inventory-related item. The RTV line is associated with an inventory business unit if it has one or more distributions with an associated inventory business unit value. Values are: <i>Y</i> : (yes) or <i>N</i> : (no).

Field or Control	Description
<p>Inventory Process</p>	<p>Select the inventory process by which you want to issue or adjust inventory for a RTV line. Inventory process values include:</p> <p><i>Express:</i> Select to perform RTV Streamline processing for this RTV line. When you use express processing, the system initiates the PeopleSoft Inventory issue (automatic issue) or adjustment (automatic adjustment) when you create data-collection transactions. If the RTV line disposition is Ship, the system creates a material stock request with a status of Shipped to update inventory. If the line disposition is Destroy, the system creates an adjustment transaction for adjusting inventory.</p> <hr/> <p>Note: You cannot select <i>Express</i> if the Inventory business unit is defined as a Warehouse Management System (WMS) type.</p> <hr/> <p><i>Fulfillment:</i> Select to perform RTV fulfillment processing for this RTV line. This enables you to stage RTV fulfillment processing requests for the PeopleSoft Inventory functionality to process and deplete return quantities. When you use fulfillment processing, the system creates and saves a material stock request transaction in Inventory when you dispatch the RTV. The <i>Fulfillment</i> value is only valid if the Disposition status is Ship. The <i>Fulfillment</i> option is not available for the Destroy disposition.</p> <hr/> <p>Note: If the inventory process value is <i>Fulfillment</i> and you change the disposition status to Destroy, the system displays an error message that the Disposition field value is <i>Ship</i> for use with the Fulfillment option.</p> <hr/> <p>When you save a RTV line with an Inventory status of Pending, the Inventory process value is Fulfillment, and the disposition value for the line is Ship, the system:</p> <ul style="list-style-type: none"> • Creates a material stock request transaction for each row of the RTV line using Inventory processing. • Sets the Inventory processing status for the RTV line to Processing. <p>You cannot cancel or change the line while the Inventory processing status is Processing.</p> <ul style="list-style-type: none"> • The RTV shipping information will be updated after the fulfillment processing has completed. <p><i>Manual:</i> Indicates that you either use the Inventory Express Issue component to issue inventory returns that are being</p>

Field or Control	Description
	<p>shipped to the supplier or the Inventory Adjustment component to adjust balances for inventory returns that are to be destroyed. The system does not automatically update inventory values.</p> <hr/> <p>Note: The system displays an error message when you attempt to change the inventory processing option to <i>Manual</i> and there is inventory demand for the RTV line.</p> <hr/> <p><i>Re-Send:</i> Select to send this transaction to PeopleSoft Inventory again. This value is only available when the Inventory status value is Processing. When you resend the transaction, the system sets the Inventory status to Pending and sets the Inventory Process field value back to either the <i>Express</i> or <i>Fulfillment</i> value that it contained before it was changed to the Re-Send status.</p> <p>When you select <i>Re-Send</i>, the system verifies that the RTV business unit, RTV ID, and RTV line do not have uncanceled demand. If they do, the system displays an error message that there is unprocessed demand in Inventory for the RTV line and the value cannot be changed.</p> <hr/> <p>Note: When an inventory transaction is resent, the quantity sent is the difference between the return quantity and the ship quantity, because partial processing could have occurred on the original transaction.</p> <hr/> <p>If the INV Status field value is <i>Processing</i> and you change the inventory process to <i>Express</i> or <i>Fulfillment</i>, the system verifies that the RTV business unit, RTV ID, and RTV line do not have uncanceled demand. If they do, the system displays an error message that there is unprocessed demand in Inventory for the RTV line and the value cannot be changed. If there is no demand, the system changes the Inventory Process field value and sets the INV Status field value to <i>Pending</i>.</p>

Field or Control	Description
<p>INV Status (inventory status)</p>	<p>Displays the inventory status for the RTV line. The field is a display-only field and is only visible when the RTV line is inventory-related. Field values include:</p> <p><i>N/A</i>: (not available)</p> <p>The system assigns this as a default value when none of the RTV lines are inventory-related.</p> <p><i>Pending</i></p> <p>Indicates that update requests have not been sent to Inventory for processing. This is the field default value when the RTV line is inventory-related. If the Inventory Process field value is <i>Express</i> or <i>Fulfillment</i>, the update requests have not yet been sent to Inventory for processing.</p> <p><i>Processing</i></p> <p>Indicates that inventory updates are being processed for either the Express or Fulfill Inventory process value. The system sets this status value when the RTV line is inventory-related and the RTV ship quantity is less than the return quantity, which means that there are inventory updates that have not been completed.</p> <p><i>Complete</i></p> <p>Indicates that inventory updates are complete and the RTV shipment quantity is equal to the return quantity. The system sets the status to Complete when the RTV line status is set to Shipped.</p>

Field or Control	Description
Streamline	<p>Select this check box to capture detailed information, such as the serial ID and lot ID, using the assembly item details for the last operation sequence performed for the production ID. The Streamline check box enables you to use streamline updates against subcontracted returned items creating data collection transactions to update production. This check box appears on the RTV line when the Production ID field has a value.</p> <p>The subcontract streamline option defaults onto the RTV line from the user preferences and you can override the value. The system automatically deselects and makes the Streamline check box unavailable if the SetID for the RTV business unit does not exist in the data collection setup.</p> <p>Streamline processing for subcontract RTVs enables you to process RTVs if completions have been performed on the associated receipt and the subcontract production header has an In Process status. The system includes negative production completion and production scrap for operations being returned against the subcontract when you select the Streamline check box.</p> <p>When you save data-collection transactions the system calculates the net quantity change. This is the difference in quantity from when you save the transaction and the value from the previous save. Data collection transactions are created for updating the subcontract production tables when the batch update is performed.</p>
Return Reason	<p>Select a return reason code for a line's return. This field displays when the RTV line is subcontract-related and has values for the production ID and operation sequence and you have selected the Streamline check box.</p>

Related Links

[Dispatching and Printing RTV Transactions](#)

[Distribution Details Page](#)

[Defining Purchasing Item Attributes](#)

[Setting Up Item Supplier Price Adjustment Rules](#)

“Defining Additional Common Information” (Application Fundamentals)

Select Receipt Page

Use the Select Receipt page (RTV_PICK_RECV_WRK) to enter search parameters to retrieve receipt lines that you want to transfer to the Return to Vendor page.

If receiving is required, use the Select Receipt page accessed from the Return to Vendor page. Use the Pick Purchase Order page only if receiving is not required for the purchase order.

Navigation:

Click the **Select Receipt** link on the Return to Vendor page.

Enter criteria that retrieves the receipt lines that contain the items for which you are creating a supplier return. After you enter the selection criteria, click the **Search** button.

Note: If you are unable to retrieve data with assorted fields populated, clear all of the criteria with the exception of the information in the **PO No**, **Receipt No**, or **Supplier ID**, fields and try the search again.

<i>Field or Control</i>	<i>Description</i>
Today +/-	This value is added and subtracted from the current date to calculate the Start Date and End Date values. This value appears by default from the User Preferences - Procurement: Receiver Setup page. You can also manually enter the start date and end date.
Mfg ID (manufacturer ID)	Select the manufacturer of the item that you are returning.
Search	Click this button to retrieve information that meets the selection criteria and to have this information display in the lower portion of the page.
Select All	Click this link to select all of the receipt lines retrieved.
Clear All	Click this link to clear the check box for all of the lines currently selected.

Receipt Lines

Select the check box next to the appropriate line to select a receipt line against which to process the supplier return. You can select multiple lines.

<i>Field or Control</i>	<i>Description</i>
Seq (sequence)	Uniquely identifies multiple receipts for each receipt line.

Field or Control	Description
Vndr Rcpt Qty (supplier receipt quantity)	Displays the quantity of items received expressed in the supplier UOM. Note: If the RTV is being created from a purchase order or receipt, the supplier unit of measure is the purchase order unit of measure (on the receipt it is called supplier UOM). For RTVs without a source, the supplier UOM is the item/supplier UOM.
Vndr Accept Qty (supplier accepted quantity)	Displays the quantity of items accepted expressed in the supplier UOM.

Additional Receipt Information

Select the Additional Receipt Information tab.

Field or Control	Description
Vndr Reject Qty (supplier reject quantity)	Displays the quantity of items rejected expressed in the Supplier UOM .
Rej Reason (reject reason)	Displays the reject reason entered on the receipt, if part of the receipt quantity was rejected at receiving time.
Rej Action (reject action)	Displays the reject action from the receipt, if part of the receipt quantity was rejected at receiving time.
Status	Displays the status of the associated receipt.

Related Links

[Item Rejection Versus Item Returns](#)

[Understanding the Receiving Business Process](#)

Receipt Details Page

Use the Receipt Details page (RTV_RECVC_QTY) to view details of the RTV transaction at the purchase order schedule level.

Navigation:

Click the **Details** link on the Select Receipt page.

Field or Control	Description
Received Quantity	Displays the quantity of items delivered.
Accepted Qty (accepted quantity)	Displays the quantity of items accepted.
Rejected Qty (rejected quantity)	Displays the quantity of items rejected at receiving time.
Supplier Unit of Measure	Displays the supplier unit of measure for the receipt.
Reject Reason Code	Displays the reject reason entered on the receipt, if part of the receipt quantity was rejected at receiving time.
Action On Rejection	Displays the reject action on the receipt, if part of the receipt quantity was rejected at receiving time.

Related Links

[Item Rejection Versus Item Returns](#)

Return To Vendor Defaults Page

Use the Return To Vendor Defaults page (RTV_DEFAULTLS) to view details regarding how the RTV adjustments are to be handled.

View the method by which the supplier is to be notified of the RTV transaction.

Navigation:

Click the **RTV Defaults** link on the Return to Vendor page.

Field or Control	Description
RTV Adjust Source	<p>Provides information about how receipt adjustments are handled. If this check box is selected, the receipt's net received quantity is adjusted if the return action is return for replacement. If this check box is clear, the net received quantity on the receipt is not adjusted.</p> <p>The return quantity is always adjusted. This check box's setting appears by default from the setting on the Purchasing Definition - Business Unit Options page.</p>

Field or Control	Description
Notify Inventory Manager	<p>Select this check box to notify the inventory manager that goods are ready to be shipped back to the supplier. The system generates an email notification to the manager when the Disposition field is set to <i>Ship</i> or <i>Destroy</i> for Inventory RTVs and the Inventory Process is <i>Manual</i>. The default value for this field is set at the business-unit level and is retrieved from the Notify Inventory Manager check box setting on the Purchasing Business Unit Options page. You can override the value for individual vendors by either deselecting or selecting the check box.</p> <p>The system uses the RTV inventory process option and the line disposition, to determine the notification messages that the system sends:</p> <ul style="list-style-type: none"> • An inventory issue message the Inventory Process field value is <i>Manual</i> and the line disposition is Ship • An inventory adjustment message when the Inventory Process field value is <i>Manual</i> and the line disposition is Destroy.
RTV Adjust Fees	<p>Provides information about how RTV adjustment fees are handled. If this check box is selected, you can enter adjustment fees for the RTV transaction using the RTV Fees page. If this check box is clear, adjustment fees cannot be entered on the RTV transaction and only appear on the RTV transaction if there is a default value on the supplier or item-supplier relationship or if there are RTV-reversible miscellaneous charges on the receipt.</p> <p>The fees appear on the RTV Fees page but cannot be changed.</p>
Inventory Manager Notified	<p>Displays as selected to indicate that the system has sent the RTV notification or worklist entry to the inventory manager. When the RTV is saved and the Notify Inventory Manager check box has been selected and Inventory Manager Notified is check box is not selected, the system generates the Errors and Warning notification (email, worklist entry, or both). The system selects the Inventory Manager Notified check box as part of the save processing.</p>
RTV Debit Memo	<p>If this check box is selected, an adjustment voucher or debit memo is created for all return actions according to the RTV Adjustment Voucher status setting.</p>

Field or Control	Description
RTV Adjustment Voucher	<p>Indicates the adjustment voucher option setting for the RTV transaction. The system looks at the RTV Adjustment Voucher option setting defined on the Supplier - Location: Procurement Options page to determine the default value that appears here. The RTV Adjustment Voucher option setting you define on the Supplier - Location: Procurement Options page also defaults to the Payables Definition - Voucher Build page. Values are:</p> <p><i>Create</i> (create adjustment): The Voucher Build process selects and creates an adjustment voucher from the RTV transaction.</p> <p><i>No Adj</i> (no adjustment): The Voucher Build process does not select or create an adjustment voucher from the RTV transaction.</p> <p><i>Stage</i> (stage to pending file): The Voucher Build process selects and stages an adjustment voucher from the RTV transaction. The adjustment voucher is staged or held in the Quick Invoice Entry component until you update the adjustment vouchers build status to <i>To Build</i> on the Quick Invoice page.</p>
RTV Dispatch Method	<p>Select the method by which you want to dispatch the supplier returns. The dispatch method that appears by default is defined on the Procurement Options page. Values are <i>EDX</i> (electronic data exchange), <i>Email</i>, <i>Fax</i>, <i>Phone</i>, and <i>Print</i>.</p>
RTV Notification Method	<p>Select the method by which you want to notify the supplier of an RTV transaction that is to be dispatched. Values are <i>Email</i> and <i>Phone</i>.</p>

Note: There are several combinations of RTV default options that cannot be used. The system issues an invalid combination warning message if you select **RTV Debit Memo** and *No Adj* (no adjustment) as the **RTV Adjustment Voucher** value. If you select **RTV Debit Memo**, the RTV adjustment voucher must have a value other than *No Adj*. The system issues an invalid combination warning message if you do not select **RTV Debit Memo** and instead select *Create* or *Stage* as the RTV adjustment voucher.

Related Links

[Understanding Business Units in PeopleSoft Purchasing](#)

“Payables Definition - Voucher Build Page” (PeopleSoft Payables)

Override Supplier Address Page

Use the Override Supplier Address page (RTV_ADDR_DTL) to override the supplier's ship to address for this return.

You may want to do this if the supplier has a return address that is different than the ordering address. You can enter an address for an entirely different supplier. You may want to do this if you have ordered an item from one supplier and can exchange it with a different supplier.

Navigation:

Click the **Override Supplier Address** link on the Return to Vendor page.

The supplier address information on this page appears by default from the Supplier Information - Address page.

Field or Control	Description
Address Sequence Number	A designated location associated with the supplier, such as corporate office or sales center. Override the default address sequence by entering a value here. This value appears by default from the Return to Vendor page.
Contact Sequence Number	A designated contact at the address given, such as a persons name or position. Override the default contact sequence by entering a value here.

Override Address

Enter contact and address information to override existing default values.

Select Purchase Order Page

Use the Select Purchase Order page (PO_PICK_ORDERS) to search for and retrieve purchase order schedules against which to create RTVs.

Only purchase orders that do not require receipts are available for selection. If the purchase order that you are returning against requires receiving, use the use the Select Receipt page to retrieve receipt lines against which to create the supplier returns.

Navigation:

Click the **Select PO** link on the Return to Vendor page.

Select the check box to retrieve and choose a purchase order distribution against which you want to perform an RTV transaction.

Field or Control	Description
PO Qty (purchase order quantity)	Displays the number of items in the selected purchase order distribution.
PO Amount	Displays the merchandise amount for the selected purchase order distribution.

Related Links

“Understanding PeopleSoft ChartFields” (Application Fundamentals)

Select Receipt Distribution Page

Use the Select Receipt Distribution page (RTV_PICK_ASSET) to if you are returning against a receipt that is a noninventory receipt, the Select Receipt Distribution page appears.

Retrieve and select the distribution information against which you are returning a product.

Navigation:

Click the **Select Source Details** button on the Return to Vendor page.

Select the check box to retrieve and choose a receipt distribution against which you want to perform an RTV transaction.

Field or Control	Description
Dist Qty (distribution quantity)	Displays the number of items in the selected receipt distribution.
Amount	Displays the merchandise amount for the selected receipt distribution.

Select Receipt Assets Page

Use the Select Receipt Assets page (RTV_PICK_ASSET) to if you are returning against an inventory-related receipt, the Select Receipt Assets page appears.

Retrieve and select the distribution information against which you are returning a product.

Navigation:

Click the **Select Source Details** link on the Return to Vendor page.

Select the check box next to the asset-receipt distribution source against which you want to perform an RTV transaction.

Field or Control	Description
AM Unit (PeopleSoft Asset Management business unit)	Displays the PeopleSoft Asset Management business unit assigned to the purchase order for the selected receipt items by the originating PeopleSoft Purchasing business unit, if applicable.
Quantity	Displays the number of items on the asset distribution line.

Field or Control	Description
VIN	Displays the VIN number associated with the serial-controlled item number that you received associated with the purchase order. Note: This field only appears if you received a serial-controlled item and the Asset Type associated with the item and asset profile was <i>FLEET</i> .

Related Links

[Select Receipt Assets Page](#)

[Managing Receipts](#)

Distribution Details Page

Use the Distribution Details page (RTV_LN_DISTRIB) to enter distribution information for the item that you want to return.

If there is only one distribution for the selected purchase order or receipt line, the distribution is automatically selected. If you are returning a serialized item, the quantity is set to 1 and the quantity field is unavailable for entry.

Navigation:

Click the **RTV Details** button on the Return to Vendor page.

This example illustrates the fields and controls on the Maintain Return to Vendor - Distribution Details page. You can find definitions for the fields and controls later on this page.

The screenshot shows the 'Distribution Details' page. At the top, it displays 'Business Unit US001', 'RTV ID 0000000002', and 'Line 1'. Below this, it shows 'Return Qty Supp 1.0000 EA', 'Merchandise Amt 6.00 USD', and 'Std Returned Qty 1.0000 EA' with a 'Conversion Rate 1.00000000'. A 'Distributions' table is visible with columns for Dist Nbr, Supplier Returned Qty, Req Date, Supplier Shipped Qty, Ship Date, Status, Merchandise Amt, and Currency. The table contains one row with Dist Nbr 1, Supplier Returned Qty 1.0000, Req Date 05/01/2001, Status Open, and Merchandise Amt 6.00 USD. Navigation buttons like 'OK', 'Cancel', and 'Refresh' are at the bottom.

If there is only one distribution for the selected purchase order or receipt line, the distribution is automatically selected.

Field or Control	Description
Line	Displays the RTV line number associated with this distribution.
Return Qty Vndr (returned quantity to supplier)	Displays the quantity of items returned to the supplier in the supplier UOM.



Field or Control	Description
Amount	Displays the monetary value of the items returned, along with the currency in which it is expressed.
Std Returned Qty (standard returned quantity)	Displays the quantity of items returned to the supplier in the standard unit of measure.
Conversion Rate	Displays the conversion rate for the standard UOM related to the supplier UOM.

Distributions

Select the Distributions tab.

Field or Control	Description
Dist Nbr (distribution number)	Displays the system-assigned value for this distribution line.
Supplier Returned Qty (supplier returned quantity)	<p>Enter the quantity in the supplier UOM returned on the distribution line. The value in this field appears by default on the Return to Vendor page and determines the value that appears in the Amount field.</p> <hr/> <p>Note: If the RTV is being created from a purchase order or receipt, the supplier unit of measure is the purchase order unit of measure (on the receipt it is called the supplier UOM). For RTVs without a source, the supplier UOM is the item/supplier UOM.</p> <hr/>

Field or Control	Description
<p>Std Returned Qty (standard returned quantity)</p>	<p>Enter the quantity in the standard UOM returned on the distribution line. Once you enter the returned quantity in the standard UOM, the system will calculate and enter the supplier returned quantity value for you. The system performs the UOM conversion for you.</p> <p>Using this field enables you to return a quantity to the supplier in a different unit of measure than was on the purchase order. For example, you place a purchase order for two cases of item 10004. In this case the supplier UOM or purchase order UOM is Cases and the standard UOM is Each. Let's say you receive that purchase order for the complete two cases and have started to use that item. Now you receive a recall from the supplier, but you only have a partial quantity left of the quantity originally ordered. You can then create an RTV and use this field (entering the quantity in the standard UOM) to return a partial quantity (10 each) of the case back to the supplier that was originally purchased.</p> <hr/> <p>Note: This field is only available if the standard UOM is different than the supplier UOM.</p>
<p>Req Date (request date)</p>	<p>Select the date on which you are requesting the RTV transaction. This identifies the date on which you are requesting to have the merchandise shipped or destroyed.</p>
<p>Supplier Shipped Qty (supplier shipped quantity)</p>	<p>Enter the quantity in the supplier UOM shipped back to the supplier. The value in this field appears by default in the Ship Qty field on the Return to Vendor page.</p> <p>If the selected receipt is not a PeopleSoft Inventory receipt, the Supplier Shipped Qty and Ship Date fields are available for entry. Update these fields when the items are physically shipped back to the supplier. When the quantity in Supplier Shipped Qty equals the quantity in Return Qty Vndr and you save the page, the status of the distribution line on the supplier return changes to <i>Shipped</i>.</p> <p>If the selected receipt is a PeopleSoft Inventory receipt, the Supplier Shipped Qty and Ship Date fields are not available for entry. This information is updated when the inventory is shipped out of the PeopleSoft Inventory business unit through the Express Issue page or scrapped on the Inventory Adjustment page.</p>

Field or Control	Description
<p>Std Shipped Qty (standard shipped quantity)</p>	<p>Enter the quantity in the standard UOM shipped back to the supplier. Once you enter the shipped quantity in the standard UOM, the system will calculate and enter the supplier shipped quantity value for you. The system performs the UOM conversion for you.</p> <hr/> <p>Note: This field is only available if the standard UOM is different than the supplier UOM.</p> <hr/>
<p>Ship Date</p>	<p>Date on which the RTV items were shipped to the supplier. This appears by default as the current date and is informational only.</p>
<p>Status</p>	<p>Displays the distribution status of the RTV transaction. Values are:</p> <p><i>Open:</i> This status appears by default when the supplier return is initiated.</p> <p><i>Shipped:</i> When the supplier shipped quantity value equals the return quantity supplier value and you save the page, the distribution line status changes to <i>Shipped</i>.</p> <p><i>Closed:</i> The distribution line has been closed by the RTV Reconciliation process.</p> <p><i>Cancelled:</i> The distribution line has been canceled. You can change the RTV status to <i>Cancelled</i> until a distribution on the RTV transaction has been shipped.</p>
<p>Amount</p>	<p>Displays the value of the items returned on the distribution line, along with the currency in which it is expressed.</p>
<p></p>	<p>Click the Select Source Details button to access the Source Details Information page where you can review RTV information such as the PO and receipt order numbers.</p>
<p></p>	<p>Click the Cancel Distribution button to cancel the selected distribution row from the RTV transaction. Canceling an RTV distribution cannot be reversed.</p>

Source Information

Select the **Source Information** tab.

Information on this tab applies to supplier returns that relate to processing inventory and subcontract data transactions. You can use Purchasing RTV streamline processing where data-collection transactions, such as subcontract completions or negative completions, can be processed at the same time for Purchasing and the Receiving component.

Note: The item ID that the system uses to validate the serial and lot data is the assembly item ID not the item ID from the PO line, receipt line, or RTV line.

<i>Field or Control</i>	<i>Description</i>
	Click the Storage Location Search button to access the Storage Location Search page where you can search for and maintain storage information related to this RTV line. This saves you from having to select each inventory location field individually.
Lot ID	Displays the lot ID for the assembly. When the source for a RTV line is a receipt line that is serial or lot controlled, you must select the appropriate receipt detail that contains the serial or lot ID from the time of receipt. The Lot ID field is also available for lot-controlled items being returned without a source receipt. The lot ID that you select must exist in PeopleSoft Inventory.
Serial ID	Select the serial ID for the assembly. This field is not available for non-serial controlled items. The Serial ID field is also available for serial-controlled items being returned without a source receipt. The serial ID that you select must exist in PeopleSoft Inventory. If you are returning a serialized item, the quantity is set to 1 and the quantity field is unavailable for entry.
IN Unit (Inventory unit)	Identifies the PeopleSoft Inventory business unit for the RTV.
Staged Date	Select the date on which inventory associated with this RTV line was placed in inventory.
Storage Area	Select the Inventory storage area where the inventory associated with this RTV line is located. You can use storage levels one through four for all inventory-related RTV detail rows to specify the picking location.
Lev 1, Lev 2, Lev 3, and Lev 4 (levels 1, 2, 3, and 4)	Select inventory storage levels one through four to define the location of goods associated with this RTV line. These are the picking locations for the item.

<i>Field or Control</i>	<i>Description</i>
Container	Displays the container with which the returned item is associated.

Dist Details

Select the Dist Details (distribution details) tab.

Use this tab to view and define distribution information for the item that you want to return. This information includes, for example, the General Ledger business unit and account, chartfields, category and subcategory, and source type.

See [Maintain Purchase Order - Distributions for Schedule Page](#).

Related Links

“Understanding PeopleSoft ChartFields” (Application Fundamentals)

“Creating Online Orders Using Express Issue in PeopleSoft Inventory” (PeopleSoft Inventory)

[Entering RTV Transactions](#)

Storage Location Search Page

Use the Storage Location Search page (RTV_STOR_LOC_SRCH) to search for storage locations.

Navigation:

Click the **Storage Location Search** button on the Maintain Return to Vendor - Distribution Details page.

As part of RTV streamline processing, you can use the Storage Location Search page to search for storage locations. The criteria fields that appear at the top of the page are transferred from the RTV line and distribution details values. The system displays matching inventory storage location rows for those search values.

To refine the search results, enter additional search field information, and click the **Search** button. The **Lot ID** and **Serial ID** fields in the search criteria and in the Storage Areas grid box is not available when the item is not lot controlled.

After the system displays the search results, you can select only one detail row at a time. When you select a row, the system copies the values from the selected row to the RTV distribution row and returns to the Maintain Return To Vendor - Distribution Details page. You do not have to click the **OK** button.

Note: If the quantity in the inventory storage location is not sufficient to satisfy the RTV line return quantity, you must insert a new RTV distribution row with the appropriate return quantity assigned to each distribution row for each Inventory storage location.

Return to Vendor Fees Page

Use the Return to Vendor Fees page (RTV_LN_FEE) to view the fees that appear by default onto the RTV transaction from the supplier, supplier-item, and the receipt.

If you select the RTV Adjust Fees check box, you can enter additional fees. You can enter a restocking fee that some vendors charge for returning items using this same functionality.

Navigation:

Click the **RTV Fees** link on the Return to Vendor page.

The setting of the **RTV Adjust Fees** check box on the RTV Defaults page, which appears by default from the **RTV Adjust Fees** setting on the Purchasing Definition - Business Unit Options page, controls whether fees, such as restocking or processing fees, can be entered or changed on the RTV transaction.

If you select the check box, adjustment fees can be entered here.

If you clear the check box, adjustment fees cannot be entered and appear only if there is a default value defined on the Supplier's Return to Vendor Fees page or the Supplier Item Return Fees page, or if there are RTV reversible fees on the receipt. The fees appear but cannot be changed.

Field or Control	Description
Misc Chg (miscellaneous charge code)	Select the identification code assigned to the applicable miscellaneous charge.
Reason Code	Displays the reason for the return. This value appears by default from the RTV line. Reasons are defined on the Reason Codes page.
Action	Displays the type of fee action. Values are <i>CR</i> (credit) and <i>DB</i> (debit).
Percent	Enter the fee percentage associated with the return reason.
Fee	Enter the calculated amount of the fee.
Accounting Entry Type	Select the type of accounting entry associated with this fee.
Cost Element	Displays the cost element code associated with the RTV item.
Accrue Charge	Designates whether or not the RTV fees are accrued. If the charge is a landed cost charge copied from the receipt, this setting appears by default from the receipt. Values are: <i>Y</i> (yes) and <i>N</i> (no).
LC Comp (landed cost component)	Designates whether or not you want the RTV fees marked as landed costs. If the RTV fee is copied from the receipt, this setting appears by default from the receipt. Values are: <i>Y</i> (yes) and <i>N</i> (no).
Process Flag	Indicates whether or not the RTV fees have been processed. Values are <i>Y</i> (yes) and <i>N</i> (no).

Related Links

[Return To Vendor Defaults Page](#)

[Establishing PeopleSoft Purchasing Business Units](#)

[Establishing Purchasing Processing Options](#)

[Item Rejection Versus Item Returns](#)

“Defining Additional Common Information” (Application Fundamentals)

Return to Vendor Header Details Page

Use the Return to Vendor Header Details page (RTV_HDR_DTLS) to enter RTV header details, including shipping information.

Navigation:

Click the **Header Details** link on the Return to Vendor page.

<i>Field or Control</i>	<i>Description</i>
Voucher Adjust Status	If this check box is selected, the Batch Voucher Build process has processed the RTV transaction.
Freight Terms	Select the freight terms that apply to this supplier return for shipping the goods back to the supplier, not for what was ordered. Freight terms reflect who holds legal responsibility for the material until ownership has passed. Freight terms are defined on the Freight Terms page.

Return To Vendor Pro Numbers Page

Use the Return To Vendor Pro Numbers page (RTV_LN_SHP_DSP_SEC) to update or insert multiple progressive numbers for noninventory RTV lines.

Navigation:

Click the **Return To Vendor Pro Numbers** link on the Return to Vendor page.

For inventory-related RTV lines, the fields in the scroll area are unavailable for entry. If some pro numbers have been entered using Express Issue page, they appear here.

<i>Field or Control</i>	<i>Description</i>
Seq (sequence)	Enter the RTV ship sequence number.
Pro Number (progressive number)	Enter the progressive number associated with this RTV line.

Related Links

“Creating Online Orders Using Express Issue in PeopleSoft Inventory” (PeopleSoft Inventory)

Dispatching and Printing RTV Transactions

This section provides an overview of the RTV Dispatch/Print process and discusses how to run the RTV Dispatch/Print process.

Page Used to Dispatch and Print RTV Transactions

<i>Page Name</i>	<i>Definition Name</i>	<i>Usage</i>
Dispatch RTVs Page	RUN_PO_RTVDISP	Set the parameters for and run these three processes: RTV Dispatch/Print, Email, RTV Dispatch & Email multiprocess job. Also produce the RTV Dispatch/Print report, which provides a printout of selected RTVs.

Understanding the RTV Dispatch/Print Process

The RTV Dispatch/Print SQR process (PORT001) dispatches supplier returns based on the selection criteria that you enter on the Dispatch RTVs page and uses the dispatch method that you set on the RTV Defaults page.

When you run this process from the Dispatch RTVs page, you have three choices:

<i>Term</i>	<i>Definition</i>
Email Application Engine process (PO_RTV_EMAIL)	Select to run only the Email process.
RTV Dispatch/Print SQR process (PORT001)	Select to run only the RTV Dispatch/Print process.
RTV Dispatch & Email multiprocess job (RTVDISP)	Select to run the RTV Dispatch/Print process and then the Email process.

Dispatching supplier returns by email requires that you run two processes: the RTV Dispatch/Print process and the Email process. The RTV Dispatch/Print process updates the RTV Email queue table and creates an output file in the location that you specify on the File Locations page. The Email process picks up the output file from the specified location and sends out an email message with the supplier return as an attachment through the SMTP gateway. The Email process sends the email to the address that you specify on the Supplier Information - Address page.

For email notifications, the Email process sends out a notification message without a file attachment. Set the notification method for RTV dispatches on the RTV Defaults page. For email dispatches, the Email process sends out a message with an RTV document attached.

To simplify dispatching by email, you can use the RTV Dispatch & Email multiprocess job on the PeopleSoft Process Scheduler Request page that you access from the Dispatch RTVs page. The RTV

Dispatch & Email multiprocess job automatically runs the RTV Dispatch/Print process and then the Email process.

When the dispatch method is by fax, the dispatch process creates an RTV file and a fax control file in the locations that you specify on the File Locations page.

When the dispatch method is EDX, the RTV Dispatch/Print process does not create an output file, but updates a series of EC outbound tables. These tables are updated: PS_RTV_DISP_HDR_EC, PS_RTV_DISP_PLN_EC, PS_RTV_DISP_DIST_EC, PS_RTV_DISP_FEE_EC, and PS_RTV_DISP_SHIP_EC.

To print a supplier return only, you can select the **Print Only** check box on the Dispatch RTVs page and specify the number of copies that you want.

Related Links

- “Entering Supplier Addresses” (PeopleSoft Source to Settle Common Information)
- “Preparing to Dispatch by Fax and Email” (PeopleSoft Source to Settle Common Information)

Dispatch RTVs Page

Use the Dispatch RTVs page (RUN_PO_RTVDISP) to set the parameters for and run these three processes: RTV Dispatch/Print, Email, RTV Dispatch & Email multiprocess job.

Also produce the RTV Dispatch/Print report, which provides a printout of selected RTVs.

Navigation:

Purchasing > Return To Vendor > Dispatch RTVs

This example illustrates the fields and controls on the Dispatch RTVs page. You can find definitions for the fields and controls later on this page.

The screenshot shows the 'Dispatch RTVs' configuration page. At the top, it displays 'Run Control ID PS_PO_DISPATCH_DEFAULT' and a 'Run' button. Below this are language settings: 'Language English' and radio buttons for 'Specified Language' (selected) and 'Recipient's Language'. The main area is divided into three sections: 'Process Request Parameters' with fields for Business Unit (US001), RTV ID, Supplier ID, Buyer, and Fax Cover Page; 'Statures to Include' with checkboxes for Dispatched, Not Dispatched, Open, Closed, Shipped, and Canceled; and 'Dispatch Methods to Include' with checked boxes for Print, FAX, EDX, E-Mail, and Phone. A 'Miscellaneous Options' section includes checkboxes for Print Only, Print Duplicate, and Test Dispatch, along with a 'Number Of Copies' field set to 1. At the bottom, there are buttons for Save, Return to Search, Notify, Add, and Update/Display.

Process Request Parameters

<i>Field or Control</i>	<i>Description</i>
Business Unit	Select a business unit as part of the selection criteria.
RTV ID	Select an RTV ID as part of the selection criteria. You must specify a business unit before you can enter an RTV ID. When you select a specific RTV ID, only the business unit and RTV ID are used as the selection criteria.
Supplier ID	Select a supplier ID as part of the selection criteria.
Buyer	Select a buyer as part of the selection criteria.
Fax Cover Page	<p>Select a fax cover page, if some of the supplier returns that you are dispatching are to be sent by fax. The fax cover letters are defined on the Fax Cover Letters page.</p> <p>The RTV Dispatch/Print process writes (to the fax control file) the file name associated with the selected cover page combined with the cover page file extension that you defined on the Dispatch Configuration page.</p>

Statuses to Include

<i>Field or Control</i>	<i>Description</i>
Dispatched	Select this check box to include previously dispatched supplier returns. Records with RTV_HDR.DISPATCH_FLAG = <i>Y</i> are included.
Not Dispatched	Select this check box to include supplier returns that have never been dispatched. Records with RTV_HDR.DISPATCH_FLAG = <i>N</i> are included.
Open, Closed, Shipped, and Canceled	Select the specific check box to include supplier returns with the selected statuses.

Dispatch Methods to Include

<i>Field or Control</i>	<i>Description</i>
Print, Fax, EDX (electronic data exchange), E-Mail , and Phone	Select the specific check box to include supplier returns with the selected dispatch methods.

Miscellaneous Options

<i>Field or Control</i>	<i>Description</i>
Print Only	Select this check box to print only and not dispatch the RTV transaction.
Print Duplicate	Select this check box to print only and not dispatch the supplier return. The printed RTV document will have the word <i>Duplicate</i> printed on it. The RTV transaction must have been previously dispatched.
Test Dispatch	Select this check box to perform a test run of the dispatch. When you select this check box, the process runs, but the supplier returns are not dispatched and are not set to a dispatched status. The printed RTV document has the word <i>Unauthorized</i> printed on it. This enables you to test the EDX, email, or fax setup without actually dispatching or updating the system.
Number of Copies	Enter the number of copies that you want the process to print.

Using the RTV EIP

This section provides an overview of the RTV EIP

Pages Used to Use the RTV EIP

<i>Page Name</i>	<i>Definition Name</i>	<i>Usage</i>
RTV Page	RTV	Enter information related to the entire RTV transaction.
“Publish Outbound Message Page” (PeopleSoft Supply Chain Management Integration)	IN_RUN_PUB_MSG	Initiate the outbound message publish process for outbound PeopleSoft SCM service operations.

Page Name	Definition Name	Usage
Return to Vendor Message Selection Criteria Page	PO_RUN_RTV	Launch the Return to Vendor outbound transaction.

Understanding the RTV EIP

The RTV EIP processes returns to vendors. This asynchronous batch publish EIP also supports flat-file processing for EDI transaction X.12 180.

Use this EIP to return items to vendors. You typically use EDI to process these transactions.

Run the RTV Dispatch/Print process (PORT001) to stage the RTV.

Use the common Publish Outbound Message page to initiate the PO_RTV Application Engine process that processes the RETURN_TO_VENDOR service operation.

Setting Up the RTV EIP

PeopleSoft delivers the service operations in PeopleSoft Integration Broker with a default status of *Inactive*. You must activate each service operation before attempting to send or receive data from a third-party source or another PeopleSoft system, such as CRM.

Before you can use the RTV EIP, you must:

1. Setup the service operation within PeopleSoft Integration Broker and Enterprise Components:

Use the information in the table below and refer to the setup instructions in the *PeopleSoft Supply Chain Management Integration 9.2* "Understanding SCM Integration" topic, Setting Up Service Operations section.

See "Setting Up Service Operations" (PeopleSoft Supply Chain Management Integration).

Service Operation	Direction and Type	Handlers	Chunking Available?	Integrates With
RETURN_TO_VENDOR	Outbound Asynchronous	ROUTERSENDHDLR	Yes	third-party system EDI transaction X.12 180

2. On the RTV, specify EDX as the RTV dispatch method.

See the product documentation for *PeopleTools: Integration Broker*

Related Links

"Setting Up Service Operations" (PeopleSoft Supply Chain Management Integration)

"Processing Inbound EIPs" (PeopleSoft Supply Chain Management Integration)

"Understanding EDI Integration with PeopleSoft" (PeopleSoft Electronic Data Interchange)

Return to Vendor Message Selection Criteria Page

Use the Return to Vendor Message Selection Criteria page (PO_RUN_RTV) to launch the Return to Vendor outbound transaction.

Navigation:

Select the Return to Vendor check box on the Publish Outbound Message page to enable the **Return to Vendor** link. Click the **Return to Vendor** link to launch the Return to Vendor Message Selection Criteria page.

The field values on this page are the same fields that appear on the Request for Quote Message Selection Criteria page.

See [RFQ Message Selection Criteria Page](#).

Reconciling RTV Transactions

This section provides an overview of the RTV Reconciliation process and discusses the page used to reconcile RTV transactions.

Page Used to Reconcile RTV Transactions

<i>Page Name</i>	<i>Definition Name</i>	<i>Usage</i>
Reconcile RTVs Page	RUN_POC5000	Initiate the RTV Reconciliation process, which evaluates and updates RTV header record statuses.

Understanding the RTV Reconciliation Process

The RTV Reconciliation Application Engine process (PO_RTVRECON) reviews the status of RTV line records to evaluate and update the RTV header record status. The process compares the shipped quantities for the RTV line records to determine whether all of the returned quantities for all of the lines have been shipped. If the shipped quantity equals the return quantity on every line, the process changes the header status to *Shipped*.

Note: If you process either a return for credit or a return for exchange action for a contract line item, and the purchase order or purchase order receipt references that contract, the RTV Reconciliation process updates the line amount and quantity to reflect the return.

If you process either a return for credit or a return for exchange action for a contract category line, and the original purchase order, either the purchase order selected or the purchase order associated with the receipt selected on the RTV document, references that contract category line, the RTV Reconciliation process updates the category released amount and quantity to reflect the return.

If you process either a return for credit or a return for exchange action for a contract with open references, and the purchase order or purchase order receipt references those open contract references, the RTV Reconciliation process updates the open item reference amount.

The RTV Reconciliation process updates the contract total amount once the RTV line status changes to *Shipped*.

If the return action on the RTV line is *Exchange*, an attempt is made to find the purchase order line schedule that contains the exchanged goods. If it is found and the goods on the RTV line have been shipped, the RTV line is eligible for closing. If the purchase order line schedule is not found, the RTV line is not closed.

After the RTV header status changes to *Shipped*, the process changes the header, line, and schedule statuses to *Closed*. If the supplier return was against an asset receipt and an adjustment voucher is not being created, an asset retirement transaction is written to the interface table in PeopleSoft Asset Management. In the event the original asset receipt transaction in the interface table has not been processed by PeopleSoft Asset Management, the return quantity is deducted from the original receipt quantity instead of creating a retirement transaction.

Once the RTV IDs status changes to *Closed*, the RTV record is no longer available to update. You can still view the return using the RTV inquiry pages.

Inquiring About RTVs

This section discusses the pages used to inquire about detailed RTV information.

Pages Used to Inquire About RTVs

Page Name	Definition Name	Usage
Return To Vendor Inquiry Page	RTV_INQ	View detailed RTV information, including RTV express details.
Return To Vendor Defaults inquiry Page	RTV_DEFAULTS_INQ	View detailed RTV default information.
Supplier Address inquiry Page	RTV_ADDR_DTL_INQ	View supplier address details.
Return To Vendor Fees inquiry Page	RTV_LN_FEE_DSP	View the fees that appeared by default on the RTV transaction from the supplier, supplier-item, and the receipt.

Page Name	Definition Name	Usage
Comments inquiry Page	RTV_INQ_COMMNT_SEC	View RTV comments entered at the header and line level.
Return To Vendor Header Details inquiry Page	RTV_HDR_DTLS_INQ	View detailed RTV header-level information.
Distribution Details inquiry Page	RTV_LN_DISTRIB_INQ	View distribution information for the item that you are returning.
Detail Information inquiry Page	RTV_SOURCE_DTL_INQ	View source purchase order and receipt information for the selected RTV distribution line.
Return to Vendor Pro Numbers inquiry Page	RTV_LN_SHIP_DISP	View progressive numbers for noninventory RTV lines.
Document Status Page	PRCR_DOCSTAT_INQ	Access and review information about procurement documents associated with a supplier return.

Using Receipt Accrual

Understanding Receipt Accrual

The PeopleSoft Purchasing Receipt Accrual Application Engine process (PO_RECVACCR) can be run on demand and multiple times in the same accounting period. This aspect of the process involves backing out previous transactions before new transactions can be generated, so that you can create reversal transactions for the current and next periods.

Note: For the Receipt Accrual process to work as designed, both PeopleSoft Payables and PeopleSoft Purchasing must be installed, and you must use PeopleSoft Payables Matching to validate vouchers.

When you run the Receipt Accrual process, the receipt accrual liability account accrues, or in other words, is credited for the amount of unbilled receipts. Any associated expense accounts are debited for the amount of unbilled receipts. The encumbrance reclassifications are generated and thereby provide a more accurate picture of the operating budget. The Receipt Accrual process also generates reversal transactions for the next period. PeopleSoft Purchasing retrieves the expense account information from the associated purchase orders or non-purchase order receipts to give you an accurate forecast of the expense account balance, even if several receipts have not been billed yet.

For example, suppose that you received 20,000 USD in materials in a month, but were billed for only 5,000 USD. The Receipt Accrual process ensures that the expense accounts reflect the remaining 15,000 USD in upcoming debits. This helps reduce the impact of unexpected debits to the expense accounts. Without the Receipt Accrual process, this 15,000 USD is hidden until the debits bill and post to the expense accounts.

When you run the Receipt Accrual process, it reverses the entries of both the receipt accrual liability account and the expense accounts. This keeps you current with all the unbilled receipts, enabling you to manage the expense accounts closely.

If receipts remain unbilled when the Receipt Accrual process runs in the new period, the same process begins anew with credits to the receipt accrual liability account and debits to the expense.

Receipt accrual supports:

- Expensed items where you have received the goods from the supplier, but the supplier has not yet invoiced the organization.
- Expensed items where a non-purchase order receipt has been entered.

You can set up receipt accrual for one scenario, both scenarios, or neither.

Here is a more detailed description of the way in which the Receipt Accrual process works:

1. Before creating the accounting entries for accrual, the process creates reversal transactions to back out all accrued receipts in the staging record (RECV_LN_ACCTG) in the current period.

The accrued receipts must first have successfully run one of the following three processes: the Entry Event Generator, Comm Cntrl Budget Processor, or the Journal Generator.

2. The original transactions for which reversals have just been created are identified as canceled.
3. Next, the process generates new transactions for receipts that qualify for accrual and creates the following six transactions in the staging record for each receipt line:

- a. An expense in the current period and an expense reversal in the next period.

ChartFields are inherited from the receipt distribution line. These transactions are budget-checked if commitment control is enabled. Entry events are generated if they are required on the Installation Options - Entry Event page. Journal Generator also processes the transactions.

- b. An accrual in the current period and an accrual reversal in the next period.

This account uses ChartField inheritance defined by the user. The ChartFields are inherited according to user selections of inheritance options on the Chartfield Inheritance page. Values are:

Always Inherit: Value comes from the receipt line distribution table RECV_LN_DISTRIB.

Do Not Inherit: Value comes from Accounting Entry Template table DST_DFTL_CNTRL.

Inherit Within Unit: Value comes from Accounting Entry Template table DST_DFTL_CNTRL.

Use Unit Default: Value comes from Accounting Entry Template table DST_DFTL_CNTRL.

These transactions are not budget-checked but are processed by Journal Generator, and the entry events are generated if they are required on the Installation Options - Entry Event Entry page.

- c. Encumbrance transactions are generated for the current period and reversal transactions are generated for the next period.

ChartFields are inherited from the receipt distribution line. These transactions are budget-checked, and entry events are generated if they are required on the Entry Events page. *Distributed* appears by default as the general ledger distribution status, so that the Journal Generator process does not process them. *N* appears by default as the budget header status and budget line status. Accrual and encumbrance transactions look exactly the same in the staging record except for the account type (RAC or ENR), general ledger distribution status, and the ChartFields. Encumbrance transactions are not created if commitment control is not installed or for receipts that are not associated with purchase orders.

4. Separate transactions are created to record miscellaneous charges that are derived from receipt landed cost transactions (RECV_LN_DIST_LC).

Multiple Currencies

If you use multiple currencies, the accounting entries post in both the transaction currency and the base currency. PeopleSoft Purchasing uses the conversion rate defined on the purchase order to calculate the base amount to accrue.

VAT and Miscellaneous Charges

If there are miscellaneous charges or landed cost charges associated with the purchase order, these charges accrue only if you select the **Accrue Charge** check box on the **Misc Charge/Landed Cost Defn** page and the **Accrue PO Receipts** check box on the **Purchasing Definition - Business Unit Options** page. In addition, only miscellaneous charge and landed cost transactions with these Accounting Entry Type definitions are eligible for accrual:

- FRG (freight expense).
- MISC (miscellaneous charge expense).
- STX (sales tax expense).
- UTX (use tax expense).
- VIN (value-added tax input nonrecoverable).

The Receipt Accrual process accrues the nonrecoverable portion of the value-added tax (VAT) on noninventory receipt lines if the **Landed Cost** accrual option (RECV_LN_DIST_LC) is selected for the corresponding miscellaneous charge code on the purchase order. This value flows from the purchase order to the receipt through the Process Receipts process. This is a VAT accrual for goods received but not invoiced.

These miscellaneous charges accrue along with the merchandise amounts only if the charges are to be paid to the same supplier designated on the purchase order.

Related Links

[Accruing Receipts](#)

[Understanding Entry Events in PeopleSoft Purchasing](#)

[Generating PeopleSoft Purchasing Entry Events](#)

“Understanding PeopleSoft Interunit and Intraunit Functionality” (Application Fundamentals)

“Generate Journals Request Page” (Application Fundamentals)

“Budget Checking Process” (PeopleSoft Commitment Control)

Receipt Accrual Criteria Description

The Receipt Accrual process does not accrue receipt amounts that have been paid or matched by PeopleSoft Payables. This section describes criteria that the Receipt Accrual process uses to determine which receipts should be accrued in various situations.

Eligibility Requirements for Accrual

The following list provides eligibility requirements for accrual:

1. For both purchase order and non-purchase order receipts:
 - a. The receipt must not be fully matched and matching must be required.
 - b. The receipt status must be *Moved*, *Not Recv'd* (not received), *Open*, or *Received*.
 - c. If the receipt line is purchase order related then the purchase order line must have Receiving Required selected.

- d. The receipt line cannot have a MFG Production ID and OP Sequence value. MFG Subcontract receipts are not accrued.
2. For purchase order receipts, the Accrue PO Receipts check box in the associated PeopleSoft Purchasing business unit must be selected.
3. For non-purchase order receipts, the Accrue Non/PO Receipts check box in the associated PeopleSoft Purchasing business unit must be selected.
4. For inventory receipt accruals, the Accrue Federal Inventory Receipt check box in the associated PeopleSoft Purchasing Business Unit must be selected.

Inventory-Related Purchasing Transactions Accrual

The Receipt Accrual process does not accrue receipt amounts that have been paid or matched by PeopleSoft Payables. This section describes criteria that the Receipt Accrual process uses to determine which receipts should be accrued in various situations.

Processing an Inventory receipt accrual

Here is an example of how to process an Inventory receipt accrual:

For inventory receipt accruals, you must select the Accrue Federal Inventory Receipt check box in the associated PeopleSoft Purchasing business unit.

1. Create a Purchase Order for the inventory items.
2. Budget check, Dispatch, and run Entry Event for the PO.
3. Receive the item via a Receipt.
4. Run the Interface Receipt job which runs both the Receive Interface Push and Complete Putaway processes for the inventory receipt accrual.
5. Run the Accrue Receipts process to create proprietary receipt accrual accounting entries. The inventory item will be set to not journal generate.
6. Run Receipt Entry Event to generate budgetary accounting entries that can be journal generated to the GL.
7. Run PO Entry Event to reverse the PO accounting entries previously made via the PO.
8. Inspect the item, if required.
9. Run Inventory Transaction Costing and Accounting Line Creation process to create the proprietary inventory accounting entries.
10. Create a voucher referencing the PO Receipt.
11. Run Voucher Budget Checking, Matching, and Document Tolerance.
12. Run Voucher Post with Entry Event.
13. Run Accrue Receipts to reverse the proprietary receipt accruals. The inventory item will be set to not journal generate.

14. Run Receipt Entry Events to reverse the entries.
15. Run Inventory Transaction Costing and Accounting Line Creation process to create any needed adjustments.
16. Journal Generate the PO, Receipt, and Voucher entries.

Related Links

[Understanding Miscellaneous Charges](#)

[Establishing PeopleSoft Purchasing Business Units](#)

“Understanding the Matching Process” (PeopleSoft Payables)

Receipt Accrual Setup

To set up receipt accrual for a business unit:

1. Select the **Accrue PO Receipts** check box or the **Accrue Non/PO Receipts** check box on the Purchasing Definition - Business Unit Options page.

See [Establishing PeopleSoft Purchasing Business Units](#).

2. Select the **Accrue Charge** check box on the Misc Charge/Landed Cost Defn (miscellaneous charge or landed cost definition) page to accrue miscellaneous charges or landed cost charges.

You cannot override this value on the purchase order; it flows to the receipt through the purchase order value adjustment.

See [Understanding Miscellaneous Charges](#)

3. Select a journal template for receipt accrual on the Procurement Control - GL Templates page.

Select the template that you want to use in the **Receipt Accrual** field. The standard template for receipt accrual is REC_ACCRUE.

See “Defining Procurement Controls for General Ledger Business Units” (PeopleSoft Payables).

4. Select the journal source and journal date on the Journal Generator Template - Defaults page.

When you set the journal source and date, you are ensuring that the accounting entries are reversed at the beginning of each subsequent period.

See “Understanding Journal Generator” (Application Fundamentals)

5. Define the liability account for receipt accrual in the **Expenses Accrual** field on the Accounting Entry Template page.

PeopleSoft Purchasing debits accrued receipt charges from the expense account designated on purchase order distributions. The alternate account designated on the Accounting Entry Template page applies only to the liability account defined here.

See “Accounting Entry Template Page” (Application Fundamentals).

6. Select *Do Not Generate Reversal* as the reversal code on the Journal Generator Template REC_ACCRUE.

The upgrade process should accomplish this step; you should not need to complete it independently of the upgrade.

7. Open the Purchasing Definition on the Accounting Entry Definition page, and change the Record from RECV_LN_ACCTG to RECV_LNACCTG_VW.

This record includes all receipt accruals that are budget-checked and ready to be journal generated. It excludes any receipt accrual with transactions that failed the budget process.

The upgrade process should accomplish this step; you should not need to complete it independently of the upgrade.

8. If any ChartFields are designated on the Detail Ledger Group - Chartfield page as *Balanced*, you need to select the *Always Inherit* rule for those ChartFields on the Chartfield Inheritance page.
9. Set up ChartFields in the general ledger definition.
10. Set up ChartFields for the accounting entry definition.

Receipt Accrual Implementation

Use the following process flow to use the Receipt Accrual process, the Entry Event Generator, and the Journal Generator process (FS_JGEN) to implement the receipt accrual business process:

1. Run the Receipt Accrual process from the Accrue Receipts page.

The Receipt Accrual process populates the RECV_LN_ACCTG table.

2. If Receipt Accrual commitment control check box is enabled, budget-check the receipt accruals from the Budget Check Request page.
3. Use the Receipt Accrual Accounting Entries to review Budget Exceptions and override them as necessary.
4. If you are using entry events, run the Entry Event Generator process from the Entry Event Run Request page.
5. Run the Journal Generator process from the Generate Journals Request page:

- a. On the Generate Journals Request page, select *REC_ACCRUE* in the **Template** field.

The template that you select controls the accounting lines source and journal date.

Note: Reversal entries are not generated because *Do Not Generate Reversal* was selected as the reversal code on the Journal Generator template *REC_ACCRUE* as part of the setup process.

- b. The Journal Generator process uses Receipt Accrual process entries in the RECV_LN_ACCTG_VW view as input to populate the PeopleSoft Journal Entry tables used by PeopleSoft General Ledger.
6. After you've created the journal entries for PeopleSoft General Ledger with the Journal Generator process, use the Journal Drill Down inquiry page to view and navigate to the accounting entries or to navigate PeopleSoft General Ledger.

- Run the Receipt Accrual SQR Report process (PORC700) to review the totals for each expense account and the total accrued liability.

Related Links

[Journal Drill Down Page](#)

[Budget Check Page](#)

[Accrue Receipts Page](#)

[Receipt Accrual Setup](#)

[PORC700 - Receipt Accrual](#)

[Understanding Entry Events in PeopleSoft Purchasing](#)

“Generate Journals Request Page” (Application Fundamentals)

Accruing Receipts

This section discusses how to run the Receipt Accrual process.

Pages Used to Accrue Receipts

Page Name	Definition Name	Usage
Accrue Receipts Page	RCPT_RUN_CNTRL	Run the Receipt Accrual process.
Accrue Receipt Page	RUN_RECVACCR_OL	Run the Receipt Accrual process, the Miscellaneous Charges process, or both. Accrue Receipts Page

Accrue Receipts Page

Use the Accrue Receipts page (RCPT_RUN_CNTRL) to run the Receipt Accrual process.

Navigation:

Purchasing > Receipts > Accrue Receipts

Note: The reversal code of the Journal Generator template, REC_ACCRUE, must first be set to *Do Not Generate Reversal* on the Journal Generator Template - Defaults page.

If any ChartFields are designated on the Detail Ledger Group - Chartfield page as *Balanced*, you need to select the *Always Inherit* rule for those ChartFields on the Chartfield Inheritance page.

As of Date

<i>Field or Control</i>	<i>Description</i>
Acctg Date (accounting date)	Select an accounting date to use for the period ending date. The current date appears by default. The system checks the accounting date against the open period date range specified on the Open Period Update page. Receipts dated after this accounting date do not accrue.

Process

<i>Field or Control</i>	<i>Description</i>
All Business Units	Select this option to accrue qualifying receipts for all business units. If you select this processing option, the system validates that the accounting date is in an open period for all business units. If the validation fails for a business unit, the system creates an error message. You have to either correct the error before continuing the process or use the single business unit option.
Business Units	Select this option to accrue qualifying receipts for a specific business unit. If selected, enter a business unit in the Values group box.
Receiver	Select this option to accrue qualifying amounts for received items on a specific receipt. If selected, enter a business unit and receipt number in the Values group box.

Additional Setting

<i>Field or Control</i>	<i>Description</i>
Default Entry Event Code	<p>Select a default entry event.</p> <p>For purchase order receipts with no entry event code on the purchase order distribution line, the value selected here populates the expense and accrual accounting lines, and the encumbrance line is blank.</p> <p>If there is already an entry event code on the purchase order distribution line, it is not replaced by the value selected on this page, and the entry event code populates expense, accrual, and encumbrance accounting lines.</p> <p>For non-purchase order receipts, the value selected here populates the expense and accrual accounting lines.</p>

Related Links

[Understanding Entry Events in PeopleSoft Purchasing](#)

“Generate Journals Request Page” (Application Fundamentals)

“Understanding PeopleSoft Interunit and Intraunit Functionality” (Application Fundamentals)

Performing Budget-Checking for Receipt Accruals

This section discusses how to budget-check receipt accruals.

Page Used to Perform Budget-Checking for Receipt Accruals

<i>Page Name</i>	<i>Definition Name</i>	<i>Usage</i>
Budget Check Page	PO_KK_RACCHECK_REQ	Perform budget-checking for receipt accruals by using the Comm. Cntrl. Budget Processor Application Engine process (FS_BP). This process is used to budget-check the expense and encumbrance reclassification transactions. You can choose to budget-check either type.

Budget Check Page

Use the Budget Check page (PO_KK_RACCHECK_REQ) to perform budget-checking for receipt accruals by using the Comm Cntrl.

Budget Processor Application Engine process (FS_BP). This process is used to budget-check the expense and encumbrance reclassification transactions. You can choose to budget-check either type.

Navigation:

Purchasing > Receipts > Budget Check Receipt

Budget-Check Request

<i>Field or Control</i>	<i>Description</i>
Tran Type (transaction type)	<p>Select the transaction type. Select from these source transactions:</p> <p><i>PO_RAEXP</i> (Receipt Accruals - Expense): Budget-check expense transactions and miscellaneous charges.</p> <p><i>PO_RAENC</i> (Receipt Accruals - Encumbrance): Budget-check encumbrance reclassifications and miscellaneous charges.</p>

Process Frequency

<i>Field or Control</i>	<i>Description</i>
Once	Select to run the request the next time the batch process runs. After the batch process runs, the process frequency is automatically set to Don't Run .
Always	Select to run the request every time the batch process runs.
Don't Run	Select to ignore the request when the batch process runs.

Process Options

<i>Field or Control</i>	<i>Description</i>
Unit Option	<p>The Receipt Option and Acctg Dt Optn criteria apply only to receipts that first meet the criteria defined here. Values are:</p> <p><i>All</i>: Budget-checks transaction type for all business units.</p> <p><i>Value</i>: Select to display the Unit field. Budget-checks transaction type for the business unit specified in the Unit field.</p>

Field or Control	Description
Receipt Option	<p>Displays a receipt ID option. Values are:</p> <p><i>All:</i> Budget-checks all receipts.</p> <p><i>Some:</i> Select to display the From/To fields. Budget-checks all receipts that match the range specified in the From/To fields.</p> <p><i>Value:</i> Select to display the Receiver ID field. Budget-checks the receipt that matches the ID specified in the Receiver ID field.</p>
Acctg Dt Optn (accounting date option)	<p>Displays the accounting date option. Values are:</p> <p><i>All:</i> Budget-checks all receipt accruals.</p> <p><i>Some:</i> Displays the From/To fields. Budget-checks all receipt accruals for which budget dates fall within the dates specified in the From/To fields.</p> <p><i>Value:</i> Displays the Accounting Date field. Budget-checks receipt accruals for which budget dates match the date specified in the Accounting Date field.</p>

Related Links

“Budget Checking Process” (PeopleSoft Commitment Control)

Viewing Receipt Accrual Accounting Line Entries

This section discusses how to access receipt accrual accounting line entries.

If the Receipt Accrual commitment control check box is enabled on the Installation Options - Products page, you can also view budget information and access the Commitment Control page from the Receipt Acctg Line page. Using the Commitment Control page you can view details about transactions such as, the source transaction type and the amount type for the journal, override budget-checking for the transaction, or run the Comm. Cntrl. Budget Processor process for the transaction.

Pages Used to View Receipt Accrual Accounting Line Entries

Page Name	Definition Name	Usage
Accrual Accounting Entry Page	RECV_LN_ACCTG_INQ	Access receipt accrual accounting entries.

Page Name	Definition Name	Usage
Commitment Control Page	KK_EXCPTN_OVER_SEC	View details about a commitment control transaction, such as the budget-checking status, the commitment control amount type, and commitment control transaction ID. You can also override budget-checking for the transaction or run the Comm. Cntrl. Budget Processor Application Engine process (FS_BP) for the transaction. <u>Accrual Accounting Entry Page</u>

Accrual Accounting Entry Page

Use the Accrual Accounting Entry page (RECV_LN_ACCTG_INQ) to access receipt accrual accounting entries.

Navigation:

Purchasing > Receipts > Review Receipt Information > Receipt Acctg Accrual Entries

This example illustrates the fields and controls on the Accrual Accounting Entry page. You can find definitions for the fields and controls later on this page.

The screenshot shows the 'Accrual Accounting Entry' page. At the top, there is a 'Search Criteria' section with fields for 'Business Unit' (US001), 'Fiscal Year' (2012), and 'Period' (11). Below these are 'From Receipt No', 'To Receipt No', 'Budget Status', and 'Type' dropdown menus, along with a 'Search' button. The 'Line Details' section below contains a table with columns: Receipt No, Line, Sched #, Dist, Type, Merchandise Amount, Currency, Budget Date, Budget Status, Budget Options, GL Unit, and Dist Qty. The table lists five entries with various types like 'Expense Distribution', 'Reserve for Encumbrances', and 'Receipt Accrual'.

Receipt No	Line	Sched #	Dist	Type	Merchandise Amount	Currency	Budget Date	Budget Status	Budget Options	GL Unit	Dist Qty
POAP-TOL	1	1	1	Expense Distribution	7,500.00	USD	11/28/2012	Not Chk'd		US001	500.00
POAP-TOL	1	1	1	Reserve for Encumbrances	-7,500.00	USD	11/28/2012	Not Chk'd		US001	500.00
POAP-TOL	1	1	1	Receipt Accrual	-7,500.00	USD	11/28/2012	Valid		US001	500.00
POAP-EXCP	1	1	1	Expense Distribution	2,000.00	USD	11/28/2012	Not Chk'd		US001	100.00
POAP-EXCP	1	1	1	Reserve for Encumbrances	-2,000.00	USD	11/28/2012	Not Chk'd		US001	100.00

Use the fields in the **Search Criteria** group box to filter transactions, and click the **Search** button to display the selections that match the search criteria in the **Line Details** group box.

Distribution Information

The following fields appear only if you enable commitment control for PeopleSoft Purchasing on the Installation Options - Products page:

Field or Control	Description
Budget Date	Displays the budget date, which is the same as the accounting date for receipt accruals.
Budget Status	Displays the budget status. Values are: <i>Error</i> , <i>Not Chk'd</i> (not checked), or <i>Valid</i> .
	Click the Budget Options button to access the Commitment Control page, where you can review transaction details and override budget-checking.

Related Links

“Understanding PeopleSoft ChartFields” (Application Fundamentals)

Viewing Receipt Accrual Journal Entries

The Receipt Accrual process loads receipt accrual data into staging tables for the Journal Generator process, which then creates journal entries based on the data.

This section discusses how to access receipt accrual journal entries.

Page Used to View Receipt Accrual Journal Entries

Page Name	Definition Name	Usage
<u>Journal Drill Down Page</u>	PO_GL_DRILL	View the PeopleSoft General Ledger or navigate to the PeopleSoft General Ledger accounting entries created by the Journal Generator process.

Journal Drill Down Page

Use the Journal Drill Down page (PO_GL_DRILL) to view the PeopleSoft General Ledger or navigate to the PeopleSoft General Ledger accounting entries created by the Journal Generator process.

Navigation:

Purchasing > Receipts > Review Receipt Information > GL Journal Drill Down

<i>Field or Control</i>	<i>Description</i>
GL Journal (go to general ledger journal)	Click this link to access the Journal Lines inquiry page in PeopleSoft General Ledger.
Base Amount DR (base amount debit)	Displays the base debit amount for the journal, which is the amount expressed in the base currency. The base currency code also appears.
Base Amount CR (base amount credit)	Displays the base credit amount for the journal, which is the amount expressed in the base currency. The base currency code also appears.

Account Lines Tab

<i>Field or Control</i>	<i>Description</i>
Acctg Date (accounting date)	Displays the journal accounting date, which designates the period ending date.

Other Amounts Tab

Select the **Other Amounts** tab.

<i>Field or Control</i>	<i>Description</i>
Foreign DR Amt (foreign debit amount)	Displays the foreign debit amount for the associated receipt line, which is the amount expressed in the transaction currency. The transaction currency code also appears.
Foreign CR Amt (foreign credit amount)	Displays the foreign credit amount for the associated receipt line, which is the amount expressed in the transaction currency. The transaction currency code also appears.

Accounting Period Tab

Select the **Accounting Period** tab.

<i>Field or Control</i>	<i>Description</i>
Distribution Line	Displays the distribution line number associated with the journal entry accounting period.

Chapter 47

Reviewing Receipt Information

Inquiring About Receipts

This section lists the pages used to inquire about receipts.

Pages Used to Inquire About Receipts

<i>Page Name</i>	<i>Definition Name</i>	<i>Usage</i>
Receipts Page	RECV_INQ	View detailed receipt information. This page and the pages accessible from it enable you to inquire about the same information available through the Maintain Receipts - Receiving page and the pages accessible from it.
Header Details Page	RECV_INQ_HDR	View receipt header details.
Line Details Page	RECV_INQ_LN_DTL	View receipt line details.
Line Status Details Page	RECV_INQ_LN_STATUS	View details about the status of a receipt line.
Manufacturing Information Page	RECV_INQ_MFG	View manufacturing details about a receipt line.
Receipt Distributions Page	RECV_INQ_DIST	View distribution information for a receipt line.
PO Distribution Details Page (purchase order distribution details)	RECV_INQ_PO_DIST	View purchase order distribution information for a selected receipt line.
Asset Management Information Page	RECV_INQ_AM	View information about asset purchases.
Inventory Putaway Information Page	RECV_INQ_PUTAWAY	View overriding information used to put away items to inventory business unit storage locations.

Page Name	Definition Name	Usage
Receipt Line Comments Page Receipt Header Comments Page	RECV_COMMENTS_INQ	View either receipt header information or line comments and attachments entered on the Receipt Header Comments page or Receipt Line Comments page.
Device Tracking Page	RECV_INQ_DEVICE	View device tracking information for each receipt distribution line.
Return to Vendor Page	RTV_LN_DISP_SEC	View RTV information for each receipt.
Document Status Page	PRCR_DOCSTAT_INQ	Access and review information about procurement documents associated with a receipt.
Partially Rcvd POs Page (partially received purchase orders)	RECV_PARTIAL	View information such as purchase order quantity, received quantity, merchandise amount for purchase order, and merchandise amount received related to purchase orders that have been partially received.
Procurement Card Information Page	CC_USE_HDR_DTL_1	View the procurement card information details related to the procurement card that is being used as the payment method for the purchase order.
Receipts By Location Page	RECV_LOC_INQ	Inquire about noninventory receipt location information.
Delivery Inquiry Page	RECV_DEL_INQ	Create receipt delivery inquiries.

Inquiring About Document Status

Understanding Document Status Inquiries

PeopleSoft Purchasing enables you to quickly cross-reference documents within a business process stream using a single known value in the stream.

For example, you may want to see the requisitions, request for quotations (RFQs), return to vendors (RTVs), and receipts associated with a purchase order.

From the menus for these transactions, you can view all of the procure-to-pay documents associated with their respective sources:

- Requisitions.
- RFQs.
- Purchase orders.
- Receipts.
- RTVs.
- Contracts.
- Associated vouchers and payments (if you're using PeopleSoft Payables).
- Strategic sourcing events (if you're using PeopleSoft Strategic Sourcing).
- Work orders (if you're using PeopleSoft Services Procurement).
- Material stock requests (MSRs) and inter-unit receipts (if you're using PeopleSoft Inventory).
- Workflow routings (if you're using PeopleSoft Workflow).

You can also access the document status inquiry from within each individual transaction.

Common Elements Used in Document Status Inquiries

<i>Field or Control</i>	<i>Description</i>
Budget Status	Budget checking status. Values are: <i>Error</i> : Error in budget check. <i>Not Chk'd</i> (not checked): Not budget checked. <i>Valid</i> : Valid budget check.
Carrier ID	Freight Carrier.
Document Type	Displays the type of document. Values include: <i>Requisition</i> , <i>Purchase Order</i> , <i>RTV</i> , <i>RFQ</i> , <i>Receipt</i> , <i>Work Order</i> , <i>MSR</i> , and <i>Contract</i> .
Currency	Currency code.
Bill of Lading	Bill of lading identifier.

Field or Control	Description
DOC ID (document ID)	<p>Click to open a new browser window that displays the inquiry page for the associated document.</p> <p>Inquiry pages that appear include:</p> <ul style="list-style-type: none"> • Requisitions - Req Inquiry page See Requisitions Inquiry Page. • All Supplier's inquiry page See Inquiring and Reporting on RFQs and Supplier Responses. • Purchase Order - Form inquiry page See Inquiring About Purchase Orders. • Receipts (inquiry) page See Inquiring About Receipts. • RTV Inquiry page See Inquiring About RTVs. • Events Inquiry page See Drilling Down to the General Ledger to View Entry Event Journal Entries. • If you are using PeopleSoft Inventory, click the DOC ID for a MSR or interunit receipt to access the Stock Requests Inquiry page for the associated document. See "Stock Requests Inquiry Selection Page" (PeopleSoft Inventory). • If you are using PeopleSoft Payables, click the DOC ID to access the Voucher Inquiry page or the Payment Inquiry page for the associated document. See "Viewing Voucher Summary Information" (PeopleSoft Payables). • If you are using PeopleSoft Strategic Sourcing, click the DOC ID to access the Strategic Sourcing Inquiry page for the associated document. See "Using the Sourcing Document Status Inquiry" (PeopleSoft Strategic Sourcing).

Field or Control	Description
Document Type	<p>Document type for the associated document: requisition, PO, RTV, RFQ, receipt, or contract.</p> <p>If you are using PeopleSoft Inventory, <i>MSR</i> or <i>Inter Unit Receipt</i> may appear.</p> <p>If you are using PeopleSoft Payables, <i>Voucher</i> or <i>Payment</i> may appear.</p> <p>If you are using PeopleSoft Strategic Sourcing, <i>Sourcing Event</i> may appear.</p> <p>If you are using PeopleSoft Services Procurement, <i>Work Order</i> may appear.</p>
Status	Status of the associated document.
Location	Supplier location.
	Click the Go To Document Status Inquiry button to open a new browser window that displays the document status inquiry for the associated document.
Match Manager	Click the link in this column to access the Match Manager query page for the associated voucher. This column appears only if you are using PeopleSoft Payables and there is an associated voucher that requires matching. This column appears only if <i>Voucher</i> is the document type for at least one row.
Accounting Entries	Click the link in this column to access the accounting entries for the associated document where it is a requisition, purchase order, payment, or voucher. If the associated document is a payment, you can access the accounting entries for the voucher associated with the payment. This link appears only if the associated document has been posted, and if accounting entries exist for at least one of the associated documents that appear. If the document is posted and then unposted, the link does not appear.

Viewing Document Status

This section discusses how to View Document Status.

Pages Used to View Document Status

<i>Page Name</i>	<i>Definition Name</i>	<i>Usage</i>
<u>Document Status Page - Requisitions</u>	PRCR_DOCSTAT_INQ	View requisition document status.
<u>Document Status Page - Request for Quote</u>	PRCR_DOCSTAT_INQ	View RFQ document status.
<u>Document Status Page - Purchase Order</u>	PRCR_DOCSTAT_INQ	View purchase order document status.
<u>Document Status Page - Receipts</u>	PRCR_DOCSTAT_INQ	View receipt document status.
<u>Document Status Page - Return to Vendor</u>	PRCR_DOCSTAT_INQ	View RTV document status.
<u>Document Status Page - Procurement Contract</u>	PRCR_DOCSTAT_INQ	View contract document status.

Document Status Page - Requisitions

Use the Document Status page (PRCR_DOCSTAT_INQ) to view requisition document status.

Navigation:

- **Purchasing > Requisitions > Review Requisition Information > Document Status Requisition**
- Click the **Document Status** link on the Maintain Requisitions - Requisition page.

This example illustrates the fields and controls on the Document Status page for a requisition.

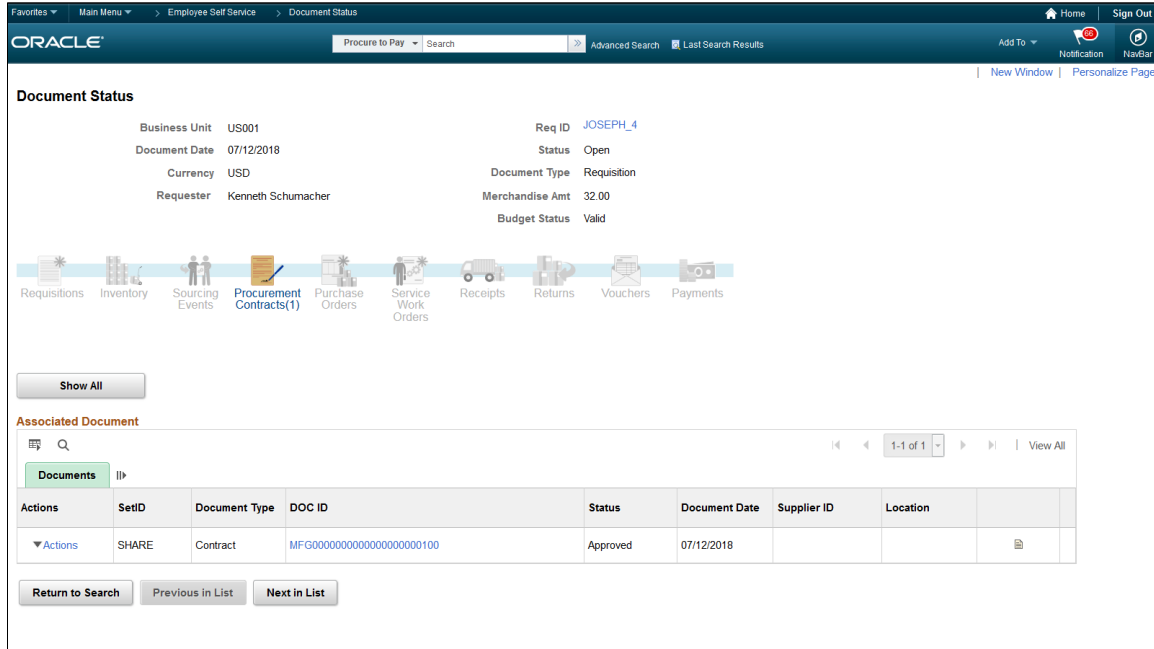

Field or Control	Description
Req ID (requisition ID)	Click to open a new browser window that displays the Requisitions - Req Inquiry page for the requisition.
Status	<p>Requisition status. Values are:</p> <p><i>Approved</i>: Requisition has been approved.</p> <p><i>Complete</i>: Requisition has been processed through to completion.</p> <p><i>Open</i>: This status appears by default from the requester setup. The requisition is not eligible to enter the approval process until an authorized user changes its status to <i>Pending Approval</i>.</p> <p><i>Pending approval</i>: Requisition is eligible to enter the approval process.</p> <p><i>Canceled</i>: Requisition has been canceled.</p>

Document Status Page - Request for Quote

Use the Document Status page (PRCR_DOCSTAT_INQ) to view RFQ document status.

Navigation:

- **Purchasing > Request for Quotes > Review RFQ Information > Document Status RFQ**
- **Purchasing > Request for Quotes > Add/Update RFQs > Request Quotes**

Select *4 - Document Status* in the **More** field on the Request Quotes page.

Field or Control	Description
RFQ ID (request for quote ID)	Click the link to open a new browser window that displays the Vendors By Quote - All Vendors inquiry page.
Status	RFQ status. Values are: <i>Approved:</i> RFQ is ready to be sent to vendors. <i>Closed:</i> RFQ is no longer open. <i>On hold:</i> RFQ is pending. <i>Canceled:</i> RFQ is rejected. <i>Open:</i> RFQ is not ready to be sent to vendors.

Document Status Page - Purchase Order

Use the Document Status page (PRCR_DOCSTAT_INQ) to view purchase order document status.

Navigation:

- **Purchasing > Purchase Orders > Review PO Information > Document Status Purchase Order**
- Click the **Document Status** link on the Maintain Purchase Order - Purchase Order page.

Field or Control	Description
PO ID	Click the link to open a new browser window that displays the Purchase Order Inquiry - Purchase Order page.
Status	PO status. Values are: <i>Approved:</i> Purchase order is ready to be sent to vendors. <i>Closed:</i> Purchase order is no longer open. <i>Pending Approval:</i> Purchase order is pending. <i>Pending Cancel:</i> Purchase Order is canceled. <i>Open:</i> Purchase order is not ready to be sent to vendors. <i>Dispatched:</i> Purchase order has been dispatched to the vendors.

Field or Control	Description
Doc ID (document ID)	<p>Click this link to access associated documents that are related to this inquiry.</p> <p>For example, suppose that you have a strategic sourcing event ID that is associated with this purchase order inquiry, click this link to access the strategic sourcing event.</p>

Document Status Page - Receipts

Use the Document Status page (PRCR_DOCSTAT_INQ) to view receipt document status.

Navigation:

- **Purchasing > Receipts > Review Receipt Information > Document Status Receipt**
- Click the **Document Status** link on the Maintain Receipts - Receiving page.

Field or Control	Description
Receiver ID	Click the link to open a new browser window that displays the Receipts inquiry page where you can view detailed receipt information.
Status	<p>Receipt status. Values are:</p> <p><i>Open</i>: Not all of the edits have passed. One or more receipt lines are in an <i>Open</i> status.</p> <p><i>Received</i>: All of the edits have passed. All of the lines are in a <i>Received</i> or <i>Canceled</i> status.</p> <p><i>Hold</i>: Receipt is on hold until released by user.</p> <p><i>Moved</i>: Item has been interfaced to PeopleSoft Asset Management, PeopleSoft Inventory, or PeopleSoft Manufacturing.</p> <p><i>Closed</i>: All of the receipt lines have been moved and matched (when required). All of the interface requirements have been fulfilled and no further processing is required.</p> <p><i>Canceled</i>: All of the lines are canceled. Canceling cannot be reversed.</p>

Document Status Page - Return to Vendor

Use the Document Status page (PRCR_DOCSTAT_INQ) to view RTV document status.

Navigation:

- **Purchasing > Return to Vendor > Document Status RTV**

- Click the **Document Status** link on the RTV page.

Field or Control	Description
RTV ID	Click to open a new browser window that displays the RTV Inquiry page where you can view detailed RTV information.
Status	<p>Values are:</p> <p><i>Closed:</i> The line has been closed.</p> <p><i>Open:</i> Appears by default when the supplier return is initiated.</p> <p><i>Shipped:</i> The line has been shipped. A line is considered shipped when the line's shipped quantity equals the returned quantity.</p> <p><i>Canceled:</i> The line has been canceled.</p>

Document Status Page - Procurement Contract

Use the Document Status page (PRCR_DOCSTAT_INQ) to view contract document status.

Navigation:

Procurement Contracts > Review Contract Information > Document Status

Field or Control	Description
Contract	Click this link to open a new browser window that displays the Events Inquiry page.
Doc ID	<p>Click to access associated documents that are related to this inquiry.</p> <p>The documents differ depending on the type of contract.</p> <p>For example, suppose that you have a strategic sourcing event ID that is associated with this contract inquiry, click this link to access the strategic sourcing event.</p>

Note: Manufacturing contracts will not have a supplier ID.

Analyzing Purchasing Using PeopleSoft Insights

Understanding PeopleSoft Insights for Purchasing

PeopleSoft Insights is an analytical engine that provides visual reports (visualizations) in the form of charts, tables, graphs and so on. The visualizations are based on queries that retrieve data from the PeopleSoft Search Framework.

Dashboard administrators use PeopleSoft Insights and the underlying analytics engine to create both dashboards and visualizations, which are then attached to dashboards. The dashboard can contain multiple visualizations. The visualization and dashboard are objects in PeopleSoft Insights, which must be imported into the PeopleSoft application.

Typically, a PeopleSoft user who has the Search Administrator role performs these tasks:

- Imports dashboards.
- Configures dashboards as tiles or related information.
- Specifies user privileges for the dashboard.

End users access dashboards based on user privileges.

- Deploys dashboards.

Note: Oracle recommends that you do not modify or edit a delivered dashboard or visualization. You may copy a delivered visualization and then modify it as per your business requirements.

For more information, see *PeopleTools Search Technology*, “Working with Insights Dashboards for PeopleSoft Application Data”, Understanding Application Data and Insights Dashboards.

For more information about PeopleSoft Search Framework, see [Understanding PeopleSoft Insights Using PeopleSoft Search Framework](#).

Setting up Insights Dashboards for Purchasing

PeopleSoft Purchasing delivers Insights dashboards to analyze Purchasing data using different visualizations.

To set up Insights dashboards for Purchasing:

1. Use the Installation Options: “Installation Options - Purchasing Page” (Application Fundamentals) to determine the reporting currency and rate type for dashboard visualizations.

This setup is required for all Purchasing Insights Dashboards.

These values identify a common currency for comparing expenses in various currencies across business units. If you change the value for reporting currency or rate type on this page, then the search index must be refreshed using the *Full Index* option for the change to be reflected in the dashboard. Conversion of the amount to reporting currency amount happens using the currency exchange rate with an effective date when the row is added to the index. There is no refresh unless the row is refreshed again in the index.

2. Use the Deploy Search Definition page to deploy the search definition (PeopleTools, Search Framework, Administration, Deploy Search Objects).

The PeopleSoft Purchasing search definitions are:

- EP_PO_CONTRACT_KIB (Procurement Contracts dashboard)
- EP_PO_RECEIPTS_KIB (Purchasing Effectiveness and Purchasing Operations dashboard)
- EP_PO_POA_KIB (Supplier Activity Analytics Insights dashboard)

See also “Search Definitions and Privileges” (Application Fundamentals) for a list of Purchasing search definitions for PeopleSoft Insights dashboards.

3. Use the Schedule Search Index page to run the Build Index process (PeopleTools, Search Framework, Administration, Schedule Search Index).

The first time you run this process for a search index, you should always select *Full Index* as the **Indexing type**. You can run incremental indexes after that.

4. Use the Deploy Insights dashboards page to deploy the dashboard and the tile (PeopleTools, Search Framework, Administration, Deploy Insights Dashboards).

When you deploy a dashboard, you are copying the dashboard from the PeopleSoft database to your instance of PeopleSoft Insights. The deployed dashboard is then available on the Saved Objects page in the Management section on the Insights home page. Use the Deploy Insights Dashboards page to deploy or update a dashboard. For more information on Deploying a Dashboard, see PeopleTools:Search Technology, Working with Insights Dashboards for PeopleSoft Application Data, Deploying a Dashboard.

5. Use the “Personalize Homepage Page” (Application Fundamentals) to add the tile to a homepage.
6. Use the User Roles page to add the privileges to users (PeopleTools, Security, User Profiles, User Profiles).

The PeopleSoft Purchasing privileges are:

- Insights PO Edit Privilege
- Insights PO View Privilege

See also “Search Definitions and Privileges” (Application Fundamentals) for a list of all product privileges for PeopleSoft Insights dashboards.

7. Real Time Indexing is available for Procurement Contracts (EP_PO_CONTRACT_KIB) and Purchasing Effectiveness (EP_PO_RECEIPTS_KIB) dashboards.

Configure the following Search Definitions for Real Time Indexing:

- **EP_PO_CONTRACT_KIB**

Add *CNTRCT_HDR* and *PO_HDR* Transaction Records to *PO_CA_ANALYT_VW* Record and Trigger SQL.

- **EP_PO_RECEIPTS_KIB**

Add *RECV_HDR* and *PO_HDR* Transaction Records to *PO_ANALYTICS_VW* Record and Trigger SQL.

For more information about Real Time Indexing, refer:

[Understanding Search in PeopleSoft Purchasing](#)

“Understanding Real Time Indexing in FSCM” (Application Fundamentals)

PeopleTools: PeopleSoft Search Technology, Using the Configure Real Time Indexing

Adding Purchasing Tiles for Insights Dashboards

PeopleSoft Purchasing has these tiles associated with Insights dashboards:

- Procurement Contracts, see [Procurement Contracts Dashboard](#)
- Purchasing Effectiveness, see [Purchasing Effectiveness Dashboard](#)
- Purchasing Operations, see [Purchasing Operations Dashboard](#)
- Supplier Activity Analytics, see [Supplier Activity Analytics Insights](#)

For additional information about how to add a tile to a PeopleSoft Fluid Home page, see “Adding Homepages and Tiles” (Application Fundamentals) and *PeopleTools: Application User’s Guide*, “Working With PeopleSoft Fluid User Interface”, Working with Fluid Homepages and Dashboards, Managing Tiles on Fluid Homepages and Dashboards.

This example illustrates the Procurement Contracts tile.

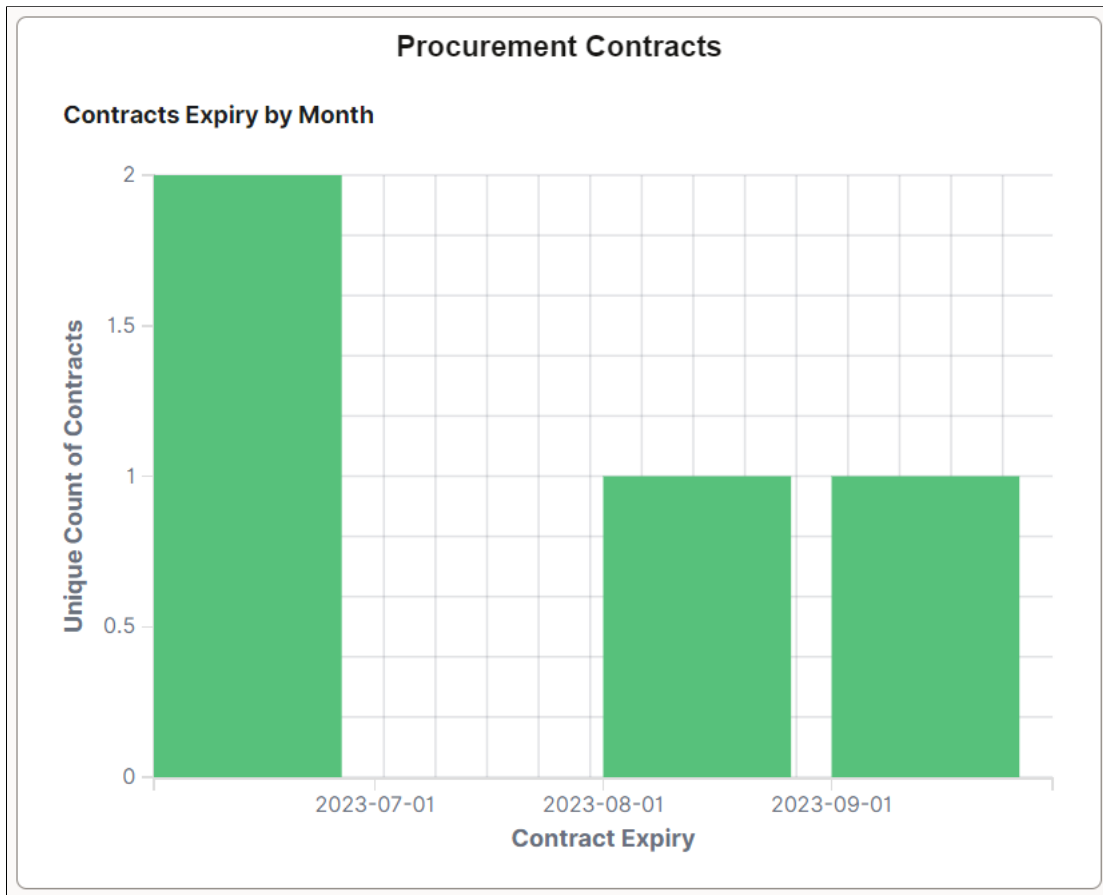

This example illustrates the Purchasing Effectiveness tile.

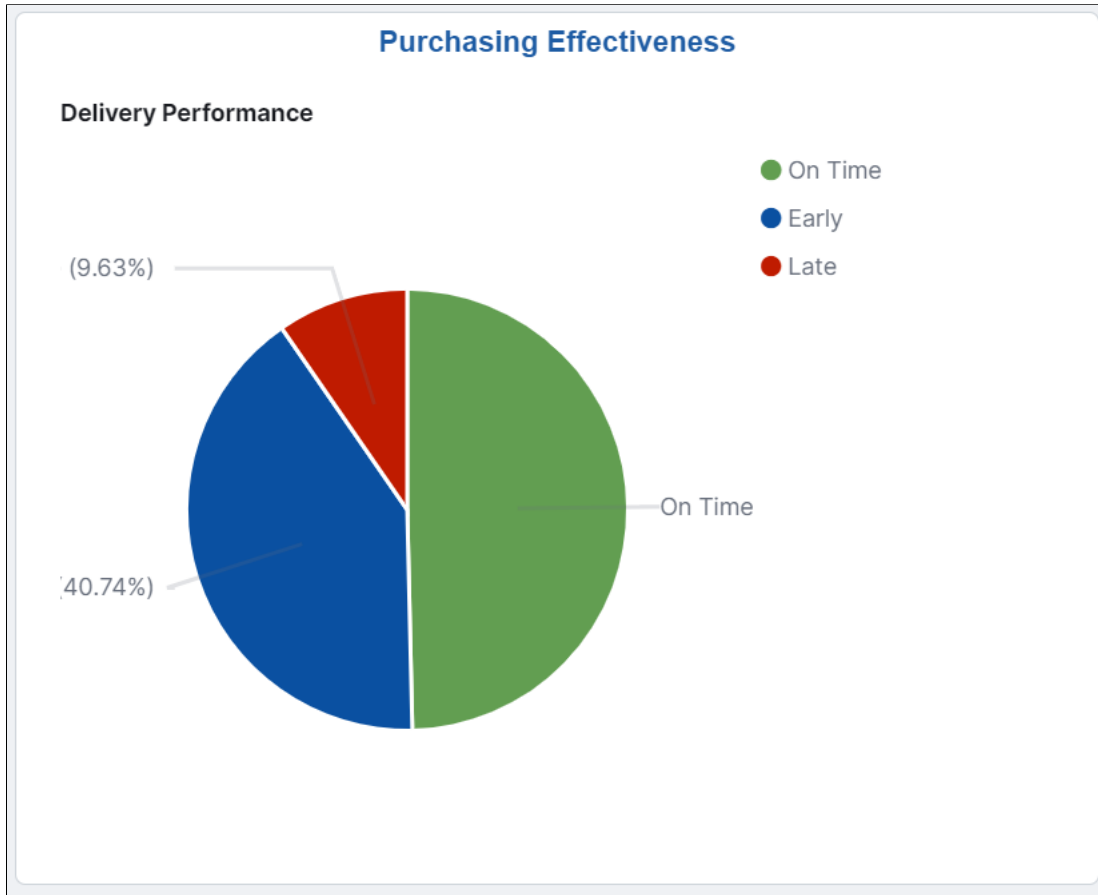

This example illustrates the Purchasing Operations tile.



This example illustrates the Supplier Activity Analytics tile.

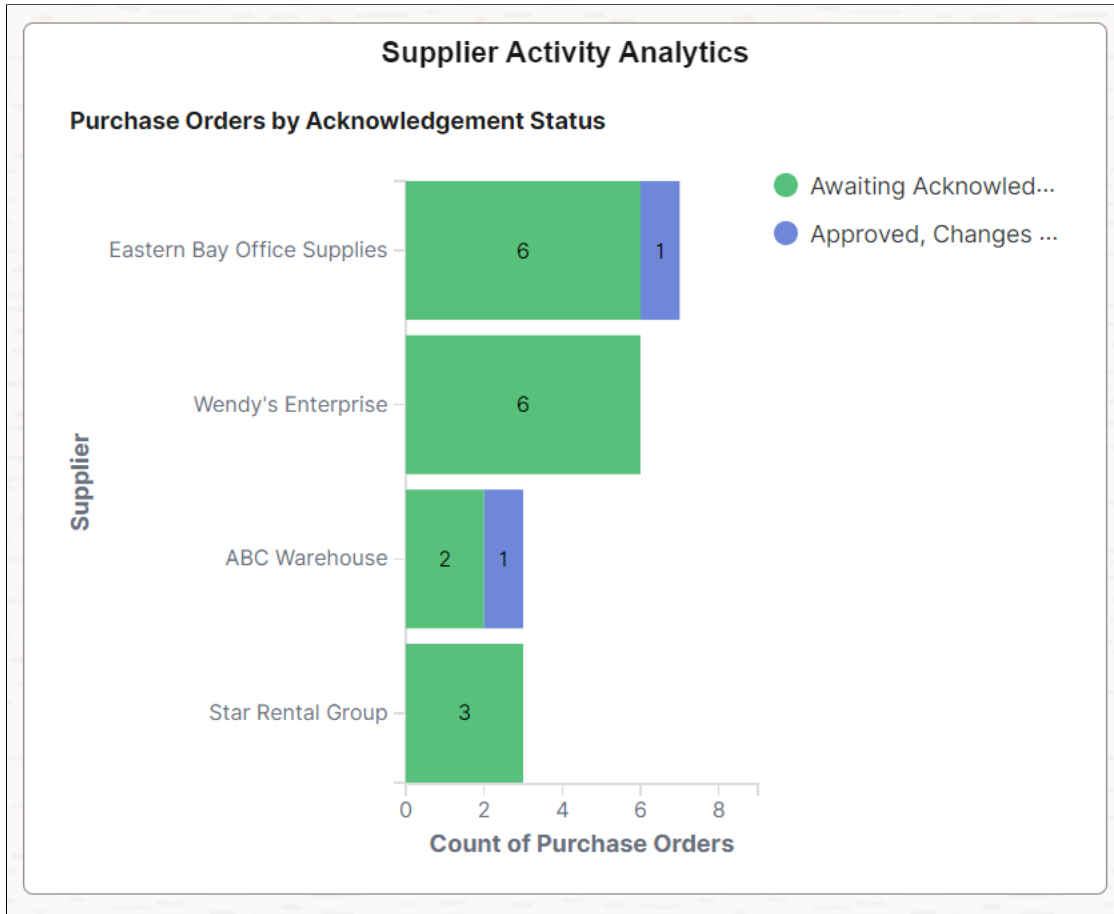

Analyzing Purchasing Using PeopleSoft Insights

This topic displays and explains how to analyze Purchasing data using PeopleSoft Insights dashboards.

Pages Used to Analyze Purchasing using PeopleSoft Insights

<i>Page Name</i>	<i>Definition Name</i>	<i>Usage</i>
<u>Procurement Contracts Dashboard</u>		Provides insight into the contract trends within the selected time frame.
<u>Purchasing Effectiveness Dashboard</u>		Provides insight into the current trend of purchase volume, top suppliers, rejections and returns of purchase orders, and procurement volume.

<i>Page Name</i>	<i>Definition Name</i>	<i>Usage</i>
<u>Purchasing Operations Dashboard</u>		Provides insight into the purchase order trend based on different criteria such as, status, acknowledgement status, budget status, document tolerance status, and so on.
<u>Supplier Activity Analytics Insights</u>		Provides insight into the performance of suppliers based on the compliance to Service Level Agreement (SLA), quality, delivery performance, pricing, and POA responsiveness.

Procurement Contracts Dashboard



Use the Procurement Contracts dashboard to view the contract trends within the selected time frame.

Navigation:

Select the Procurement Contracts tile.

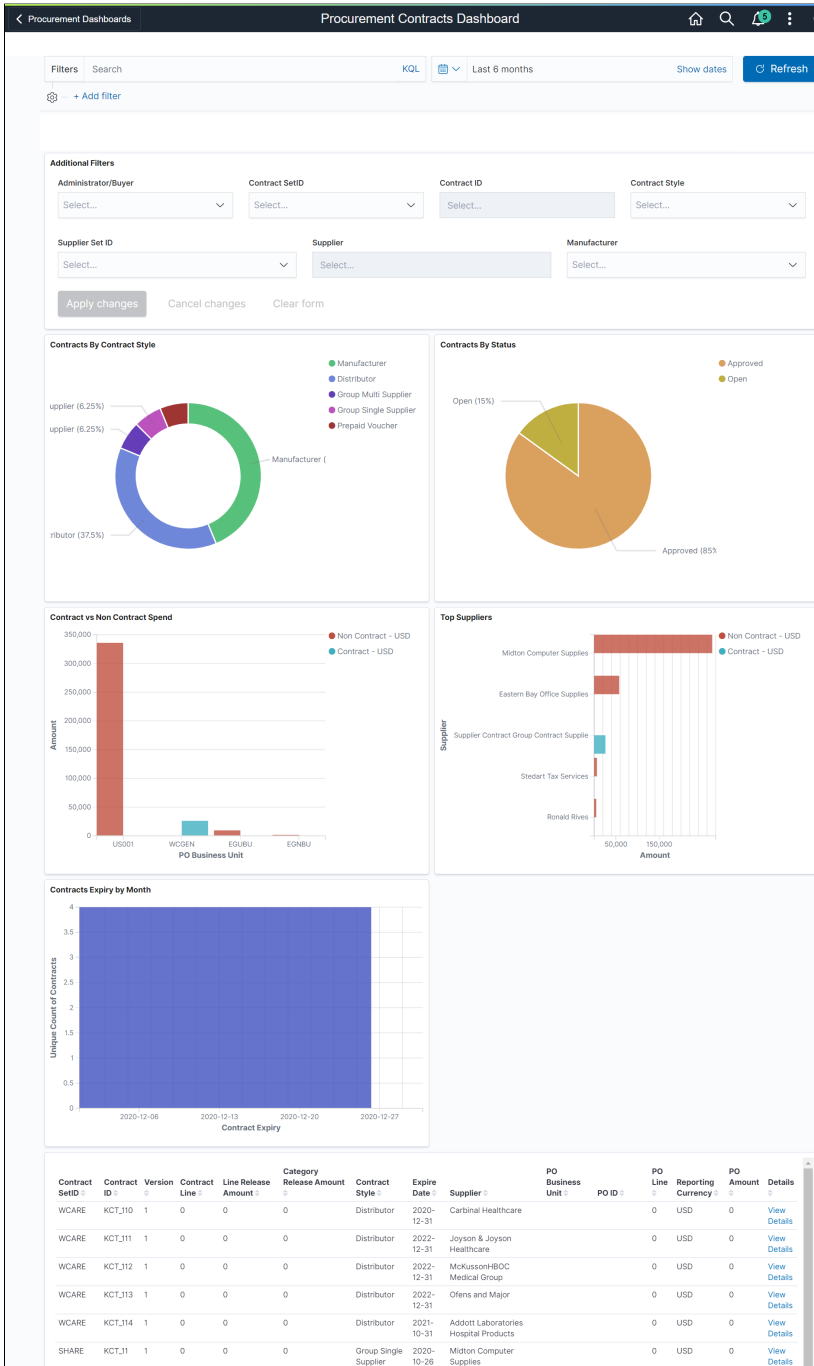
This example illustrates the fields and controls on the Procurement Contracts Dashboard. You can find definitions for the fields and controls later on this page.



Field or Control	Description
	Click to view a visualization in full-screen mode. You can see this icon when you hover over a visualization.
	Select to make changes to the current filter criteria.

Field or Control	Description
	Click to select the required time period. The dashboards display data according to the date range specified.

You can filter the data by entering a relevant search text in the Search field or by specifying additional filter criteria. You can also filter the data by clicking a segment or a bar. The filters modify the data across all visualizations. The data table below the visualizations displays the contract and purchase order details that match the specified filter criteria. You can download the data as a CSV file.

Visualizations that are part of this dashboard are:

Contracts by Contract Style — Shows the distribution of contracts by styles for the selected time frame.

Contracts by Status — Shows the distribution of contracts by their status for the selected time frame.

Contract Vs Non Contract Spend — Shows the Contract and Non Contract amount based on the purchase order data. A purchase order with a status of *Cancelled* or *Open* is excluded from this visualization.

Top Suppliers — Shows the top five suppliers in the descending order of the Non Contract spend.

Contracts Expiry by Month — Shows the number of contracts expiring in the next six months from the date the dashboard is accessed. Contracts expiry is counted irrespective of whether the contract is already renewed, and a new contract is created or not.

At the bottom of the dashboard, the data table lists the contracts details with corresponding purchase order information if available. If a purchase order was created without a contract, the *Contract ID* field appears blank. Click the *View Details* link to navigate to the Document Status page.

Purchasing Effectiveness Dashboard

Use the Purchasing Effectiveness dashboard to analyze the current trend of purchase volume, top suppliers, purchase order volume, rejections and returns of purchase order by suppliers, and procurement volume.

Navigation:

Select the Purchasing Effectiveness tile.

This example illustrates the fields and controls on the Purchasing Effectiveness dashboard.

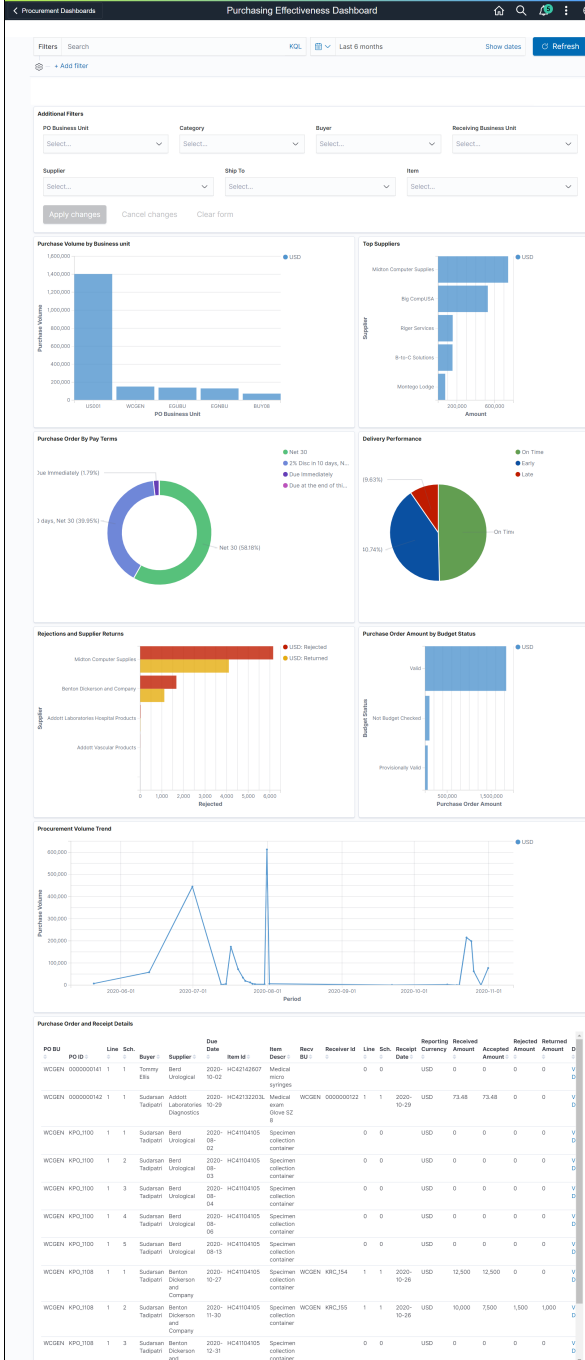

The dashboard helps managers to analyze the purchase orders and procurement volume in terms of different criteria.

You can apply different filters to modify the data across all visualizations. Hover over different sections in the visualization to see the statistics.

Visualizations that are part of this dashboard are:

Purchase Volume by Business Unit — Shows the purchase volume within the specified time frame for each business unit that the user has access to. Amounts, irrespective of the transaction currency, are converted to the reporting currency defined on the Purchasing Installation Options page.

Top Suppliers — Shows the top five suppliers by purchasing amount. The dashboard shows the suppliers based on the applied filters.

Purchase Order by Pay Terms — Shows the purchase order volume by payment.

Delivery Performance — Shows the number of shipments that are received on time, early, and late. If the item is received on the date mentioned as the due date in the purchase order, it is considered to be an on time delivery. If it is before and after the due date, then it is considered as Early and Late deliveries respectively.

Purchase Order Amount by Budget Status — Shows the purchase order amount grouped by various budget statuses. Purchase orders that do not require budget validations are excluded from this visualization.

Rejections and Supplier Returns — Shows the top five suppliers with the purchase volume that they rejected or returned. Rejections indicate the purchase order items that are rejected at the receipt level, thus reducing the Net received quantity of the receipt. Supplier returns indicate the purchase order items that are removed from the Net received quantity through Supplier Returns using RTV.

Procurement Volume Trend — Shows the purchase volume created over a specific time frame.

Below the visualizations, the Purchase Order and Receipt Details table lists the purchase orders and the corresponding receipt details. Click the *View Details* link to view the Document Status page for the selected purchase order.

Purchasing Operations Dashboard

Use the Purchasing Operations dashboard to view the purchase order trend based on criteria such as, status, acknowledgement status, budget status, document tolerance status, and so on.

Navigation:

Select the Purchasing Operations tile.

This example illustrates the fields and controls on the Purchasing Operations dashboard.

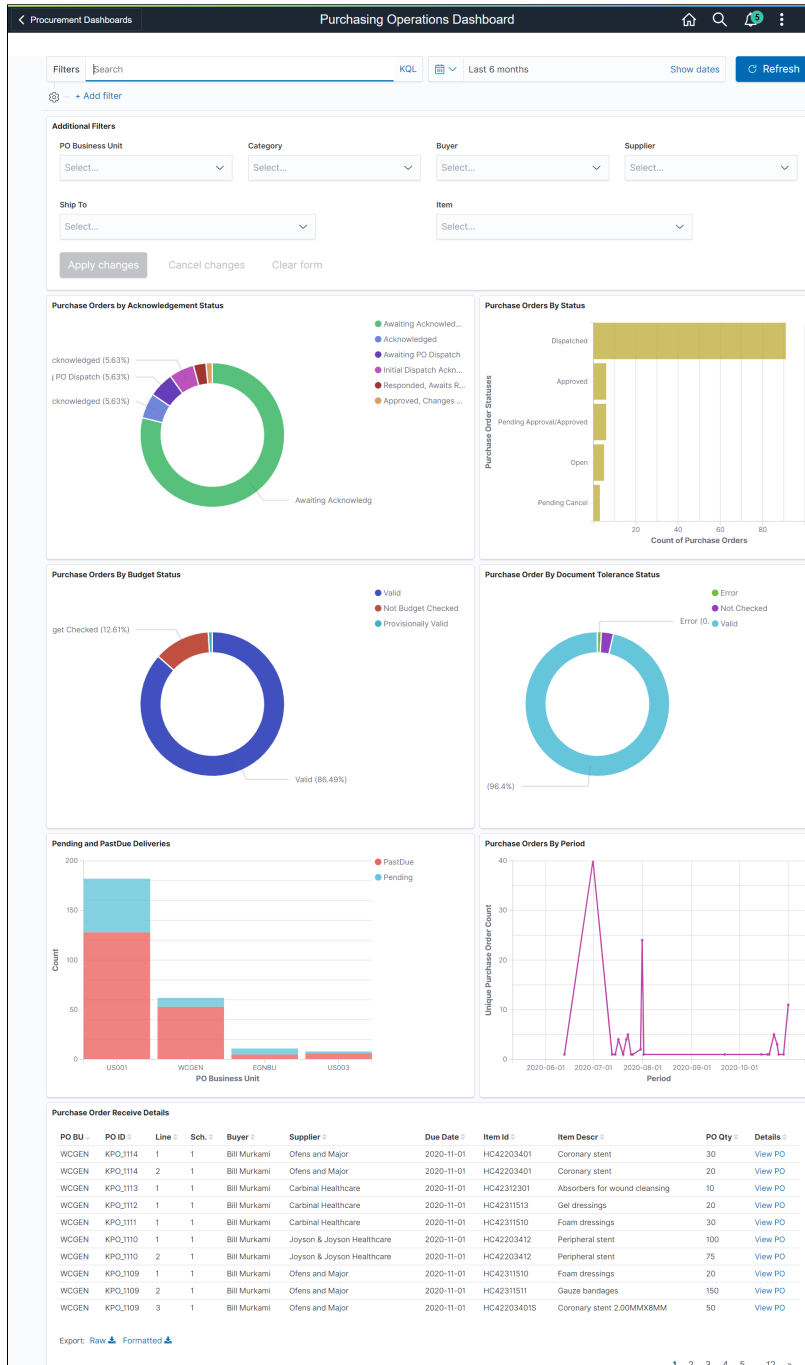

The Purchasing Operations dashboard helps buyers to analyze the current trend of purchase orders. You can apply different filters to modify data across all visualizations. Hover over different sections in the visualization to see the detailed statistics.

Visualizations that are part of this dashboard are:

Purchase Orders by Status — Shows the number of purchase orders by their statuses across all the business units. Purchase orders are displayed based on the date range that you have selected and the purchase order date. *Cancelled* and *Completed* purchase orders are excluded from this visualization.

Purchase Orders by Acknowledgement Status — Shows the number of purchase orders by their acknowledgement status. Purchase orders that do not require acknowledgement are excluded from this visualization.

Purchase Orders by Budget Status — Shows the number of purchase orders by their budget status. Purchase orders that do not require budget check are excluded from this visualization.

Purchase Orders by Period — Shows the number of purchase orders created over a time period based on the purchase order date. The time period can be set using the date picker.

Purchase Orders by Document Tolerance Status — Shows the number of purchase orders based on the status of document tolerance.

Pending and Past Due Deliveries — Shows the number of purchase orders by their business units that are pending or past their delivery due date. The Pending bar represents the purchase orders that are open either partially or fully, but with a due date in the future. The Past Due bar represents those schedules that are either not yet received or partially received, and past the due date. Non-purchase order receipts are excluded from this visualization as they do not have a stipulated due date.

At the bottom of the dashboard, The Purchase Order Receive Details table lists the purchase orders and items that match the applied filters. Click the *View PO* link of a purchase order to view or modify its details.

Supplier Activity Analytics Insights

Use the Supplier Activity Analytics Insights to analyze the performance of suppliers based on the compliance to Service Level Agreement (SLA), quality, delivery performance, pricing, and POA responsiveness.

This dashboard monitors key performance indicators (KPIs) to measure supplier performance and ensure contractual obligations are met. The procurement administrator can view the procurement activity across several lines of business by drilling the visualization of specific buyers and/or suppliers.

Navigation:

Select the Supplier Activity Analytics tile.

This example illustrates the fields and controls on the Supplier Activity Analytics Insights page (1 of 3).

Supplier Activity Analytics Insights

KQL ▼ Last 1 year Show dates Refresh

Buyer Name: Kenneth Schumacher x
+ Add filter

Additional Filters

Supplier Name

Buying Organization

Ship To Location

Apply changes
Cancel changes
Clear form

Number of POs Dispatched by Buying Organization

Buying Organization	PO Dispatched
US001	23
US003	13
WCCGN	4
US005	6
AU501	1

Value of POs Dispatched by Buying Organization

Buying Organization	PO Value
US001	~10,000,000
US003	~4,000,000
WCCGN	~2,000,000
US005	~1,000,000
AU501	~100,000

Number of POs Dispatched by Ship To Location

Supplier	Ship To Location	PO Dispatched
Wendy's Enterprise	USA - New York	20
	USA - California	4
Eastern Bay Office Supplies	USA - California	18
	USA - Illinois	1
Bayard Healthcare	USA - Illinois	4
	USA - Florida	3
	EGV05 - Miami, FL	2
	USA - Colorado	2
Midton Computer Supplies	USA - New York	4
	USA - New Orleans	4
	USA - Pleasanton	2
	USA - Oregon	2
ABC Warehouse	USA - New Orleans	2
	USA - Pleasanton	1

Value of POs Dispatched by Ship To Location

Supplier	Ship To Location	PO Value
Star Rental Group	USA - New York	3,803,500
Eastern Bay Office Supplies	USA - New York	3,469,950
Eastern Bay Office Supplies	EGV05 - Miami, FL	151,000
Nathan Allen Home Interiors	USA - New York	3,164,420
ABC Warehouse	USA - Oregon	750,000
ABC Warehouse	USA - Colorado	625,000
ABC Warehouse	USA - Phoenix	350,000
ABC Warehouse	USA - Illinois	323,875
ABC Warehouse	USA - New York	195,000
ABC Warehouse	Other	10,000

Export: [Raw](#) [Formatted](#)

This example illustrates the fields and controls on the Supplier Activity Analytics Insights page (2 of 3).

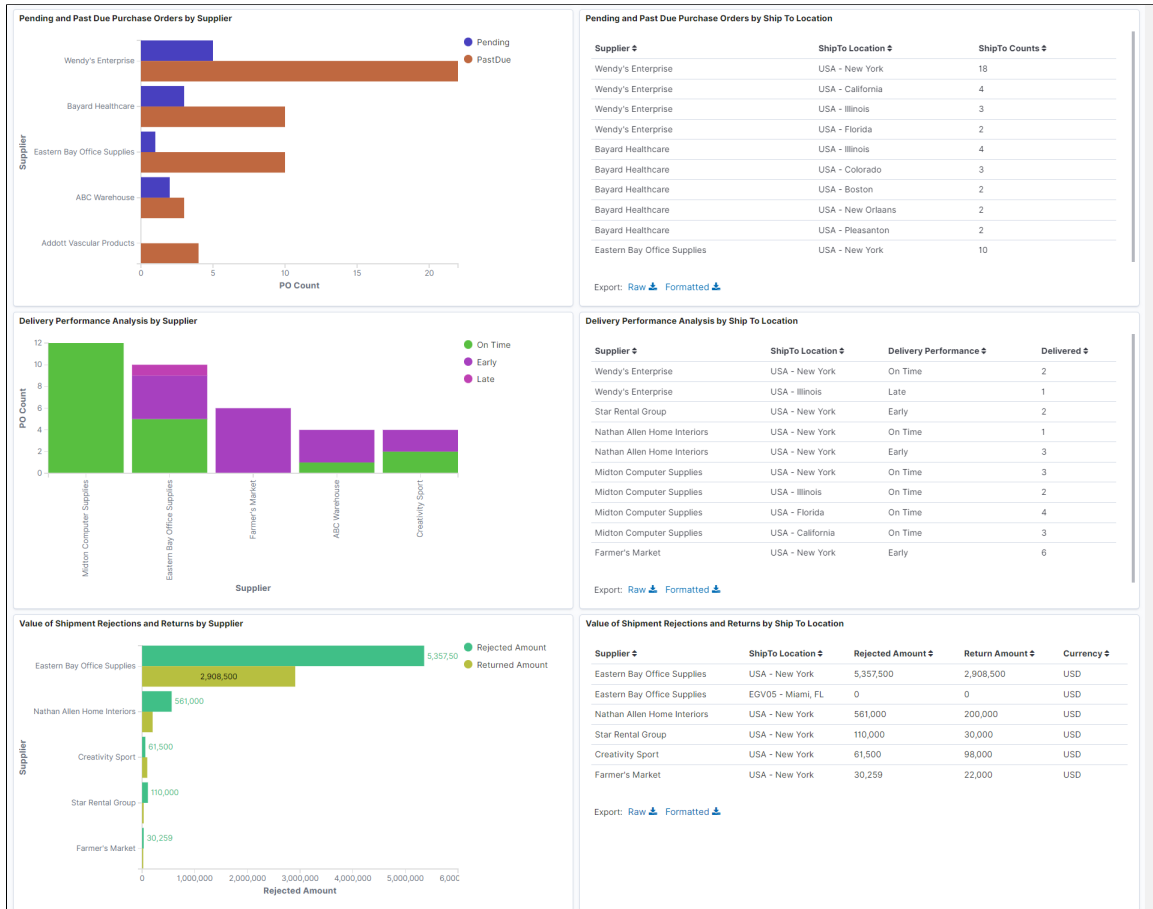

This example illustrates the fields and controls on the Supplier Activity Analytics Insights page (3 of 3).

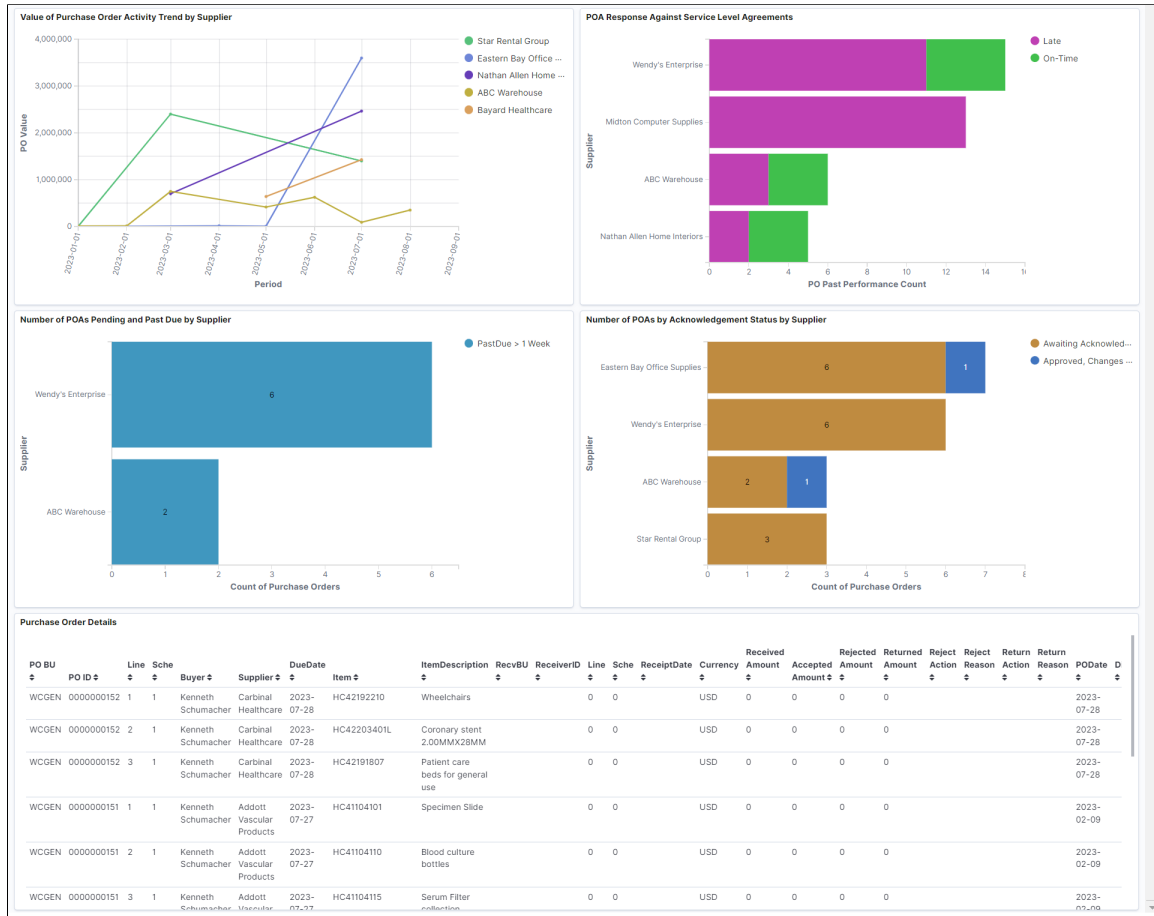

Visualizations that are part of this dashboard are:

Number of POs Dispatched by Buying Organization — Shows the number of POs dispatched by Buying Organization for each Supplier associated with the Supplier User.

Value of POs Dispatched by Buying Organization — Shows the total value of POs dispatched by Buying Organization for each Supplier associated with the Supplier User.

Number of POs Dispatched by Ship To Location — Shows the number of POs dispatched by Ship to Location for each Supplier associated with the Supplier User.

Pending and Past Due Purchase Orders by Supplier — Shows the PO schedules that are either not yet received or partially received, and the due date is in the past.

Delivery Performance Analysis by Supplier — Shows the delivery performance based on qualifiers. On Time: Received on the date mentioned as the due date in the PO. Early: Received before the due date. Late: Received after the due date.

Value of Shipment Rejections and Returns by Supplier — Shows the total amount of rejections and returns for each supplier associated with the Supplier User.

Value of Purchase Order Activity Trend by Supplier — Shows the total purchase volume based on the supplier, buying organization, or ship to location chosen.

POA Response Against Service Level Agreements — Shows the purchase order acknowledgment performance based on qualifiers. On Time: Acknowledgment on the date mentioned as the due date in Supplier/Bu level. Late: Acknowledged after the due date.

Number of POAs Pending and Past Due by Supplier — Shows the purchase order schedules that are either not yet acknowledged or partially acknowledged, and the due date is in the past.

Number of POAs by Acknowledgement Status by Supplier — Shows the count of unique POs for each PO acknowledgment status.

The detailed tabular view is also available for the *Value of POs Dispatched by Ship To Location*, *Pending and Past Due Purchase Orders by Ship To Location*, *Delivery Performance Analysis by Ship To Location*, and *Value of Shipment Rejections and Returns by Ship To Location*.

At the bottom of the dashboard, the **Purchase Order Details** table lists the purchase orders and items that match the applied filters. Click the *Details* link of a purchase order to view or modify its details on the *Purchase Order Acknowledgment* page.

Analyzing Procurement History

Understanding Procurement History Analysis

Analyzing procurement data provides you with information about procurement trends and can assist you in managing supplier relationships. PeopleSoft Purchasing enables you to accumulate and analyze summaries of purchasing, invoicing, and receiving transactions.

PeopleSoft Purchasing provides you with an Application Engine process for generating procurement history data based on a reporting entity. The reporting entity controls how procurement history information is accumulated into monthly or periodic buckets and for which business units to collect procurement information. You configure a procurement analysis inquiry profile for a user ID based on reporting entity, candidate view, and how the user wants the procurement data to appear on the inquiry page.

PeopleSoft delivers seven procurement views: Requisition List (PRCR_LST_ARQ_VW), PO Schedule List (PRCR_LST_APO_VW), Procurement History (PRCR_HST_AAA_VW), Receiving List (PRCR_LST_ARC_VW), Receiving History (PRCR_HST_SVN_VW), Voucher List (PRCR_LST_AAP_VW) and Voucher History (PRCR_HST_VND_VW). Each view is mapped to one of the five inquiry types: History, PO List, Receiver List, Requisition List and Voucher List. In addition to the system delivered views, you can create your own view for your own aggregating and viewing purposes as long as the view created is a subset of the ones delivered by PeopleSoft.

Understanding the Procurement Analysis View Creation Process

To create a view that is eligible for use in procurement analysis:

1. Define the new Structured Query Language view by using PeopleTools Application Designer.

The fields in this view should be based on fields in a view that is available in the **View ID** field on the View Candidate Setup page.

2. Modify the view text of the procurement analysis valid candidate view (PRCR_VALID_VIEW) to include the new view by using PeopleTools Application Designer.
3. Create the new view as well as the valid candidate view (PRCR_VALID_VIEW) by using PeopleTools Application Designer.

This step creates the view in the database by using the PeopleTools definition.

4. Access the View Candidate Setup page to set up the new view, associate it with an inquiry type, and make the view eligible for selection in the inquiry profile setup.

See the product documentation for *PeopleTools: Application Designer Developer's Guide*

Configuring Procurement Analysis Inquiries

To define procurement controls, use the Define Procurement Controls component (PRCR_ENTITY_CNTL). To define field candidates, use the Field Candidates component (PRCR_FLDCAN_TBL). To define profile inquiries, use the Profile Inquiries component (PRCR_PRF_OPR). To define views, use the View component (PRCR_VIEW_CAN).

This section discusses how to Configure Procurement Analysis Inquiries:

Pages Used to Configure Procurement Analysis Inquiries

<i>Page Name</i>	<i>Definition Name</i>	<i>Usage</i>
<u>Define Procurement Controls Page</u>	PRCR_ENTITY_TBL	Set up reporting entities, which function as high-level groupings for your inquires and pagelets.
<u>Field Candidate Setup Page</u>	PRCR_FLDCAN_TBL	Select fields that you want to be eligible for selection for an inquiry type.
<u>View Candidate Setup Page</u>	PRCR_VIEW_CAN	Create views of procurement data to use in inquiry functions.
<u>Inquiry Profile Setup Page</u>	PRCR_PRF_OPR	Define up to seven inquiry profiles per user ID to be used as filters for viewing either history files or current data in procurement tables (called lists).
<u>Setup Procurement Users Page</u>	OPR_DEF_RPT_TBL	Assign users to a Reporting Entity and specify the periods for which data should be displayed.

Define Procurement Controls Page

Use the Define Procurement Controls page (PRCR_ENTITY_TBL) to set up reporting entities, which function as high-level groupings for your inquires and pagelets.

Navigation:

Purchasing > Analyze Procurement > Setup Profiles > Define Procurement Controls

Note: This page displays different fields depending on whether you are defining a procurement history reporting entity type or a spend analysis reporting entity type.

Procurement History Reporting Entity Type

<i>Field or Control</i>	<i>Description</i>
Chunk Size	Enter the number of rows to display at one time. To help improve performance, PeopleSoft recommends that you indicate a specific number of rows of data to retrieve (for example, 10 rows).
Calendar ID	Select the ID for a predefined calendar, which you set up on the Business Calendar page. Procurement analysis uses it to determine which data to retrieve and process based on dates.

Data Selection Criteria

Use the **Data Selection Criteria** group box to define high-level reporting entity data selection criteria.

<i>Field or Control</i>	<i>Description</i>
Include PO Data	Select if you want the inquiries for the reporting entity to include purchase order data.
Include all PO units	Select if you want to include all purchasing business units in this reporting entity.
Include AP Data (include accounts payable data)	Select if you want the inquiries for the reporting entity to include voucher data.
Include all AP units (include all accounts payable units)	Select if you want to include all accounts payable business units in this reporting entity.
Include Receiver Data	Select if you want the inquiries for the reporting entity to include receipt data.
Include all Receiving units	Select if you want to include all receiving business units in this reporting entity.
Include Lines With no Item ID	Select if you want to include lines with no item ID specified.
Business Unit	Select all the PeopleSoft Purchasing, Receiving or Payables business units for which this reporting entity is responsible. When updating the procurement history tables, the process selects all purchase orders assigned to the PeopleSoft Purchasing business units specified here.

Spend Analysis Reporting Entity Type

Field or Control	Description
Reporting Entity ID	Enter a unique identifier for spend history.
Reporting Entity Type	Select <i>Spend Analysis</i> .
Description	Enter a short description for the reporting entity.
Calendar SetID	Select the SetID for the calendar you wish to use to bucket expenditures.
Calendar ID	<p>Select a predefined calendar in which to bucket purchase order expenditures. This calendar will determine how purchase order commitments will be displayed by period.</p> <p>For example, if you selected a calendar where Period 1 was defined from 01/02/2005 to 01/29/2005 and Period 2 was from 01/30/2005 to 02/26/2005 and you created the following purchase orders:</p> <ol style="list-style-type: none"> 1. You have 2 purchase order schedules, one for 100.00 due 01/15/2005 and another for 200.00 due 1/30/2005. 2. When the graph for the Buyer Spend Total is generated, you would see 100.00 in Period 1 and 200.00 in Period 2. <p>See “Calendar Periods Page” (Application Fundamentals).</p>
Currency Code	Select a currency to which all purchase order spend information will be converted. This will be the currency that all buyers or managers assigned this reporting entity will view their total spend information.
Rate Type	Select the rate type used to convert the currency for purchase orders.
Unit Type	Displays the business unit type. You have <i>PO</i> and <i>AUC</i> as the options.

Field or Control	Description
Business Unit	<p>Select all the PeopleSoft Purchasing business units for which this reporting entity is responsible. When updating the spend history tables, the process selects all purchase orders assigned to the PeopleSoft Purchasing business units specified here.</p> <p>You should set up a reporting entity for all possible combinations of business units for which buyers are responsible. For example, if Buyer A and Buyer B both can purchase only for Purchasing Business Unit 1, you would need only one reporting entity. However, if Buyer A can purchase for Purchasing Business Unit 1 and 2 and Buyer B can purchase for Purchasing Business Unit 2 and 3, you would need two separate reporting entities.</p> <p>When defining a manager as a buyer, you should ensure the reporting entity specified on the manager's dashboard preferences is either the same as the buyers for which he or she is responsible or encompasses all the business units for the buyers. For example, if both Buyer A and Buyer B purchased for Purchasing Business Unit 1 and reported to Manager XYZ, you could use the same reporting entity when setting up Buyer A, Buyer B and Manager XYZ. However, if Buyer A purchases for Business Unit 1 and 2 and Buyer B purchases for Business Unit 2 and 3, you would need to set up a third reporting entity that included Business Units 1, 2 and 3 and assign that reporting entity to Manager XYZ. That way, Manager XYZ would be able to view all the business units for all the buyers for which he or she was responsible.</p>

Related Links

“Understanding the SRM Dashboard” (PeopleSoft Source to Settle Common Information)

Field Candidate Setup Page

Use the Field Candidate Setup page (PRCR_FLDCAN_TBL) to select fields that you want to be eligible for selection for an inquiry type.

Navigation:

Purchasing > Analyze Procurement > Setup Profiles > Field Candidate Setup

Field or Control	Description
Inquiry Type	<p>Displays the inquiry type that maps to the applicable view name below. Values include:</p> <ul style="list-style-type: none"> • <i>PO Schedule List</i> (PRCR_LST_APO_VW). • <i>Procurement History List</i> (PRCR_HST_AAA_VW). • <i>Receiver Schedule List</i> (PRCR_LST_ARC_VW). • <i>Requisition List</i> (PRCR_LST_ARQ_VW). • <i>Voucher List</i> (PRCR_LST_AAP_VW).
Field Heading	<p>Enter a user-defined field heading name that you use to identify the candidate field that you select in the Field Name field. When you define inquiry profile IDs, you define the field data that you want to retrieve by selecting from these field headings.</p>
Field Name	<p>Select the candidate field that you want to retrieve. The field must exist in the selected inquiry type view to be available for selection.</p>
Field Type	<p>Displays the field data type, such as numeric or character.</p>

View Candidate Setup Page

Use the View Candidate Setup page (PRCR_VIEW_CAN) to create views of procurement data to use in inquiry functions.

Navigation:

Purchasing > Analyze Procurement > Setup Profiles > View Candidate Setup

Field or Control	Description
View By	<p>Displays the user-defined name of the view.</p>
View ID	<p>Select the view used to create the View By.</p>

Field or Control	Description
Inquiry Type	<p>Select the inquiry type for which the view by value can be used. Types are:</p> <ul style="list-style-type: none"> • <i>History</i> • <i>PO List</i> • <i>Recv List</i> (receiver list) • <i>Req List</i> (requisition list) • <i>Vchr List</i> (voucher list)

Inquiry Profile Setup Page

Use the Inquiry Profile Setup page (PRCR_PRF_OPR) to define up to seven inquiry profiles per user ID to be used as filters for viewing either history files or current data in procurement tables (called lists).

Navigation:

Purchasing > Analyze Procurement > Setup Profiles > PO Analysis Profile Inquires

Field or Control	Description
User ID	Select the user ID that uses the inquiry profile.
Procurement Profile ID	<p>Select a profile ID. Seven profile IDs exist for each user ID:</p> <ul style="list-style-type: none"> • <i>PO History Items</i> • <i>PO Schedule List</i> • <i>Receiver History Items</i> • <i>Receiver Schedule List</i> • <i>Requisition List</i> • <i>Voucher History Items</i> • <i>Voucher List</i>
RPT Entity (reporting entity)	Select the data selection criteria that are defined for the selected reporting entity that apply to the inquiry profile.
Inquiry Type	Displays the inquiry type with which the inquiry profile is associated. The profile can be used only by this corresponding procurement analysis inquiry.

Field or Control	Description
View By	Select a view by which to display the inquiry. System-delivered views include By Supplier, By Ship To, or By Ship to by Supplier, but your organization can configure views and set them up by using the View Candidate Setup page.

Field Sequencing

Use the **Field Sequencing** group box to specify the inquiry fields and the sequence in which they appear. To change the sequence of the fields, use the arrows that are adjacent to the field heading.

You can override defaults that you configure here on the inquiry display pages.

Setup Procurement Users Page

Use the Set up Procurement Users page to assign users to a Reporting Entity and also specify the periods for which data should be displayed. Current period data is displayed in case no data is specified.

Navigation:

Purchasing > Analyze Procurement > Setup Procurement Operations > Setup Procurement Users

This example illustrates the fields and controls on the Setup Procurement Users. You can find definitions for the fields and controls later on this page.

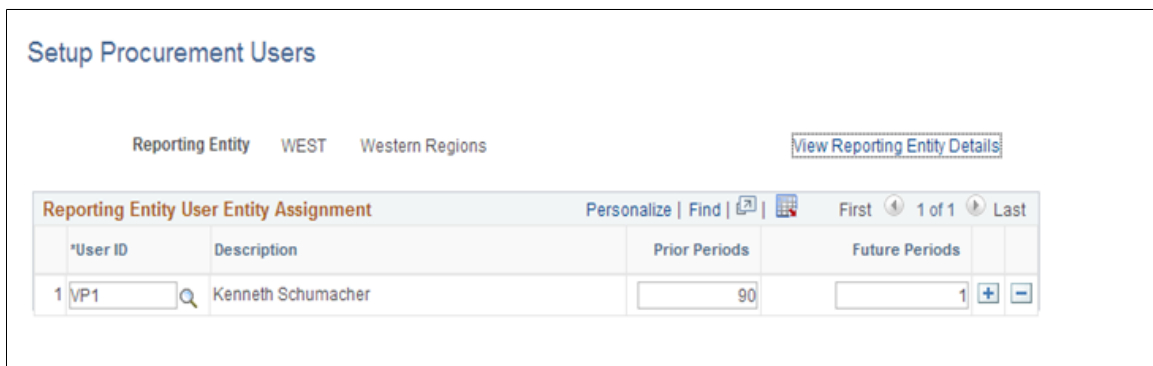

Field or Control	Description
User ID	A user assigned to the reporting entity, can only be associated with one reporting entity. The user's reporting entity is used in the Procurement Operations Home Page and select procurement pivot grids.
Prior Periods	Enter the number of periods before the start of the current period at which you want to begin displaying procurement spend accumulation in the Procurement Operations Home Page.

<i>Field or Control</i>	<i>Description</i>
Future Periods	Enter the number of periods after the start of the current period at which you want to end displaying procurement spend accumulation in the Procurement Operations Home Page.

Generating Procurement History

This section provides an overview of the Procurement History Update Application Engine process (FS_PRCRUPD) and discusses how to run the Procurement History Update process.

Page Used to Generate Procurement History

<i>Page Name</i>	<i>Definition Name</i>	<i>Usage</i>
<u>Update Procurement History Page</u>	RUN_CNTL_PRCR_UPD	Set up run-control information for the Procurement History Update process and run it. This process accumulates procurement history from the transaction tables.

Understanding the Procurement History Update Application Engine Process (FS_PRCRUPD)

This process populates the history tables. It selectively accumulates procurement history for the following transactions:

- Purchase order schedules
- Receipt lines
- Voucher lines
- Payments

Run this process as often as needed to refresh procurement history periods with current data. That might be once a day or once a week, depending on transaction volume.

The history that this process builds from these data sources can be viewed by using the online procurement history analysis pages. The views appear according to the inquiry profiles that you configure.

Update Procurement History Page

Use the Update Procurement History page (RUN_CNTL_PRCR_UPD) to set up run-control information for the Procurement History Update process and run it.

This process accumulates procurement history from the transaction tables.

Navigation:

Purchasing > Analyze Procurement > Update Procurement Info > Update Procurement History

<i>Field or Control</i>	<i>Description</i>
Reporting Entity ID	Select the reporting entity ID. The reporting entity determines the business units for which procurement history data is generated, as well as the kinds of data that is selected.
Relative	Select this option to run this process on a range of periods that are relative to the current period. The Start - Current Period Minus and End - Current Period Minus fields are available for entry when you select this option. This option is useful if you choose to schedule history updates. After you enter relative period information and save it here, the process runs with these parameters each time that the PeopleSoft Process Scheduler submits the process.
Start - Current Period Minus	Enter the number of periods before the start of the current period at which you want to begin procurement history accumulation.
End - Current Period Plus	Enter the number of periods after the start of the current period at which you want to end procurement history accumulation.
Specify	Select this option to define a specific period range for which you want to generate procurement history data. The Start Period, Start Year, End Period, and End Year fields become available for entry when you select this option. The number of periods or specific period and year entered here must exist on the calendar tied to the reporting entity specified on the run control. If you enter a period or year not associated with the calendar for the reporting entity, the system will reset the period and year to what is on the calendar associated with the reporting entity.

Related Links

[Define Procurement Controls Page](#)

Generating Spend History

This section provides an overview of the Spend History Application Engine process (PO_SPND_HIST) and discusses how to run the Spend History process.

Page Used to Generate Spend History

<i>Page Name</i>	<i>Definition Name</i>	<i>Usage</i>
<u>Update Spend History Page</u>	PO_SPEND_HIST_RC	Set up run-control information for the Spend History process and run it. This process generates spend history information for use by the Procurement Operations Home Page, several SRM Dashboard pagelets, and procurement spend pivot grids.

Understanding the Spend History Application Engine Process (PO_SPND_HIST)

Use this process to gather and bucket the dispatched purchase order spend information. This process will collect purchase order and contract amounts by month or period, summarized by a buyer within a period. When running the process you will specify a reporting entity ID, that defines a set of business units, calendar ID, currency code, and rate type. Only those purchase orders for the business units specified on the reporting entity will be included. The calendar ID is used to bucket the purchase order spend by period. The currency code and rate type are used to convert the purchase order's monetary amounts into a single currency when viewed by the buyer.

After you run the Spend History process you can view the results using several pagelets in the Supplier Relationship Management (SRM) Dashboard.

See “Understanding the SRM Dashboard” (PeopleSoft Source to Settle Common Information).

Update Spend History Page

Use the Update Spend History page (PO_SPEND_HIST_RC) to set up run-control information for the Spend History process and run it.

This process generates spend history information for use by several SRM Dashboard pagelets.

Navigation:

Purchasing, Analyze Procurement, Update Spend History

<i>Field or Control</i>	<i>Description</i>
Reporting Entity ID	Select the reporting entity ID. This reporting identity determines what currency and rate to convert purchase order amounts to and in which period to group purchase order spend.

Field or Control	Description
Relative	Select this option if you want to select a date range relative to the current period. Selecting relative enables you to set up the run control once and when it executes, it will always pick up the defined number of periods relative to the period in which it was run. If you want to include specific periods, clear this option and select the specify option instead.
Start - Cur Period Minus (start - current period minus)	Eight (8) appears by default. Enter the number of periods prior to the current period you want to generate spend history for.
End - Current Period Plus	Three (3) appears by default. Enter the number of periods ahead of the current period you want to generate spend history for.
Specify	Select this option if you want to specify a start and end period. When this option is selected for the run control, you must change the periods specified each time the process is run in subsequent periods.
Start Period and Start Year	Enter the start period and year you want to generate spend history for. The number of periods or specific period and year entered here must exist on the calendar tied to the reporting entity specified on the run control. If you enter a period or year not associated with the calendar for the reporting entity, the system will reset the period and year to what is on the calendar associated with the reporting entity.
End Period and End Year	Enter the end period and year you want to generate spend history for. The number of periods or specific period and year entered here must exist on the calendar tied to the reporting entity specified on the run control. If you enter a period or year not associated with the calendar for the reporting entity, the system will reset the period and year to what is on the calendar associated with the reporting entity.

Generating Procurement Statistics

PeopleSoft Purchasing also provides you with the ability to view requisition, purchase order, and receipt statistics using the Procurement Statistics inquiry page. You will need to run the Procurement Statistics Application Engine process (PRCR_TXN_HIST) before you can view the purchasing statistics and transaction summaries.

This section provides an overview of the Procurement Statistics process and discusses how to run the Procurement Statistics process.

Page Used to Generate Procurement Statistics

<i>Page Name</i>	<i>Definition Name</i>	<i>Usage</i>
<u>Update Procurement Statistics Page</u>	PRCR_TXN_HIST_RC	Set up run-control information for the Procurement Statistics process and run it. This process generates statistics for requisitions, purchase orders, and receipts.

Understanding the Procurement Statistics Process

Use this process to generate requisition, purchase order, and receipt statistics. This process will collect various counts of all requisitions and purchase orders, as well as receipt transactions that fall within the date range you specify on the run control request.

For requisitions, the requisition date (REQ_HDR.ENTERED_DT) is used to determine the documents that are included when calculating the statistics. Those requisitions whose entered date fall within the date range specified on the run control are included. Once the requisitions have been gathered, they are sorted by the period in which they fall. Once sorted, the number of requisitions, lines, and high and low amounts per period can be determined.

For purchase orders, the same process is used as that for requisitions except the purchase order date (PO_HDR.PO_DT) is used.

For receipts, the same process is used as that for requisitions except the receipt date (RECEIPT_DT) is used. The RECEIPT_DT on the RECV_HDR is used to group the receivers into periods based on the calendar associated with the reporting entity specified on the run control request.

Update Procurement Statistics Page

Use the Update Procurement Statistics page (PRCR_TXN_HIST_RC) to set up run-control information for the Procurement Statistics process and run it.

This process generates statistics for requisitions, purchase orders, and receipts.

Navigation:

Purchasing, Analyze Procurement, Update Procurement Statistics

Field or Control	Description
Reporting Entity ID	<p>Select the reporting entity ID. This reporting identity determines:</p> <ul style="list-style-type: none"> • The business units, purchase orders, requisitions, and receipt records to include in the statistical calculations. • The currency to convert monetary amounts to. • The periods to group purchase orders, requisitions, and receipt information.
Relative	Select this option if you want to select a date range relative to the current period. Selecting relative allows you to set up the run control once and when it executes, it will always pick up the defined number of periods relative to the period in which it was run. If you want to include specific periods, clear this option and select the specify option.
Start - Cur Period Minus (start - current period minus)	Eight (8) appears by default. Enter the number of periods prior to the current period you want to summarize transactions for.
End - Current Period Plus	Three (3) appears by default. Enter the number of periods ahead of the current period you want to summarize transactions for.
Specify	Select this option if you want to specify a start and end period. When this option is selected for the run control, you must change the periods specified each time the process is run in subsequent periods
Start Period and Start Year	<p>Enter the start period and year you want to summarize transactions for.</p> <p>The number of periods or specific period and year entered here must exist on the calendar tied to the reporting entity specified on the run control. If you enter a period or year not associated with the calendar for the reporting entity, the system will reset the period and year to what is on the calendar associated with the reporting entity.</p>
End Period and End Year	<p>Enter the end period and year you want to summarize transactions for.</p> <p>The number of periods or specific period and year entered here must exist on the calendar tied to the reporting entity specified on the run control. If you enter a period or year not associated with the calendar for the reporting entity, the system will reset the period and year to what is on the calendar associated with the reporting entity.</p>

Reviewing Supplier Performance

This section discusses how to review supplier performance.

Page Used to Review Supplier Performance

Page Name	Definition Name	Usage
View Supplier Shipment Performance Page	WV_PE_METRIC_DTL	Review on-time performance, purchase order receipt quantity performance, quality performance, and quantity performance for a supplier.

View Supplier Shipment Performance Page

Use the View Supplier Shipment Performance page (WV_PE_METRIC_DTL) to review on-time performance, purchase order receipt quantity performance, quality performance, and quantity performance for a supplier.

Navigation:

Purchasing, Analyzing Procurement, Review Supplier Performance

This example illustrates the fields and controls on the View Supplier Shipment Performance (On-Time Performance) page (1 of 2). You can find definitions for the fields and controls later on this page.

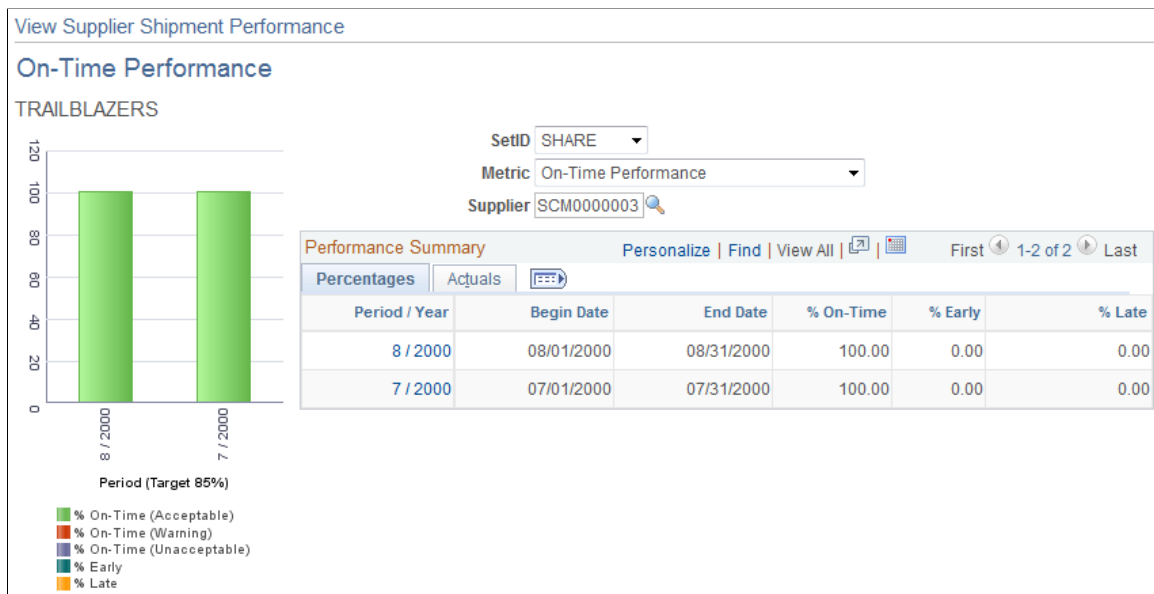

This example illustrates the fields and controls on the View Supplier Shipment Performance (On-Time Performance) page (2 of 2). You can find definitions for the fields and controls later on this page.

Detail Information for Period: 8 - 08/01/2000 thru 08/31/2000

From Percentage To Percentage

Category Ship To

Performance Detail Personalize | Find | View All | |

First 1-12 of 12 Last

Item ID	Description	% On-Time	% Early	% Late
10002	Long Sleeve T-Shirt, Mens	100.00	0.00	0.00
10003	Long Sleeve Biking Jersey, Women's	100.00	0.00	0.00
10004	Long Sleeve T-Shirt, Womens	100.00	0.00	0.00
10005	Switchback Mountain Biking Shorts, Men's	100.00	0.00	0.00
10014	Cadence Kit	100.00	0.00	0.00
10015	AT9090 Altimeter	100.00	0.00	0.00
10016	TC8799 Cyclometer	100.00	0.00	0.00
10017	Wireless Cycle Computer	100.00	0.00	0.00
10020	Hand Pump, Frame Attachment	100.00	0.00	0.00
10021	Dual Pump, Tire or Floor	100.00	0.00	0.00
10022	CycleBest Combination Padlock	100.00	0.00	0.00
LT5003	Wheel Tire, 700x25	100.00	0.00	0.00

[Send Email](#)

This page displays different information depending on the metric that you select in the **Metric** field.

Field or Control	Description
Metric	<p>Select the type of metric you want to review for the supplier. Metrics are:</p> <ul style="list-style-type: none"> • <i>On-Time Performance</i> • <i>PO/Receipt Qty Performance</i> (purchase order/receipt quantity performance) • <i>Quality Performance</i> • <i>Quantity Performance</i>

On-Time Performance

Displays the percentage and actual number of shipments that are on time, early, and late for all items within the period. The page features a graph that displays the percentage on time metric, supplier name, and target percentages by period.

Click the **Period/Year** link in the Performance Summary group box to view the details used to derive this graph. When you click this link the Detail Information for Period group box appears at the bottom of the page.

PO/Receipt Quantity Performance

Displays the percentage and actual number of purchase order receipts within the period. The page features a purchase order-versus-receipt quantity performance graph that displays the percentage open receipt quantity metric, supplier name, and target percentage by period.

Click the **Period/Year** link in the Performance Summary group box to view the details used to derive this graph. When you click this link the Detail Information for Period group box appears at the bottom of the page.

Quality Performance

Displays the percentage and actual number of supplier shipment quantities inspected, accepted, rejected, and returned by period. The page features a quality performance graph that displays the percentage net received metric, supplier name, and target percentage.

Click the **Period/Year** link in the Performance Summary group box to view the details used to derive this graph. When you click this link the Detail Information for Period group box appears at the bottom of the page.

Quantity Performance

Displays the percentage and actual number of supplier shipments with correct quantities, over-shipment quantities, and under-shipment quantities by period. The page features a graph that displays the supplier name, percentage correct, percentage under, percentage over, and target percentage.

Click the **Period/Year** link in the Performance Summary group box to view the details used to derive this graph. When you click this link the Detail Information for Period group box appears at the bottom of the page.

Viewing Procurement Analysis Data

This section provides an overview of the procurement history inquiries

Pages Used to View Procurement Analysis Data

<i>Page Name</i>	<i>Definition Name</i>	<i>Usage</i>
<u>Purchase Order List Page</u>	PRCR_PO_LIST	View data in the current purchase order tables.

Page Name	Definition Name	Usage
PO Inquiry selection criteria Page	PRCR_PO_SELECT	Retrieve data to the inquiry page. The data that is retrieved is based on the selection criteria that you define in the inquiry profile for the user ID. Any defaults that you establish there appear on the inquiry page. You can override these defaults and define additional selection criteria on this page. <u>Purchase Order List Page</u>
<u>Receipt List Page</u>	PRCR_RC_LIST	View data in the current receipt tables.
Receipt Inquiry selection criteria Page	PRCR_RC_SELECT	Retrieve data to the inquiry page. The data that is retrieved is based on the selection criteria that you define in the inquiry profile for the user ID. Any defaults that you establish there appear on the inquiry page. You can override these defaults and define additional selection criteria on this page. <u>Receipt List Page</u>
<u>Voucher List Page</u>	PRCR_VC_LIST	View data in the current voucher tables.
Voucher Inquiry selection criteria Page	PRCR_VC_SELECT	Retrieve data to the inquiry page. The data that is retrieved is based on the selection criteria that you define in the inquiry profile for the user ID. Any defaults that you establish there appear on the inquiry page. You can override these defaults and define additional selection criteria on this page. <u>Voucher List Page</u>
Requisition List Page	PRCR_REQ_LIST	View data in the current requisition tables.
Requisition Inquiry selection criteria Page	PRCR_REQ_SELECT	Retrieve data to the inquiry page. The data that is retrieved is based on the selection criteria that you define in the inquiry profile for the user ID. Any defaults that you establish there appear on the inquiry page. You can override these defaults and define additional selection criteria on this page.
PO History Inquiry Page	PRCR_HST_INQ	View purchase order data in the procurement history table.

Page Name	Definition Name	Usage
History selection criteria Page	PRCR_HST_SELECT	Retrieve data to the inquiry page. The data retrieved is based on the selection criteria that you define in the inquiry profile for the user ID. Any defaults that you establish there appear on the inquiry page. You can override these defaults and define additional selection criteria on this page.
Receipt History Inquiry Page	PRCR_HST_INQ	View receipt data in the procurement history table.
Voucher History Inquiry Page	PRCR_HST_INQ	View voucher data in the procurement history table.
Supplier Information - Identifying Information Page	VND_ID1	Enter supplier identifying information.
Conversations Page	VND_CNVRSTN	Track ongoing discussions and conversations with supplier contacts. You must enter the supplier and contact before you record conversations.
Purchasing Attributes Page	ITM_TBL_PUR	Enter basic purchasing information for an item.

Understanding Procurement History Inquiries

Use the procurement history inquiry pages to view accumulated and summarized procurement history data. There are seven inquiries available. They are:

- Purchase order history inquiry.
- Receipt history inquiry.
- Voucher history inquiry.
- Purchase order list.
- Receipt list.
- Voucher list.
- Requisition list.

The data that appears in these inquiries varies depending on the user ID and the configuration of the associated inquiry profile IDs.

Common Elements Used in Procurement History Inquiries

Field or Control	Description
%CAN (percent canceled)	Percentage of the order that is canceled.
%RCV (percent received)	Percentage of the order that is received.
%REJ (percent rejected)	Percentage of the order that is rejected.
%RTN (percent returned)	Percentage of the order that is returned.
Amt Ordered (amount ordered)	Amount that is listed on the purchase order.
Bank Code	Code that is assigned to the bank from which the item invoice is to be paid.
CUR/Currency	Purchase order transaction currency.
Days Vary	Number of days by which the item may arrive early or late without being rejected and returned.
Early Ship	Number of days by which an item may arrive early without being rejected.
Gross Paid	Gross amount that is paid, not taking into account any discounts or adjustments.
Inquiry Results	<p>Displays field values according to criteria that is defined for the user ID and associated inquiry profile IDs. These values are chosen to produce procurement analysis inquiries that are relevant to the user ID.</p> <p>Inquiries initially retrieve only fields that are predefined. However, you can use the selection criteria page for each inquiry to alter the current view by selecting new search parameters to retrieve exactly the amount and type of information for which you are looking.</p>
LT MAD (lead time mean absolute deviation)	Lead-time mean absolute deviation.
Late Ship	Number of days by which an item may arrive late without being rejected.
Num Receipts (number of receipts)	Number of receipts that are generated for the item.

Field or Control	Description
Over Ship (over shipped)	Number of items by which the order may be overshipped without being rejected.
PO Count	Number of purchase orders that are associated with the receipt line.
Paid Amount	Amount that is paid on the purchase order, less any discounts or adjustments.
Pay Currency (payment currency)	Payment currency.
Receipt WT (receipt weight)	Weight of items that are received.
Receiver	Receipt ID.
Unit PO (Purchasing unit)	Purchasing business unit.
Under Ships	Number of items by which the order may be undershipped without being rejected.
UOM WT (unit of measure weight)	Unit of measure for the weight of the item.
Supplier Cat ID (supplier catalog ID)	Supplier catalog ID.

Purchase Order List Page

Use the Purchase Order List page (PRCR_PO_LIST) to view data in the current purchase order tables.

Navigation:

Purchasing > Analyze Procurement > Review Procurement Information > Purchase Order Lists > Purchase Order List

Field or Control	Description
Amount	Total line cost.
PO Date	Purchase order creation date.
Price	Purchase order item unit cost.
Status	Purchase order status.

<i>Field or Control</i>	<i>Description</i>
VND Item (supplier item)	Supplier item code.

Receipt List Page

Use the Receipt List page (PRCR_RC_LIST) to view data in the current receipt tables.

Navigation:

Purchasing > Analyze Procurement > Review Procurement Information > Analyze Receipt Information > Receipt List

<i>Field or Control</i>	<i>Description</i>
Origin	Source of the receipt.
PO Price	Purchase order item unit price.
PO Ship Amt (purchase order shipped amount)	Cost of the purchase order items that are shipped.
PO Ship Qty (purchase order shipped quantity)	Number of purchase order items shipped.
Status	Purchase order status.
Unit	Receiving business unit.

Voucher List Page

Use the Voucher List page (PRCR_VC_LIST) to view data in the current voucher tables.

Navigation:

Purchasing > Analyze Procurement > Review Procurement Information > Voucher Lists > Voucher List

<i>Field or Control</i>	<i>Description</i>
Amount	Total line cost.
Inv Date (invoice date)	Invoice issue date.
Recv Ship (receiving ship to)	Ship to location where the items are received.

Requisition Inquiry selection criteria Page

Use the Requisition Inquiry selection criteria page (PRCR_REQ_SELECT) to retrieve data to the inquiry page.

The data that is retrieved is based on the selection criteria that you define in the inquiry profile for the user ID. Any defaults that you establish there appear on the inquiry page. You can override these defaults and define additional selection criteria on this page.

Navigation:

Click the **Select** button on the Requisition List inquiry page.

Field or Control	Description
Business Unit	Business unit that generates the requisition.
Merchandise Amt (merchandise amount)	Cost of the total number of the items requested.
Name 1	Item supplier full business name.
Order Line	Order Management order line number for direct shipments.
Order Management BU (order management business unit)	Order Management business unit for direct shipment orders.
Order No (order number)	Order Management order number.
Requisition Date	Requisition creation date.
Requisition Price	Unit price of the requisition item.
Ship Via Code	Code for the shipping method designated for the item.
ShipTo SetID	SetID to which the item is to be shipped.
Status	Requisition status.

Viewing Procurement Statistics

This section discusses how to view procurement statistics.

Page Used to View Procurement Statistics

<i>Page Name</i>	<i>Definition Name</i>	<i>Usage</i>
Procurement Statistics inquiry Page	PRCR_TXN_HISTORY	View requisition, purchase order, and receipt statistical information.

Procurement Statistics inquiry Page

Use the Procurement Statistics inquiry page (PRCR_TXN_HISTORY) to view requisition, purchase order, and receipt statistical information.

Navigation:

Purchasing, Analyze Procurement, Review Procurement Information, Procurement Statistics

This example illustrates the fields and controls on the Procurement Statistics inquiry page. You can find definitions for the fields and controls later on this page.

Procurement Statistics

*Document Type

*Reporting Entity ID

Currency Code EUR

Business Unit From Business Unit To

From Period/Year To Period/Year

Purchase Order Transactions								Personalize Find First 1-18 of 18 Last
Business Unit	Period/Year	# of Purchase Orders	Average # of PO Lines	Max # of PO Lines	High Monetary Amount	Low Monetary Amount	# of Change Orders	
AUS01	P3-2006	1	0	0	0.00	0.00	0	
AUS01	P4-2006	2	1	1	2,491.70	359.92	0	
FRA01	P3-2006	7	1	2	64,573.72	543.92	0	
FRA01	P4-2006	15	3	5	1,599,869.28	0.00	2	
GBR01	P3-2006	3	1	2	2,215.33	830.75	0	
GBR01	P4-2006	16	4	13	62,716.54	0.00	1	
US001	P3-2006	11	2	3	3,945.30	115.36	0	
US001	P4-2006	48	3	10	30,736.03	0.00	12	

Note: You must run the Procurement Statistics process (PRCR_TXN_HIST) before data will appear on this inquiry page.

See [Generating Procurement Statistics](#).

Search Criteria

<i>Field or Control</i>	<i>Description</i>
Document Type	<p>Select the type of information you want to view. Document types are:</p> <ul style="list-style-type: none"> • <i>Purchase Order</i> • <i>Receipt</i> • <i>Requisition</i> <p>Depending on the document type you select, the grid in the lower portion of the page will display differently.</p>
Reporting Entity ID	<p>Select the reporting entity. Only reporting entities IDs that are associated with a <i>Spend Analysis</i> reporting entity type will appear for selection. The reporting entity ID specified here should correspond to the one entered on the run control request. The reporting entity determines which business units purchase orders are included in the statistical calculations.</p>
Business Unit From and Business Unit To	<p>Select the range of business units whose information you wish to view. If no business unit is specified here, the information for all business units will be displayed.</p>
From/Period Year and To/Period Year	<p>Select the date range you want to view the transactions summary for. The period range specified on the Update Procurement Statistics run control determines the periods and years available for selection.</p>

Purchase Order Transactions

<i>Field or Control</i>	<i>Description</i>
Average # of PO Lines (average number of purchase order lines)	<p>Displays the average number of purchase order lines for the period. For each business unit, all the purchase order lines associated with the purchase orders in the period are counted. That number is then divided by the total number of purchase orders in the period to give you the average number of purchase order lines.</p>
Max # of PO Lines (maximum number of purchase order lines)	<p>Displays the maximum number of purchase order lines for the period. For the time period, this is the most number of purchase order lines contained on one purchase order.</p>

Field or Control	Description
High Monetary Amount	Displays the highest monetary amount of one purchase order for the period. Each purchase order is converted into the currency specified on the reporting entity ID, using the rate indicated. The highest amount associated with one purchase order displays.
Low Monetary Amount	Displays the lowest monetary amount of one purchase order for the period. Each purchase order is converted into the currency specified on the reporting entity ID, using the rate indicated. The lowest amount associated with one purchase order displays.

Receipt Transactions

Field or Control	Description
Average # of Receipt Lines (average number of receipt lines)	Displays the average number of receipt lines for the period. For each business unit, all the receipts lines for a receipt in the period are counted. That number is then divided by the total number of receipts in the period to give you the average number of receipt lines.
Max # of Receipt Lines (maximum number of receipt lines)	Displays the maximum number of receipt lines for the period. For the time period, this is the most number of receipt lines contained on one receipt.
# of Receipts from Receive Loader (number of receipts from receive loader)	Displays the number of receipts processed through the Receive Load process for the period.

Requisition Transactions

Field or Control	Description
Average # of Req Lines (average number of requisition lines)	Displays the average number of requisition lines for the period. For each business unit, all the requisition lines associated with the requisitions in the period are counted. That number is then divided by the total number of requisitions in the period to give you the average number of requisition lines.
Max # of Req Lines (maximum number or requisition lines)	Displays the maximum number of requisition lines for the period. For the time period, this is the most number of requisition lines contained on one requisition.

Field or Control	Description
High Monetary Amount	Displays the highest monetary amount of one requisition for the period. Each requisition is converted into the currency specified on the reporting entity ID, using the rate indicated. The highest amount associated with one requisition displays.
Low Monetary Amount	Displays the lowest monetary amount of one requisition for the period. Each requisition is converted into the currency specified on the reporting entity ID, using the rate indicated. The lowest amount associated with one requisition displays.
# of Reqs From Req Loader (number of requisitions from requisition loader)	Displays the number of requisitions processed through the Purchasing Requisition Loader process for the period. Any requisition that contains a system source of BCP (configurator product batch), BIN (inventory batch), BOM (order management batch), BPO (purchase order batch), POU (point of use), PPC (project costing or line entry page), and WM (Maintenance Management) is counted and considered processed through the requisition loader.

Related Links

[Understanding the Requisition Business Process](#)

[Understanding the Purchase Order Business Process](#)

[Understanding the Receiving Business Process](#)

[Understanding the Purchasing Requisition Loader Application Engine Process \(PO_REQLOAD\)](#)

Setting Up and Using PeopleSoft Fluid User Interface for Financials and Supply Chain Management

PeopleSoft Fluid User Interface is an alternative user interface to the PeopleSoft Classic User Interface. PeopleSoft Fluid pages are designed for used on all types of devices such as a desktop or a laptop, a tablet, and a smart phone. When accessing a PeopleSoft fluid page, the system detects the device you're using and renders the appropriate page.

PeopleTools documentation regarding the PeopleSoft Fluid User Interface includes:

- *PeopleTools: Fluid User Interface Developer's Guide.*
- *PeopleTools: Applications User's Guide, Working With PeopleSoft Fluid User Interface.*





Click to watch a short video about [PeopleSoft Fluid User Interface - Getting Started](#).

Click to watch a short video about [PeopleSoft Procurement Operations On the Go: Monitoring Supplier Performance](#).

Note: The pages and tiles in this topic were designed using PeopleSoft Fluid User Interface technology. They can be accessed from a tablet, smart phone or laptop with touch-screen capability, or from the PeopleSoft Classic platform. See *PeopleTools: Fluid User Interface Developer's Guide* for more information. A PeopleSoft Fluid User Interface home page appears when you log into the system. From this home page you can view notifications, access applications, and navigate the PeopleSoft system by tapping on individual tiles. The banner at the top of the home page acts like a button. Select the title to access another home page, if you have access to multiple home pages. The tiles that appear on a home page display notification information, such as the last pay date. A tile can also be a button that accesses an application page where you can complete a business transaction.

Common Elements Used with PeopleSoft Fluid User Interface

The banner appears at the top of every page and includes the page title and these standard buttons:

Field or Control	Description
 (Actions List)	Select to see a list of available actions for the current window. Access pages to personalize window content or sign out.
 (Home)	Select to return to the main PeopleSoft Home page.
 (NavBar)	Select to expand the NavBar window, where you can select window content from options, such as Recent Places, My Favorites, Navigator, My Preferences, and Fluid Home. Select again to collapse the NavBar window.
 (Notifications)	Select to view actions and alerts in a notifications window.
 (Personalize NavBar)	Select to access the personalization window, where you can add and remove selected tiles from the NavBar.

Understanding PeopleSoft Fluid User Interface with Procurement Operations Pages

Procurement Operations Home Page allows you to monitor key events in Procurement while “on-the-go” on your Smartphone or Tablet. The Fluid User Interface allows you to monitor-by-exception; such events as approvals not performed with a stated timeframe, suppliers who are not performing to service level agreements, and while in meetings, allow you to quickly answer questions about Procurement spend. You can also configure your Landing Page to only select those Items, Item Categories, Business Units, Buyers, Ship To and Suppliers you wish to monitor. Setting best practice thresholds for events, allow you to see where there are violations in order to take action. As long as you have access to your areas of interest, you can be effective and proactive and address issues before they affect other areas of the organization.

Pages Used to Set Up the PeopleSoft Fluid User Interface for Procurement Operations

<i>Page Name</i>	<i>Definition Name</i>	<i>Usage</i>
<u>Define Procurement Controls Page</u>	PRCR_ENTITY_TBL	Set up reporting entities, which function as high-level groupings for your inquires and page.
<u>Update Spend History Page</u>	PO_SPEND_HIST_RC	Set up run-control information for the Spend History process and run it.
<u>Setup Procurement Users Page</u>	OPR_DEF_RPT_TBL	Assign Report Entity to user and also specify the periods for which data should be displayed. Note: A user must be assigned to a single Reporting Entity before using the Procurement Operations Home Page
<u>Supplier Watch List Event Page</u>	PO_EVENT_SWL	Enable the events that are to be monitored in the Supplier Watch List.
<u>Define Event Threshold Page</u>	PO_EVT_THRESH	Define event thresholds by reporting entity. Users assigned to the reporting entity will use these thresholds for selected events.
<u>Procurement User Preferences – Contract Expiration Page</u>	PO_PREF_EXPC_FL	Personalize and configure selection criteria for Expiring Contracts.
<u>Procurement User Preferences – PO Approval Cycle Time Page</u>	PO_PREF_POACT_FL	Personalize and configure selection criteria for Purchase Orders that are Pending Approval.
<u>Procurement User Preferences – Req Approval Cycle Time Page</u>	PO_PREF_RQACT_FL	Personalize and configure selection criteria for Requisitions that are Pending Approval.
<u>Procurement User Preferences – Req to PO Cycle Time Page</u>	PO_PREF_R2PCT_FL	Personalize and configure selection criteria for Requisitions that have open amounts.
<u>Procurement User Preferences – Procurement Spend Analysis Page</u>	PO_PREF_PSA_FL	Personalize and configure selection criteria for Procurement Spend Pivot grid.
<u>Procurement User Preferences – Supplier Watch List Page</u>	PO_PREF_SWL_FL	Personalize and configure list of Suppliers and thresholds for Supplier Watch List.

Page Name	Definition Name	Usage
Working with the Procurement Operations Home Page		Personalize and configure tiles to appear on Procurement Operations Home Page.

Configuring Thresholds and Events for Procurement Operations

This section provides an overview of the Supplier Watch List Event Page (PO_EVENT_SWL).

Page Used to Supplier Watch List Event Page

Page Name	Definition Name	Usage
Supplier Watch List Event Page	PO_EVENT_SWL	Select the events you want to monitor in the Supplier Watch List Page.

Supplier Watch List Event Page

Use the Supplier Watch List Event to select the events you want to monitor in the Supplier Watch List.

Navigation:

Purchasing > Analyze Procurement > Setup Procurement Operations > Select Watch List Event

This example illustrates the fields and controls on the Supplier Watch List Event page. You can find definitions for the fields and controls later on this page.

Select Watch List Event

Reporting Entity: WEST Western Regions [View Reporting Entity Details](#)

Purchasing Events	Contract Events	Sourcing Events
<ul style="list-style-type: none"> <input checked="" type="checkbox"/> Req to PO Cycle Time Overdue <input checked="" type="checkbox"/> PO Approval Cycle Time Overdue <input checked="" type="checkbox"/> PO Dispatch Cycle Time Overdue <input checked="" type="checkbox"/> Total Period to Date PO Spend <input checked="" type="checkbox"/> Number of POs Period to Date <input checked="" type="checkbox"/> POs Backordered Overdue <input checked="" type="checkbox"/> Volume of EDI POs <input checked="" type="checkbox"/> Non EDI POs Over Amount 	<ul style="list-style-type: none"> <input checked="" type="checkbox"/> Number of Contracts <input checked="" type="checkbox"/> Contracts Due to Expire Soon <input checked="" type="checkbox"/> Contract Spend on PO <input checked="" type="checkbox"/> Non Contract Spend Over Amount 	<ul style="list-style-type: none"> <input checked="" type="checkbox"/> Number of Bidder Invitations <input checked="" type="checkbox"/> Participant Percentage <input checked="" type="checkbox"/> Award Percentage

Define Event Threshold Page

This section provides an overview of the Define Event Threshold Page (PO_EVT_THRESH).

Page Used to Define Event Threshold Page

Page Name	Definition Name	Usage
<u>Define Event Threshold Page</u>	PO_EVENT_THRESH	Define system level thresholds.

Define Event Threshold Page

Use the Define Event Threshold page to define system level thresholds. A violation will appear for each Event on the Supplier Watch List when the transaction amount calculated or number of days pending exceeds the threshold established for the reporting entity.

Navigation:

Purchasing > Analyze Procurement > Setup Procurement Operations > Define Event Threshold

This example illustrates the fields and controls on the Define Event Threshold Page. You can find definitions for the fields and controls later on this page.

Define Event Thresholds

Reporting Entity: WEST Western Regions [View Reporting Entity Details](#) [Copy From Reporting Entity](#)

Event Threshold Details							Personalize Find First 1-7 of 7 Last
Event Type	Title Event Name	Threshold Days	Threshold Amount	Currency Code	Threshold Type	Title Event Appears On	
1 Purchasing	Req Approval Cycle Time	<input type="text"/>			Days Pending	Req Approval Cycle Time	
2 Purchasing	Requisition to PO Cycle Time	<input type="text"/>			Days Pending	Req to PO Cycle Time , Supplier Watch List	
3 Purchasing	PO Approval Cycle Time	<input type="text"/>			Days Pending	PO Approval Cycle Time , Supplier Watch List	
4 Purchasing	PO Dispatch Cycle Time	<input type="text"/>			Days Pending	Supplier Watch List	
5 Purchasing	PO Backorder Volume	<input type="text"/>			Days Pending	Supplier Watch List	
6 Purchasing	Non EDI PO Volume		<input type="text"/>	USD	Maximum Amount	Supplier Watch List	
7 Contracts	Non Contract Spend on PO		<input type="text"/>	USD	Maximum Amount	Supplier Watch List	

Field or Control	Description
View Reporting Entity Details	Displays information about the Reporting Entity, including the Business Units assigned.
Copy From Reporting Entity	This link will only be available when initially setting up the thresholds for the Reporting Entity. Use the link to copy the threshold values from another Reporting Entity to the current one.

Event Threshold Details

<i>Field or Control</i>	<i>Description</i>
Threshold Days	<p>Indicates the minimum number of days that pending transactions should be included in the spend analysis for the Tile. In other words, transactions have to be pending for at least the specified number of days to be included.</p> <p>For example, with the 'PO Approval Cycle Time' event, a PO is only included if it has been in 'Pending' status for the number of days specified here or longer.</p>
Threshold Amount	If the amount calculated for an event exceeds the threshold amount entered here, then it is marked as a violation in the Supplier Watch List.
Currency Code	Displays the currency of the Reporting Entity.
Tile Event Appears On	Displays the Tiles that are relevant to the Event.

Setting Up Your Procurement Operations Using PeopleSoft Fluid Pages

Thresholds can be defined by Reporting Entity and applies to all users assigned to the Reporting Entity. You can establish tighter thresholds using My User Preference for the selected events. The system will identify and display when a transaction exceeds the event threshold established at the reporting entity or at the My User Preference.

This table illustrates events used in the Procurement Operations Home Page.

<i>Event</i>	<i>Description</i>
Req to PO Cycle Time Overdue	Approved Requisitions with open amount past x days.
Req Approval Cycle Time Overdue	Requisitions pending approval past x days.
PO Approval Cycle Time Overdue	Purchase Orders pending approval past x days.
PO Dispatch Cycle Time Overdue	Approved POs not dispatched past x days.
Total Period to Date PO Spend	Dispatched Purchase Order amount.

Event	Description
Number of POs Period to Date	Dispatched Purchase Order count.
Pos Backordered Overdue	Dispatched Purchase Order amount not received past due date by x days.
Volume of EDI POs	Amount for Purchase Orders dispatched using EDI.
Non EDI POs Over Amount	Amount for Purchase Orders dispatched not using EDI.
Number of Contracts	Contract count.
Contracts Due to Expire Soon	Contracts due to expire within x days.
Contract Spend on PO	Amount for dispatched Purchase Orders using Contract.
Non Contract Spend Over Amount	Amount for dispatched Purchase Orders not using Contract over x amount.
Number of Bidder Invitations	Count of Bidders specifically requested to participate in the Sourcing Event.
Participant Percentage	Participation percentage of the Bidders.
Award Percentage	Award percentage of the Bidder for the event they participated.

Note: Req Approval Cycle Time and PO Approval Cycle Time events use approval workflow records to calculate cycle time. Approval Workflow must be turned on for the Business Unit to calculate approval cycle time.

These are the steps to setup Procurement Operations Home Page:

1. Use the Define Procurement Controls page to define Reporting Entities that will group your procurement spend activity based on the selected business units. Identify calendar to represent your reporting periods and a reporting currency code you want to view amounts in. Data is staged only for stated business units for this Report Entity. See [Configuring Procurement Analysis Inquiries](#)
2. Execute Update Spend History batch process to stage procurement data for this Report Entity. Assign the time periods that data needs to be staged for. See [Generating Spend History](#)
3. Use the Set up Procurement Users page to assign users to a Reporting Entity and also specify the periods for which data should be displayed. Current period data are displayed in case no data is specified. See [Configuring Procurement Analysis Inquiries](#)
4. Use the Supplier Watch List Event age to select the events you want to monitor in the Supplier Watch List. See [Configuring Thresholds and Events for Procurement Operations](#)

5. Use the Define Event Threshold page to define system level thresholds. A violation will appear for each Tile Event Name on the Supplier Watch List when the transaction amount calculated or number of days pending exceeds the threshold established for the reporting entity. See [Configuring Thresholds and Events for Procurement Operations](#)
6. My Preferences helps user to setup, which events to display in Supplier Watch List and also setup any warning days or amounts on top of admin setup.

Procurement User Preferences

Use the My Preferences tile to access the Procurement User Preferences for the Procurement Operations tiles.

You can access the My Preference tile directly through the action menu of some of the Procurement Operations tiles. In addition, you can access My Preferences from one of the Fluid Homepages or from the NavBar, if configured.

Common Elements Used in Procurement User Preferences

<i>Field or Control</i>	<i>Description</i>
Define Filters	Select to limit selection criteria for spend analysis to specified Business Units, Suppliers, Items or Categories, Ship To Locations, and Buyers.

Business Unit Selection

<i>Field or Control</i>	<i>Description</i>
All	Select to access all business units. You can only view data for the business units that you have access to.
Specific	Select to enter one or more business units. You can only select the business units you have access to.

Item / Category Selection

<i>Field or Control</i>	<i>Description</i>
All	Select to access all items and categories

<i>Field or Control</i>	<i>Description</i>
Item	Select to enter one or more items.
Category	Select to enter one or more categories.

Supplier Selection

<i>Field or Control</i>	<i>Description</i>
All	Select to access all suppliers.
Specific	Select to enter one or more suppliers.

Ship To Selection

<i>Field or Control</i>	<i>Description</i>
All	Select to access all ship to locations.
Specific	Select to enter one or more ship to locations.

Buyer Selection

<i>Field or Control</i>	<i>Description</i>
All	Select to access all buyers.
Specific	Select to enter one or more buyers.

Note: You must set the filter option to limit your existing search results to rows that meet your criteria. By setting the filters you can reduce the original search results to a smaller number of rows so that you can focus on your area of interest.

Procurement User Preferences – Contract Expiration Page

Use the Procurement User Preferences - Expiring Contracts Page to personalize and configure selection criteria for Contracts.

Navigation:

Fluid Home > Employee Self Service > My Preferences > Contract Expiration

This example illustrates the fields and controls on the Procurement User Preferences – Contract Expiration Page. You can find definitions for the fields and controls later on this page.

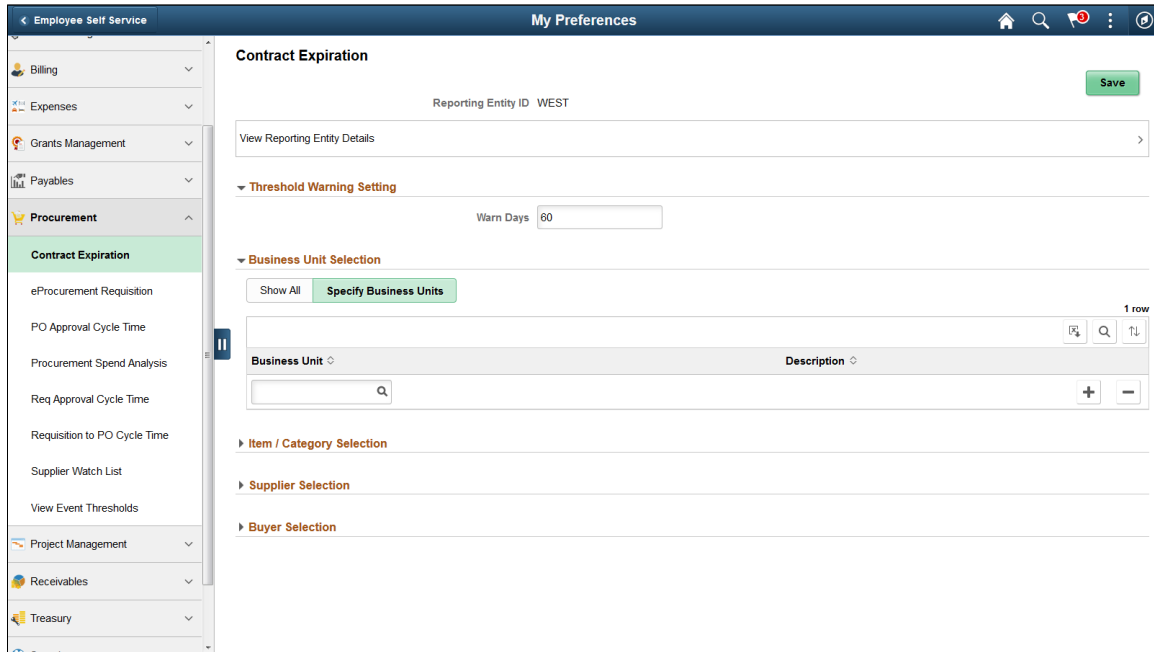

Threshold Warning Setting

<i>Field or Control</i>	<i>Description</i>
Warn	Enter the number of days to be warned in advance of expiring contracts.

Data Selection

<i>Field or Control</i>	<i>Description</i>
Define Filters	Select to define selection criteria by specific Business Units, Items or Categories, Suppliers, and/or Buyers. These are all optional fields. In case you do not select any filter options, you will get Contract Expiration notices for all contracts in the system.

Note: You must set the filter option to limit your existing search results to rows that meet your criteria. By setting the filters you can reduce the original search results to a smaller number of rows so that you can focus on your area of interest.

Procurement User Preferences – PO Approval Cycle Time Page

Use the Procurement User Preferences - PO Approval Cycle Time Page to personalize and configure selection criteria for Purchase Orders that are Pending Approval.

Navigation:

Fluid Home > > Employee Self Service > My Preferences > PO Approval Cycle Time

This example illustrates the fields and controls on the PO Approval Cycle Time. You can find definitions for the fields and controls later on this page.

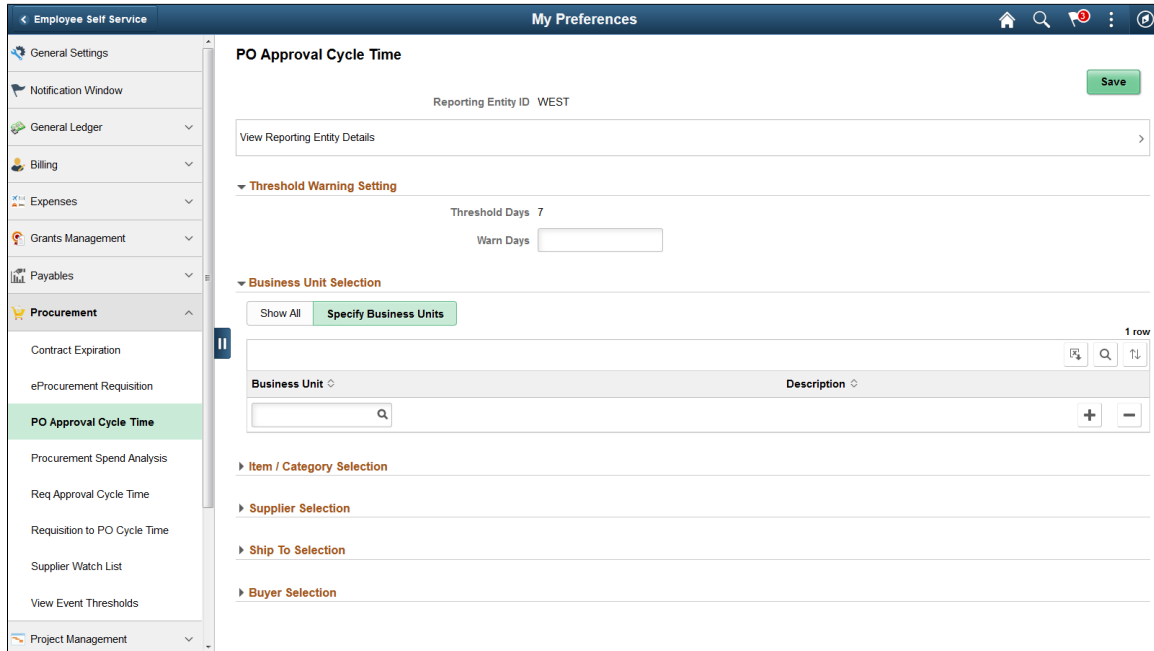

Threshold Warning Setting

Field or Control	Description
Threshold Days	Displays the event's threshold days established on the Define Event Threshold page for the Reporting Entity.
Warn	Enter the number of days to setup a warning ahead of the threshold established at the reporting entity. For example, If the reporting entity threshold days is 3 days and the warn days prior is 2, the system would select pending purchase orders whose Days Since Pending is 1 day or more.

Data Selection

<i>Field or Control</i>	<i>Description</i>
Data Filters	Select to define selection criteria by specific Business Units, Items or Categories, Suppliers, Ship To Locations, and/or Buyers. These are all optional fields.

Note: You must set the filter option to limit your existing search results to rows that meet your criteria. By setting the filters you can reduce the original search results to a smaller number of rows so that you can focus on your area of interest.

Note: The Procurement User Preferences — Requisition Approval Cycle Time page and Procurement User Preferences — Requisition to PO Cycle Time page have the same threshold warning settings and data selection criteria.

Procurement User Preferences – Procurement Spend Analysis Page

Use the Procurement User Preferences - Procurement Spend Analysis Page to personalize and configure selection criteria for Procurement spend pivot grid.

Navigation:

Fluid Home > Employee Self Service > My Preferences > Procurement Spend Analysis

This example illustrates the fields and controls on the Procurement Spend Analysis. You can find definitions for the fields and controls later on this page.

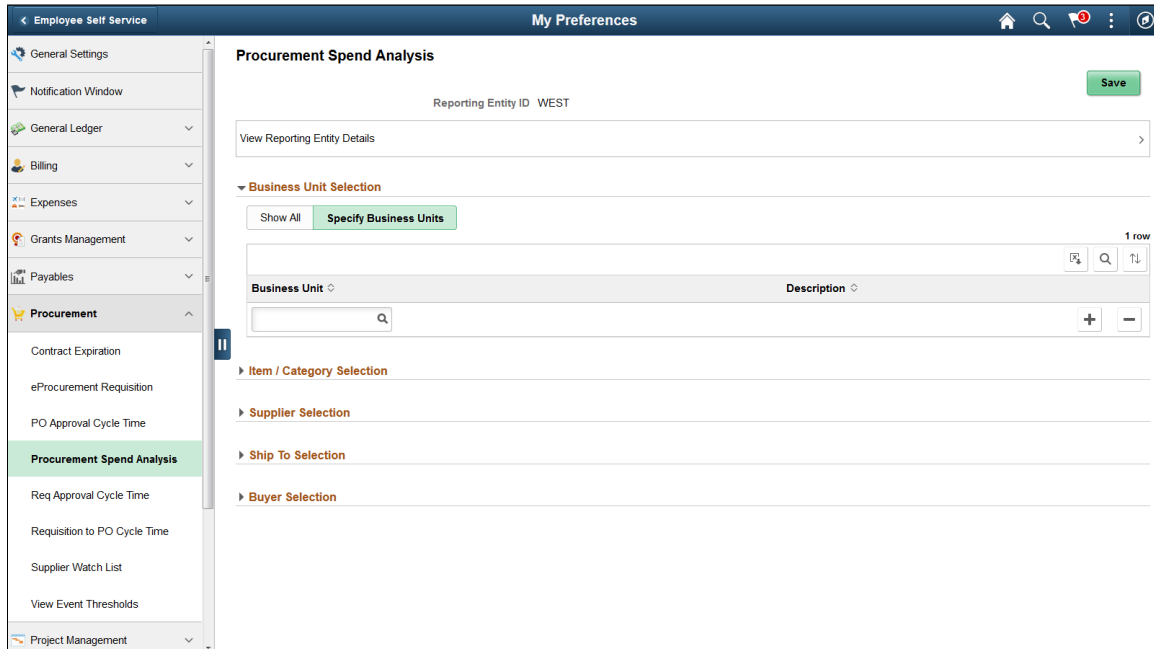

Data Selection

<i>Field or Control</i>	<i>Description</i>
Define Filters	Select to define selection criteria by specific Business Units, Items or Categories, Suppliers, Ship To Locations, and/or Buyers. These are all optional fields.

Note: You must set the filter option to limit your existing search results to rows that meet your criteria. By setting the filters you can reduce the original search results to a smaller number of rows so that you can focus on your area of interest.

Procurement User Preferences – Supplier Watch List Page

Use the Procurement User Preferences – Supplier Watch List Page to personalize and configure list of Suppliers and thresholds.

Navigation:

Fluid Home > Employee Self Service > My Preferences > Supplier Watch List

This example illustrates the fields and controls on the Procurement User Preferences – Supplier Watch List page.

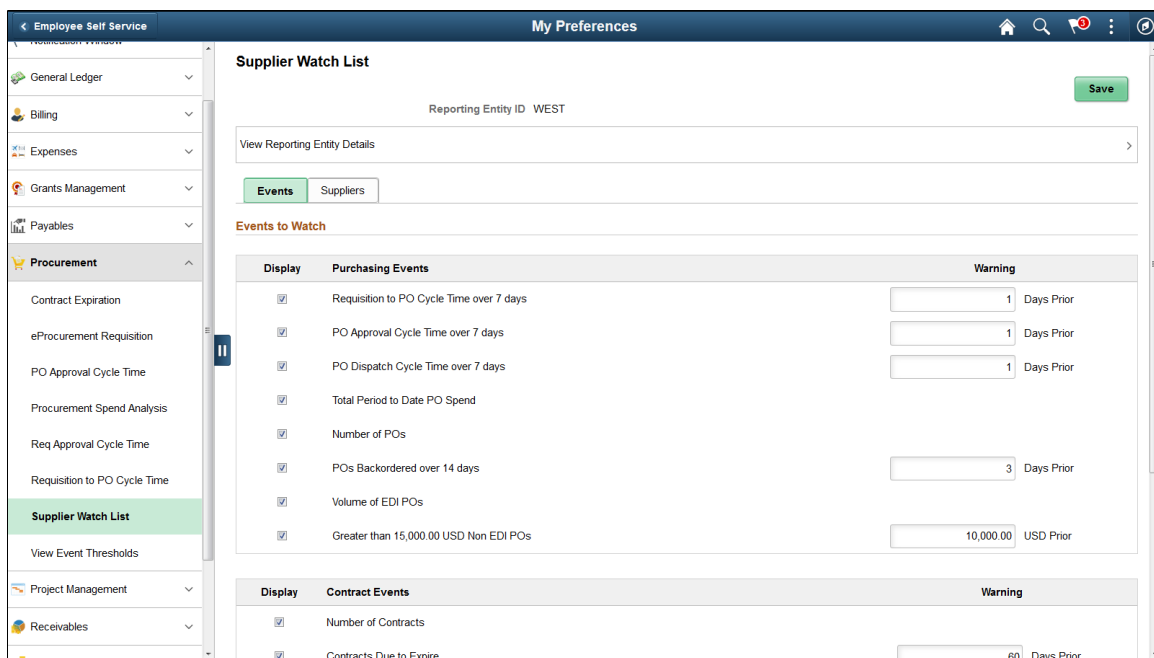

You can select events to indicate as a preference, whether an event will appear on your Supplier Watch List. You may establish your own warning thresholds for select events to warn you ahead of the threshold days reached that was established for the Reporting Entity.

Use the Suppliers Tab to add or remove suppliers to watch. You may add the suppliers, you wish to track on this tab. You also have the ability to add Suppliers “on-the-fly” from various points in the Procurement applications. You can also add suppliers to your Watch List while on the Supplier Watch List page itself.

Procurement User Preferences - View Event Threshold Page

Use the Procurement User Preferences - View Event Threshold Page to view all the available events and their respective user level thresholds.

Use the My Preference icon or tile on the Procurement Operations Page to access the View Event Threshold page.

Page Used to View the Procurement User Preferences - View Event Threshold Page

<i>Page Name</i>	<i>Definition Name</i>	<i>Usage</i>
Procurement User Preferences - View Event Threshold	PO_PREF_VET_FL	View all the events and their respective user level thresholds.

This example illustrates the fields and controls on the View Event Threshold Page. You can find definitions for the fields and controls later on this page.

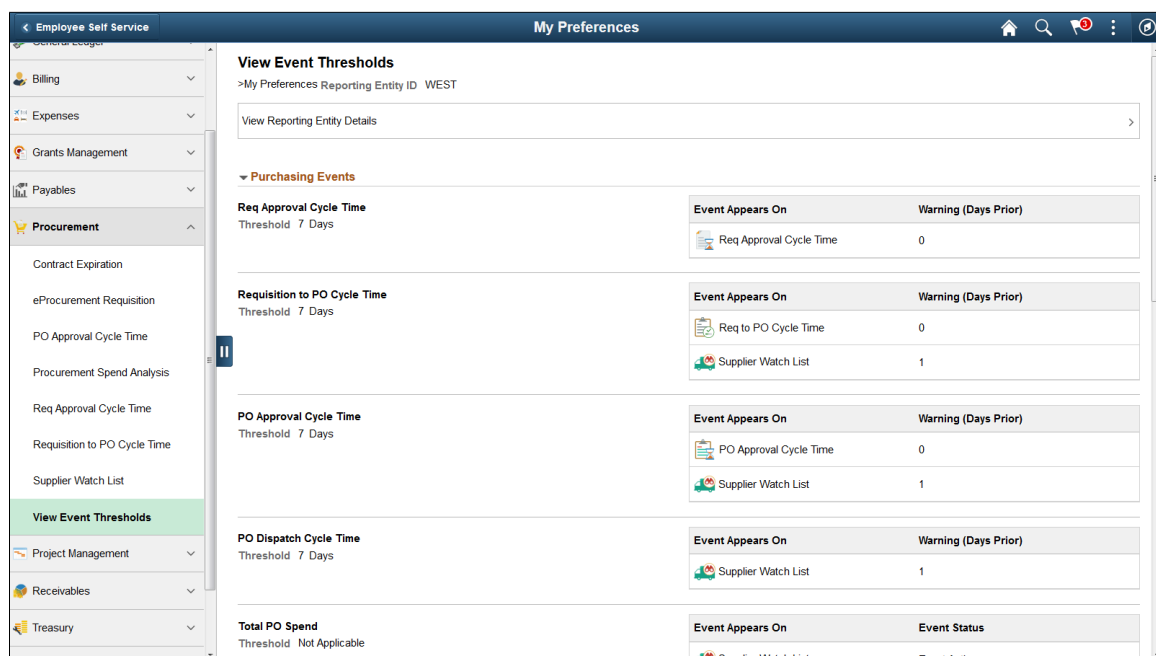

These are the conditions based on which an event is displayed to the user:

- User must have access to the event specific user preference component.
- The event must be selected as a Watch List event in case it is associated with the Supplier Watch List only. The record PS_PO_EVENT_SWL is accessed to view if an event is a watch list event.
- If an event has its own tile and is also associated with Supplier Watch List then the user should have access or the event should be selected as a Watch List event to be displayed.

These are the conditions based on which the tile rows will be displayed on the grid:

- The user must have access to the tile component for all individual tiles other than the Supplier Watch List.
- The user must have access to the tile component for all individual tiles other than the Supplier Watch. In case the user has access to the Supplier Watch List tile, but is not selected on the user level preference then the tile is displayed as “Event Inactive”

Procurement User Preferences - PO Acknowledgement Page

Use the Procurement User Preferences – PO Acknowledgement page to set the default view options on the PO Acknowledgement page.

Navigation:

Fluid Home > My Preferences > Procurement > PO Acknowledgement

This example illustrates the fields and controls on the Procurement User Preferences – PO Acknowledgement page. You can find definitions for the fields and controls later on this page.

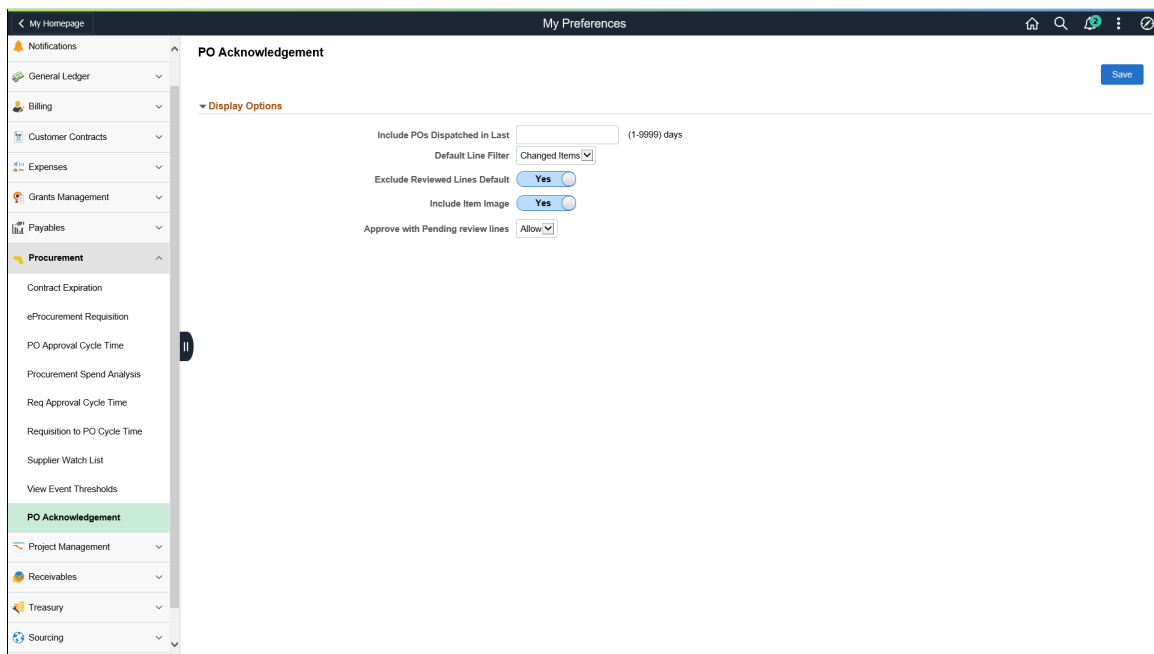

Field or Control	Description
Include POs dispatched in Last	Enter the timeframe for including the dispatched purchase orders on the PO Acknowledgements page. Default time period is 90 days.
Default Line Filter	Select the default option for displaying the purchase order lines. The available options are <i>All Items</i> and <i>Changed Items</i> .

Field or Control	Description
Exclude Reviewed Lines Default	Set the toggle to <i>Yes</i> to exclude already reviewed purchase order line items from the left pane on the Purchase Order Acknowledgement – Details page.
Include Item Image	Set the toggle to <i>Yes</i> to display the images of the items on the Purchase Order Acknowledgement – Details page.
Approve with Pending review lines	<p>When you acknowledge a PO with lines (a few or all) pending review, select any of the following display options:</p> <ul style="list-style-type: none"> • Allow (default): Allows you to approve a PO acknowledgement with lines that are pending review. • Error: Prevents you from approving a PO acknowledgement until all lines are set to Reviewed. • Warn: Displays a warning message during PO acknowledgement approval, that not all lines have been marked as Reviewed.

Procurement Operations Home Page with Reporting Entity not assigned to User

Reporting Entity must be assigned to user to be able to display information on the tile and also to be able to drill down on the tile. The following message is displayed on the tile when Reporting Entity is not assigned to a user.

This example illustrates the fields and controls on the Procurement Operations with Reporting Entity not assigned to User Page. You can find definitions for the fields and controls later on this page.

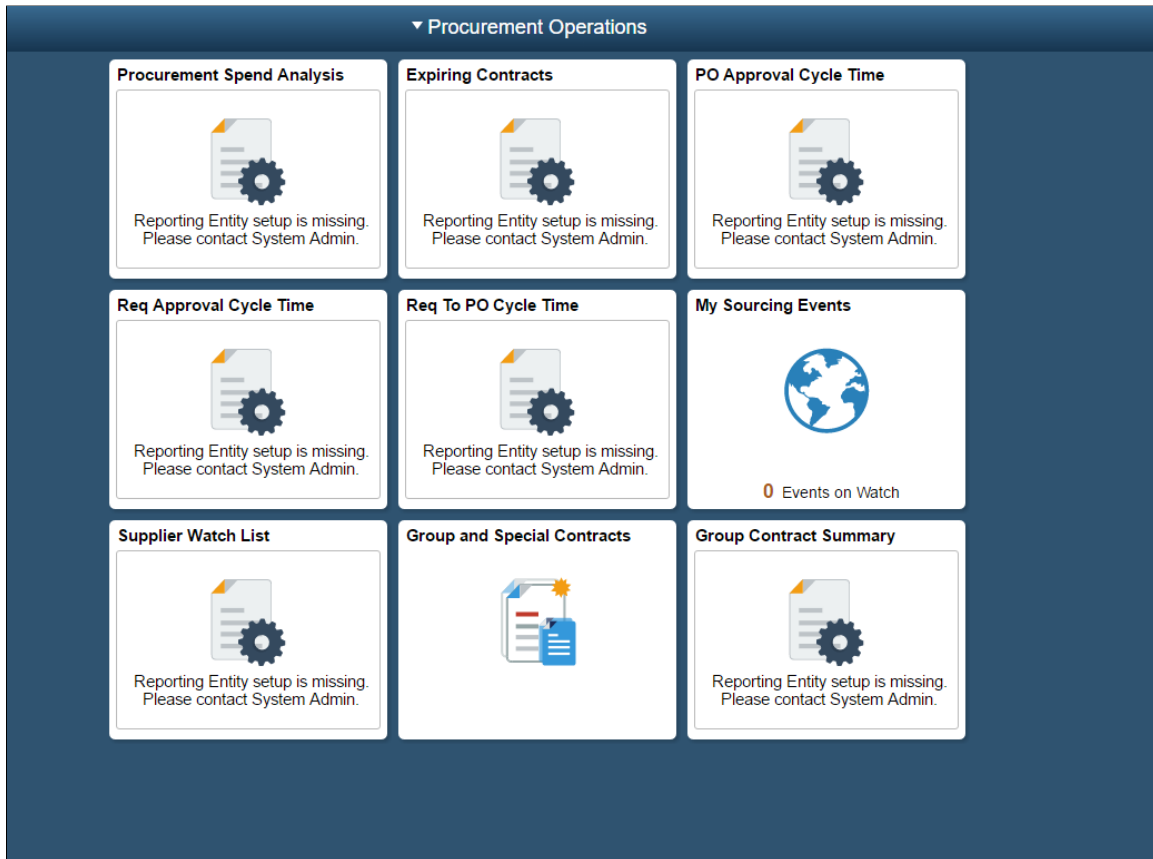

With proper Admin setup completed, Procurement Operations Home Page tiles would display tile related information and tapping on the tile would take user to tile detail Page. See Procurement Operations Home Page.

Procurement User Preferences – Sourcing Events Page

Use the Procurement User Preferences – Sourcing Events page to set up preferences for My Sourcing Events page.

Select My Preferences on the Action Menu on the top right corner to customize your view of the data.

This example illustrates the fields and controls on the Procurement User Preferences – Sourcing Events Page. You can find definitions for the fields and controls later on this page.

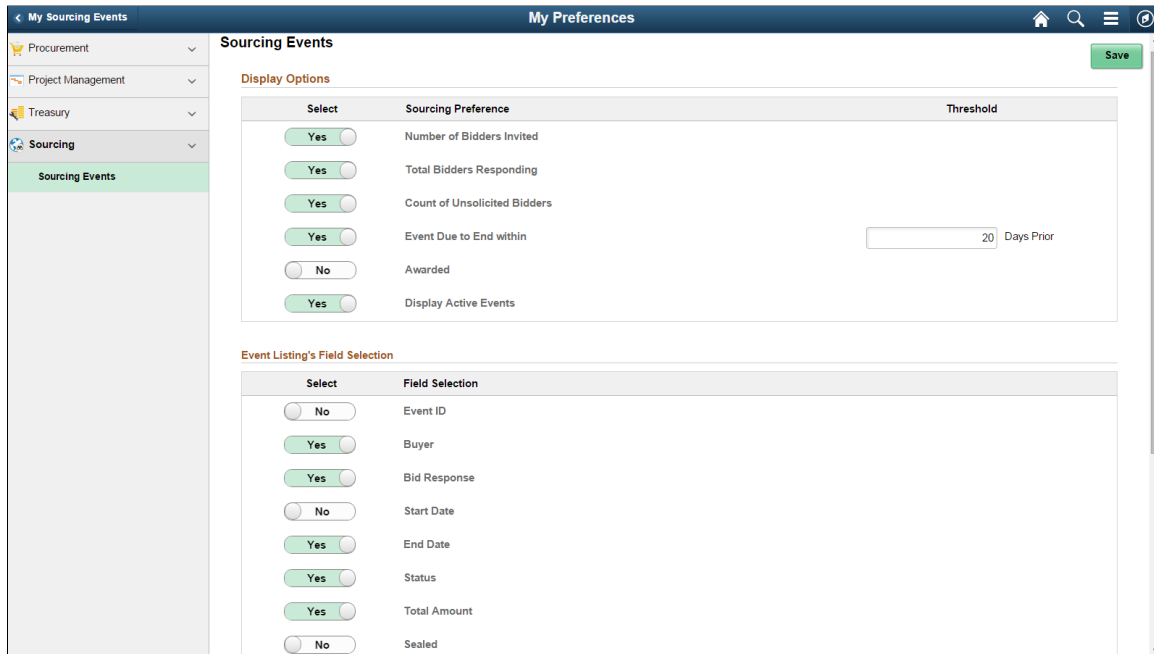

Display Options

The display of items on the My Sourcing Events page is controlled by the following setup parameters:

Field or Control	Description
Number of Bidders Invited	Displays the count of the number of bidders specifically requested to participate in the Sourcing event. The default option is Yes.
Total Bidders Responding	Displays the count of the number of bidders that have elected to participate and accepted the Event, and either have or eventually will submit a packaged Bid or Auction Price. The default option is Yes.
Count of Unsolicited Bidders	Displays the count of non-invited bidders who may have seen the event on a public site, or may have been sent to the event by a third party and have elected to participate. The default option is Yes.

<i>Field or Control</i>	<i>Description</i>
Event Due to End within	Displays the countdown to the end date of the event in terms of days. The default option is Yes.
Awarded	Displays the number as to how many bidders were awarded the Event based on the Bid Factors and decisions. The default option is No.
Display Active Events	Displays the active events in the My Sourcing Events page. The default option is Yes.

Event Listing's Field Selection

Select the fields you want to display on the My Sourcing Events page. The display of fields on the left panel in the My Sourcing Events page is controlled by setting the status to Yes or No.

Define Filters

<i>Field or Control</i>	<i>Description</i>
Define Filters	Select to define selection criteria by specific Business Units, Items or Categories, and/or Buyers. These are all optional fields.

Business Unit Selection

<i>Field or Control</i>	<i>Description</i>
All	Select to access all business units. You can only view data for the business units that you have access to.
Specific	Select to enter one or more business units. You can only select the business units you have access to.

Item / Category Selection

<i>Field or Control</i>	<i>Description</i>
All	Select to access all items and categories
Specific Items	Select to enter one or more items.
Specific Categories	Select to enter one or more categories.

Buyer Selection

<i>Field or Control</i>	<i>Description</i>
All	Select to access all buyers.
Specific	Select to enter one or more buyers.

Amount Selection

<i>Field or Control</i>	<i>Description</i>
Display Events where Amount is greater than	All events greater than the amount you enter in this field is displayed in the My Sourcing Events page. The default value is 0.
Currency Code	Select a currency code.

Working with the Procurement Operations Home Page

Use the Procurement Operations Home page to access individual procurement operations pages.

Navigation:

Fluid Home > Procurement Operations

This example illustrates the fields and controls on the Procurement Operations Home Page.

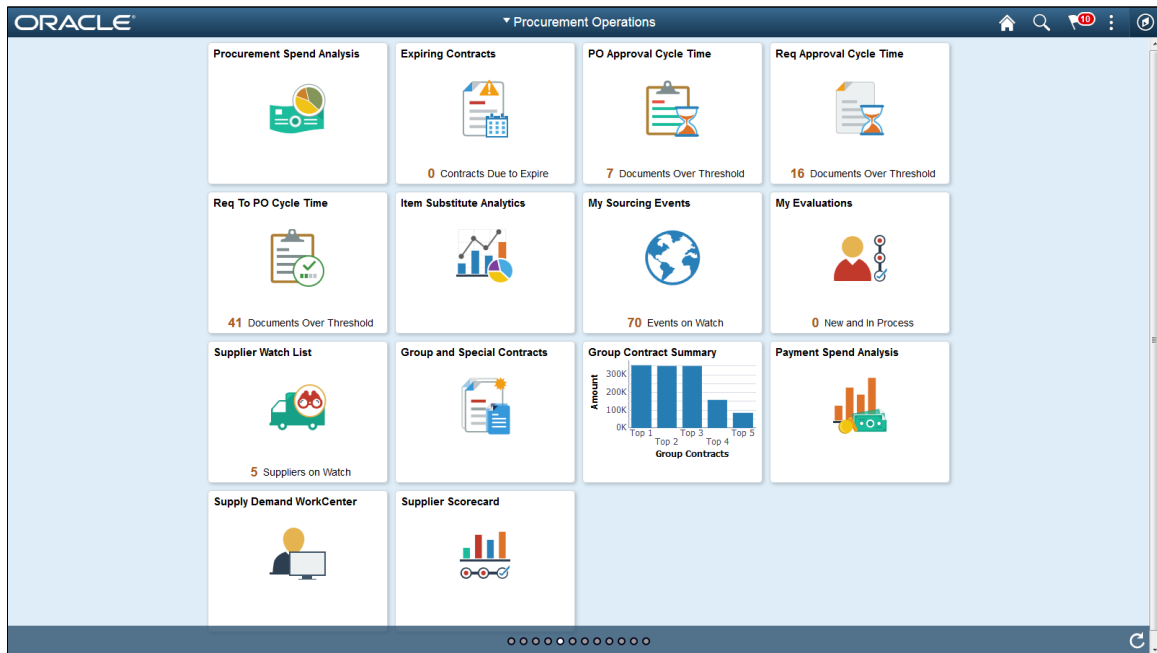

Use the Procurement Operations Home page to access individual procurement operations pages. Each tile represents one event or multiple events. All Cycle Time tiles have one event only. Supplier Watch List has multiple events. For example 'PO Approval Cycle Time' Tile has only one event 'PO Approval Cycle Time'. Supplier Watch List has both 'PO Approval Cycle Time' event as well as 'Req to PO Cycle Time' event and can have a maximum of 12 events.

The following tiles are available on the Procurement Operations Home Page:

- Procurement Spend Analysis
See [Using Procurement Spend Analysis with the PeopleSoft Fluid User Interface](#)
- Expiring Contracts
See [Expiring Contracts Page](#)
- Cycle Time Tiles
 - PO Approval Cycle Time
See [PO Approval Cycle Time Page](#)
 - Req Approval Cycle Time
See [Req Approval Cycle Time Page](#)
 - Req to PO Cycle Time
See [Req to PO Cycle Times](#)
- Item Substitute Analytics
- My Sourcing Events

See [My Sourcing Events Page](#)

- My Evaluations
- Supplier Watch List

See [Supplier Watch List Page](#)

- Group and Special Contracts

See “Group and Special Purpose Contract Component” (PeopleSoft Source to Settle Common Information)

- Group Contract Summary

See “Group Contract Summary Page” (PeopleSoft Source to Settle Common Information)

- Payment Spend Analysis

See [Payment Spend Analysis Page](#)

- Supply Demand WorkCenter

- Supplier Scorecard

See:

- “Supplier Watch List Page” (PeopleSoft Source to Settle Common Information)
- “Overall Score Rank Page” (PeopleSoft Source to Settle Common Information)
- “Overall Score Trend Page” (PeopleSoft Source to Settle Common Information)

See also *PeopleTools: Applications User's Guide*, Working With PeopleSoft Fluid User Interface.

Using Procurement Spend Analysis with the PeopleSoft Fluid User Interface

Pages Used to Analyze Procurement Spend

<i>Page Name</i>	<i>Definition Name</i>	<i>Usage</i>
Procurement Spend Analysis Page	PTPG_NUI_VWR	Analyze purchase order spend detail

Procurement Spend Analysis Page

Use the Procurement Spend Analysis (PTPG_NUI_VWR) page to analyze purchase order spend detail summarized in a pivot view.

Navigation:

Procurement Operations home page > PO Spend Analysis tile

This example illustrates the fields and controls on the Procurement Spend Analysis.

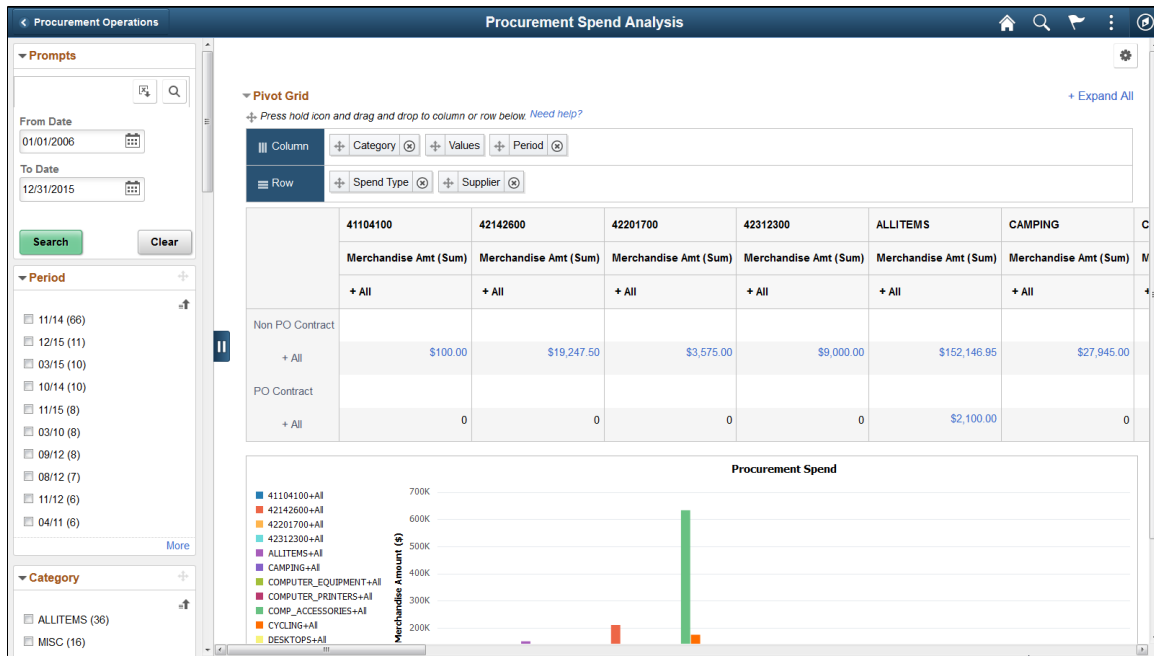

Select range of data using field prompts, filter data by selecting specific facets values, and analyze pivot data by dragging and dropping facets into the Pivot Grid Columns and Rows.

My Preference is not accessible within the Procurement Spend pivot grid. Use the Procurement User Preferences - Procurement Spend Analysis page to configure and personalize your data preference by business unit, items or item category, buyer, supplier, ship to location

Monitoring Expiring Contracts with the PeopleSoft Fluid User Interface

Page Used to Monitor Expiring Contracts

<i>Page Name</i>	<i>Definition Name</i>	<i>Usage</i>
<u>Expiring Contracts Page</u>	PO_CNTRCT_EXP_FL	View listing of Contracts that are due to expire based on specified threshold and selection criteria.

Expiring Contracts Page

Use the Expiring Contracts (PO_CNTRCT_EXP_FL) page to monitor approved contracts due to expire within the specified threshold days.

Navigation:

Procurement Operations home page > Expiring Contracts tile > Expiring Contracts

This example illustrates the fields and controls on the Expiring Contracts. You can find definitions for the fields and controls later on this page.

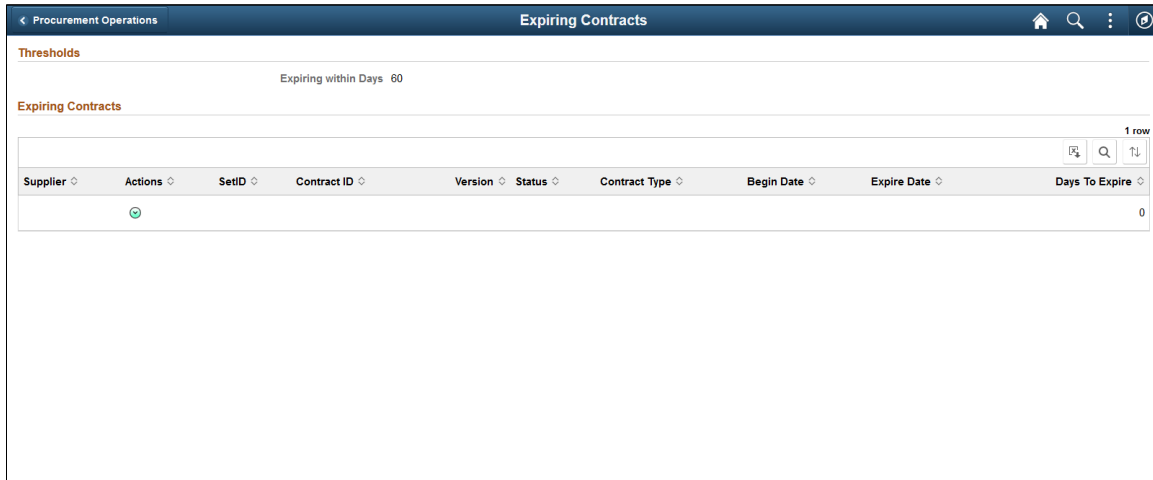

Use the My Preference icon to select and customize your view of the data.

Monitoring Cycle Times Using the PeopleSoft Fluid User Interface

Pages Used to Monitor Cycle Times

<i>Page Name</i>	<i>Definition Name</i>	<i>Usage</i>
<u>PO Approval Cycle Time Page</u>	PO_POAPP_FL	View listing of Purchase Orders that are pending approval based on specified threshold and selection criteria.
Purchase Order Details Page	PO_POAPPDT_FL	View Purchase Order lines for the selected Purchase Orders that are pending approval based on specified threshold and selection criteria.
<u>Req Approval Cycle Time Page</u>	PO_REQAPP_FL	View listing of Requisitions that are pending approval based on specified threshold and selection criteria.
Requisition Details Page	PO_REQAPPDT_FL	View Requisition lines for the selected Requisitions that are pending approval based on specified threshold and selection criteria.

Page Name	Definition Name	Usage
<u>Req to PO Cycle Times</u>	PO_REQTOPO_FL	View listing of Requisitions that have open amount based on specified threshold and selection criteria.
Requisition Details Page	PO_REQPODT_FL	View Requisition lines for the selected Requisitions that have open amount based on specified threshold and selection criteria

Understanding Cycle Time Tiles

The Cycle Time tiles help you monitor threshold events for transactions. The system will identify when the transaction cycle time exceeds either the thresholds established at the Reporting Entity or the Procurement User Preferences level.

A user can set any number of warning days for cycle time irrespective of the threshold established at the reporting entity. If the warning days exceed the reporting entity threshold days, then the system will use the same days as the reporting entity threshold days when determining if the pending transaction should be selected. For example, if the Reporting Entity Req Approval Cycle Time is 10 and the My User Preference Warn Days is 15, the Req to Approval Tile will display the Warn days as 10 and the system will select pending requisitions whose Days Since Pending is 0 day or more.

Note: Cycle Time and Procurement Spend Analysis tiles have related action to add Supplier to the watch list. Select 'Add to Watch List' action to add Supplier to watch list. If Supplier is already on watch list it shows that Supplier is already in the watch list.

PO Approval Cycle Time Page

Use the PO Approval Cycle Time (PO_POAPP_FL) page to monitor purchase orders pending approvals equal to or exceeding the specified thresholds.

Navigation:

Procurement Operations home page > PO Apprvl Cycle Time tile

This example illustrates the fields and controls on the PO Approval Cycle Time page. You can find definitions for the fields and controls later on this page.

PO Approval Cycle Time

Thresholds
Threshold Days 7
Warn 0 Days Prior

Purchase Orders

Business Unit	PO Number	Actions	Buyer	Supplier	Merchandise Amount	Currency	Status	Pending From	Days Since Pending	Budget Status	Hold
US003	000000002	🟢	Kenneth Schumacher	Deltz	\$14,000.00	USD	Pend Appr	10/28/2014	1661	Not Chk'd	No
US003	000000003	🟢	Calvin Roth	Bike Shopper	\$10,805.00	USD	Pend Appr	10/28/2014	1661	Not Chk'd	No
US003	000000004	🟢	Calvin Roth	Eastern Bay Office Supplies	\$15,000.00	USD	Pend Appr	07/25/2018	295	Not Chk'd	No
US003	000000005	🟢	Edmund Donahue	Medical Supply	\$15,814.50	USD	Pend Appr	07/25/2018	295	Valid	No
US003	000000006	🟢	Edmund Donahue	Corvidium Medical Supply	\$15,206.57	USD	Pend Appr	07/25/2018	295	Valid	No
US003	000000007	🟢	Sudarsan Tadipatri	Eastern Bay Office Supplies	\$619.25	USD	Pend Appr	01/21/2016	1211	Valid	No
US003	000000008	🟢	Calvin Roth	Big CompUSA	\$132,720.00	USD	Pend Appr	02/15/2016	1186	Valid	No

Use the My Preference icon to select and customize your view of the data.

Req Approval Cycle Time Page

Use the Req Approval Cycle Time (PO_REQAPP_FL) page to monitor requisitions pending approvals equal to or exceeding the specified thresholds.

Navigation:

Procurement Operations home page > REQ Apprvl Cycle Time tile

This example illustrates the fields and controls on the Req Approval Cycle Time Page. You can find definitions for the fields and controls later on this page.

Req Approval Cycle Time

Thresholds
Threshold Days 7
Warn 0 Days Prior

Requisitions

Business Unit	Requisition ID	Actions	Requester	Merchandise Amount	Currency	Status	Pending From	Days Since Pending	Budget Status	Hold
US003	000000003	🟢	Calvin Roth	\$1,750.00	USD	Pending Approval	07/25/2018	295	Not Chk'd	No
US003	000000004	🟢	Kelly Jones	\$7,000.00	USD	Pending Approval	10/29/2014	1660	Not Chk'd	No
US003	000000005	🟢	Calvin Roth	\$675.00	USD	Pending Approval	07/25/2018	295	Not Chk'd	No
US003	000000006	🟢	Edmund Donahue	\$1,125.00	USD	Pending Approval	07/25/2018	295	Valid	No
US003	000000008	🟢	Edmund Donahue	\$1,125.00	USD	Pending Approval	07/25/2018	295	Valid	No
US003	000000009	🟢	Edmund Donahue	\$1,140.00	USD	Pending Approval	11/25/2014	1633	Valid	No
US003	000000010	🟢	Edmund Donahue	\$1,125.00	USD	Pending Approval	11/25/2014	1633	Valid	No
US003	000000011	🟢	Rosanna Channing	\$7,000.00	USD	Pending Approval	11/26/2014	1632	Valid	No
US003	000000012	🟢	Rosanna Channing	\$7,512.46	USD	Pending Approval	11/26/2014	1632	Valid	No
US003	000000013	🟢	Rosanna Channing	\$7,000.00	USD	Pending Approval	07/25/2018	295	Valid	No
US003	000000014	🟢	Edmund Donahue	\$770.00	USD	Pending Approval	01/23/2015	1574	Valid	No
US003	000000015	🟢	Edmund Donahue	\$705.00	USD	Pending Approval	07/25/2018	295	Valid	No

Use the My Preference icon to select and customize your view of the data.

Req to PO Cycle Times

Use the Req to PO Cycle Time (PO_REQTOPO_FL) page to monitor approved requisitions with remaining items to be sourced to PO exceeding the specified thresholds.

Navigation:

Procurement Operations home page > Req to PO Cycle Time tile > Req to PO Cycle Time

Use the My Preference icon to select and customize your view of the data.

This example shows the Requisitions Approved but still having open amount after threshold days. You can drill down to line level.

This example illustrates the fields and controls on the Req to PO Cycle Time. You can find definitions for the fields and controls later on this page.

Business Unit	Requisition ID	Actions	Status	Requester	Open Amount	Currency	Approval Date	Days Since Approved	Budget Status	Hold
EGNBU	000000006		Approved	Claude Monet	\$1,050.00	USD	03/25/2016	1147	Valid	No
EGNBU	000000008		Approved	Charlotte Jorgenson	\$95,250.00	USD	05/13/2016	1098	Valid	No
EGNBU	000000009		Approved	Claude Monet	\$750.00	USD	06/28/2016	1052	Not Chk'd	No
EGNBU	000000010		Approved	Claude Monet	\$500.00	USD	06/28/2016	1052	Not Chk'd	No
EGNBU	000000012		Approved	Wayne Mitchell	\$550.00	USD	03/15/2017	792	Valid	No
EGNBU	000000013		Approved	Wayne Mitchell	\$1,240.00	USD	03/15/2017	792	Valid	No
EGNBU	000000014		Approved	David Haderlein	\$180.00	USD	03/15/2017	792	Valid	No
EGUBU	000000006		Approved	Rosanna Channing	\$4,000.00	USD	03/17/2016	1155	Valid	No
EGUBU	000000008		Approved	Mimi Young	\$140.00	USD	05/04/2016	1107	Not Chk'd	No
EGUBU	000000009		Approved	Mimi Young	\$130.00	USD	05/04/2016	1107	Not Chk'd	No
EGUBU	000000010		Approved	Linda Adams	\$820.00	USD	05/04/2016	1107	Not Chk'd	No
EGUBU	000000011		Approved	Linda Adams	\$87.85	USD	05/04/2016	1107	Not Chk'd	No

Select the 'Action Menu' on the top right corner, to go to My Preferences to make modifications .

Managing Sourcing Events with the PeopleSoft Fluid User Interface

Page Used to Manage Sourcing Events

Page Name	Definition Name	Usage
My Sourcing Events Page	MY_SOURC_EVENTS_FL	Track, create and manage Sourcing events in strategic sourcing.

My Sourcing Events Page

Use the My Sourcing Events (MY_SOURC_EVENTS_FL) page to track, create and manage Sourcing events in strategic sourcing.

Navigation:

Procurement Operations home page > My Sourcing Events tile > My Sourcing Events

This example illustrates the fields and controls on the My Sourcing Events Page. You can find definitions for the fields and controls later on this page.



The count of sourcing events display on the My Sourcing Events tile. If there are no events, the count is zero.

A user must set up preferences to see the events in the My Sourcing Events page. Select My Preferences on the Action Menu on the top right corner of My Sourcing Events page to set up preferences and customize your view of data. See [Procurement User Preferences – Sourcing Events Page](#)

The left hand side panel of the My Sourcing Events page displays the list of events based on Event Name, and sorted by date.

The left hand side panel of the My Sourcing Events page has the following icons:

Field or Control	Description
Filter	Narrow down the list of events on the My Sourcing Events page. You can apply additional filters on the data (apart from what was set in My Preferences page) to further filter results by Event Type, Event Format, and Event Status.
Sort	Sort the events on ascending or descending order.

Field or Control	Description
Field Selection	Edit the fields selected on the left hand side panel.

Other details on the left hand side panel include:

- Event Name
- Bid responses with count of bid responses out of the Minimum Response required.
- Event Status
- Event End date
- Warnings (If the event has warning due to end within ‘X’ days, or minimum response required.)

When you click an event on the left hand side panel of the My Sourcing Events page, the details of the event display on the right hand side.

Events Not Open to Public and Not Sealed

When the event is not open to Public and not sealed, the Event header fields **Public** and **Sealed** display the status as No. The summary panel on the left hand side displays the **Bid Responses** number. If the Bid Responses is zero on the left hand side panel, then no links are displayed under **Event Monitoring** on the right hand side.

The following links are available under Event Monitoring when an Event is not open to Public and not Sealed. When you click on these links, you can further drill down to the details of the event.

Field or Control	Description
Number of Bidders Invited	Displays the Bidders Invitation Details page with details of the event. The Bidders Invitation page displays the list of bidders or suppliers specifically requested to participate in the Sourcing Event along with the invitation status.
Total Bidders Responding	Displays Total Bidders Responding page with details about bidders’ responses. The Total Bidders Responding page displays information about suppliers and bidders that have elected to participate and accepted the Event, and either have or eventually will submit a packaged Bid or Auction Price.
Awarded	Displays the Award Details page with details of Award for that event. The Award Details page displays information about the bidders who were awarded the Event based on the Bid Factors and decisions.

Events Not Open to Public and Sealed

For a Sealed event, **Bid Responses** on the left hand side panel displays **Sealed**. When an event has reached the end date for a sealed event, the links display all the information in detail. If the event has not reached the end date, only the links display. However, the information and details are hidden.

Event open to Public and Not Sealed

When an event is open to Public, the link **Count of Unsolicited Bidders** displays. Bidders who were not invited from the Bidder Invitation page and responding to an Open event are listed under this page.

Using the Supplier Watch List With the PeopleSoft Fluid User Interface

Pages Used in the Supplier Watch List

<i>Page Name</i>	<i>Definition Name</i>	<i>Usage</i>
<u>Supplier Watch List Page</u>	PO_SWL_WATCH_FL	View list of Suppliers on the watch. Add or remove Suppliers. View event exceptions for the Suppliers.
Open Requisitions Page	PO_SWL_RQTOPO_FL	View list of Requisitions that have open amount based on the specified threshold for selected Supplier.
Pending PO Details Page	PO_SWL_CH_ND_PA_FL	View listing of Purchase Orders that are pending approval based on specified threshold for selected Supplier.
Approve PO Details Page	PO_SWL_CH_ND_A_FL	View listing of approved Purchase Orders that are not dispatched based on specified threshold for selected Supplier.
Business Unit Spend Page	PO_SWL_BU_BO_FL	View Business Unit Amount for overdue Purchase Orders.
Backorder Volume Details Page	PO_SWL_BO_DTL_FL	View listing of overdue Purchase Orders for selected Business Unit.
Business Unit Spend Page	PO_SWL_BU_NOEDI_FL	View Business Unit Amount for Non EDI Purchase Orders.
Non EDI Volume Details Page	PO_SWL_NEDI_DTL_FL	View listing of Non EDI Purchase Orders for selected Business Unit.

Page Name	Definition Name	Usage
Expiring Contracts Page	PO_SWL_CNT_EXP_FL	View listing of Contracts that are due to expire based on specified threshold for selected Supplier.
Business Unit Spend Page	PO_SWL_BU_NC_FL	View Business Unit Amount for Non Contract Purchase Orders.
Non Contract Spend Page	PO_SWL_CNT_PVG_FL	View Purchase Orders with Non Contract Spend for selected Business Unit in a Pivot Grid.

Supplier Watch List Page

Use this page to view a list of suppliers from the watch list, add or remove suppliers, and view supplier event data.

Navigation:

Procurement Operations home page > Supplier Watch List tile > Supplier Watch List

This example illustrates the fields and controls on the Supplier Watch List. You can find definitions for the fields and controls later on this page.

The screenshot displays the 'Supplier Watch' interface. On the left, a list of suppliers is shown with their names and locations. The selected supplier, 'B2B Solutions', is highlighted. The right side of the page provides detailed information for this supplier, including contact details, entity information, and various performance metrics under 'Purchase Order' and 'Contract Information' sections.





Suppliers		Supplier		Entity	
B2B Solutions	British Columbia, BC B7C9R7	Sup... B2B Solutions	Con... John Barker	Rep... WEST	Entity
BIKE SHOP	ANY TOWN, CA 95120	Phone Not Listed	Email change_me@email.com	Start Date 03/01/2007	End Date 10/31/2015
CAMPER'S WAREHOUSE	ANY TOWN, KS 66044	Purchase Order		Cur... USD	
CompUSA	Pleasanton, CA 94588	Requisition to PO Cycle Time over 2 days	0		
Computers Unlimited	City 1, ACT AUS	PO Approval Cycle Time over 2 days	0		
		PO Dispatch Cycle Time over 2 days	0		
		Total Period to Date PO Spend	\$0.00		
		Number of POs	0		
		POs Backordered over 5 days	\$0.00		
		Volume of EDI POs	\$0.00		
		Greater than \$15,000.00 Non EDI POs	\$0.00		
		Contract Information			
		Number of Contracts	0		
		Contracts Due to Expire in 60 days	0		

This page displays a list of suppliers and their respective event data. You can select more than one supplier to get the event data. Violations and warnings are shown depending on certain pre-set conditions as defined by the user or reporting entity. For threshold of 'Days', one or more transaction matching pre-set condition at admin level will show as Violation. If one or more transaction match only user level pre-set condition then it will show as Warning. The system displays the total count of violations and warnings on the left panel against each Supplier.

Note: For amounts, if any business unit amount exceeds reporting entity setup, then it is shown as a violation. If business unit amount only exceeds user -threshold then it is shown as warning.

Supplier Watch List displays list of watched Suppliers on the left. One or more Suppliers can be added or deleted using the buttons on the top of the list. Event threshold violation or warning is indicated next to the event on right. Select this indicator to go to Business Unit level or transaction level information depending on the event selected. A total count of violations and warnings is displayed on the left along with Supplier name.

Select a different Supplier on left to monitor the Supplier event information.

<i>Field or Control</i>	<i>Description</i>
	Select to add one or more Suppliers to watch list. Opens a Search window, where Supplier name can be entered as search criteria. Shows list of Suppliers that match criteria. Multiple Suppliers can be selected. Suppliers are added to end of the list.
	Select to enter edit mode. Edit mode allows you to select one or more Suppliers for deletion from list.
	Indicates Reporting Entity threshold violation for event. Select to drill down to Business Unit or Transaction level information depending on event.
	Indicates user level threshold violation (warning) for event. Select to drill down to Business Unit or Transaction level information depending on the event.
	Select 'My Preference' to go to user preferences specific to the tile user is on.

Adding Suppliers

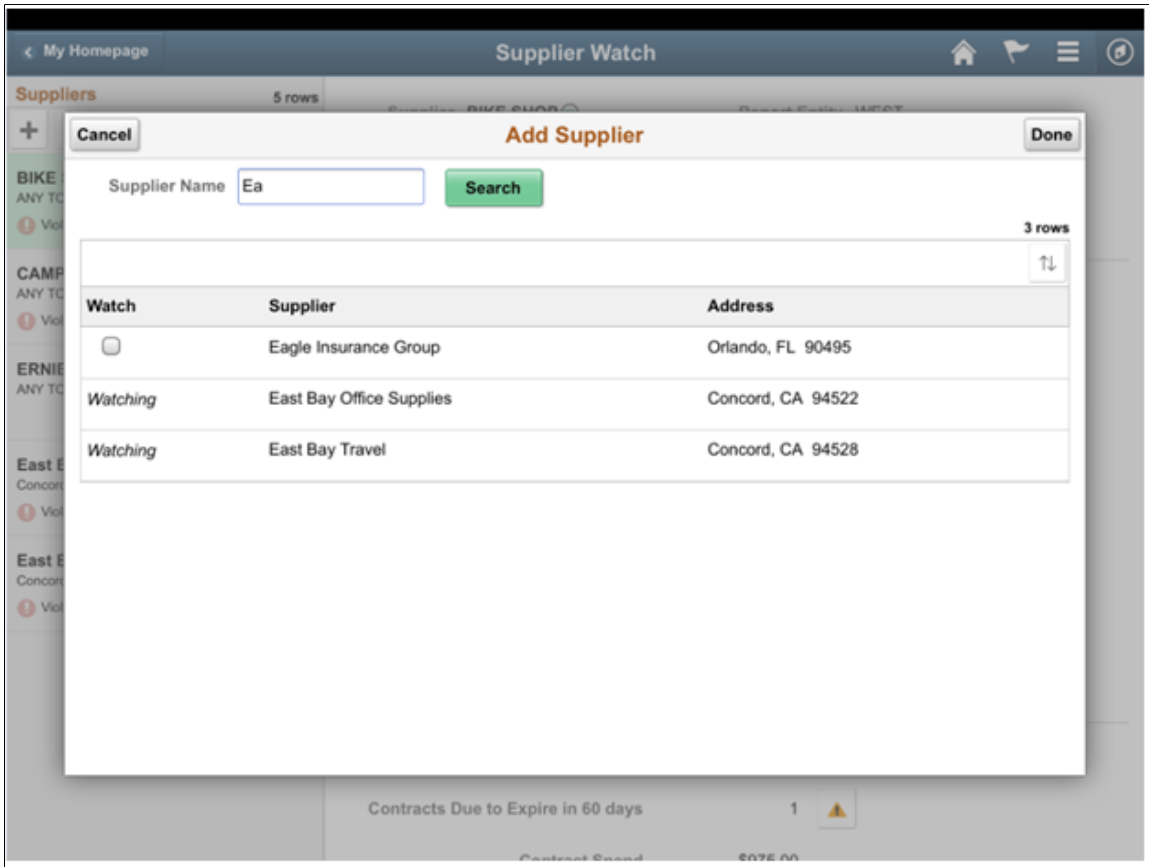

Select on the '+' button to add Supplier to the Supplier Watch List. The pop up window gives you the option to Search on Supplier name and selects one or more Suppliers. Selecting **Done** will add the Supplier to the Supplier Watch List. Selecting **Cancel** would not add Suppliers to the list. **Warning** is displayed for Suppliers that are already in the list and cannot be selected.

This example illustrates the fields and controls on the Supplier Watch List — Add Supplier Page. You can find definitions for the fields and controls later on this page.



Editing Suppliers

Supplier Watch List Edit mode can be used to remove one or more Suppliers from the Watch List.

Field or Control	Description
	Select to cancel out of edit mode. Only displayed when in edit mode.
	Displayed when one or more Suppliers are selected (for deletion). Shows count of Suppliers selected. Select to delete selected Suppliers from list.

Notifying Suppliers

Select related action menu next to Supplier name on right and select the 'Notify' action for the notification pop up. Use the notification window to send email to Supplier or any employee. Supplier name is defaulted in the subject area. Supplier contact email is defaulted into 'To' list.

This example illustrates the fields and controls on the Supplier Watch List — Send Email Page. You can find definitions for the fields and controls later on this page.

The screenshot displays the 'Supplier Watch' interface. On the left, a list of suppliers is visible, including 'BIKE SHOP' (ANY TOWN, CA 95120) with 4 violations, 'CAMPER'S WAREHO' (ANY TOWN, KS 66044) with 2 violations, 'ERNIE'S BIKE SHOP' (ANY TOWN, TX 76262), 'East Bay Office Sup' (Concord, CA 94522) with 1 violation, and 'East Bay Travel' (Concord, CA 94528) with 2 violations. The main area shows a 'Send Email' modal form with the following fields:

- *To: change_me@email.com
- CC: (empty)
- BCC: (empty)
- *Subject: Attn Supplier: BIKE SHOP
- Message: (empty)

A green 'Send Email' button is located at the bottom of the modal. Below the modal, summary statistics are shown: 'Number of Contracts' (3), 'Contracts Due to Expire in 60 days' (1 with a warning icon), and 'Contract Spend' (\$075.00).

Using Sourcing Information

Use the Sourcing Information parameters to monitor supplier or bidder performance. These sourcing parameters are based on the settings configured in [Procurement User Preferences – Supplier Watch List Page](#), and [Configuring Thresholds and Events for Procurement Operations Page](#).

This example illustrates the fields and controls on the Supplier Watch – Sourcing Information section. You can find definitions for the fields and controls later on this page.

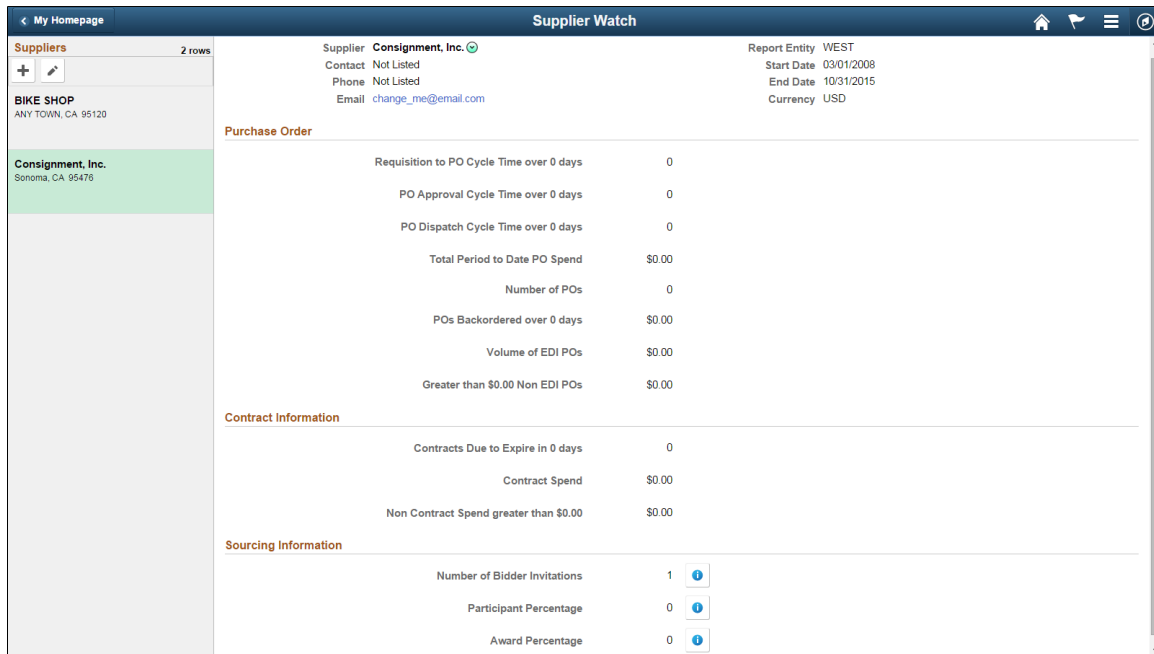

Field or Control	Description
Number of Bidder Invitations	<p>Displays the count of the bidders specifically requested to participate in the Sourcing event.</p> <p>Click on the icon next to Number of Bidder Invitations to view the event details by Business units, and Invitation details.</p>
Participation Percentage	<p>Displays the Participation percentage of the bidders. This parameter indicates how many bidders responded to a Sourcing Event.</p> <p>Click on the icon next to Participation Percentage to view the event details by Business units, and bidder Participation details.</p>
Award Percentage	<p>Displays the Award percentage of the bidder for the event they participated.</p> <p>Click on the icon next to Award Percentage to view the event details by Business units, and Event Awarded details.</p>

Using the My Analytics (Related Information) Panel

Simplified Analytics in the Supplier Watch List enable users to compare metrics among Suppliers on their Watch List (All Suppliers or just one Supplier). With Simplified Analytics, users can create, customize and save analytic reports, and drill down detail information related to a Supplier.

Simplified Analytics enables:

- End users of a fluid application page to create contextual analytic reports. They can create their own reports based on the pre-defined templates by selecting the fields, filling the prompt fields, defining the layout, and selecting different types of visualizations.
- Administrator or super user to create and publish reports (based on the configured base templates) to all users of the component.
- End users to add a saved analytic report to home page and view later.

Note: To enable Simplified Analytics for a component, application developers or business administrators have to associate one or more Pivot Grid models (or base templates) to a component. They can also map page fields to the prompts that are associated with the template model to define the required context. The Simplified Analytics feature is only available for fluid components in PeopleTools 8.55 and this feature must be enabled for fluid components before users can use the Simplified Analytics Wizard to create and view analytic reports. For more information, see the section Enabling/Disabling Simplified Analytics in Supplier Watch List.

The following Simplified Analytics are available on the Supplier Watch List:

Simplified Analytic Name	Pivot Grid Model Name	Usage
Backorder by Supplier	PO_SPND_BACKORD_SEL_SA_FL	<p>Enables a user to evaluate backorder amount for one supplier or compare one supplier against another supplier.</p> <hr/> <p>Note: You must run the Update Spend History process to populate data for Supplier Backorder Analytics. For more information, see Understanding the Spend History Application Engine Process (PO_SPND_HIST)</p>
On-Time Delivery Performance	PO_ONTIME_PERFORMANCE_SA_FL	<p>Enables a user to evaluate performance for one supplier or compare one supplier against another supplier.</p> <hr/> <p>Note: You must run the Update Procurement Info process to update performance metrics for supplier performance. See Understanding the Procurement History Update Application Engine Process (FS_PRCRUPD)</p>
Overdue PO Acknowledgements	PO_NOPOA_HOURS_SA_FL	<p>Enables a user to evaluate acknowledgements for one supplier or compare one supplier against another supplier.</p>

Enabling/Disabling Simplified Analytics in Supplier Watch List

For Simplified Analytics, pivot grids must be assigned to a component. A pivot grid attached to a component forms the base of a Simplified Analytic.

Use the Assign Related Content (PTCS_SERVICECFG) page to enable/disable Simplified Analytics in the Supplier Watch List.

Navigation:

PeopleTools > Portal > Related Content Service > Manage Related Content Service

Search for **Supplier Watch List**, and then click **Edit**. Verify if the **Enable** check box is selected for the Simplified Analytics.

Select/Deselect the **Enable** check box to enable/disable Simplified Analytics.

When Simplified Analytics is assigned to a component and enabled, the **My Analytics** panel displays in the right side of the component.

This example illustrates the fields and controls on the My Analytics Panel as displayed on a tablet. You can find definitions for the fields and controls later on this page.

Suppliers	Purchase Order	Contract Information
Suppliers 5 rows B-to-C Solutions British Columbia, BC B7C 9R7 3 Violations Big CompUSA Pleasanton, CA 94588 4 Violations Bike Shopper ANY TOWN, CA 95120 5 Violations CAMPER'S WAREHOUSE ANY TOWN, KS 66044 4 Violations Limit Computers City 1, ACT AUS 1 Violation	Supplier B-to-C Solutions Contact John Barker Phone Not Listed Email change_me@email.com Requisition Cycle Time over 2 days 0 PO Approval Cycle Time over 2 days 0 PO Dispatch Cycle Time over 2 days 0 Total Period to Date PO Spend \$198,305 Number of POs 3 POs Backordered over 5 days \$185,305.00 Volume of EDI POs \$0.00 Greater than \$15,000.00 Non EDI POs \$198,305.00	Number of Contracts 0 Contracts Due to Expire in 60 days 0

Use the **My Analytics** panel to create, edit, or view the analytic reports in the Supplier Watch List.

Create Analytics Wizard - Step 1

Use the Create Analytics Wizard - step 1 to specify the names of the analytic reports, select the analytic report template and select the display options that will be used to create the analytic report.

This example illustrates how to create an analytic report for Backorder by Supplier. You can follow these steps to create other analytic reports such as On-Time Delivery Performance and Overdue PO Acknowledgements.

Navigation:

Select the + button to create a new Analytic.

This example illustrates the fields and controls on the Backorder by Supplier as displayed on a tablet. You can find definitions for the fields and controls later on this page.

<i>Field or Control</i>	<i>Description</i>
Analytics Name	Enter a name for the analytic report.

Field or Control	Description
What kind of analytics would you like to create?	<p>Displays the available analytic templates that are used to create the analytic report. The template you select from this list determines the fields and prompts in the next step of the wizard, Create Analytics - step 2.</p> <hr/> <p>Note: This drop-down list is not available when only one template is available.</p> <hr/>
Display Option	<p>Define the display options for the analytic reports. The following display options are available; you can use different combinations of these display options:</p> <ul style="list-style-type: none"> • Chart • Simple table • Pivot grid
Next	Click to advance the wizard to the next page.

Create Analytics Wizard - Step 2

Use the Create Analytics Wizard - step 2 to select the fields for the analytic reports and to change the default values of the prompt fields.

Navigation:

From the Create Analytics Wizard - step 1, click the **Next** button.

This example illustrates the fields and controls on the Create Analytics Wizard - Step 2 as displayed on a tablet (Backorder by Supplier). You can find definitions for the fields and controls later on this page.

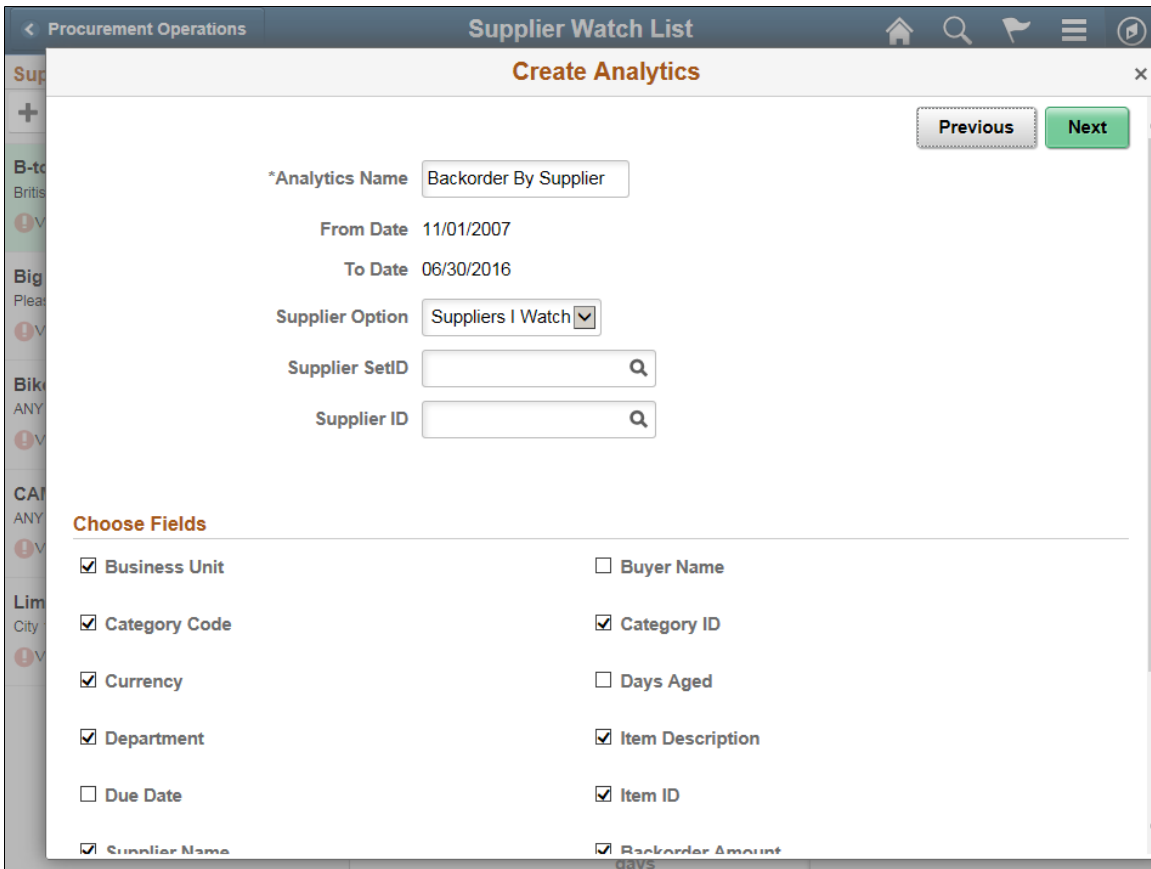

Field or Control	Description
From Date, To Date	<p>In this example, the From Date and To Date fields appear based on the parameters set in the Related Content configuration. These prompts are defined in the Pivot Grid based template model.</p> <hr/> <p>Note: The date-fields are read-only because the value for this field is implicitly passed from the transaction page because of the related content configuration.</p>
Supplier Option	<p>Select an option to display metrics for Suppliers only on the Watch List, or All Suppliers, or for a Supplier for a specified Supplier Id.</p>
Choose Fields	<p>Use this section to select the fields that will appear in the analytic reports.</p> <p>Some fields are preselected because those fields form a part of rows/columns/axis/filters in the base template model.</p>

Field or Control	Description
Previous	Click to go back to the Create Analytics Wizard - step 1.
Next	Click to advance the wizard to the next page, where you can preview the display of the analytic reports.

Create Analytics Wizard - Step 3

Use the Create Analytics Wizard - step 3 to preview the analytic reports based on the display options, fields, and prompts selected in the previous steps of the wizard. Optionally, you can modify (by dragging and dropping, applying filters, and so on) the analytic reports to finalize the design and then click the Save button to save the final report.

Navigation:

From the Create Analytics Wizard - step 2, click the **Next** button.

This example illustrates the fields and controls on the Create Analytics Wizard - Step 3 as displayed on a tablet (Backorder by Supplier). You can find definitions for the fields and controls later on this page.

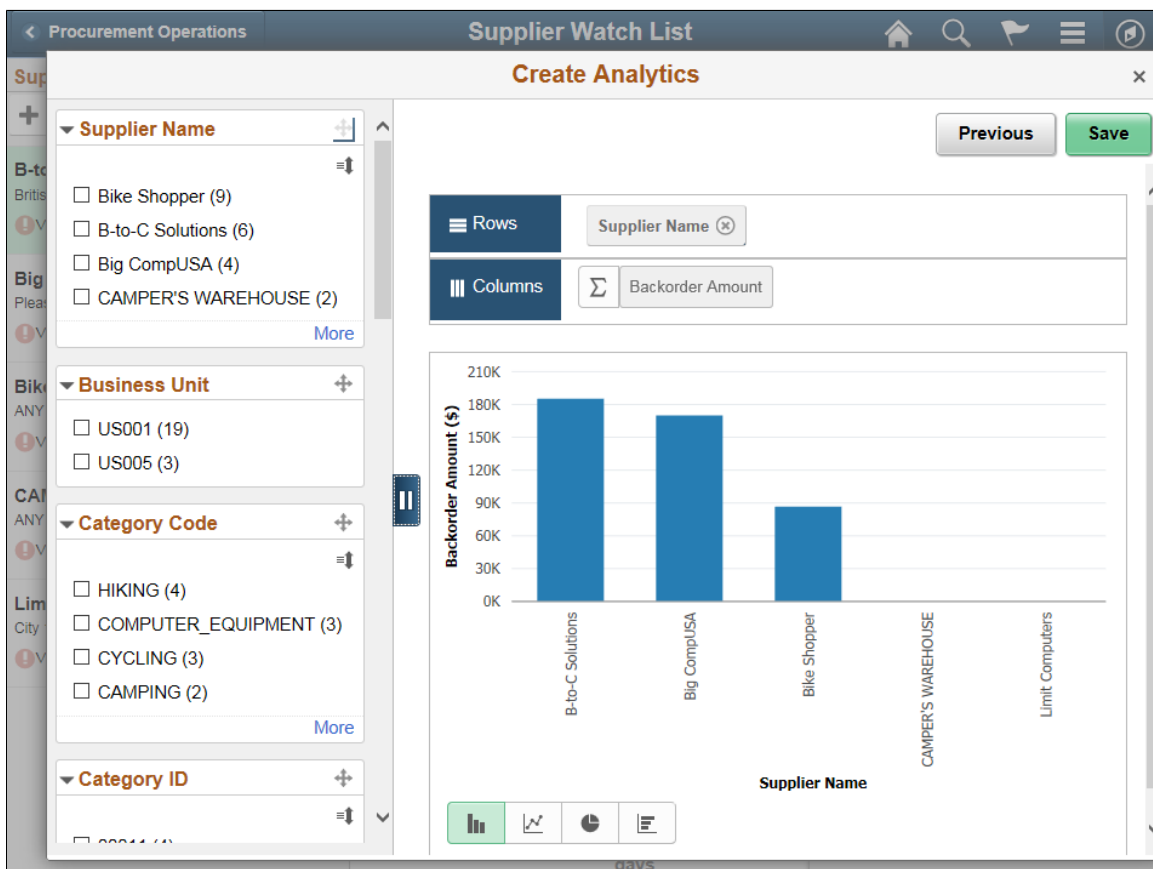

From the preview window, use the **Save** button to save the analytic report.

On saving the analytic report, the **Add to Homepage** button is enabled which you can use to add the analytic report to the fluid homepage. For more information, see Adding Analytic Reports to the Fluid Homepage section in *PeopleTools: Pivot Grid*

If you are an administrator or super user, saving the analytic report enables the **Publish Options** button which you can use to publish the analytic reports to the **My Analytics** section or the **Tile** repository of all users of the component. For more information, see Publishing the Analytic Report section in *PeopleTools: Pivot Grid*

Note: The buttons **Add to Homepage** and **Publish Options** are displayed only when you view the analytic report on a tablet, Laptop or a large monitor. These buttons are not displayed on a smartphone.

Follow the same steps to create analytic reports for On-Time Delivery Performance and Overdue PO Acknowledgements.

Supplier Watch List – small form factor

In small form factor Supplier list becomes an overlay. When a Supplier is selected, list is dismissed to the left to display event information. Tab must be tapped to bring back Supplier list and select another Supplier.

This example illustrates the fields and controls on the Supplier Watch List – small form factor. You can find definitions for the fields and controls later on this page.

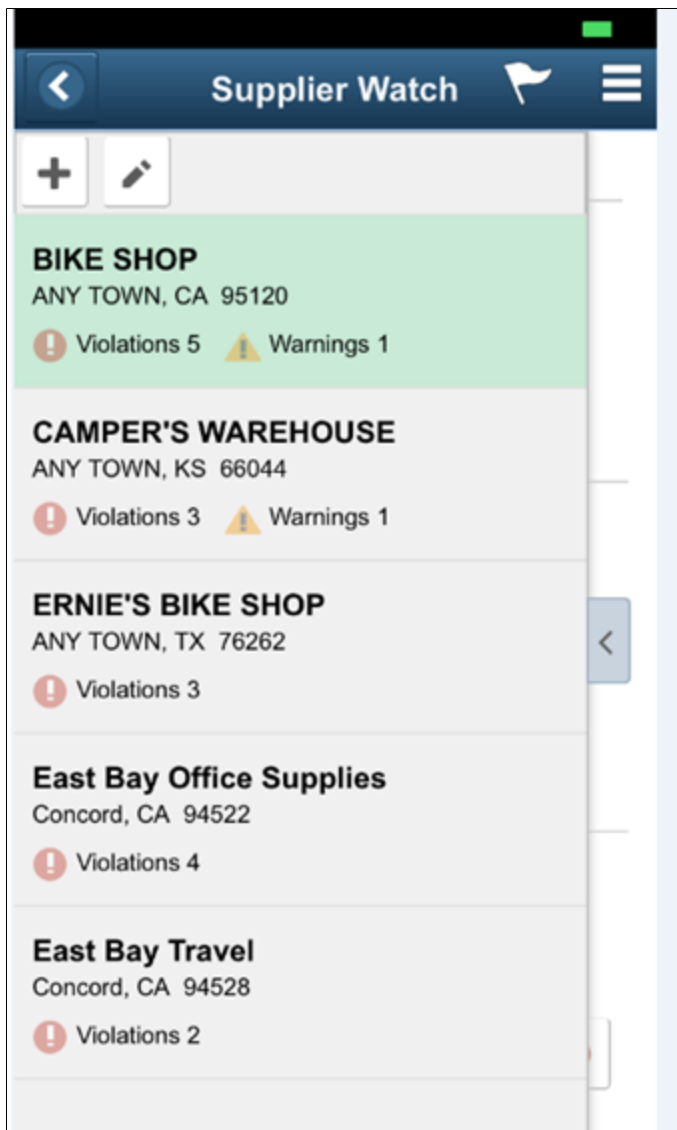

This example illustrates the fields and controls on the Supplier Watch List — small form factor (Page 2 of 2). You can find definitions for the fields and controls later on this page.

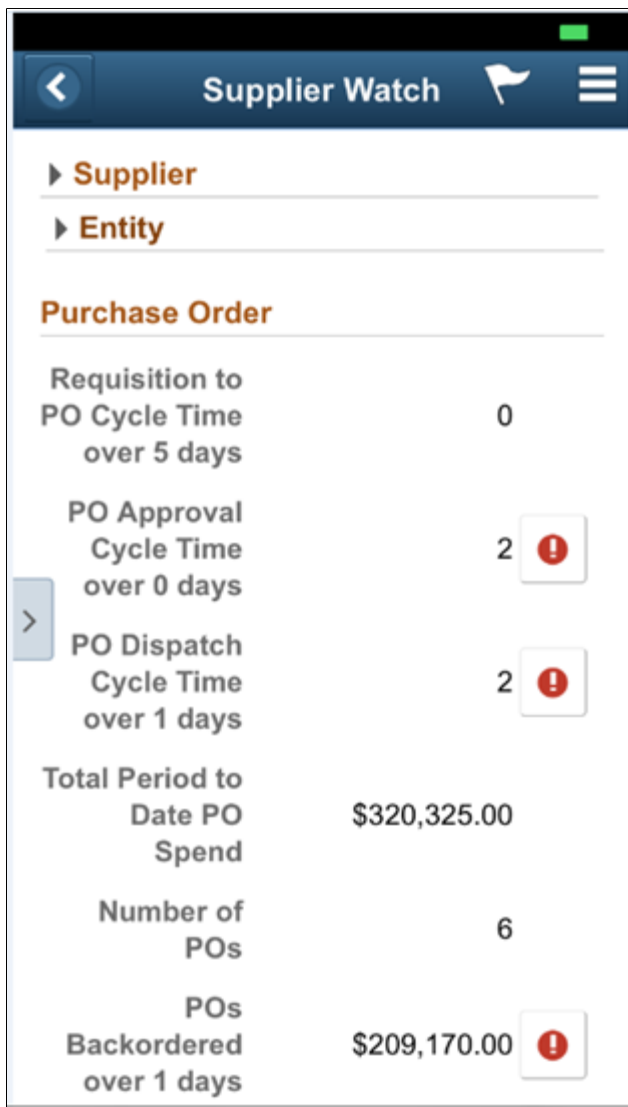

Note: Detail information is shown as list view in small form factor so that user does not need to keep scrolling left and right to view information.

This example illustrates the fields and controls on the Approve PO Details — small form factor Page. You can find definitions for the fields and controls later on this page.

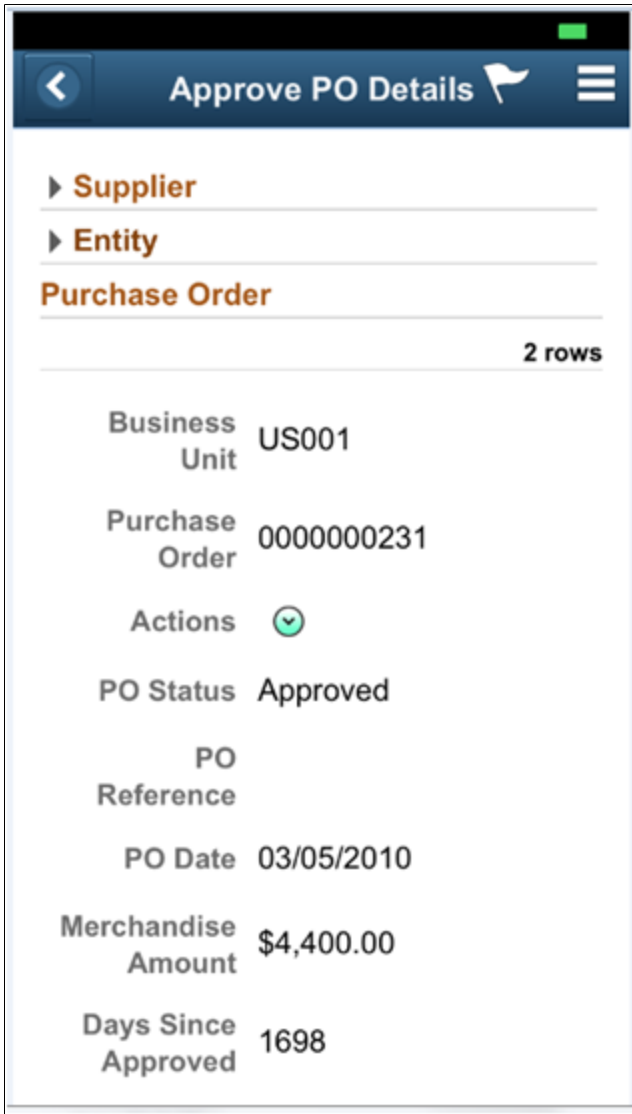

Analyzing Payment Spend with the PeopleSoft Fluid User Interface

Page Used to Analyze Payment Spend

<i>Page Name</i>	<i>Definition Name</i>	<i>Usage</i>
<u>Payment Spend Analysis Page</u>	PTPG_NUI_VWR	Track and analyze paid and expensed spend amounts.

Payment Spend Analysis Page

Use the Payment Spend Analysis page (PTPG_NUI_VWR) to track and analyze paid and expensed spend amounts.

Navigation:

Procurement Operations Home Page > Pymt Spend Analysis tile

This example illustrates the fields and controls on the Payments Spend Analysis page.

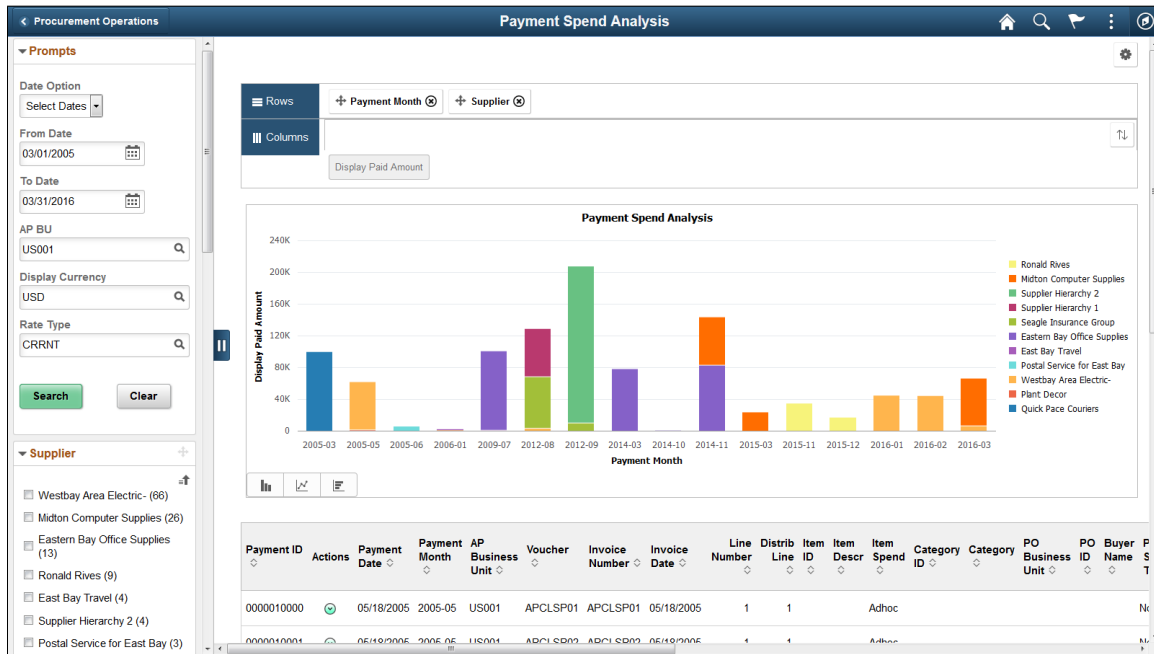

Use the pivot grid to track and analyze paid and expensed spend amounts. The pivot grid enables you to display data in different views by performing operations such as pivoting and filtering. This enables you to interpret data in a variety of ways. Pivots grids are based on PS Queries and can display results in a grid format, a chart format, or both.

You can choose the type of graph you want to use to display your data—including bar, line, and pie charts. Click the bars in a graph (or pie slice) in the pivot grid to view details or drill down by various dimensions.

Use the left panel to modify delivered prompts and filters. Users can select from a range of data using field prompts. You can analyze payments using various facets, such as supplier, business unit, purchase order spend versus non purchase order spend, and so forth.

The Payment Spend Analysis page includes these prompts and filters:

- *Date Option* (30 days, 60 days, 90 days, or Select Dates)
- *From/To Date* (payment date)
- *AP BU* (Accounts Payable Business Unit)
- *Display Currency*
- *Rate Type*

- *Supplier*
- *Payment Month*
- *AP Business Unit* (Accounts Payable Business Unit)
- *Item Spend*
- *Category*
- *PO Business Unit* (Purchasing Business Unit)
- *Buyer Name*
- *PO Spend Type* (Purchase Order Spend Type)
- *Contract Spend Type*

View Grid Option

Use *View Grid* under the Options Menu (cog icon) to modify the layout and analytics of the pivot grid and table by adding or removing prompts and facet values in the grid. The modal window also includes the facet pane on the left. When you click the **Apply** button in the top right of the modal, the chart is refreshed based on the current layout of the grid.

For more information about this option, see product documentation for PeopleTools: Pivot Grid.

Update Filters Option

Use *Update Filters* under the Options Menu (cog icon) to add or remove filters from the left panel of the Payment Spend Analysis page.

For more information about this option, see product documentation for PeopleTools: Pivot Grid.

Chart Options

Use *Chart Options* under the Options Menu (cog icon) to change chart labels, chart axis and layout, and so forth.

For more information about this option, see product documentation for PeopleTools: Pivot Grid.

Threshold Options

Use *Threshold Options* under the Options Menu (cog icon) to configure basic threshold settings for the **Display Paid Amount** column.

For more information about this option, see product documentation for PeopleTools: Pivot Grid.

Using Group Purchasing Organizations

Understanding GPO Contracts

The GPO feature enables you to record and use contract pricing negotiated by group purchasing organizations on behalf of an organization. You can record the GPO contract within the PeopleSoft system by loading the contract and then accepting only the contract items used by the organization. You can use PeopleSoft GPOs to:

- Load contract price and item data from XML or flat files.

The source of the data could be the manufacturer, distributor, or group purchasing organization.

- Select the information from the GPO contract to be used by the organization.

As GPO contract information is loaded, you control the addition of new items, price changes, and new units of measure (UOMs).

- Automatically calculate the distributor price used on the purchase order.

The distributor prices are stored in the item tables and can be recalculated at any time. The distributor price is based on the manufacturer's price plus the distributor markup.

- Run PeopleSoft reports to review items purchased by GPO, GPO contract, manufacturer, or distributor.
- Track contract commitments including multiple levels of pricing tiers based on amount or percentage.
- Review rebates received per GPO contract.

Related Links

[PeopleSoft Purchasing Reports: General Description](#)

Common Elements Used in GPO Contracts

<i>Field or Control</i>	<i>Description</i>
Distributor's Price	This price appears by default from the Supplier's UOM & Pricing Info (suppliers unit of measure and pricing information) page. This is the distributor's price for an item used on the purchase order.
GPO ID (group purchasing organization identifier)	Enter an alphanumeric code to uniquely identify each group purchasing organization.

Field or Control	Description
GPO Contract (group purchasing organization contract) and GPO Contract Number (group purchasing organization contract number)	Enter an alphanumeric code to uniquely identify each contract from a group purchasing organization.
Manufacturer's Price	Enter the price per unit for an item on the Item Manufacturer GPO page.

Defining GPO Contracts

To define manufacturers, GPO manufacturers, rebates, definitions, and distributors, use the Manufacturer (MANUFACTURER), GPO Manufacturer (MFG_GPO), GPO Rebates (MFG_GPO_REBATE), GPO Definition (GPO_NAME), and GPO Distributor (MFG_GPO_SUPPLIER) components.

This section provides an overview of the GPO contract definition process.

Pages Used to Define GPO Contracts

Page Name	Definition Name	Usage
Manufacturer Page	MANUFACTURER	Define each manufacturer of items.
General Information - Identification or Supplier - Identifying Information Page	VNDR_ID1	Define each distributor of GPO contract items as a supplier.
Define GPO Page (define group purchasing organization)	GPO_NAME	Define group purchasing organizations.
<u>Define GPO Manufacturer (define group purchasing organization manufacturer) Page</u>	MFG_GPO	Define GPO contracts.
Tier Requirements	MFG_GPO_REQ	Enter details concerning tier requirements of the GPO contract.
<u>GPO Distributor (define group purchasing distributor) Page</u>	MFG_GPO_SUPPLIER	Enter the GPO contract distributors (suppliers) and their markup percentages.
GPO Rebates (define group purchasing rebates)	MFG_GPO_REBATE	Enter any rebates received for this GPO contract. Update this page whenever a rebate is received against this contract.

Understanding the GPO Contract Definition Process

To define GPO contracts:

1. On the Manufacturer page, define a manufacturer ID for each manufacturer of contract items.
2. Using the Supplier Information component, define each distributor as a PeopleSoft Supplier.

If you can buy directly from the manufacturer of the item, the manufacturer should also be defined as a supplier.

3. On the Define GPO page, define a GPO ID for each group purchasing organization.
4. On the Define GPO Manufacturer page, define each GPO contract with a GPO contract ID and contract details.
5. (Optional) On the Tier Requirements page, identify any tier requirements contained in the GPO contract.
6. On the GPO Distributor page, enter the GPO contract distributors (suppliers) and their markup percentages.
7. (Optional) On the Define GPO Rebates page, enter any GPO contract rebates received.

In PeopleSoft Purchasing, two ways are available to manage vendor rebates for GPO Contracts:

- Manually record the vendor rebates received from the manufacturer using the GPO Rebates page.
This is for reporting purposes only.
- Use the vendor rebate functionality to automatically manage and process vendor rebates for GPO contracts.

If you decide to use the vendor rebate functionality, using the GPO Rebates page to enter vendor rebates is not necessary. The vendor rebates for the GPO contract are managed and processed within the vendor rebate functionality.

Note: The vendor rebates functionality won't copy the vendor rebates back to the GPO Rebates page because the rebates are already managed within the vendor rebates functionality. If you still want to use the GPO Rebates page in addition to the vendor rebate functionality, you can, but you will have to manually update the GPO Rebates page.

Related Links

[Calculating Distributor Prices](#)

[GPO Distributor \(define group purchasing distributor\) Page](#)

[Define GPO Manufacturer \(define group purchasing organization manufacturer\) Page](#)

[Loading GPO Contracts](#)

[“Understanding Supplier Maintenance” \(PeopleSoft Source to Settle Common Information\)](#)

[Understanding Vendor Rebates](#)

Define GPO Manufacturer (define group purchasing organization manufacturer) Page

Use the Define GPO Manufacturer (define group purchasing organization manufacturer) page (MFG_GPO) to define GPO contracts.

Navigation:

Purchasing > GPO Contracts > GPO Manufacturer > Define GPO Manufacturer

<i>Field or Control</i>	<i>Description</i>
Buy from this Manufacturer	Select this check box if you can buy items directly from the manufacturer. The system creates a record on the GPO distributor table for the manufacturer, with default markup of 0.
Supplier ID	<p>Enter the manufacturer's supplier ID if you can buy directly from the manufacturer. If you are using vendor rebate functionality, the system uses this supplier associated with this manufacturer to assign the vendor rebate agreement to a purchase order.</p> <hr/> <p>Note: You must select the Buy from this Manufacturer check box and select a supplier ID for the vendor rebate functionality to be handled correctly for this manufacturer. If you do not specify the manufacturer's supplier ID, you can still optionally manage vendor rebates with the distributor's supplier ID (the supplier on the purchase order).</p> <hr/>
Supplier GLN	Displays the GLN Values.
Committed Contract	Select this check box if you are committed by this contract to purchase a minimum level calculated by amount, by percentage, or both.
Commitment % (commitment percentage)	Enter a percentage if the contract commitment is based on the percentage of overall spending for the organization.
Commit Level Amount	Enter the amount that must be purchased based on the contract commitment.
Contract Tier Level	If the contract's commitments have multiple purchase levels, then enter the contract tier designation (for example, tier 1, tier 2, and so on). Enter the tier pricing that applies to the organization.
Tier Requirements	If the contract commitments have multiple purchase levels, then enter the organization's requirements (for example, amount per year) for the contract tier levels.

Field or Control	Description
More	Click to access the Tier Requirements page. Use that page to document the contract tier levels and their requirements.
Price Expiration Date	Enter the expiration date for the contract pricing.
Maximum % Increase (maximum percentage increase)	Enter a percentage to indicate contractual price change limits. Price increases can be approved on the GPO Item Selection page.
Increase Type	Select the base for the calculation of the price increase percentage. Options are: <ul style="list-style-type: none"> • <i>% of CPI</i>: Percentage of consumer price index. • <i>% of MPI</i>: Percentage of medical price index. • <i>Straight %</i>: Percentage of existing manufacturer price.
Rebate Frequency	If rebates are received per this contract, enter the time period for rebate calculation. Options are: <ul style="list-style-type: none"> • <i>Annual</i>: Rebates are calculated once per year. • <i>Quarterly</i>: Rebates are calculated four times per year. • <i>Sem Annual</i>: Rebates are calculated twice per year.

Related Links

[GPO Item Selection \(group purchasing organization item selection\) Page](#)

[Understanding Vendor Rebates](#)

[Creating Purchase Order Lines](#)

GPO Distributor (define group purchasing distributor) Page

Use the GPO Distributor (define group purchasing distributor) page (MFG_GPO_VENDOR) to enter the GPO contract distributors (suppliers) and their markup percentages.

Navigation:

- **Purchasing > GPO Contracts > Distributor > GPO Distributor**
- Click the **Distributors** link on the Define GPO Manufacturer page.

This page defines the distributors (suppliers) associated with the GPO contract.

Supplier Information

<i>Field or Control</i>	<i>Description</i>
Priority	Enter the supplier's priority number to identify primary, secondary, and tertiary distributors. Use the insert-row feature to add as many distributors as needed.
Supplier GLN	Displays the GLN Values. Note: In this page the Supplier GLN field does not change dynamically since the field is added in the grid.

Price/Contract Info

Select the Price/Contract Info tab.

<i>Field or Control</i>	<i>Description</i>
Markup % (markup percentage)	Enter the markup percentage that the system applies to the manufacturer's price to create the distributor purchase price.
Contract ID	Select any standard contract opened for this supplier. Purchases can be reported against both a GPO contract and a standard contract.

Loading GPO Contracts

This section provides an overview of the load GPO contracts process and health care unit-of-measure conversion.

Pages Used to Load GPO Contracts

<i>Page Name</i>	<i>Definition Name</i>	<i>Usage</i>
Data Def Maint Page (data definition maintenance)	EO_EIP_CTL_MAINT	Review the enterprise integration point results for the GPO Manufacturer Price Load, GPO Distributor Price Load, and Item Loader processes.
GPO Load Maintenance Page (group purchasing organization load maintenance)	GPO_LOAD_MAINT	View a detail entry of the transaction enterprise integration point.

Page Name	Definition Name	Usage
<u>GPO Item Load Errors (group purchasing organization item load errors) Page</u>	GPO_ITM_EC	Correct any errors in the load process.
<u>GPO Item Selection (group purchasing organization item selection) Page</u>	GPO_ITM_SELECT	Review and update any price changes, new items, or new units of measure. Approval is required to load this data.
Units of Measure Page	UNITS_OF_MEASURE	Enter any new units of measure loaded with the GPO contract.
<u>GPO Load Manufacturer Price (group purchasing organization load manufacturer price) Page</u>	RUN_GPO_MFG_PRICE	Run the GPO Manufacturer Price Load process to load the manufacturer prices from the GPO Staging table into the item loader staging tables.
GPO Load Distributor Price Page(group purchasing organization load distributor price)	RUN_GPO_VNDR_PRICE	Run the GPO Distributor Price Load process to load distributor prices to the item loader staging tables. This process calculates the distributor price by increasing the manufacturer's price by the markup percentage from the GPO Distributor page.
Item Loader Data Maintenance Page	IN_EIP__ITEM_MAINT	Access the Item Manufacturer GPO Errors page.
<u>Item Mfg GPO Errors (item manufacturing group purchasing organization errors) Page</u>	IN_EIPITM_MFG_GPO	Correct any errors in the item loader staging tables before running the Item Loader process.
Item Loader Page	RUN_IN_ITMLOAD	Run the Item Loader process, which loads the PeopleSoft application tables with the data in the item loader staging tables.
<u>Item Manufacturer GPO (item manufacturer group purchasing organization) Page</u>	ITM_MFG_GPO	View the manufacturer's price for the item. The price is stored by a combination of SetID, item ID, UOM, manufacturer ID, GPO ID, GPO contract number, and currency.

Understanding the Load GPO Contracts Process

You can automatically load GPO contract prices into the PeopleSoft system. The data can be in the form of an XML file or a flat file. The GPO contract prices can be received directly from the GPO, the manufacturer, or the distributor.

Note: When the PeopleSoft system receives a transmission from a supplier, manufacturer, or distributor that uses the 832 Price List Load process, the system recognizes keys other than the PeopleSoft system item ID. These keys include the supplier item ID for the supplier on the transmission, manufacturer item ID for a manufacturer, or universal product number (UPN ID). If the system does not find an item ID for any of the keys, it automatically assigns a new item ID for the item.

See “Running the Item Loader Process” (PeopleSoft Managing Items).

When GPO contract prices are loaded:

- The manufacturer's price is inserted into the price per unit field on the Item Manufacturer GPO page.
- (Optional) The item's standard price on the Purchasing Attributes page is updated with the manufacturer's price.

Prices are loaded into the manufacturer item price tables.

- New items are added that do not currently exist in the item master tables.

These new items must be approved through the GPO Item Selection page.

Units of measure and conversion rates appear on the GPO Item Selection page for approval. If the unit of measure is not defined in the PeopleSoft system, you must add it manually using the Units of Measure page.

To load GPO contracts:

1. Confirm that the GPO contract has been defined.

See [Defining GPO Contracts](#).

2. Verify that the file contains the required data fields (SetID, Manufacturer ID, Manufacturer Item ID, GPO Contract Number, UOM, Price, and Price Effective Date).
3. Process the enterprise integration point (EIP) for GPO contracts.

The data is now stored in the GPO Staging table (GPO_ITM_EC).

4. After this process is finished, you can check for errors by reviewing the Data Definition Maintenance page.

If errors occurred, click the Show Detail Entry buttons to access the GPO Item Load Error page where you can correct the data.

See [Item Mfg GPO Errors \(item manufacturing group purchasing organization errors\) Page](#).

5. Use the GPO Item Selection page to approve items and prices to load, to approve new items, and to approve new units of measure.

Only items marked as approved create item loader staging records. To approve, select the row and save the page. For items that currently do not exist in the PeopleSoft system, enter an item category in the category code field. This enables the system to find necessary default data for the new item. Add any new units of measure using the Units of Measure page.

See [GPO Item Selection \(group purchasing organization item selection\) Page](#).

6. Run the GPO Manufacturer Price Load Application Engine process (PO_GPOMFG_PR) to load the manufacturer prices from the GPO Staging table into the Item Loader staging tables.

See [GPO Load Manufacturer Price \(group purchasing organization load manufacturer price\) Page](#).

7. Run the Item Loader process to put the data in the PeopleSoft production tables.

On the Item Loader process page, select the **Item Mfg GPO** (item manufacturing group purchasing organization) option for the item load type.

8. When the Item Loader process is complete, you can view the manufacturer prices on the Item Manufacturer GPO page.

See [Item Manufacturer GPO \(item manufacturer group purchasing organization\) Page](#).

9. (Optional) Run the GPO Distributor Price Load Application Engine (PO_GPO_SUP_PR) process to load distributor prices into the Item Loader staging tables. (Manufacturer prices should be in the production tables before you run the GPO Distributor Price Load process.)

See [Calculating Distributor Prices](#).

10. Run the Item Loader process again.

This time the Item Loader process populates item and supplier tables with prices.

This diagram illustrates the data flow for loading GPO contract data:

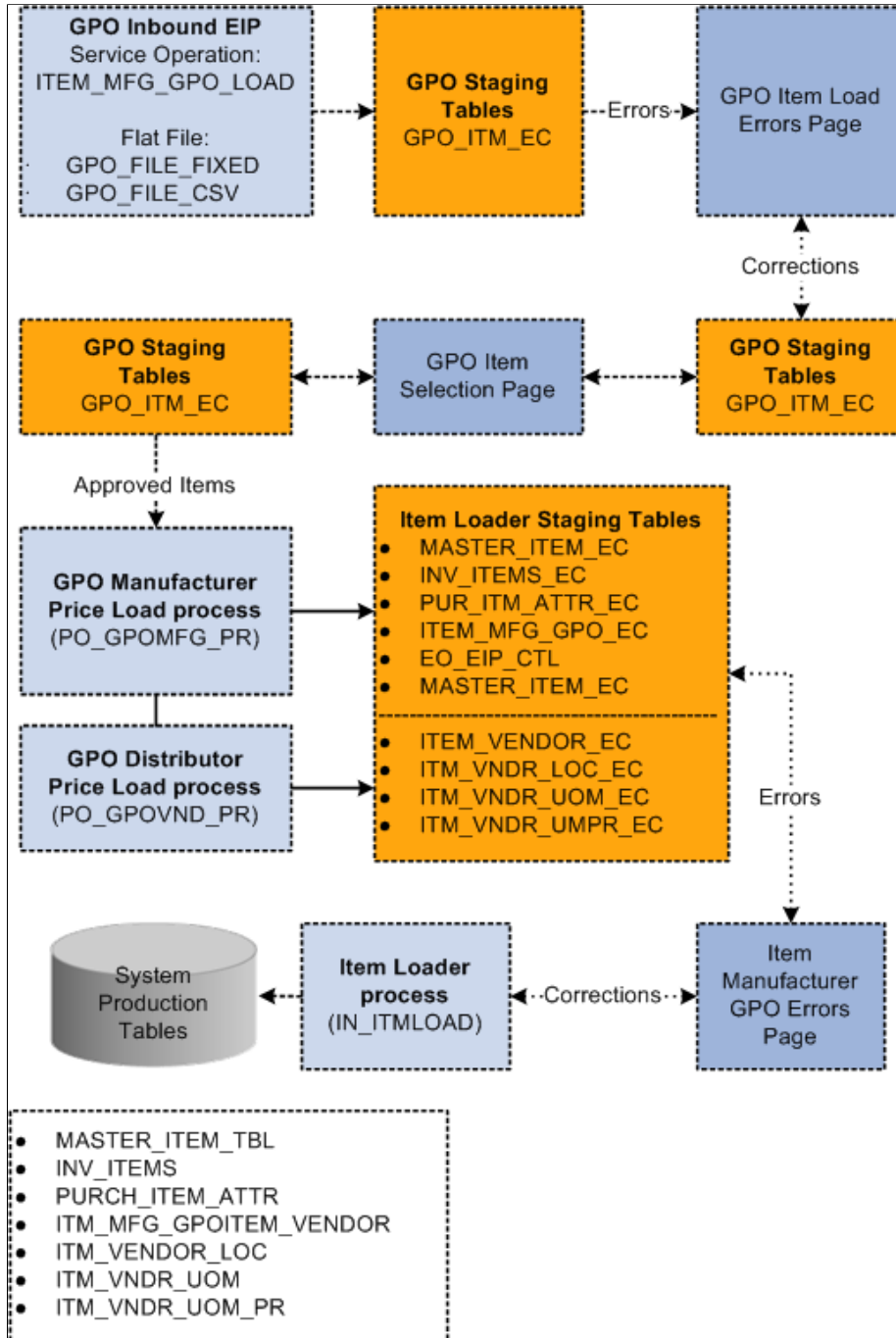

Understanding Health Care Unit-of-Measure Conversion

Unlike the retail industry, which tracks point-of-sale data, health care providers need to capture usage data on units-of-use dispensed or applied at the point of care or point of use. Most medical products are packaged and sold in units of measure that primarily meet supply and replenishment needs, not point-of-use needs. Even in the replenishment process, the critical factor in meeting inventory needs and determining unit cost is validating the quantity of product units within a package.

A standard, unique unit-of-measure code for the unit of use provides more accurate usage tracking and establishes a basis for accurately measuring the quantity of products in a package. Unique health care UOMs also facilitate the update of price lists and item catalogs that the system transmits using electronic data interchanges or XML.

You can define the conversion between units of measure for inbound messages using the XML Mapper for UOMs. To set up mapping details for health care UOMs:

1. Add specific health care-related units of measure.
 - a. Access the Units of Measure page by selecting **Setup Financials/Supply Chain > Common Definitions > Units of Measure.**
 - b. Add a new or select an existing unit of measure for which you want to define health care-related UOMs.
 - c. Assign a default conversion rate between an UOM and a system unit of measure
 The system automatically calculates the inverse conversion rate.

2. Establish the translation between UOMs for inbound messages using XML Mapper.

XML Mapper enables you to map values between a database and an external trading partner database.

- a. Access the Define Map page by selecting **SCM Integrations > XML Mapper > Define Maps.**
 See “Implementing XML Mapper” (PeopleSoft Supply Chain Management Integration).
- b. Select Map ID EXTERNAL_UOM, then select the Map Details tab.

You use the tab to specify the map type detail. This includes mapping health care UOMs in inbound messages to system values.

This table describes the common use of health care units of measure:

<i>Unit of Measure</i>	<i>Definition</i>
Bag (BG)	A container in the form of a sack or pouch that is made from a flexible material, such as paper or plastic, for transporting and dispensing a portion of its contents. Contents can be individually packaged or subpackaged in, for example, packs, vials, or bottles.
Bottle (BO)	A medium-sized glass or plastic receptacle with an attached lid to contain and dispense a portion of its solid contents as needed.
Box (BX)	A small to midsized container in the form of a rectangular box made of cardboard that is used to enclose a smaller quantity of similar contents within a case or carton. Within a box, contents can be individually packaged or subpackaged, such as in a pack, bag, vial, or bottle.

Unit of Measure	Definition
Case (CA)	A large container in the form of a rectangular box used to protect a quantity of similar contents to be transported. Contents can be individually packaged or subpackaged, such as in a box, carton, or bottle.
Cassette (CS)	A small to midsized container in the form of a rectangular box that is used to enclose and transport a smaller quantity of dissimilar pharmaceutical products within a health care facility. Cassette is not commonly used as a packaging UOM in medical and surgical products. Instead, CS and CA (case) are used interchangeably.
Carton (CT)	A small to midsized container in the form of a rectangular box made of thin cardboard used to enclose a smaller quantity of similar contents within a case. Multiple cartons are in a case. Within a carton, contents can be individually packaged in smaller units.
Centimeter (CM)	Length (Centimeter (CM), Foot (FT), Inch (IN), Meters (M), Millimeter (MM), Yard (YD)) - A smaller unit of measure used as a dimensional unit to identify length.
Container (CN)	An enclosure in which a quantity of similar products and or materials are stored or contained.
Crate (CP)	A wooden or synthetic enclosure that protects multiple packages or a single piece of equipment.
Dozen (DZ)	A box that is used to enclose a smaller quantity of similar suture products within a box. Within a dozen, the quantity of sutures is 12 each. Dozen is used only with suture products.
Drum (DR)	A large container of a single product that is used to package a product for transporting. A product is typically a liquid that is measured in a sub-UOM of gallons such as a 55-gallon drum.
Each (EA)	An individual, single package in a quantity of <i>one</i> that comprises quantity counts of all larger packages.
Foot (FT)	Length (Centimeter (CM), Foot (FT), Inch (IN), Meters (M), Millimeter (MM), Yard (YD)).
Gallon (GA), Liter (LT), Quart (QT), and Pint (PT)	A larger unit of volume or capacity that is used to measure or contain and transport liquids.
Gram (GM)	Weight (Pound (LB), Gram (GM), Kilogram (KG), Milligram (ME)) - A smaller unit of measure that is used as a dimensional unit to identify weight.

Unit of Measure	Definition
Gross (GR)	A small to midsized container in the form of a rectangular box or tray made of cardboard that is used to enclose a smaller quantity of similar contents. Within a gross, the quantity of contents is defined at 144.
Inch (IN)	Length (Centimeter (CM), Foot (FT), Inch (IN), Meters (M), Millimeter (MM), Yard (YD)) - A smaller unit of measure that is used as a dimensional unit to identify length.
Jar (JR)	A large-sized glass or plastic receptacle with an attached lid to contain and dispense a portion of its contents as needed.
Kilogram (KG)	Weight (Pound (LB), Gram (GM), Kilogram (KG), Milligram (ME)) - A smaller unit of measure that is used as a dimensional unit to identify weight.
Kit (KT)	A packaged set of related (not similar) products that is used in performing a procedure or test, such as an IV start kit. Multiples are never in a kit. You do something with a kit.
Meter (M)	Length (Centimeter (CM), Foot (FT), Inch (IN), Meters (M), Millimeter (MM), Yard (YD)) - A smaller unit of measure that is used as a dimensional unit to identify length.
Milligram (ME)	Weight (Pound (LB), Gram (GM), Kilogram (KG), Milligram (ME)) - A smaller unit of measure that is used as a dimensional unit to identify weight.
Milliliter (ML)	Volume (Ounce (OZ), Milliliter (mil)) - A smaller unit of measure that is used as a dimensional unit to identify volume.
Millimeter (MM)	Length (Centimeter (CM), Foot (FT), Inch (IN), Meters (M), Millimeter (MM), Yard (YD)) - A smaller unit of measure that is used as a dimensional unit to identify length.
Ounce (OZ)	Volume (Ounce (OZ), Milliliter (mil)) - A smaller unit of measure that is used as a dimensional unit to identify volume.
Pack (PH)	Pack (PH) - A small package made of paper or plastic containing a predetermined number (1 through 10) of identical products packaged for dispensing the entire contents.
Package (PK)	An intermediate level of packaging that is normally used interchangeably within the medical supply chain with Box (BX).

Unit of Measure	Definition
Pair (PR)	An each consisting of two products, similar in form or function and matched or associated, such as a pair of gloves or shoes.
Pallet (PLT)	A portable platform for moving cargo or freight such as a case, carton, or box.
Piece (PC)	A UOM identifying and counting disparate (not identical) product units within the smallest Unit of Packaging.
Parts (N7)	A descriptor that indicates that the package contains dissimilar pieces, packages, or product units assembled for a particular application or list of pieces needed to meet a prescribed need.
Pound (LB)	Weight (Pound (LB), Gram (GM), Kilogram (KG), Milligram (ME)) - A smaller unit of measure that is used as a dimensional unit to identify weight.
Ream (RM)	A packaging unit for multiple sheets of a given paper good packaged for transporting. The contents level would contain the quantity of the contents with a UOM of SH.
Roll (RL)	A packaging unit in which a product is rolled up in the form of a cylinder, such as a roll of tape.
Set (ST)	A group of products of the same kind (not alike) that belong together and are so used, such as surgical knives. A procedure or test cannot be performed solely with a set.
Sheet (SH)	A piece of paper product, such as copy paper or labels.
Tray (TY)	A flat, shallow receptacle with a raised edge or rim used for carrying, holding, or displaying its contents. In health care, it is used to transport and dispense a portion of its contents as needed.
Tube (TB)	A small, flexible, cylindrical container sealed at one end and having a screw cap at the other.
Unit (UN)	A unit-of-use or dimensional unit of measure for product counts within the smallest Unit of Packaging.
Vial (VI)	A small-sized glass or plastic receptacle with an attached lid to contain and dispense a portion of its liquid contents as needed.

Unit of Measure	Definition
Yard (YD)	Length (Centimeter (CM), Foot (FT), Inch (IN), Meters (M), Millimeter (MM), Yard (YD)) - A smaller unit of measure that is used as a dimensional unit to identify length.

Loading GPO Data Using PeopleSoft Integration Broker

Use the service operation ITEM_MFG_GPO_LOAD to load the GPO contract data into the GPO Staging table (GPO_ITM_EC). This inbound service operation performs the basic validation and assigns the default values.

Before you can use the ITEM_MFG_GPO_LOAD EIP, you must set up the service operation within PeopleSoft Integration Broker and Enterprise components.

Use the information in the following table and refer to the setup instructions in the *PeopleSoft Supply Chain Management Integration 9.2 Documentation*.

Service Operation	Direction and Type	Handlers	Chunking Available	Integration With
ITEM_MFG_GPO_LOAD	Inbound Asynchronous	ITEM_MFG_GPO_LOAD	No	third-party system

Note: To load a flat file, use the PeopleSoft data integration utilities for mapping. For loading flat files into the service operation, use the Inbound File Publish Application Engine process (EOP_PUBLISHF).

Service Operation Fields

The service operation contains these fields:

SET ID	Required
MANUFACTURER ID	Required
MANUFACTURER ITEM ID	Required
GPO CONTRACT NUMBER	Required
GPO ID	Optional
ITEM DESCRIPTION	Optional
MANUFACTURER ITEM CATEGORY	Optional

SET ID	Required
UOM	Required
CONVERSION RATE	Optional
BASE UNIT OF MEASURE	Optional
PRICE	Required
CURRENCY	Optional
PRICE EFFECTIVE DATE	Required
PRICE EXPIRATION DATE	Optional

See the product documentation for *PeopleTools: Integration Broker*

Related Links

“Setting Up Service Operations” (PeopleSoft Supply Chain Management Integration)

“PeopleSoft SCM Inbound EIPs” (PeopleSoft Supply Chain Management Integration)

“PeopleSoft SCM Inbound EIPs” (PeopleSoft Supply Chain Management Integration)

GPO Item Load Errors (group purchasing organization item load errors) Page

Use the GPO Item Load Errors (group purchasing organization item load errors) page (GPO_ITM_EC) to correct any errors in the load process.

Navigation:

Click the **GPO Details** button on the GPO Load Maintenance page.

After the EIP process is finished, you can check for errors by reviewing the Data Definition Maintenance page. If errors occurred, access the GPO Item Load Error page, where you can correct the data.

Common errors include missing data and data that could not be validated in the PeopleSoft system, such as an incorrect manufacturer ID. The data displayed is located in the GPO Staging table (GPO_ITM_EC). Use this page to correct data or add missing information.

GPO Item Selection (group purchasing organization item selection) Page

Use the GPO Item Selection (group purchasing organization item selection) page (GPO_ITM_SELECT) to review and update any price changes, new items, or new units of measure.

Approval is required to load this data.

Navigation:

- **SCM Integrations > Create Transactions > GPO Item Selection**
- Click the **GPO Item Selection** link on the GPO Load Maintenance page.

Use the GPO Item Selection page to approve the items for loading into the PeopleSoft system. This page displays the items in the GPO staging table that do not have an error status. When you approve a line, the approval flag is set to *Yes*. Only lines that you approve on this page are available for further processing. This approval step exists for a number of reasons. The approval step enables you to:

- Select items for the organization.

Group purchasing organizations may send pricing information for many items that are not purchased by the organization. Use this page to approve the items to load into the PeopleSoft tables.

- Add new items in PeopleSoft software.

Occasionally, an item appears that does not currently exist in the PeopleSoft item tables. To add this item to the PeopleSoft system, enter an item category code and approve the item.

- Review current and effective-dated pricing for the items displayed.

Prices displayed on this page are loaded into the PeopleSoft system only if the line is approved.

- Review new units of measure.

Units of measure that do not currently exist in the PeopleSoft system must be manually added to the Units of Measure page, then approved on this page.

- Verify or change the conversion rate.

To review and approve an item:

1. Enter values in the **SetID**, **Manufacturer ID**, **GPO ID**, and **GPO Contract** fields.

These are required entries before you initiate a search.

2. (Optional) Select a manufacturer (item) category.

If you are loading a large GPO contract, selecting a manufacturer (item) category can reduce the display to a reasonable size.

3. (Optional) Use the **Item Selection** field to narrow the search to lines with or without PeopleSoft item IDs.

Users can select items without a PeopleSoft item ID. This feature enables users to identify and update items that need additional information to pass through the Item Loader process without error.

4. Click the **Search** button.

The system displays the data that matches the search criteria in the **Item Details** group box.

5. To approve an item, select the **Sel** check box and click the **Approve** button.

The **Select All** link enables you to quickly select all displayed items.

Field or Control	Description
SetID ,Manufacturer ID, andGPO ID (group purchasing organization ID)	Select values that you want to use to search for GPO contract items. These fields are required for the search. When you enter values for the fields, a correlation must exist among the entries. For example, a GPO ID must have been created for the SetID and manufacturer ID combination to be available for input in the GPO ID field.
GPO Contract (group purchasing organization contract)	Select a GPO contract. GPO contracts enable you to record and use contract pricing negotiated by group purchasing organizations on behalf of an organization. You can record the GPO contract within the PeopleSoft system by loading the contract and then accepting only the contract items used by the organization. A contract must have been created for the SetID, Manufacturer ID, and GPO ID combination to be available for the GPO Contract field.
Manufacturer Category	Select a category. The manufacturer category is the manufacturer's category for the item.
Item Selection	Select the type of contract item search results that you want to display in the Item Details grid box. Values include: <i>Show Items with Item ID:</i> Select to view only those items with item IDs. <i>Show Items with no Item ID:</i> Select to view only items that do not have an item ID. When you select this value, the system makes the Item ID field unavailable for entry. <i>Show all Items:</i> Select to view all item IDs.
Item ID	Select an item ID or a range of item IDs. The system provides operands for you to limit the search. For example, you can search for a single item or search for all items between item 200000 and item 200020. This field is available when you select <i>Show all Items</i> or <i>Show Items with Item IDs</i> in the Item Selection field.
Manufacturer Item ID	Select a manufacturer item ID or range of IDs that you want to include in the search criteria. The system uses the values in the GPO_ITM_EC record for the search.
Description	Select a description on which to base the search.
Search	Click to search for contract items that match the selection criteria that you entered.

Field or Control	Description
Category	Select an item category code that you want to apply to multiple rows of data in the Item Details grid. After selecting a category, click the Apply Category Code button to place the code in the Category Code column for the rows of data that you select using the Sel check box.
Apply Category Code	Click to apply the category code that you entered in the Category field to the rows of data that you have selected in the Item Details grid.

Item

Select the Item tab.

Field or Control	Description
Sel (select)	Select to indicate that you want the selected rows of data to either be approved when you click the Approve button or have the category code applied in the Category Code column when you click the Apply Category Code button.
Approved	Appears as selected when the Sel check box has been selected for a row and the row is approved. The system validates the items and updates the selected items to approved. After the lines are approved, the rows are unavailable for entry and you cannot make further changes to the approved lines.
Mfg Category (manufacturing category)	Displays the manufacturer's item category from the GPO price list.
Mfg Item ID (manufacturing item ID)	Displays the manufacturer item ID.
Item ID	Displays this check box to include this item.
Description	Displays the item information that has been loaded from message data.
Category Code	Enter the code that represents a specific category code. Category codes are user-defined codes that you customize to handle the tracking and reporting requirements of your organization. When you save the page, the system saves the category codes on the GPO_ITM_EC record. If a category already exists on the record, the system overrides the existing value.

Field or Control	Description
UOM (unit of measure)	Displays how the item is measured.
Base UOM (base unit of measure)	Enter the base unit of measure by which this item is measured.
Conversion Rate	Enter a conversion factor by which you want to convert one UOM to another. A UOM conversion changes the way that an item is measured. To do this, the system uses a conversion factor. This is a number or factor that is applied to a quantity with one UOM to convert it to a quantity with another UOM.

Price

Select the Price tab.

Field or Control	Description
Price Per Unit	Displays the price per unit retrieved from the transmission message.
Currency Code	Displays the currency code used with this GPO item.
Current price per unit	Enter the current unit price. If this item and supplier combination already exists, the system populates the Current price per unit field with the current item supplier price for the UOM. This provides a quick comparison of the price change.
Price Effective Date	Displays the date on which this GPO item price is effective. The system uses the value from the transmission message to populate the field.
Price Expiration Date	Displays the date on which this GPO item price expires. The system uses the value from the transmission message to populate the field.

GPO Load Manufacturer Price (group purchasing organization load manufacturer price) Page

Use the GPO Load Manufacturer Price (group purchasing organization load manufacturer price) page (RUN_GPO_MFG_PRICE) to run the GPO Manufacturer Price Load process to load the manufacturer prices from the GPO Staging table into the item loader staging tables.

Navigation:

SCM Integrations > Process Transactions > Items > GPO Load Manufacturer Price

This process populates the Item Loader staging tables that are required for supplying the manufacturer price. The tables populated include:

- EO_EIP_CTL
- MASTER_ITEM_EC
- INV_ITEMS_EC
- PUR_ITM_ATTR_EC
- INV_ITEM_UOM_EC
- ITEM_MFG_GPO_EC

The process also loads the item loader staging record, ITEM_MFG_GPO_EC.

<i>Field or Control</i>	<i>Description</i>
Update Standard Purchase Price	Select to insert the manufacturer's price (from the external file) as the standard price in the Purchasing Attributes table (PUR_ITM_ATTR_EC).

When you run the item loader again, the loader updates these tables:

- MASTER_ITEM_TBL
- INV_ITEMS
- PURCH_ITEM_ATTR
- ITEM_MFG
- ITEM_MFG_GPO
- INV_ITEM_UOM

Item Mfg GPO Errors (item manufacturing group purchasing organization errors) Page

Use the Item Mfg GPO Errors (item manufacturing group purchasing organization errors) page (IN_EIPITM_MFG_GPO) to correct any errors in the item loader staging tables before running the Item Loader process.

Navigation:

Click the **Item Mfg GPO** link on the Item Loader Data Maintenance page.

Use this page to correct errors after prices have been loaded for manufacturers and distributors. Corrections entered here will be entered into the Item Loader Staging tables.

See [GPO Load Manufacturer Price \(group purchasing organization load manufacturer price\) Page](#).

See [GPO Load Distributor Price \(group purchasing organization load distributor price\) Page](#).

Item Manufacturer GPO (item manufacturer group purchasing organization) Page

Use the Item Manufacturer GPO (item manufacturer group purchasing organization) page (ITM_MFG_GPO) to view the manufacturer's price for the item.

The price is stored by a combination of SetID, item ID, UOM, manufacturer ID, GPO ID, GPO contract number, and currency.

Navigation:

Items > Define Items and Attributes > Define Item > General

Click the **Manufacturers** link on the Define Item - General page.

Click the **GPO Pricing** link on the Manufacturer's Item page.

<i>Field or Control</i>	<i>Description</i>
Price Per Unit	Displays the manufacturer's price. This price can be loaded from an external file or manually updated. The manufacturer's price is increased by the distributor's markup percentage to obtain the purchase price.

Calculating Distributor Prices

This section provides an overview of calculating distributor prices and discusses how to run the GPO Distributor Price Load Application Engine process (PO_GPOVND_PR).

Pages Used to Calculate Distributor Prices

<i>Page Name</i>	<i>Definition Name</i>	<i>Usage</i>
GPO Distributor Page(group purchasing organization distributor)	MFG_GPO_VENDOR	Enter or change the GPO contract distributors (suppliers) and their markup percentages.
Item Manufacturer GPO Page(item manufacturer group purchasing organization)	ITM_MFG_GPO	Store the manufacturer's price for the item.

Page Name	Definition Name	Usage
GPO Load Distributor Price Page(group purchasing organization load distributor price)	RUN_GPO_VNDR_PRICE	Run the GPO Distributor Price Load process, which calculates distributor prices and loads them into the item loader staging records to update supplier prices for distributors associated with a GPO contract.
“Item Loader Page” (PeopleSoft Managing Items)	RUN_IN_ITMLOAD	Run the Item Loader process to load the PeopleSoft application tables with the data in the Item Loader staging tables.
Supplier's UOM & Pricing Info Page	ITM_SUPPLIER	Store the distributors price for the item. This is the price used on the purchase order.

Understanding Calculating Distributor Prices

The distributor price is critical because it is used to price the items on the purchase order. These prices are stored in the **Price** field on the Supplier's UOM & Pricing Info page. The distributor price is the manufacturer's price plus the distributor markup from the GPO Distributor page.

See [GPO Distributor \(define group purchasing distributor\) Page](#).

Multiple distributor prices can be derived from one manufacturer's price. The Supplier's UOM & Pricing Info page is also updated with the current units of measure and conversion rates. The manufacturer appears by default as the primary manufacturer for the item.

The distributor price should be recalculated when:

- GPO contracts are loaded.
- Distributor markups are changed.
- GPO contracts are manually entered or changed.

To calculate distributor prices:

1. Add or change the pricing data by loading a GPO contract or manually entering data on the Item Manufacturer GPO page and the GPO Distributor page.

See [Item Manufacturer GPO \(item manufacturer group purchasing organization\) Page](#).

See [GPO Distributor \(define group purchasing distributor\) Page](#), [GPO Load Manufacturer Price \(group purchasing organization load manufacturer price\) Page](#).

2. Run the GPO Distributor Price Load process to calculate the distributor prices.

This process populates the Item Loader Staging tables.

See [GPO Load Distributor Price \(group purchasing organization load distributor price\) Page](#).

- Run the Item Loader process to put the distributor price data in the PeopleSoft production tables.

On the Item Loader process page, select the **Item Mfg GPO** option for the item load type. When the process is complete, you can view the distributor prices on the Supplier's UOM & Pricing Info page.

This diagram illustrates the data flow for calculating GPO distributor prices:

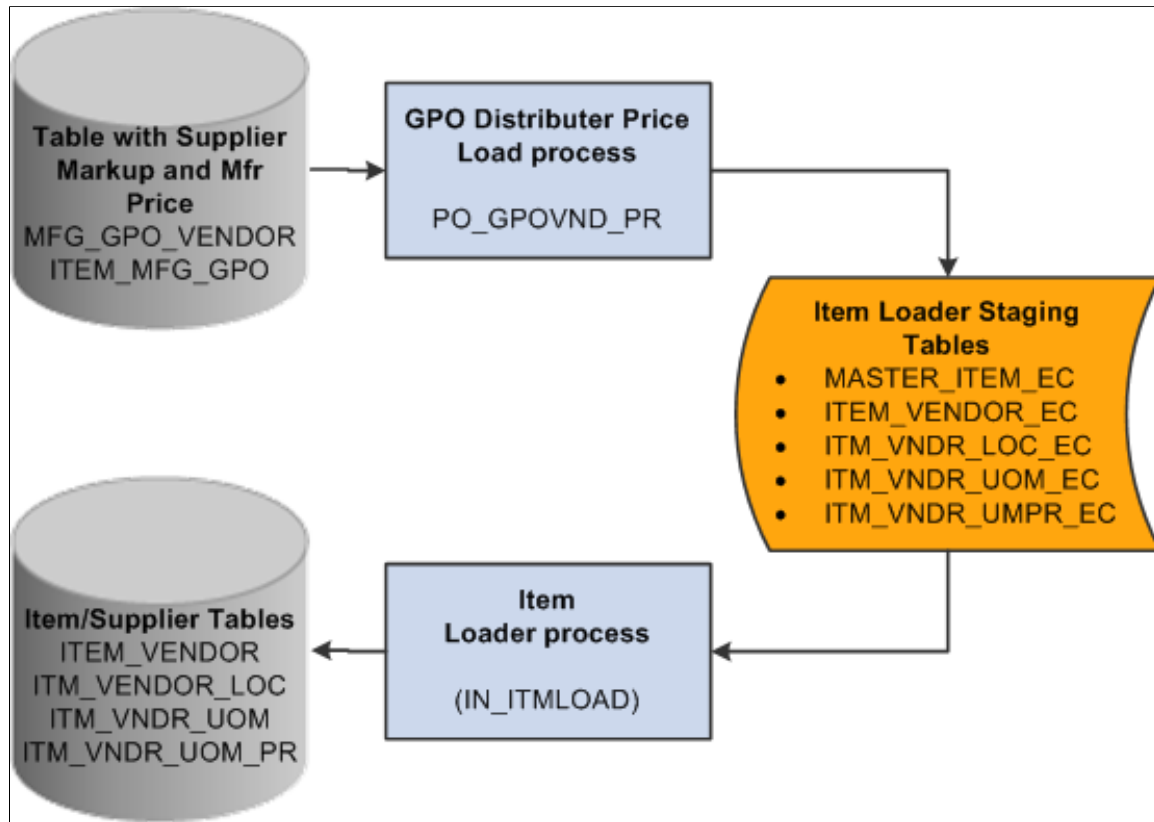

GPO Load Distributor Price (group purchasing organization load distributor price) Page

Use the GPO Load Distributor Price (group purchasing organization load distributor price) page (RUN_GPO_VNDR_PRICE) to run the GPO Distributor Price Load process, which calculates distributor prices and loads them into the item loader staging records to update supplier prices for distributors associated with a GPO contract.

Navigation:

SCM Integrations > Process Transactions > Items > GPO Load Distributor Price

This process calculates the distributor price by increasing the manufacturer's price by the markup percentage from the GPO Distributor page. Use the controls on this page to determine parameters for the distributor (supplier) prices that you want to load.

See [GPO Distributor \(define group purchasing distributor\) Page](#).

The process stores data in these item staging tables:

- EO_EIP_CTL

- MASTER_ITEM_EC
- ITEM_VENDOR_EC
- ITM_VNDR_LOC_EC
- ITM_VNDR_UOM_EC
- ITM_VNDR_UMPR_EC

After you run the Distributor Price Load process, you should run the Item Loader process to put item and supplier prices into production tables. Tables populated by Item Loader process for distributor prices include:

- ITM_VENDOR_LOC,
- ITM_VNDR_UOM
- ITM_VNDR_UOM_PR

<i>Field or Control</i>	<i>Description</i>
Supplier SetID, Short Supplier Name, and Supplier ID	(Optional) Select these fields to limit the processing to a particular supplier.
Override With Date	By default, the system creates prices with the effective date equal to the manufacturer price effective date. To make prices effective on another date, select the Override With Date option and specify the effective date.

(USF) Using Federal Spending Regions

Understanding Federal Spending Regions

The Federal Government uses spending regions to track procure-to-pay activities by area or region. Spending regions are typically established by the procurement manager or accounts payable manager who is responsible for monitoring the procure-to-pay activities of the organization. Use the spending regions functionality to capture the appropriate region for both purchase order and voucher transactions. Spending regions are identified with a ChartField and its values are associated with a supplier's remit-to address.

Defining Federal Spending Regions

This section discusses how to define spending regions.

Page Used to Define Federal Spending Regions

<i>Page Name</i>	<i>Definition Name</i>	<i>Usage</i>
<u>Spending Region Install Option Page</u>	SPNDNG_REG_INST	Establish the ChartField that is used to identify spending regions.

Spending Region Install Option Page

Use the Spending Region Install Option page (SPNDNG_REG_INST) to establish the ChartField that is used to identify spending regions.

Navigation:

Set Up Financials/ Supply Chain > Product Related > Procurement Options > Federal Spending Region > Spending Region Installation > Spending Region Install Option

This example illustrates the fields and controls on the Spending Region Install Option page. You can find definitions for the fields and controls later on this page.

Spending Region Chartfield

<i>Field or Control</i>	<i>Description</i>
Spending Region	Select a valid ChartField as the spending region element.

Purchasing/Accts. Payable Edit (Purchasing and Accounts Payable Edits)

Determine how the system responds if a transaction uses a spending region value that is not associated with a given supplier. When edits and transactions are not valid, you receive a warning message.

<i>Field or Control</i>	<i>Description</i>
No Edit	Select when an edit is not required. If you do not select a purchasing or accounts payable edit, the system uses this as the default value.
Required	Select if required to enter and match a spending region ChartField on the transaction.
Optional	Select to edit the spending region when the spending region ChartField is entered on a transaction.

<i>Field or Control</i>	<i>Description</i>
Prohibited	Select if the spending region ChartField cannot be entered on a transaction.

Using Spending Regions

This section discusses how to use spending regions.

Pages Used to Use Spending Regions

<i>Page Name</i>	<i>Definition Name</i>	<i>Usage</i>
<u>Spending Region Definition Page</u>	SPNDNG_REG_DEF	Capture spending by region for PeopleSoft Payables transactions.

Spending Region Definition Page

Use the Spending Region Definition page (SPNDNG_REG_DEF) to capture spending by region for PeopleSoft Payables transactions.

Navigation:

Set Up Financials/ Supply Chain > Product Related > Procurement Options > Federal Spending Region > Spending Region Definition

<i>Field or Control</i>	<i>Description</i>
SetID	Select one SetID or multiple SetIDs to establish a ChartField relationship for the given state.
ChartField Value	Select a ChartField value that was previously defined on the Spending Region Install Option page.

(USF) U.S. Federal G-Invoicing

Understanding U.S. Federal G-Invoicing Processing

The U.S. Federal Government Department of the Treasury implemented the G-Invoicing system to manage intra-governmental (IGT) buy sell transactions. IGT transactions result from business activities conducted between two federal entities known as trading partners. G-Invoicing provides a common platform for all IGT Buy/Sell activity.

G-Invoicing supports all four stages of the IGT Buy/Sell transaction lifecycle:

- *General Terms and Conditions (GT&C)*: Identify the general terms that govern Buy/Sell trades between the Requesting Agency and the Selling Agency, including roles and responsibilities for both agencies to ensure effective management of the interagency agreement.
- *Orders*: Specifies the quantity of goods or services ordered.
- *Performance*: Goods/services are delivered/performed by the Selling Agency and received by the Requesting Agency.
- *7600EZ*: This business process allows direct vouchering by the supplier and eliminates the entry of an order in the G-Invoicing system. Note that a purchase order can still be used in the PeopleSoft business process but will not reference a G-Invoicing order.
- *Funds Settlement*: Funds are transferred directly between G-Invoicing and the Federal government Intragovernmental Payment and Collection system (IPAC).

PeopleSoft provides only Buying Agency integration with the U.S. Federal Government G-Invoicing system.

G-Invoicing Process

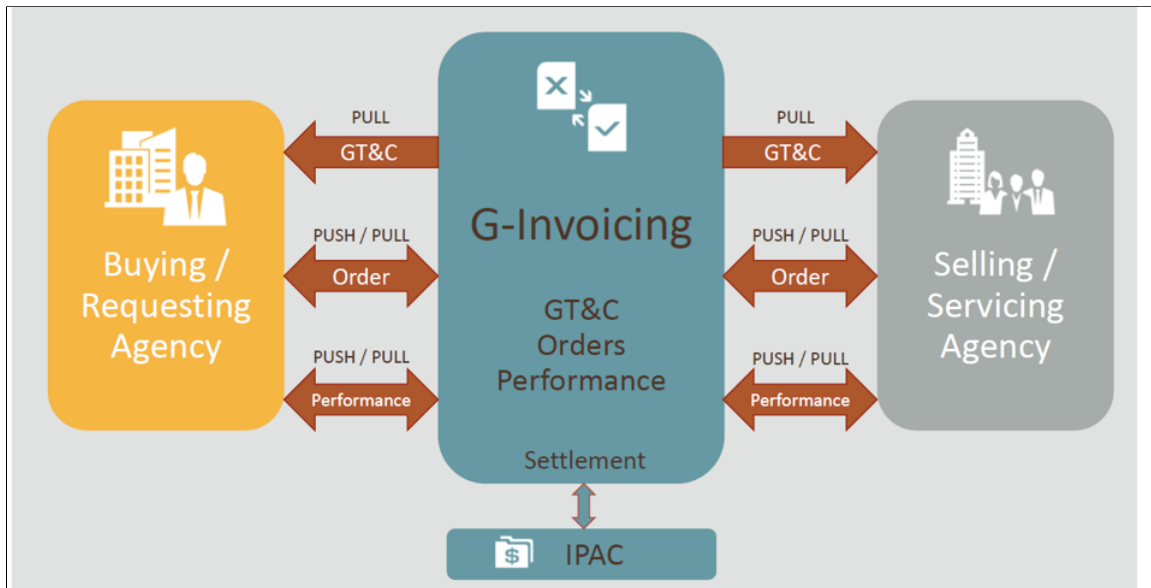

PeopleSoft Purchasing supports the Requesting Agency's Procure-to-Pay business process for G-Invoicing with the following functionality:

- *GT&C:*
 - GT&C API pulls a select set of GTC fields in from the G-Invoicing system.
 - G-Invoicing View GTC inquiry is used to view data that is stored from the inbound interface.
 - The GTC number can be referenced on the PeopleSoft purchase order header and is a key data point that identifies the purchase order is related to G-Invoicing.
- *Orders:*
 - Orders API pulls a list of Orders from the G-Invoicing system.
 - G-Invoicing View Order inquiry is used to view data that is stored from the inbound interface.
 - The Order number can be referenced on PeopleSoft purchase header and is a key data point that identifies the purchase order is related to G-Invoicing. G-Invoicing Order line and schedule information must also be referenced and tie exactly with the G-Invoicing order information.
- *Performance:*
 - Performance APIs are used to pull and push data between PeopleSoft Purchasing and G-Invoicing.
 - G-Invoicing View Performance inquiry is used to view Delivered/Performed transactions which originate from the Seller as well as Received/Accepted transactions which originate from the Requesting Agency.

- Delivered/performed performance transactions can be automatically created in Purchasing as Advanced Shipping Notices and then receipts before creating vouchers in Payables. The receipts are sent back to G-Invoicing through push API as Received/Accepted transactions.
- Evaluated Receipt Settlement (ERS) can be leveraged if enabled for the Purchase Order to automatically create PO Vouchers.

See “U.S. Federal G-Invoicing Processing” (PeopleSoft Payables) for information on how Advances are handled.

- **7600EZ**
 - It primarily supports the high volume of transactions for the General Services Administration (GSA) and the Government Publishing Office (GPO).
 - The GTC number can be referenced on the PeopleSoft purchase order header and is a key data point that identifies the purchase order is related to 7600EZ G-Invoicing.
 - The Order Number reference is not applicable to the PeopleSoft purchase header.
 - 7600EZ APIs use pull/push REST Services to transfer transactions.
- **Funds Settlement:** See “U.S. Federal G-Invoicing Processing” (PeopleSoft Payables) for more information.

PeopleSoft G-Invoicing Business Processes

PeopleSoft provides integration that supports the G-Invoicing Requesting Agency intra-governmental Procure-to-Pay business process.

The G-Invoicing Procure-to-Pay process includes several APIs and processes in PeopleSoft as well as some manual steps as shown below.

G-Invoicing Procure-to-Pay Process

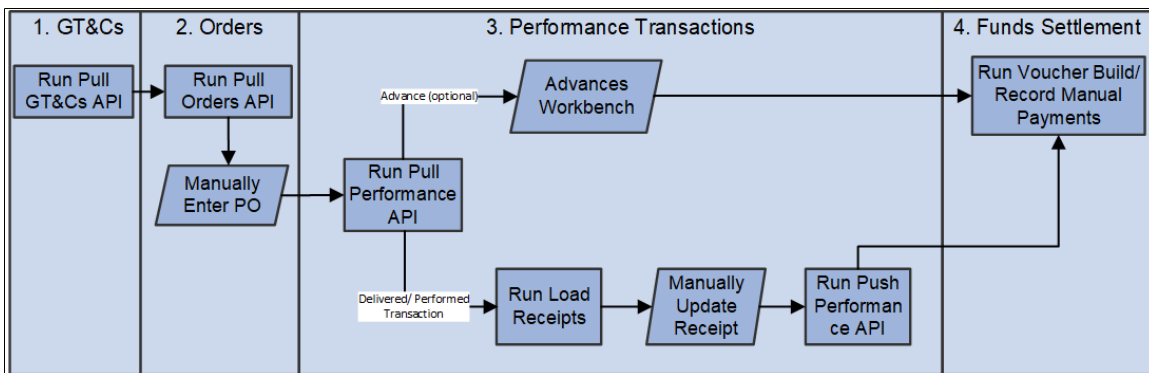

Stage	G-Invoicing Steps	PeopleSoft Steps
1. GT&Cs	GT&Cs are entered directly into G-Invoicing.	A select set of GT&C fields are pulled into PeopleSoft through GT&C API.

Stage	G-Invoicing Steps	PeopleSoft Steps
2. Orders	Orders are entered manually into G-Invoicing.	High level key fields are pulled into PeopleSoft through Order API. Purchase Orders are manually entered into PeopleSoft and reference G-Invoicing GT&C and Order numbers at the header level. Purchase Order lines and schedules must reference G-Invoicing order line and schedule line numbers exactly.
3. Performance Transactions		Performance transactions are pulled into PeopleSoft or pushed into G-Invoicing using the Performance API.
4. 7600EZ	Select 7600EZ as Business Application on the Header Details.	All new G-Invoicing APIs will employ a push/pull model utilizing REST services. Purchasing Receipt transactions in PeopleSoft are optional. Purchase Orders are manually entered into PeopleSoft with reference G-Invoicing GT&C. Order number is not applicable.
Advance payments ('548')	Entered into G-Invoicing by the seller.	See "U.S. Federal G-Invoicing Processing" (PeopleSoft Payables) for more information.
Adjustments to advances (negative '548')	Entered into G-Invoicing by the seller.	See "U.S. Federal G-Invoicing Processing" (PeopleSoft Payables) for more information.
Delivered/performed transactions ('035')	Entered into G-Invoicing by the seller.	Delivered/Performance transactions are loaded as Advanced Shipping Notices (ASNs) using the Pull Performance API. ASNs can be built into Receipts by Load Receipts and are then created as vouchers by Payables.
Received/accepted transactions ('050')	Received from PeopleSoft using API.	Received/accepted transactions are created from Receipts by the requester and pushed back to G-Invoicing using the Push Performance API.

Stage	G-Invoicing Steps	PeopleSoft Steps
Adjustments to received/accepted transactions (negative '050')	Received from PeopleSoft using API.	These adjustments are created from Receipts and Return to Vendor transactions by the requester and pushed back to G-Invoicing through the Push Performance API.
Adjustments to delivered/performed transactions (negative '035')	Entered into G-Invoicing by the seller.	Negative delivered/performed transactions are received through Pull Performance API. These transactions must be reviewed and handled manually in PeopleSoft.
Deferred payment transactions ('014')	Entered into G-Invoicing by the seller to communicate the amount/percentage of work completed for work in progress transactions.	Deferred payment transactions are received through Pull Performance API. They are stored for informational purpose only.
4. Funds Settlement	G-Invoicing initiates funds transfers using IPAC.	See "U.S. Federal G-Invoicing Processing" (PeopleSoft Payables) for more information.

Configuring and Using PeopleSoft G-Invoicing

This topic discusses how to configure and use PeopleSoft G-Invoicing.

Pages Used to Configure and Manage G-Invoicing

This table lists the pages used to configure and manage G-Invoicing.

Page Name	Definition Name	Usage
Federal Processing Options Page	INSTALLATION_FD	To enable PeopleSoft G-Invoicing to run the APIs and view the G-Invoicing specific fields on the purchase order and receipt.
G-Invoicing Definition Page	PO_GINV_DEFN	To capture fields required by G-Invoicing for messaging.
General Terms and Conditions Page	PO_GNV_GTC_FL	To view G-Invoicing General Terms and Conditions that have been pulled using the Pull GTCs API.

Page Name	Definition Name	Usage
<u>G-Invoicing Pull GTCs Page</u>	PO_RUN_GINV_PROC	To run the Pull GT&Cs API which populates the View General Terms and Conditions grid.
<u>Orders Page</u>	PO_GNV_ORD_FL	To view G-Invoicing orders that have been pulled using the Pull Orders API.
<u>G-Invoicing Pull Orders Page</u>	PO_GINV_ORD_PROC	To run the Pull Orders API which populates the View Orders grid.
<u>Performance Transactions Page</u>	PO_GNV_PER_HDR_FL	To view G-Invoicing Performance Transactions that have been pulled using the Pull Performance API.
<u>G-Invoicing Pull Performance Page</u>	PO_GINV_PFM_PROC	To run the Pull Performance transactions which populates the View Performance grid.
<u>G-Invoicing Push Performance Page</u>	PO_GINV_PFM_PUSH	To run the Push Performance transactions API which sends Received/ Accepted transactions and adjustments to G-Invoicing.

Federal Processing Options Page

Use the Federal Processing Options page (INSTALLATION_FD) to enable PeopleSoft G-Invoicing to run the APIs and view the G-Invoicing specific fields on the purchase order and receipt.

Navigation:

Setup Financials/Supply Chain > Install > Installation Options > Federal Processing

This example illustrates the fields and controls on the Federal Processing Options page. You can find definitions for the fields and controls later on this page.

Installation Options

Federal Processing Options

System for Award Management

Enable SAM

Use NAICS Code Functionality
 Suppliers
 Customers

Use Taxpayer Name for Alternate Withholding

Federal Award Data

Enable Procurement Fields

Products

PIID and Parent PIID Display Length

Enable Financial Assistance Fields

Products

FAIN Display Length

URI Display Length

G-Invoicing

Enable G-Invoicing
 Generate AP Journal Voucher for Negative Advance Transactions

<i>Field or Control</i>	<i>Description</i>
Enable G-Invoicing	Select to enable G-Invoicing fields and functionality.
Generate AP Journal Voucher for Negative Advance Transactions	Select to automatically create Journal Vouchers for negative advance adjustment performance transactions received from G-Invoicing. This field is visible only when <i>Enable G-Invoicing</i> is selected.

G-Invoicing Definition Page

The G-Invoicing Definition page (PO_GINV_DEFN) captures fields required by G-Invoicing for messaging. Additionally, this page stores the last date and time that each API ran for the selected G-Invoicing System ID. All G-Invoicing System IDs must be defined on this page. System IDs are used for security in G-Invoicing.

Navigation:

Purchasing > G-Invoicing > G-Invoicing Definition

This example illustrates the fields and controls on the G-Invoicing Definition page. You can find definitions for the fields and controls later on this page.

G-Invoicing Definition

*SetID

*System ID

Description

APIs | < 1 of 1 > |

G-Invoicing API	Last Updated Date	Last Updated Time
Pull GTCs	08/10/2023	11:35:35PM
Pull Orders	04/22/2022	8:47:06PM
Pull Performance	07/10/2023	10:13:21PM
Push Performance	05/30/2023	6:25:15AM
Pull EZ Invoices	08/29/2023	1:15:06AM
Push EZ Invoices	08/29/2023	1:13:52AM

Field or Control	Description
SetID	Enter the Set ID associated with the System ID definition.
System ID	Enter the G-Invoicing System ID.
Description	Enter a description of the entry.
G-Invoicing API	Displays the available APIs.
Last Updated Date (read only)	Displays the date FROM which transactions are selected by the pull APIs.
Last Updated Time (read only)	Displays the time FROM which transactions are selected by the pull APIs.

G-Invoicing navigation collection page is used to group the G-Invoicing inquiry pages together allowing a user to easily navigate from one component to another.

This example illustrates the fields and controls on the G-Invoicing page.

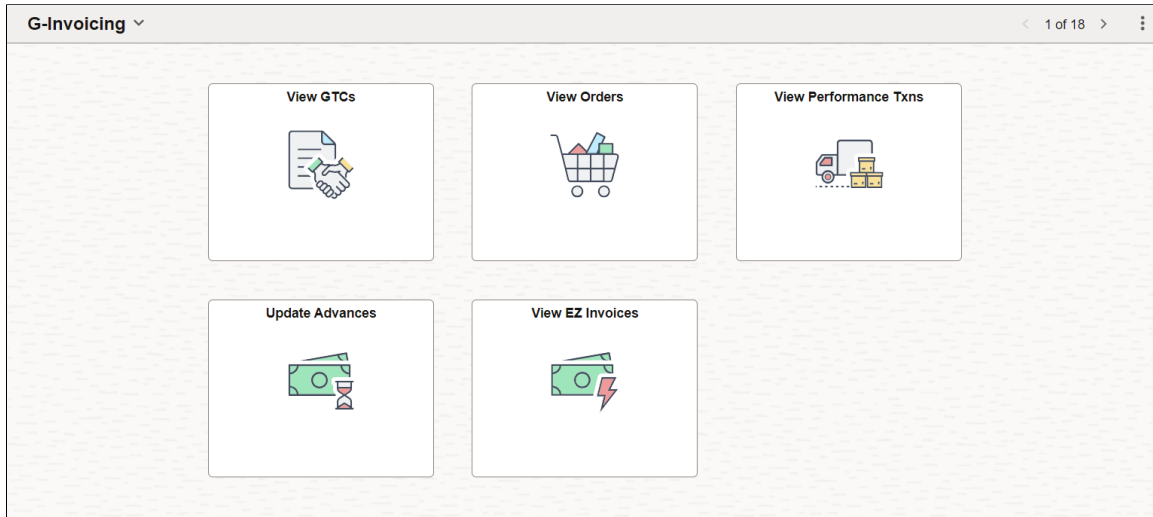

General Terms and Conditions Page

Use the GTCs (General Terms and Conditions) page (PO_GNV_GTC_FL) to view G-Invoicing General Terms and Conditions that have been pulled using the Pull GTCs API.

Navigation:

G-Invoicing > View GTCs

This example illustrates the fields and controls on the General Terms and Conditions page. You can find definitions for the fields and controls later on this page.

General Terms and Conditions							
General Terms and Conditions 84 rows							
GTC Number ¹	Title ¹	Feature Code ¹	Status ¹	Start Date ¹	End Date ¹	Active ¹	Details
A2305-020-020-027136	EZInvoice_nash_3	EZ_10K	Open	01/01/2022	05/01/2024	Yes <input type="checkbox"/>	>
A2305-020-020-027339	Reversal Voucher	EZ_10K	Open	01/01/2023	05/01/2024	Yes <input type="checkbox"/>	>
A2305-020-020-027423	Nash1	EZ_10K	Open	01/01/2023	05/01/2024	Yes <input type="checkbox"/>	>
A2305-020-020-027618	Standard_1	STANDARD	Open	01/01/2023	05/01/2024	Yes <input type="checkbox"/>	>
A2306-020-020-028438	DOT-GSA-FY21-Fleet Services	STANDARD	Open	04/12/2021	04/02/2024	Yes <input type="checkbox"/>	>
A2306-020-020-028441	Multi-Year Contract for Services	STANDARD	Open	10/01/2020	09/30/2022	Yes <input type="checkbox"/>	>
A2307-020-020-028735	Standard_2	STANDARD	Open	01/01/2023	05/01/2024	Yes <input type="checkbox"/>	>
A2307-020-020-028736	Standard_3_EZ?	STANDARD	Open	01/01/2023	05/01/2024	Yes <input type="checkbox"/>	>
A2307-020-020-028772	EZ_with >10K	EZ_10K	Open	01/01/2023	05/01/2024	Yes <input type="checkbox"/>	>

Field or Control	Description
SetID	Displays the derived set ID associated with the G-Invoicing System ID on the G-Invoicing Definition page.
GTC Number	Displays the GT&C number assigned in G-Invoicing.

Field or Control	Description
Title	Displays the GT&C Title entered in G-Invoicing.
Feature Code	Displays the G-Invoicing type: <ul style="list-style-type: none"> • Standard • EZ_10K: For 7600EZ G-Invoicing
Status	Displays the GT&C Status received from G-Invoicing.
Start Date	Displays the GT&C Start Date entered in G-Invoicing.
End Date	Displays the GT&C End Date entered in G-Invoicing.
Active	Indicates whether the GT&C is available for selection on Purchase Orders.
	Click to view the GT&C Detail page. Click the Select Last Updated Date drop down to see the GT&C changes that have occurred in G-Invoicing for a specific date/time.

This example illustrates the fields and controls on the GT&C Detail page.

General Terms and Conditions

SetID FEDRL
 GTC Number A2104-020-020-003293
 *Select Last Updated Date 2023-06-24 05:41:23.000000

Title Multi-Year Contract for Services Start Date 10/01/2020
 Active Yes End Date 09/30/2022
 Status Open Order Originating Partner R
 Feature Code STANDARD

Requesting Agency

Agency ID 020 ALC 20180309
 Group Name Santa Clara CA Group ID 6a4479c1-f76b-46e5-93f3-ed4d1d1c8c18
 Tracking Number 772a3d5f-7c92-457d-865f-5e9fac

Servicing Agency

Agency ID 020 ALC 20180310
 Group Name Peoplesoft Field Offices Group ID ad25e677-21b3-4857-944f-87891a589ea8

Preparer

Phone [REDACTED] Email [REDACTED]
 Name [REDACTED]

G-Invoicing Pull GTCs Page

Use the G-Invoicing Pull GTCs page (PO_RUN_GINV_PROC) to run the Pull GT&Cs API which populates the View General Terms and Conditions grid. Only G-Invoice GTCs with a status of Open (REC) or Closed (CLZ) are pulled.

Navigation:

Purchasing > G-Invoicing > G-Invoicing Pull GTCs

GT&Cs are entered directly into G-Invoicing and a subset of fields is pulled into PeopleSoft using this API. The GT&C Number is used for reference on purchase orders.

This example illustrates the fields and controls on the G-Invoicing Pull GTCs page. You can find definitions for the fields and controls later on this page.

Field or Control	Description
Run Control ID	Enter a run control ID.
Process Frequency	Select how often the process should run. The available options are: <ul style="list-style-type: none"> • Always Process. • Process Once. • Don't Run.
System ID	Enter the System ID to use when pulling transactions from G-Invoicing.
Last Updated Date and Last Updated Time	Displays the last run date and time for the API.

Orders Page

Use the Orders page (PO_GNV_ORD_FL) to view a list of G-Invoicing orders that have been pulled using the Pull Orders API.

Navigation:

G-Invoicing > View Orders

This example illustrates the fields and controls on the Orders page. You can find definitions for the fields and controls later on this page.

SetID	Order Number	GTC Number	Requesting ALC	Servicing ALC	FOB Point	Status	Last Update	Active
FEDRL	O2203-020-020-765262	A2203-020-020-008597	20184903	20188768	Source	REC	04/22/22	Yes
FEDRL	O2203-020-020-765264	A2203-020-020-008598	20184903	20188768	Source	REC	04/28/22	Yes
FEDRL	O2203-020-020-765346	A2203-020-020-008599	20184903	20188768	Source	REC	04/28/22	Yes
FEDRL	O2203-020-020-765359	A2203-020-020-008600	20184903	20188768	Source	REC	04/28/22	Yes
FEDRL	O2203-020-020-765360	A2203-020-020-008601	20184903	20188768	Source	CLZ	04/20/22	Yes
FEDRL	O2203-020-020-765447	A2203-020-020-008602	20184903	20188768	Destination	REC	04/28/22	Yes
FEDRL	O2204-020-020-790933	A2204-020-020-008750	20184903	20188768	Source	REC	04/28/22	Yes
FEDRL	O2204-020-020-794580	A2204-020-020-008755	20184903	20188768	Destination	REC	04/28/22	Yes
FEDRL	O2204-020-020-794759	A2204-020-020-008756	20184903	20188768	Source	REC	04/28/22	Yes
FEDRL	O2204-020-020-797038	A2204-020-020-008758	20184903	20188768	Source	REC	04/28/22	Yes

Field or Control	Description
SetID	Displays the derived set ID associated with the G-Invoicing System ID on the G-Invoicing Definition page.
Order Number	Displays the Order Number assigned in G-Invoicing.
GTC Number	Displays the associated GT&C in G-Invoicing.
Requesting ALC	Displays the Requester’s Agency Location Code (ALC) from G-Invoicing.
Servicing ALC	Displays the Seller’s Agency Location Code from G-Invoicing.
FOB Point	Indicates whether the Order originated from the Requestor or Seller in G-Invoicing.
Status	Displays the Order Status in G-Invoicing.
Last Update	Displays the last date that the Order was updated by the API.
Active	Indicates whether the Order is available for selection on Purchase Orders.

G-Invoicing Pull Orders Page

Use the G-Invoicing Pull Orders page (PO_GINV_ORD_PROC) to run the Pull Orders API which populates the View Orders grid. Only G-Invoice Orders with a status of Open (REC) or Closed (CLZ) are pulled.

Navigation:

Purchasing > G-Invoicing > G-Invoicing Pull Orders

This example illustrates the fields and controls on the G-Invoicing Pull Orders page. You can find definitions for the fields and controls later on this page.

Orders are entered directly into G-Invoicing and a list of orders is pulled into PeopleSoft using this API. The Order Number is used for reference on Purchase Orders.

Field or Control	Description
Run Control ID	Enter a run control ID.
Process Frequency	Select how often the process should run. The available options are: <ul style="list-style-type: none"> • Always Process. • Process Once. • Don't Run.
System ID	Enter the System ID to use when pulling transactions from G-Invoicing.
Last Updated Date and Last Updated Time	Displays the last run date and time for the API.

Performance Transactions Page

Use the Performance Transactions page (PO_GNV_PER_HDR_FL) to view G-Invoicing Performance Transactions that have been pulled using the Pull Performance API.

Navigation:

G-Invoicing > View Performance Transactions

This example illustrates the fields and controls on the Performance Transactions page. You can find definitions for the fields and controls later on this page.

SetID	Type	Performance Number	Order Number	GTC Number	Requesting ALC	Servicing ALC	Performance Date	In Process	Details
FEDRL	035	P2203-020-020-192791	O2203-020-020-765262	A2203-020-020-008597	20184903	20188768	10/05/2021	Processing	>
FEDRL	035	P2203-020-020-192792	O2203-020-020-765262	A2203-020-020-008597	20184903	20188768	01/27/2022	Processing	>
FEDRL	548	P2203-020-020-192793	O2203-020-020-765264	A2203-020-020-008598	20184903	20188768	10/12/2021	Not Started	>
FEDRL	035	P2203-020-020-192794	O2203-020-020-765346	A2203-020-020-008599	20184903	20188768	11/16/2021	Not Started	>
FEDRL	035	P2203-020-020-192795	O2203-020-020-765346	A2203-020-020-008599	20184903	20188768	01/06/2022	Not Started	>
FEDRL	035	P2203-020-020-192796	O2203-020-020-765346	A2203-020-020-008599	20184903	20188768	02/16/2022	Not Started	>
FEDRL	035	P2203-020-020-192797	O2203-020-020-765359	A2203-020-020-008600	20184903	20188768	10/12/2021	Processing	>
FEDRL	035	P2203-020-020-192798	O2203-020-020-765359	A2203-020-020-008600	20184903	20188768	11/24/2021	Processing	>
FEDRL	035	P2203-020-020-192799	O2203-020-020-765359	A2203-020-020-008600	20184903	20188768	12/23/2021	Processing	>

Field or Control	Description
SetID	Displays the derived set ID associated with the G-Invoicing System ID on the G-Invoicing Definition page.
Type	Identifies the nature of the performance in the reported transaction: <ul style="list-style-type: none"> • '035' Delivered/Performed • '050' Received/Accepted • '548' Advance • '014' Deferred Payment (for informational purposes only)
Performance Number	Displays the Performance Number assigned to the transaction in G-Invoicing.
Order Number	Displays the associated Order Number in G-Invoicing.
GTC Number	Displays the associated GT&C in G-Invoicing.
Requesting ALC	Displays the Requester's ALC from G-Invoicing.

Field or Control	Description
Servicing ALC	Displays the Seller's ALC from G-Invoicing.
Performance Date	Displays the date of the performance transaction in G-Invoicing.
In Process	<p>Identifies whether the transaction has one or more receipts created:</p> <ul style="list-style-type: none"> • <i>N (Not Started)</i>: no receipts created against this transaction. • <i>P (Processing)</i>: at least one receipt is created against this transaction but there is still an outstanding balance. • <i>C (Complete)</i>: receipts have been created against this transaction and it is fully received.
	Click to view the Performance Detail page. This page contains header and line data associated with the performance transaction.

This example illustrates the fields and controls on the Performance Details page. You can find definitions for the fields and controls later on this page.

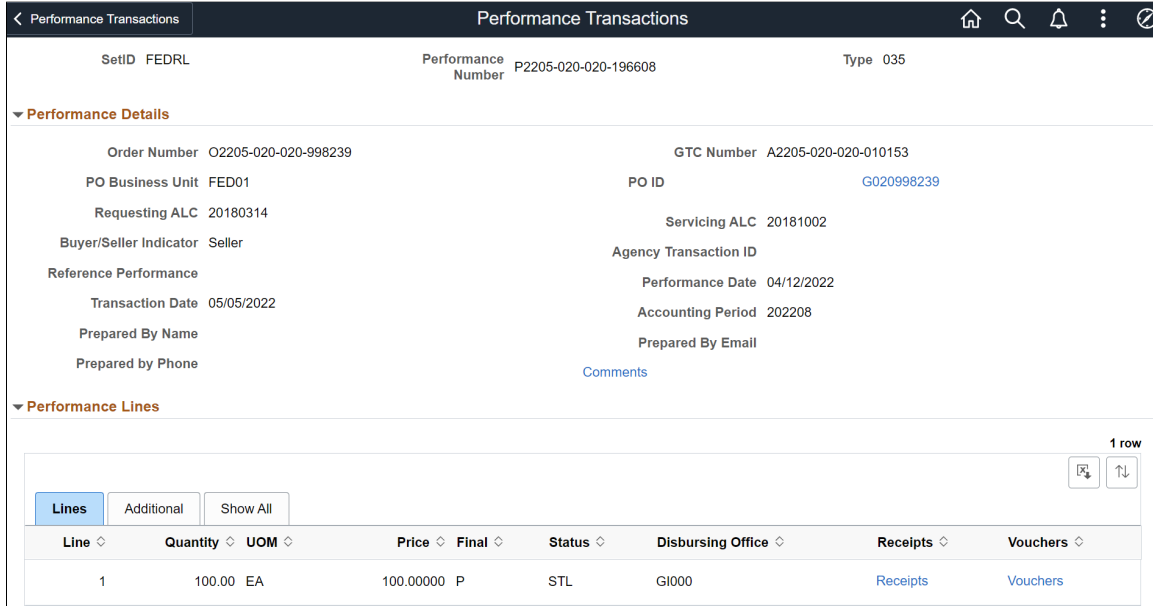

The screenshot shows the 'Performance Transactions' page. At the top, it displays 'Performance Transactions' with navigation icons. Below this, key information is shown: SetID FEDRL, Performance Number P2205-020-020-196608, and Type 035. A section titled 'Performance Details' contains various fields: Order Number O2205-020-020-998239, GTC Number A2205-020-020-010153, PO Business Unit FED01, PO ID G020998239, Requesting ALC 20180314, Servicing ALC 20181002, Buyer/Seller Indicator Seller, Agency Transaction ID, Reference Performance, Performance Date 04/12/2022, Transaction Date 05/05/2022, Accounting Period 202208, Prepared By Name, Prepared By Email, Prepared by Phone, and a Comments link. Below this is the 'Performance Lines' section, which shows a table with one row. The table has columns for Line, Quantity, UOM, Price, Final, Status, Disbursing Office, Receipts, and Vouchers. The first row contains: 1, 100.00, EA, 100.00000, P, STL, GI000, Receipts, and Vouchers. There are also buttons for 'Lines', 'Additional', and 'Show All' above the table.

Field or Control	Description
SetID	Displays the derived set ID associated with the G-Invoicing System ID on the G-Invoicing Definition page.

Field or Control	Description
Type	Identifies the nature of the performance in the reported transaction: <ul style="list-style-type: none"> • '035' Delivered/Performed • '050' Received/Accepted • '548' Advance • '014' Deferred Payment
Performance Number	Displays the Performance Number assigned to the transaction in G-Invoicing.
Order Number	Displays the associated Order Number in G-Invoicing.
GTC Number	Displays the associated GT&C in G-Invoicing.
PO Business Unit	Displays the PO Business Unit from the set ID associated with the G-Invoicing System ID on the G-Invoicing Definition page.
PO ID	Click to view the Purchase Order in the PO Inquiry page.
Buyer/Seller Indicator	Indicates whether the performance transaction originated from the Requestor or Seller in G-Invoicing.
Agency Transaction ID	Displays the Agency Transaction ID from G-Invoicing.
Reference Performance	Links a new Performance Transaction to an existing one.
Transaction Date	Displays the date and time the performance transaction was entered into G-Invoicing.
Performance Date	Displays the date and time of the performance transaction in G-Invoicing.
Prepared By Name/Email/ Phone	Displays the name, email address, and phone number for the preparer in G-Invoicing.
Comments	Click the Comments link to view Comments associated with the transaction.
Line	Displays the G-Invoicing performance line number.

Field or Control	Description
Quantity	Displays the number of units pertaining to the type of performance being reported.
UOM	Displays the units in which a quantity is being expressed.
Price	Displays the price of the G-Invoicing line.
Final	Specifies from one partner to another that no more performance (of this type) is expected against the Order Schedule. This is a G-Invoicing field, not to be confused with the PeopleSoft partial/final flag.
Status	Displays the G-Invoicing status of the payment with IPAC.
Disbursing Office	Identifier assigned to the agency which is disbursing funds.
Receipts	Click to view Receipts created for this performance transaction.
Vouchers	Click to view Vouchers created for this performance transaction.
Reference Line	G-Invoicing reference line number that links a new Performance Detail to an existing one.
Order Line	G-Invoicing identifier of a specific line item within the order.
Schedule Number	G-Invoicing identifier of a specific schedule within the line item, containing the detailed financial and shipping information.
Payment Transfer Date	G-Invoicing date when the funds settled in IPAC.

Note: It is possible that GT&C number could be blank on the Performance Inquiry table, if Pull Performance runs before Pull Orders. The GT&C Number is derived from the Orders data. To correct this issue, run Pull Orders and then Pull Performance again to populate GT&C Number.

G-Invoicing Pull Performance Page

Use the G-Invoicing Pull Performance page (PO_GINV_PFM_PROC) to run the Pull Performance transactions which populates the View Performance grid.

Navigation:

Purchasing > G-Invoicing > G-Invoicing Pull Performance

This example illustrates the fields and controls on the G-Invoicing Pull Performance page. You can find definitions for the fields and controls later on this page.

Performance transactions include:

- Advance payments ('548')
- Adjustments to advances (negative '548')
- Delivered/performed transactions ('035')
- Adjustments to delivered/performed transactions (negative '035'). These transactions are for informational purposes only and no transactions are automatically created. Since the specific reason for the adjustment is unknown, these transactions need to be reviewed and determine manual correction in Purchasing as necessary.
- Received/accepted transactions ('050')
- Adjustments to received/accepted transactions (negative '050')
- Deferred payment transactions ('014'). For informational purposes.

Field or Control	Description
Run Control ID	Enter a run control ID.
Process Frequency	Select how often the process should run. The available options are: <ul style="list-style-type: none"> • Always Process. • Process Once. • Don't Run.

Field or Control	Description
System ID	Enter the System ID to use when pulling transactions from G-Invoicing.
Last Updated Date and Last Updated Time	Displays the last run date and time for the API.

G-Invoicing Push Performance Page

Use the G-Invoicing Push Performance page (PO_GINV_PFM_PUSH) to run the Push Performance transactions API which sends Received/Accepted transactions and adjustments to G-Invoicing.

Navigation:

Purchasing > G-Invoicing > G-Invoicing Push Performance

This example illustrates the fields and controls on the G-Invoicing Push Performance page. You can find definitions for the fields and controls later on this page.

The following transactions are pushed back to G-Invoicing:

- Received/accepted transactions ('050'). These transactions originate from Receipts.
- Adjustments to received/accepted transactions (negative '050'). These transactions originate from adjustments to Receipts and Return to Vendor transactions.

Field or Control	Description
Run Control ID	Enter a run control ID.

Field or Control	Description
Process Frequency	Select how often the process should run. The available options are: <ul style="list-style-type: none"> • Always Process. • Process Once. • Don't Run.
System ID	Enter the System ID to use when pulling transactions from G-Invoicing.
Last Updated Date and Last Updated Time	Displays the last run date and time for the API.

Note: Pull Performance must be run prior to pushing RTV and receipt adjustment transactions so that the Reference Performance Number can be populated on the '050' adjustment transaction. All '050' adjustments must reference the Received/Accepted transaction ('050') they are adjusting. G-Invoicing assigns a performance number to a '050' transaction after it is pushed using the API. This performance number becomes the reference performance number for the '050' adjustment.

Creating G-Invoicing Purchase Order Transactions

G-Invoicing must be enabled in Installation options and the Supplier ID must be classified as Federal, to view G-Invoicing specific fields on the purchase order.

Ensure that the Purchase Order entered in PeopleSoft matches the G-Invoicing Order lines and schedules exactly. The references are used to tie together all transaction activity between both systems.

Field or Control	Description
GTC Number	Select GT&C number associated with the Order from the list. For more information, see PO Header Details Page
G-Invoicing Order Number	Select G-Invoicing Order Number associated with this PO from the list. For more information, see PO Header Details Page
G-Invoicing Order Line	Unique identifier for each line on the G-Invoicing Order. Defaults initially to the PeopleSoft PO Line Number. The Line numbers must match between the Order in G-Invoicing and PeopleSoft. For more information on purchase orders, see Maintain Purchase Order - Purchase Order Page

<i>Field or Control</i>	<i>Description</i>
G-Invoicing Order Schedule	Unique identifier for the order schedule. Defaults initially to the PeopleSoft PO Schedule Number. The schedule numbers must match between the Order in G-Invoicing and PeopleSoft. For more information on schedules, see Maintain Purchase Order - Schedules Page

Creating Advance Shipping Notifications for G-Invoicing Performance Transactions

G-Invoicing Performance Transactions classified as Delivered/Performed from the Supplier Agency are used to create Advanced Shipping Notifications (ASNs) in PeopleSoft. These ASNs become Advanced Shipping Receipts (ASRs) once loaded to Purchasing.

Performance transactions meeting the following criteria are selected for ASN creation:

- Performance type is Delivered/Performed or '035'.
- In Process flag on the Performance Inquiry table must not be Complete.
- Performance transaction not previously processed into an ASR.
- Performance transaction is NOT an Adjustment (Reference Performance field is blank).

The Pull Performance API loads all eligible delivered/performed performance transactions to the ASN staging tables.

Use Advanced Shipment Receipts page (Purchasing> Receipts> Review Receipt Information> Advanced Shipment Receipts) to view the staged shipments. Use Load Purchase Order Receipts page (Purchasing> Receipts> Load Receipts) to create Receipts from the staged ASR transactions.

For additional information, see [Loading Receipts Received Using EIPs and EDC](#)

Creating G-Invoicing Receipts Manually

It is possible to bypass the ASN/ASR process and create G-Invoicing receipts manually.

Pull Performance will create ASNs for all eligible '035' transactions. These transactions can either be ignored or canceled. Processing them in addition to creating a receipt manually will cause duplicate entries.

This example illustrates the fields and controls on the Advanced Shipment Receipts page

Advanced Shipment Receipts
EIP Control ID 1020926542124211109300001

ASR Lines

ASR Lines | More Line Data | 1-2 of 2 | View All

Sel	ASR Seq	ASR Sched	ASR Status	Status	PO Unit	PO Number	Line	Sched Num	Msg	Description
<input type="checkbox"/>	1	1 P	Processed	FED01	G020916017	1	1			LINE 1
<input type="checkbox"/>	2	2 P	Processed	FED01	G020916017	2	1			LINE 2

Header Details | Shipment Header | Address
Lot/Serial | Select Purchase Order | Error Message Text

To designate the receipt as G-Invoicing so that the Push Performance API generates a ‘050’ transaction, the following fields are required to be entered:

- Referenced PO ID is required and the selected PO must be designated as G-Invoicing.
- Shipment Number must be entered with the exact G-Invoicing Performance Number from the Seller agency.
- Invoice Number must be entered.
- Ship and Receipt Date must be entered as the G-Invoicing Performance Date.

Note: All Received/Accepted (‘050’) transactions and adjustments to Received/Accepted (negative ‘050’) transactions must either be entered in PeopleSoft OR in G-Invoicing but not both. Entering ‘050’ transactions directly into G-Invoicing and PeopleSoft will cause errors and reconciliation issues.

Pushing Receipts to G-Invoicing

The G-Invoicing receipts are in an open status after the Load Receipts process is run.

A user must verify and confirm the Receipt Quantity on the line as well as enter an Invoice Number. The receipt status changes to Fully Received, once saved.

Note: The Receipt Quantity entered on the PeopleSoft receipt cannot exceed the quantity that the Supplier Agency reported on the delivered/performed (035) transaction or the push back to G-Invoicing will fail.

For additional information, see [Maintain Receipts - Receiving Page](#)

Now the Receipt is eligible to be pushed back to G-Invoicing as a received/accepted (050) performance transaction. Use the [G-Invoicing Push Performance](#) page to run the Push Performance API which sends eligible receipts to G-Invoicing.

In addition to Receipts, the Push Performance API sends the following transactions to G-Invoicing:

- Updated receipts in a Received status are sent as received/accepted adjustments. When the receipt has been previously sent, the difference in quantity between the original and the adjustment is sent. Canceled G-Invoicing receipts are also sent.

- Return to Vendor (RTV) transactions that reference a G-Invoicing designated receipt and are in a Shipped status are sent as received/accepted adjustments. Canceled G-Invoicing RTVs are also sent.

Adjustments to delivered/performed transactions (negative '035') must originate from the seller and are included in the Pull Performance API. No transactions are automatically created for negative '035' transactions since the reason for the adjustment and the corrective action are not known. These transactions must be reviewed and handled manually in PeopleSoft.

For example, a G-Invoicing Order is created for a quantity of 100. The Seller sends a Delivered/Performed ('035') transaction to the Requester for a quantity of 100 when the items are shipped. The Requester and the Seller have agreed to an FOB Point of Source, so an IPAC payment with a quantity of 100 is triggered in G-Invoicing when the Delivered/Performed ('035') transaction is created. 20 items were lost in transit and the Requester sends a Received/Accepted ('050') transaction for a quantity of 80 back to the Seller. To account for this in G-Invoicing and refund the quantity in IPAC, the Seller enters a negative Delivered/Performed ('035') transaction with a quantity of -20. This negative 035 is sent back to PeopleSoft in the Pull Performance API. If this negative 035 is processed, then amounts and quantities in PeopleSoft and G-Invoicing will not match.

Note: Received/Accepted ('050') transactions with multiple lines are assigned a unique Performance Number for each line by G-Invoicing.

Processing Taxes for India

Processing Custom Duty, Excise Duty, and Sales Tax/VAT in the Sourcing Business Process

This section discusses how to Process Custom Duty, Excise Duty, and Sales Tax/VAT in the Sourcing Business Process

Pages Used to Process Custom Duty, Excise Duty, and Sales Tax/VAT in the Sourcing Business Process

<i>Page Name</i>	<i>Definition Name</i>	<i>Usage</i>
<u>Run Controls Page</u>	RUN_PO_POCALC1	Enter run control criteria for the PO Calculations process and run the process.
<u>Create PO Page</u>	RUN_PO_POCREATE	Enter run control criteria for the Create Purchase Orders process and run the process.
Sourcing Workbench - Sourcing Page	PO_SRC_ANALYSIS	View, correct, and recycle transactions in the purchasing staging tables.
Sourcing Workbench - Sourcing Details Page	PO_SRC_ANLSYS_DTL	View further details about a staged row and to change the supplier and stage status
Sourcing Workbench - Pricing Information Page	PO_SRC_PRICING	Enter pricing information.
<u>PO Stage Excise/Sales Tax/VAT Details Page</u>	PO_SHIP_STG_EXS	View staged purchase order excise duty and sales tax/VAT information. If information is incorrect, the page provides source document details to help you determine where corrections may need to be made.
<u>Purge Stage Page</u>	RUN_PO_POSTGPRG	Enter run control criteria for the Purge Stage Tables process and run the process.

Run Controls Page

Use the Run Controls page (RUN_PO_POCALC1) to enter run control criteria for the PO Calculations process and run the process.

Navigation:

Purchasing > Purchase Orders > Stage/Source Requests > PO Calculations > Run Controls

The PO Calculations process acts on the PeopleSoft Purchasing staging table (PO_ITM_STG) and creates rows in PO_ITM_STG_UD and PO_ITM_STG_SUP. The PO Calculations process calculates miscellaneous charges, freight, use tax, and sales tax/VAT. In addition, it invokes the Tax Determination Application Engine process (FS_EXSLIB), which performs tax determination and calculates all applicable excise duties and sales tax/VAT for the purchase order.

Details relevant to tax determination, such as inventory business unit, purchasing business unit, item, and supplier are available in the PeopleSoft Purchasing staging tables. However, no tax parameters, such as tax rate code, tax rate, calculated tax base, tax amounts, and so forth, are available.

Based on the details relevant to tax determination, the Tax Determination and PO Calculations processes run for the purchase order calculate and store tax information in the tax staging tables (PO_STG_TAX_EXD and PO_STG_TAXD_EXS).

The PO_CMFRTMSC section of the PO Calculations process runs the customs duty tax determination and calculation common process.

Related Links

[Running the PO Calculations Process](#)

PO Stage Excise/Sales Tax/VAT Details Page

Use the PO Stage Excise/Sales Tax/VAT Details page (PO_SHIP_STG_EXS) to view staged purchase order excise duty and sales tax/VAT information.

If information is incorrect, the page provides source document details to help you determine where corrections may need to be made.

Navigation:

Click the **Excise/Sales Tax** button on the Sourcing Workbench - Pricing Information page.

Excise/ST/VAT Schedule Dtls

<i>Field or Control</i>	<i>Description</i>
Amount	Displays the total merchandise amount on the schedule.

Field or Control	Description
Tax Transaction Type	Displays the tax transaction type assigned to the transaction. Values for purchases are: <ul style="list-style-type: none"> • <i>DIMP</i> (direct import) • <i>DOM</i> (domestic) • <i>LIMP</i> (local import)
Excise Applicable	Indicates if excise duties are applicable to the transaction.
Tax Applicable	Indicates whether sales tax/VAT are applicable to the transaction.

Excise Applicable

Field or Control	Description
Tax Rate Cd (tax rate code)	Displays the excise tax rate code for the transaction derived using the Tax Determination process and tax rate code default hierarchy.
Excise Use Av Flag (excise use assessable value flag)	Indicates if the assessable value entered for the item is being used in the tax calculation.
Excise Item Category Code	Displays the default excise tax category code defined for the item.
Excise UOM (excise unit of measure)	Displays the item excise unit of measure.
Assessable Value	Displays the assessable value entered for the item. The excise reporting currency defined for the tax location appears. The tax location for the transaction is based on the inventory or purchasing business unit for the ship to location. Excise registers are maintained in a selected currency based on the periodic reports and statements that are submitted to excise authorities. Excise transactions that update excise registers need to be converted to an excise reporting currency.

Tax Applicable

Field or Control	Description
Tax Rate Cd (tax rate code)	Displays the sales tax/VAT rate code derived using the Tax Determination process and assigned to the transaction.
Reporting Authority	Displays the sales tax/VAT reporting authority derived using the Tax Determination process and assigned to the transaction.
Ship From State	Displays the ship from state for the item.
Tax Authority Rate	Displays the sales tax/VAT authority rate derived using the Tax Determination process and assigned to the transaction.
Ship to State	Displays the ship to state for the item.
Form Code	Displays the sales tax/VAT form code associated with the derived sales tax/VAT rate code.
Sales Item Category Code	Displays the default sales tax/VAT category code defined for the item.

Excise/Sales Tax/VAT and Custom Duty Details

Field or Control	Description
Tax Type	Displays the tax type associated with the tax component code on the transaction. Values are: <ul style="list-style-type: none"> • <i>Excise</i> (excise duty) • <i>Custom</i> (custom duty) • <i>ST/VAT</i> (sales tax and value added tax)
Tax Rate Sequence	Indicates the order in which tax component codes in the tax rate code should be calculated.
Tax Component Code	Displays the tax component code assigned to the transaction.

Field or Control	Description
Calculation Scheme	<p>Displays the default calculation scheme associated with the selected tax component code. Values are:</p> <p><i>Amount</i>: Ad hoc amount-based tax calculation.</p> <p><i>Percentage</i>: Percentage-based tax calculation. Percentage appears by default.</p> <p><i>Quantity</i>: Quantity-based tax calculation</p>
Tax Rate UOM (tax rate unit of measure)	<p>If the Calculation Scheme is set to <i>Quantity</i>, displays the unit of measure against which the tax rate amount is applied.</p> <hr/> <p>Note: If the transaction unit of measure is different from the tax rate code unit of measure, the system performs the conversion using the PeopleSoft-delivered unit of measure conversion feature.</p> <hr/>
Tax Rate Pct (tax rate percentage)	<p>If the Calculation Scheme field value is set to <i>Percentage</i>, displays the percentage to be applied against the taxable amount.</p>
Tax Rate Amount	<p>If the Calculation Scheme field value is set to <i>Quantity</i>, displays the amount to be applied against the transaction quantity, according to the transaction quantity in the Tax Rate UOM value.</p> <hr/> <p>Note: If the transaction unit of measure is different from the tax rate code unit of measure, the system performs the conversion using the PeopleSoft-delivered unit of measure conversion feature.</p> <hr/> <p>If the Calculation Scheme is set to <i>Amount</i>, this is the tax amount.</p>
Basis Amount	<p>Displays the base amount on which tax is calculated.</p>
Tax Amount	<p>Displays the tax amount for the tax rate sequence.</p>
Recovery Amount	<p>Displays the recoverable tax amount for the tax rate sequence.</p>
Non Recovery Amount	<p>Displays the nonrecoverable tax amount for the tax rate sequence.</p>

More Tab

Select the More tab.

Field or Control	Description
Tax Percentage	<p>Displays the tax percentage. The system uses this value to split taxes into recoverable and nonrecoverable components.</p> <p>If the Tax Type field value is set to <i>Excise</i>, this is the CENVAT percentage that can be recovered. For example, a field value of <i>100</i> indicates that the full amount of tax is eligible for CENVAT credit.</p> <p>If you set the Tax Type field value to <i>ST/VAT</i>, this is the set-off percentage for the tax rate code. For example, a field value of <i>60</i> indicates that 60 percent of the tax amount is recoverable and eligible for setoff. The balance is added to the inventory cost or expensed depending on the treatment defined for the item.</p>
Tax Dependency Code	<p>Displays the tax dependency code assigned to the tax rate code. Tax dependency codes indicate the basis for calculating tax, as well as the precedence of taxes of the same tax type that must be included.</p>
Include Base	<p>If this check box is selected, indicates the inclusion of the base value in the tax calculation. If this check box is clear, the base value is excluded from the tax calculation. For example, this check box may be clear for a surcharge tax component, which is calculated based on a preceding tax component rather than on a base value. However, this check box would generally be selected for basic excise duties and local sales taxes.</p>
Include Freight	<p>If this check box is selected, indicates the inclusion of freight as a part of the base value in tax calculation.</p>
Include Miscellaneous Charges	<p>If this check box is selected, indicates the inclusion of miscellaneous charge expenses as a part of the base value for tax calculation.</p>

Tax Summary

Field or Control	Description
Total Freight Amount	<p>Displays the total freight charge amount for the schedule.</p>

Field or Control	Description
Total Misc Charge Amount (total miscellaneous charge amount)	Displays the total miscellaneous charge amount for the schedule.
Total Item Cost	Displays the total cost of items on the schedule. This value includes the merchandise amount, total freight amount, total miscellaneous charge amount, and total nonrecoverable tax amount.
Total Tax Amount	Displays the total tax amount on the schedule.
Total Recovery Amt (total recovery amount)	Displays the total recoverable tax amount on the schedule.
Total Non-Recovery Amt (total non-recovery amount)	Displays the total nonrecoverable tax amount on the schedule.

Related Links

[Using the Sourcing Workbench](#)

Create PO Page

Use the Create PO page (RUN_PO_POCREATE) to enter run control criteria for the Create Purchase Orders process and run the process.

Navigation:

Purchasing > Purchase Orders > Stage/Source Requests > PO Creation > Create PO

Based on tax determination parameters such as inventory business unit, purchasing business unit, supplier ID, and item ID, the Tax Determination process calculates and stages applicable tax data. The Create Purchase Orders process creates purchase orders from data in the PeopleSoft Purchasing staging tables and populates data to the purchase order tables. The Create Purchase Orders process also works to transfer the tax information populated to the tax staging tables by the Tax Determination and PO Calculations processes to the purchase order tax tables.

Both the Create Purchase Order and PO Change processes use the Build Distribution process (PO_CMBLDDST) to create the distribution and nonprorated distribution temporary tables.

When creating distributions for excise duties and sales tax/VAT, the process prorates customs duties among distributions based on amounts in the customs duty staging table as populated by the Customs Duty Calculation process (PO_CMCSDLIB).

Related Links

[Understanding the Purchase Order Business Process](#)

[Creating Purchase Orders Using the Create Purchase Orders Process](#)

Purge Stage Page

Use the Purge Stage page (RUN_PO_POSTGPRG) to enter run control criteria for the Purge Stage Tables process and run the process.

Navigation:

Purchasing > Purchase Orders > Stage/Source Requests > Purge Stage Tables > Purge Stage Table

Once purchase orders are created, you run the Purge Stage Tables process to purge the Purchasing staging tables. This process also purges the PO_HDR_STG_ESX, PO_STG_TAX_EXS, and PO_STG_TAXD_EXS staging tables, which carry excise duty and sales tax/VAT data. This tax data was originally populated to these tables by the Tax Determination process (FS_EXSLIB) that was invoked as a part of the PO Calculations process.

Related Links

[Purging Purchasing Staging Tables](#)

Processing Excise Duty and Sales Tax/VAT for Online Purchase Orders

In PeopleSoft Purchasing, estimated excise duties and sales tax/VAT are determined at the schedule level and are prorated down to the distribution lines. These excise duties and sales tax/VAT appear by default to purchase orders based on the tax rate code default hierarchy using parameters such as tax component code, tax rate code, tax rate, and tax determination structure.

This section discuss how to Process Excise Duty and Sales Tax/VAT for Online Purchase Orders

Pages Used to Process Excise Duty and Sales Tax/VAT for Online Purchase Orders

<i>Page Name</i>	<i>Definition Name</i>	<i>Navigation</i>	<i>Usage</i>
Maintain Purchase Order - Purchase Order page Page	PO_LINE	Purchasing > Purchase Orders > Add/Update POs > Maintain Purchase Order - Purchase Order	Enter or change purchase order header and line information online.

Page Name	Definition Name	Navigation	Usage
Copy Purchase Order	PO_COPY_TMPLT	<p>Access the Copy From field on the Maintain Purchase Order - Purchase Order.</p> <p>The Copy From field is available only in add mode.</p>	<p>Create a purchase order by copying an existing contract, requisition, or purchase order.</p> <p>This feature includes the ability to copy PO_HDR_EXS, PO_LN_SHIP, EXS_PO_SHIP_TAX, and EXS_PO_LN_DIST information to the new purchase order.</p> <p>The Tax Determination and Tax Calculation processes are triggered upon completion of the copy.</p>
Maintain Purchase Order - Schedules	PO_SCHEDULE	Click the Schedule button on the Maintain Purchase Order - Purchase Order page.	<p>Specify ship to, quantities, due dates, comments, sales and use tax, miscellaneous charges, price adjustments, and multiple distributions per schedule within a purchase order line.</p> <p>Excise duty and sales tax/VAT applicability determination is triggered as a part of the Tax Determination process when you enter a ship to location on the purchase order schedule after entering field values such as the purchasing business unit, supplier, and item on the purchase order header and line.</p>
Express Purchase Order - Purchase Order	PO_EXPRESS	Purchasing > Purchase Orders > Add/Update Express POs > Express Purchase Order - Purchase Order	<p>Enter purchase orders using a rapid-entry version of the Maintain Purchase Order - Purchase Order page, where you can view line, schedule, and distribution information all on one page.</p> <p>However, when using the Express Purchase Order - Purchase Order page you cannot distribute by amount, allocate header miscellaneous charges, or copy from an existing contract, requisition, or purchase order.</p>

Page Name	Definition Name	Navigation	Usage
<u>Excise Duty/Sales Tax/VAT Details for Schedule Page</u>	PO_LN_SHIP_TAX_EXS	<ul style="list-style-type: none"> Click the Excise/Sales Tax button on the Maintain Purchase Order - Schedules page. Click the Excise/Sales Tax button on the Express Purchase Order - Purchase Order page. 	<p>Access excise and sales tax/VAT rate codes, corresponding tax component codes, and calculated results.</p> <p>Access the total excise duty amount, sales tax/VAT amount, excise duty recovery amount, and sales tax/VAT recovery amount at the schedule level.</p>
Maintain Purchase Order - Distributions for Schedule	PO_SCHED_DISTRIB	Click the Distributions/ChartFields button on the Maintain Purchase Order - Schedules page.	Define multiple distributions for each purchase order schedule.
Excise/Sales Tax/VAT Details for Distribution	PO_DISTRIB_TAX_EXS	<ul style="list-style-type: none"> Click the Excise/Sales Tax button on the Maintain Purchase Order - Distributions for Schedule page. Click the Excise/Sales Tax button on the Express Purchase Order - Purchase Order page. 	<p>View excise duties, sales tax/VAT, and customs duties calculated on the purchase order schedule, prorated across the schedule's distribution lines.</p> <p>Excise duty, sales tax/VAT, customs duty amounts appear in the transaction currency and the general ledger base currency.</p> <p>Total excise duty, sales tax/VAT, and customs duty amounts appear for each distribution line.</p>
Purchase Order Inquiry - Schedules	PO_SCHED_INQ	<p>Purchasing > Purchase Orders > Review PO Information > Purchase Orders > Purchase Order Inquiry - Purchase Order</p> <p>Click the Schedule button on the Purchase Order Inquiry - Purchase Order page.</p>	View information about the purchase order schedule.
Excise Duty/Sales Tax/VAT Details for Schedule (inquiry)	PO_SHP_TAX_INQ_EXS	Click the Excise/Sales Tax button on the Purchase Order Inquiry - Schedules page.	Inquire on purchase order excise duty and sales tax/VAT details.

Maintain Purchase Order - Purchase Order page Page

Use the Maintain Purchase Order - Purchase Order page page (PO_LINE) to enter or change purchase order header and line information online.

Navigation:

Purchasing > Purchase Orders > Add/Update POs > Maintain Purchase Order - Purchase Order

Entering field values such as the purchasing business unit, supplier, and item on the purchase order header and line provides processing parameters for excise duty and sales tax/VAT applicability determination, which is triggered as a part of the Tax Determination process when you enter a ship to location on the purchase order schedule.

If you change the ship to location on the schedule and a schedule quantity exists, tax determination and calculation are performed again.

Note: If the **PO Status** header field is set to *Complete* or *Canceled*, you cannot modify tax information on the purchase order.

The following tables store excise duty and sales tax/VAT data for online purchase order entry:

- PO_HDR_EXS
- PO_HDR_WRK_EXS
- PO_LN_SHIP_EXS
- PO_SHIP_TAX_EXS
- PO_LN_DIST_EXS

Field or Control	Description
Total Adj Amt (total adjustment amount)	Total amount of adjustments made to the purchase order. This value includes sales tax/VAT, excise duty, miscellaneous charge, and freight amounts.

Excise Duty/Sales Tax/VAT Details for Schedule Page

Use the Excise Duty/Sales Tax/VAT Details for Schedule page (PO_LN_SHIP_TAX_EXS) to access excise and sales tax/VAT rate codes, corresponding tax component codes, and calculated results.

Access the total excise duty amount, sales tax/VAT amount, excise duty recovery amount, and sales tax/VAT recovery amount at the schedule level.

Navigation:

- Click the **Excise/Sales Tax** button on the Maintain Purchase Order - Schedules page.
- Click the **Excise/Sales Tax** button on the Express Purchase Order - Purchase Order page.

This example illustrates the fields and controls on the Excise Duty/Sales Tax/VAT Details for Schedule page (1 of 2). You can find definitions for the fields and controls later on this page.

Maintain Purchase Order

Excise Duty/ Sales Tax/VAT Details for Schedule 1

Unit	IND01	Item	INDRM002
PO ID	0000000001	Sched Qty	2.0000 EA
Line	1	Price	250.00000
Sched	1	Merchandise Amt	500.00 INR
Ship To	IND01	IN Unit	IND01

Excise/ST/VAT Schedule Dtls

Tax Transaction Type Direct Import Excise Applicable
 Tax Applicable
 Custom Duty Applicable

Excise Applicable

Tax Rate Cd Excise UOM EA
 Excise Use Av Flag Excise Item Category Code RM001
 Assessable Value Excise Currency Reporting INR

Tax Applicable

Tax Rate Cd Ship From State KA
 Reporting Authority KARLST Ship to State KA
 Tax Auth Rate KARLST Sales Item Category Code RM001
 Form Code 37

This example illustrates the fields and controls on the Excise Duty/Sales Tax/VAT Details for Schedule page (2 of 2). You can find definitions for the fields and controls later on this page.

Excise/Sales Tax/VAT and Customs Duty Details Personalize | Find | View All | First 1-2 of 2 Last

Tax Type	Tax Rate Sequence	Tax Component Code	Calculation Scheme	UOM	Tax Percent	Tax Rate Amount	Basis Amount	Tax Amount	Recovery Amount	Non Recovery Amount
Excise		1 BED	Percentage			INR	500.00			
ST/VAT		1 LST	Percentage		8.0000	INR	500.00	40.00	32.00	8.00

Tax Summary

Total Freight Amount	5.00	Total Tax Amount	40.00
Total Misc Charge Amount	1,000.00	Total Recovery Amt	32.00
Total Item Cost	1,725.25	Total Non-Recovery Amt	8.00

Following purchase order excise duty and sales tax/VAT calculations, you can access tax information on the Excise Duty/Sales Tax/VAT Details for Schedule page. The system displays monetary amounts on this page in the transaction currency.

If you change the tax transaction type, the system clears the excise and sales tax/VAT rate codes and reruns the Tax Determination process to determine the tax rate code values appropriate for the new tax transaction type. The system repopulates the tax components and all related tax details to the page.

You have the option to change the values that appear in the **Assessable Value** and excise and sales tax/VAT rate code fields. The tax rate code value populates the transaction using the tax determination hierarchy. You can alter these values to determine the impact on the tax amount in an alternate scenario.

Note: The **Assessable Value** and **Tax Rate Code** fields are unavailable for entry when the purchase order status is *Dispatched*, *Complete*, or *Canceled*.

If you change any of these values, the following actions occur:

- The Tax Calculation process is triggered and the recovery and nonrecovery tax amounts are recalculated and appear.
- When you click the **OK** button, the system prorates the total excise tax amount, excise nonrecovery amount, excise recovery amount, sales tax/VAT amount, sales tax/VAT recovery amount, and sales tax/VAT nonrecovery amount in the transaction currency to the distribution and the general ledger base currency to the EXS_PO_LN_DIST table.

Field or Control	Description
Unit	Displays the purchasing business unit entered on the purchase order header.
Ship To	Displays the ship to location entered on the purchase order schedule.
Sched Qty (scheduled quantity)	Displays the quantity of units ordered.
Price	Displays the unit price of the raw materials expressed in the transaction currency.
Merchandise Amt (merchandise amount)	Displays the total price of the raw materials expressed in the transaction currency.
IN Unit (inventory business unit)	Displays the inventory business unit derived from the ship to location.
Calculate	<p>If you change field values that impact tax derivation or calculation, such as the tax rate code or assessable value, click this button to trigger the Tax Calculation process to recalculate and redisplay taxes.</p> <p>You can click the save or refresh button to initiate the Tax Calculation process. The system recalculates and redisplay the taxes.</p>

Excise/ST/VAT Schedule Dtls

Field or Control	Description
Tax Transaction Type	Tax transaction type assigned to the transaction. Values for purchases are: <i>DIMP</i> (direct import) <i>DOM</i> (domestic) <i>LIMP</i> (local import)
Excise Applicable	Indicates whether excise duties are applicable to the transaction.
Sales Tax Applicable	Indicates whether sales tax/VAT are applicable to the transaction.
Custom Duty Applicable	Indicates whether custom duties are applicable to the transaction. <hr/> Note: If you select this check box, the Custom Duty Applicable group box appears. <hr/>

Custom Duty Applicable

Field or Control	Description
Tax Rate Cd (tax rate code)	Custom duty tax rate code for the transaction derived using the Tax Determination process and tax rate code default hierarchy.

Excise Duty

Field or Control	Description
Tax Rate Cd (tax rate code)	Excise tax rate code for the transaction derived using the Tax Determination process and tax rate code default hierarchy.
Excise Use Av Flag (excise use assessable value flag)	Indicates if the assessable value entered for the item is being used in the tax calculation.
Excise Item Category Code	Default excise tax category code defined for the item.

Field or Control	Description
Excise UOM (excise unit of measure)	Item excise unit of measure.
Assessable Value	<p>If the Excise Use Av Flag check box is selected, the assessable value defined for the item appears by default to this field, and can be overridden. The system calculates excise duties using this assessable value as the base amount.</p> <p>If the Excise Use Av Flag check box is clear, the system uses the schedule merchandise amount as the base amount for tax calculation.</p> <p>The tax location for the transaction is based on the inventory business unit for the ship to location.</p>

Tax Applicable

Field or Control	Description
Tax Rate Cd (tax rate code)	Sales tax/VAT rate code derived using the Tax Determination process and assigned to the transaction.
Reporting Authority	Sales tax/VAT reporting authority derived using the Tax Determination process and assigned to the transaction.
Tax Auth Rate (tax authority rate)	Sales tax/VAT authority rate derived using the Tax Determination process and assigned to the transaction.
Ship From State	Displays the state from which materials are being shipped derived from the supplier location.
Ship to State	Displays the state to which materials are being shipped derived from the ship to location.
Sales Item Category Code	Default sales tax/VAT category code defined for the item.

Excise/Sales Tax/VAT and Custom Duty Details

Field or Control	Description
Tax Type	<p>Displays the tax type associated with the tax component code on the transaction. Values are:</p> <ul style="list-style-type: none"> • <i>Excise</i> (excise duty) • <i>Custom</i> (custom duty) • <i>ST/VAT</i> (sales tax and VAT)
Tax Rate Sequence	Indicates the order in which tax component codes in the tax rate code should be calculated.
Tax Component Code	Displays tax component codes in the selected tax rate code.
Calculation Scheme	<p>Displays the default calculation scheme associated with the selected tax component code. Values are:</p> <p><i>Amount</i>: Ad hoc amount-based tax calculation.</p> <p><i>Percentage</i>: Percentage-based tax calculation. Percentage appears by default.</p> <p><i>Quantity</i>: Quantity-based tax calculation.</p>
Tax Rate UOM (tax rate unit of measure)	<p>If the Calculation Scheme is set to <i>Quantity</i>, displays the unit of measure against which the tax rate amount is applied.</p> <hr/> <p>Note: If the transaction unit of measure is different from the tax rate code unit of measure, the system performs the conversion using the PeopleSoft-delivered unit of measure conversion feature.</p> <hr/>
Tax Rate Pct (tax rate percentage)	If the Calculation Scheme field value is set to <i>Percentage</i> , displays the percentage to be applied against the taxable amount value in the Basis Amount field.

Field or Control	Description
Tax Rate Amount	<p>If the Calculation Scheme field value is set to <i>Quantity</i>, displays the amount to be applied against the transaction quantity, according to the transaction quantity in the Tax Rate UOM value.</p> <hr/> <p>Note: If the transaction unit of measure is different from the tax rate code unit of measure, the system performs the conversion using the PeopleSoft-delivered unit of measure conversion feature.</p> <hr/> <p>If the Calculation Scheme is set to <i>Amount</i>, this is the tax amount.</p>
Basis Amount	Displays the base amount on which tax is calculated.
Tax Amount	Displays the tax amount for the tax rate sequence.
Recovery Amount	Displays the amount of tax that can be recovered based on the Tax Amount and Rcvry Percent values.
Non Recovery Amount	Displays the amount of tax that is nonrecoverable based on the Tax Amount and Tax Percentage values.
Tax Percent	<p>Displays the tax percentage. The system uses this value to split taxes into recoverable and nonrecoverable components.</p> <p>If the Tax Type field value is set to <i>Excise</i>, this is the CENVAT percentage that can be recovered. For example, a field value of <i>100</i> indicates that the full amount of tax is eligible for CENVAT credit.</p> <p>If the Tax Type field value is set to <i>ST/VAT</i>, this is the set-off percentage for the tax rate code. For example, a field value of <i>60</i> indicates that 60 percent of the tax amount is recoverable and eligible for setoff. The balance is added to the inventory cost or expensed depending on the treatment defined for the item.</p>
Tax Dependency Code	Displays the tax dependency code assigned to the tax rate code. Tax dependency codes indicate the basis for calculating tax, as well as the precedence of taxes of the same tax type that must be included.

Field or Control	Description
Include Base	If this check box is selected, indicates the inclusion of the base value in the tax calculation. If this check box is clear, the base value is excluded from the tax calculation. For example, this check box may be clear for a surcharge tax component, which is calculated based on a preceding tax component rather than on a base value. However, this check box would generally be selected for basic excise duties and local sales taxes.
Include Freight	If this check box is selected, indicates the inclusion of freight as a part of the base value in tax calculation.
Include Miscellaneous Charges	If this check box is selected, indicates the inclusion of miscellaneous charge expenses as a part of the base value for tax calculation.

Tax Summary

Field or Control	Description
Total Freight Amount	Displays the total freight charge amount for the schedule.
Total Misc Charge Amount (total miscellaneous charge amount)	Displays the total miscellaneous charge amount for the schedule.
Total Item Cost	Displays the total cost of items on the schedule. This value includes the merchandise amount, total freight amount, total miscellaneous charge amount, and total nonrecoverable tax amount.
Total Tax Amount	Displays the total tax amount on the schedule.
Total Recovery Amt (total recovery amount)	Displays the total recoverable tax amount on the schedule.
Total Non-Recovery Amt (total non-recovery amount)	Displays the total nonrecoverable tax amount on the schedule.

Related Links

[“Understanding PeopleSoft Tax Solutions” \(PeopleSoft Supply Chain Management Integration\)](#)

[Understanding the Purchase Order Business Process](#)

[Using Express Purchase Orders](#)

Processing Customs Duty on Online Purchase Orders

This section provides an overview of purchase order customs duty processing and discusses how to:

Pages Used to Process Customs Duty on Online Purchase Orders

Page Name	Definition Name	Usage
<u>Maintain Purchase Order - Purchase Order Page</u>	PO_LINE	Enter or modify purchase order information online.
Copy Purchase Order Page	PO_COPY_TMPLT	<p>Create a purchase order by copying an existing contract, requisition, or purchase order.</p> <p>This feature includes the ability to copy PO_HDR_EXS, PO_LN_SHIP, EXS_PO_SHIP_TAX, and EXS_PO_LN_DIST information to the new purchase order.</p> <p>The Tax Determination and Tax Calculation processes are triggered upon completion of the copy.</p>
<u>Maintain Purchase Order - Schedules Page</u>	PO_SCHEDULE	Specify ship to, quantities, due dates, comments, sales and use tax, miscellaneous charges, price adjustments, and multiple distributions per schedule within a purchase order line.
<u>Excise Duty/Sales Tax/VAT Details for Schedule Page</u>	PO_LN_SHIP_TAX_EXS	<p>Access excise and sales tax/VAT rate codes, corresponding tax component codes, and calculated results.</p> <p>Access the total excise duty amount, sales tax/VAT amount, excise duty recovery amount, and sales tax/VAT recovery amount at the schedule level.</p>
Maintain Purchase Order - Distributions for Schedule Page	PO_SCHED_DISTRI	Define multiple distributions for each purchase order schedule.

Page Name	Definition Name	Usage
Excise/Sales Tax/VAT Details for Distribution Page	PO_DISTRIB_TAX_EXS	View excise duties, sales tax/VAT, and customs duties calculated on the purchase order schedule, prorated across the schedule's distribution lines. Excise duty, sales tax/VAT, and customs duty amounts appear in the transaction currency and the general ledger base currency. Total excise duty, sales tax/VAT, and customs duty amounts appear for each distribution line.
<u>Express Purchase Order - Purchase Order Page</u>	PO_EXPRESS	Enter purchase orders using a version of the Maintain Purchase Order - Purchase Order page, where you can view line, schedule, and distribution information all on one page. However, when using the Express Purchase Order - Purchase Order page you cannot distribute by amount, allocate header miscellaneous charges, nor copy from an existing contract, requisition, or purchase order.
Purchase Order Inquiry - Schedules Page	PO_SCHED_INQ	View information about the purchase order schedule.
Excise Duty/Sales Tax/VAT Details for Schedule Page(inquiry)	PO_SHP_TAX_INQ_EXS	Inquire on purchase order excise duty and sales tax/VAT details.

Understanding Purchase Order Customs Duty Processing

Customs duty processing applies to import purchase orders with associated customs duty-related charges. Customs duties appear by default on the purchase order based on the tax rate code default hierarchy using parameters such as tax component code, tax rate code, tax rate, and tax determination structure.

Maintain Purchase Order - Purchase Order Page

Use the Maintain Purchase Order - Purchase Order page (PO_LINE) to enter or modify purchase order information online.

Navigation:

Purchasing > Purchase Orders > Add/Update POs > Maintain Purchase Order - Purchase Order

This example illustrates the fields and controls on the Maintain Purchase Order - Purchase Order page. You can find definitions for the fields and controls later on this page.

Field or Control	Description
Item	Entering an item with associated customs duty miscellaneous charges on an import purchase order triggers miscellaneous charge determination and calculation.
PO Qty (purchase order quantity)	Entering or modifying the purchase order quantity for an item with associated customs duty miscellaneous charges on an import purchase order triggers the determination and calculation of applicable miscellaneous charges.

Related Links

[Creating Purchase Order Headers](#)

“Understanding PeopleSoft Tax Solutions” (PeopleSoft Supply Chain Management Integration)

Maintain Purchase Order - Schedules Page

Use the Maintain Purchase Order - Schedules page (PO_SCHEDULE) to specify ship to, quantities, due dates, comments, sales and use tax, miscellaneous charges, price adjustments, and multiple distributions per schedule within a purchase order line.

Navigation:

Click the **Schedule** button on the Maintain Purchase Order - Purchase Order page.

Field or Control	Description
Ship To	Entering or modifying the ship to location for an item with associated customs duty miscellaneous charges on an import purchase order triggers the determination and calculation of applicable miscellaneous charges.

Related Links

[Creating Purchase Order Schedules](#)

Excise Duty/Sales Tax/VAT Details for Schedule Page

Use the Excise Duty/Sales Tax/VAT Details for Schedule page (PO_LN_SHIP_TAX_EXS) to access excise and sales tax/VAT rate codes, corresponding tax component codes, and calculated results.

Access the total excise duty amount, sales tax/VAT amount, excise duty recovery amount, and sales tax/VAT recovery amount at the schedule level.

Navigation:

- Click the **Excise/Sales Tax** button on the Maintain Purchase Order - Schedules page.
- Click the **Excise/Sales Tax** button on the Express Purchase Order - Purchase Order page.

This example illustrates the fields and controls on the Excise Duty/Sales Tax/VAT Details for Schedule page (1 of 2). You can find definitions for the fields and controls later on this page.

Maintain Purchase Order

Excise Duty/ Sales Tax/VAT Details for Schedule 1

Unit IND01	Item INDRM002
PO ID 0000000001	Sched Qty 2.0000 EA
Line 1	Price 250.00000
Sched 1	Merchandise Amt 500.00 INR
Ship To IND01	IN Unit IND01

Excise/ST/VAT Schedule Dtls

Tax Transaction Type Direct Import

Excise Applicable

Tax Applicable

Custom Duty Applicable

Excise Applicable

Tax Rate Cd

Excise Use Av Flag

Assessable Value

Excise UOM EA

Excise Item Category Code RM001

Excise Currency Reporting INR

Tax Applicable

Tax Rate Cd

Reporting Authority KARLST

Tax Auth Rate KARLST

Form Code 37

Ship From State KA

Ship to State KA

Sales Item Category Code RM001

This example illustrates the fields and controls on the Excise Duty/Sales Tax/VAT Details for Schedule page (2 of 2). You can find definitions for the fields and controls later on this page.

Excise/Sales Tax/VAT and Customs Duty Details											
Personalize Find View All First 1-2 of 2 Last											
Tax Type	Tax Rate Sequence	Tax Component Code	Calculation Scheme	UOM	Tax Percent	Tax Rate Amount		Basis Amount	Tax Amount	Recovery Amount	Non Recovery Amount
Excise	1	BED	Percentage				INR	500.00			
ST/VAT	1	LST	Percentage		8.0000		INR	500.00	40.00	32.00	8.00

Tax Summary			
Total Freight Amount	5.00	Total Tax Amount	40.00
Total Misc Charge Amount	1,000.00	Total Recovery Amt	32.00
Total Item Cost	1,725.25	Total Non-Recovery Amt	8.00

OK Cancel Refresh

Excise/ST/VAT Schedule Dtls

Field or Control	Description
Tax Transaction Type	Displays the tax transaction type assigned to the transaction. Values for purchases are: <i>DIMP</i> (direct import) <i>DOM</i> (domestic) <i>LIMP</i> (local import)
Excise Applicable	Indicates whether excise duties are applicable to the transaction.
Tax Applicable	Indicates whether sales tax/VAT are applicable to the transaction.
Custom Duty Applicable	Indicates whether custom duties are applicable to the transaction. Note: If this check box is selected, the Custom Duty Applicable group box will appear.

Custom Duty Applicable

<i>Field or Control</i>	<i>Description</i>
Tax Rate Cd (tax rate code)	Displays the custom duty tax rate code for the transaction that was derived using the Tax Determination process and tax rate code default hierarchy.

Excise/Sales Tax/VAT and Custom Duty Details

<i>Field or Control</i>	<i>Description</i>
Tax Type	Displays the tax type associated with the tax component code on the transaction. Values are: <ul style="list-style-type: none"> • <i>Excise</i> (excise duty) • <i>Custom</i> (custom duty) • <i>ST/VAT</i> (sales tax and VAT)
Tax Rate Sequence	Indicates the order in which tax component codes in the tax rate code should be calculated.
Tax Component Code	Displays the tax component codes in the selected tax rate code.
Calculation Scheme	Displays the default calculation scheme associated with the selected tax component code. Values are: <p><i>Amount</i>: Adhoc amount-based tax calculation.</p> <p><i>Percentage</i>: Percentage-based tax calculation. Percentage appears as the default.</p> <p><i>Quantity</i>: Quantity-based tax calculation.</p>
UOM (unit of measure)	If the Calculation Scheme is set to <i>Quantity</i> , then this field displays the unit of measure against which the tax rate amount is applied. <hr/> <p>Note: If the transaction unit of measure is different from the tax rate code unit of measure, the system performs the conversion using the PeopleSoft-delivered unit of measure conversion feature.</p> <hr/>

Field or Control	Description
Tax Percent	If the Calculation Scheme is set to <i>Percentage</i> , then this field displays the percentage to be applied against the taxable amount value in the Basis Amount field.
Tax Rate Amount	<p>If the Calculation Scheme is set to <i>Quantity</i>, then this field displays the amount to be applied against the transaction quantity, according to the transaction quantity in the UOM value.</p> <hr/> <p>Note: If the transaction unit of measure is different from the tax rate code unit of measure, the system performs the conversion using the PeopleSoft-delivered unit of measure conversion feature.</p> <hr/> <p>If the Calculation Scheme is set to <i>Amount</i>, this is the tax amount.</p>
Basis Amount	Displays the base amount on which tax is calculated.
Tax Amount	Displays the tax amount for the tax rate sequence.
Recovery Amount	Displays the amount of tax that can be recovered based on the Tax Amount and Recovery Percentage values.
Non Recovery Amount	Displays the amount of tax that is nonrecoverable based on the Tax Amount and Tax Percent values.
Recovery Percentage	<p>Displays the recovery percentage. The system uses this value to split taxes into recoverable and nonrecoverable components.</p> <p>If the Tax Type field value is set to <i>Customs</i>, this is the CENVAT percentage that can be recovered for the Customs Duty. For example, a field value of <i>100</i> indicates that the full amount of tax is eligible for CENVAT credit.</p>
Tax Dependency Code	Displays the tax dependency code assigned to the tax rate code. Tax dependency codes indicate the basis for calculating tax, as well as the precedence of taxes of the same tax type that must be included.

Field or Control	Description
Include Base	If this check box is selected, indicates the inclusion of the base value in the tax calculation. If this check box is clear, the base value is excluded from the tax calculation. For example, this check box may be clear for a surcharge tax component, which is calculated based on a preceding tax component rather than on a base value. However, this check box would generally be selected for basic excise duties and local sales taxes.
Include Freight	If this check box is selected, indicates the inclusion of freight as a part of the base value in tax calculation.
Include Miscellaneous Charges	If this check box is selected, indicates the inclusion of miscellaneous charge expenses as a part of the base value for tax calculation.

Tax Summary

Field or Control	Description
Total Freight Amount	Displays the total freight charge amount for the schedule.
Total Misc Charge Amount (total miscellaneous charge amount)	Displays the total miscellaneous charge amount for the schedule.
Total Item Cost	Displays the total cost of items on the schedule. This value includes the merchandise amount, total freight amount, total miscellaneous charge amount, and total nonrecoverable tax amount.
Total Tax Amount	Displays the total tax amount on the schedule.
Total Recovery Amt (total recovery amount)	Displays the total recoverable tax amount on the schedule.
Total Non-Recovery Amt (total non-recovery amount)	Displays the total nonrecoverable tax amount on the schedule.

Express Purchase Order - Purchase Order Page

Use the Express Purchase Order - Purchase Order page (PO_EXPRESS) to enter purchase orders using a version of the Maintain Purchase Order - Purchase Order page, where you can view line, schedule, and distribution information all on one page.

However, when using the Express Purchase Order - Purchase Order page you cannot distribute by amount, allocate header miscellaneous charges, nor copy from an existing contract, requisition, or purchase order.

Navigation:

Purchasing > Purchase Orders > Add/Update Express POs > Express Purchase Order - Purchase Order

This example illustrates the fields and controls on the Express Purchase Order - Purchase Order page (1 of 2). You can find definitions for the fields and controls later on this page.

This example illustrates the fields and controls on the Express Purchase Order - Purchase Order page (2 of 2). You can find definitions for the fields and controls later on this page.

Field or Control	Description
Benefit ID	You must enter a benefit ID for each item on an import purchase order. This information appears by default on BOEs and other reports.

Related Links

[Using Express Purchase Orders](#)

Dispatching and Printing Excise Duty and Sales Tax/VAT Information on Purchase Orders

The PO Dispatch/Print process (POPO005) prints and dispatches purchase orders to suppliers and updates purchase order statuses to *Dispatched*. The process prints and dispatches the following excise duty and sales tax/VAT details.

Dispatch Field Description	Display Level	Details
Excise Registration Number	Header or schedule	<p>If the excise tax registration number is the same for all schedules, the number is provided at the header level.</p> <p>If the numbers are different, the individual numbers are provided at the schedule level.</p>
Sales Tax Registration Number	Header or schedule	<p>For ship-to sales tax registration numbers, if the ship from and ship to combination is the same for all schedules, registration number information is provided at the header level. If the ship from and ship to combination is different for any schedules, registration number information is provided at the schedule level.</p> <p>For ship to sales tax registration numbers, if the ship from and ship to country and state are not the same, the central sales tax (CST) registration number is provided. If the ship from and ship to country and state are the same, the local sales tax (LST) registration number or the VAT taxpayer identification number (TIN) is provided.</p> <p>Supplier sales tax registration numbers (CST and LST) or TIN number are also provided.</p>
Form Code	Header or schedule	n/a
Total Tax Value	Displays for each tax type	n/a
Excise Duty Tax Code	Schedule	Excise tax component code, tax rate, and tax amount are provided.
Sales Tax Code	Schedule	Sales tax component code, tax rate, and tax amount are provided.

Page Used to Dispatch and Print Excise Duty and Sales Tax/VAT Information on Purchase Orders

<i>Page Name</i>	<i>Definition Name</i>	<i>Usage</i>
Purchase Orders Print Page	RUN_PRN_POPO005	Run the PO Dispatch/Print process.

Processing Custom Duty, Excise Duty, and Sales Tax/VAT in Purchase Order Change Orders

When you make changes to a purchase order that affect tax determination, online change order processing and the batch Change Purchase Order process (PO_POCHNG) provide for the redetermination and recalculation of taxes. For example, if you change the ship to location, quantity, or pricing on the schedule, once the changes are validated, tax determination and calculation are triggered, and the process updates excise duty and sales tax/VAT information on purchase order schedules and distributions.

The order items that change determine how the Change Purchase Order process handles changes related to excise duties and sales tax/VAT:

- If the ship to location or item ID changes, new defaults are retrieved and excise duties and sales tax/VAT are recalculated using the Tax Determination process (FS_EXSLIB).
- If the quantity or price changes, excise duties and sales tax/VAT are recalculated using the Tax Calculation process.
- If there are any other valid changes to the schedule, the Change Purchase Order process handles them using the original VAT information.
- If there are no qualifying changes to the schedule, no changes are processed. The PO_SHIP_WRK and PO_DIST_WRK tables are purged to reduce unnecessary processing, as there are no valid changes against them.
- If any errors are encountered, the process issues errors and writes those errors to the message log.

When the Change Purchase Order process for changes related to custom duties taxes is triggered:

- The Change Purchase Order process calls PO_CMFRTMSC and PO_CMBLDDST.

The PO_CMFRTMSC section of the Change Purchase Order process runs the customs duty tax determination and calculation common process.

- Customs duty processing for online purchase order change orders function similarly; when a quantity, item, or ship to location is changed, a change order is triggered, along with customs duty processing.

Page Used to Process Custom Duty, Excise Duty, and Sales Tax/VAT in Purchase Order Change Orders

<i>Page Name</i>	<i>Definition Name</i>	<i>Usage</i>
PO Changes Page	RUN_PO_POCHNG	Run the Change Purchase Order Application Engine process (PO_POCHNG).

Related Links

[Understanding the Purchase Order Business Process](#)

[Understanding the Purchase Order Change Order Business Process](#)

Processing Excise Duty and Sales Tax/VAT in the PO Receipt Push Process

The Receipt Push process (PO_RECVPUSH) takes receipt lines and distributions and joins in purchase order schedule excise duty and sales tax/VAT details to create receipt-landed cost transactions. Receipt-landed cost data is passed on to inventory using the Staged Cost table.

Once landed cost transactions are created for receipt lines, any online changes to the quantities accepted on the receipt are applied to the landed cost transactions upon saving the receipt.

The Receiver Interface Push process passes the receipt lines to the PeopleSoft PO/AP/AM Interface process (AMPS1000). When the Allocate Purchasing Group check box is selected on the Purchasing Options page, the following processing is done for each receipt with a procurement group ID:

- The procurement group asset data is written to the Receipt Line Asset table and the Asset Management Interface table (INTFC_PRE_AM). Online receipts facilitate the process by generating entries in the receipt line asset table that are based on the allocation quantity (or amount) multiple. As such, by the time the Receipt Push process is triggered, the initial receipt line asset structure (as adjusted for procurement groups) is already in place.
- For the item flagged as a primary unit, a separate entry is created in the Asset Management Interface table for each increment of unit allocation quantity or unit allocation amount. Each entry is assigned the next available procurement group sequence.
- Similarly separate entries are created in the PeopleSoft Asset Management interface table for non-primary items for each increment of unit allocation quantity or unit allocation amount. Each non-primary item entry is Arbortext Editor Unformatted Print: temp_ResolvedDoc.xml Printed then assigned the procurement group sequence associated with the corresponding primary unit entry (for example, for each non-primary item, the first unit of allocation gets assigned the same sequence associated with the first primary item unit of allocation and so on).
- The load status on the PeopleSoft Asset Management interface table will be set to PGI (procurement group incomplete) for any procurement grouping (sequence) that does not contain all of the items within a procurement group or if any of the items within that grouping (sequence) do not have a full unit of allocation. Groupings without a primary item will also be set to 'PGI' Procurement group items

are identified by the Receipt Push process by taking into account all transaction line items across all purchase orders that are assigned to that procurement group. Also taken into consideration are requisition lines with asset items that have any open quantity (or amount). For this reason, in terms of asset allocation, the items that comprise a procurement group cannot be changed once the structure has been established (based on existing transactions). If item composition needs to be addressed after a procurement group has already been established, a new procurement group should be utilized instead. Receipt Push will examine older data in the interface table in status 'PGI' to determine if the incoming Receipt Asset Lines can complete the asset.

- Since Receipt Push matches on descriptions (for description only items), care must be exercised when entering a non-primary description only item on a transaction line so that it is spelled exactly as an existing description only item that is intended to be the same item.
- The Receiver Interface Push process keeps the rows in the RECV_LN_ASSET table in sync with the rows in the Asset Management Interface table. This enables future changes to a receipt to be passed to the Asset Management Interface table.

Page Used to Process Excise Duty and Sales Tax/VAT in the PO Receipt Push Process

<i>Page Name</i>	<i>Definition Name</i>	<i>Usage</i>
<u>Process Receipts Page</u>	RUN_PO_RECEIPT	Define parameters to run the Receiver Interface Push process (PO_RECVPUSH) and the Receipt to Inventory & AM multiprocess job (RECV_03).

Related Links

[Using the Receiver Interface Push Application Engine Process \(PO_RECVPUSH\)](#)

Using the Return-To-Vendor (RTV) Excise Adjustment Business Process

This section discusses the RTV Adjustment Business process.

Note: None of the taxes automatically change, calculate, or appear on the actual RTV.

See [Understanding the RTV Business Process](#).

Using a BOE

This section provides overviews of BOE, BOE processing rules, BOE Statuses, and BOE customs duty determination and calculation.

Pages Used to Use a BOE

Page Name	Definition Name	Usage
<u>Maintain Bill of Entry IND Page</u>	BILL_OF_ENTRY	Enter BOEs.
<u>Select Lines Page</u>	BOE_SELECT	Select source rows to add to a BOE.
<u>Header Details Page</u>	BOE_HDR	Access BOE header details.
<u>Bill of Entry Worksheet Page</u>	RUN_POY5070	Enter parameters for the Bill of Entry Worksheet process (POX5070) and run the process.

Understanding BOE

There are two ways in which BOEs are used in customs processing:

- With bonding.

When using BOEs with bonding, you begin tracking customs-applicable goods using BOEs when the supplier delivers the goods to customs. Although the goods are not physically in your organization's possession, you receive the goods into a business unit you have created to represent the customs warehouse, or a bonded warehouse.

- Without bonding.

When using BOEs without bonding, you begin tracking customs-applicable goods after the goods are released from customs and are delivered to you. You receive the goods for putaway to an inventory business unit or inventory warehouse.

The bonded scenario is designed for use when the legal responsibility for the goods transfers from the supplier to your organization upon delivery to customs. Use the nonbonded scenario if the transfer of responsibility occurs upon delivery to you after customs assessment.

The following procedure provides the basic process flow for the nonbonded BOE scenario.

Nonbonded BOE

You must submit a BOE worksheet to customs authorities when a supplier delivers your goods to customs. In addition, customs uses original shipping documents for assessment and confirmation of customs duties.

To create nonbonded BOEs:

1. Create a BOE with a type of *Home Consumption* using a purchase order with a tax transaction type of *Import*.

Use the pro forma invoice from the supplier to provide details needed on the BOE.

2. Set the BOE status to *Ready*.

This designates that the BOE is ready for printing and submission to customs.

3. Save the BOE.

Upon saving, customs duties are determined and calculated.

4. Print the BOE worksheet and submit to customs.

Customs authorities assess the BOE and related goods and return an updated BOE to you.

5. Apply the updates from customs and set the BOE status to *Assessed*.

6. Use PeopleSoft Payables to pay customs duties using a third-party voucher.

7. Receive and put goods away to the appropriate inventory warehouse.

Receipt lines must be associated with an assessed BOE line.

8. Reopen the third-party voucher and enter the receipt ID associated with each voucher line.

This enables the system to calculate and apply any variance between the estimated and actual nonrecoverable customs duties. This variance is applied to the item in PeopleSoft Inventory.

9. Change the BOE line and header statuses to *Closed*.

10. Create an internal supplier excise invoice for the goods using the BOE.

11. Run the Register Update process to update Indian tax registers and record accounting entries.

Understanding BOE Processing Rules

The bill of entry processing rules are:

- The system does not apply receiving tolerance percentages when creating BOEs; therefore, the total purchase order schedule BOE quantity cannot be greater than the purchase order quantity.
- You cannot create BOEs based on amount-only purchase order lines.
- You can add purchase order schedules from multiple purchase orders and suppliers to one BOE.
- When you select a warehousing BOE to copy to an ex-bonded BOE, you can copy lines from any number of warehousing BOEs to one ex-bonded BOE.

However, you can only select lines from warehousing BOEs for copying.

- Consignment orders do not require special handling for BOE or receiving processing.

Consignment orders are processed in the same way as non consignment orders.

- The system uses default values, such as those on the BOE_HDR, only when inserting child rows and are not used for overriding values on existing rows.

For example, suppose that you change the rate value (RT_RATE) on the BOE_HDR record and there are existing BOE_LN records, the rate values on those BOE_LN records are not overridden. However,

new BOE_LN records added after the change to the rate value on the BOE_HDR record receive the new rate value.

Understanding BOE Statuses

The following table provides details about available BOE header and line statuses:

Header Statuses	Possible Line Statuses	Details
<i>Open</i>	<i>Hold, Ready, Assessed, or Closed</i>	<p>When BOE headers and lines are initially added, the BOE status is set to <i>Open</i>.</p> <p>After all lines have reached a status of <i>Ready, Assessed, or Closed</i>, you can change the BOE header status to <i>Ready</i> and print the BOE worksheet.</p>
<i>Ready</i>	<i>Ready, Assessed, or Closed</i>	You can print BOE worksheets only for BOEs in <i>Ready</i> status.
<i>Assessed</i>	<i>Assessed or Closed</i>	<p>Only BOE lines in <i>Assessed</i> status can be associated with receipt lines.</p> <p>After all lines have reached a status of <i>Assessed or Closed</i>, you can change the BOE header status to <i>Assessed</i>.</p> <p>You can apply updates to the BOE worksheet until the header status is changed to <i>Assessed</i>.</p>

Header Statuses	Possible Line Statuses	Details
<i>Closed</i>	<i>Closed</i>	<p>After receiving BOE goods, you can manually change the BOE line status to <i>Closed</i>.</p> <p>After a BOE line has reached a status of <i>Closed</i>, no information on the BOE line can be modified, including the line duty.</p> <p>After all lines have reached a status of <i>Closed</i>, you can change the BOE header status to <i>Closed</i>.</p> <p>After a BOE header has reached a status of <i>Closed</i>, no information on the BOE can be modified.</p> <p>Only BOE lines in <i>Closed</i> status are picked up when creating an internal supplier excise invoice with a type of <i>BOE</i>.</p> <p>After information has been copied from the BOE transactions to the internal supplier excise invoice, the CENVAT Posting process creates the CENVAT entries.</p>

Understanding BOE Customs Duty Determination and Calculation

When source transaction lines (purchase order schedules or BOE lines) are copied to a BOE, the common Customs Duty Determination process (CSD_TAX_DETERM) and Customs Duty Calculation (CSD_TAX_CALC) process are triggered. These processes are also triggered when you change BOE field values that affect tax calculations.

Before calling the Customs Duty Determination process (CSD_TAX_DETERM), the line tax defaults (CSD_TAXDF_LN_RS) must be populated. After the customs duty determination is complete, the process populates the line tax default rows with default values to be transferred to the BOE_LN_DUTY record.

The Customs Duty Calculation process (CSD_TAX_CALC) is then triggered to calculate duty amounts using the line tax defaults populated by the Customs Duty Determination process. After customs duty calculations are complete, the system uses the line tax calculation detail rows to update corresponding fields on the BOE_LN_DUTY record. Corresponding amounts in BOE_LN_DUTY are also updated to reflect amounts in both base and reporting currencies.

Related Links

“Understanding PeopleSoft Tax Solutions” (PeopleSoft Supply Chain Management Integration)

Maintain Bill of Entry IND Page

Use the Maintain Bill of Entry IND page (BILL_OF_ENTRY) to enter BOEs.

Navigation:

Purchasing > Receipts > Maintain Bill of Entry IND

This example illustrates the fields and controls on the Maintain Bill of Entry IND page. You can find definitions for the fields and controls later on this page.

You can create a BOE for a single purchase order, multiple purchase orders, or a portion of a purchase order. BOEs are associated with a purchasing business unit.

Field or Control	Description
Import Export Code	This field appears by default from the import export code defined for the organization assigned to the selected tax location.
BOE Status	Select the bill of entry header status. Values are: <i>Hold</i> , <i>Closed</i> , and these values: <i>Open</i> : This is the default value. <i>Ready</i> : Indicates that the BOE worksheet is ready for printing. <i>Assessed</i> : Indicates that all BOE worksheet details are final and goods can be received by the importer.
Bill of Lading and BOL Date (bill of lading date)	Enter a bill of lading and bill of lading date.

Bill of Entry Lines

Use the **Bill of Entry Lines** scroll area to access and enter BOE line details.

Line/Quantity Tab

Field or Control	Description
Select	Select the BOE line for which you want to display details in the Line Duties scroll area.

Field or Control	Description
BOE Status	Select the bill of entry line status. Values are: <i>Hold</i> , <i>Closed</i> , and these values: <i>Open</i> : This is the default value. <i>Ready</i> : Indicates that the BOE line is ready for printing. <i>Assessed</i> : Indicates that all BOE line details are final and goods can be received by the importer.
Quantity Available	Quantity available to be assigned to the BOE. If the purchase order schedule is associated with another BOE, this quantity is the purchase order schedule quantity less the quantity associated with the other BOE.
BOE Quantity	Quantity assigned to the BOE. The default value is the purchase order quantity. You can modify this quantity; however, the quantity can never exceed the purchase order quantity available to be associated with a BOE. This purchase order quantity is expressed in the BOE unit of measure, which may be different from the purchase order unit of measure.
UOM (unit of measure)	The default value is the value entered on the Bill of Entry - Header Details page. If you do not enter a value on that page, this value is set to the purchase order quantity unit of measure. You can modify this value.

Amounts Tab

Select the **Amounts** tab.

Field or Control	Description
Amount	The default value is the purchase order merchandise amount expressed in the reporting currency defined for the line. This value changes according to the value that you enter in the BOE Quantity field.
Currency	The default value is the reporting currency defined on the Bill of Entry - Header Details page. If you do not enter a value on that page, this value is set to the purchase order currency.
Rate Type	The default value is derived from the BOE header.

Field or Control	Description
Rate (RPT => PO) (exchange rate from reporting to purchase order currency)	This is the exchange rate applied between the reporting and purchase order currencies using the rate type defined at the BOE header. You can modify this value.
Freight	Enter any applicable freight costs.
Insurance	Enter any applicable insurance costs.
Other Cost	Enter any other costs.
CIF Amount (charge-in-full amount)	This is the sum of the merchandise amount expressed in the reporting currency, and the amounts in the Freight, Insurance and Other Cost fields, also expressed in the reporting currency.
Landing Charges	<p>Generally, this is one percent of the CIF amount, expressed in the reporting currency. You can modify this value.</p> <p>If the value in the CIF Amount field changes at any point due to a modified quantity or changes to the Freight, Insurance, and Other Cost field values, the existing landing charge based on the one percent of the CIF amount is overridden and the overriding value is used.</p>
Assess Value	This is the sum of the CIF and landing charges amounts and is used to calculate customs duties.

Duty Totals Tab

Select the **Duty Totals** tab.

Field or Control	Description
Custom Duty	Total customs duty amount for the BOE line. The amount reflects the sum of corresponding amounts in the Line Duties scroll area.
Custom Revry (custom recovery)	Total recoverable customs duty amount for the BOE line. The amount reflects the sum of corresponding amounts in the Line Duties scroll area.

<i>Field or Control</i>	<i>Description</i>
Custom NRevry (custom nonrecovery)	Total nonrecoverable customs duty amount for the BOE line. The amount reflects the sum of corresponding amounts in the Line Duties scroll area.

Details Tab

Select the **Details** tab.

<i>Field or Control</i>	<i>Description</i>
Benefit ID	The default is the purchase order benefit scheme ID.
Exempt ID	Enter an applicable customs duty exemption ID.

PO Qty/Price Details Tab

Select the **PO Qty/Price Details** tab.

The **PO Qty/Price Details** (purchase order quantity/price details) tab displays purchase order details for each BOE line.

<i>Field or Control</i>	<i>Description</i>
Unit Price	The default value is the purchase order unit price.

Line Duties

<i>Field or Control</i>	<i>Description</i>
Seq Nbr (sequence number)	The sequence appears by default from the Schedule - Miscellaneous Charges page.
Misc Chg (miscellaneous charge)	All customs duty-related miscellaneous charge codes associated with each line item appear by default on the page.

Field or Control	Description
Calc Method (calculation method)	<p>Method by which the miscellaneous charge is calculated. For customs duty-related miscellaneous charges, the following values apply:</p> <p><i>Flat Amt</i> (flat amount): Charge is a flat amount. This amount can be entered on the Miscellaneous Charges - Miscellaneous page.</p> <p><i>Unit Amt</i> (per unit amount): Used to calculate the charge based on a unit price multiplied by the number of units. You can enter the unit price on the Miscellaneous Charges - Miscellaneous page.</p> <p><i>% Value</i> (percentage of value): Used to calculate the charge based on a percentage of the assessable value on the purchase order schedule. This percentage is defined on the Misc Charge/Landed Cost Defn (miscellaneous charge/landed cost definition) page, but can be overridden on the Miscellaneous Charges - Miscellaneous page.</p>
Value % (value percent)	If the calculation method is set to <i>% Value</i> , it displays the percentage defined on the Misc Charge/Landed Cost Defn page to be applied to the assessable value of the item. You can modify this value.
Flat Amount	If the calculation method is <i>Flat Amt</i> , it displays the flat amount of the charge entered on the Miscellaneous Charges - Miscellaneous page. You can modify this value.
Dependency Code	Dependency code associated with the customs duty-related miscellaneous charge.
Unit Price	If the calculation method is <i>Unit Amt</i> , it displays the unit price for the item's miscellaneous charge
Custom Duty	Miscellaneous charge amount based on the calculation method and applicable values.
Custom Rcvry (custom recovery)	Displays the recoverable customs duty amount based on the recoverable tax percent.
Custom NRcvry (custom nonrecovery)	Displays the nonrecoverable customs duty amount based on the recoverable tax percent.

Page Actions

Field or Control	Description
Add Lines	Click this button to access the Select Lines page, where you can select purchase order schedules to add to the BOE.
Header Details/Line Defaults	Click this link to access the Header Details page, where you can access BOE header details.
Recalculate Duties	Click this button to recalculate customs duties based on any changes made to BOE worksheet. The system recalculates all lines on the BOE. When calculations are complete, the BOE worksheet is ready for printing. Set the header status to <i>Ready</i> . Note: Saving the BOE also triggers recalculation.

Select Lines Page

Use the Select Lines page (BOE_SELECT) to select source rows to add to a BOE.

Navigation:

Click the **Add Lines** button on the Maintain Bill of Entry IND page.

This example illustrates the fields and controls on the Select Lines page. You can find definitions for the fields and controls later on this page.

Note: Available fields on this page appear based on the **BOE Type** field value.

<i>Field or Control</i>	<i>Description</i>
Business Unit	Displays the PeopleSoft Purchasing business unit for the BOE. This is the business unit that initiated the purchase of the customs duty-applicable goods for which you are creating the BOE.
Bill of Entry	Displays the system-generated BOE reference number.

Field or Control	Description
BOE Type	<p>Displays the BOE type. Values are:</p> <p><i>Home Consumption</i>: Select to designate that the goods are to be transferred from customs authorities directly to your inventory warehouse for consumption.</p> <p><i>Warehousing</i>: Select to designate that the goods are to be transferred from customs authorities to a bonded customs warehouse for storage until you need to consume them. These goods are to be received in your system using an inventory business unit representing the bonded warehouse. When you are ready to consume the goods, you create an ex-bonded BOE worksheet and do an interunit transfer to move the goods from the customs bonded warehouse to the inventory warehouse.</p> <p>If <i>Home Consumption</i> or <i>Warehousing</i> is selected, the system populates the Lines Available for Selection scroll area with purchase order schedules that meet the selection criteria and the following requirements when you click the Search button:</p> <ul style="list-style-type: none"> • Purchase order schedule direct import tax transaction type: <i>DIMP</i> • Purchase order schedule: The schedule is not already fulfilled on a BOE. <p>The BOE quantity that appears is the purchase order schedule quantity less the sum of the BOE quantities for all BOEs for the purchase order schedule that have a BOE type of <i>Home Consumption</i> or <i>Warehousing</i>.</p> <p>You can select one or more rows to copy to the BOE. After you select source rows and click OK, information from the source purchase order schedules is copied to the new BOE line and BOE line duty records.</p> <p>The Customs Duty calculation routine is triggered to calculate duties based on the quantity that appears by default to the BOE lines.</p> <p><i>Ex-Bond</i>: Select to designate that goods are being moved from a bonded customs warehouse to the inventory warehouse for consumption.</p> <p>If selected, the system populates the Lines Available for Selection scroll area with BOE lines that meet the selection criteria and the following requirements when you click the Search button:</p> <ul style="list-style-type: none"> • BOE type: <i>Warehousing</i>. • Exemption ID: clear. • BOE status: <i>Closed</i>. • BOE quantity: The BOE quantity has not been fulfilled by another BOE with a BOE type of <i>Ex-Bond</i>. <p>The BOE quantity that appears for the row is the BOE quantity from the warehousing BOE line less the sum of</p>

Field or Control	Description
	<p>the BOE quantity for any existing ex-bond BOE lines for the corresponding warehousing BOE line.</p> <p>You can select one or more rows to copy to the ex-bond BOE.</p> <p>After you select source rows and click OK, information from the source warehousing BOE is copied to the new ex-bond BOE line and BOE line duty records.</p> <p>The customs duty calculation routine is triggered to calculate duties based on the quantity that appears by default to the ex-bonded lines.</p>
Bill of Lading	This field appears when the BOE Type field is set to <i>Ex-Bond</i> .
BU From (from business unit)	This field appears when the BOE Type field is set to <i>Ex-Bond</i> . This is the business unit representing the bonded customs warehouse from which the goods are being transferred to the ex-bonded warehouse.
BOE Ref ID (BOE reference ID)	This field appears when the BOE Type field is set to <i>Ex-Bond</i> . This is the warehousing BOE used as the source transaction for the ex-bonded BOE.
License	This field appears when the BOE Type field is set to <i>Ex-Bond</i> . This is the license assigned to the bonded customs warehouse that stored the ex-bonded goods.
Item SetID	Enter the item SetID for which you want to return applicable transaction lines.
Item ID	Enter the item for which you want to return applicable transaction lines.
Exempt ID	This field appears when the BOE Type field is set to <i>Ex-Bond</i> . This is the exemption ID on the source BOE line.
Search	Select to display qualifying BOE source lines in the Lines Available for Selection scroll area.

Line/Quantity

Field or Control	Description
BU From (from business unit)	This field appears when the BOE Type field is set to <i>Ex-Bond</i> . This is the business unit representing the bonded customs warehouse from which the goods are being transferred to the ex-bonded warehouse.

Field or Control	Description
BOE Ref ID (BOE reference ID)	This field appears when the BOE Type field is set to <i>Ex-Bond</i> . This is the warehousing BOE used as the source transaction for the ex-bonded BOE.
BOE Ref Line	This field appears when the BOE Type field is set to <i>Ex-Bond</i> . This is the warehousing BOE line used as the source transaction for the ex-bonded BOE.
BOE Quantity	Quantity to assign to the BOE expressed in unit of measure entered in the UOM field. This is the purchase order quantity, which may have been converted if the UOM field value is different from the purchase order unit of measure. You can modify this quantity on the BOE; however, the quantity can never exceed the purchase order quantity available to be associated with a BOE.
UOM (unit of measure)	The default value is the value entered on the Bill of Entry - Header Details page. If you do not enter a value on that page, this value is set to the purchase order quantity unit of measure. You can modify this value on the BOE.
Amount	This field appears when the BOE Type field is set to <i>Ex-Bond</i> . This is the merchandise amount from the source BOE line.
Currency	The default value is the reporting currency defined on the Bill of Entry - Header Details page. If you do not enter a value on that page, this value is set to the purchase order currency. This currency must be the same currency defined in the miscellaneous charge setup for the selected item. The system issues an error for rows for which the currency codes do not match, because it is unable to calculate customs duty amounts. Use the currency override on the Bill of Entry - Header Details page to set the reporting currency to the correct value.
OK	Click to copy selected lines to the BOE worksheet.

Related Links

“Understanding PeopleSoft Tax Solutions” (PeopleSoft Supply Chain Management Integration)

Header Details Page

Use the Header Details page (BOE_HDR) to access BOE header details.

Navigation:

Click the **Header Details/ Line Defaults** link on the Maintain Bill of Entry IND page.

This example illustrates the fields and controls on the Header Details page. You can find definitions for the fields and controls later on this page.

Default values, such as those available for entry on this page are used only when inserting new rows and are not used for overriding values on existing rows. For example, suppose that you change the rate value (RT_RATE) on this page and there are existing BOE_LN records, the rate values on those existing BOE_LN records are not overridden. However, new BOE_LN records inserted after you change the rate value receive the new rate value.

Amount fields appear in the reporting, or local currency.

Field or Control	Description
Bill of Entry	Displays the BOE ID and type.
BOE Status	Displays the BOE header status.
Bonded Warehouse License	This field is available for entry for warehousing BOEs.
Validity Date	This field is available for entry for warehousing BOEs.
Port Code	Enter an applicable port code. This value is stored for informational purposes.

Field or Control	Description
Ship Mode	Select the applicable mode of shipment. This value is stored for informational purposes. Values are: <i>Air</i> <i>Land</i> <i>Sea</i>
Gross Weight	Enter the gross weight of the shipment. This value is stored for informational purposes.
No. of Packages (number of packages)	Enter the number of packages included in the shipment of goods on the BOE. This value is stored for informational purposes.
Customs House Agent Code	Following BOE assessment, enter the code for the customs agent responsible for the BOE assessment.
Customs House Number	Following BOE assessment, enter the number for the customs house responsible for the BOE assessment.
Customs BOE ID	Following BOE assessment, enter a BOE reference number issued by customs authorities.
Customs BOE Date	Following BOE assessment, enter a BOE assessment date issued by customs authorities.
Custom Duty	Reflects the sum of corresponding amounts on BOE lines.
Custom Rcvry (customs recovery)	Reflects the sum of corresponding amounts on BOE lines.
Custom NRcvry (customs nonrecovery)	Reflects the sum of corresponding amounts on BOE lines.

Line Defaults

The **Line Defaults** group box does not appear for ex-bonded BOEs. In this case, you can perform necessary overrides at the line level.

Field or Control	Description
Unit of Measure	Enter a unit of measure to be used as a line default line value for new rows that you insert. This value does not override the default unit of measure for existing lines.

Field or Control	Description
Currency Code - Reporting	This field appears by default from the currency code assigned to the selected tax location.

Override Rate

Field or Control	Description
Currency Code	Enter a currency code to override the default reporting currency code on new rows that you insert.
Rate (RPT => PO))	<p>Exchange rate between the default reporting currency code and the override currency code that you enter using the selected rate type. Click the Calculate Exchange Rate button to have the system calculate the rate for you.</p> <p>This rate is to be used as a line default line value for new rows that you insert. This value does not override the default rate for existing lines.</p>
Rate Type	<p>Rate type to use to calculate the exchange rate between the default reporting currency code and the override currency code that you have entered.</p> <p>This rate type is to be used as a line default line value for new rows that you insert. This value does not override the default rate type on existing lines.</p>
Calculate Exchange Rate	Click to calculate the exchange rate between the default reporting currency code and the override currency code that you have entered.

Bill of Entry Worksheet Page

Use the Bill of Entry Worksheet page (RUN_POY5070) to enter parameters for the Bill of Entry Worksheet process (POY5070) and run the process.

Navigation:

Purchasing > Receipts > Reports > Bill of Entry Worksheet

This example illustrates the fields and controls on the Bill of Entry Worksheet page. You can find definitions for the fields and controls later on this page.

Bill Of Entry Worksheet

Run Control ID BOE Report Manager Process Monitor Run

Language English

Report Request Parameters

Business Unit

Bill of Entry Type

Bill of Entry To

BOE Date To

Save Notify Add Update/Display

Field or Control	Description
Business Unit	Enter the purchasing business unit for which you want to print BOE worksheets. To print BOE worksheets for all business units, do not enter a value.
Bill of Entry Type	Select the type of BOE worksheets that you want to print. To print BOE worksheets for all types, do not select a value. Values are: <i>Ex-Bond</i> <i>Home Consumption</i> <i>Warehousing</i>
Bill of Entry/To	Enter the range of BOE numbers that you want to print. Only BOEs in <i>Ready</i> status are available for selection.
BOE Date/To	Enter the date range for the BOEs that you want to print. The system prints BOEs in <i>Ready</i> status that have BOE dates that meet the date range criteria.

Bill of Entry Page

Use the Bill of Entry page (Purchasing, Receipts, Maintain Bill of Entry IND).

You update a BOE worksheet in the system after it has been assessed by customs authorities. The custom authorities for the imported goods return the BOE to you (the importer) for confirmation of the assessable value and customs duty amounts assigned.

You make updates to BOEs in *Ready* status according to the assessment by customs authorities with the intention of changing the status to *Assessed*. As you update each BOE line, you change the line status to *Assessed*, which indicates that information on the BOE line is correct and final. You can change the BOE header status to *Assessed* after each line is in *Assessed* status.

Common updates resulting from customs authority assessment of BOEs include the application of the following:

- A different exchange rate, which affects the assessable value of goods.
- A different customs duty rate.
- An additional customs duty.

Receiving Against a BOE

This section provides an overview of the BOE receipts and discusses how to Receive Against BOE

Pages Used to Receive Against BOE

Page Name	Definition Name	Usage
Select Purchase Order - Search Criteria Page	PO_PICK_ORDERS	Search for and retrieve BOE-related purchase order schedules to add to a receipt.
Maintain Receipts - Receiving Page	RECV_WPO	Create receipts for non-purchase order and purchase order line items.
Maintain Receipts - Receipt Line Details for Line Page	RECV_WPO_DETAILS	View receipt line details, including information about any associated BOEs. The page displays the originating BOE business unit, BOE ID, BOE type, and BOE line.

Understanding the BOE Receipts

You can receive imported goods only after you have updated the BOE worksheet for the goods according to the customs authority assessment and have set the BOE status to *Assessed*. Generally, a factory location can receive goods only when they are associated with an assessed BOE.

When receiving imported goods, you must associate each receipt line must with a BOE. This association affects the timing of customs duty credit recorded in the CENVAT Value-Raw Material register and CENVAT Value - Capital Goods register.

Related Links

[Understanding the Receiving Business Process](#)

Select Purchase Order - Search Criteria Page

Use the Select Purchase Order - Search Criteria page (PO_PICK_ORDERS) to search for and retrieve BOE-related purchase order schedules to add to a receipt.

Navigation:

- **Purchasing > Receipts > Add/Update Receipts > Select Purchase Order - Search Criteria**
- Click the **Select Purchase Order** link on the Maintain Receipts - Receiving page.
- Access the Maintain Receipts - Receiving page in Add mode.

When receiving a purchase order schedule with a tax transaction type of *Import* (EXS_TAX_TXN_TYPE = *DIMP*), you are required to enter a BOE line for each receipt line. The quantity open for receipt is the quantity on the BOE line (BOE_LN.QTY_PO) selected for the purchase order schedule less the sum of the receipt line quantities (QTY_SH_NETRCV_VUOM) for the BOE line.

Field or Control	Description
PO Unit	Enter the purchasing business unit associated with the BOE that you want to receive against.
ID	<p>Enter the BOE number for a BOE line that you want to associate with a receipt. BOEs available for selection meet the following criteria:</p> <ul style="list-style-type: none"> • BOE type set to <i>Home Consumption</i> or <i>Warehousing</i>. Ex-bonded BOEs are not available for selection because ex-bonded goods have already been received using a warehousing BOE. Ex-bonded BOEs are used to move goods from a bonded customs warehouse to an inventory business unit by way of an interunit transfer. • BOE header status set to <i>Ready</i> or <i>Assessed</i>. <p>The search criteria that you enter in the ID field are interpreted by the system using the following hierarchy. Data is retrieved to the Retrieved Rows scroll area in an order that corresponds to the hierarchy.</p> <ul style="list-style-type: none"> • The ID that you enter is a PO ID for a non-direct-import purchase order. If applicable, purchase order lines and schedules on this purchase order are included in the first possible set of rows in the scroll area. • The ID that you enter is a contract ID. If applicable, purchase order lines and schedules associated with this contract ID are included in the second possible set of rows in the scroll area. • The ID that you enter is interpreted as either the BOE ID or the purchase order ID referenced on the BOE line. If applicable, purchase order lines and schedules associated with this BOE ID are included in the third possible set of rows in the scroll area.

Retrieved Rows

<i>Field or Control</i>	<i>Description</i>
PO Qty (purchase order quantity)	For purchase order schedules with associated BOE lines, the purchase order quantity reflects the BOE quantity.

Related Links

[Managing Receipts](#)

Maintain Receipts - Receiving Page

Use the Maintain Receipts - Receiving page (RECV_WPO) to create receipts for non-purchase order and purchase order line items.

Navigation:

Purchasing > Receipts > Add/Update Receipts > Maintain Receipts - Receiving

After you have received goods for a BOE line using the Receiving page, you manually update the BOE line and set its status to *Closed*. Upon closing the BOE line, the system validates that the received quantity is equal to the BOE line quantity. You update the BOE header status to *Closed* when all BOE lines are in *Closed* status.

This example illustrates the fields and controls on the Maintain Receipts - Receiving page. You can find definitions for the fields and controls later on this page.

Receipt Lines

Field or Control	Description
Receipt Qty (receipt quantity)	<p>When receiving purchase order schedules with associated BOE lines, the default receipt quantity is the BOE quantity if you selected the Ordered Quantity option on the Pick Purchase Order page. The receipt quantity is the BOE open quantity that you selected the PO Remaining Qty option on the Pick Purchase Order page.</p> <p>Existing receiving tolerances are overridden and the system validates that the receipt quantity does not exceed the BOE quantity.</p>
Accept Qty (accepted quantity)	<p>When receiving purchase order schedules with associated BOE lines, the default accept quantity is the BOE quantity if you selected the Ordered Quantity option on the Pick Purchase Order page. The accept quantity is the BOE open quantity, if you selected the PO Remaining Qty option on the Pick Purchase Order page.</p> <p>Existing receiving tolerances are overridden and the system validates that the accepted quantity does not exceed the BOE quantity.</p>

More Details

Field or Control	Description
Allocation Type	<p>Displays the allocation type for the receipt. The method selected is used when the receipt quantity is less than the quantity ordered. This field appears by default from the Purchasing Definition - Business Unit Options page. Values are:</p> <ul style="list-style-type: none"> • <i>FIFO (first-in-first-out)</i>: Allocations to the distribution quantities are fulfilled based on the sequence in which they are added to the purchase order schedule for purchase order receipts or the receipt line for non-purchase order receipts. • <i>Prorate</i>: The receipt amount is prorated across the distributions for the schedule based on what percentage the receipt amount is to the total purchase order schedule's distribution amount. For example, if 50% of the required items were received, each distribution line would be allocated 50 percent of its required quantity. • <i>Specify</i>: The user will specify the quantity received for each distribution line. • <i>Split Distribution</i>: Automatically assign the same Asset Grouping Sequence for both Serialized and Non-Serialized items to the same asset line across all the distributions. Each split unit will automatically be assigned the same asset grouping sequence number so that PeopleSoft Asset Management will assign the same asset ID to each fractional unit. <hr/> <p>Note: Allocation type on receipt page defaults from the BU level. But if you specify a value for IN unit on PO distribution page, allocation type for its receipt will be FIFO.</p> <hr/>

Related Links

[Understanding the Receiving Business Process](#)

Running the Receiver Interface Push Process with Customs Duty

The Receipt Push process (PO_RECVPUSH) creates landed cost transactions for nonrecoverable customs duty amounts. The nonrecoverable customs duty amount is derived from the PO Value Adjustment record for the corresponding receipt line. This information is passed on to inventory and cost management along with other landed cost transactions.

If the purchase order schedule associated with the receipt line contains customs duties and has a tax transaction type of import (EXS_TAX_TXN_TYPE = DIMP) and the miscellaneous charge on the schedule is for customs duty (DST_ACCT_TYPE = CSDN), the Receipt Push process creates receipt-landed cost transactions for the nonrecoverable customs duties. If the tax transaction type is not set to *Import*, the process does not create receipt-landed cost transactions.

Related Links

[Using the Receiver Interface Push Application Engine Process \(PO_RECVPUSH\)](#)

Creating Internal Supplier Excise Invoices Against a BOE

This section discuss how to Create Internal Supplier Excise Invoices Against a BOE:

Pages Used to Create Internal Supplier Excise Invoices Against a BOE

Page Name	Definition Name	Usage
Internal Supplier Excise Invoice Search Page	EXD_SUP_INV_SRCH	Select receipt lines for internal supplier excise invoice creation.
Maintain Vndr Excise Invce IND Page (maintain supplier excise invoice IND)	EXD_SUP_INVOICE	Create and modify internal supplier excise invoices. Internal supplier excise invoices in <i>Ready</i> and <i>Posted</i> statuses cannot be modified.

Internal Supplier Excise Invoice Search Page

Use the Internal Supplier Excise Invoice Search page (EXD_SUP_INV_SRCH) to select receipt lines for internal supplier excise invoice creation.

Navigation:

Access the Maintain Vndr Excise Invce IND page in Add mode.

Click the **Select Receipt** link on the Internal Supplier Excise Invoice Search page.

Field or Control	Description
Exc Doc Num Sr (excise document number series)	Enter an appropriate excise document number series for BOEs on the prompt page.

Field or Control	Description
Excise Tx Type (excise transaction type)	<i>BOE</i> (bill of entry): As a result of selecting an excise document number series for BOEs, the BOE excise transaction type appears. When displayed, the Supplier Excise Invoice Search page provides for the search and selection of BOE transactions instead of receipt transactions.
BU From	Enter the business unit associated with the BOE for which you want to create an internal supplier excise invoice.
Bill of Entry	Enter the BOE for which you want to create an internal supplier excise invoice.
Bill of Lading	Enter the bill of lading associated with the BOE for which you want to create an internal supplier excise invoice.
PO Unit	Enter the purchasing business unit associated with the BOE for which you want to create an internal supplier excise invoice.
PO ID	Enter the purchase order associated with the BOE for which you want to create an internal supplier excise invoice.

Receipt Lines

Lines returned in the **Receipt Lines** scroll area are BOE lines in *Closed* status that have not already been assigned to an internal supplier excise invoice line.

Related Links

[Managing Receipts](#)

Creating Internal Supplier Excise Invoices for BOE Transactions

Access the Exd Vnd Invoice page (Purchasing, Receipts, Maintain Vndr Excise Invce IND).

Note: All tax amounts that appear on this page reflect customs duty amounts.

Information on the BOE lines that you selected on the search page are copied to the internal supplier excise invoice. The common Customs Duty Determination and Calculation routines are not triggered for internal supplier excise invoices for which the excise transaction type is set to *BOE*. In addition, the Excise Duty and Sales Tax Determination and Calculation routines are not triggered. You cannot modify invoice line or tax details and the **Calculate** button is unavailable.

You create an internal supplier excise invoice for a BOE to enable the Register Update process to pick up the recoverable portion of the customs duty on the BOE. The nonrecoverable portion of the customs duty is passed to PeopleSoft Cost Management by the Receiver Interface process (PO_RECVPUSH). For this reason, when the excise transaction type is set to *BOE*, the nonrecoverable customs duty amount

is always set to 0, and therefore the customs duty amount may not be the sum of the recoverable and nonrecoverable customs duty amounts. If the nonrecoverable amount were included on the BOE internal supplier excise invoice, the amount would be posted to the general ledger twice, once through PeopleSoft Cost Management and again through the Register Update process.

Field or Control	Description
Excise Tx Type (excise transaction type)	<i>BOE</i> (bill of entry): As a result of selecting an excise document number series for BOEs, the BOE excise transaction type appears.
Value Register Update Flag	This option is selected once the value register has been updated for the selected internal supplier excise invoice.
Total Amount	Total merchandise amount for goods on the internal supplier excise invoice.
Total Tax Amount	Total customs duty amount for goods on the internal supplier excise invoice.
Recovery Amt (recovery amount)	Total recoverable customs duty amount for goods on the internal supplier excise invoice.
Non Recovery	Total nonrecoverable customs duty amount for goods on the internal supplier excise invoice.

Invoice Line

Field or Control	Description
Item ID	Item associated with the BOE line, along with its description.
Price	Unit price for the goods on the BOE line.
Accept Qty (accepted quantity)	Purchase order quantity from the BOE line converted to the standard unit of measure.
UOM (unit of measure)	Standard unit of measure for the selected item.
Assessable Value	Assessable value for the BOE line.

Field or Control	Description
Assess Value	Assessable value of the goods from the BOE line. <hr/> Note: When the Excise Tx Type field is set to <i>BOE</i> , the Assessable Value and Assess Value field values are always equal. <hr/>
Excise Amt (excise amount)	Total customs duty amount for the invoice line.

More Tab

Select the **More** tab.

Field or Control	Description
EXD-NonRcvry Amt (excise duty - nonrecovery amount)	Recoverable customs duty amount for goods on the internal supplier excise invoice line.
EXD-Recov Amt (excise duty - recovery amount)	Nonrecoverable customs duty amount for goods on the internal supplier excise invoice line.
Currency	Transaction currency for the internal supplier excise invoice.

Source Information Tab

Select the **Source Information** tab.

Field or Control	Description
PO Unit	Purchasing business unit on the BOE line.
PO No/PO Line/PO Sched (purchase order number/purchase order line/purchaser order schedule)	Purchase order details associated with the BOE line.
BU From	Business unit associated with the BOE line.

Field or Control	Description
BOE Type	Displays the source BOE type. Values are: <i>Consume</i> <i>Warehouse</i> <i>Ex-Bond</i>
Bill of Entry	Bill of entry that you are associating with the internal supplier excise invoice.
BOE Line	Bill of entry line that you are associating with the internal supplier excise invoice.
Bill of Lading	Bill of lading associated with the BOE.

Excise Tax Details

Field or Control	Description
Tax Type	When the excise transaction type is set to <i>BOE</i> , this field displays the <i>Excise</i> tax type. However, tax amounts that appear on this page reflect customs duty amounts.
Tax Pct (tax percent)	When the excise transaction type is set to <i>BOE</i> and the calculation method from the BOE is set to <i>% Value</i> , it displays the percentage to be applied to the assessable value of the item to derive the customs duty amount.
UOM (unit of measure)	Unit of measure for the BOE line.
Tax Amount	Customs duty amount for the rate sequence based on BOE.
NRevry Amt (nonrecovery amount)	Nonrecoverable customs duty amount for the rate sequence.
Recovery Amount	Recoverable customs duty amount for the rate sequence.

Viewing India Localization Reports

This table describes the Purchasing report provided for India localization.

Report ID and Name	Description	Run Control Page
POX5070, BOE Worksheet Page	Provides a printout of bill of entry worksheets for submission to customs authorities.	RUN_POY5070

See the product documentation for *PeopleTools: Process Scheduler*

Delivered Workflows for PeopleSoft Purchasing

Delivered Workflows for PeopleSoft Purchasing

This section discusses PeopleSoft Purchasing workflows. The workflows are listed alphabetically by workflow name.

Bank Statement Arrived

This section discusses the Bank Statement Arrived workflow.

Description

<i>Information Type</i>	<i>Description</i>
Event Description	A bank statement arrived.
Action Description	Notifies appropriate users that a procurement card statement has arrived and is ready for reconciliation.
Notification Method	Email

Workflow Objects

<i>Information Type</i>	<i>Description</i>
Approval Rule Set	Procurement Card Approval
Business Process	PROCARD_BANK_SMENT_ARRIVED
Activity	Bank Statement Arrived
Role	Employee

Contract Expiration Alert

This section discusses the Contract Alert workflow.

Description

<i>Information Type</i>	<i>Description</i>
Event Description	A contract expires.
Action Description	Notifies the buyer when a contract expired or reached the maximum monetary amount.
Notification Method	Worklist

Workflow Objects

<i>Information Type</i>	<i>Description</i>
Approval Rule Set	Contract Expire Alert
Business Process	CONTRACT_EXPIRY_ALERT
Activity	CONTRACT_EXPIRY_ALERT
Role	Buyer

Online Purchase Order Acknowledgement Notifications

This section discusses the Online Purchase Order Acknowledgement Notifications workflow.

Description

<i>Information Type</i>	<i>Description</i>
Event Description	PO Acknowledgements incoming from the supplier that need approval.
Action Description	Alerts the buyer tied to the purchase order, when an acknowledgement comes in from the supplier (via EDX or online) that needs their approval.

<i>Information Type</i>	<i>Description</i>
Notification Method	Worklist

Workflow Objects

<i>Information Type</i>	<i>Description</i>
Approval Rule Set	N/A <hr/> Note: Uses the buyer tied to the PO (purchase order). <hr/>
Business Process	PO_ACKNOWLEDGEMENT
Activity	PO_ACKNOWLEDGEMENT (POA Approvals - Realtime EDX flow. Supplier POA Resp - Realtime Online flow)
Role	Uses the buyer tied to the purchase order.

Procurement Card Grace Period Expired

This section discusses the Procurement Card Grace Period Expired workflow.

Description

<i>Information Type</i>	<i>Description</i>
Event Description	A procurement card grace period expires.
Action Description	Notifies appropriate users that the reconciliation of a procurement card bank statement was not finished within a preset time frame.
Notification Method	Email

Workflow Objects

<i>Information Type</i>	<i>Description</i>
Approval Rule Set	Procurement Card Grace Period Expire Alert

<i>Information Type</i>	<i>Description</i>
Business Process	PROCARD_GRACE_PERIOD_EXPIRED
Activity	ProCard Grace Period Expired
Role	Employee

Purchase Order Acknowledgement Alert Notification

This section discusses the Purchase Order Acknowledgement Alert workflow.

Description

<i>Information Type</i>	<i>Description</i>
Event Description	Late PO Acknowledgements
Action Description	Notifies the buyers tied to purchase orders marked as acknowledgements required, that have not received PO Acknowledgements within specified ranges defined in the Purchasing Business Options or within the supplier's definition. (Two types are after X days of purchase order dispatch and within X days of shipment)
Notification Method	Worklist

Workflow Objects

<i>Information Type</i>	<i>Description</i>
Approval Rule Set	N/A <hr/> Note: Uses the buyer tied to the purchase order that hasn't received the acknowledgement. <hr/>
Business Process	PO_POA_ALERTS
Activity	PO_POA_ALERTS
Role	Uses the buyer tied to the purchase order.

Purchase Order Approval - ChartField Approval, Supervisor

This section discusses the Purchase Order Approval - ChartField Approval workflow. This workflow indicates that further approval is required from the supervisor.

Description

<i>Information Type</i>	<i>Description</i>
Event Description	Further approval is required.
Action Description	Notifies approver when a purchase order needs approval.
Notification Method	Worklist

Workflow Objects

<i>Information Type</i>	<i>Description</i>
Approval Rule Set	PO ChartField Approval
Business Process	Purchase Order Approvals
Activity	Review PO ChartFields
Role	Supervisor

Purchase Order Approval - ChartField Approval, Reviewer

This section discusses the Purchase Order Approval - ChartField Approval workflow. This workflow indicates that further ChartField approval is required from the previous reviewer.

Description

<i>Information Type</i>	<i>Description</i>
Event Description	Recycle ChartField.
Action Description	Notifies previous reviewer when a purchase order needs further review.
Notification Method	Worklist

Workflow Objects

<i>Information Type</i>	<i>Description</i>
Approval Rule Set	PO ChartField Approval
Business Process	Purchase Order Approvals
Activity	Review PO ChartFields
Role	Previous reviewer

Purchase Order Approval - ChartField Approval, Denied

This section discusses the Purchase Order Approval - ChartField Approval workflow. This workflow indicates that the ChartField is denied.

Description

<i>Information Type</i>	<i>Description</i>
Event Description	Deny ChartField.
Action Description	Notifies buyer that the purchase order has been denied.
Notification Method	Email and Worklist

Workflow Objects

<i>Information Type</i>	<i>Description</i>
Approval Rule Set	PO ChartField Approval
Business Process	Purchase Order Approvals
Activity	Review PO ChartFields
Role	Buyer

Purchase Order Approval - Amount Approval, Supervisor

This section discusses the Purchase Order Approval - Amount Approval workflow. This workflow indicates that further approval is required from the supervisor.

Description

<i>Information Type</i>	<i>Description</i>
Event Description	Further approval required.
Action Description	Notifies approver when a purchase order needs approval.
Notification Method	Worklist

Workflow Objects

<i>Information Type</i>	<i>Description</i>
Approval Rule Set	PO Amount Approval
Business Process	Purchase Order Approvals
Activity	Review PO amount.
Role	Supervisor

Purchase Order Approval - Amount Approval, Reviewer

This section discusses the Purchase Order Approval - Amount Approval workflow. This workflow indicates that further approval is required from the previous reviewer.

Description

<i>Information Type</i>	<i>Description</i>
Event Description	Recycle amount.
Action Description	Notifies previous reviewer when a purchase order needs further review.
Notification Method	Worklist

Workflow Objects

<i>Information Type</i>	<i>Description</i>
Approval Rule Set	PO Amount Approval
Business Process	Purchase Order Approvals
Activity	Review PO Amount
Role	Previous reviewer

Purchase Order Approval - Amount Approval, Denied

This section discusses the Purchase Order Approval - Amount Approval workflow. This workflow indicates that the purchase order amount was denied.

Description

<i>Information Type</i>	<i>Description</i>
Event Description	Deny amount.
Action Description	Notifies buyer that the purchase order has been denied.
Notification Method	Email and Worklist

Workflow Objects

<i>Information Type</i>	<i>Description</i>
Approval Rule Set	PO Amount Approval
Business Process	Purchase Order Approvals
Activity	Review PO Amount
Role	Buyer

Purchase Order Canceled

This section discusses the Purchase Order Canceled workflow.

Description

<i>Information Type</i>	<i>Description</i>
Event Description	A purchase order associated with a requisition is canceled.
Action Description	Notifies the requester when the purchase order for the requisition has been canceled.
Notification Method	Email

Workflow Objects

<i>Information Type</i>	<i>Description</i>
Approval Rule Set	N/A
Business Process	PO_CANCELED
Activity	PO Canceled
Role	Requester

Rebate Manager Notification

This section discusses the rebate manager notification workflow.

Description

<i>Information Type</i>	<i>Description</i>
Event Description	A claim associated with a vendor rebate agreement is generated.
Action Description	Notifies the rebate manager when the claim for the rebate agreement has been generated.
Notification Method	Email and worklist.

Workflow Objects

This notification uses the PeopleSoft Errors, Warnings, and Notifications (EWN) architecture.

Receipt Quantity Change Notification

This section discusses the rebate manager notification workflow for receipt quantity changes affecting a rebate.

Description

<i>Information Type</i>	<i>Description</i>
Event Description	A receipt associated with a vendor rebate agreement that has accruals already included on a claim is changed.
Action Description	Notifies the rebate manager when the receipt associated with a vendor rebate agreement that has accruals already included on a claim has been changed.
Notification Method	Email and worklist

Workflow Objects

This notification uses the PeopleSoft Errors, Warnings, and Notifications (EWN) architecture.

Request for Quote (RFQ) Notification

This section discusses the RFQ Notification workflow.

Description

<i>Information Type</i>	<i>Description</i>
Event Description	A requisition line requires an RFQ.
Action Description	Notifies the buyer when a requisition line requires an RFQ.
Notification Method	Worklist

Workflow Objects

<i>Information Type</i>	<i>Description</i>
Approval Rule Set	RFQ Notification Alert
Business Process	RFQ_NOTIFICATION
Activity	REQ Notification
Role	Buyer

Requisition Approval - ChartField Approval

This section discusses the Requisition Approval - ChartField Approval workflow. This workflow indicates that further ChartField approval is required from the supervisor.

Description

<i>Information Type</i>	<i>Description</i>
Event Description	Further approval is required.
Action Description	Notifies approver when a requisition needs approval.
Notification Method	Worklist

Workflow Objects

<i>Information Type</i>	<i>Description</i>
Approval Rule Set	Req ChartField Approval
Business Process	Requisition Approvals
Activity	Req ChartField Approval
Role	Supervisor

Requisition Approval - ChartField Approval

This section discusses the Requisition Approval - ChartField Approval workflow. This workflow indicates that further ChartField approval is required from the previous reviewer.

Description

<i>Information Type</i>	<i>Description</i>
Event Description	Recycle Req ChartFields.
Action Description	Notifies previous reviewer when a requisition needs further review.
Notification Method	Worklist

Workflow Objects

<i>Information Type</i>	<i>Description</i>
Approval Rule Set	Req ChartField Approval
Business Process	Requisition Approvals
Activity	Req ChartField Approval
Role	Previous reviewer

Requisition Approval - ChartField Approval

This section discusses the Requisition Approval - ChartField Approval workflow. This workflow indicates that the ChartField is denied.

Description

<i>Information Type</i>	<i>Description</i>
Event Description	Deny ChartField.
Action Description	Notifies requester that the requisition has been denied.
Notification Method	Email and Worklist

Workflow Objects

Information Type	Description
Approval Rule Set	Req ChartField Approval
Business Process	Requisition Approvals
Activity	Req ChartField Approval
Role	Requester

Requisition Approval - Amount Approval

This section discusses the Requisition Approval - Amount Approval workflow. This workflow indicates that further amount approval is required from the supervisor.

Description

Information Type	Description
Event Description	Further approval is required.
Action Description	Notifies approver when a requisition needs approval.
Notification Method	Worklist

Workflow Objects

Information Type	Description
Approval Rule Set	Req Amount Approval
Business Process	Requisition Approvals
Activity	Amount Approval
Role	Supervisor

Requisition Approval - Amount Approval

This section discusses the Requisition Approval - Amount Approval workflow. This workflow indicates that further amount approval is required from the previous reviewer.

Description

<i>Information Type</i>	<i>Description</i>
Event Description	Recycle Req Amount.
Action Description	Notifies previous reviewer when a requisition needs further review.
Notification Method	Worklist

Workflow Objects

<i>Information Type</i>	<i>Description</i>
Approval Rule Set	Req Amount Approval
Business Process	Requisition Approvals
Activity	Amount Approval
Role	Previous reviewer

Requisition Approval - Amount Approval

This section discusses the Requisition Approval - Amount Approval workflow. This workflow indicates that the requisition amount was denied.

Description

<i>Information Type</i>	<i>Description</i>
Event Description	Deny Req Amount.
Action Description	Notifies requester that the requisition has been denied.
Notification Method	Email and Worklist

Workflow Objects

<i>Information Type</i>	<i>Description</i>
Approval Rule Set	Req Amount Approval
Business Process	Requisition Approvals
Activity	Amount Approval
Role	Requester

Settlement Manager Notification

This section discusses the settlement manager notification workflow.

Description

<i>Information Type</i>	<i>Description</i>
Event Description	A claim associated with a vendor rebate agreement is settled.
Action Description	Notifies the settlement manager when the claim for the rebate agreement has been settled.
Notification Method	Email and worklist.

Workflow Objects

This notification uses the PeopleSoft Errors, Warnings, and Notifications (EWN) architecture.

PeopleSoft Purchasing Reports

PeopleSoft Purchasing Reports: General Description

For samples of these PeopleSoft Purchasing reports, see the Portable Document Format (PDF) files published with your online documentation.

In addition to the standard reports that PeopleSoft delivers, PeopleSoft also provides reporting tools that you can use to create new reports.

This table lists the PeopleSoft Purchasing reports, sorted in alphanumerical order by report ID. These reports listed are Structured Query Reports (SQRs) or BI Publisher reports. If you need more information about a report, refer to the report details at the end of this topic.

This section discusses:

- PeopleSoft Purchasing reports.
- PeopleSoft Purchasing Cost reports.

PeopleSoft Purchasing Reports

<i>Report ID and Report Name</i>	<i>Description</i>	<i>Navigation</i>	<i>Run Control Page</i>
POCNT500 GPO Price Comparison (group purchase order price comparison)	Displays manufacturer prices, distributor prices, expected distributor markups, and actual item markups for all items on a GPO contract. All prices are displayed in the GPO manufacturer currency. (SQR)	Purchasing, GPO Contracts, Reports, GPO Price Comparison	RUN_POCNT500
POCNT505 GPO Price Exception	Lists all items for which the distributor markup on the actual price does not equal that on the GPO contract. (SQR)	Purchasing, GPO Contracts, Reports, GPO Price Exception	RUN_POCNT505
POCNT510 GPO Manufacturer Commitment	Lists the amount spent, by GPO manufacturer contract. The amounts in this report do not include distributor markup. The report is sorted by distributor (supplier) or item category. (SQR)	Purchasing, GPO Contracts, Reports, GPO Manufacturer Commitment	RUN_POCNT510

Report ID and Report Name	Description	Navigation	Run Control Page
POCNT515 GPO Distributor Commitment	Displays the total amount spent with a GPO distributor for items supplied by a particular manufacturer. Compare this report to the contract commitments made to the distributor (amount purchased per quarter, for example). (SQR)	Purchasing, GPO Contracts, Reports, GPO Distributor Commitment	RUN_POCNT515
POCNT520 GPO Purchases	Displays the amount spent with a single group purchasing organization (GPO), including all current contracts. Amounts include distributor markups. The report is sorted by distributor (supplier) or item category code. (SQR)	Purchasing, GPO Contracts, Reports, GPO Purchases	RUN_POCNT520
PO_LGSP PO Line Group Spend	Lists the spend activity for line groupings sourced on purchase orders. (BI Publisher)	Purchasing, Reports, Line Group Spend Report	RUN_PO_LGSPND
POPO005 PO Dispatch/Print	Prints a hard copy of the purchase order. (SQR) <hr/> Note: The PO_DISPATCH is the BI Publisher version of the POPO005.sqr report and the POXMLP_PRINT is the online printable version of the report. When you click the View Printable Version link for the purchase order, the system displays the report if you have the XMLP Template check box selected as an installation option. If the template is not selected, the popo005.sqr appears.	Purchasing > Purchase Orders > Review PO Information > Print POs > Purchase Orders Print	RUN_PRN_POPO005
POPO008 Close Purchase Order	Provides information about purchase orders that have been closed by the last run of the Close Purchase Order Application Engine process. (SQR)	Purchasing > Purchase Orders > Reconcile POs > Close Purchase Orders	RUN_PORECON

Report ID and Report Name	Description	Navigation	Run Control Page
POPO009 PO Activity	Lists purchase order activity for the purchasing business unit, GL business unit, department, and dates that you select. Reviewing this report enables that you to perform comparisons and resolve discrepancies proactively. (SQR)	Purchasing > Purchase Orders > Reports > Purchase Order Activity	RUN_POPO009
POPO010 PO Acknowledgement	Lists specified purchase order acknowledgments sorted by either supplier name or buyer name. (SQR)	Purchasing > Purchase Orders > Reports > Purchase Order Acknowledgments	RUN_POPO010
POPO011 Non-Owned Purchase History	Lists utilization information for nonstock items for business units and departments listed in the item master. Analysis of this information can help you to evaluate supplier contracts, establish new supplier relationships, consolidate purchasing transactions, establish and maintain budgets, and anticipate supply needs. (SQR)	Purchasing > Purchase Orders > Reports > Non-Owned History Report	RUN_POPO011
POPO012 Backorder Status	Part of the Backorder Status process displays backorder details for a supplier, business unit, item, or buyer within user-defined date parameters. If you do not select the Include Backorders Received check box, the system only includes open (unreceived) backorder details. (SQR)	Purchasing > Purchase Orders > Reports > PO Backorder Status	RUN_POPO012
PORB7010 Supplier Claims	Provides a hard copy of the claim. (SQR) See Printing a Vendor Rebate Claim .	Purchasing > Supplier Rebates > Vendor Rebate Claims > Vendor Rebate Claims Print	VRBT_CLAIMS_PRT_RC
PORC100 ASR	Provides information about staged receipts that have been created from ASR documents received by electronic data exchange. (SQR)	Purchasing > Receipts > Reports > Advanced Shipment Receipt Rpt	RUN_PORCV100

Report ID and Report Name	Description	Navigation	Run Control Page
PORC200 Planned Receipt	Provides information about receipts generated from purchase order information to be used for electronic data collection transactions. (SQR)	Purchasing > Receipts > Reports > Planned Receipts > Planned Receipt Report	RUN_PORCV200
PORC700 Receipt Accrual	Lists all received items (sorted by ChartFields) that have been posted but not fully invoiced. It can help with monitoring and maintaining monthly budgets. You can run this report for inventory items, expense items, or both. It might also include landed costs. (SQR)	Purchasing > Receipts > Reports > Receipt Accrual	RUN_PORC700
PORC910 Receiving Bar-code Labels	Create a flat file to produce receipt labels used to track received items. Receiving labels may be generated for each item on a receipt. (SQR)	Purchasing > Receipts > Reports > Receipt Labels > PO Receipt Labels	RUN_PORC910
PORC920 Receipt Item Usage Labels	Prints item usage labels for point-of-use locations against purchase order receipts. When items are delivered to a receiving dock, they are either put away in inventory storage or delivered to a point-of-use location. (SQR)	Purchasing > Receipts > Reports > Receipt Item Usage Labels > PO Receipt Item Usage Labels	RUN_PORC_USG_LBL
PORC930 Device Tracking Receipts	Displays device-tracked items that have been received. (SQR)	Purchasing > Receipts > Reports > PO/Receipt Device Tracking > PO/Receipt Dev Trk	RUN_PORC930
PORFQ01 RFQ Dispatch/Print	Provides a hard copy of the request for quote. (SQR)	Purchasing > Request for Quotes > Dispatch Quotes > Dispatch Quote Forms	RUN_PORFQ01
POROL001 Open Purchase Order	Review open purchase orders for the budget year-end process. The information for the purchase order distribution lines appear in this report if their encumbrances still remain on the KK_LIQUIDATION table. (SQR)	Purchasing > Purchase Orders > Budget Year End Processing > Open Purchase Order Report > Open Purchase Order	RUN_POREPORT

Report ID and Report Name	Description	Navigation	Run Control Page
POROL002 PO Rollover	Review the four different roll statuses (Pending, Mid Roll, Roll Completed, and Disqualified) of the purchase orders during the budget year-end process. (SQR)	Purchasing > Purchase Orders > Budget Year End Processing > PO Rollover Activity Report > PO Rollover	RUN_PORO011
POROLLEXP_PO PO Rollover Exception List Sort by Type	Review non-qualified purchase orders and their associated documents. To produce the report listing, the PO Rollover View process must be run prior to producing the Non-Qualified PO Exception Listing. (SQR) Note: The PO_POROLLEXP – PO Rollover Exception List Sort by PO report is also available for viewing purchase order rollover exceptions.	Purchasing > Purchase Orders > Budget Year End Processing > Non Qualified PO Listing	RUN_ROLL_EXCEPTION
PORQ009 Close Requisition	Provides information about requisitions that have been closed by the last run of the Close Requisition process (PO_REQRCON). (SQR)	Purchasing > Requisitions > Reconcile Requisitions > Close Requisitions	RUN_REQRECON
PORQ010 Requisition Print SQR	Provides a hard copy of your requisitions sorted by requisition ID. You can print a single requisition or multiple requisitions. (SQR)	Purchasing > Requisitions > Reports > Print Requisition > Requisition Print	RUN_POY100
PORQ011 Requisition Template	Provides a listing of the items most commonly ordered, along with supplier and manufacturer information. It is used to facilitate data entry of commonly ordered items. (SQR)	Purchasing > Requisitions > Reports > Requisition Template	RUN_PORQ011
PORT001 RTV Dispatch/Print	Provides a hard copy of the selected return to vendor transactions. (SQR)	<ul style="list-style-type: none"> • Purchasing > Return To Vendor > Dispatch RTVs • Purchasing > Return To Vendor > Print RTVs 	RUN_PO_RTVDISP

Report ID and Report Name	Description	Navigation	Run Control Page
POS8001 Procurement Budgetary Activity	Generate the Procurement Budgetary Activity Report. This report provides budgetary amount information for purchase orders according to report request parameters. (SQR)	Purchasing > Purchase Orders > Reports > Req & PO Budget Activity Req	RUN_POS8000
POS8002 Requisition Budgetary Activity	Generate the Requisition Budgetary Activity report. This report provides budgetary amount information for requisitions according to report request parameters. (SQR)	Purchasing > Purchase Orders > Reports > Req & PO Budget Activity Req	RUN_POS8000
POVR100 Vendor Rebate Dispatch	Prints a hard copy of the vendor rebate agreement. (SQR)	<ul style="list-style-type: none"> • Purchasing > Supplier Rebates > Rebate Dispatch > Vendor Rebate Agreement Dispatch • Click the Dispatch button on the Rebate Agreement - Rebate Agreement page. 	RUN_DISP_POVRBT100
POVRB200 Rebate Threshold Analysis	Provides vendor rebate agreement threshold analysis information for selected vendor rebate agreements. (SQR)	Purchasing > Vendor Rebates > Vendor Rebate Analysis > Rebate Analysis Workbench > Vendor Rebate Analysis Workbench - Workbench Filter Options page. Click the View Workbench button on the Vendor Rebate Analysis Workbench - Workbench Filter Options page. Select <i>Rebate Threshold Report</i> in the Select Rows For field on the Vendor Rebate Agreement Analysis Workbench and then click the OK button.	VRBT_SERVER_REPORT

Report ID and Report Name	Description	Navigation	Run Control Page
POVRB300 PO Not Received	Provides open purchase order information that is associated with a vendor rebate agreement. (SQR)	<p>Purchasing > Vendor Rebates > Vendor Rebate Analysis > Rebate Analysis Workbench > Vendor Rebate Analysis Workbench - Workbench Filter Options page.</p> <p>Click the View Workbench button on the Vendor Rebate Analysis Workbench - Workbench Filter Options page.</p> <p>Select <i>PO Not Received Report</i> in the Select Rows For field on the Vendor Rebate Agreement Analysis Workbench and then click the OK button.</p>	VRBT_SERVER_RPT
PO_DISPATCH PO_DISPATCH	Provides information about selected purchase orders. (BI Publisher)	Purchasing > Purchase Orders > Dispatch POs	RUN_PO_DISPATCH
POXMLP_PRINT POXMLP_PRINT	Provides information about selected purchase orders. (BI Publisher)	<p>Purchasing > Purchase Orders > Add/Update POs</p> <p>Click the View Printable Version link on the Maintain Purchase Order - Purchase Order page.</p>	RUN_POXMLP_PRINT
POX4006 Expediting Report by Buyer	Provides purchase order details such as late days and due date sorted by buyer. Use it to help determine which purchase orders may require expediting. (BI Publisher)	Purchasing > Purchase Orders > Reports > Expediting > Expediting Report	RUN_POY4006
POX4007 Expediting Report by Supplier	Provides purchase order details such as late days and due date sorted by supplier. (BI Publisher)	Purchasing > Purchase Orders > Reports > Expediting > Expediting Report	RUN_POY4007
POX4008 Expediting Report by Due Date	Provides purchase order details such as late days and due date sorted by due date. (BI Publisher)	Purchasing > Purchase Orders > Reports > Expediting > Expediting Report	RUN_POY4008

Report ID and Report Name	Description	Navigation	Run Control Page
POX4030 PO Detail Listing By PO Date	Provides detailed purchase order information sorted by purchase order date. (BI Publisher)	Purchasing > Purchase Orders > Reports > Purchase Order Detail Listings	RUN_POY4030
POX4031 PO Detail Listing By Supplier	Provides detailed purchase order information sorted by supplier. (BI Publisher)	Purchasing > Purchase Orders > Reports > Detail Listings > PO Detail Listings	RUN_POY4031
POX4032 PO Detail Listing By Buyer	Provides detailed purchase order information sorted by buyer. (BI Publisher)	Purchasing > Purchase Orders > Reports > Detail Listings > PO Detail Listings	RUN_POY4032
POX4100 PO Detail Listing By Buyer	Provides a cross-reference between requisitions and the purchase orders created from those requisitions. (BI Publisher)	Purchasing > Purchase Orders > Reports > Requisition/PO Xref > PO To Requisition Xref	RUN_POY4100
POX5001 Receiver Summary	Provides a summary listing of receipts within a specified date range. (BI Publisher)	Purchasing > Receipts > Reports > Receipt Summary	RUN_POY5001
POX5010 Receiver Shipto Detail	Provides a summary listing of receipts shipments within a specified date range. (BI Publisher)	Purchasing > Receipts > Reports > Receipt Ship To Details	RUN_POY5010
POX5020 Receiver Account Detail	Provides a detailed list of shipments by receiver ID. (BI Publisher)	Purchasing > Receipts > Reports > Receipt Account Details	RUN_POY5020
POX1100 Requisition to PO XREF	Provides information about selected requisitions and the purchase orders that have been created from them. (BI Publisher)	Purchasing > Requisitions > Reports > PO/Requisition Xref > Requisition to PO XREF	RUN_POY1100
POX3031 Contract Activities	Displays line level information about procurement documents associated with a contract. (BI Publisher)	Procurement Contracts > Reports > PO Contract Activities Report	RUN_POY3030

Report ID and Report Name	Description	Navigation	Run Control Page
POX4006 Expediting Report by Buyer	Provides purchase order details such as late days and due date sorted by buyer. Use it to help determine which purchase orders may require expediting. (BI Publisher)	Purchasing > Purchase Orders > Reports > PO Expediting Report	RUN_POY4006
POX4007 Expediting Report by Supplier	Provides purchase order details such as late days and due date sorted by supplier. Use it to help determine which purchase orders may require expediting. (BI Publisher)	Purchasing > Purchase Orders > Reports > Expediting > Expediting Report	RUN_POY4007
POX4008 Expediting Report by Due Date	Provides purchase order details such as late days and due date sorted by due date. Use it to help determine which purchase orders may require expediting. (BI Publisher)	Purchasing > Purchase Orders > Reports > Expediting > Expediting Report	RUN_POY4008
POX4010 PO Listing by PO Date	Provides purchase order information sorted by purchase order date. (BI Publisher)	Purchasing > Purchase Orders > Reports > Purchase Order Listings Report	RUN_PO4010
POX4011 PO Listing By Supplier	Provides purchase order information sorted by supplier. (BI Publisher)	Purchasing > Purchase Orders > Reports > Listings > PO Listings	RUN_POY4010
POX4012 PO Listing By Buyer	Provides purchase order information sorted by buyer. (BI Publisher)	Purchasing > Purchase Orders > Reports > Listings > PO Listings	RUN_POY4010
POX4013 PO Listing By Status	Provides purchase order information sorted by status. (BI Publisher)	Purchasing > Purchase Orders > Reports > Listings > PO Listings	RUN_POY4010
POX4020 Order Status By Supplier	Provides purchase order status information sorted by supplier. (BI Publisher)	Purchasing > Purchase Orders > Reports > Status Listings > PO Status Listings	RUN_POY4020
POX4021 Order Status by Item	Provides purchase order status information sorted by item. (BI Publisher)	Purchasing > Purchase Orders > Reports > Status Listings > PO Status Listings	RUN_POY4020

Report ID and Report Name	Description	Navigation	Run Control Page
POX4030 PO Detail Listing By PO Date	Provides detailed purchase order information sorted by purchase order date. (BI Publisher)	Purchasing > Purchase Orders > Reports > Detail Listings > PO Detail Listings	RUN_POY4030
POX4031 PO Detail Listing By Supplier	Provides detailed purchase order information sorted by supplier. (BI Publisher)	Purchasing > Purchase Orders > Reports > Detail Listings > PO Detail Listings	RUN_POY4031
POX4032 PO Detail Listing By Buyer	Provides detailed purchase order information sorted by buyer. (BI Publisher)	Purchasing > Purchase Orders > Reports > Detail Listings > PO Detail Listings	RUN_POY4032
POX4040 PO Schedule Listing By PO Date	Provides purchase order schedule information such as ship to and due date sorted by purchase order date. (BI Publisher)	Purchasing > Purchase Orders > Reports > Schedule Listings > PO Schedule Listings	RUN_POY4040
POX4041 PO Schedule Listing By Supplier	Provides purchase order schedule information such as ship to and due date sorted by supplier. (BI Publisher)	Purchasing > Purchase Orders > Reports > Schedule Listings > PO Schedule Listings	RUN_POX4041
POX4042 PO Schedule Listing By Buyer	Provides purchase order schedule information such as ship to and due date sorted by buyer. (BI Publisher)	Purchasing > Purchase Orders > Reports > Schedule Listings > PO Schedule Listings	RUN_POY4042
POX5001 Receiver Summary	Provides a summary listing of receipts within a specified date range. (BI Publisher)	Purchasing > Receipts > Reports > Receipt Summary > Receiver Summary	RUN_POY5001
POX5010 Receiver Ship to Detail	Provides a summary listing of receipts shipments within a specified date range. (BI Publisher)	Purchasing > Receipts > Reports > Receipt Ship To Details > Receipt Shipto Detail	RUN_POY5010
POX5020 Receiver Account Detail	Provides a summary listing of receipts with account distribution. (BI Publisher)	Purchasing > Receipts > Reports > Receipt Account Details > Receiver Account Detail	RUN_POY5020

Report ID and Report Name	Description	Navigation	Run Control Page
POX5030 Receipt Delivery Detail	Provides a detailed list of shipments by receiver ID, including deliveries made through the Mobile Inventory Management application. (BI Publisher)	Purchasing > Receipts > Reports > Receipt Delivery	RUN_POY5030
POX5035 Shop Floor Receipt Delivery	Provides a detailed list of shop floor receipts.	Purchasing > Receipts > Reports > Receipt Delivery	RUN_POY5030
POX5050 Return To Vendor Detail	Provides the supplier's return address, shipping method, and line item return information. (BI Publisher) This report is available anytime after you enter and save the supplier return in PeopleSoft Purchasing.	Purchasing > Return To Vendor > RTV Details Report	RUN_POY5050
POX5060 RTV Credits	Provides details of return to vendor transactions, sorted by supplier and return to vendor ID, and lists the buyer, line details, and the distribution information selected on the return. Totals are provided for each return to vendor ID and supplier. (BI Publisher) This report is available at any time after you enter and save the supplier return in PeopleSoft Purchasing.	Purchasing > Return To Vendor > Supplier RTV Credits Report	RUN_POY5060
POX5070 Bill of Entry Worksheet	Provides a bill of entry worksheet. (BI Publisher)	Purchasing > Receipts > Reports > Bill of Entry Worksheet > BOE Worksheet	RUN_POY5070
POX6100 REQ/RFQ Cross Reference	Provides a cross-reference between requests for quotes and the requisitions created from those requests for quotes.	Purchasing > Requests for Quotes > Requisition/RFQ Xref Report > REQ/RFQ Cross Reference	RUN_POY6100

Report ID and Report Name	Description	Navigation	Run Control Page
POX8000 Cardholder Information	Provides information relating to each cardholder and the cardholder's assigned procurement card. The information printed in the report includes card number, transaction and monthly limits, and authorized purchasing categories. (BI Publisher)	Purchasing > Procurement Cards > Reports > Cardholder Information	RUN_POY8000
POX8010 Exceed Limit per Transaction	Provides information about employee procurement card expenditure amount limits per transaction. (BI Publisher)	Purchasing > Procurement Cards > Reports > Purchase Exceptions	RUN_POY8010
POX8011 Exceed Limit per Cycle	Provides information about employee procurement card expenditure amount limits per cycle. (BI Publisher)	Purchasing > Procurement Cards > Reports > Purchase Exceptions	RUN_POY8010
POX8012 Exceed Transactions per Day	Provides information about employee number of procurement card transactions per day limits. ((BI Publisher)	Purchasing > Procurement Cards > Reports > Purchase Exceptions	RUN_POY8010
POX8013 Exceed Transactions per Cycle	Provides information about employee number of procurement card transactions per cycle limits. (BI Publisher)	Purchasing > Procurement Cards > Reports > Purchase Exceptions	RUN_POY8010
POX8014 Unauthorized Commodity	Provides information about employee procurement card purchases involving unauthorized commodity codes. (BI Publisher)	Purchasing > Procurement Cards > Reports > Purchase Exceptions	RUN_POY8010
POX8020 Expected Credits	Provides a list of disputed procurement card transactions. Statement lines listed on the Expected Credits report are those for prior periods where a dispute amount has been entered, and the credit collected indicator has not been selected. (BI Publisher)	Purchasing > Procurement Cards > Reports > Expected Credits	RUN_POY8020

Report ID and Report Name	Description	Navigation	Run Control Page
POX8030 Purchase Detail by Issuer	Provides procurement card expenditures made using a particular credit card provider. (BI Publisher)	Purchasing > Procurement Cards > Reports > Purchase Details	RUN_POY8030
POX8031 Purchase Detail by Merchant	Provides procurement card expenditures for a specific merchant. (BI Publisher)	Purchasing > Procurement Cards > Reports > Purchase Details	RUN_POY8030
POX8032 Purchase Detail by Employee	Provides procurement card expenditures of a single cardholder or all of the cardholders. (BI Publisher)	Purchasing > Procurement Cards > Reports > Purchase Details	RUN_POY8030
POX8050 Purchase Summary by Issuer	Provides a summary of all procurement card purchases sorted by supplier. (BI Publisher)	Purchasing > Procurement Cards > Reports > Account Summary	RUN_POY8050
POX8051 Purchase Summary by Merchant	Provides a summary of all procurement card purchases sorted by merchant. (BI Publisher)	Purchasing > Procurement Cards > Reports > Account Summary	RUN_POY8050
POX8052 Purchase Summary by Employee	Provides a summary of all procurement card purchases sorted by employee. (BI Publisher)	Purchasing > Procurement Cards > Reports > Account Summary	RUN_POY8050
POX8060 Credit Detail by MCG	Provides information about cardholders credit activity and summarizes the transaction amount for each account number. Lists all credit transactions grouped by MCG. (BI Publisher)	Purchasing > Procurement Cards > Reports > Credit Detail By MCG	RUN_POY8060
POX8061 Non-Preferred Supplier	Identifies all purchases involving nonpreferred suppliers within an MCC. Indicates whether cardholders are adhering to organizational policy in the use of preferred suppliers. (BI Publisher)	Purchasing > Procurement Cards > Reports > Non-Preferred Supplier	RUN_POY8061

Report ID and Report Name	Description	Navigation	Run Control Page
POX8062 Top Supplier Chains	Lists the supplier chains based on the volume during the reporting period for the selected MCGs. (BI Publisher)	Purchasing > Procurement Cards > Reports > PCard Top Supplier Chains Rpt	RUN_POY8062
POX8063 Top Merchant Category	Lists the merchant categories based on the volume during the reporting period for the selected MCGs. (BI Publisher)	Purchasing > Procurement Cards > Reports > Top Merchant Category	RUN_POY8063
POX8064 MCC Exceptions	Provides Merchant Category Code Exceptions. (BI Publisher)	Purchasing > Procurement Cards > Reports > MCC Exceptions Report	RUN_POY8064
PO_ITMSUBU Item Substitution Usage	Provides a listing of Purchase Order Lines whose items have been substituted.	Purchasing, Purchase Orders, Reports, Item Substitution Usage	RUN_POITMSUBU
PO_ITEMSUBS Item Substitution Summary	Provides a summary usage listing of substitute items.	Purchasing, Purchase Orders, Reports, Item Substitution Usage Summary	RUN_POITMSUBS
POX3010 Contract Release by BU	Lists of order contract releases based by business unit.	Procurement Contracts, Reports, Order Contract Releases	RUN_POY3010
POX1052 Recurring Voucher Contract Details	Lists recurring voucher contract details by SetID and contract ID.	Procurement Contracts, Reports, Recurring Voucher Details	RUN_POY1052
POX3020 Contract Release by SetID	Lists order contract releases based by SetID.	Procurement Contracts, Reports, Order Contract Releases	RUN_POY3010

PeopleSoft Purchasing Cost Reports

Report ID and Report Name	Description	Navigation	Run Control Page
CMS3000 Estimate vs. Actual Landed Cost	Provides purchase price variance for landed cost elements. (SQR)	Purchasing > Receipts > Reports > Estimate/Actual Landed Cost > Estimate vs Actual	RUN_CMS3000

Report ID and Report Name	Description	Navigation	Run Control Page
CMS3010 Total Purchase Variance	Provides purchase price variance and exchange rate variance for landed cost elements. (SQR)	Purchasing > Receipts > Reports > Total Purchase Variance > Total Variance	RUN_CMS3010
CMS3020 Standard Purchase Variance	Provides purchase price variance at receipt of landed cost elements for standard costed items only. (SQR)	Purchasing > Receipts > Reports > Standard Purchase Variance > Standard Variance	RUN_CMS3020

PeopleSoft Purchasing Report Details

This section lists common elements and provides detailed information about individual reports including important fields and tables accessed. The reports are listed alphanumerically by report ID.

Common Elements Used in PeopleSoft Purchasing Reports

Field or Control	Description
Rel (release)	If the purchase order is tied to a contract, the contract release number appears.
PO Status (purchase order status)	Displays the status of the purchase order: <i>Approved, Canceled, Completed, Dispatched, Initial, Open, or Pending Approval.</i>
EmplID (employee ID)	Displays the procurement card user's name along with the user's ID.
Credit Card	Select the supplier responsible for issuing the card. Typically, this supplier is a bank.
CC Account (credit card account)	Enter the credit card account number.
Currency Code	Select the currency code. The report contains transactions with the selected currency code.
Date From	Select the start point of the transaction date range.
To	Select the end point of the transaction date range.

POLGSPND - Line Group Spend

This report provides line group item quantities and amounts awarded, released, and remaining for events. You can sort the report in this order: by business unit, event ID, line group ID, supplier ID for purchase order and finally by contract document type. Because the report elements have different data structures, they are separate. The system totals the amounts for each document.

Along with header details, the system provides item information such as the quantities and amounts awarded and released and the remaining amounts for each item.

Field or Control	Description
Event ID	Displays the sourcing event ID along with the round and version numbers.
Line Grouping ID	A line group is a bundle of items that buyers use in PeopleSoft Strategic Sourcing to obtain better pricing for items. Other values in the report such as the amount released, awarded and remaining apply to the corresponding line group ID and document.
Purchasing Business Unit	Displays the PeopleSoft Purchasing business unit in which the line grouping is defined. A business unit is an operational subset of the organization that tracks and maintains its own set of requisitions and purchase orders.
Document Type	Displays the type of document. Values include: <i>Requisition, Purchase Order, RTV, RFQ, Receipt, Work Order, MSR, and Contract.</i>
Document ID	Displays the system identifier and short description for the document.
Supplier ID	Displays the supplier to which the event was awarded.
Buyer ID	Displays the buyer for sourcing event ID along with the round and version numbers.

POPO005 - PO Dispatch/Print

Field or Control	Description
Payment Terms	If you are using a procurement card or a supplier card as the payment method for the purchase order, <i>ProCard</i> appears in this field.

Field or Control	Description
Procurement Card Information	Depending on the procurement card dispatch option you select different procurement card information will appear on this report. The procurement card information appears under the Bill To information in the header portion of the report. For example: Procurement Card: *****7777 Card Type: Visa Expires: 2100-01-01
Replenishment Option	Displays whether the items on the purchase order are standard or stockless. Each purchase order contains either all standard or all stockless items.
Extended Amt (extended amount)	The schedule price multiplied by the schedule quantity. This is the merchandise amount of the schedule. It does not include other amounts associated with the schedule, such as freight and tax. This is in the transaction currency on the purchase order that you send to the supplier.
Total Amount	The total amount that can be ordered against the contract line.
Total Quantity	The total (maximum) quantity that can be ordered against the contract line.

Related Links

[Creating Purchase Order Headers](#)

[Defining Purchasing Item Attributes](#)

[Select Purchase Order Page](#)

POPO008 - Close Purchase Order

Field or Control	Description
PO Status	Status of the purchase order after you run the process.
Budget Status	Status of the budget check that you performed on the purchase order.
Budget Ln Status (budget line status)	Status of the budget check performed on the purchase order line.

Related Links

[Creating Requisition Header Information](#)

[Closing Purchase Orders](#)

[Purchase Order Header Status Values](#)

POPO009 - PO Activity

<i>Field or Control</i>	<i>Description</i>
Include Cancelled POs?	Check to include canceled purchase orders on the report.
Include Open/Pending Appr POs?	<p>Check to include purchase orders that are still open or pending approval.</p> <p>The line amounts will be zero for canceled, open, and pending approval purchase orders.</p>
Option	<p>Select beginning and ending dates. Values are:</p> <p><i>C</i> (current date): Report purchase order activity beginning and ending with the current date.</p> <p><i>M</i> (current date minus days): Report purchase order activity beginning and ending with the date that is a specified number of days before the current date. Specify that number in the Nbr Days field.</p> <p><i>N</i> (no selection by date): Date criteria not used to report purchase order activity.</p> <p><i>P</i> (current date plus days): Report purchase order activity beginning and ending with the date that is a specified number of days after the current date. Specify the number in the Nbr Days field.</p> <p><i>S</i> (specified date): Report purchase order activity beginning and ending with the date that you select in the Date field.</p>

POPO010 - PO Acknowledgement

<i>Field or Control</i>	<i>Description</i>
Only Those Needing Review	Select to report only on acknowledgments not yet identified as <i>Reviewed</i> .
Exceptions Only	Select to report only on acknowledgments for which the status indicates that the supplier has changed the purchase order.

Field or Control	Description
Option	<p>Select the beginning and ending dates for which you want to report acknowledgments. Values are:</p> <p><i>C</i> (current date): Report received acknowledgments beginning and ending with the current date.</p> <p><i>M</i> (current date minus days): Report received acknowledgments beginning and ending with the date that is a specified number of days before the current date. Specify that number in the Nbr Days field.</p> <p><i>N</i> (no selection by date): Date criteria not used to report acknowledgments.</p> <p><i>S</i> (specified date): Report received acknowledgments beginning and ending with the date that you select in the Date field.</p>
POA Status	Acknowledgment status for the purchase order.
Line Status	Acknowledgment status for the line.

PO_POROLLEXP - PO Rollover Exception List Sort by PO

For more information about the PO Rollover Exception List Sort by PO, see the PO Rollover Exception List Sort by Type report description.

See [PO_POROLLEXP - PO Rollover Exception List Sort by PO](#).

PORC100 - Advanced Shipment Receipt (ASR)

Field or Control	Description
Supplier ID	Enter the supplier SetID in the first field and the supplier ID in the second.
Print Schedules	Select to have the report generate detail to the schedule level.

Note: PeopleSoft SCM applications do not support the printing of bar codes from processes running on OS390 servers. You should run your SQRs that print barcodes on a process scheduler server that is running on a non-OS390 operation system.

Note: Define ship to locations for all purchasing transactions at the schedule level.

Field or Control	Description
Production ID	If the item is associated with a PeopleSoft Manufacturing production kit, this field displays the item's associated production identification number.
Op Seq (operation sequence)	The order number in which this material is used in the production sequence.

PORC200 - Planned Receipt

Field or Control	Description
Supplier ID	Enter the supplier SetID in the first field and the supplier ID in the second.
Print Schedules	Select to generate detail that includes the schedule level on the report.

Note: PeopleSoft SCM applications do not support the printing of bar codes from processes running on OS390 servers. You should run your SQRs that print barcodes on a process scheduler server that is running on a non-OS390 operation system.

Note: Define ship to locations for all purchasing transactions at the schedule level.

Field or Control	Description
Open Quantity	Quantity of the purchase order line (or schedule) that has not been received. This is the purchase order quantity minus the receipt quantities.
Production ID	If the item is associated with a PeopleSoft Manufacturing production kit, this is the item's associated production ID.
Op Seq (operation sequence)	The order number in which this material is used in the production sequence.
Pegged	Indicates if the line or schedule is pegged.

PORC700 - Receipt Accrual

Before you run the Receipt Accrual report:

- Put away all inventory receipts.

- Run the AP/PO Matching process in PeopleSoft Payables.
- To ensure correspondence with amounts in the general ledger, run inventory costing, accounting line creation, and journal generation for inventory.

Also run Posting in PeopleSoft Payables.

- Run the accrual process for non-inventory items.

If you are including landed costs in this report, match and post the vouchers, and run the landed cost extract.

<i>Field or Control</i>	<i>Description</i>
GL Business Unit	Select this option and enter a business unit to report on receipts for a specific business unit. If you do not enter a specific business unit, you will report on all GL business units.
Recv BU	Select this option and enter a business unit to report on receipts for a specific receiving unit. If you do not enter a specific business unit, you will report on all receiving business units.
ChartField	Enter the ChartField by which to sort the report. The default is by account.
ChartField Value 1 and ChartField Value 2	Then enter ChartField values in order to limit the report to a specific range for that ChartField. To report on all values, leave the range fields blank. You can sort by more than one ChartField.

PORC920 - Receipt Item Usage Labels

<i>Field or Control</i>	<i>Description</i>
All Unprocessed Receipts	Select to produce a flat file including items on all unprocessed receipts. The system retrieves all lines in the RECV_LN_DISTRIB table that have not been processed (LOC_RECV_LBL_FLG = N) for usage label generation.
Reprint	Select to reprint a report including items on a specific flat file. In addition, you may reprint labels according to values that you entered in the Receipt ID and Receipt Line fields, or according to entries in the RECV_LN_DISTRIB table with a LOC_RECV_LBL_FLG = Y.
Receipt ID	If you selected the Reprint option, enter the receipt number for which to reprint labels.

Field or Control	Description
Receipt Line	If you selected the Reprint option and have entered a receipt ID, enter the receipt line number associated with the item for which to reprint labels.
Item Usage Label Format	Select a label format ID from the available options. You define this value on the Data Collection Label Setup page.
Number of Copies	Enter the number of sets of labels to print.
Override File	Select to designate that this report file is to override an existing flat file.
File Directory	Enter the file directory that contains the file to override with the current flat file.
File Name	Enter the name of the file to override with the current flat file.

When items are delivered to a receiving dock, they are either put away in inventory storage or delivered to a point-of-use location. This process enables you to create a flat file to print item usage labels for items that are delivered to point-of-use locations directly upon receiving.

Only items that are defined at the par location level or SetID item level as being usage tracked with a method code of *track for billing* or *track for costing* cause labels to be printed. The labels are created in the item's standard unit of measure.

The fields on this report are the same as those found on the Item Usage Label report.

PORC930 - Device Tracking Receipts

Field or Control	Description
Include Inactive Items	Select to include items that are restricted to warehouse movement transactions, adjustments, RMA and RTV transactions, and receiving transactions.

Related Links

“Using Device Tracking” (PeopleSoft Managing Items)

“Managing Inventory by Item Status” (PeopleSoft Managing Items)

POROL001 - Open Purchase Order

<i>Field or Control</i>	<i>Description</i>
Refresh	Click to display multiple rows for each column in the ChartField Selection area and default Sequence field values. When you click Refresh , the button name changes to Restore , and you can click it to restore the default view of ChartField Selection area.
Sequence	The sequence in which ChartFields appear on the report.
Include CF (include ChartField)	Select to generate a report on the ChartField and values that you selected in this row.

POROL002 - PO Rollover

<i>Field or Control</i>	<i>Description</i>
Pending	Select to report on purchase orders that are pending.
Mid Roll	Select to report on purchase orders for which you have run the PO Roll1 process.
Roll Completed	Select to report on purchase orders for which you have run the PO Roll1 process and the PO Roll2 process. As a result, new distributions are ready to be budget checked.
Disqualified	Select to report on purchase orders that are in roll error.

POROLLEXP_PO - PO Rollover Exception List Sort by Type

<i>Field or Control</i>	<i>Description</i>
Business Unit	Displays the business unit to which this report applies.
Search ID	Displays the search ID that you selected for the report.
Report Sort Order	The report can be sorted by exception type or purchase order number.

Field or Control	Description
Exception Type	<p>Displays the rollover error and information associated with the error sorted by exception type. For each rollover error type, the report displays the error title and information using these rules:</p> <ul style="list-style-type: none"> • Invalid budget status on PO. • Invalid budget status on voucher. • Invalid budget status on PO and voucher. • Invalid budget status on PO and receipt partially vouchered. • Invalid budget status on PO and voucher and receipt partially vouchered. • One receipt is partially vouchered. • Invalid budget status on voucher and receipt partially vouchered.
PO ID	Displays the purchase order business unit.
PO Amount	Displays the amount of the purchase order.
Business Unit	Displays the purchase order business unit.
Document ID	Displays the document ID which can be a voucher or receipt.
Document Amount	Displays the amount for the purchase order.

PORQ010 - Requisition Print SQR

The Requisition Print SQR report provides information about contracts that were used in the pricing of the requisition. On the report, the status of the requisition appears next to the business unit in the header portion of the report:

- *Open*: The requisition has been saved, but an authorized user must change its status to **Pending Approval** for the process to continue.
- *Pending Approval*
- *Approved*
- *Canceled*
- *Completed*

If you have a requisition that has several lines and only a few of the lines are approved, this requisition will print on the report. On the report, the overall status for the requisition will display as *SEE LINES*. The individual line status will appear in the report detail section for the approved lines.

Field or Control	Description
Requester Signature	The person who submitted the requisition can sign here for purposes of accountability.
Procurement Card, Card Type, and Expires	If applicable, the procurement card number, type, and expiration date will appear in the header portion of the report under the Requestor Signature field.
*	An asterisk will appear next to the requisition line and schedule if that line is to be paid by a procurement card.
Extended Amt (extended amount)	The merchandise amount of the schedule is the schedule price multiplied by the schedule quantity. It does not include other amounts associated with the schedule, such as freight and tax. This is in the transaction currency on the purchase order that you send to the supplier.

PORT001 - RTV Dispatch/Print

Field or Control	Description
Freight Terms	If freight terms apply to this return to vendor, this field shows the applicable terms according to the schedules of the purchase order for the received material. The freight terms reflect who holds legal responsibility for the material until ownership has passed.
UM (unit of measure)	Unit of measure of the quantity being returned.
Action	Return action for the item.
Dispose	Disposition assigned to the item being returned.
Reason	Return reason for the item.
Ship Via	Route or mode of transportation of the shipment assigned to the returned material.

Related Links

[Understanding the RTV Business Process](#)

POS8001 - Procurement Budgetary Activity

Amounts are reported in the base currency of the general ledger business unit associated with the selected purchasing business unit.

ChartField types and values are reported based on your selections on the Req-PO Budgetary Activity page.

Field or Control	Description
Business Unit	Purchasing business unit for which the report was run.
Budget Date From/To	Budget dates for which the report was run. The budget dates do not necessarily correspond to a budget period.
Remaining Amount (at the report header level)	Distribution remaining amount criteria against which the report was run.
PO ID (purchase order ID)	Purchase order for which information is reported.
Line/Sched/Dist (line/schedule/distribution)	<p>Report processing checks the Purchase Order Line Distribution tables and selects lines, schedules, and distributions for which the following criteria are met:</p> <p>The business unit and budget date on the line meet report request parameters.</p> <p>The report provides information for distribution lines with budget line statuses of <i>V</i> (valid) or <i>W</i> (warning).</p> <p>The line meets defined ChartField criteria, if any.</p>
Original PO Amount (original purchase order amount)	Original purchase order distribution amount.
Liquidated Amount	<p>The liquidated amount is calculated from the original purchase order amount less the remaining amount.</p> <hr/> <p>Note: You should define a default commitment control ledger group on the Ledgers for a Unit - Commitment Control Options page. The liquidated amount on the report is derived from the KK_LIQUIDATION table using the distribution's general ledger business unit and its default commitment control ledger group. The liquidated amount on the report is set to zero if you have not selected a default commitment control ledger group.</p> <hr/>

Field or Control	Description
Remaining Amount (at the report line level)	<p>The remaining amount is calculated using the default commitment control ledger group associated with the general ledger business unit on the purchase order distribution line, the ledger group in the BU_LED_GRP_TBL table, and the setting of the Commitment Detail Ledger option on the Ledgers for a Unit - Commitment Control Options page.</p> <p>If you select the Commitment Detail Ledger option, the remaining amount is derived from KK_LIQUIDATION.MONETARY_AMT.</p> <p>If the Commitment Detail Ledger option is not selected, the remaining amount is derived from PO_LN_DISTRIB.MONETARY_AMT_BSE.</p>
Vouchered Amount	Sum of the vouchered amount associated with the purchase order distribution line.
Totals	The report provides totals for original purchase order amount, liquidated amount, remaining amount, and vouchered amount values.

Related Links

“Defining Ledgers for a Business Unit” (Application Fundamentals)

POS8002 - Requisition Budgetary Activity

Amounts are reported in the base currency of the general ledger business unit associated with the selected purchasing business unit.

ChartField types and values are reported based on your selections on the Req-PO Budgetary Activity page and on data stored in the REQ_LN_DISTRIB table.

Field or Control	Description
Business Unit	Purchasing business unit for which the report was run.
Budget Date From/To	Budget dates for which the report was run. The budget dates do not necessarily correspond to a budget period.
Remaining Amount (at the report header level)	Distribution remaining amount criteria against which the report was run.
REQ ID (requisition ID)	Requisition for which information is reported.

Field or Control	Description
Line/Sched/Dist (line/schedule/distribution)	<p>Report processing checks the Requisition Line Distribution tables and selects lines, schedules, and distributions for which the following criteria are met:</p> <p>The business unit and budget date on the line meet report request parameters.</p> <p>The report provides information for distribution lines with budget line statuses of <i>V</i> (valid) or <i>W</i> (warning).</p> <p>The line meets defined ChartField criteria, if any.</p>
Original REQ Amount (original requisition amount)	Original requisition distribution amount.
Liquidated Amount	<p>The liquidated amount is calculated from the original requisition amount less the remaining amount.</p> <hr/> <p>Note: You should define a default commitment control ledger group on the Ledgers for a Unit - Commitment Control Options page. The liquidated amount on the report is derived from the KK_LIQUIDATION table using the distribution's general ledger business unit and its default commitment control ledger group. The liquidated amount on the report is set to zero if you have not selected a default commitment control ledger group.</p> <hr/>
Remaining Amount (at the report line level)	<p>The remaining amount is calculated using the default commitment control ledger group associated with the general ledger business unit on the requisition distribution line, the ledger group in the BU_LED_GRP_TBL table, and the setting of the Commitment Detail Ledger option on the Ledgers for a Unit - Commitment Control Options page.</p> <p>If you select the Commitment Detail Ledger option, the remaining amount is derived from KK_LIQUIDATION.MONETARY_AMT.</p> <p>If the Commitment Detail Ledger option is not selected, the remaining amount is derived from REQ_LN_DISTRIB.MONETARY_AMT_BSE.</p>
PO Amount	Sum of the MONETARY_AMT_BSE field values from the purchase order distribution lines associated with the requisition distribution line.
Totals	The report provides totals for original requisition amount, liquidated amount, remaining amount, and PO amount values.

Related Links

“Defining Ledgers for a Business Unit” (Application Fundamentals)

PO Dispatch

This report provides basic information for the purchase order, such as its status, date, payment and freight terms, and buyer.

Related Links

[Creating Purchase Order Headers](#)

[Defining Purchasing Item Attributes](#)

[Select Purchase Order Page](#)

POXMLP - Print

The printed version of this report displays online and provides basic information for the purchase order, such as its status, date, payment and freight terms, and buyer. To create the printed version, click the **View Printable Version** link on the Purchase Order page.

Related Links

[Creating Purchase Order Headers](#)

[Defining Purchasing Item Attributes](#)

[Select Purchase Order Page](#)

POX4006 - Expediting Report by Buyer

This report provides a listing of expedited purchase orders sorted by buyers. Report details include the range of due dates included in the report, a listing of all purchase orders, the suppliers, and item descriptions. You can also run the report for all business units or limit the report to a range of business units.

POX4007 - Expediting Report by Supplier

This report provides a listing of expedited purchase orders sorted by supplier. Report details include the range of due dates included in the report, a listing of all purchase orders and buyers, and item descriptions. You can also run the report for all business units or limit the report to a range of business units.

POX4008 - Expediting Report by Due Date

This report provides a listing of expedited purchase orders by due date. Details include the range of dates included in the report and number of days past the due date that a purchase order is late. You can also run the report for all business units or limit the report to a range of business units.

POX4030 - PO Detail Listing By PO Date

This report provides a listing of purchase orders details sorted by business unit and then by purchase order dates. Details include the range of purchase order dates included in the report, purchase order IDs, items,

prices, and any contract information. You can run the report for all business units or limit the report to a range of business units.

POX4031 - PO Detail Listing By Supplier

This report provides purchase order details sorted by supplier SetID and then by supplier ID. Report details include the business unit, purchase orders, dates and line information and item descriptions. You can also run the report for all business units or limit the report to a range of business units.

POX4032 - PO Detail Listing By Buyer

This report provides purchase order details sorted by supplier SetID and then by supplier ID. Report details include the business unit, purchase orders, dates and line information and item descriptions. You can also run the report for all business units or limit the report to a range of business units.

POX4100 - PO To Requisition XREF

When you run this report, a business unit is required, and the system prompts you for a business unit if one is not entered. The report is sorted by business unit, then by purchase order ID. It additionally sorts requisitions associated with purchase orders. Report details include purchase order and requisition information.

POX5001 - Receiver Summary

When you run this report, a business unit is required. The system displays a message to enter a business. The report is sorted by business unit and then by the ship to business unit. Report details include the receipt ID, date, and status; supplier ID and name; and carrier ID.

POX5010 - Receiver Ship to Detail

When you run this report, a business unit is required. The system displays a message to enter a business. The report provides a listing of receipts sorted by business unit and receipt date. Report details include the range of receipts (receiver) included in the report and additional details about the receipt items.

POX5020 - Receiver Account Detail

When you run this report, a business unit is required. The system displays a message to enter a business. Report details include the range of receipt dates included in the report and is sorted first by business unit and then by receipt (receiver) date.

POX5030 - Receipt Delivery Detail

Provides a detailed list of shipments by receiver ID, including deliveries made through the Mobile Inventory Management application.

POX1100 - Requisition to PO XREF

When you run this report, a business unit is required. If you leave the **Business Unit** field blank, the report will be blank.

If you leave the **From Date** and **Through Date** fields blank, all requisitions are included.

POX3031 - Contract Activities

<i>Field or Control</i>	<i>Description</i>
Max Amount (maximum amount)	The maximum amount of the contract. <hr/> Note: The contract must not exceed the contract maximum amount. <hr/>

POX5001 - Receiver Summary

Note: Define ship to locations for all purchasing transactions at the schedule level.

<i>Field or Control</i>	<i>Description</i>
Rcv Date (receiving date)	The date on which you physically received the shipment.
Rcv Status (receiving status)	The status of the shipment.
Match Status	The matching status of the receipt line item. Values are: <i>Matched:</i> Fully matched. <i>No Match:</i> No match found. <i>Partial:</i> Partially matched. <i>To Match:</i> To be matched.
Bill Of Lading	The shipper's proof of identification of the material in transit.
Hold Asset	Indicates whether the system is currently processing asset information for this receipt or holding until you clear Hold Asset on the Receipt Defaults page. <i>Y</i> (yes) indicates that Hold Asset is selected for this receipt. <i>N</i> (no) indicates that Hold Asset is not selected for this receipt.

<i>Field or Control</i>	<i>Description</i>
Hold Inventory	<p>Indicates whether the system is currently processing inventory and putaway information for this receipt or holding until you clear Hold Inventory on the Receipt Defaults page.</p> <p><i>Y</i> (yes) indicates that Hold Inventory is selected for this receipt. <i>N</i> (no) indicates that Hold Inventory is not selected for this receipt.</p>

Note: You can no longer select **Hold Inventory** for a receipt after that receipt has a status of *Moved*.

Related Links

[Asset Management Information for Line Page](#)

[Defining Receipt Statuses](#)

POX5020 - Receiver Account Detail

<i>Field or Control</i>	<i>Description</i>
Rcv Status (receiving status)	The status of the shipment.

<i>Field or Control</i>	<i>Description</i>
GL BU (general ledger business unit)	The PeopleSoft General Ledger business unit associated with the selected distribution.
Product	The identification number of the product group to which the selected distribution line item belongs.

Related Links

[Defining Receipt Statuses](#)

POX5030 - Receipt Delivery Detail

<i>Field or Control</i>	<i>Description</i>
Bill of Lading	Displays the shipper's proof of identification of the material in transit.
Recv Ln (receiving line)	Displays the receipt line number.

<i>Field or Control</i>	<i>Description</i>
PO HDR Comment/PO LINE Comment	Displays the header and line comments entered on the purchase order with the Shown at Receipt option selected.

- Shop Floor Receipt Delivery

<i>Field or Control</i>	<i>Description</i>
Production ID	If the item is associated with a PeopleSoft Manufacturing production kit, the system displays the item's associated production ID in this field.
Operation Sequence	The order number in which this material is used in the production sequence.
WC Description (work center description)	Description of the selected work center.
Bill of Lading	The shipper's proof of identification of the material in transit.
Recv Ln (receiving line)	The identification number of the line on the receipt.

POX5050 - Return To Vendor Detail

<i>Field or Control</i>	<i>Description</i>
RTV ID (return to vendor)	Select a Return To Vendor ID in combination with a business unit to run a report for an individual return.
Return Status	Select a return status to run a report for all vendor returns having a specific return status and business unit.
Freight Terms	If freight terms apply to this return to vendor, this field shows the applicable terms according to the schedules of the purchase order for the received material. The freight terms reflect who holds legal responsibility for the material until ownership has passed.
Disp Type (disposition type)	Disposition assigned to the item being returned.
Prod ID (production ID)	If the item is associated with a production kit, this field displays the item's associated production ID.

Field or Control	Description
OP Seq (operation sequence)	Number designating the sequence in which production uses this material.
Ship Via	Route or mode of transportation for the shipment line assigned to the returned material. The ship via can differ line to line if for some reason an item requires a different method of shipping. For example, a shipment line may require a ship via for a hazard-controlled item.