

ORACLE

Partner

XPLM[®]

User Guide

PTC Creo Parametric integration
for
Oracle Agile PLM

Valid for product version: 3.6.5

Published: 13.03.2025 | Build: 916 | Revision: 5f7ac1bc4

XPLM Solution GmbH

Altmarkt-Galerie

Altmarkt 25

01067 Dresden

Office: +49 351 82658-0

Fax: +49 351 82658-88

Web: www.xplm.com

Legal information

Non-disclosure

The information in this document is to be treated confidentially.

Licensing

XPLM Solution GmbH (XPLM) does not issue licenses for the software components to be integrated. These licenses must be obtained from the respective software manufacturer.

Support

For Oracle Agile Engineering Collaboration support, contact the Oracle Global Customer Support (GCS) at www.oracle.com/support, or My Oracle Support at <https://support.oracle.com>.

Handling personal data

Against the background of the EU General Data Protection Regulation (GDPR), XPLM informs about the processing of personal data in its contracts and privacy policies. The extent to which XPLM comes into contact with personal data from the customer environment while providing services depends on the customer's IT systems and the data transmitted to XPLM. XPLM is generally not interested in gaining access to personal data from the customer environment. If this cannot be avoided, the customer is responsible for such personal data and must enter into a GDPR-compliant data processing agreement with XPLM.

Information exchange: The integration software exchanges information between the systems involved in the form of attributes. What is contained in these attributes is left to the customer's definition. For ECAD integrations, the exchanged attribute information is saved in the file `metadata.xml` in the configured project directory or directly in the project files.

For other integrations, the exchanged attribute information is saved in files or objects of the source system.

Log files: To record activities of integration functions, the integration software stores log files on the computer on which it is installed. These log files can also contain information from Windows environment variables, for example the user and computer name. For ECAD integrations, log files are stored in the directory `%TEMP%\integrate` by default. This directory can be deleted, but new log files will be created when the integration software is used again. For other integrations, logging is deactivated by default. Activation, protocol level and storage location must be set up in advance. Directories with log files can be deleted, but new log files will be created when the integration software is used again.

Other policies: XPLM also refers to the privacy policies of the software manufacturers involved for the handling of personal data in their systems.

Table of Contents

Legal information.....	ii
Glossary.....	6
1 Introduction.....	7
1.1 About this document.....	7
1.2 Naming conventions.....	7
1.3 Integration overview.....	8
1.4 Supported file types.....	8
2 Functional description.....	9
2.1 Agile menu.....	9
2.2 Login dialog.....	11
2.3 Create Object Dialog.....	12
2.3.1 Details Pane.....	13
2.3.2 Preferences Pane.....	15
2.3.3 Workspace Pane.....	15
2.3.4 Design and Item Properties.....	15
2.4 Agile Save Preview Dialog.....	15
2.4.1 Browser View.....	16
2.4.2 Toolbar.....	17
2.4.3 List View.....	19
2.4.4 Side Panel.....	24
2.4.5 Drawing Handling Dialog.....	26
2.5 Load Dialog.....	27
2.5.1 Browser view.....	27
2.5.2 Toolbar section.....	28
2.5.3 List View.....	30
2.6 Preferences Dialog.....	31
2.6.1 PLM Usage.....	33
2.6.2 Load Options.....	34
2.6.3 Save Options.....	35
2.6.4 Class Default Settings.....	36
2.6.5 Viewable Creation.....	38
2.6.6 Property Value Preferences.....	39

2.6.7	Mapping Editor.....	40
2.7	Workspace Browser.....	42
2.7.1	CAD Tab.....	43
2.7.2	Workspace Tab.....	46
2.8	Assign Change Dialog.....	51
3	Usage.....	53
3.1	Starting the Integration.....	53
3.2	Create New Object from Template.....	53
3.3	Save to Agile PLM.....	54
3.3.1	Saving to Agile PLM via Save Preview.....	54
3.3.2	Assigning an Existing Design Object.....	55
3.4	Load to Creo Parametric.....	56
3.4.1	Loading from Agile PLM.....	56
3.4.2	Lazy Load Feature.....	57
3.5	Access Control Management.....	57
3.5.1	Check Out and Cancel Check Out.....	57
3.5.2	Concurrent Engineering.....	58
3.5.3	Strict CAD Modification Workflow.....	58
3.6	Property exchange.....	59
3.6.1	Property Mapping.....	59
3.6.2	Update properties.....	60
3.7	Material and BOM management.....	61
3.7.1	Assigning Items.....	61
3.7.2	Assigning an Existing Item Object.....	62
3.7.3	BOM publishing.....	64
3.8	Workspace Management.....	64
3.8.1	CAD working directory vs. EC Workspaces.....	64
3.8.2	Workspaces on Save.....	65
3.8.3	Workspace on Load.....	65
3.8.4	Workspace on CAD start.....	66
3.8.5	Files in the Workspace Tab.....	66
3.8.6	Collaboration files.....	66
3.9	Change control.....	66
3.9.1	Design File Release Process.....	66

3.9.2	Assign a New Change Order.....	67
3.9.3	Assign An Existing Change Order.....	68
3.10	Creo Parametric specific functionality.....	69
3.10.1	Thumbnail support.....	69
3.10.2	Handling of Family Tables.....	69
3.10.3	Handling External References.....	71
3.10.4	Handling Suppressed Components.....	71
3.10.5	Mapping Find Numbers to Agile PLM BOM.....	72
3.10.5.1	Using Agile Find Numbers in Creo Parametric.....	72
3.10.6	Handling Simplified Representations.....	72
3.10.7	File Sync status Mismatch.....	73
3.10.8	Intermediate Data Format (IDF) Import.....	73
3.10.9	Handling of Standard Parts.....	73

Glossary

Application Programming Interface (API)

Defines a set of routines, communication protocols and tools for building software. In general, they are clearly defined methods for communication between different components.

Bill of Materials (BOM)

Defines a list of assemblies, sub-assemblies, items and their quantities needed to produce a final product.

BOM position

Defines a position in the BOM with unique identification, name, quantity and other characteristics.

Connector

Defines a central interface component of each XPLM integration. The integration uses connectors for each participating application to exchange data via their API.

Datamodel

Defines objects and their relationships in a PLM system that are managed by the integration to store data from an authoring application.

Dynamic Link Library (DLL)

Defines a file with a library of functions and other information that can be accessed by a Windows program.

Java Runtime Environment (JRE)

Defines a runtime environment for Java technology. It is used to execute Java applications largely independently of the underlying operating system.

Payload

Defines the data contained within an API request. The description is borrowed from the transportation industry, where a truck carries its cargo (its payload) to a location. The truck, as with the API request, is always the same, but the payload changes with each request.

Product Lifecycle Management (PLM)

Defines systems and processes for managing data during the development of a product from creation through manufacturing to maintenance and disposal.

Revision

Defines a released object state in Agile PLM that cannot be modified.

Script engine

Defines the central component in each integration. It contains the integration logic for processing and forwarding the information and data coming from the connectors.

User Interface (UI)

Defines a (usually) graphical interface through which a user interacts with the computer.

Version

Defines an incremental counter of each object modification in Agile PLM on check-in.

x86/x64

Defines the processor architecture in a computer and thus also the performance of applications. x86 corresponds to 32-bit and x64 corresponds to 64-bit.

1 Introduction

1.1 About this document

You are reading the User Guide of the PTC Creo Parametric integration for Oracle Agile PLM.

Purpose

This document shows how to use the integration.

Target audience

This document is intended for engineers in the company, who use the integration on a daily basis. System administrators should also read this document to familiarize themselves with the user interface and integration functions.

How to read this document

This document is structured chronologically and you should read it in the order of the chapters described. If you skip chapters, you will miss important information.

Where appropriate, cross-references to other chapters are listed. To quickly return to where you came from after clicking such a link, click the **Back** button in your PDF viewer. Try it right now with [this link!](#)

Notes used



This note highlights additional information about the current content.



This note highlights important instructions.

1.2 Naming conventions

In addition to the terms already listed in the glossary, the following naming conventions are used in this document. Familiarize yourself with these names. You will find them throughout the document.

Form Used	Generally refers to
Agile PLM	Oracle Agile PLM
Creo Parametric	PTC Creo Parametric
Item	Item in Agile PLM
Attribute	Object property in Agile PLM
Parameter	Property in the component

1.3 Integration overview

The integration is the interface between Creo Parametric and Agile PLM and is designed for seamless and efficient data exchange between both applications.

The integration focuses on a Creo Parametric-centric workflow, enabling users to interact with Agile PLM directly within Creo Parametric. The main integration functions include saving, loading, and performing object operations. When saving CAD data to Agile PLM, corresponding objects and structures are created in Agile PLM and linked to the CAD data. The original CAD files are attached to these objects, allowing for centralized data management within the company.

To support concurrent engineering and avoid access conflicts, the integration utilizes the object reservation capabilities (checkin/checkout) from Agile PLM.

The integration functionalities are accessible through additional toolbars or extended menus in Creo Parametric.

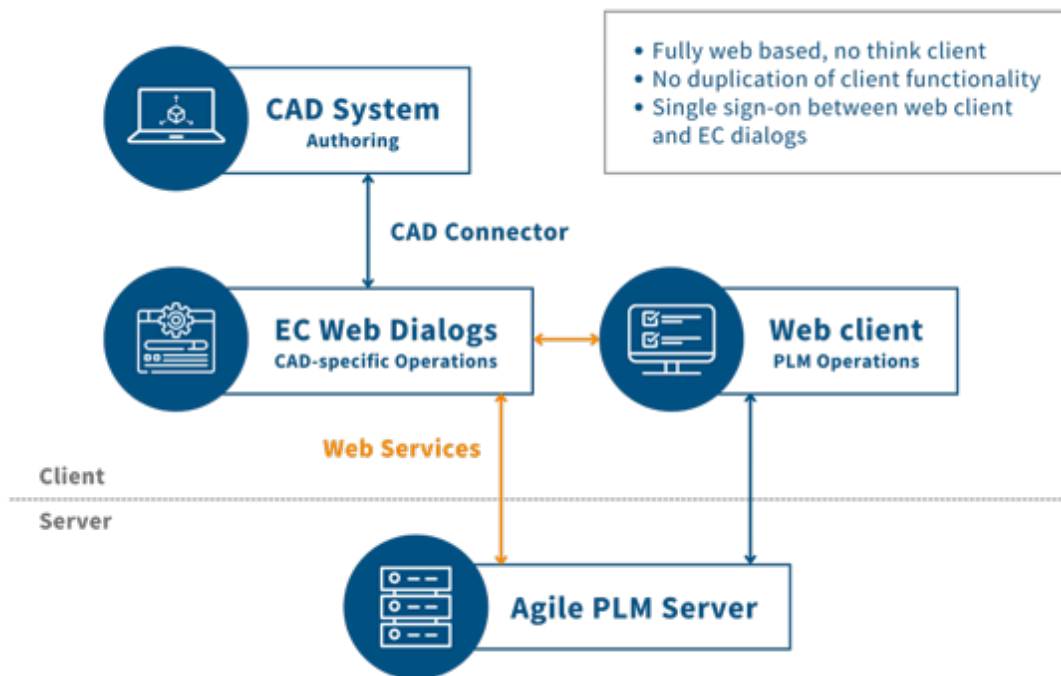

1.4 Supported file types

The Creo Parametric connector supports the following file types:









File type	File extension
Part	.prt
Assembly	.asm
Drawing	.drw
Format	.frm
Notebook	.lay











2 Functional description







2.1 Agile menu

After installing the integration, the integration ribbon menu appears on the Creo Parametric user interface. Additional steps may be required to make the integration menu visible. See Installation and Administration Guide for more information.

The integration menu contains the following commands;

Icon	Command	Description
	Search	Opens the Agile PLM Web Client from where you can find a design to load into Creo Parametric. Note that the load function can be initiated directly from the web client using the Load to CAD function.
	Create	Opens the Agile Create Object dialog which enables users to create new objects based on templates saved in Agile PLM.
	Save Preview	Saves files from the current Creo Parametric model and all its components into Agile PLM, with a dialog that allows the setting of save options.
	Save	Saves, Checks In and then Checks Out (increment save) the files from the current Creo Parametric model and all its components into Agile PLM, without launching the Save Preview dialog.
	Check In	Saves and Checks In the current Creo Parametric model and its structure into Agile PLM without launching the Save Preview dialog.  Also available in the Creo Parametric feature tree context menu.
	Save session	Saves all opened files from the current Creo Parametric session into Agile PLM, with a dialog that allows the setting of save options.
	Save Family Table	Allows the user to save an entire family table to Agile PLM at once. With Creo Parametric, this process also validates the family table. The user is prompted if there are any errors with the validation process and a log file is created for review.

Icon	Command	Description
	Save Modified	<p>Searches for all locally modified objects within the currently loaded Creo Parametric model structure and saves them to Agile PLM via the Save Preview.</p> <p> When using this function, the structure of the Creo Parametric model is displayed on the Save Preview if both the parent and child elements are marked as locally modified. The lack of structure information on the Save Preview does not affect the structure in Agile PLM.</p> <p>For Creo Parametric, this function has to be configured. See Installation and Administration Guide for more information.</p>
	Check Out	<p>Performs a Check Out in Agile PLM for the selected Design objects.</p> <p> Also available in the Creo Parametric feature tree context menu.</p>
	Cancel Check Out	<p>Cancel the Check Out for the selected Design objects in Agile PLM.</p> <p> Also available in the Creo Parametric feature tree context menu.</p>
	Current	<p>Sets custom file property values in Creo Parametric based on values from Agile PLM. Only properties for the current Creo Parametric model are updated.</p>
	First Level	<p>Sets custom file property values in Creo Parametric based on values from Agile PLM. Properties for the current Creo Parametric model and the next lower level (typically used for setting drawing and model properties together).</p>
	All Levels	<p>Sets custom file property values in Creo Parametric based on values from Agile PLM. Properties for the current Creo Parametric model and all its child components are updated.</p>
	Transfer BOM Find Numbers	<p>Transfers BOM table find numbers from drawing BOM tables to the BOM tab of the related model Item in Agile PLM.</p> <p> Some connectors do not support this function for drawing files with multiple reference models and/or multiple BOM tables.</p> <p>For Creo Parametric, this function has to be configured. See Installation and Administration Guide for more information.</p>

Icon	Command	Description
	Workspace Manager	Opens the Workspace Manager dialog which displays Agile PLM related information of the current Creo Parametric model and all its components. The Workspace Manager's main task is to facilitate file management.
	Preferences	Opens the Preferences Dialog which enables user to define settings for saving and loading to and from Agile PLM . The Preferences window is also used to open the Mapping Editor.
	Show Agile Form	Launches the Agile PLM Web Client and displays the Design object of the current Creo Parametric file.  Also available in the Creo Parametric feature tree context menu.
	Disconnect Session	Terminates the connector session and starts a new one. Usually, the integration is started automatically on demand by using any of the menu items except About and Disconnect Session .
	About	Provides basic information about the Creo Parametric integration in use.

2.2 Login dialog

In this dialog, you can establish a connection to Agile PLM.

The login dialog is launched by using any of the integration menu functions except **Disconnect Session** and **About** buttons.

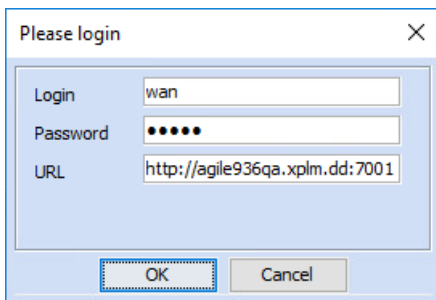

The integration manages the connection to Agile PLM in the background and you only need to know user name, password and URL for Agile PLM.

 The URL should not contain blanks or a forward slash (/) at the end of the URL otherwise there might be problems with the connection.

 You do not need to add the suffix `/Agile` to the URL in the login dialog as it is done on the Web Client.

When you close Creo Parametric, the integration also disconnects from Agile PLM and all processes are stopped.

2.3 Create Object Dialog

In this dialog, you can create new objects simultaneously in Creo Parametric and Agile PLM using template files stored in Agile PLM.

The Agile Create Object dialog is displayed by the **Agile > Create** command within the integration menu.

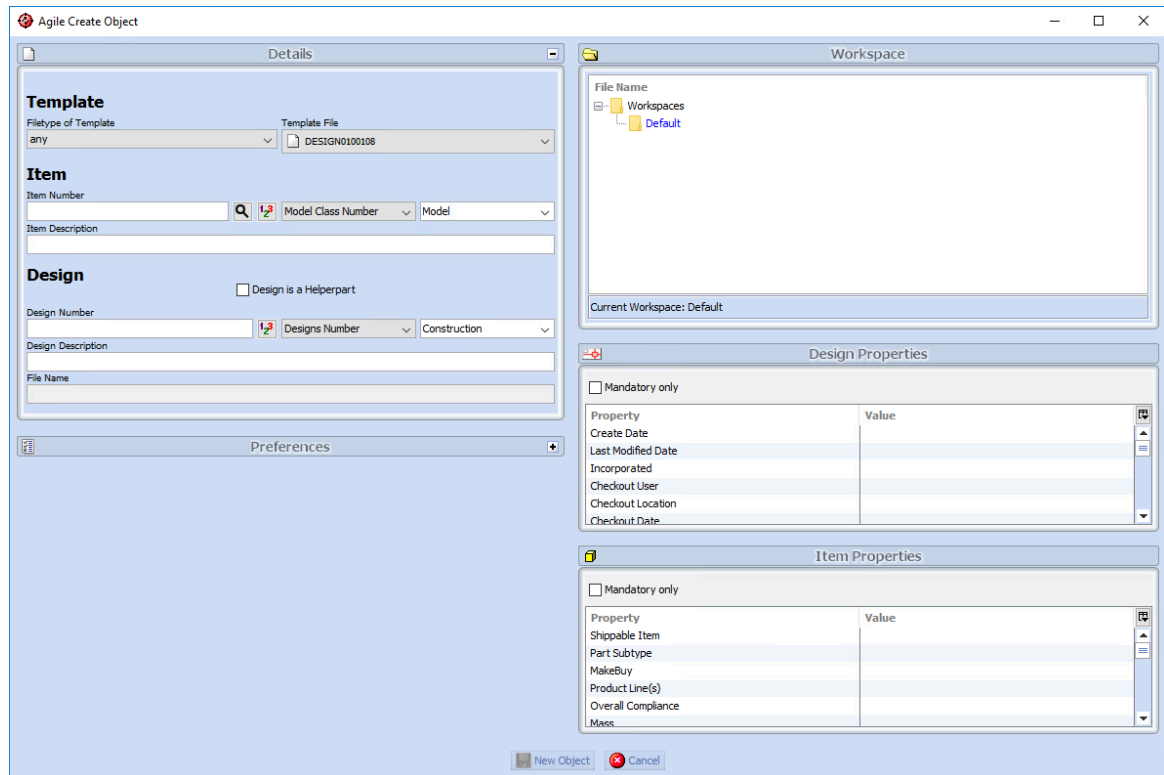





Sections in the Create Object dialog :









- Details pane
- Preferences pane (collapsed in the figure)
- Workspace
- Design Properties
- Item Properties

The **Preferences** pane, **Workspace** pane, **Design and Item Properties** panes have the same functionality as those of the Save and Load Preview's side panel. See [Side Panel](#) (p. 24) for more information.

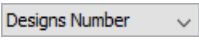
2.3.1 Details Pane

This section contains the main functions for creating new objects.

Property	Description
Filetype of template	<p>This is a combo box that allows the user to select the file type for the templates to be displayed in the Template File combo box.</p> <p>The subtype is displayed in brackets behind its file type if templates with assigned subtypes are available for selection. The following options are possible:</p> <ul style="list-style-type: none"> ▪ any - all available templates are displayed. ▪ Entry without subtype - all templates of that file type are displayed. ▪ Entry with subtype - Only the templates of that file type and subtype are displayed. <p>See Installation and Administration Guide for more information.</p>
Template file	<p>Displays a list of available templates in Agile PLM. Only suitable template files and their description (if given in Agile PLM) are displayed depending on the file type chosen.</p> <p> New objects can only be created if a valid file type is selected.</p>
Item Number	Shows the Item object Number in Agile PLM.
Item Search 	<p>Searches for existing Item objects in Agile PLM using values entered in the Item Number field.</p> <p>If there is one match, the found Item object Number is written into the Item Number field. If more than one match is found, a dialog pops up displaying all available matches from which the user can select the desired Item object.</p>
Item Autonumber generator 	Automatically creates and assigns a unique and sequential Item Number to the selected object from the (pre)selected Item Number source.
Item Autonumber <input type="text" value="Part Number"/>	Shows the Item autonumber source to be used for the selected subclass.
Item Subclass <input type="text" value="Part"/>	<p>Shows the Item subclasses available in Agile PLM. This combo box is set inactive if no item should be created.</p> <p> Auto-completion is supported based on text entered.</p>
Item Description	<p>Shows the description of the Item object in Agile PLM.</p> <p> If you add the item description before you select the item autonumber, the description will automatically carry to the design description otherwise you will need to fill in the design description separately.</p>

Property	Description
Design Number	Shows the Design object Number in Agile PLM.  This field must contain a value for new objects to be created.
Design Autonumber generator 	Automatically creates and assigns a unique and sequential Design Number to the selected object from the (pre)selected Design Number source.
Design Autonumber 	Shows the Design autonumber source to be used for the selected subclass.
Design subclass 	Shows the Design subclasses available. User can select the subclass to be used for creating the file in Agile PLM.  Auto-completion is supported based on text entered.
Design Description	Shows the description of the Design object in Agile PLM.
File Name	Shows the file name of the Creo Parametric model from which the template was created.
Design is a Helperpart	Flags a Design object as a helperpart in Agile PLM when selected. A Helperpart is a Creo Parametric component that is used in the structure but is not part of the finished product. It is represented as a Design but not an Item in Agile PLM Default : False
New Object 	Initiates the process to create a new object in Agile PLM and in Creo Parametric based on the selected template.  This button is inactive (greyed out) if required fields are not filled in. By default, Template file and Design Number are set as required fields. They are both needed to activate this button. See Installation and Administration Guide for more information.
Cancel 	Closes the dialog without further action The dialog can also be closed using the close button (X) in the top right corner.

 If any attribute value, for example description, in the Creo Parametric system contains unsupported characters as defined in the character set rule of the Agile PLM attribute, the attribute will not be saved or updated in Agile PLM.

Starting from 9.3.6 RUP21, a warning message will be logged in `webservice.log` if the log level sets to **WARN** (Default value is **ERROR**) in `<AgileHome>\agileDomain\config\log.xml`. The warning message will also be returned in web service response.

Starting from MCAD 3.6.4.3, the end users can see the warning message from MCAD client.

2.3.2 Preferences Pane

This section shows the Preferences dialog. See [Preferences Dialog](#) (p. 31) for more information

The Preferences pane behaves much like that displayed on the Save and Load previews. However, it has one major difference in that changes in Class Default settings are automatically applied to the corresponding sections of the Details pane.

2.3.3 Workspace Pane

This section shows the current workspace and the workspace directory structure. See [Workspace Tab](#) (p. 46) for more information.

2.3.4 Design and Item Properties

These sections contain a list of Design and Item properties and their values in tabular form.

The *Value* column is usually editable, and a few entries for the Design Properties may be preassigned depending on the selected template. A property is preassigned if a corresponding entry in Agile PLM for the selected template object exists. Whenever a new template is selected in the combo box the predefined values of that template are loaded into the table.

These properties can also be set as *Required*, meaning that you must enter a value before exiting the dialog. You can filter the list to only display the required properties by clicking on the check box **Mandatory only**. See Installation and Administration Guide for more information.

Related links

[Side Panel](#) (p. 24)

2.4 Agile Save Preview Dialog

In this dialog you can save Creo Parametric data to Agile PLM and review related information.

The *Agile Save Preview dialog* is displayed by the **Agile > Save Preview** command within the integration menu.

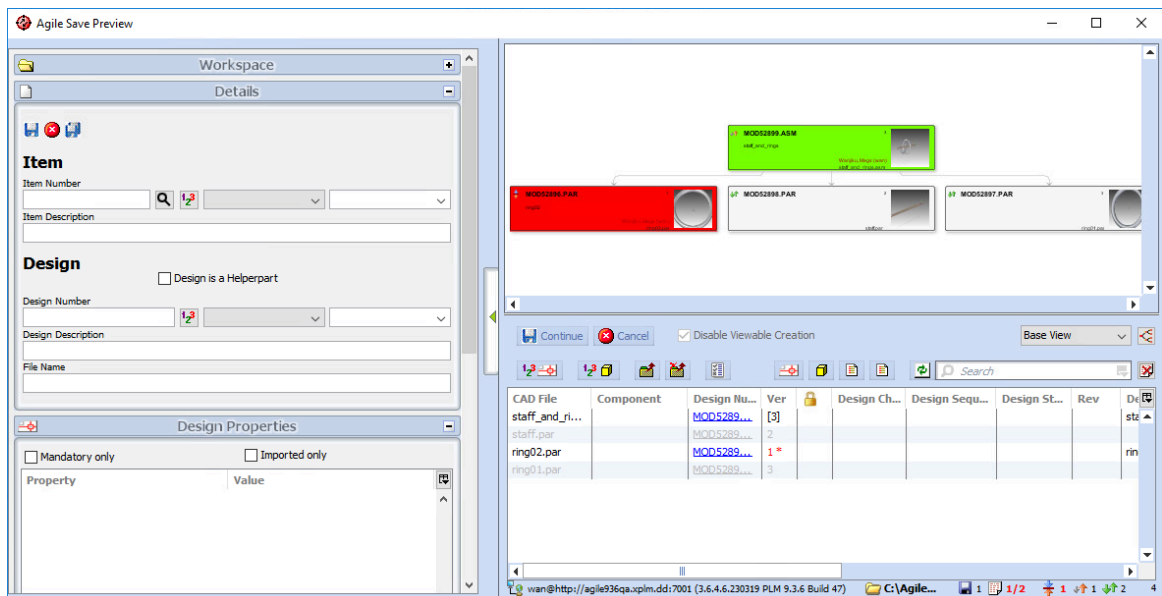

Sections in the Save Preview dialog:

- Browser view (also called Graph view)

- Toolbar
- List View
- Side Panel (collapsible)
- Status line with integration version, PLM version, current workspace directory and number and status of available files in the model window



The appearance of the *Save* dialog can be changed by system administrators or users. See Installation and Administration Guide for more information.

2.4.1 Browser View

This section shows the Creo Parametric model structure information.

The browser view is enabled by default but it can be disabled by clicking on the **Tree view Toggle** button on the toolbar. See Installation and Administration Guide for more information.

The node boxes in the browser view are rendered using an `xhtml` template and `css` style-sheet. Each node in this browser view contains Creo Parametric model and Agile PLM related information if it exists.

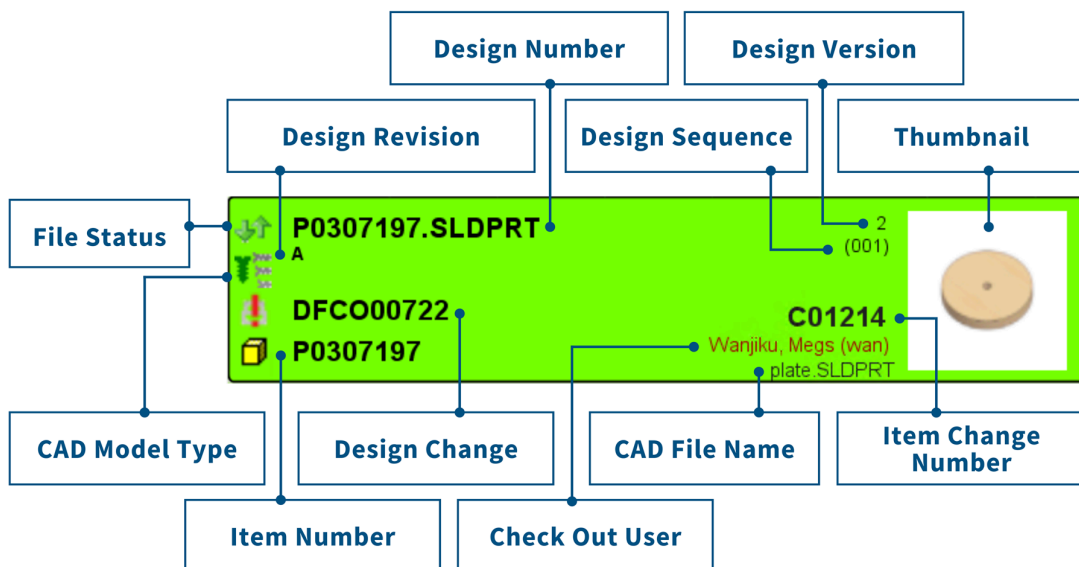

Multi-select and Context Menu

You can either select one node by left-clicking on it, or multi-select several nodes by placing the cursor in the browser view, mouse left click and dragging over the desired nodes. Once you have selected the desired items, you can use the context menu (right mouse button) to execute any of the commands listed.

You can also open the detail view of a model in the Side Panel by double clicking a node.

Node Color Codes







The background color of the node boxes visualizes the status of the displayed files. An explanation of the colors shown in the Save Preview is given in the table:











Color	Description
Green	The file is selected for saving meaning the Save Option column is not empty.
Yellow	File is Agile PLM unknown and no Save Option is selected



Color	Description
Light Grey	The Agile PLM information has been retrieved and the file is not modified locally or in Agile PLM.
Dark Grey	File is the same locally and in Agile PLM. No Save Option is selected.
Red	A newer version is available in Agile PLM, but the file is modified locally. No Save Option is selected
Light Red	The Design object (or rather the files of this Design object) are incorporated to a DFCO and thus it is not possible to check out (and check in) the Design object.
Orange	Latest version is modified locally but no Save Option is selected.
Dark Blue	A newer version is available in Agile PLM. No Save Option selected
Dark Blue-gray	Strict Modification Workflow is enabled and <code>MUST_NOT_SAVE</code> flag is set for the file in the Save Preview dialog.

2.4.2 Toolbar

This section contains the main functions for saving model data to Agile PLM.

Function	Description
Continue 	Starts the save operation to Agile PLM.
Cancel 	Closes the dialog without further action The dialog can also be closed using the close button (X) in the top right corner.
Save As 	Assigns new Design and Item objects to the selected components depending the preference settings.
Create Items 	Assigns Item objects to the selected Design Objects that are not already linked to an Item in Agile PLM. If Item assignments already exists, nothing is done.
Check Out 	Sets reservation for the selected components in Agile PLM.
Cancel Checkout 	Removes reservation for the selected components in Agile PLM.
Open Preferences 	Opens the Side Panel to display the Preference dialog section. See Preferences Dialog (p. 31) for more information

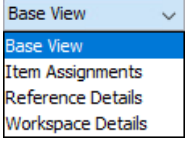
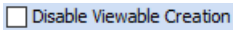
Function	Description
Refresh 	Reloads all Agile PLM related data that is displayed in the Save Preview.
Open form for Design 	Launches the Agile PLM Web Client and displays the Design Object of the selected component.  You need to highlight the row of the desired object in the list view or select the corresponding node in the graph view before selecting this function.
Open form for Item 	Launches the Agile PLM Web Client and displays the Item Object (if it exists) of the selected component.  You need to highlight the row of the desired object in the list view or select the corresponding node in the graph view before selecting this function.
Open form for Item Change 	Launches the Agile PLM Web Client and displays the Item Change Object (if it exists) assigned to the Item object of the selected component.  You need to highlight the row of the desired object in the list view or select the corresponding node in the graph view before selecting this function.
Open form for Design Change 	Launches the Agile PLM Web Client and displays the Design Change Object (if it exists) assigned to the Design object of the selected component.  You need to highlight the row of the desired object in the list view or select the corresponding node in the graph view before selecting this function.
Tree view Toggle 	Switches the visibility of the browser/graph view on and off. By default, the browser view is visible. See Installation and Administration Guide for more information.
Filter Modified Toggle 	Switches the visibility of non-modified files in the table on and off. By default, all files are shown. See Installation and Administration Guide for more information.

Function	Description
<p>Attributes View selector</p> 	<p>The view selector switches the visibility of column headers containing different attributes visible in the list view.</p> <ul style="list-style-type: none"> ■ The Base View shows the main attributes of the model and assigned Design objects. ■ The Item Assignments view shows additional information about the Item assignment and the Item attributes. ■ The Reference Details view shows specific information for Parts with external references or part families. ■ The Workspace Details view shows the complete local path directories for all components shown in the Save Preview dialog.
<p>Disable Viewable Creation</p> 	<p>When viewable creation is enabled on the Preference dialog, this function can be used to temporarily disable viewable creation for the current save process.</p> <p>Default: False</p>
<p>Search</p> 	<p>The search field is used to filter the elements displayed in the list view using user-given criteria. This search criteria is based on the properties given in the column headers.</p> <p>You can select or change the search criterion by clicking on the arrow icon on the right-hand side of the search text field and checking the desired attribute to be used.</p> <p> You can only use a single search criterion. Multiple search criteria are not supported.</p>

2.4.3 List View













This section shows the model data with its metadata in tabular form. When the save dialog is started, checks are performed on the model, status and possible actions are indicated for each file/object.

















Sections in the list view include:



- Column headers
- Row items

Column headers

Columns	Description
CAD File	Shows the file name of the Creo Parametric model selected for save.
Component	Shows the component type of the Design object in Agile PLM.
Design Number	Shows the Design objects Number in Agile PLM.
Version	Shows the version of the Design object in Agile PLM.

Columns	Description
Is Incorporated 	<p>Shows the incorporate status of the assigned Design change order. This column is blank if no Design Change is assigned.</p> <ul style="list-style-type: none">  - The change is not incorporated on the Design Change. Saving with save option Check In/Incorporate implicitly incorporates the change.  - The change is incorporated on the Design Change, but the Change is not released.  - The change is incorporated on a Design Change, that is released.
Design Change	Shows the design change order number assigned to the selected Design object. This column is blank if no Design change is assigned.
Design Sequence	Shows the Design sequence of the related Design change order. This column is blank if no Design change is assigned.
Design Status	Shows the status of the related Design change order. This column is blank if no Design change is assigned.
Rev	Shows the revision of the Design object in Agile PLM. This column is displayed in the Base View .
Description	Shows the description of the Design object in Agile PLM. This column is displayed in the Base View .
Lifecycle Phase	Shows the Lifecycle Phase associated with the current Design version in Agile PLM. This column is displayed in the Base View .
Checkout User	Shows the user who has checked out the object in Agile PLM.
File Status 	<p>Shows the status of the local file. Possible values are:</p> <ul style="list-style-type: none">  - The file does not exist in Agile PLM, the object is preselected for save  - The local file is up to date with Agile PLM, the object is deselected from save  - The file is modified locally and is known in Agile PLM, the object is preselected for save  - The file is known in Agile PLM and was modified by someone else in Agile PLM, the object is deselected from save  - A newer version is available in Agile PLM, but the file is modified locally. The object is NOT preselected for save.  - Unknown synchronization status. Agile PLM ID exists, but the cache information is missing.
Save Option	<p>Shows the save options for the selected object. possible values are:</p> <ul style="list-style-type: none"> (blank) - Do not save Check In/Incorporate - Save and Check In. Additionally set Incorporate status if a pending Design Change is assigned. Save - Save, Check In and Check Out again. <p> Check In/Incorporate is the only option that triggers publishing to Item based on the preference settings.</p>

Columns	Description
Save Status 	<p>Indicates whether an object can be saved to Agile PLM, based on the user's privileges and the state of the object in Agile PLM.</p> <ul style="list-style-type: none"> ▪  - File can be saved to Agile PLM ▪  - No write privilege in Agile PLM. Cannot be saved. ▪  - Check Out or Save As action required to save the object to Agile PLM ▪  - A newer version is available in Agile PLM. ▪  - Shows the missing privilege in combination with the underlying icon. Possible combinations include: <ul style="list-style-type: none"> <input type="checkbox"/>  Check Out <input type="checkbox"/>  Check In <input type="checkbox"/>  Modify <input type="checkbox"/>  Cancel Checkout disabled if checked out by another user. ▪ (blank) the file can be saved to Agile PLM.
Part Assignment 	<p>Shows the Item assignment status</p> <ul style="list-style-type: none"> ▪  - You cannot assign an Item Object to this Design Object (e.g., for Drawings, Helperparts and Manufacturing) ▪  - An Item object is assigned to the Design object ▪ (blank) - No Item object is assigned to the Design object.
Item Number	Shows the Item object ID in Agile PLM.
Rev	Current revision of the Item in Agile PLM. Parentheses indicate a pending revision. This column is displayed in the Item Assignments View .
Item Change	The Item Change Order that is assigned to the Item Object. If there are multiple pending changes, the desired change can be selected here.
Item Lifecycle Phase	The lifecycle phase associated with the current Item. This column is displayed in the Item Assignments View .
Description	Shows the description of the Item object in Agile PLM. This column is displayed in the Item Assignments View
CAD Model Type 	<p>Displays whether a file is an instance or the generic model of a part family or configurations. using icons</p> <ul style="list-style-type: none"> ▪  - Indicates the file is generic model ▪  - Indicates the file is an instance model <p>This column is displayed in the Reference Details View.</p>
Part Family 	<p>Shows the file name of generic model of a part family or configurations.</p> <p>The row of the generic model does not contain a value.</p> <p>This column is displayed in the Reference Details View.</p>

Columns	Description
CAD Link Type 	Displays whether a file contains reference geometry or is the referenced geometry; <ul style="list-style-type: none"> ■  - Model is linked from other models or is merged into other models ■  - Model contains linked geometry or merged geometry. This column is displayed in the Reference Details View .
Link Reference	Lists the name(s) of the referenced model(s). This column is displayed in the Reference Details View .
CAD File in Workspace	Shows the the path to the local directory where the file is stored. This column is displayed in the Workspace Details View .
Type	Shows the Creo Parametric file extension

You can select or deselect column headers to be displayed in this section by expanding the drop down list on the right hand side after the last column. The attributes visible in this list are also configurable. See Installation and Administration Guide for more information.



You can also move Columns around to arrange them in your preferred order.

Row Items

Model data is shown per row item in different columns.

You can either select one line item or multi-select several items by either **CTRL**+left-click, or a sequence with **SHIFT**+left-click.



















You can directly open the form of Design, Item or Change objects in Agile PLM Web Client by clicking on the corresponding hyperlinks embedded in the row items. These hyperlinks are displayed in blue.

You can also open the detail view of a model in the Side Panel by double clicking the row item.

Save Preview Context Menu

The context menu is available on both the browser and list view. Right click on a node (browser view) or a line item (list view) and you can select additional functions from the context menu.

Command	Description
Edit properties 	Allows user to edit properties for single selected objects by launching the SidePanel. See Side Panel (p. 24) for more details.
Save 	Assigns the save option Save to the selected objects.
Check In/Incorporate 	Assigns the save option Check In/Incorporate to the selected objects.
Don't Save 	Removes any assigned save option.

Command	Description
Check Out 	Performs a Check Out in Agile PLM for the selected Design objects.
Cancel Check Out 	Cancels the Check Out for the selected Design objects in Agile PLM.
Load Drawings	Performs a Where Used query in Agile PLM on the selected objects and filters related drawings. The resulting drawings are added to the <i>Save Preview</i> and highlighted in cyan.  Do not use this function for drawings that already exist in the local workspace as it may lead to data corruption or reverting of local modifications.
Save As 	Assigns new Design and Item objects to the selected components depending the preference settings.
Create Items 	Assigns Item objects to the selected Design objects that are not already linked to an Item in Agile PLM. If Item assignments already exists, nothing is done.
Assign Change 	Opens a dialog window that allows users to assign Design and Item change orders to the selected objects. See Assign Change Dialog (p. 51) for more information
Select Change 	Copies the Change of the selected Design or Item to the clipboard, you can assign an existing Change to another object this way.
Publish to Item 	Publish the latest checked in Design content including Structure, BOM structure and viewables to the assigned Item.
Delete Item Assignment 	Remove the relationship to the Item in Agile PLM.
Assembly sub menu 	Executes all contained actions for all children of the selected nodes.
Parents sub menu 	Executes all contained actions for all parents of the selected nodes.
Graph view sub menu 	Provides different ways to show the selected objects and their children in the browser view.

Related links

[Side Panel](#) (p. 24)

2.4.4 Side Panel

This section can be shown or hidden and is located on the left side of the Save preview dialog.

The side panel has the following sections:





- Workspace
- Details Panel
- Design Properties
- Item Properties
- Preferences Panel







Workspace

This section shows the current workspace and the workspace directory structure. See [Workspace Tab](#) (p. 46) for more information.

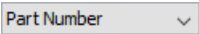
Details Panel

This section contains the main functions and properties for saving model data in Agile PLM. The main purpose is to assign Item and Design numbers and Descriptions.

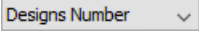
Function/Property	Description
Save 	Saves the changes made to the Details panel. This button is greyed out by default and is only activated when Save As function of the side panel is activated. This function also stores the Design properties in the Agile PLM.
Cancel 	Cancels the <i>Save As</i> process. This button is greyed out by default and is only activated when Save As function of the side panel is activated.
Save As 	Clears the Agile PLM metadata for the selected object allowing user to assigns new Design and Item objects to the selected components depending the preference settings.. This option activates both the Save and Cancel buttons in the Side Panel of the Save Preview.
Item Number	Shows the Item object number in Agile PLM.
Item Description	Shows the description of the Item object in Agile PLM.
Item Search 	This function allows users to search for existing Item objects in Agile PLM using values entered in the Item Number field. If there is one match, the found Item object ID is written into the Item Number field. If more than one match is found, a dialog pops up displaying all available matches from which the user can select the desired Item object.
Item Autonumber generator 	Automatically creates and assigns a unique and sequential Item Number to the selected object from the (pre)selected Item Number source.

Function/Property	Description
Item Autonumber 	Shows the Item autonumber source to be used for the selected subclass. If there is more than one autonumber source, the list is displayed in alphabetical order.
Item subclass 	Shows the Item subclasses available. User can select the subclass to be used for saving the file to Agile PLM.  Auto-completion is supported based on text entered.
Design Number	Shows the Design object's number in Agile PLM.
Design Description	Shows the description of the Design object in Agile PLM.
File Name	Shows the file name of the Creo Parametric model selected for save.
Design Autonumber generator 	Automatically creates and assigns a unique and sequential Design Number to the selected object from the (pre)selected Design Number source.
Design Autonumber 	Shows the Design autonumber source to be used for the selected subclass. If there is more than one autonumber source, the list is displayed in alphabetical order.
Design subclass 	Shows the Design subclasses available. User can select the subclass to be used for saving the file to Agile PLM.  Auto-completion is supported based on text entered.
Design is a Helperpart	This check box allows users to flag a design object as a Helperpart in Agile PLM. A Helperpart is a Creo Parametric component that is used in the structure but is not part of the finished product. It is represented as a Design but not an Item in Agile PLM Default : False



After making changes to the Details section, always click the **Save** button in this section to apply the changes.

System administrators can configure values allowed for some of the properties such as Number and description. These properties can also be set as **Required**, meaning that you must enter a value before exiting the dialog. See Installation and Administration Guide for more information.



If any attribute value, for example description, in the Creo Parametric system contains unsupported characters as defined in the character set rule of the Agile PLM attribute, the attribute will not be saved or updated in Agile PLM.

Starting from 9.3.6 RUP21, a warning message will be logged in `webservice.log` if the log level sets to **WARN** (Default value is **ERROR**) in `<AgileHome>\agileDomain\config\log.xml`. The warning message will also be returned in web service response.

Starting from MCAD 3.6.4.3, the end users can see the warning message from MCAD client.

Design and Item Properties

These sections contain a list of Design and Item attributes respectively, and their values in tabular form.

The attributes displayed are defined in Agile PLM and can also be set as **Required**, meaning that you must enter a value before exiting the dialog.

You can filter the list of attributes displayed in the Design and Item Properties sections using the following check boxes available in the sections:

- **Mandatory only** - If checked, displays only those attributes set as required in Agile PLM
- **Imported only** - If checked, displays only those attributes mapped via the *Mapping editor*.

See Installation and Administration Guide for more information.



After making changes to the Design and Item sections, always click the **Save** button in the Details section to apply the changes.

Preferences Panel

This section shows the Preferences dialog. See [Preferences Dialog](#) (p. 31) for more information



After making changes to the Preferences Panel, always click the **Save** button within the panel to apply the changes.

Related links

[Workspace Tab](#) (p. 46)

[Agile Save Preview Dialog](#) (p. 15)

2.4.5 Drawing Handling Dialog

In this dialog, you can copy related 2D models simultaneously with 3D models.

The drawing handling dialog is triggered by clicking **Save As** on the Save Preview toolbar if there is at least one 3D Creo Parametric object selected to which the Save As process is applied. It allows users to simultaneously copy related drawings upon copy of the 3D model.

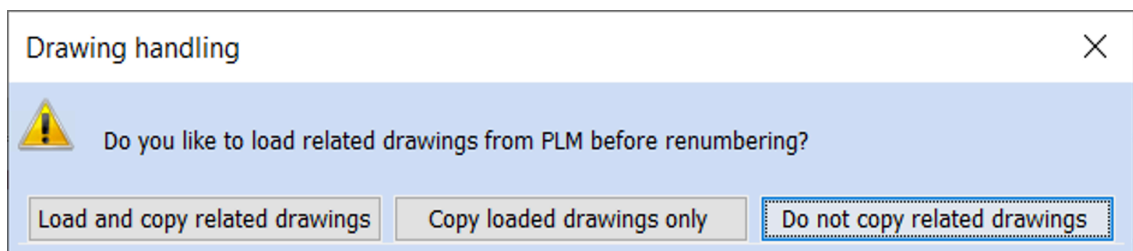

Command	Description
Load and copy related drawings	Triggers a search for all related drawings in Agile PLM and in the local workspace and adds them to the Save Preview dialog. These found objects are displayed as Agile PLMunknown and new Design and Item numbers are then assigned to them.
Copy loaded drawings only	Triggers a search for all related drawings in the local workspace only and adds them to the Save Preview dialog. These found objects are displayed as Agile PLMunknown and new Design and Item numbers are then assigned to them.
Do not copy related drawings	No search is performed for related drawings.

2.5 Load Dialog

In this dialog, you can review the Agile PLM metadata and choose model data to be loaded to the active workspace.

The Agile Load Preview dialog is displayed by the **Load to CAD** command in Agile PLM web client. The Load to CAD command is available in the following locations within the Agile PLM web client:

- in the **More** menu of any search results that include Design and Item objects
- in the **Actions** menu of any Design object
- in the **More** menu of any Item Attachments tab

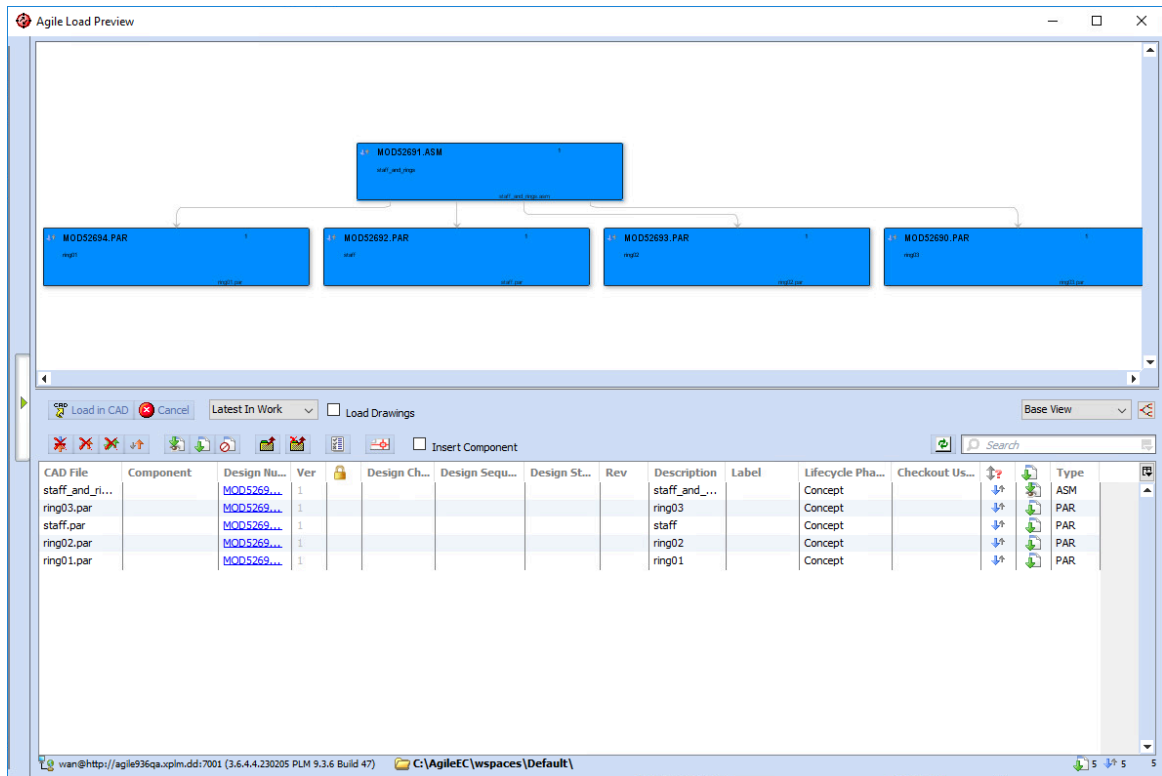

Sections in the load preview dialog:

- Browser/Graph view
- Toolbar
- List View
- Side Panel (collapsible)
- Status line with MCAD version, PLM version, current workspace directory and number and status of available files in the model window

2.5.1 Browser view

This section shows the Creo Parametric model structure information.





The Browser view in this section is similar to that of the Save Preview. See [Browser View](#) (p. 16) for more information.







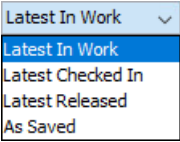





The only difference is in the node color codes. An explanation of the colors available on this dialog is given in the following table



Color	Description
Green	File is newer/modified in the local workspace than in Agile PLM, Load option set to keep local file . Indicates that no Load conflict is present
Orange	File is newer/modified in the local workspace than in Agile PLM, Load option set to overwrite local file . Indicates a load conflict
Blue	File is newer in Agile PLM than on local workspace, Load option set to overwrite local file
Cyan	The file is a <i>PLM where used</i> query result. This color displays in Load Preview and Workspace Manager only.
Dark Grey	File is the same locally and in Agile PLM
Light grey	The Agile PLM information has not been retrieved (LazyLoad) and the file is not modified locally or in Agile PLM.

2.5.2 Toolbar section

This section contains the main functions for loading model data from Agile PLM to the current local workspace.

Command	Function
Load in CAD 	Starts the download process from Agile PLM.
Cancel 	Closes the dialog without further action The dialog can also be closed using the close button (X) in the top right corner.
Structure Resolution 	Defines the Design versions to be retrieved from Agile PLM for loading. The structure resolution displayed on the browser view will be rerun when this option is changed. <ul style="list-style-type: none"> ■ Latest in Work - load the latest version (also checked out version) of a Design object. ■ Latest Checked In - load the latest checked in version of a Design object. ■ Latest Released - load the latest version of a Design object which is attached to a released Item object. ■ As Saved - load the Design version that is linked in the Structure tab in Agile PLM. <p>The default can be defined in the Preferences settings. See Preferences Dialog (p. 31) for more information.</p> <p> If you want to load a past revision, you must execute the load directly from the Design object web form, not from the search results list. That is necessary because you need to be able to select the version of the top Design</p>

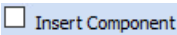
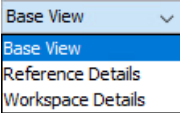
Command	Function
Load drawings <input type="checkbox"/> Load Drawings	If checked, the associated drawings of all structure elements are added to the list of files to be loaded, by looking up the Where Used function of the Designs objects in Agile PLM. The structure resolution will be rerun when this option is checked.
Simplified Reps	If checked, simplified representations are loaded to reduce CAD memory consumption.
Download Wizards	These buttons provide a smart selection logic depending on the file status. <ul style="list-style-type: none"> ▪  - Discard all local changes where a newer version is available in Agile PLM. The newer version is downloaded from Agile PLM ▪  - Discards all local changes and reloads the version from Agile PLM. ▪  - Reload all local files from Agile PLM, even when the file is up to date. ▪  - Keep all local changes.
Download Options	Sets the desired load option for selected components. Determines how the file is loaded from Agile PLM to the local workspace. <ul style="list-style-type: none"> ▪  Download and Open - download the file to the current workspace and open it in Creo Parametric ▪  Download Only - only download the file to the current workspace. ▪  Do not Download - do not download the file <p> These options are automatically set by the system, but you can override the set options using the context menu commands to set your desired download option.</p>
Checkout 	Performs a Check Out in Agile PLM for the selected Design objects.
Cancel Check Out 	Cancels the Check Out for the selected Design objects in Agile PLM.
Preferences 	Opens the Side Panel to display the Preferences Panel . See Preferences Dialog (p. 31) for more information
Open Design Form 	Launches the Agile PLM Web Client and displays the Design object of the selected component.

Command	Function
Insert Component 	Enables the user to insert selected models stored in Agile PLM directly into the currently active structure open in Creo Parametric System administrators can deactivate this option. See Installation and Administration Guide for more information.
Attributes View selector 	The view selector switches the visibility of attribute visible in the list view. <ul style="list-style-type: none"> ■ The Base View shows the main attributes of the model and assigned Design objects. ■ The Reference Details view shows specific information for Parts with external references or part families. ■ The Workspace Details view shows the complete local path directories for all components shown in the Save Preview dialog.
Refresh 	Updates the metadata for all line items from Agile PLM.
Tree View Toggle 	Switches the visibility of the structure browser on and off. By default, the structure view is visible. See Installation and Administration Guide for more information.

2.5.3 List View



This section shows model data with its metadata in tabular form







This section is similar to that of the save preview but instead of save options, there are load options as described in the [Toolbar section](#) (p. 28).

Load Preview Context Menu

The context menu is available on both the Browser and List view. Right click on a node (browser view) or a line item (list view) and you can select additional functions from the context menu.

You can either select one line item or multi-select several items in the list view by either **CTRL**+left-click, or a sequence with **SHIFT**+left-click.

Command	Description
Open in CAD 	Sets the download option download and open for the selected file.
Download File 	Sets the download option download only for the selected file.
Keep Local File 	Sets the download option do not download for the selected file.

Command	Description
Check Out 	Performs a Check Out in Agile PLM for the selected Design objects.
Cancel Check Out 	Cancels the Check Out for the selected Design objects in Agile PLM.
Load Where Used 	Performs a Where Used query in Agile PLM on the selected objects and adds all the referenced objects (like sub-parents, parents, part families, external geometry, and similar) to the load preview. Added objects are highlighted in cyan in the browser view.
Load Drawings 	Performs a Where Used query in Agile PLM on the selected objects and filters related drawings. The resulting drawings are added to the Load Preview and highlighted in cyan.  Do not use this function for drawings that already exist in the local workspace as it may lead to data corruption or reverting of local modifications.
Assembly sub menu 	Performs contained actions recursively for the selected object and all children.
Parents sub menu 	Performs contained actions recursively for the selected object and all its parents.

Related links

[List View](#) (p. 19)

2.6 Preferences Dialog



In this dialog, you can set preferences for save and load options, class default settings, property value preferences, define mapping of Creo Parametric properties to Agile PLM fields among others.



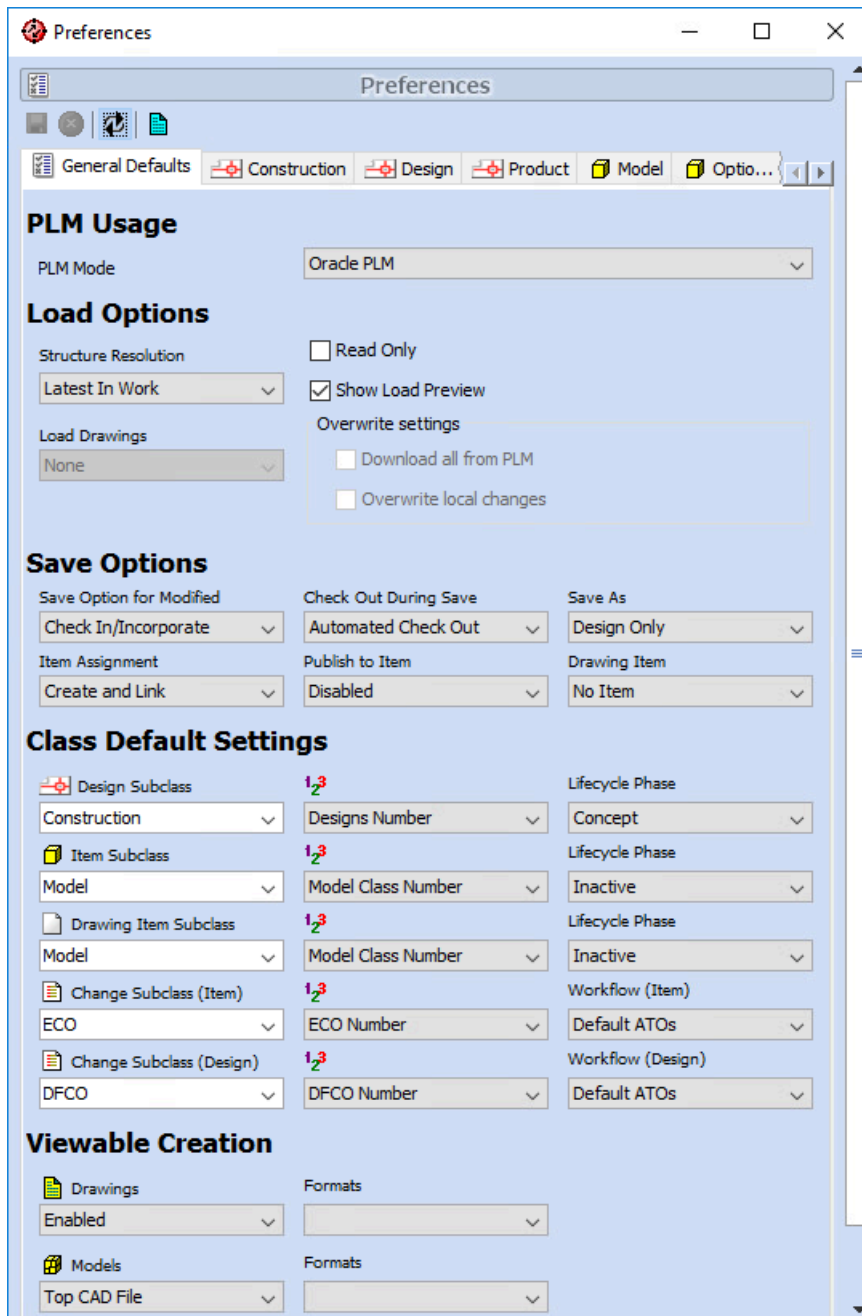

The Preferences dialog can be accessed through

- the integration menu
- the toolbar menu button on Save and Load Previews
- expanding the left side panel of the Save and Load Preview
- expanding the Preferences pane of the Create Object dialog



Preferences toolbar

Command	Description
Save Preferences 	Initiates a save process of the preference settings. It is inactive (greyed out) when no changes are made to the preference dialog. If this button is clicked, a pop-up is displayed where an admin user can apply the changes made to the preference dialog to all users by uploading the changes to the server.
Cancel 	Cancels the changes made to the preference dialog It is inactive (greyed out) when no changes are made to the preference dialog.

Command	Description
Reload Configuration from PLM 	Reloads class definitions from Agile PLM. This function is used when changes have been made to the property value preferences.  This function is only available to users with administrative roles and privileges in Agile PLM. It is deactivated or greyed out for normal MCAD users.
Property Mapping Editor 	Launches the Mapping editor  This function is only available to users with administrative roles and privileges in Agile PLM. It is invisible for normal MCAD users.

The default display of the Preferences dialog is the **General Defaults** which has the following sections;

- PLM Usage
- Load Options
- Save Options
- Class Default Settings
- Viewable Creation

 These options are set by the system administrators and if they are updated, they will be automatically updated for the user on login.

2.6.1 PLM Usage

The PLM Mode drop-down list defines the mode of operation for the MCAD connector.

 This option is only available to users with administrative roles and privileges in Agile PLM.

The options available in the PLM Mode drop-down list are;

Option	Description
Oracle PLM	Normal connector behavior for Agile PLM. This is the default functionality for Agile PLM.
CAD4Cloud	Alternative connector behavior when using Oracle PD Cloud. This mode of operation hides all Item related controls in the MCAD connector GUI and is intended to be used when using the MCAD connector to connect to PD Cloud via an Agile server. Item creation in PD Cloud is then taken over by Agile PLM.  Please refer to <i>Agile PLM CAD for Cloud Integration Guide</i> for more information on this functionality.
Oracle PLM Hybrid Cloud	Works like Oracle PLM mode but uses PD Cloud hyperlinks for the Item related controls of the MCAD connector's GUI instead of Agile PLM hyperlinks.

 The MCAD connector needs to be restarted after changing the **PLM Mode** value

The Fusion URL text field is used to define the URL that points to the PD Cloud service. The MCAD connector uses the URL given in this text field to navigate to Item objects stored in PD Cloud in *CAD4Cloud* and *Hybrid Cloud* modes.

2.6.2 Load Options

The load options define the behaviour of the connector during load operations.

Option	Description
Structure Resolution	<p>Configures the default structure resolution during load. The structure resolution defines which versions of children in design structures are loaded to CAD and used in a parent file.</p> <p>Valid values include:</p> <ul style="list-style-type: none"> ▪ Latest in Work - Select the latest design version of a component in Agile PLM including versions that are currently checked out by the current user. ▪ Latest Checked In - Select the latest Checked In Design version of a component. ▪ Latest Published - Select the latest Design version, with an released Item assignment. ▪ As Saved - Select the Design version that was saved within the parent assembly.
Read Only	<p>It enables read-only mode in the Creo Parametric and the local workspace for files downloaded from Agile PLM.</p> <p>This option works with Strict CAD modification workflow feature.</p>
Show Load Preview	<p>This check box is used to activate and deactivate the Load Preview dialog during load operations.</p> <p>If this option is checked, the load preview is displayed during Load to CAD operations.</p> <p>Default: true (checked)</p>
Load Drawings	<p>This option is only active if Show Load Preview is not checked. It defines the options for loading drawings.</p> <p>Valid options include:</p> <ul style="list-style-type: none"> ▪ None - No additional drawings (except the drawing selected for load in the Web Client) are loaded. ▪ Top-level drawings - loads the drawing(s) assigned to the root element of the structure being loaded if the root element of the structure selected for loading is not a drawing. ▪ All drawings - loads all drawings associated with the structure being loaded

Option	Description
Overwrite settings	<p>The check boxes under this option are only active if Show Load Preview is not checked. It defines the behaviour when there are locally modified files.</p> <p>The options include:</p> <ul style="list-style-type: none"> ▪ Download all from PLM - If this check box is selected, it forces a download of all files from Agile PLM even if some of the files are available locally. ▪ Overwrite local changes - If this check box is selected, changes made locally are overwritten during load from Agile PLM.

2.6.3 Save Options

The Save Options define the behavior during save operations.

Option	Description
Save Option for Modified	<p>This option defines the preselected save option in the Save Preview for locally modified files.</p> <p>Valid options include:</p> <ul style="list-style-type: none"> ▪ Save - Performs a check out of the Design object if necessary and enabled (Check Out During Save is set to Automated Check Out in the Preferences dialog). The Design is then checked in and then checked out again immediately. The Design remains checked out after the save process with an incremented version. ▪ Check In/Incorporate - Performs a check out of the Design object if necessary and enabled (Check Out During Save is set to Automated Check Out in the Preferences dialog). The Design is then checked in. If a pending Design Change is assigned, the Incorporate flag is implicitly set.
Check Out During Save	<p>This options defines the check out behaviour during save.</p> <p>Valid options include:</p> <ul style="list-style-type: none"> ▪ Force User Check Out - You must manually check out the Design to be able to save. ▪ Automated Check Out - The Design is checked out automatically for the current user during save.
Save As	<p>Defines if the connector creates Item objects simultaneously with Design objects during the Initial Save or Save As process.</p> <p>The valid options include:</p> <ul style="list-style-type: none"> ▪ Design Only - Only design objects are created for the CAD files during save. Design AutoNumber is used to assign Design numbers. ▪ Item and design - Design and Item objects are created simultaneously during save. Item AutoNumber is used to assign Design Numbers, appended by the CAD extension.





Option	Description
Item Assignment	<p>This option defines whether Items are created and assigned during save to Agile PLM</p> <p>Valid options include:</p> <ul style="list-style-type: none"> ■ Create and Link - This creates new Item objects during the save process. The Item is linked to the Design and the Item properties are also updated. ■ Update and Link only - This option does not create Items. Existing Items are linked to the Design and the Item properties are updated. The Item object must already exist in Agile PLM. ■ Link Only - This option does not create or update Item objects. Only the relationship link between the items and the designs is created. The Item object must already exist in Agile PLM. ■ Disabled - Item assignment or creation is disabled completely.
Publish to Item	<p>This option controls whether an Item BOM is created or updated in Agile PLM during save. It also determines whether Design files are attached to the Item objects Attachments tab after the design is checked in.</p> <p>Valid options include:</p> <ul style="list-style-type: none"> ■ Disabled - Item BOM is not updated or created and neither are Design files attached. ■ BOM and Attachments - Item BOM is created and updated, and the Design files are attached to the Items. ■ BOM - Item BOM is created and updated. No Design files are attached. ■ Attachments - No Item BOM is updated. However, Design files are attached.
Drawing Item	<p>This option controls whether the Item object of a drawing is linked or created.</p> <p>Valid options include:</p> <ul style="list-style-type: none"> ■ No item - No Item is linked to the drawing Design object. ■ Link to Model Item - No Item is created for the drawing Design object but the drawing Design is linked to the Model Item on the Relationships table in Agile PLM. ■ Separate Item - An Item object is created for the drawing Design object.

2.6.4 Class Default Settings

This section defines the default sub-classes and default AutoNumber sources for all Items, Designs and Change orders created by Creo Parametric integration.

These settings are mainly used in save use cases. It is possible to customize the sub-classes and AutoNumber generators displayed in the Preferences dialog. See Installation and Administration Guide for more information.

The Preferences dialog does not display inactive PLM sub-classes

Option	Description
Design subclass	<p>Defines the Design subclasses available.</p> <p>You can select the subclass to be used if Design objects should be created by the connector.</p> <p> Auto-completion is supported based on text entered.</p>
Design Autonumber	<p>Defines the Design autonumber source to be used for the selected subclass.</p>
Item subclass	<p>Defines the Item subclasses available.</p> <p>You can select the subclass to be used if Item objects should be created by the connector.</p> <p> Auto-completion is supported based on text entered.</p>
Drawing Item Subclass	<p>Defines the Item subclasses available that the connector assigns to drawing Design objects. This is used if different Item subclasses should be assigned to drawings and 3D objects.</p> <p>You can select the subclass to be used if Item objects should be created by the connector.</p> <p> Auto-completion is supported based on text entered.</p>
Item Autonumber	<p>Defines the Item autonumber source to be used for the selected subclass.</p>
Lifecycle Phase	<p>Defines the lifecycle phases available. You can select the lifecycle phase associated with the design and Item objects in Agile PLM.</p>
Change subclass (Item)	<p>Defines the subclasses available for Item Change Orders (ECOs).</p> <p>You can select the subclass to be used if Item Change Orders should be created by the connector.</p> <p> Auto-completion is supported based on text entered.</p>
Change subclass (Design)	<p>Defines the subclasses available for Design Change Orders (DCOs or DFCOs).</p> <p>You can select the subclass to be used if Design Change Orders should be created by the connector.</p> <p> Auto-completion is supported based on text entered.</p>
Workflow	<p>Defines the workflow processes available for Item and Design change orders.</p> <p>You can select the workflow that the integration will assign to Item or Design changes when creating or assigning them.</p>

2.6.5 Viewable Creation

The Viewable Creation defines the types of viewable files that are automatically created and attached in Agile PLM along with the native file.

Viewable files are 2D or 3D interchange file formats that are automatically created and attached in Agile PLM along with the native Creo Parametric file.

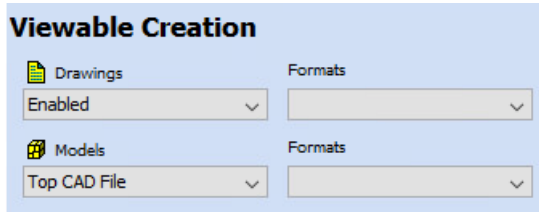

Option	Description
Drawings	<p>Controls viewable generation for 2D files.</p> <p>Valid options include:</p> <ul style="list-style-type: none"> ▪ Enabled - viewables of the selected formats are generated for drawing files. ▪ Disabled - No viewables are generated for drawing files.
Formats	<p>Launches the Value Selection pop up dialog that enables you to select the viewable formats to be created. .</p> <p>Supported 2D viewable formats : PDF , TIF ,PVZ</p>
Models	<p>Controls viewable generation for 3D model files.</p> <p>Valid options are:</p> <ul style="list-style-type: none"> ▪ Top CAD file - viewables of the selected formats are generated only for the top Creo Parametric file in the structure. ▪ Disabled - No viewables files are generated <p> The options can be configured to generate viewables for all files, only assembly files or part files in the structure. See Installation and Administration Guide for more information.</p> <p>Enabling viewable generation for a large 3D structure models can cause a huge load to processes in the Creo Parametric session on Save and have a huge impact on the save performance. It is NOT recommended to enable and set as default for all users.</p>
Formats	<p>Launches the Value Selection pop up dialog that enables you to select the viewable formats to be created. .</p> <p>Supported 3D viewable formats: STEP, EPRT, EASM ,STP , X_T , IGES, ,PVZ</p>

The viewables can be set independently for 2D and 3D files.

The **Formats** combo boxes launches the Value Selection pop up dialog that displays all available viewable formats. The pop-up lets you select the desired formats to be created by highlighting the name of the viewable and using the directional arrows to move it from the **all** box to the **selected** box and vice versa.

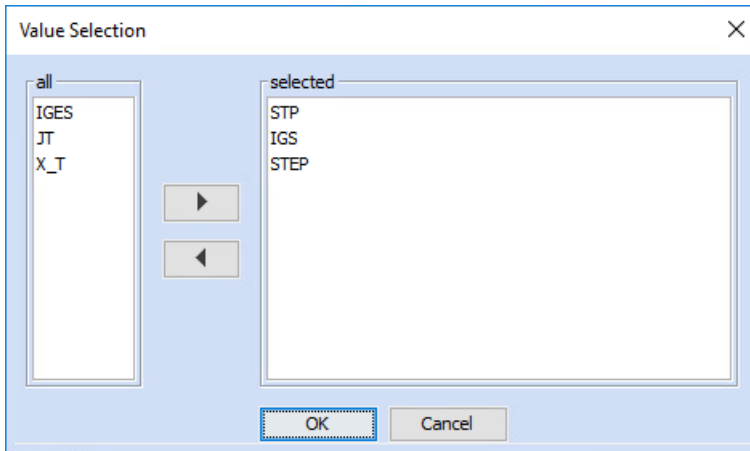

 Additional configuration may be needed to determine the viewable formats generated and whether they are created automatically during save. See Installation and Administration Guide for more information.

2.6.6 Property Value Preferences

This section allows you to pre-define the properties that are mapped between Creo Parametric and Agile PLM, as part of the save process.

Each Design and Item class is represented in the preferences by tabs below the toolbar section which are used to configure the mapping of symbolic CAX properties to fields in Agile PLM.

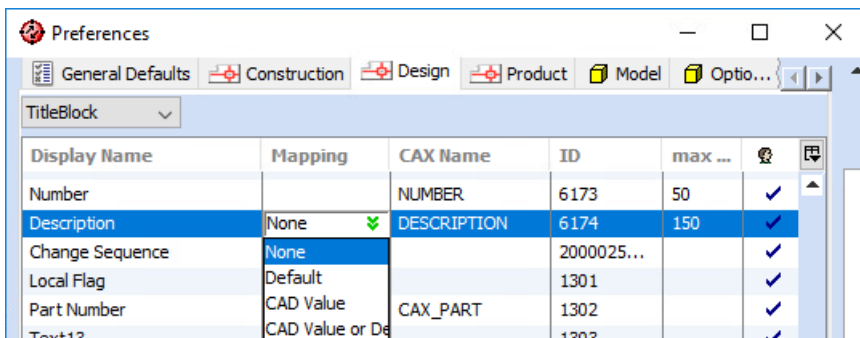

The administrator can setup the mapping interactively. The preferences are saved into a MCAD-CONFIG File Folder object in Agile PLM if the current user is a member of the admin group. The values must be set for each subclass independently. Additionally, each field may get a value default mapping.

By setting these preferences appropriately, you can reduce the use of the interactive save dialog and speed up the save process. The mapping options include;

- **None** - No value is to be set for this property.
- **Default** - Use the value in the Default column.
- **CAD Value** - Use the value defined in the Creo Parametric properties, based upon the mapping defined by your administrator.
- **CAD Value or Default** - Use the value defined in the Creo Parametric properties, but if no value exists, then use the default value in the Default column.

2.6.7 Mapping Editor

In this dialog, you can define mappings of Creo Parametric properties to Agile PLM fields or vice versa during save and property exchange processes.

The Mapping editor is opened by pressing the **Property Mapping Editor** icon (blue page button) on the Preferences dialog.



The button is only visible to user with Administrative roles and privileges in Agile PLM.

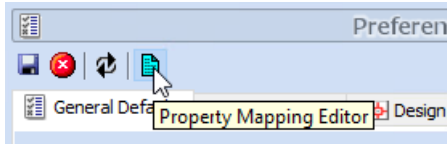

To use or test any new mapping definitions, you must restart the Save Preview. The mapping definition is read on each start of a **Save**, **Update Properties** or **Update Title block** command.

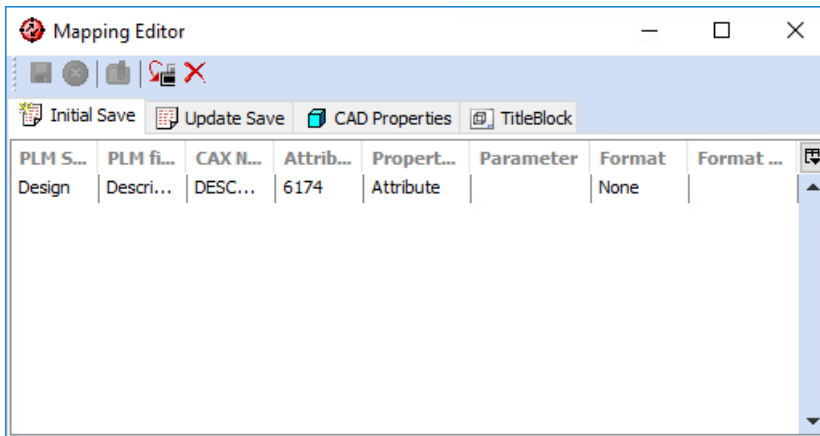



The mapping editor has the following sections;



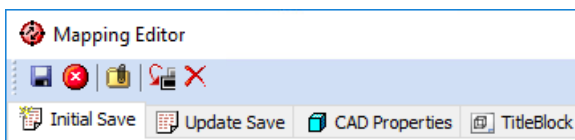

- The toolbar
- Tabs menu
- The list view

Toolbar

The toolbar of the Mapping Editor has the following functionality:



Command	Description
Save 	Saves the mapping definitions  The local save doesn't make the mapping available to all users and is lost if you login to Agile PLM the next time via the connector.

Command	Description
Upload to PLM 	Save and upload the mapping definition to Agile PLM and make it available to all users.  All other client machines must re-login (for example using the Disconnect Session command) to download the updated mapping.
Cancel 	Cancel all changes to the mappings and reread the latest saved mapping.
Insert Mapping 	Add a mapping definition row into the current active mapping tab
Delete Mapping 	Remove a selected mapping definition row in the current active mapping tab

Tabs

The tabs section contains four tabs in which the mappings are defined in tabular form.

Tab	Description
Initial Save	Defines the mapping of Creo Parametric properties to Agile PLM fields during the first save process of Agile PLM unknown files (Initial save process)
Update Save	Defines the mapping of Creo Parametric properties to Agile PLM fields during subsequent save process of Agile PLM known files (update save process)  In Creo Parametric integration, the Update Save tab is also executed for objects that are not yet known to Agile PLM.
CAD Properties	Defines the mappings of Agile PLM fields to Creo Parametric properties.
TitleBlock	Defines the mappings of Agile PLM fields to properties specific to Title Block in drawing files.

List view



This section shows mapping definitions in tabular form. It has two sections

- Column headers
- Row items

The row items correspond to each mapping definition added. See Installation and Administration Guide for more information.

Column Headers

Column	Available in Tab	Description
PLM SuperClass	<ul style="list-style-type: none"> ■ Initial Save ■ Update Save ■ CAD Properties ■ Titleblock 	Switches between the target Agile PLM superclass objects; Design or Item

Column	Available in Tab	Description
PLM Field	<ul style="list-style-type: none"> ■ Initial Save ■ Update Save ■ CAD Properties ■ Titleblock 	Depending on the selected PLM superclass object, the available Agile PLM fields are filtered from the current class configuration. Only visible and editable fields in Agile PLM are available.
Property Name	<ul style="list-style-type: none"> ■ CAD Properties ■ Titleblock 	The name of the target Creo Parametric property. This could be a Creo Parametric file attribute or Creo Parametric property or configuration-specific property
CAX Name	<ul style="list-style-type: none"> ■ Initial Save ■ Update Save ■ CAD Properties ■ Titleblock 	Displays additional information about the PLM Field selected.  This column is read only in the initial and update save tabs.
Attribute ID	<ul style="list-style-type: none"> ■ Initial Save ■ Update Save 	Displays additional information about the PLM Field selected.  This column is read only
Property Type	<ul style="list-style-type: none"> ■ Initial Save ■ Update Save 	This column lets you select from Creo Parametric internal integration parameters and from Creo Parametric properties.
Parameter	<ul style="list-style-type: none"> ■ Initial Save ■ Update Save 	You can specify a Creo Parametric property name in this column.  A parameter with the given name is searched in the configuration specific properties first. If there is no configuration specific property with that name, the standard or custom properties of the file are scanned.
Format	<ul style="list-style-type: none"> ■ Initial Save ■ Update Save ■ CAD Properties ■ Titleblock 	Provide basic formatting options for values mapped between Creo Parametric and Agile PLM and vice versa.
Format Parameter	<ul style="list-style-type: none"> ■ Initial Save ■ Update Save ■ CAD Properties ■ Titleblock 	Provide parameters for the Format column

See Installation and Administration Guide for more information.

2.7 Workspace Browser

This dialog displays files available locally on disk or open in Creo Parametric and their related Agile PLM metadata.

The Agile Workspace dialog is displayed by the **Agile > Workspace Manager** command within the integration menu.

The workspace dialog has two main tabs:

- CAD tab

- Workspace tab

2.7.1 CAD Tab

This section displays the Agile PLM structure of the current Creo Parametric file in session.

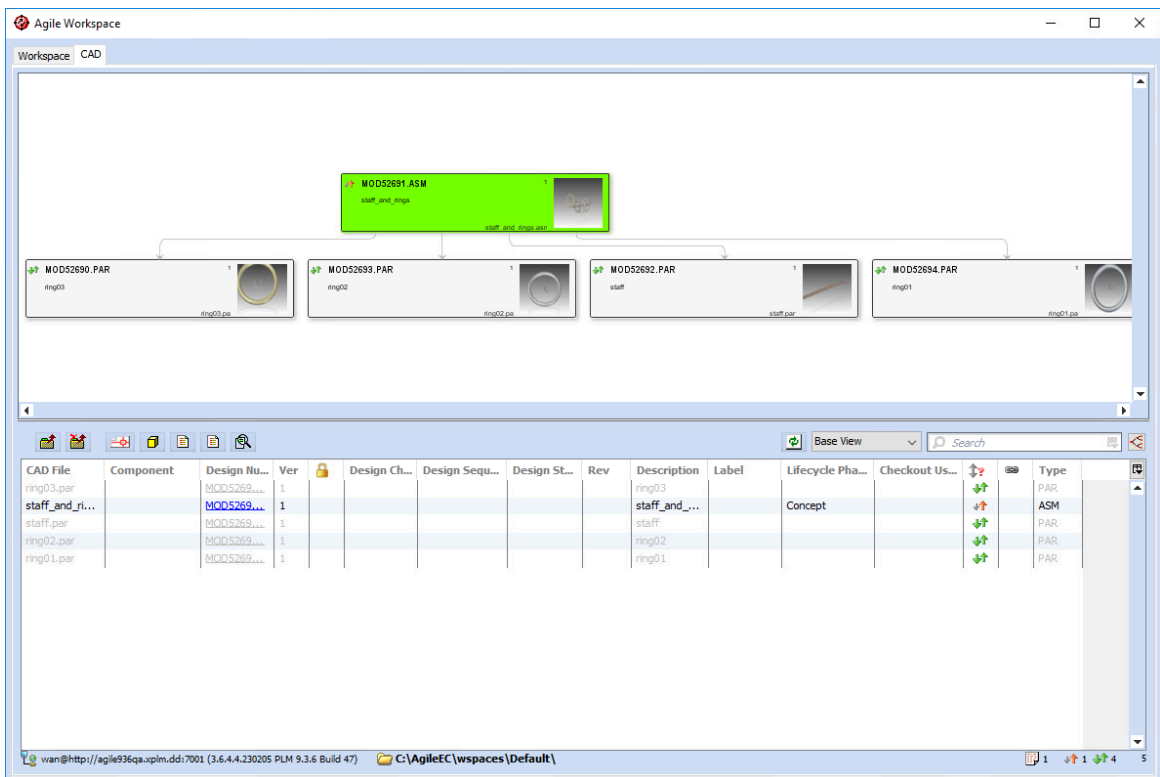

 To improve performance, the Workspace Manager can be configured to open with empty CAD tab. See Installation and Administration Guide for more information.

Sections in the CAD tab:

- Browser view
- Toolbar
- List view
- Status line with MCAD version, PLM version, current workspace directory and number and status of available files in the model window

Browser view

The Browser view in this section is similar to that of the save preview. See [Browser View](#) (p. 16) for more information.









The only difference is in the node color codes. An explanation of the colors available on this dialog is given in the following table

Color	Description
Green	The file is selected for saving meaning the Save Option column is not empty. Note that Save Option column is only available in the Save Preview window. This only shows what the Save Preview would display if it were open. Green overrides Red
Light Grey	The PLM information has not been retrieved (LazyLoad) and the file is not modified locally or in PLM.
Dark Grey	File is the same locally and in PLM. No Save option is selected

Color	Description
Cyan	The file is a <i>PLM where used</i> query result. This color displays in Load Preview and Workspace Manager only.
Dark Blue	The file was modified in PLM. The local version is out of date.
Red	A newer version is available in PLM, but the file is modified locally

Toolbar

This section contains the main functions for managing model data in Agile PLM.

Function	Description
Check Out 	Performs a Check Out in Agile PLM for the selected Design objects.
Cancel Checkout 	Cancels the Check Out for the selected Design objects in Agile PLM.
Open form for Design 	Launches the Agile PLM Web Client and displays the Design Object of the selected component.
Open form for Item 	Launches the Agile PLM Web Client and displays the Item Object (if it exists) of the selected component.
Open form for Item Change 	Launches the Agile PLM Web Client and displays the Item Change Order (if it exists) assigned to the Item object of the selected component.
Open form for Design Change 	Launches the Agile PLM Web Client and displays the Design Change Order (if it exists) assigned to the Design object of the selected component.
Autovue 	Opens the AutoVue applet.
Refresh 	If model data is already saved, updates the metadata for all line items from Agile PLM.
Tree view Toggle 	Switches the visibility of the browser/graph view on and off. By default, the browser view is visible. See Installation and Administration Guide for more information.

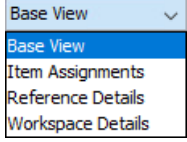







Function	Description
<p>Attributes View selector</p> 	<p>The view selector switches the visibility of attribute columns visible in the list view.</p> <ul style="list-style-type: none"> ■ The Base View shows the main attributes of the model and assigned Design objects. ■ The Item Assignments view shows additional information about the Item assignment and the Item attributes. ■ The Reference Details view shows specific information for parts with external references or part families. ■ The Workspace Details view shows the complete local path directories for all components shown in the Save Preview dialog.

List View

The list view in this section is similar to that of the save preview but without the save options. See [List View](#) (p. 19) for more information.

CAD Tab Context Menu

The context menu is available on both the Browser and List view. Right click on a node (Browser view) or a line item (List view) and you can select additional functions from the context menu.

Command	Description
<p>Update with Structure</p> 	<p>Starts the Load Preview from PLM to reload an assembly to the local disk</p>
<p>Checkout</p> 	<p>Performs a Check Out in Agile PLM for the selected Design objects.</p>
<p>Cancel Checkout</p> 	<p>Cancels the Check Out for the selected Design objects in Agile PLM.</p>
<p>Load Where Used</p> 	<p>Performs a Where Used query in Agile PLM on the selected objects and adds all the referenced objects to the dialog.</p> <p>Added objects are highlighted in cyan within the Browser view.</p>
<p>Assign Change</p> 	<p>Opens a pop up dialog that allows users to assign Design and Item Change Orders to the selected objects.</p>
<p>Assembly sub menu</p> 	<p>Performs contained actions recursively for the selected object and all children.</p>
<p>Parents sub menu</p> 	<p>Performs contained actions recursively for the selected object and all its parents.</p>
<p>Graph view sub menu</p> 	<p>Provides different ways to show the selected objects and their children in the browser view.</p>

Related links

[Agile Save Preview Dialog](#) (p. 15)

2.7.2 Workspace Tab

This tab displays information about files in the local workspace the workspace directory structure. It shows both Creo Parametric and Agile PLM related information.

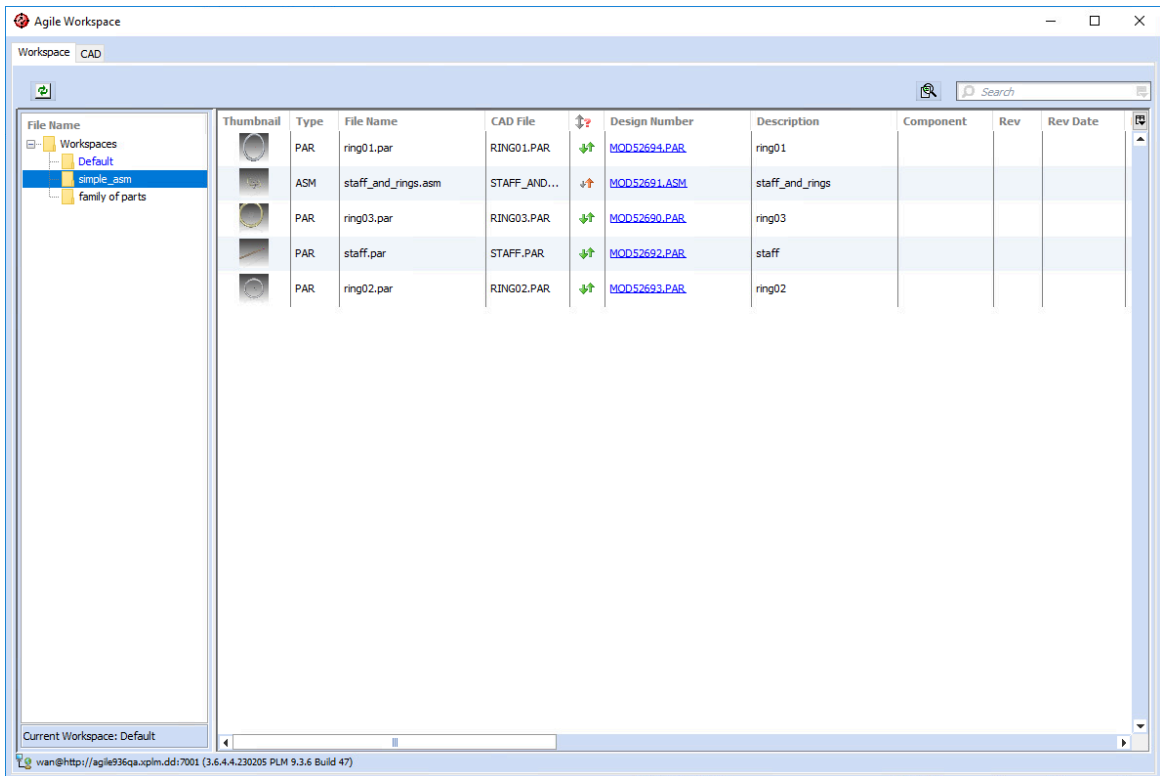

The workspace tab has two main sections

- Workspace view
- List view

The workspace tab also has a limited toolbar section that only contains three command functions;

Command	Description
Refresh	Updates the metadata for all line items from Agile PLM.
Autovue	Opens the AutoVue applet.

Command	Description
Search	<p>The search field is used to filter the elements displayed in the list view using user-given criteria. This search criteria is based on the properties given in the column headers.</p> <p>You can select or change the search criterion by clicking on the arrow icon on the right-hand side of the search text field and checking the desired attribute to be used. The default search criterion can be configured by system administrators. See Installation and Administration Guide for more information.</p> <p> You can only use a single search criterion. Multiple search criteria are not supported.</p>

Workspace View

This section shows the current workspace and the workspace directory structure. The default workspace set by the connector is `C:\AgileEC\wspaces\`

The Workspace pane enables you to create or select Workspaces, which correspond to folders on your local disk. You can expand or collapse the workspace directory structure by clicking the plus (+) or minus (-) signs beside the folder label.

Context Menu

Right click on the workspace label to bring up the context menu

Command	Description
Refresh Workspace	Updates the metadata information from Agile PLM for all items in the selected workspace.
Create Workspace	<p>Launches a pop-up dialog that allows creation of a new workspace folder. The new workspace folder is created as a subfolder below the selected folder and automatically set as the current workspace (highlighted in blue font).</p> <p> The Creo Parametric connector does not support Asian characters in the workspace name. It is recommended to use only ASCII characters.</p>
Remove Viewables	This function is used to delete viewables stored locally in the selected workspace

Command	Description
Zip and Upload Workspace	<p>This function is used to compress the complete selected workspace, including all files and subdirectories. The zipped file is uploaded to a design object in Agile PLM named with the Design AutoNumber defined in the <code>WorkspaceFolderAutoNumber</code> option setting in the CaxConfig.xml file. The created folder is linked to the bookmarks of the current login user.</p> <p>The zipped file also contains the Agile PLM cache information and can be used to save or transfer complete workspaces, including all Creo Parametric files and Agile PLM related information.</p> <p> It is recommended to extract the complete workspace to a new empty target workspace.</p>
Change Workspace	<p>This function is used to set the workspace to be used for load, save or object creation. The current active workspace is highlighted in blue font text and also shown at the bottom of the Workspace pane.</p>







 It is possible to extend the workspace view context menu to add additional functions. See Installation and Administration Guide for more information.





List View

This section shows model data with its metadata in tabular form. Sections in the list view include:

- Column headers
- Row items

Column headers

Column	Description
Thumbnail	Shows the Creo Parametric thumbnail if available in the Creo Parametric file.
Type	Shows the Creo Parametric file extension.
File Name	Local Creo Parametric file name.
CAD File	Shows the file name of the Creo Parametric model.
File Status 	<p>Shows the status of the local file. Possible values are:</p> <ul style="list-style-type: none"> ■  - The file does not exist in Agile PLM. ■  - The local file is up to date with Agile PLM. ■  - The file is modified locally and is known in Agile PLM. ■  - The file is known in Agile PLM and was modified by someone else in Agile PLM. ■  - A newer version is available in Agile PLM, but the file is modified locally. ■  - Unknown synchronization status. Agile PLM ID exists, but the cache information is missing.

Column	Description
Design Number	Shows the Design object Number in Agile PLM.
Description	Shows the description of the Design object in Agile PLM.
Component	Shows the component type of the Design object in Agile PLM.
Rev	Shows the revision of the Design object in Agile PLM.
Rev Date	The date of the last Design revision
Label	Is simply the Label attribute in Agile PLM
Version	Shows the version of the Design object in Agile PLM.
Is Incorporated 	Shows the incorporate status of the assigned Design Change Order. This column is blank if no design change is assigned. <ul style="list-style-type: none">  - The file is not incorporated on the Design Change. Saving with save option Check In/Incorporate implicitly incorporates the file.  - The file is incorporated on the Design Change, but the Change is not released.  - The file is incorporated on a Design Change, that is released.
Design Change	Shows the Design Change Order Number assigned to the selected Design object. This column is blank if no Design change is assigned.
Design Status	Shows the status of the related Design Change Order. This column is blank if no Design Change is assigned.
Local Version	Corresponding Agile PLM Version of the local file
Checkout User	Shows the user who has checked out the object in Agile PLM.
Checkout Date	The date of the current checkout, if any.
last modified	The date of local modification of the file, if any.
Item Number	Shows the Item object Number in Agile PLM.
Rev	Current revision of the Item in Agile PLM. Parentheses indicate a pending revision.
Path	Full path information of the file
Size	Local file size

You can select or deselect column headers to be displayed in this section by expanding the drop down list on the right hand side after the last column. The attributes visible in this list are also configurable. See Installation and Administration Guide for more information.









You can also move Columns around to arrange them in your preferred order.







Row Items

Model data is shown per row item in the different columns.

You can either select one line item or multi-select several items by either **CTRL**+left-mouse-click, or a sequence with **SHIFT**+left-mouse-click.

Workspace Tab Context menu

Command	Description
Open Form 	Launches the Agile PLM Web Client and displays the Design object of the selected component.
Open 	Opens and displays the selected object in Creo Parametric from the local workspace
Update with Structure 	Starts the Load Preview from PLM to reload an assembly to the local disk
Copy Files 	Copies all selected files to a virtual clipboard, note that this is not the system clipboard.
Cut Files 	Copies all selected files to a virtual clipboard. The selected files can then be removed from their original directory and moved to another directory using the Paste Files function. If Paste Files is not executed, the selected files remain visible.
Paste Files 	Inserts the files from the virtual clipboard to the workspace directory on which the Paste Files function is executed. If the files were sent to the clipboard with the Cut Files function, they are removed from their original directory and the clipboard. They, however, remain in place and on the clipboard if the Copy Files function was used. If there are files with similar file names in the destination directory the user is promoted to overwrite them. If the user denies, then the previously selected files are not removed even if the Cut Files function was used on them. Pasting files does not work if the files to be processed are removed from the source directory before the Paste Files function is used.





Command	Description
Delete Files 	Deletes selected files from the current workspace directory if the files are currently not open in Creo Parametric with a confirmation dialog.  Even though deletion of files that are in session does not cause any problems in Creo Parametric, deletion is prevented to avoid problems in the integration cache. However, this behaviour can be configured. See Installation and Administration Guide for more information.
Check Out 	Performs a Check Out in Agile PLM for the selected Design objects.
Cancel Check Out 	Cancels the Check Out for the selected Design objects in Agile PLM.
Save 	Assigns the save option Save to the selected objects.
Check In/Incorporate 	Sets all selected objects to be saved and checked in.
Assign Change 	Opens a dialog that allows users to assign Design and Item change orders to the selected objects.
PLM Structure	Switch to the CAD tab and show the structure information from Agile PLM for the selected file.
PLM Where Used	Switch to the CAD tab and show the parents information from Agile PLM for the selected file. The Design structure where used and the Design relationships table in Agile PLM is scanned for Objects referencing the current file. The found parents are highlighted in cyan in the browser view.
Show Children Files	This function highlights all child objects of the currently selected Creo Parametric file in the Workspace tab regardless of the actual version of these files
Show Parent Files	This function highlights all parent objects of the currently selected Creo Parametric file in the Workspace tab regardless of the actual version of these files

2.8 Assign Change Dialog

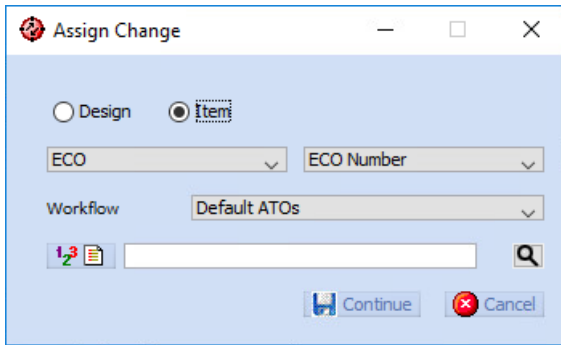
In this dialog, you can create and assign Design and Item Change Orders.

The Assign Change dialog is opened by context menu command **Assign Change** available in the Save Preview and Workspace Manager.



Option	Description
Design and Item radio buttons	Selects if a Design or Item change order is assigned to the selected objects.
Combo boxes	Depending on the radio button selected, you can use the combo boxes drop-down lists to select the Change subclass and Change Order autonumber generator source to be used to create the desired Change Order.
Workflow combo box	You can define the Workflow to be applied to the Change Order. The workflow selected on this dialog overwrites the default selection on the Preferences dialog.
Autonumber generator	Automatically creates and assigns a unique and sequential Change Order Number to the selected object from the (pre)selected Autonumber source. See Installation and Administration Guide for more information.
Current Change Order	This text field displays the current Change Order Number.
Search 	<p>This function allows users to search for existing Change Orders in Agile PLM using values entered in the Current Change Number field. A search with wild-card (*) is supported</p> <p>If there is one match, the found Change Order object ID is written into the Current Change Number field. If more than one match is found, a Select Change dialog pops up displaying all available matches from which you can select the desired Change Order.</p> <p> If only existing Change numbers are allowed in the system, the connector can be configured to discard non-existing numbers. See Installation and Administration Guide for more information.</p>
Continue 	<p>Initiates the process to assign the selected Change Order.</p> <p> You must click Continue for the change order to be assigned to the selected Design/Item object(s).</p>
Cancel 	<p>Closes the dialog without further action</p> <p>The dialog can also be closed using the close button (X) in the top right corner.</p>

3 Usage

3.1 Starting the Integration

The Creo Parametric connector for Agile PLM is operated directly from Creo Parametric.

If the integration is installed, a shortcut of the startup script is added to desktop. With this shortcut the Agile PLM integration can be started together with Creo Parametric.

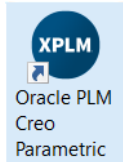

Note To use Engineering Collaboration (EC), you must have a user account in Agile PLM.

When EC is enabled, you see an **Agile** menu in the ribbon bar within your Creo Parametric system . Access to EC functions is through this ribbon bar.

3.2 Create New Object from Template

The integration helps you to create new objects simultaneously in Creo Parametric and Agile PLM.

Before you start

Verify that a valid template is available in Agile PLM. See Installation and Administration Guide for more information.

About this task

This use case describes how to create a new object using the **Agile Create Object** dialog

Procedure

1. Press **Agile > Create**

→ Agile Create Object dialog opens

2. Select a template to use from the **Template File** combo box

3. Select a design subclass from the **Design subclass** combo box

4. **Optional:** Select an Item subclass from the **Item subclass** combo box

5. **Optional:** Assign an Item Number by pressing the **Item autonumber generator** or by manually entering a number into the item Number text filed.



Depending on the Preference settings, assigning an Item Number might automatically generate a Design Number.

6. Select the **Design Autonumber** source to be used.



You can also use the Design Autonumber automatically selected after selecting the Design subclass.

7. Assign a Design Number by pressing the **Design autonumber generator** or by manually entering a number into the Design Number text filed.

8. **Optional:** In the **Workspace Pane**, select the folder into which the new object should be stored on the local disk.

9. Press **New Object** button.

Result

A new object is created in Agile PLM and opened in Creo Parametric. The selected template file is copied to the selected workspace directory on the local machine and opened in Creo Parametric. A corresponding Design object in Agile PLM is also created simultaneously.

Related links

[Create Object Dialog](#) (p. 12)

3.3 Save to Agile PLM

3.3.1 Saving to Agile PLM via Save Preview

The integration helps you save model data consistently from Creo Parametric to Agile PLM.

Before you start

Launch Creo Parametric and create or open a model that is NOT known in Agile PLM.

About this task

This use case describes how to save new and modified Creo Parametric files to Agile PLM via the **Save Preview**

Procedure

1. Press **Agile > Save Preview**

→ Save Preview dialog opens. All files are selected for saving. Column *CAD File* is automatically filled with object name from Creo Parametric. Columns with Agile PLM related information are not filled.

2. Assign Design and Item numbers by selecting all files in the list view (CTRL + A) and clicking **Save As** and **Create Items** buttons respectively.

3. Optional: Open the Side Panel of the Save Preview by double clicking on the corresponding node in the Browser view or row in the list view and add values for Design and Item attributes. These values are mapped to corresponding fields in Agile PLM during save process.

- a) Add value to Item and Design Description fields
- b) Add values to desired Design attributes in the Design Properties table.
- c) Add values to desired Item attributes in the Item Properties table.
- d) Click **Save** in the Side Panel



If there are any required attributes that do not contain a value, an error message will be displayed stating that '*Some required attributes are empty!*' with a list of the required attributes given in the error description.

4. Optional: Set the **Save Option** by selecting all objects in the list view and using the Context menu commands. Otherwise, the default option set in the Preference dialog is automatically assigned.

5. Press **Continue** button.



When saving for the first time, Design and Item AutoNumbers are assigned automatically to each model depending on the related preferences setting after clicking **Continue** if they were not previously assigned.

→ Save process starts and finishes without errors. Files and information are uploaded to Agile PLM.



Save process will be cancelled with error report if duplicate Design numbers are found by the save call.

6. Return to Creo Parametric and modify an object
7. Press **Agile > Save Preview**
 - Save Preview dialog opens. Modified files are preselected for saving. Agile PLM related information for example Design Number, Item Number, Lifecycle Phase and so on are displayed for all files. Furthermore, the *Save Preview* provides information about Check Out status and corresponding user.
8. Press **Continue** button.



To prevent saving incomplete structures to Agile PLM, you should make sure that a referencing Creo Parametric object (i.e., a Creo Parametric object containing a structure) displayed as locally modified by the integration is always saved to Agile PLM alongside all its child objects which are displayed as either new or locally modified by the integration. You should not reset the save option of the child objects in this case, since this would cause a referenced Creo Parametric object from not being saved to Agile PLM.

Result

Save process starts and finishes without errors. Files and information are uploaded to Agile PLM.

Related links

[Preferences Dialog](#) (p. 31)

[Agile Save Preview Dialog](#) (p. 15)

3.3.2 Assigning an Existing Design Object

The integration supports assigning a Design object that already exists in Agile PLM to a Creo Parametric model using the Side panel of the Save Preview..

Before you start

Make sure you have a Design object that already exists in Agile PLM. Note the Design Number.

Launch Creo Parametric, create or open a model. The object can be known or unknown in Agile PLM.



The model open in Creo Parametric must be of the same file type as the file attached to the Design Object in Agile PLM.

About this task

This use case describes how to assign a Design number that is already assigned to a different Design object in Agile PLM using Side panel of the Save Preview.

You can also assign a Design number that is already assigned to a different Design object in Agile PLM during object creation using the Create Dialog.

You can search for and assign Design objects of different subclasses from those set in Preferences dialog.



If the Design object in Agile PLM does not contain the file extension of the corresponding Creo Parametric file, the connector will not create a new Design object. The existing Design will be assigned.

Procedure

1. Press **Agile > Save Preview**
 - Save Preview dialog opens.
2. Double click on the object in the list or browser view.
 - The Side Panel of the Save Preview is displayed (left side)

3. **Optional:** Click **Save As** in the Details Panel.

→ The fields in the Details Pane are activated (editable).

4. In the Details section of the Side panel, enter the number of an existing Design object into the **Design Number** text field, then click on any other field within the section so that the Design Number text field loses keyboard focus.



The Design Number text field is not case sensitive and the check is performed by removing focus from the text field.

→ A confirmation dialog appears warning you that the Design already exists and requesting confirmation to use the existing design.

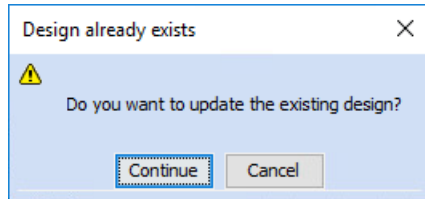

5. Click **Continue** to confirm that the already existing Design Number should be assigned to the model



Click **Cancel** to terminate the Design assignment process.

→ The Design Number is visible in the Details panel Design Number Text field.

6. **Important:** Click **Save** in the Details panel.

→ Design Number becomes visible in the Browser and List view of the Save Preview

7. Click **Continue** in the Save Preview

Result

The Creo Parametric file is uploaded to the incremented version of the Design Object in Agile PLM (Verify in the **Files** tab of the Design Object).

3.4 Load to Creo Parametric

3.4.1 Loading from Agile PLM

The integration helps you load Design objects from Agile PLM to the local workspace and optionally open them in Creo Parametric.

Before you start

Verify that you have a valid design object in Agile PLM not reserved by another user.

Creo Parametric is running and you are connected to Agile PLM.

Activate the option setting **Show Load Preview** on the Preference dialog by selecting the check box.

About this task

This use case describes how to load a design object to Creo Parametric using the Load Preview.

Procedure

1. In Agile PLM Web Client, navigate to the desired Design object and select **Actions > Load to CAD**

→ Load Preview dialog opens. The list view is filled with corresponding Agile PLM and Creo Parametric related information.



If the Load preview is not activated, the load process will be directly initiated.

2. **Optional:** Set the desired load options.
3. **Optional:** Check Out the files using the context menu or toolbar command.
4. Click **Load in CAD**.

Result

The native files of the Design object are downloaded from Agile PLM and opened in Creo Parametric depending on the load options selected.

If files were checked out, the downloaded objects are reserved for the current user in Agile PLM.



During Load To CAD property update from Agile PLM to Creo Parametric is performed for Creo Parametric files which are checked out for the current user with the exception of Standard Parts.

Related links

- [Preferences Dialog](#) (p. 31)
- [Load Dialog](#) (p. 27)
- [Property Mapping](#) (p. 59)

3.4.2 Lazy Load Feature

The lazy load feature controls the visibility of Agile PLM information on the Load Preview

If Lazy Load is **activated**, Agile PLM information such as Design and Item change on the Load Preview is only retrieved from Agile PLM and displayed on user request (click the object to initiate the process).

If it is **de-activated**, all Agile PLM information for all objects visible in the Load Preview is retrieved and displayed as soon as Load Preview appears on screen. Thus, activated Lazy Load may shorten onset times especially for many Agile PLM-known Creo Parametric objects.



This feature can be activated or deactivated as desired. See Installation and Administration Guide for more information.

3.5 Access Control Management

3.5.1 Check Out and Cancel Check Out

Check Out and **Cancel Check Out** functions are available in several locations of the integration:

- the integration main menu
- the Save Preview
- the Load Preview
- the Workspace Manager
- CAD feature tree context menu

You can Check out or Cancel Checkout on a single object or the entire object structure.

Verifying the Check Out Status

You can verify the checkout status of an object using the Workspace Manager, Save Preview, Load Preview, Quick View and PLM information side pane of the integration. Those dialogs display the **Checkout User** attribute. Thus, if an object is checked out, the attribute would display the corresponding user-name.

Unsuccessful Check Outs

In the event that you cannot check out an object in Agile PLM (for example, due to another user having already checked out the object in Agile PLM or the Design is already incorporated on a DFCO), an error message will be displayed warning you of the conflict.

3.5.2 Concurrent Engineering

The XPLM connector is specifically designed to support concurrent engineering, the ability for multiple designers to work on different portions of the same overall Creo Parametric assembly at the same time.

The most important consideration for concurrent engineering is that the ongoing changes by the designers be managed such that the files in the central repository (Agile PLM) remain valid and up to date.

The connector makes use of two basic control mechanisms to manage concurrent engineering:

- **Check out** - a reservation mechanism inside Agile PLM that is used to prevent other users from saving changes to something you are changing.
- **Time stamp** - is a mechanism that relies on a time stamp value stored on each Design object in Agile PLM each time you save. If your time stamp is up to date, meaning that no one has made a change more recently than when you loaded the file, then you can save into Agile PLM.

The preference setting **Check Out During Save** determines how check out and version mechanisms are used to control concurrent engineering.



It is recommended to use the option **Force User Checkout** to ensure that users are aware when other users are working on models. Users are also recommended to Check Out Designs as early as possible either when loading to Creo Parametric from Agile PLM or using the Workspace Manager during Creo Parametric design modifications.

Related links

[Save Options](#) (p. 35)

3.5.3 Strict CAD Modification Workflow

Since release 3.6, the Creo Parametric integration supports a strict CAD modification workflow based on Agile PLM checkout status.

If this feature is enabled, you are restricted from modifying Agile PLM known objects unless you have checked out the objects in Agile PLM. See Installation and Administration Guide for more information.



This feature also preselects all checked out files by the user for check in during save.

If activated, you are only allowed to modify Agile PLM managed Creo Parametric objects if you have checked out that object in Agile PLM. If not, the connector implicitly switches to the Creo Parametric systems read-only mode, preventing you from using modification features and/or preventing saving the file altogether.

Whenever you attempt to use a feature that would modify the Creo Parametric data that is not checked out in Agile PLM for example, modify or locally save a modified file, the following Checkout Status dialog is displayed. The dialog allows you to directly attempt to check out the object in question.

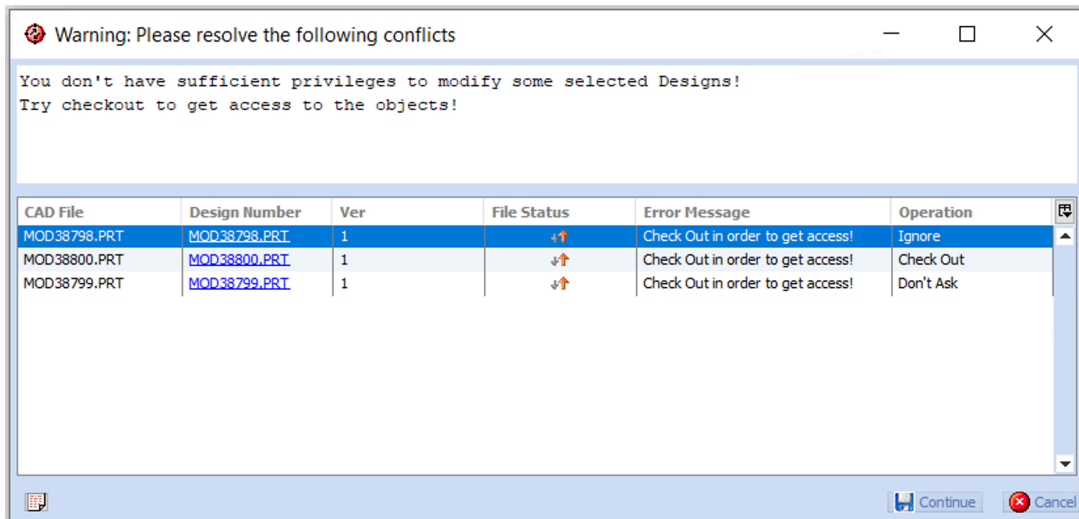

The dialog gives users three operational options: **Ignore**, **Check Out** or **Don't Ask**.

Update Properties function also display conflicts when Strict CAD modification Workflow feature is activated with a list of files for which the property update could not be executed given.

3.6 Property exchange

Properties (also known as parameters, attributes, or metadata) are information stored as text strings that are associated with Creo Parametric and Agile PLM data. The connector supports bi-directional transfer of properties between Creo Parametric and Agile PLM.

3.6.1 Property Mapping

The connector supports mapping of properties to and from Agile PLM and Creo Parametric.

Property mapping supports the following types of Agile PLM attributes:

- Text
- MultiText
- List
- MultiList

When mapping from Creo Parametric to Agile PLM, there are two types of properties that can be mapped:

- **System properties** - are not directly defined by the user such as the file name and the Creo Parametric software version number which can be saved as properties in Agile PLM.
- **User properties** - are defined by the user using the Creo Parametric custom file properties

System properties and user properties are mapped into Agile PLM Designs and Item objects as part of the Save process.



Mapping in the MCAD connectors is always case sensitive, even in cases where CAD file properties are not case sensitive in the CAD systems.

Mapping from Agile PLM into Creo Parametric is done using the **Update Properties** command. It can also be configured to occur automatically during the Save process. Both design and item properties can be mapped into Creo Parametric.

When working with drawings, the **Update Title Block** command is used to map Agile PLM properties into Creo Parametric. This updates properties just for the current drawing, not all subordinate models. To use properties within a Title Block, you need to define the text notes to be linked to properties, either within the drawing or within the part or assembly referenced on the drawing. This is standard Creo Parametric functionality.

3.6.2 Update properties

The integration helps you map properties from Agile PLM to Creo Parametric.

Before you start

Prepare a model file with three level structure in Creo Parametric.

Creo Parametric is running and you are connected to Agile PLM.

About this task

This use case describes how to map description attribute from Agile PLM to Creo Parametric using the **Update Properties** functions for **current**, **first level** and **all levels**.



Only users with Administrator Roles (Roles with Admin in the name attribute of the role) in Agile PLM can set up mapping.

Procedure

1. Open the prepared model in Creo Parametric.
→ Creo Parametric displays the test model.
2. Save the test model and its complete structure to Agile PLM via the Save Preview.
→ Model file is successfully saved to Agile PLM and Design version 1 is created for all files.
3. Click **Agile > Preferences** on the integration menu.
→ The Preference dialog is opened.
4. On the Preference dialog, click **Property Mapping Editor** icon
→ The Mapping Editor is opened.
5. In the **TitleBlockTab**;
 - a) Click **Insert Mapping** icon
→ A row is added to the list view. The column **PLM Superclass** and **Format** are automatically filled with values **Design** and **None** respectively.
 If these fields are not pre-filled, you can also set a value from the drop-down lists therein.
 - b) Click in the text field under **Property Name** and enter a value such as *TEST_DESCRIPTION*.
 - c) Open the drop-down list under **PLM field** column and select **Description** from the list.
→ The column **CAX Name** will be automatically filled with the value **DESCRIPTION**
 - d) Click **Save** within the mapping editor.
→ Mapping has been set up.
6. Close both the Mapping Editor and Preference dialog.



Step 3 to 6 are performed by users with Admin roles in Agile PLM

7. Click **Agile > Show Agile Form** from the integration menu.
→ The Agile PLM web client is opened displaying the Design object of the root assembly in version 1.
8. In the Agile PLM web client, change the description attribute value of the root assembly's Design object to a unique value. Then do the same for all child elements in the structure
→ Description attribute in Agile PLM has been changed for all Design objects in the structure.
9. Return to Creo Parametric and click **Agile > Current**
→ A progress bar may be displayed for a very short time, otherwise nothing discernible happens.
10. Open the Creo Parametric file properties of the root assembly
→ A property named *TEST_DESCRIPTION* has been added with the unique value defined in step 8. This property does not exist in the Creo Parametric file properties of all the child elements.
11. Return to Creo Parametric and click **Agile > First Level**
→ A progress bar may be displayed for a very short time, otherwise nothing discernible happens.
12. Open the Creo Parametric file properties of the second level child elements of the test assembly.
→ A property named *TEST_DESCRIPTION* has been added with the unique value defined in step 8. This property does not exist in the Creo Parametric file properties of all the child elements in the third level or deeper.
13. Return to Creo Parametric and click **Agile > All Levels**
→ A progress bar may be displayed for a very short time, otherwise nothing discernible happens.
14. Open the Creo Parametric file properties of the third level child elements of the test assembly.
→ A property named *TEST_DESCRIPTION* has been added with the unique value defined in step 8.

Result

Properties have been successfully mapped from Agile PLM to Creo Parametric.

Related links

[Saving to Agile PLM via Save Preview](#) (p. 54)

3.7 Material and BOM management

3.7.1 Assigning Items

The connector provides several ways for assigning Item objects to a Design

Automatic Item Assignment

You can assign Items automatically during the Save process depending on the Preferences dialog settings. The Items will be assigned automatically during the Initial save to Agile PLM . Items will be created regardless of what save option is used. See Installation and Administration Guide for more information.

Assigning a New Item

You can assign Items manually using the **Create Items** and **Save As** button on the Save Preview toolbar or by entering or creating an Item Number in the Details Panel in the Side Panel.

Assigning an Item to an object that already has an Item assignment

Item assignments can get exchanged by entering or creating an **Item Number** in the Details Panel in the Side Bar. The change needs to be confirmed.

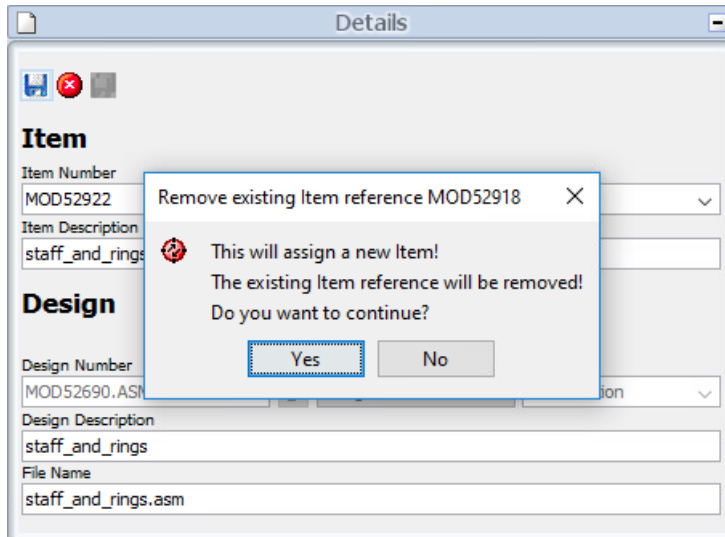

You must press the **Save** button in the Side Panel to apply the changes.

Deleting an Item assignment

To remove an Item Assignment, open the Design object's Context menu in the Save Preview and select the option **Delete Item Assignment**

Related links

[Agile Save Preview Dialog](#) (p. 15)

3.7.2 Assigning an Existing Item Object

The integration supports assigning an Item object that already exists in Agile PLM using the Side panel of the Save Preview..

Before you start

Create an Item Object in Agile PLM via the web client and keep a note of the Item number.

Launch Creo Parametric, create or open a model. The object can be known or unknown in Agile PLM.

About this task

This use case describes how to assign an existing Item object in Agile PLM using Side panel of the Save Preview.

You can search for and assign Item objects of different subclasses from those set in Preferences dialog.

Procedure

1. Press **Agile > Save Preview**
 - Save Preview dialog opens.
2. Double click on the object in the list or browser view.
 - The Side Panel of the Save Preview is displayed (left side)

- In the Details section of the Side panel, enter the number of an existing Item object into the **Item Number** text field, then click on any other field within the section so that the Item Number text field loses keyboard focus.



The check is performed by removing focus from the Item Number text field.

- A confirmation dialog appears warning you that the Item already exists and requesting confirmation to use the existing Item

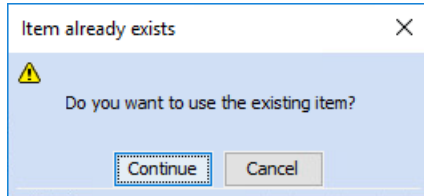

- Click **Continue** to confirm that the already existing Item should be assigned



Click **Cancel** to terminate the Item assignment process.

- Another confirmation dialog appears requesting that you define what property values should govern the Item assignment process

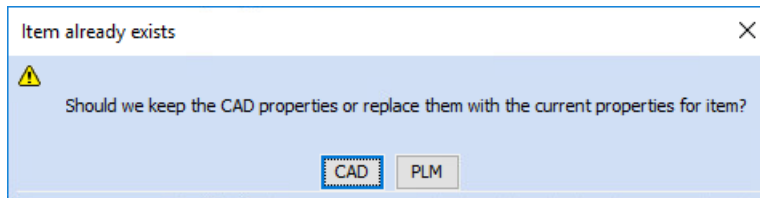

- Option:** Select the **CAD** option if the property values currently stored by the connector (Details panel and Item Properties table) should be written to the newly assigned Item



Note that the pop-up dialogs mentioned above do not execute the actual assignment of the Item in question if the **CAD** option is selected in the pop-up dialog mentioned above

- Option:** Select the **PLM** option if the property values currently stored by the connector (Details panel and Item Properties table) should be discarded and the values of the corresponding Agile PLM attributes of the newly assigned Item should be used instead.

- If the **PLM** option is selected, a third pop up message is displayed asking you to confirm the removal of the existing Item reference

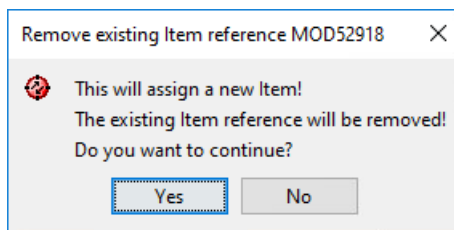

- Option:** Select **Yes** to continue with the new Item assignment.



This will overwrite the local data with the Agile PLM Item attributes. This process cannot be reversed.

- Option:** Select **No** to restore the old Item assignment.

- Important:** Click **Save** in the Details panel.

- Click **Continue** in the Save Preview

Result

Item object is assigned and changes saved to Agile PLM.



The *Item already exists* pop up prompts can be deactivated to improve performance. See Installation and Administration Guide for more information.

Related links

[Side Panel](#) (p. 24)

3.7.3 BOM publishing

BOM Publishing is used to create or update Agile PLM BOM tables based on Creo Parametric Design structures.

The preference setting **Publish to Item** determines whether an Item BOM is created or updated in Agile PLM during save.

The connector's BOM publishing process has three main steps;

- 1. Save** - This step saves the Design structure into Agile PLM, using the **Agile > Save** command.
- 2. Assign Items** - This step links each Design object to a corresponding Item object. This linking is done based on the type of mapping defined in your EC environment. The linking operation is accomplished using the Agile PLM **Relationships tab**, and the link applies across all Design versions and Item revisions.
- 3. Publish BOM** - This step creates or updates the BOM structure for all the assigned Items, based on the corresponding Design structure. Additionally, it attaches specific Design file types to the Item object's **Attachments tab**, as configured by your administrator.



The BOM publishing process can be managed within only one save process depending on the Preferences settings for the Publish and Item creation behavior.

If necessary, manual BOM edits can be made using the normal Redline BOM capability in Agile PLM. Manual BOM edits are tracked independently and do not change upon subsequent BOM publish updates.

Related links

[Save Options](#) (p. 35)

3.8 Workspace Management

The integration uses a local working directory to store Creo Parametric files. The connector synchronizes these local files with Agile PLM. You can have multiple workspaces in parallel in order to separate the local data, for example when working on different projects at the same time.



It is recommended to maintain all workspaces under the EC workspace directory.

3.8.1 CAD working directory vs. EC Workspaces

The Creo Parametric working directory and the EC workspaces are different and lead to different behavior of the integration.

The **working directory** is the active directory in the Creo Parametric system, where the engineer is working. This directory is not necessarily the same directory where the Creo Parametric files loaded in session are located, because after load the working directory may be changed, or some components are loaded from external library paths.

The **EC workspace** is a managed directory of the Creo Parametric integration that can be displayed in the Workspace Manager. EC workspaces are in a dedicated local area on disk defined by the environment setting `CAX_WORKSPACE_ROOT`. All directories below this root can be displayed in the EC Workspace Manager. External directories outside this root are not displayed, but the connector tracks the file status of any file independent from the path where it resides.



It is recommended to have both the working directory and the EC workspace, share the same folder location. This can be done using the **Change Workspace** context menu command in the Workspace Manager. This also sets the current working directory in Creo Parametric respectively to the same value.



Manually changing the current working directory in Creo Parametric does not change the EC workspace

3.8.2 Workspaces on Save

This is the local directory to which files are stored during the save process.

To keep assembly integrity, the location of files on disk is not changed during save. Only completely new files not stored on disk are saved into the active EC workspace.



Setting the current working directory in Creo Parametric has NO effect on where the new files are saved locally. Set the EC workspace to control where new files are stored during save to Agile.

If the current working directory in Creo Parametric does not match the active EC workspace, a warning dialog is displayed. You can then decide whether to continue creating objects in the EC workspace folder or abort the save process and reset the EC workspace and the Creo Parametric working directory.

You can select the target workspace during save to Agile PLM using the **Change Workspace** or create a new workspace using the **Create Workspace** context menu command in the side panel of the Save Preview.



Changing the active workspace in the Save Preview does NOT reset the Creo Parametric working directory. If you intend to change both at once, use the Agile Workspace Manager before saving.

You can see the current selected workspace at the bottom of the Save Preview dialog on the Status line.

If the Creo Parametric files are renamed during initial save and the file location is changed, the original file is retained.



Viewables are generated in the active workspace of the Creo Parametric file

Related links

[Agile Save Preview Dialog](#) (p. 15)

[Workspace Tab](#) (p. 46)

3.8.3 Workspace on Load

This is the local directory to which files are loaded from Agile PLM.

On load from Agile PLM, the target workspace can be selected using the **Change Workspace** context menu command in the Workspace Manager or in the sidebar of the Load preview. You can also create a new workspace in which to load using the **Create Workspace** command.

When you change the current workspace, the file status checks are executed, and the display is refreshed. Both commands also set the current working directory in Creo Parametric.



The current selected workspace can be seen at the bottom of the Load Preview dialog.

Related links[Load Dialog](#) (p. 27)

3.8.4 Workspace on CAD start

The last workspace is stored in the `connect.properties` file in users AgileCache directory. During startup Creo Parametric scans this file for the workspace and sets the Creo Parametric working directory to the last workspace used.

3.8.5 Files in the Workspace Tab

The Workspace tab of the Workspace Manager displays only model file types in the List view.

For files that have a version number in file name suffix, the version number is not displayed in the Workspace Manager. For example *Part.prt.1* will be displayed as *Part.prt*. Additionally, if the file has multiple versions, it will only be displayed once in the Workspace Manager.

Viewable files types are not displayed on the Workspace Manager.

Related links[Workspace Tab](#) (p. 46)[Supported file types](#) (p. 8)

3.8.6 Collaboration files

Collaboration files (.CLB files) are files that contain meta information of Creo Parametric files managed by Agile PLM.



Collaboration files are automatically created by the integration and used to link a Creo Parametric file to its corresponding Agile PLM object. A .CLB file always has the same file name as its source file, along with the file extension **.CLB**.

Whenever a file is saved or downloaded from Agile PLM, using the integration, a new collaboration file is created and saved in the same directory as the transferred file. If a collaboration file is deleted, the link between the file on the local workstation and the corresponding object in Agile PLM is broken. Due to this breakage, the integration cannot update the Agile PLM object any longer and treats the source file as unknown to Agile PLM, thus creates a new Agile PLM object when the source file is saved again.

3.9 Change control

3.9.1 Design File Release Process

The integration allows you to create and assign Design File Change Orders via the Assign Change dialog.



Since MCAD version 3.5, the Design File Release Process of Agile PLM is supported by the MCAD connector. For details regarding this process, refer to the documentation of Agile PLM: [What's New in Agile Product Lifecycle Management \(E61170-01\), chapter 2, "Design File Release Process"](#).

Incorporating Design Objects

The **Check In/Incorporate** save option of the MCAD connector implicitly incorporates a file of a Design object if it has a pending Design Change Order (DFCO) assigned. If no DFCO is assigned, this save option only performs a save with check in to the Design object, to which it is applied.



Un-incorporate actions can only be performed via the Web Client, not via the MCAD connector

3.9.2 Assign a New Change Order

The integration helps you to create and assign Design File and Item Change Orders via the Assign Change dialog available in the Save Preview dialog and Workspace Manager .



Before you start

Creo Parametric is running and you are connected to Agile PLM.

About this task

This use case describes how to create and assign a new Design File Change Order (DFCO) or Item Change Order (ECO) using the Assign Change dialog via the Save Preview dialog.

Procedure

1. Open a Creo Parametric model and save it to Agile PLM.
 - Creo Parametric model has associated Design object in Agile PLM.
2. Press **Agile > Save Preview**
 - Save Preview opens.
3. In the Save Preview dialog, highlight the file, right click and select **Assign Change** from the context menu.
 - Assign Change dialog is opened.
4. On the Assign Change dialog, select the **Design** radio button to assign a DFCO or the **Item** radio button to assign an ECO.
 - The Assign Change dialog is updated with content corresponding to the button selected.
5. **Optional:** Select the **Change Type** and Change Order autonumber generator source to be used from the respective combo boxes.
6. **Optional:** Select the desired **Workflow** to be applied to the Change Order from drop-down list.
 -  Changes MUST have an assigned workflow status to work with the connector!
7. Click the **Autonumber generator** to create a unique identifier for the Change Order.
 - A unique identifier is created for the Change Order and the number is entered in **Current Change Order** text field.
 -  You can also manually enter the Change Order Number but only according to your company's allowed numbering scheme. If you enter the wrong number, a warning message will be displayed informing you that *No Change (in a valid state) with such a Number was found!* See Installation and Administration Guide for more information.
8. Click **Continue** on the Assign Change dialog.

Result

A new Change Order is created and assigned to the Design object of the Creo Parametric model. The Change Order ID and all metadata related to the Change Order are displayed on the Save Preview in the respective fields.

Related links

[Assign Change Dialog](#) (p. 51)

[Saving to Agile PLM via Save Preview](#) (p. 54)

3.9.3 Assign An Existing Change Order

The integration helps you assign a Design File or Item Change Orders that already exists in Agile PLM using the Assign Change dialog.

Before you start

Create new a Design File Change order (DFCO) or Item Change Order (ECO) in Agile PLM via the web client or ensure one exists and keep note of the number.

About this task

This use case describes how to query and assign a Change Order (CO) using the Assign Change dialog via the Save Preview dialog.

Procedure

1. Open a Creo Parametric model and save it to Agile PLM.
→ Creo Parametric model has associated design object in Agile PLM.
2. Press **Agile > Save Preview**
→ Save Preview opens.
3. In the Save Preview dialog, highlight the file, right click and select **Assign Change** from the context menu.
→ Assign Change dialog is opened.
4. On the Assign Change dialog, select the **Design** radio button to assign a DFCO or the **Item** radio button to assign an ECO.
→ The Assign Change dialog is updated with content corresponding to the button selected.
5. At this point, you have two options for assigning the Change Order:
 - a) **Direct Input method** In the **Current Change Order** text field, enter the known Change Order number noted from the preconditions above. Clicking the **Search** button in this case does nothing or a progress dialog may be shown for a very short time. Proceed to step 6.
 - b) **Query and Select method** In the **Current Change Order** text field, enter at least two characters of the Change Order followed by a wild card (for example *DFCO**) then click the **Search** button.
→ **Select Change** pop-up dialog is opened displaying a list of all query matches found in Agile PLM.

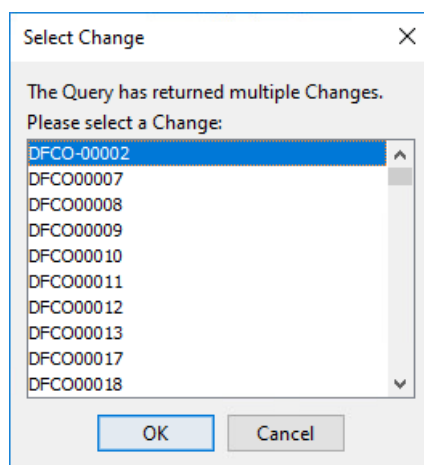

c) In the Select Change pop-up dialog, select the appropriate Change Order from the list and click **OK**. Proceed to step 6.

→ The Select Change dialog is closed and the complete Change Order number is entered in the **Current Change Order** text field.



You can only query for Change Orders with **Unassigned, Pending, Submit** or **Hold** status. **Released** Change orders cannot be queried or assigned.

6. Click **Continue** on the Assign Change dialog.

Result

The Change Order is assigned to the Design object of the Creo Parametric model. The Change Order ID and all metadata related to the Change Order are displayed on the Save Preview in the respective fields.

Related links

[Assign Change Dialog](#) (p. 51)

[Saving to Agile PLM via Save Preview](#) (p. 54)

3.10 Creo Parametric specific functionality

3.10.1 Thumbnail support

The connector extracts thumbnails from the Creo Parametric native file.

The Creo Parametric system stores thumbnail views into the Creo Parametric binary data that are extracted using the same routines used by Windows Explorer.

The connector does not generate the thumbnail content but retrieves it from Creo Parametric files. Please refer to the documentation of your Creo Parametric tool on how to enable thumbnail generation in the Creo Parametric files.

The thumbnails are only held locally and are shown inside the Workspace Manager in small icons. A bigger fly-out is shown on the small icon, on a node in the browser views or on the file name columns in the table views. In the Load Preview the thumbnail from Agile PLM is downloaded if no local thumbnail is available. In all other dialogs, only thumbnails generated locally are used.



Since release 3.6.4, you can configure the size of the thumbnails in Agile PLM. See Installation and Administration Guide for more information..



If the thumbnail size is reconfigured, thumbnail folders must be deleted for the changes to take effect. For example , delete `C:\AgileEC\spaces\Default\.thumbnails`, otherwise the connector reuses the cached thumbnails.

3.10.2 Handling of Family Tables

The Creo Parametric connector contains specialized functionality to manage Family Tables

Recognizing Family Tables

In all main EC Connector dialogs – Save Preview, Load Preview and Workspace manager, additional columns in the list view display the Family Tables information in the **CAD Model Type** and **Part Family** columns. If no Family Tables files are contained within the current Creo Parametric model, then the extra columns are not even displayed.



If no Family Tables are contained within the current Creo Parametric model, then the columns are not automatically displayed in the **Reference Details View** of the Save and Load Preview.

The relationship between generic and instances is highlighted in the browser view of the EC connector dialogs with **green dashed** lines and special end nodes. The **CAD Model Type** icons are also shown within the nodes themselves.

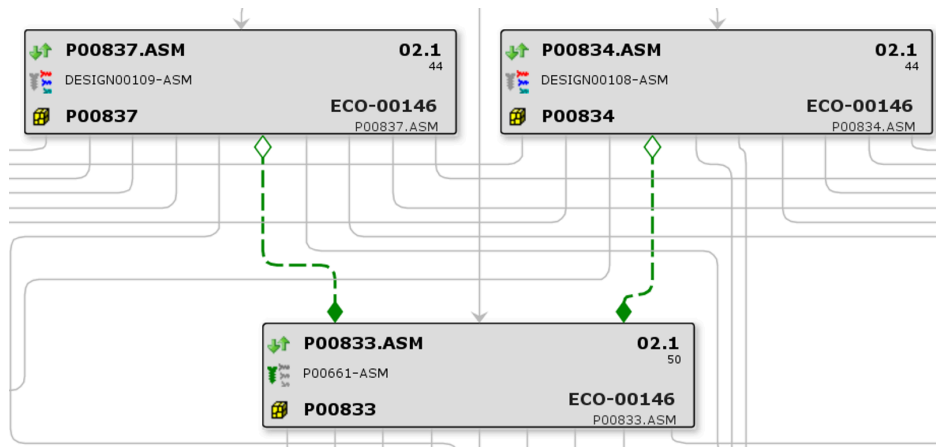

Family Tables information is also displayed on the Agile PLM Web Client in **Model Type** and **Model Reference** attribute fields. These fields can be used to query for instances or generic objects.

Selecting Family Tables Models

The selection between the generic and the instances is transparent within the EC dialogs.

- If the generic is **selected**, all instances in session are also **selected**.
- If a generic is **deselected**, all instances are also **deselected**.
- If an instance is **selected**, the related generic is also **selected**.
- If an instance is **deselected**, the related generic is **NOT deselected**.

Saving Family Tables

The integration menu command **Save Family Table** allows you to save or update all the Family Tables files to Agile PLM at once.

This command brings up the Save Preview dialog containing the generic and all instances of a Family Tables model. To use this function, you must have the generic model or assembly active in your Creo Parametric session.

This command also validates each instance and prompts you if there is an error with any of the instances. If there are any errors, an error pop-up message is displayed that allows you to view the log file of errors (which is also stored in your log directory for further access). If you choose to continue, the Save Preview dialog will only contain the properly validated instances.

Numbering of Family Tables

By default, the EC connector treats Family Tables as regular files, so each part gets a unique design number assigned in Agile PLM. The numbers do not have to match between the generic and the instances from the Agile PLM point of view.

Optionally, the design number of instances can be derived from the generic design number by adding a suffix. See Installation and Administration Guide for more information.



The instance Design Number cannot exceed 50 characters and should not contain any special characters.

Related links[Agile menu](#) (p. 9)[List View](#) (p. 19)[Browser View](#) (p. 16)

3.10.3 Handling External References

The Creo Parametric connector provides additional functionality within the connector to display and manage external reference information.

Recognizing Models with External References

In all main EC Connector dialogs – Save Preview, Load Preview and Workspace manager, additional columns in the list view display the External Reference information in the **Link Type** and **Link Reference** columns. If no external references are contained within the current Creo Parametric model, the extra columns are empty.

The information shown in these columns is also shown in the form of each object in the MCAD connector. You can use these attributes to perform searches, for example on merge reference parts.

External reference information is also displayed on the Agile PLM Web Client in **Link Type** and **Link Reference** attribute fields. These fields can be used to query for such objects for example merge reference parts.

Creo Parametric contains specialized functionality to manage external references such as copy geometry, publish geometry, merge/inheritance and shrink-wrap.

External references stored in Agile PLM are fully supported in the Load process. The Load commands check out the additional files. For automated loading of the reference files in the Creo Parametric session you must set the following two `config.pro` options;

- `RETRIEVE_MERGE_REF_PARTS YES`
- `RETRIEVE_DATA_SHARING_REF_PARTS YES`

See Installation and Administration Guide for more information.

Related links[Agile menu](#) (p. 9)

3.10.4 Handling Suppressed Components

The Creo Parametric connector is extended to handle suppressed components when saving.

Before saving the connector scans the structure of the current object and detects suppressed components. If suppressed components are found, an information dialog is shown listing all suppressed components.

If a suppressed component is found in Agile PLM, it is not shown in the Save Preview. If a suppressed component is not found in Agile PLM and it is in session, it is shown in the Save Preview and handled like an active component.



Components not found in Agile PLM and not in session, cannot be handled!

Suppressed components with associated Agile PLM Design objects are built into the Design structure with a special **Identifier** - `CAX-PROE-SUP` and **Component** information `SUPPRESSED`.



Suppressed components are NOT BOM relevant and therefore are filtered from the Item BOM in Agile PLM during publish.

3.10.5 Mapping Find Numbers to Agile PLM BOM

The integration allows you to map BOM Find Numbers to Agile PLM Item BOM. This feature is only available within the drawing context of Creo Parametric.

BOM find numbers are numbers assigned to BOM components in a BOM table visible in a Creo Parametric drawing.

You can transfer Find Numbers from Creo Parametric drawing BOM table to Agile PLM BOM table using the **Transfer BOM Find Number** function available in the Agile menu.



For Creo Parametric connector, this menu option has to be configured to be visible. Additionally, to use the function, you need to select a suitable BOM table in the Creo Parametric drawing from which the Find Numbers will be populated. See Installation and Administration Guide for more information.

The Find Numbers are available in the Agile PLM Web Client within the **Find Num** column under the **BOM** tab.



It is only possible to transfer the Find Number from Creo Parametric to Agile PLM not the other way round.

Find numbers cannot be transferred only by using a save function. The following restrictions apply:

- The Creo Parametric drawing must be known to Agile PLM.
- The BOM which is updated with the find numbers is the BOM displayed in the **BOM** tab of the drawing's model. This is the BOM tab, which is updated by the **Publish to Item** function.

If you have a drawing with the corresponding BOM, and you have saved it to Agile PLM with a Design (and Item) number. The Item number is optional for the drawing model. However, if the corresponding assembly file does not have an Item assignment, the MCAD connector will implicitly create and assign an Item object to the assembly's Design object (find numbers are transferred to the BOM tab of the corresponding assembly Item).

You can manually change the find numbers of each component in the BOM table of the Creo Parametric drawing and then transfer the changes to Agile PLM by clicking **Agile > Transfer BOM Find Number**.



When you make a change, ensure that there is no space around the number entered, because the Agile PLM Web Client will not read this data correctly.

3.10.5.1 Using Agile Find Numbers in Creo Parametric

Agile PLM **Find Numbers** can be used in Creo Parametric Drawings for BOM Balloons.

Find Numbers must be first entered manually within the Item BOM in Agile PLM. Once they are created, they can be accessed from Creo Parametric using either of these two options;

- Manually created balloons using the parameter `&AGILE_FIND_NO:att_cmp`.
- Automated balloons using Report Parameter `asm.mbr.cparam.AGILE_FIND_NO` in a repeat region.

To use duplicate **Find Numbers** See Installation and Administration Guide for more information.

3.10.6 Handling Simplified Representations

The Creo Parametric connector is extended to handle components suppressed by a simplified representation.

The handling of components suppressed by a simplified representation is like the handling of suppressed components. However, the information dialog shows the current simplified representation in addition.

If a component suppressed by a simplified representation is found in Agile PLM, it is not shown in the Save Preview. If a component suppressed by a simplified representation is not found in Agile PLM and it is in session, it is shown in the Save Preview and handled like an active component.



Components suppressed by a simplified representation not found in Agile PLM and not in session, cannot be handled!

Components suppressed by a simplified representation with associated Agile PLM Design objects are built into the Design structure with a special **Identifier** - *CAX-PROE* and **Component** information *SIMP_REP_SUPPRESSED*.



Components suppressed by a simplified representation are BOM relevant are therefore added to the BOM table in Agile PLM.

3.10.7 File Sync status Mismatch

The Creo Parametric connector has two different file change recognition functionalities implemented.

While the Workspace Manager only uses the **dot version** of the Creo Parametric files, the Save Preview window uses the **dot version** and the internal file modification flag provided by Creo Parametric to detect changes to files.

If there are modifications made to a Creo Parametric file and you have not saved the changes locally, the Save Preview and the Workspace Manager may display different sync status for that file. Saving the changes made to the Creo Parametric file locally will resolve the issue.

3.10.8 Intermediate Data Format (IDF) Import

Intermediate Data Format (IDF) is a data exchange format for ECAD and MCAD applications. Since release 3.6, the Creo Parametric connector supports the IDF import feature.

When importing IDF data, Creo Parametric creates the corresponding native geometry files (.PRT, .ASM) based on the IDF geometry definitions.



Make sure that the geometry files have the same file name as the IDF files from which they were created but NOT the same file ending. Otherwise, the connector will save the IDF files (.EMN, .EMP) to Agile PLM as viewables together with the geometry files (.PRT, .ASM).

3.10.9 Handling of Standard Parts

The Creo Parametric connector provides additional functionality to manage Standard Parts.



This feature was introduced in release 3.6.4.6 of the Creo Parametric connector.

The Creo Parametric connector takes care of saving and loading the Standard parts to and from Agile PLM. To optimize the work flow, the behavior regarding Standard Parts is different compared to other components:

- Standard Parts are NOT implicitly pre-selected for saving to Agile PLM.
- Standard Parts cannot be renamed either during save (RenameOnSave) or load (RenameOnLoad) operations
- No viewables are created for Standard Parts if viewable creation is activated during Save
- Agile PLM properties are not written to Standard Parts.

Saving Standard Parts

You can save Standard Parts to Agile PLM with normal save functions.

The Standard Parts are saved to Design objects with Unique Design Number in Agile PLM.

Standard Parts are flagged on the Agile PLM Web Client with *TOOLBOX* value in the **Design.PageTwo.Name Format** attribute.

Once saved to Agile PLM and thus Agile PLM-known, Standard Parts are not affected by the MCAD connector's **Save As** function. This means, that no new Design number is assigned to them in case that they are selected and the **Save As** button is clicked.

Loading Standard Parts

Standard parts are loaded the same way as any other Creo Parametric files.

Standard Parts are displayed in the Workspace Manager and have .CLB files assigned to them. Standard parts loaded to the active workspace do not cause any conflicts related to the separate Toolbox Library outside of the workspace that might exist, since both Creo Parametric files (the standard part file in the active workspace and the standard part file in the Toolbox Library) link to the same Design object in Agile PLM.



Creo Parametric does not have a default Toolbox Library available, but you can create a Toolbox library to store Standard parts.

Renaming

Standard parts never get renamed by the Creo Parametric connector

Viewables

Viewables are not created for Standard parts. Regardless of the viewable related option settings selected in the Preferences dialog.

Standard Parts Without Collaboration Files

When saving Standard Parts to Agile PLM, the MCAD connector queries the Agile PLM system for the file name of the Standard Part. If the query returns a result, the MCAD connector re-assigns the corresponding Design object to the Standard Part in question. This way, Standard Part that had been saved to Agile PLM before can be linked to their Design objects even without having a .CLB file assigned.

This functionality also allows several users that utilize the same set of Standard Parts (but not on a shared location, like a network drive) to work with Standard Parts without having to worry about conflicts regarding the concurrent usage of those files.