

# Oracle Identity Manager Integration Implementation Guide

Oracle Banking Corporate Lending

Release 14.7.4.0.0

Part No. F98076-01

[May] [2024]



---

# Table of Contents

<b>1. INTRODUCTION .....</b>	<b>1-2</b>
1.1 SCOPE .....	1-2
1.2 INTRODUCTION TO ORACLE IDENTITY MANAGER .....	1-2
1.3 ADVANTAGE.....	1-2
<b>2. REQUIREMENTS / PROBLEM STATEMENT .....</b>	<b>2-1</b>
<b>3. PREREQUISITES.....</b>	<b>3-1</b>
3.1 SOFTWARE REQUIRED.....	3-1
3.2 FLEXCUBE COMPONENT REQUIRED .....	3-2
<b>4. SYSTEM DESCRIPTION .....</b>	<b>4-1</b>
4.1 ABOUT ORACLE IDENTITY MANAGER .....	4-1
4.1.1 <i>Oracle Identity Manager System Components</i> .....	4-1
4.2 INTEGRATION / DESIGN ARCHITECTURE .....	4-3
4.2.1 <i>Provisioning Design Architecture</i> .....	4-4
4.2.2 <i>Reconciliation Design Architecture</i> .....	4-4
4.2.3 <i>Design Constraints</i> .....	4-4
4.2.4 <i>Message Flow</i> .....	4-5
<b>5. INSTALLATION / CONFIGURATION .....</b>	<b>5-1</b>
5.1 ENVIRONMENT SETUP/CONFIGURATIONS.....	5-1
5.1.1 <i>Enabling SSL for Weblogic and OIM Server</i> .....	5-1
5.1.2 <i>Enabling SSL on GTC Connector Server</i> .....	5-5
5.1.3 <i>Configuring SSL Mode in Oracle Internet Directory</i> .....	5-7
5.1.4 <i>OIM FLEXCUBE Adapter Setup</i> .....	5-10
5.1.5 <i>Build GWEJB</i> .....	5-23
5.1.6 <i>OIM Setup</i> .....	5-23
5.1.7 <i>System Configurations</i> .....	5-53
<b>6. SOLUTION / USAGE GUIDELINES.....</b>	<b>6-1</b>
6.1 WORKING WITH OIM.....	6-1
6.1.1 <i>Creating a user in FLEXCUBE through OIM</i> .....	6-1
6.1.2 <i>Modifying a user in FCUBS through OIM</i> .....	6-8
6.1.3 <i>Disable/Remove Accounts in FCUBS through OIM</i> .....	6-10
6.1.4 <i>Enabling a Disabled user in FCUBS through OIM</i> .....	6-12
6.1.5 <i>Running Reconciliation in OIM</i> .....	6-13
<b>7. REFERENCE.....</b>	<b>7-1</b>
<b>8. APPENDIX.....</b>	<b>8-1</b>
8.1 DATA SOURCE CREATION .....	8-1

---

# 1. Introduction

For the purpose of centralized user provisioning FLEXCUBE is qualified with Oracle Identity Manager - Oracle® Fusion Middleware 11g Release 2 (11.1.2.3.0). This feature is available in FLEXCUBE since the release FCUBS V.UM 10.1.0.0.0.0.0.

## 1.1 Scope

This document provides an understanding as to how centralized provisioning through OIM can be enabled for FCUBS.

In addition to providing a background to the various components of the deployment, this document provides detailed steps as to how to install the various FCUBS components required for the integration with OIM configuration in FCUBS and Oracle Identity Manager to enable centralized provisioning.

## 1.2 Introduction to Oracle Identity Manager

Oracle Identity Manager is an identity management product that automates user provisioning, identity administration, and password management, integrated in a comprehensive workflow engine. It enables organizations to reduce Information Technology (IT) administration costs and improve security. Oracle identity manager achieves this by providing a centralized control mechanism to manage the entire life cycle of user identities and entitlements and to control user access to across all resources in the organization.

## 1.3 Advantage

Integrating FCUBS with Oracle identity Manager provides capability for managing the entire life cycle of FCUBS user identities through a centralized point provided by OIM in both scenario- FCUBS without single sign on and FCUBS with single sign on.

---

## 2. Requirements / Problem Statement

The requirement is to integrate FCUBS with Oracle Identity Manager for FCUBS user provisioning and de-provisioning services with and without FCUBS single sign on.



## 3. Prerequisites

### 3.1 Software Required

Oracle® Fusion Middleware 11g Release 2 (11.1.2.3.0)

Refer [Oracle Identity Manager Document for Installation and configuration of Oracle Identity Manager](#).

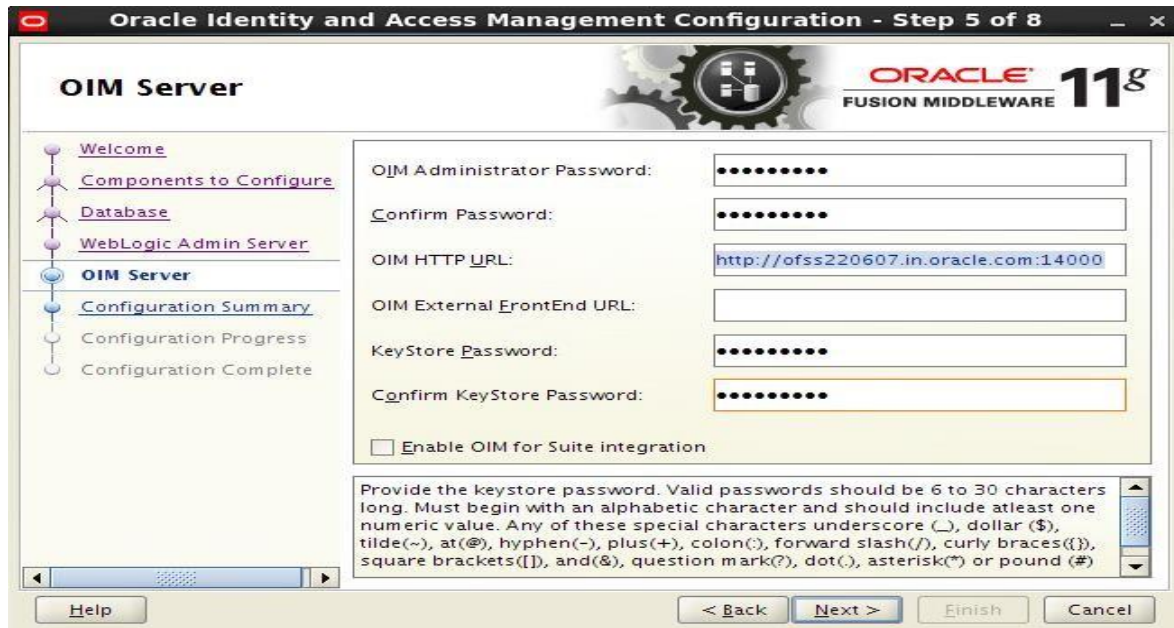

Note \*: To get the Keystore Password in the above screen while configuring OIM Console, you should have only Weblogic Admin Server, OIM Server and SOA Server in this OIM Domain. Based on that the below keystore will be created with store password

<Domain\_home>/config/fmwconfig/default-keystore.

- Oracle Internet Directory Connector 11.1.1.6.0
- Refer the below sections:
  - > [Installation of Oracle Internet Directory Connector \(Section 2.2.1.1, 2.2.1.2 & 2.3.1.1\)](#)
  - > Connector by default will be available with Oracle Identity and Access Management Suite.

The path will be as follows :

<Oracle\_Middleware>/<OIM\_HOME>/connector/oid

For example:

Linux: /app/oracle/Middleware/Oracle\_IDM1/connector/oid

Windows: C:\apps\oracle\Middleware\Oracle\_IDM1\connector\oid

The above directory <oid> has to be copied into

<Oracle\_Middleware>/<OIM\_HOME>/server/ConnectorDefaultDirectory

> [Configuring Oracle Identity Manager Design Console](#)

## 3.2 **FLEXCUBE Component Required**

FLEXCUBE Gateway EJB

---

## 4. System Description

### 4.1 About Oracle Identity Manager

Oracle Identity Manager is an identity management product that automates user provisioning, identity administration, and password management, integrated in a comprehensive workflow engine. Key features of Oracle Identity Manager include password management, workflow and policy management, identity reconciliation, reporting and auditing, and extensibility through adapters.

#### 4.1.1 Oracle Identity Manager System Components

Oracle Identity Manager is built on an enterprise-class, modular architecture that is both open and scalable. Each module plays a critical role in the overall functionality of the system:

##### **Identity Administration**

Identity administration includes creation and management of identities in Oracle Identity Manager. Identities include users, organizations, and roles. Identity administration also enables password management and user Oracle Identity Manager Self Service operations. Identity administration is performed by using Oracle Identity Manager Administration and Oracle Identity Manager Self Service Web clients, and the SPML Web service.

##### **Provisioning**

The provisioning transactions are assembled and modified in the provisioning module. This module maintains the "who" and "what" of provisioning. User profiles, access policies, and resources are defined in the provisioning module, as are business process workflows and business rules.

The Provisioning Server is the run-time engine for Oracle Identity Manager. It runs the provisioning process transactions as defined through Oracle Identity Manager Administration and Oracle Identity Manager Design Console and maintained within the provisioning module.

##### **Audit and Reports**

The audit and compliance functions include evaluating a person, organization, system, process, project, or product. This occurs by capturing data generated by the suite's workflow, policy, and reconciliation engines. By combining this data with identity data, an enterprise has all the information it requires to address any identity and to access a related audit inquiry. Audits are performed to ascertain the validity and reliability of information, and also provide an assessment of a system's internal control.

Reporting is the process of generating a formal document, which is created as a result of an audit. The report is subsequently provided to a user, such as an individual, a group of persons, a company, a government, or even the general public, as an assurance service so that the user can make decisions, based on the results of the audit. An enterprise can create reports on both the history and the current state of its provisioning environment. Some captured identity data includes user identity profile history, role membership history, user resource access, and fine-grained entitlement history.

##### **Reconciliation and Bulk Load**

The reconciliation engine ensures consistency between the provisioning environment of Oracle Identity Manager and Oracle Identity Manager managed resources within the organization. The reconciliation engine discovers illegal accounts created outside Oracle Identity Manager. The reconciliation engine also synchronizes business roles located inside and outside the provisioning system to ensure consistency.

If you want to load a large amount of data from other repositories in your organization into Oracle Identity Manager, then you can use the Bulk Load utility. The Bulk Load utility reduces the downtime in loading the data. In addition, Bulk Load utility import Oracle Identity Manager users, roles, role memberships, and accounts provisioned to users.

## Common Services

Various services are grouped together that are shared and used by other Oracle Identity Manager components. These services are:

**Form Designer:** A form that allows you to create process and resource object forms that do not come packaged with Oracle Identity Manager.

**Scheduler:** A service that provides the capability to run specific jobs at specific schedules. This service can be used by users, application developers, connector developer, and administrators to create and configure a Job to be run at specified intervals. In addition, this service provides administrative capabilities to manage the functionality of jobs and their schedules.

**Notification Templates:** A common notification service is used by other functional components to send notifications to interested parties about events occurring in Oracle Identity Manager. In addition, this service provides the administrative capabilities for notification template management. A notification template is used for sending the outgoing notifications. These templates typically contain the variables that refer to the available data to provide more contextual content.

**System Properties:** A system property is an entity that controls the configuration aspect of an application. In addition, to the default system properties, you can create and manage system properties in Oracle Identity Manager.

**Deployment Manager:** The Deployment Manager is a tool for exporting and importing Oracle Identity Manager configurations. The Deployment Manager enables you to export the objects that make up your Oracle Identity Manager configuration.

## Workflow and Request Management

Various operations in Oracle Identity Manager cannot be performed directly. Instead, the operations must be requested. The request management service provides a mechanism to create, approve, and manage requests. A request is an entity created by the users or administrators who want to perform a specific action, which requires a discretionary permission to be obtained from someone or some process before the action can be performed. For example, a user can create a request to gain access to a laptop computer, a manager can approve the request and create an open requisition, and an IT resource administrator can approve the request.

The primary goal of a provisioning solution is to manage requests and provision resources. Request service provides an abstraction layer on the Business Process Execution Language (BPEL) 11g workflow engine. Functional components such as request, provisioning, and attestation interacts with the workflow engine for human approvals. Request service caters to the various functional components in Oracle Identity Manager by managing workflow instances and categories, and provides an abstraction layer on BPEL.

## Infrastructure and Middleware Integration

The Adapter Factory, Kernel Orchestration mechanism, Context Manager, and Plug-in Framework are designed to eliminate the need for hard-coding integrations with these systems.

## Connector Framework

The integration solution strategy of Oracle Identity Manager provides connectors to various heterogeneous identity-aware IT systems. This strategy is designed to minimize custom development, maximize the reuse of code, and reduce deployment time. The tiers of the integration solution are:

- Out-of-the box integration using predefined connectors and predefined generic technology connector providers

- Identity connectors that are designed to separate the implementation of an application from the dependencies of the system that the application is attempting to connect to
- Connectors based on custom generic technology connector providers
- Custom connectors using the Adapter Factory

Following figure illustrates the system components of Oracle Identity Manager.

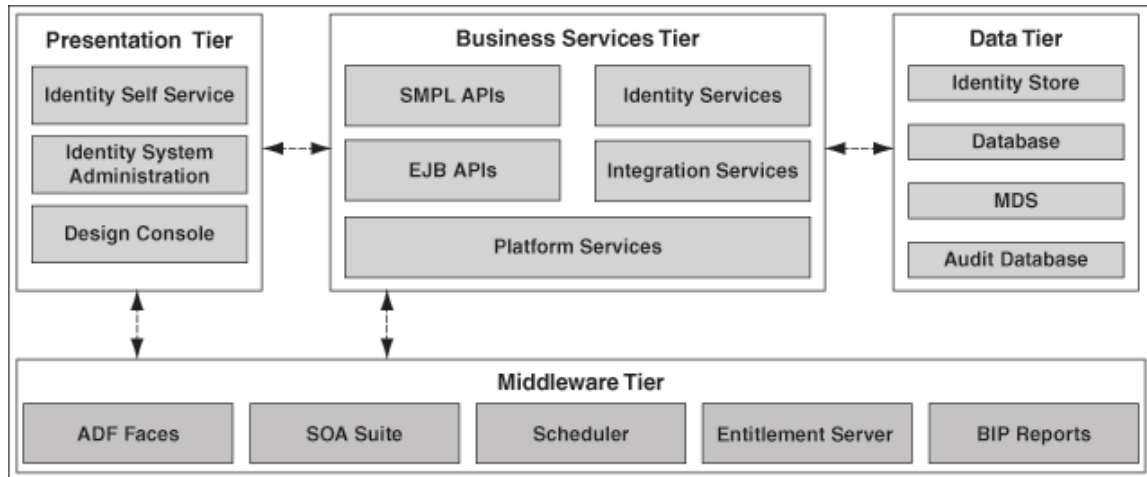

## 4.2 Integration / Design Architecture

With the integration of FCUBS and Oracle Identity Manager, a user can be created, modified, closed, and reopened in FCUBS. Oracle Identity Manager acts as the front-end entry point for managing mandatory fields of FCUBS user. After users are provisioned, the users can access the FCUBS without any interaction with Oracle Identity Manager. This integration also ensures that any change that has been made for corresponding user in FCUBS should be reflected in OIM using reconciliation feature of OIM.

### Design

For the purpose of integration of Oracle Identity manager and FCUBS “Generic technology connector” (GTC) has been used. GTC provides out of box providers for provisioning and reconciliation.

Following two figures illustrate the design aspect of the provisioning and reconciliation process:

## 4.2.1 Provisioning Design Architecture

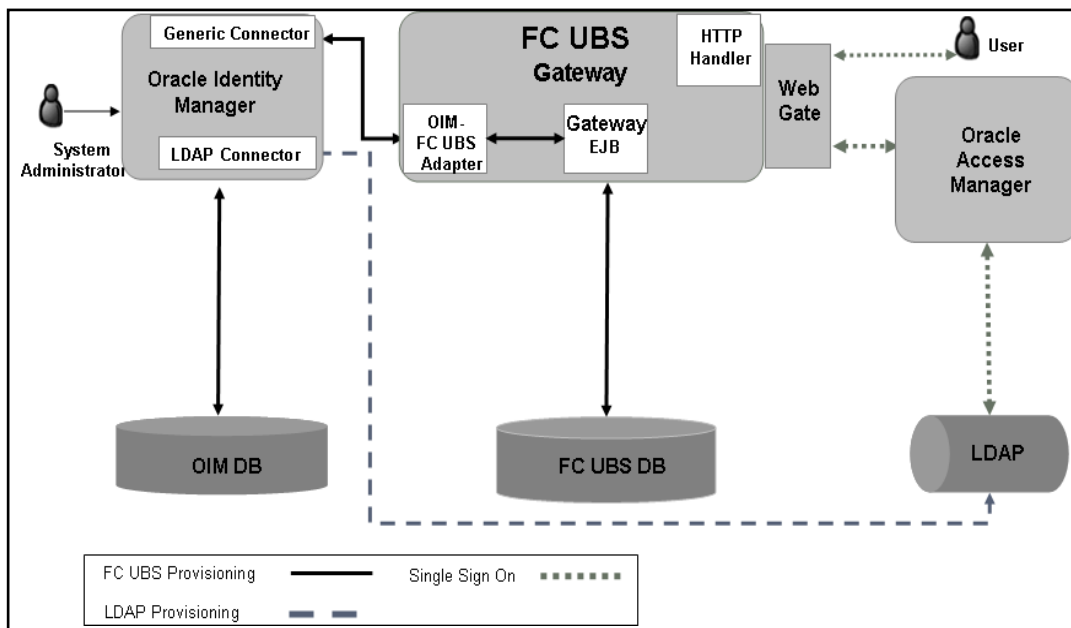

## 4.2.2 Reconciliation Design Architecture

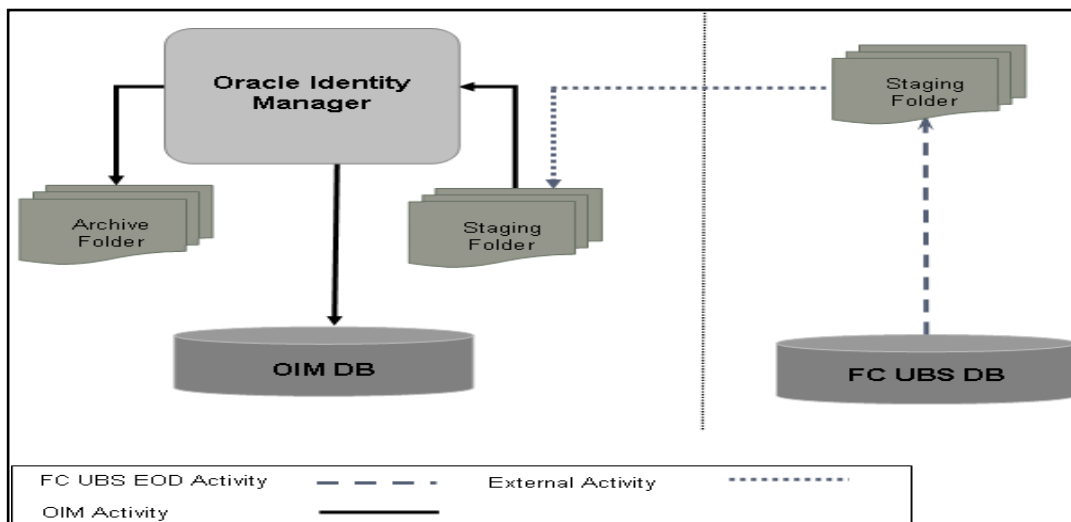

## 4.2.3 Design Constraints

The followings are the design constraints for this integration:

- This integration is based upon sample configuration containing only mandatory fields of FCUBS user while defining the GTC. Other fields can be defined in the GTC using the same configurations.
- Due to specific data requirement for FCUBS user creation, only manual provisioning method can be used for FCUBS provisioning.
- User role is not taken up in this integration and the FCUBS user will not be associated with any role at the time of user creation.
- A common FCUBS maker id will be used for user creation that is maintained as property in a property file.

- OIM does not allow ASCII special characters e.g. ampersand, colon, braces etc. Apart from this, OIM also does not allow multiple consecutive occurrences of some of special ASCII character like underscore etc.

#### 4.2.4 **Message Flow**

OIM-FCUBS adapter would transform the request from the OIM SPML/DSML to FCUBS Gateway request using Extensible Style sheet Language Transformation (XSLT). Transformed XML request will be sent to the FCUBS Gateway EJB for further processing based on the type of the request. Based on the FCUBS Gateway EJB response OIM-FCUBS adapter will prepare the response in SPML/DSML format and will send to the OIM.

Following gives the sequence of the message exchanges between the adapter and FCUBS Gateway EJB for user provisioning that are initiated from OIM.

##### 4.2.4.1 **Message exchange sequence for User Creation**

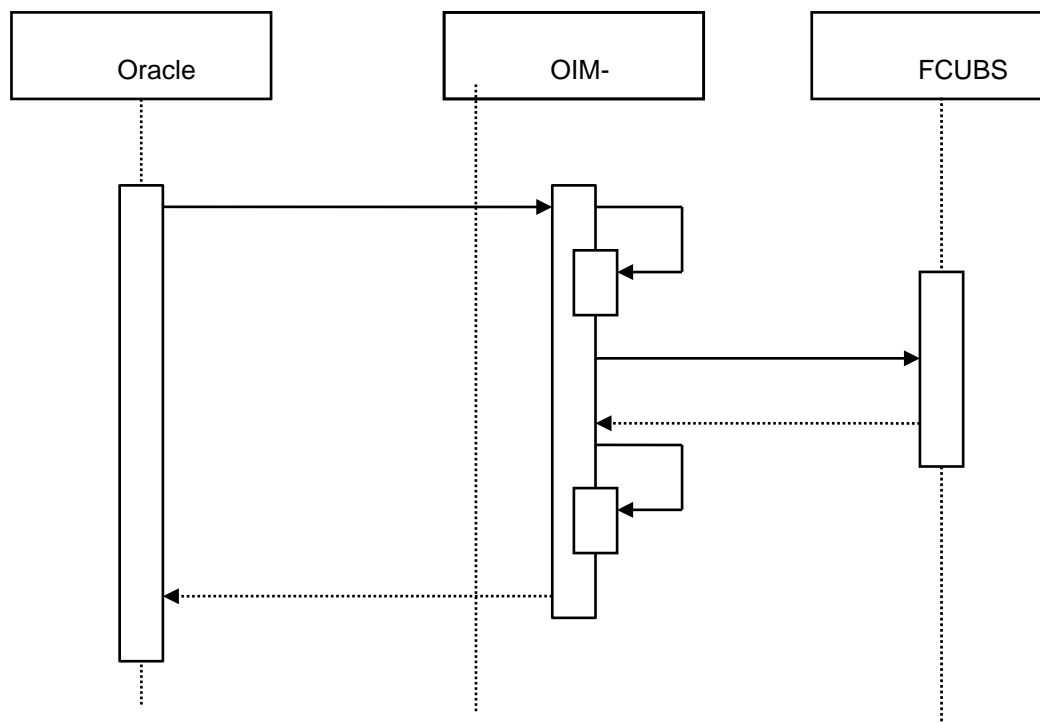

#### 4.2.4.2 Message exchange sequence for User Field Modification/Set Password

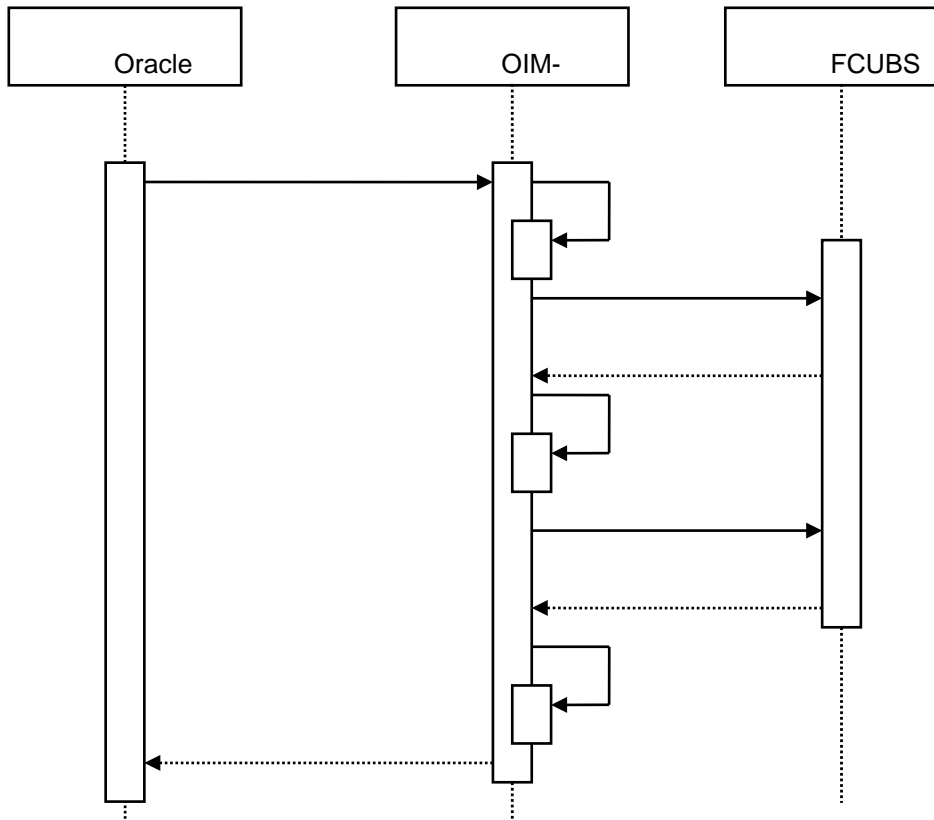



### 4.2.4.3 Message exchange sequence for User Delete/Suspend/Resume Request

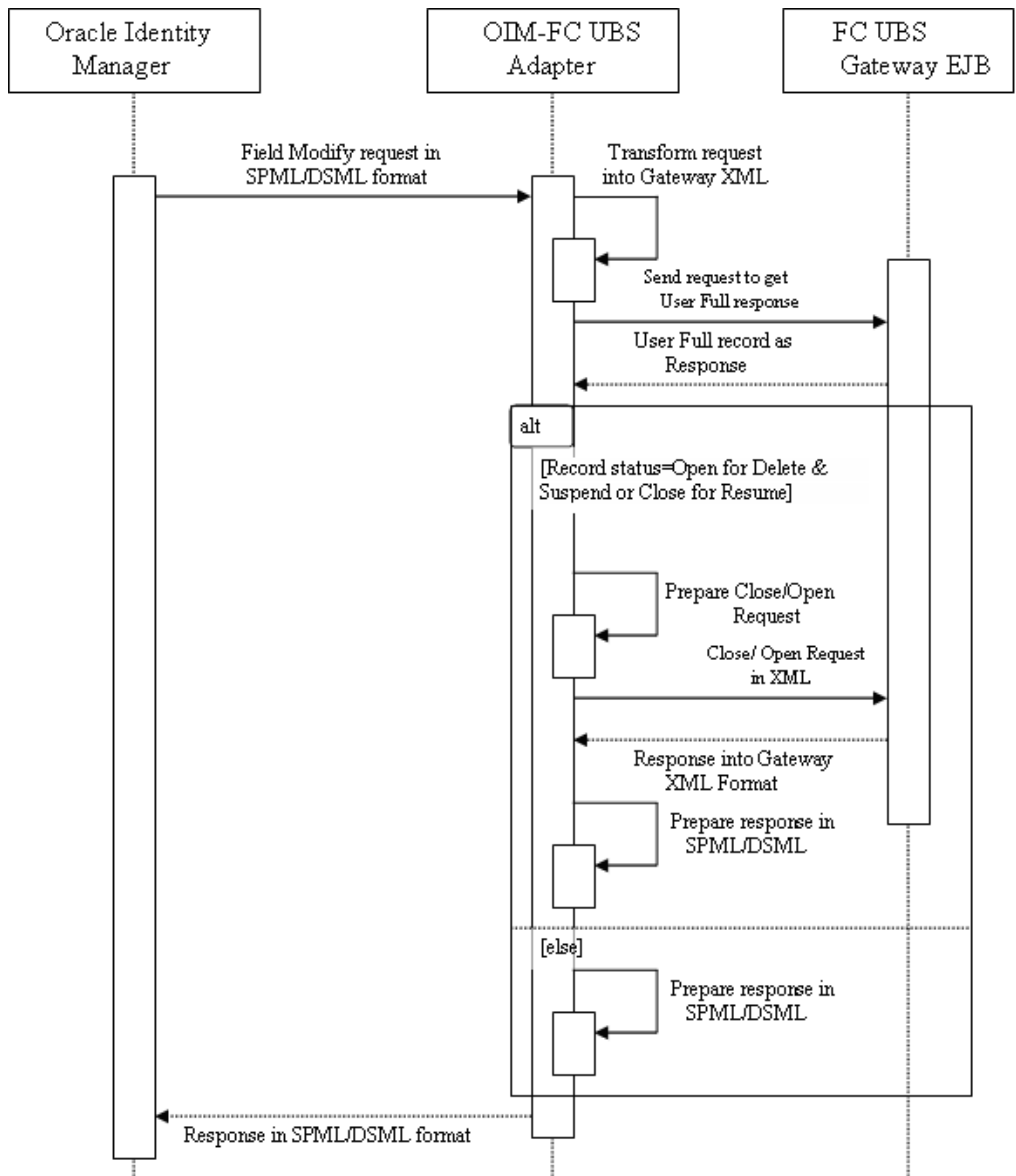

---

## 5. Installation / Configuration

### 5.1 Environment Setup/Configurations

FLEXCUBE - OIM Integration environment setup requires

- OIM FLEXCUBE Adapter setup & configuration
- OIM setup

Note: This implementation document describes the installation and setup of OIM FLEXCUBE Adapter on Oracle Fusion Middleware 11g Release 2 (11.1.2.3.0).

#### 5.1.1 Enabling SSL for Weblogic and OIM Server

##### 5.1.1.1 Self-Signed Certificate Creation

To enable SSL mode, Weblogic requires a keystore which contains private and trusted certificates. We have to use the same version of JDK (which is used by Weblogic Domain), to create the keystore and certificates, otherwise it may lead to many difficulties (suggested by Oracle Support).

Keytool utility available in Java JDK will be used to create Keystore. In command prompt set PATH to the JDK\bin location. Follow the below steps to create keystore and self-signed certificates:Keystore Creation

##### 5.1.1.1.1 Key Store Creation

```
keytool -genkey -keystore <keystore_name.jks> -alias <alias_name> -dname "CN=<hostname>,
OU=<Organization Unit>, O=<Organization>, L=<Location>, ST=<State>, C=<Country_Code>" -keyalg
<Key Algorithm> -sigalg <Signature Algorithm> -keysize <key size> -validity <Number of Days> -
keypass <Private key Password> -storepass <Store Password>
```

For example:

```
keytool -genkey -keystore AdminFlexcubeKeyStore.jks -alias FlexcubeCert -dname
"CN=ofss00001.in.oracle.com, OU=OFSS, O=OFSS, L=Chennai, ST=TN, C=IN" -keyalg "RSA" -sigalg
"SHA1withRSA" -keysize 2048 -validity 3650 -keypass Password@123 -storepass Password@123
```

**Note:** **CN=ofss00001.in.oracle.com** is the Host Name of the weblogic server

##### 5.1.1.1.2 Export Private key as Certificate

```
keytool -export -v -alias <alias_name> -file <export_certificate_file_name_with_location.cer> -keystore
<keystore_name.jks> > -keypass <Private key Password> -storepass <Store Password>
```

For example:

```
keytool -export -v -alias FlexcubeCert -file AdminFlexcubeCert.cer -keystore AdminFlexcubeKeyStore.jks
-keypass Password@123 -storepass Password@123
```

##### 5.1.1.1.3 Import as Trusted Certificate

```
keytool -import -v -trustcacerts -alias rootcert -file <export_certificate_file_name_with_location.cer> -
keystore <keystore_name.jks> > -keypass <Private key Password> -storepass <Store Password>
```

For example:

```
keytool -import -v -trustcacerts -alias rootcert -file AdminFlexcubeCert.cer -keystore AdminFlexcubeKeyStore.jks -keypass Password@123 -storepass Password@123
```

References: Oracle Support Articles (Article ID 1281035.1, Article ID 1218695.1), in case of Certificates issued by the Trusted Authorities

### 5.1.1.2 Configuring Weblogic Console

After domain creation, follow the below steps to enable SSL in Weblogic Admin server, OIM Server and SOA Server.

#### 5.1.1.2.1 Select Admin Server to enable SSL options.

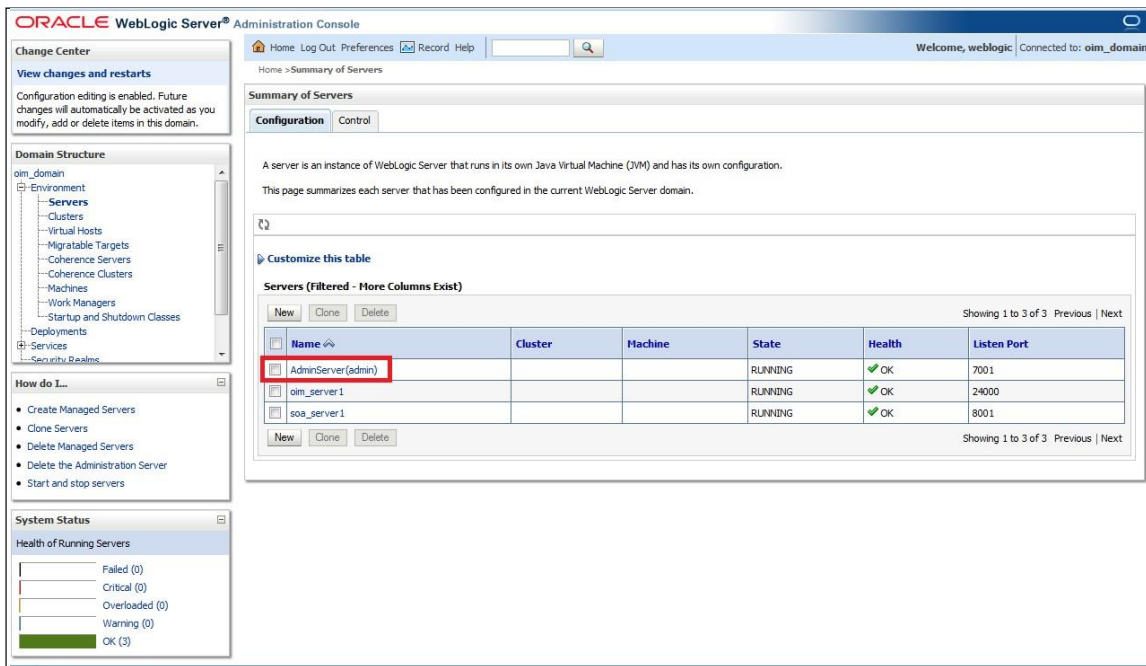

The screenshot shows the Oracle WebLogic Server Administration Console. The main content area displays the 'Summary of Servers' page. A table lists the servers in the domain:

Name	Cluster	Machine	State	Health	Listen Port
AdminServer(admin)			RUNNING	OK	7001
oim_server1			RUNNING	OK	24000
soa_server1			RUNNING	OK	8001

The 'AdminServer(admin)' row is highlighted with a red box. The console also shows a 'Domain Structure' tree on the left and a 'System Status' section at the bottom left.

#### 5.1.1.2.2 Follow the steps in General Tab as shown below:

1. Select SSL Listen Port Enabled, Client Cert Proxy Enabled, Weblogic Plug-In Enabled.
2. Click on Save.

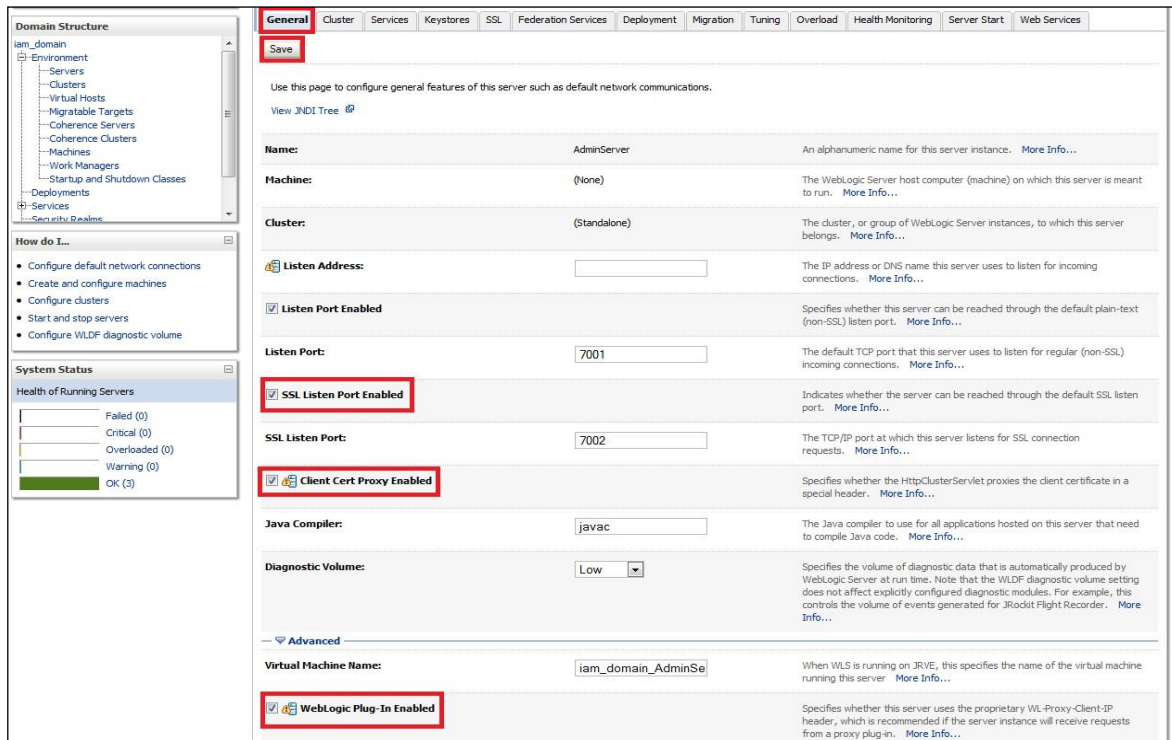

### 5.1.1.2.3 Follow the steps in Keystores Tab as shown below:

1. Click Change and select Keystores as **Custom Identity and Custom Trust**
2. Click on Save
3. Note: Keystores as **Custom Identity and Custom Trust** is as suggested by Oracle Support Team

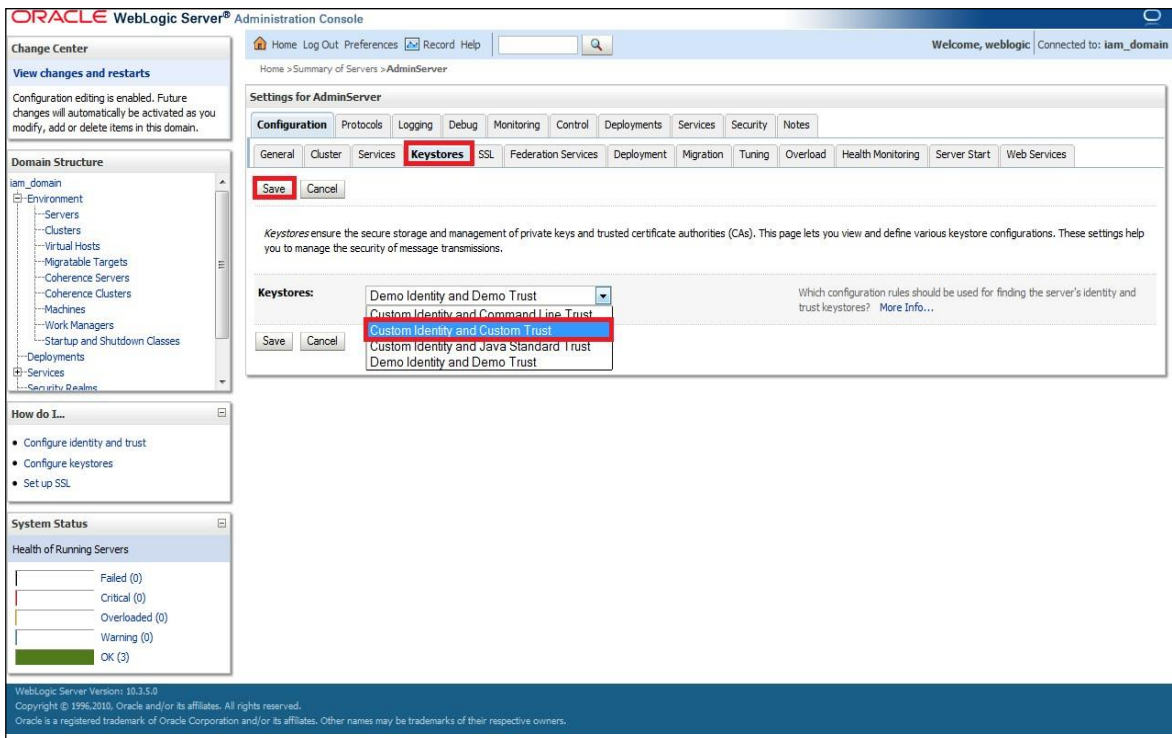

### 5.1.1.2.4 Follow the steps in Keystores Tab as shown below:

4. Enter Custom Identity Keystore and Custom Line Trust Keystore as same as the Keystore Name created in step [5.1.1.1.1](#) with full path.

5. Enter Custom Identity Keystore Type and Custom Trust Keystore Type as jks.
6. Enter Custom Identity Keystore Passphrase, Confirm Custom Identity Keystore Passphrase, Custom Trust Keystore Passphrase and Confirm Custom Trust Keystore Passphrase as same as the Store Password entered in step [5.1.1.1.1](#).
7. Click on Save.

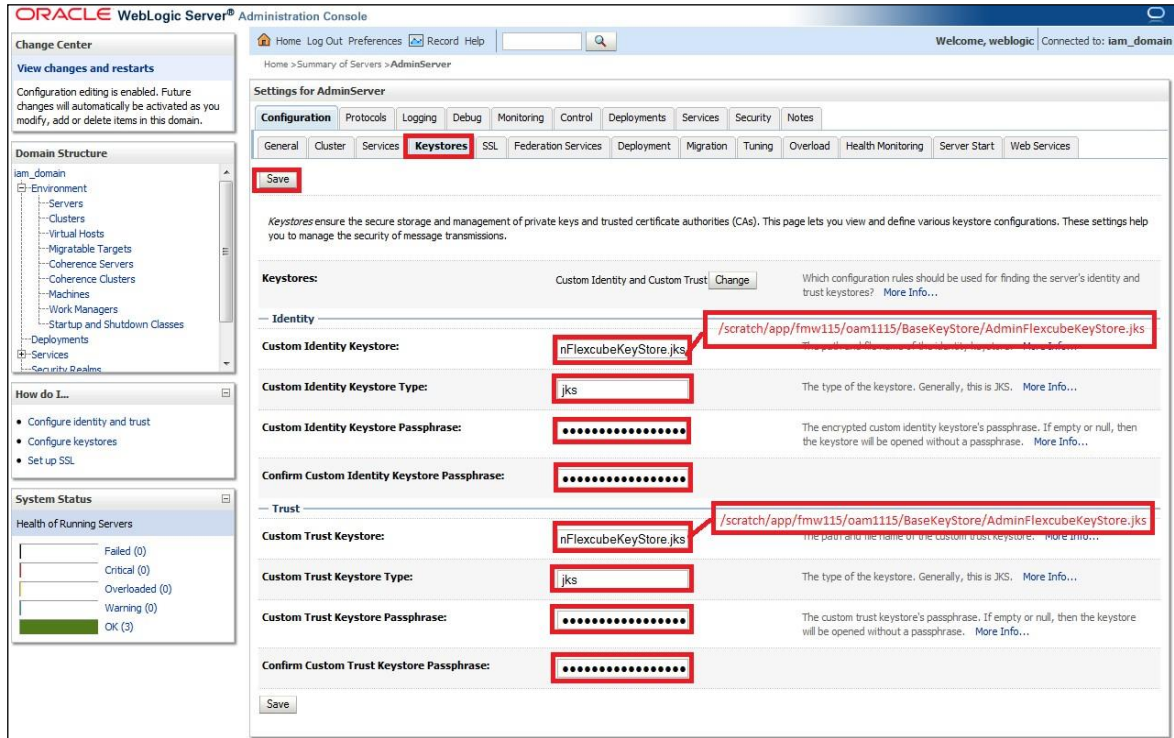

#### 5.1.1.2.5 Follow the steps in SSL Tab as shown below:

1. Enter Private Key Alias as same as the alias name entered in step [5.1.1.1.1](#).
2. Enter Private Key Passphrase and Confirm Private Key Passphrase as same as the Private Key Password entered in step [5.1.1.1.1](#).
3. Change the Hostname Verification to None.
4. Use JSSE SSL option should be remain unchecked
5. Click on Save.

The screenshot shows the 'Settings for AdminServer' page in the Oracle WebLogic Administration Console. The 'SSL' tab is active, and the 'Save' button is highlighted. The page contains several configuration sections:

- Identity and Trust Locations:** Includes 'Private Key Location' (from Custom Identity Keystore), 'Private Key Alias' (FlexcubeCert), 'Private Key Passphrase' (masked), and 'Confirm Private Key Passphrase' (masked).
- Trust:** Includes 'Trusted Certificate Authorities' (from Custom Trust Keystore).
- Advanced:** Includes 'Hostname Verification' (set to None) and 'Custom Hostname Verifier' (set to None).
- Export Key Lifespan:** Set to 500.
- Use Server Certs:** A checkbox option.

**5.1.1.2.6 Select OIM Server & SOA Server to enable SSL options and Repeat the steps performed in 5.1.1.2.2 to 5.1.1.2.5.**

The screenshot shows the 'Summary of Servers' page in the Oracle WebLogic Administration Console. The 'oim\_server 1' and 'soa\_server 1' are highlighted in the server list table. The table shows the following data:

Name	Cluster	Machine	State	Health	Listen Port
AdminServer(admin)			RUNNING	OK	7001
oim_server 1			RUNNING	OK	24000
soa_server 1			RUNNING	OK	8001

**5.1.1.2.7 Now the admin\_server, oim\_server and soa\_server are SSL enabled. Restart all three servers.**

**5.1.2 Enabling SSL on GTC Connector Server**

To have SSL enabled Provisioning Web Service in 5.1.5.23. We have to have a two way handshake between GTC Connector Server and the Application Server, where FCUBSProvisioningAdService web service deployed.



### 5.1.2.1 Export the KeyStore Certificate in [5.1.1.1](#)

```
keytool -export -alias <aliasname> -file <exportfilename> -keystore <keystorename> -storetype jks -storepass <keystorepassword> -provider sun.security.provider.Sun
```

For Example:

```
keytool -export -alias FlexcubeCert -file webfile.cer -keystore FlexcubeKeyStore.jks -storetype jks -storepass Password@123 -provider sun.security.provider.Sun
```

### 5.1.2.2 Import the Certificate to Xellarate Key Store

```
keytool -import -trustcacerts -alias <aliasname> -noprompt -keystore <Domain_home>/config/fmwconfig/default-keystore.jks -file <importfilename> -storepass <keystorepassword>
```

For Example:

```
keytool -import -trustcacerts -alias FlexcubeCert -noprompt -keystore /app/Middleware/user_projects/domains/oim_domain/config/fmwconfig/default-keystore.jks -file webfile.cer -storepass Password123
```

Note \*: <Domain\_home>/config/fmwconfig/default-keystore.jks will be the KeyStore Password while configuring OIM Server. To have this feature, you should have only Weblogic Admin Server, OIM Server and SOA Server in this OIM Domain.

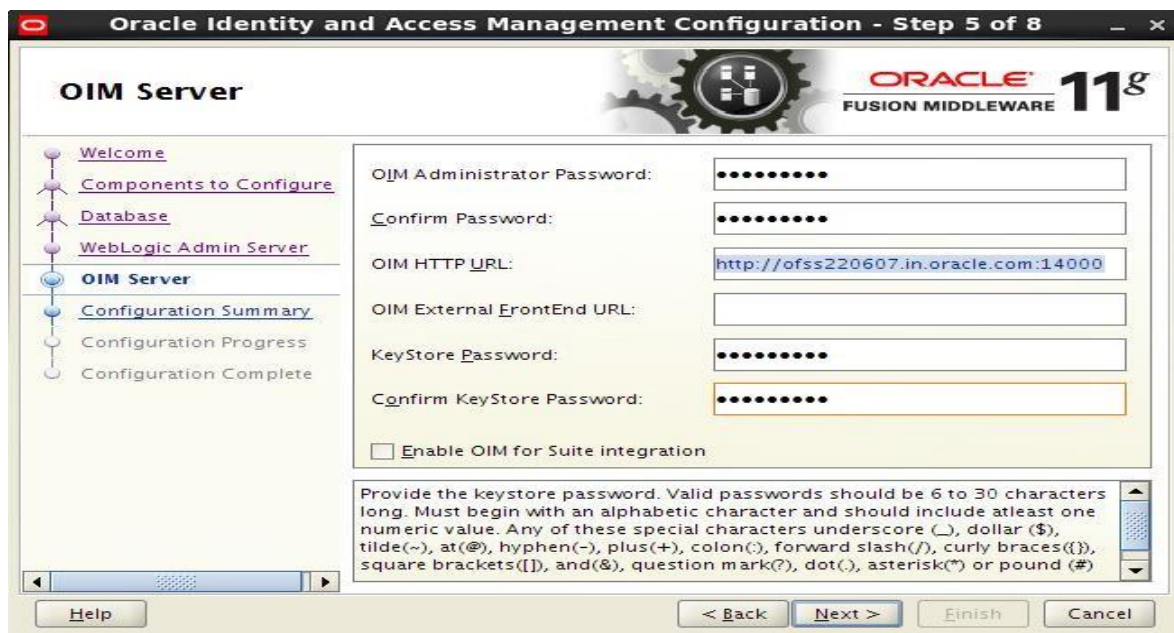

### 5.1.2.3 Export Xellarate KeyStore Certificate

```
keytool -export -alias xell -noprompt -keystore <Domain_home>/config/fmwconfig/default-keystore.jks -file <xellexportfilename> -storetype jks -provider sun.security.provider.Sun
```

For Example:

```
keytool -export -alias xell -noprompt -keystore /app/Middleware/user_projects/domains/oim_domain/config/fmwconfig/default-keystore.jks -file xellcertificate.cer -storetype jks -provider sun.security.provider.Sun
```

### 5.1.2.4 Import the Xellarate Certificate to KeyStore Created in 5.1.1.1.1

```
keytool -import -alias <aliasname> -trustcacerts -file <xellimportfilename> -keystore <keystorename> -storetype jks -storepass <keystorepassword> -provider sun.security.provider.Sun
```

For Example:

```
keytool -import -alias xellcertificate -trustcacerts -file xellcertificate.cer -keystore FlexcubeKeyStore.jks -storetype jks -storepass Password@123 -provider sun.security.provider.Sun
```

### 5.1.3 **Configuring SSL Mode in Oracle Internet Directory**

To enable SSL for OID LDAP Server refer and follow the below steps.

Login to the Enterprise Manager Console of the domain, in which Oracle Internet Directory is associated.

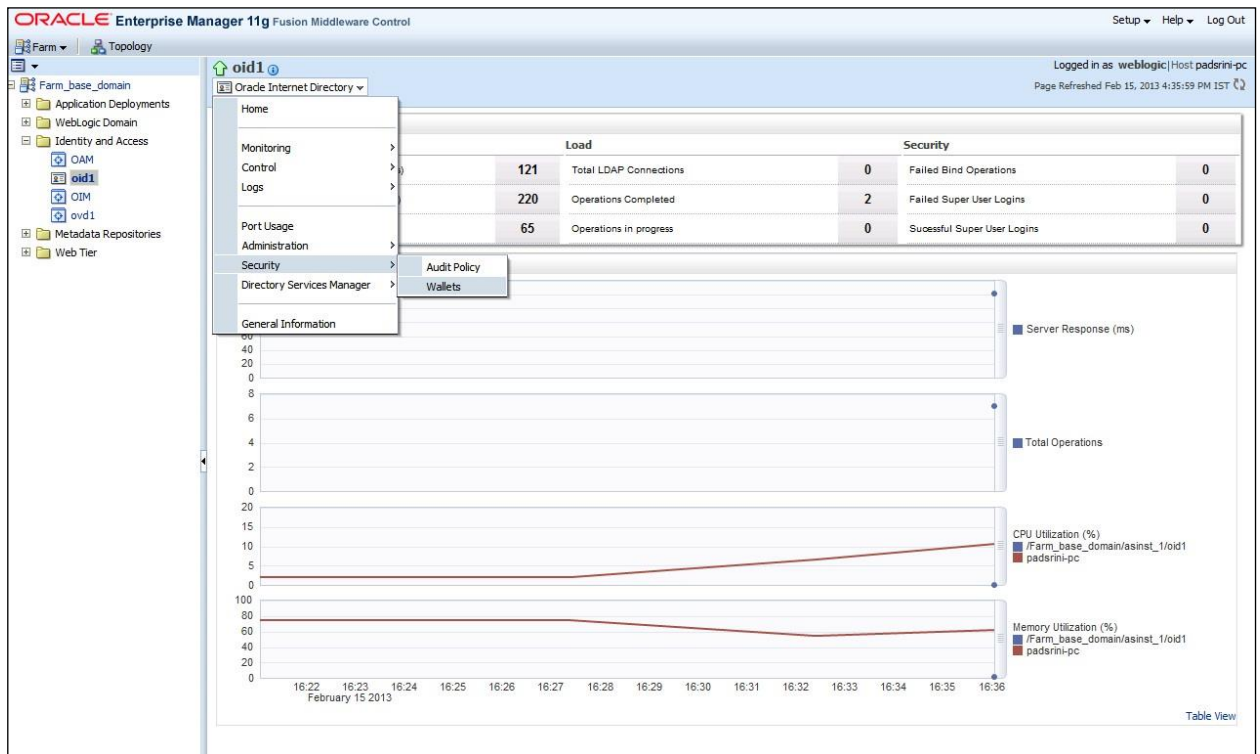

Click on Create Self-Signed Wallet.

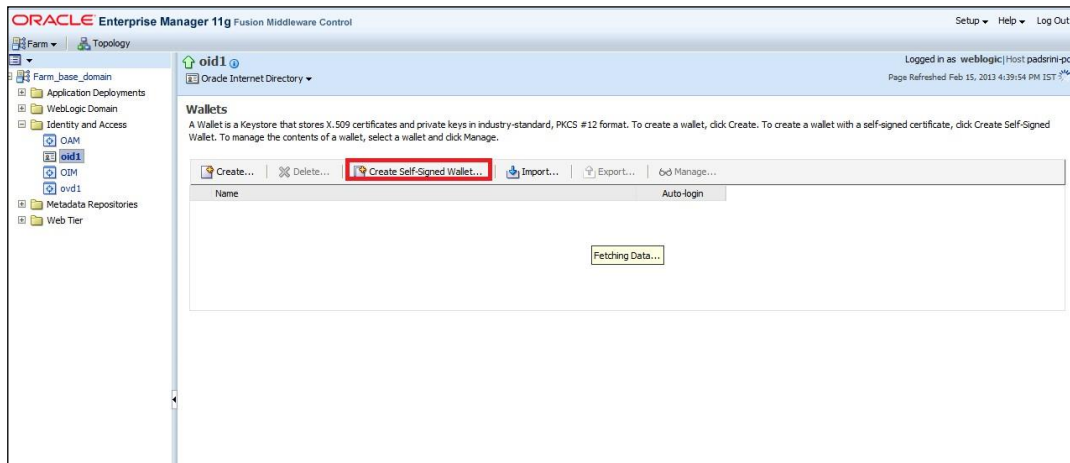



Enter the Details as below & Click on OK.

**ORACLE Enterprise Manager 11g Fusion Middleware Control**

Setup Help Log Out

Logged in as weblogic@Host padsrini-pc  
Page Refreshed Feb 15, 2013 4:40:45 PM IST

Walleys > Create Self-Signed Wallet

**Create Self-Signed Wallet** [OK] [Cancel]

A self signed wallet is not signed by a well known CA. A self-signed wallet is not recommended in a production environment. The wallet name should be unique for a given component. The wallet type can be auto-login or password-protected. Passwords, if specified, have a minimum length of eight characters, and contain alphabetic characters combined with numeric or special characters. Auto-login wallet is an obfuscated form of PKCS #12 wallet that provides PKI-based access to services and applications without requiring a password at runtime. Auto-login wallet don't need a password to modify, or delete the wallet. File system permissions provide the necessary security for Auto-login wallets.

**Self-Signed Wallet Details**

\* Wallet Name:

Auto-login

Wallet Password:

Confirm Password:

**Add Self-Signed Certificate**

Add a self-signed certificate that becomes part of the wallet.

\* Common Name:

Organizational Unit:

Organization:

City:

State:

Country:

Key Size:

Click on Manage...

**ORACLE Enterprise Manager 11g Fusion Middleware Control**

Setup Help Log Out

Logged in as weblogic@Host padsrini-pc  
Page Refreshed Feb 15, 2013 4:44:27 PM IST

**Walleys**

A Wallet is a Keystore that stores X.509 certificates and private keys in industry-standard, PKCS #12 format. To create a wallet, click Create. To create a wallet with a self-signed certificate, click Create Self-Signed Wallet. To manage the contents of a wallet, select a wallet and click Manage.

Create... Delete... Create Self-Signed Wallet... Import... Export... Manage...

Name	Auto-login
oidselfsigned	<input checked="" type="checkbox"/>

Select the Trusted Certificate & Click on Export.

**ORACLE Enterprise Manager 11g Fusion Middleware Control**

Setup Help Log Out

Logged in as weblogic@Host padsrini-pc  
Page Refreshed Feb 15, 2013 4:45:58 PM IST

Walleys > Manage Certificates

**Manage Certificates: oidselfsigned**

To generate a certificate signing request (CSR), click "Add Certificate Request". After you create a CSR, send it to your CA who will verify your identity and return the signed certificate. To import the CA signed certificate or trusted cert, click Import. You can only import the CA-signed certificate into the same wallet from which the CSR was generated.

Add Certificate Request Import... Export... Delete...

Subject Name	Certificate Type	Status	Key Size	Start Date	Expiration Date
CN=padsrini-pc, OU=OFSS, O=Oracle, L=Chennai, ST=TN, C=IN	Certificate Request		2048		
CN=padsrini-pc, OU=OFSS, O=Oracle, L=Chennai, ST=TN, C=IN	Certificate	Valid	2048	February 15, 2013	February 14, 2018
OU=Class 3 Public Primary Certification Authority, O=VeriSign, Inc., C=US	Trusted Certificate	Valid	1024	January 29, 1996	August 2, 2028
CN=GTE CyberTrust Global Root, OU=GTE CyberTrust Solutions, Inc., O=GTE Corporation, C=US	Trusted Certificate	Valid	1024	August 13, 1998	August 14, 2018
CN=padsrini-pc, OU=OFSS, O=Oracle, L=Chennai, ST=TN, C=IN	Trusted Certificate	Valid	2048	February 15, 2013	February 14, 2018
OU=Class 2 Public Primary Certification Authority, O=VeriSign, Inc., C=US	Trusted Certificate	Valid	1024	January 29, 1996	August 2, 2028
OU=Class 1 Public Primary Certification Authority, O=VeriSign, Inc., C=US	Trusted Certificate	Valid	1024	January 29, 1996	January 8, 2020

Click Export Trusted Certificate and save the certificate file.

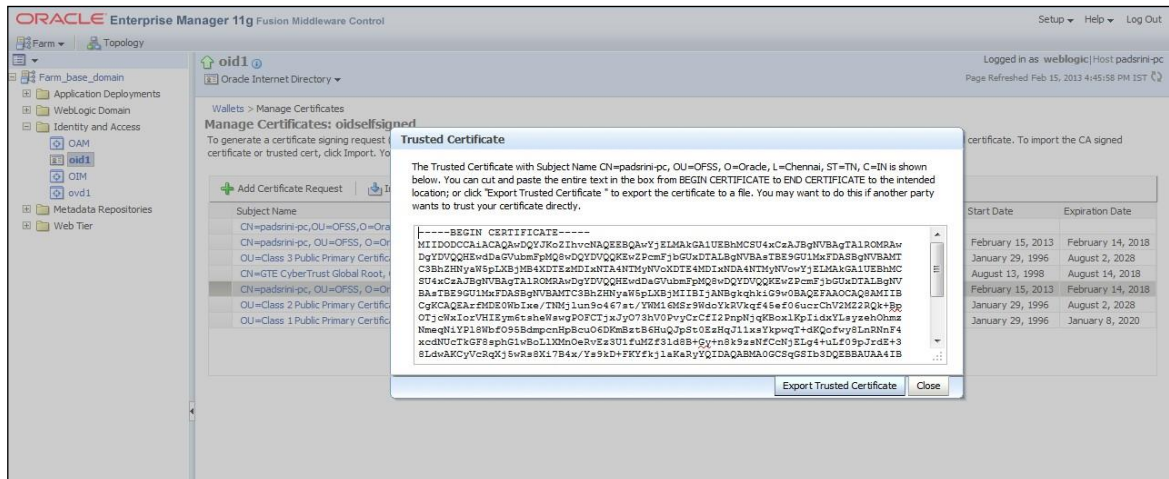

Click on Server Properties.

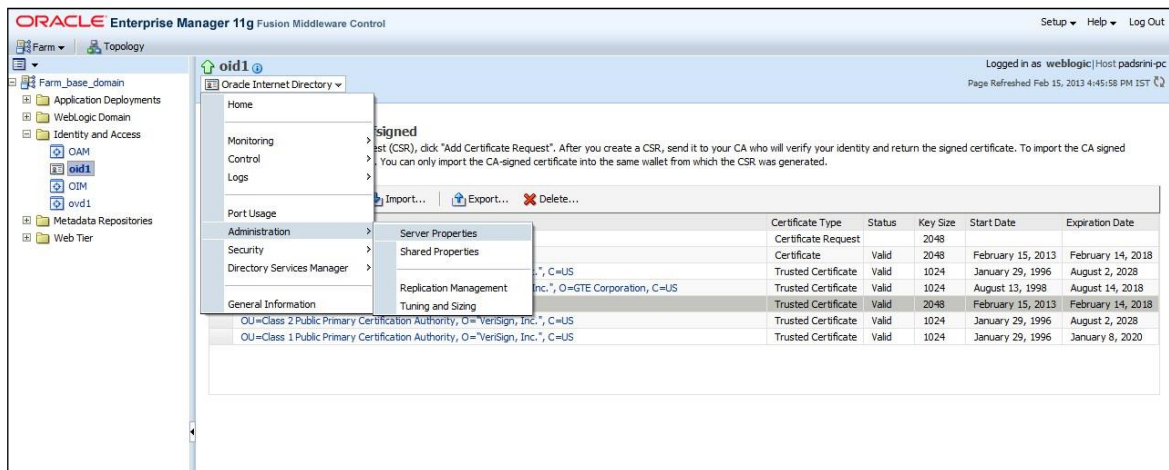

Click on Change SSL Settings.

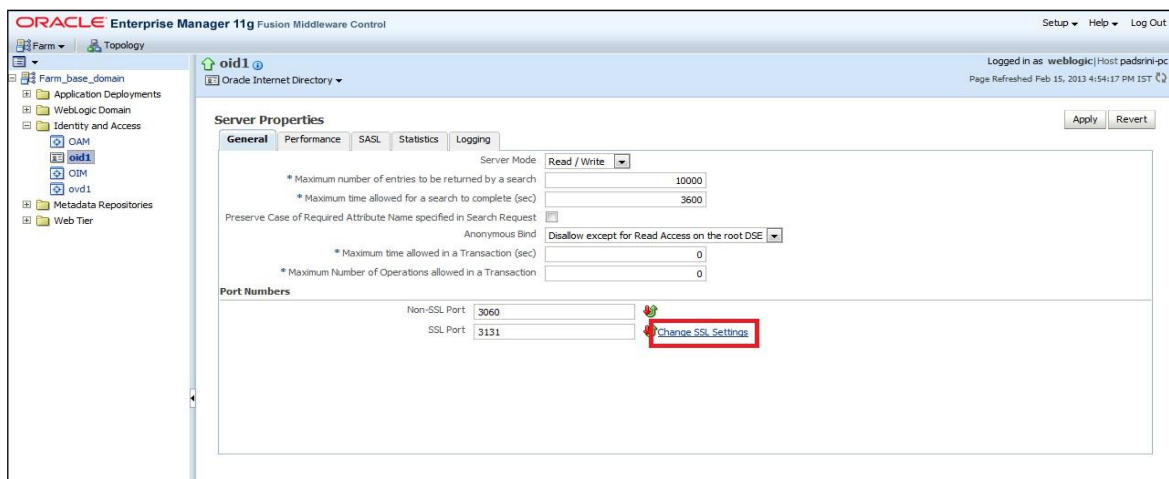

Select the Wallet, SSL Authentication as Server Authentication, Cipher Suite, SSL Protocol Version as below & Click on OK.

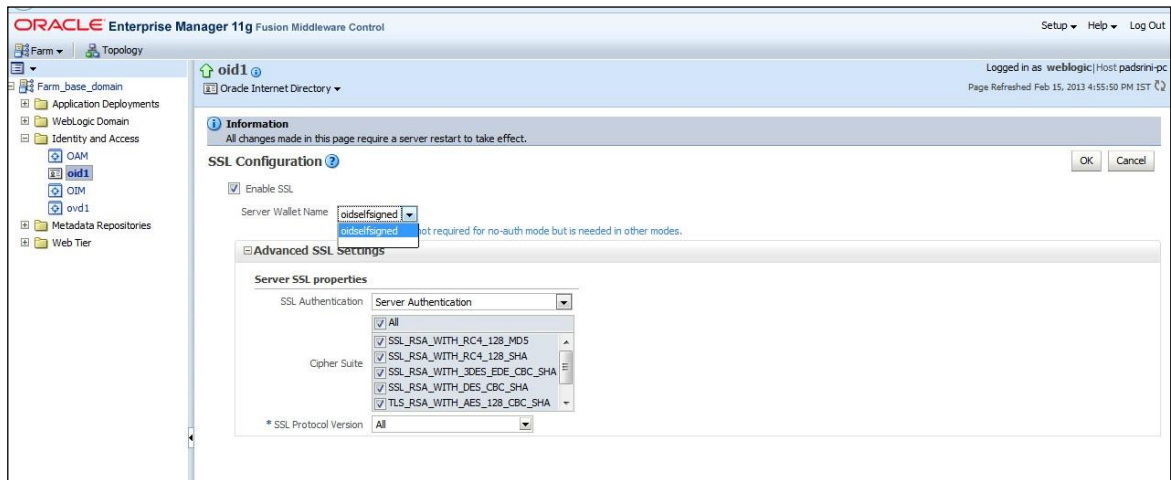

Click on Apply.

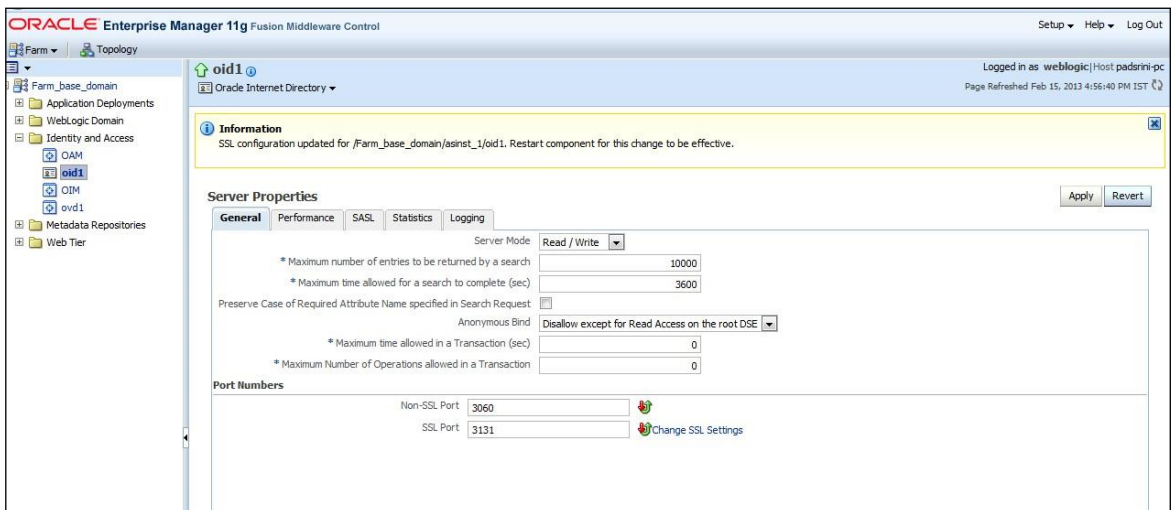

### 5.1.3.1 Import LDAP Server SSL Certificate into OIM Server

Import the Exported Certificate into **wlserver\_10.3/server/lib/DemoTrust.jks** of OIM Server Domain using the below command [Store Password is **DemoTrustKeyStorePassPhrase** ]

```
keytool -import -keystore MW_HOME/wlserver_10.3/server/lib/DemoTrust.jks -file /home/testoc4j/OIM/globalv.crt -storepass DemoTrustKeyStorePassPhrase
```

Restart Both OID & OIM Server.

### 5.1.4 OIM FLEXCUBE Adapter Setup

**Prerequisite:** Gateway EJB component

OIM FCUBS adapter consists of two web services:

- FCUBSLOVAdService : To fetch list of values from FCUBS Database
- FCUBSProvisioningAdService: To handle OIM's request and response for user provisioning and de-provisioning services. This web service requires FCUBS Gateway EJB either on same Weblogic Application server or another. If it is on same Weblogic Application server then this web service is deployed as child of Gateway EJB.

OIM FCUBS adapter setup is all about deployment of these web services on Oracle Fusion Middleware 11g Release 2 (11.1.2.3.0).

#### 5.1.4.1 Environment Setup

The following steps to be followed to do the initial environment setup for OIM FCUBS adapter deployment:

##### 5.1.4.1.1 Copy following folders from the FCUBS Software Release area

- <FCUBS Release Name>\ADAPTERS\OIM\FCUBSLOVAdService
- <FCUBS Release Name>\ADAPTERS\OIM\FCUBSProvisioningAdService
- <FCUBS Release Name>\ADAPTERS\OIM\setup

to local machine (say **D:\OIM** for WINDOWS or **/home/kernel/OIM** for UNIX).

Note: If Gateway EJB server and OIM server is on same system, then copy entire folder from FCUBS software release area to local machine.

In this document SPMLADAPTER\_INSTALL\_DIR specifies the directory where adapter will be installed.

e.g.

For WINDOWS:

SPMLADAPTER\_INSTALL\_DIR=D:\

For UNIX:

SPMLADAPTER\_INSTALL\_DIR=/home/kernel/

OIM\_SERVER\_INSTALL\_DIR specifies the OIM server installation directory (like D:\Oracle\Middleware\weblogic\Oracle\_IDM1 in windows or /Oracle/Middleware/weblogic/ Oracle\_IDM1 in unix).

##### 5.1.4.1.2 Create a Data source in WebLogic Server Version: 10.3.6.0.

[\[Refer Appendix 8.1 Data Source Creation\]](#)

##### 5.1.4.1.3 Modify configuration files as below :

Edit <SPMLADAPTER\_INSTALL\_DIR>\OIM\FCUBSLOVAdService\src\webcontent\WEB-INF\web.xml. This XML file shall have a similar section as the one shown below (Change the values given in bold)

```
<resource-ref>
    <res-ref-name>OIMLOVSQA</res-ref-name>
    <res-type>javax.sql.DataSource</res-type>
    <res-auth>Container</res-auth>
</resource-ref>
<env-entry>
    <description>Property File Path</description>
    <env-entry-name>propertyPath</env-entry-name>
```

```

    <env-entry-type>java.lang.String</env-entry-type>

    <env-entry-value>D:/OIM/FCUBSLOVAdService/config/</env-entry-value>

</env-entry>

```

**Edit resource-ref section:** Mention the JNDI name of the Datasource created in Application server for FLEXCUBE UBS Messaging Database Layer Instance at step 3 as res-ref-name.

**Edit Property File Path:** Give the absolute path for lookup\_prop.xml as env-entry-value. Ideally, this file is residing in <SPMLADAPTER\_INSTALL\_DIR>\OIM\FCUBSLOVAdService\config.

**Note:** Give "/" for at the end of the path. Also, note that as separator forward slash has been used instead of backward.

Edit <SPMLADAPTER\_INSTALL\_DIR>\OIM\FCUBSLOVAdService\config\lookup\_prop.xml. This XML file shall have a similar section as the one shown below, (Change the values given in bold)

```

<!-- DataBase Connection -->

    <add key="FCUBS_CON_POOLNAME" value="OIMLOVSQA"/>

<!-- DataBase Connection -->

<add key="LOGGER_PATH"
value="D:/OIM/FCUBSLOVAdService/config/lookup_logger.xml"/>

```

**Edit FCUBS\_CON\_POOLNAME:** Give the same Datasource JNDI name mentioned in above web.xml for FLEXCUBE UBS Messaging Database Layer Instance.

**Edit LOGGER\_PATH:** Give the logging configuration absolute path for lookup\_logger.xml. This file is residing in <SPMLADAPTER\_INSTALL\_DIR>\OIM\FCUBSLOVAdService\config folder.

**Note:** As separator use forward slash instead of backward slash.

Edit <SPMLADAPTER\_INSTALL\_DIR>\OIM\FCUBSLOVAdService\config\lookup\_logger.xml. This XML file shall have a similar section as the one shown below, (Change the values given in bold)

```

<add key="ADOIM.LOGGER.FPATH" value="D:/OIM/FCUBSLOVAdService/log"/>

```

ADOIM.LOGGER.FPATH: Give the absolute path where log files will be stored. It is recommended that mention the following path <SPMLADAPTER\_INSTALL\_DIR>\OIM\FCUBSLOVAdService\log/

**Note:** As separator use forward slash instead of backward slash. Give "/" for at the end of the path.

Edit <SPMLADAPTER\_INSTALL\_DIR>\OIM\FCUBSProvisioningAdService\src\webcontent\WEB-INF\web.xml. This XML file shall have a similar section as the one shown below (Change the values given in bold)

```

<ejb-ref>

    <ejb-ref-name>GWEJB_GW_EJB_Bean</ejb-ref-name>

    <ejb-ref-type>Session</ejb-ref-type>

    <home>com.ofss.fcubs.gw.ejb.GWEJBRemoteHome</home>

```

```

    <remote>com.ofss.fcubs.gw.ejb.GWEJBRemote</remote>

</ejb-ref>

<env-entry>

    <description>Property File Path</description>

    <env-entry-name>propertyPath</env-entry-name>

    <env-entry-type>java.lang.String</env-entry-type>

    <env-entry-value>D:/OIM/FCUBSProvisioningAdService/config/</env-
entry-value>

</env-entry>

```

**Edit ejb-link:** To refer Gateway EJB from the web service locally the reference of Gateway EJB has been defined in this deployment descriptor file. Give the Gateway EJB name here as ejb-link, mentioned as ejb-name in ejb-jar.xml deployment descriptor file of Gateway EJB.

**Edit Property File Path:** Give the absolute path for ADOIM\_Prop.xml as env-entry-value. This file is residing in **<SPMLADAPTER\_INSTALL\_DIR>\OIM\FCUBSProvisioningAdService\config**.

**Note: Give "/" for at the end of the path. Also, note that as separator forward slash has been used instead of backward.**

Edit **<SPMLADAPTER\_INSTALL\_DIR>\OIM\FCUBSLOVAdService\config\ADOIM\_Prop.xml**. This XML file shall have a similar section as the one shown below, (Change the values given in bold)

```

    <add key="GW_EJB_JNDI_NAME" value="
GWEJB#com.ofss.fcubs.gw.ejb.GWEJBRemote "/>

    <add key="GW_EJB_CALL_TYPE" value="REMOTE"/>

    <add key="GW_EJB_CTX_FACTORY"
value="weblogic.jndi.WLInitialContextFactory"/>

    <add key="GW_EJB_SERVER_URL" value="t3s://localhost:7102"/>

    <add key="GW_EJB_SECURITY_PRINCIPAL" value=""/>

    <add key="GW EJB SECURITY CREDENTIALS" value=""/>

```

Edit **GW\_EJB\_JNDI\_NAME**: Give the Gateway EJB JNDI name.

Edit **GW\_EJB\_CALL\_TYPE**: Give the LOCAL or REMOTE (must be in Upper Case) based on the way EJB is to be referred from web service. If FCUBS Gateway EJB is deployed on same Weblogic Application server then it should be REMOTE.

Edit **GW\_EJB\_SERVER\_URL**: Give the application server URL where Gateway EJB is deployed.

Following are the parts that make this URL:

t3s://HostName:PortNumber



## Protocol Host Name Weblogic Port

**Protocol:** This should be t3s as in WebLogic application server.

**Server URL:** This should be the IP address or fully qualified computer name (i.e. <computer name>.<domain>) of the system where the application server is running on which Gateway EJB has been deployed.

**Port:** This should be the same as **request port** mentioned in domain.xml file.

Edit following section in the <SPMLADAPTER\_INSTALL\_DIR>\OIM\FCUBS\LOVAdService\config\ADOIM\_Prop.xml file: (Change the values given in bold )

```
<add key="MAKER_ID" value="OIMUSER9"/>

<add key="HEAD_OFFICE" value="CHO"/>

<add key="REQ_SOURCE" value="IDM"/>

<add key="UBS_OR_IS" value="FCUBS"/>

<add key="LOGGER_PATH"

value="D:/OIM/FCUBSProvisioningAdService/config/adoim_logger.xml"/>

<add key="FCUBS_SPML_ERROR_FILE"

value="D:/OIM/FCUBSProvisioningAdService/config/

FCUBS_SPML_ERROR.properties"/>

<add key="ADOIM_MSG_LOGGING_ENABLED" value="N"/>

<add key="ADOIM_MSG_LOGGING_PATH"

value="D:/OIM/FCUBSProvisioningAdService/log"/>
```

**Edit MAKER\_ID:** Give FCUBS user id that can serve as maker id for all OIM requests. Please ensure that this id should be a valid user in FCUBS and should have rights for creating, authorizing and modifying user.

**Edit HEAD\_OFFICE:** Give the head office branch code.

**Edit REQ\_SOURCE:** Give the external source name. Please ensure that maintenance of this external source has been done in FCUBS.

**Edit UBS\_OR\_IS:** Give the application name to which the user need to be provisioned. The value will be either FCUBS or FCIS.

**Edit LOGGER\_PATH:** Give the logging configuration absolute path for adoim\_logger.xml. This file is residing in <SPMLADAPTER\_INSTALL\_DIR>\OIM\FCUBSProvisioningAdService\config folder.

Edit FCUBS\_SPML\_ERROR\_FILE: Give the absolute path for fcubs\_spml\_error.properties. This file is residing in < SPMLADAPTER\_INSTALL\_DIR>\OIM\FCUBSProvisioningAdService\config folder.

**Edit ADOIM\_MSG\_LOGGING\_ENABLED:** Give 'Y' if OIM request and response message is required to be stored separately otherwise give 'N'.

**Edit ADOIM\_MSG\_LOGGING\_PATH:** Give the absolute path where OIM request–response will get stored.

Note: As separator use forward slash instead of backward slash. Give "/" for at the end of the path.

Edit <SPMLADAPTER\_INSTALL\_DIR>\OIM\FCUBSProvisioningAdService\config\adoim\_logger.xml. This XML file shall have a similar section as the one shown below, (Change the values given in bold)

```
<add key="ADOIM.LOGGER.FPATH" value="D:/OIM/FCUBSProvisioningAdService /log"/>
```

**Edit ADOIM.LOGGER.FPATH:** Give the absolute path where log files will be stored. It is recommended that mention the following path <SPMLADAPTER\_INSTALL\_DIR>/OIM/FCUBSProvisioningAdService/log/

**Note:** As separator use forward slash instead of backward slash. Give "/" for at the end of the path.

**Remark:** GW\_EJB\_SECURITY\_PRINCIPAL & GW\_EJB\_SECURITY\_CREDENTIALS can be update using <SPMLADAPTER\_INSTALL\_DIR>\OIM\FCUBSProvisioningAdService\setup\ChangePassword.bat or ChangePassword.sh

#### 5.1.4.1.4 Building the Deployment Units for WINDOWS

##### 5.1.4.1.4.1 Building FCUBSLOVAdService.ear

- Edit <SPMLADAPTER\_INSTALL\_DIR>\OIM\FCUBSLOVAdService\setup\WEBLOGIC\ build.xml to set {server\_home} entry to Weblogic Server installed directory  
Eg: D:\Middleware\wlserver\_10.3
- Open a DOS command-prompt and change directory to, D:\OIM\FCUBSLOVAdService\
- Set PATH to JDK\bin and ANT\bin in the command prompt
- Set JAVA\_HOME
- Change the directory to D:\OIM\FCUBSLOVAdService\setup\WEBLOGIC
- To execute the build file, type "ant" on the command-prompt and press enter.

Above step creates an EAR file in D:\OIM\FCUBSLOVAdService\build with the name FCUBSLOVAdService.ear

##### 5.1.4.1.4.2 Building FCUBSProvisioningAdService.ear

- Edit <SPMLADAPTER\_INSTALL\_DIR>\OIM\FCUBSProvisioningAdService\setup\WEBLOGIC\build.xml to set {server\_home} and {JAVA\_HOME} entry to Weblogic Server installed directory and JDK Installed directory.

Eg: D:\Middleware\wlserver\_10.3

C:\Program Files\java\jdk1.7.0\_51

- Change directory to, D:\OIM\FCUBSProvisioningAdService\setup\WEBLOGIC
- To execute the build file, type "ant" on the command-prompt and press enter.



Above step creates an EAR file in build D:\OIM\FCUBSProvisioningAdService folder with the name FCUBSProvisioningAdService.ear

#### 5.1.4.1.5 Building the Deployment Units for UNIX / Linux

##### 5.1.4.1.5.1 Building FCUBSLOVAdService.ear

- Modify {server\_home} entry in the build.xml to where Weblogic Server is installed ( for example /home/kernel/Middleware/wlserver\_10.3 )
- Open a UNIX shell prompt and change directory to, /home/OIM/FCUBSLOVAdService
- Set PATH environment variable with JDK/bin path and ANT\bin path in the command prompt.
- Change the directory to <SPMLADAPTER\_INSTALL\_DIR>/FCUBSLOVAdService/setup/WEBLOGIC
- To execute the build file, type “ant” on the shell prompt and press enter.

Above step creates an EAR file in /home/kernel/OIM/FCUBSLOVAdService/build folder with the name FCUBSLOVAdService.ear

##### 5.1.4.1.5.2 Building FCUBSProvisioningAdService.ear

- Edit <SPMLADAPTER\_INSTALL\_DIR>/OIM/FCUBSProvisioningAdService/setup/WEBLOGIC/build.xml to set {server\_home} entry to Weblogic Server installed directory

Eg: home/Oracle/Middleware/wlserver\_10.3

home/java/jdk1.7.0\_51

- Change directory to, /home/kernel/OIM/FCUBSProvisioningAdService/setup/WEBLOGIC
- To execute the build file, type “ant” on the command-prompt and press enter.

Above step creates an EAR file in /home/kernel/OIM/FCUBSProvisioningAdService/build folder with the name FCUBSProvisioningAdService.ear

## 5.1.4.2 Deployment

### Deploy FCUBSLOVAdService

Login to Administrative Console

Enter Weblogic administrator username/password and press Login.



Click on Deployments as shown in below screen.

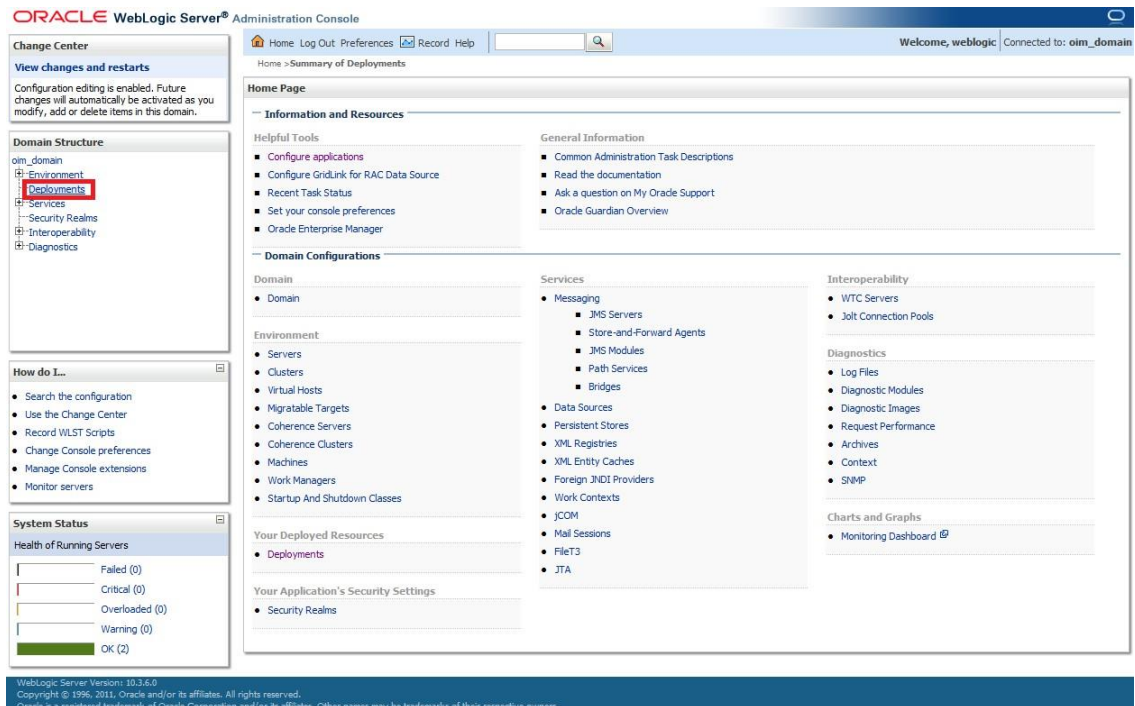

Click on the Install as shown below.

**Summary of Deployments**

This page displays a list of Java EE applications and stand-alone application modules that have been installed to this domain. Installed applications and modules can be started, stopped, updated (redeployed), or deleted from the domain by first selecting the application name and using the controls on this page.

To install a new application or module for deployment to targets in this domain, click the Install button.

**Customize this table**

**Deployments**

Install Update Delete Start Stop

Name	State	Health	Type	Deployment Order
adf.oracle.businesseditor(1.0,11.1.1.2.0)	Active		Library	100
adf.oracle.domain(1.0,11.1.1.2.0)	Active		Library	100
adf.oracle.domain.webapp(1.0,11.1.1.2.0)	Active		Library	100
AqAdapter	Active	OK	Resource Adapter	324
b2bui	Active	OK	Enterprise Application	313
composer	Active	OK	Enterprise Application	315
DbAdapter	Active	OK	Resource Adapter	322
DefaultToDoTaskFlow	Active	OK	Enterprise Application	314
DMS Application (11.1.1.1.0)	Active	OK	Web Application	5
mem	Active	OK	Enterprise Application	400

Showing 1 to 10 of 90 Previous Next

The following screen is displayed.

a. Click on upload your file(s)

**Install Application Assistant**

Back Next Finish Cancel

**Locate deployment to install and prepare for deployment**

Select the file path that represents the application root directory, archive file, exploded archive directory, or application module descriptor that you want to install. You can also enter the path of the application directory or file in the Path field.

**Note:** Only valid file paths are displayed below. If you cannot find your deployment files, upload your file(s) and confirm that your application contains the required deployment descriptors.

**Path:** /scratch/app/sso1123/wl1036/NI/Middleware/user\_projects/domains/oim\_domain

**Recently Used Paths:** (none)

**Current Location:** ofis220223.in.oracle.com / scratch / app / sso1123 / wl1036 / NI/Middleware / user\_projects / domains / oim\_domain

- bin
- config
- servers
- soa
- sysman

Back Next Finish Cancel

Choose the enterprise archive file from the build path:

<SPMLADAPTER\_INSTALL\_DIR>\OIM\FCUBSLOVAdService\build\

a. Click on Next

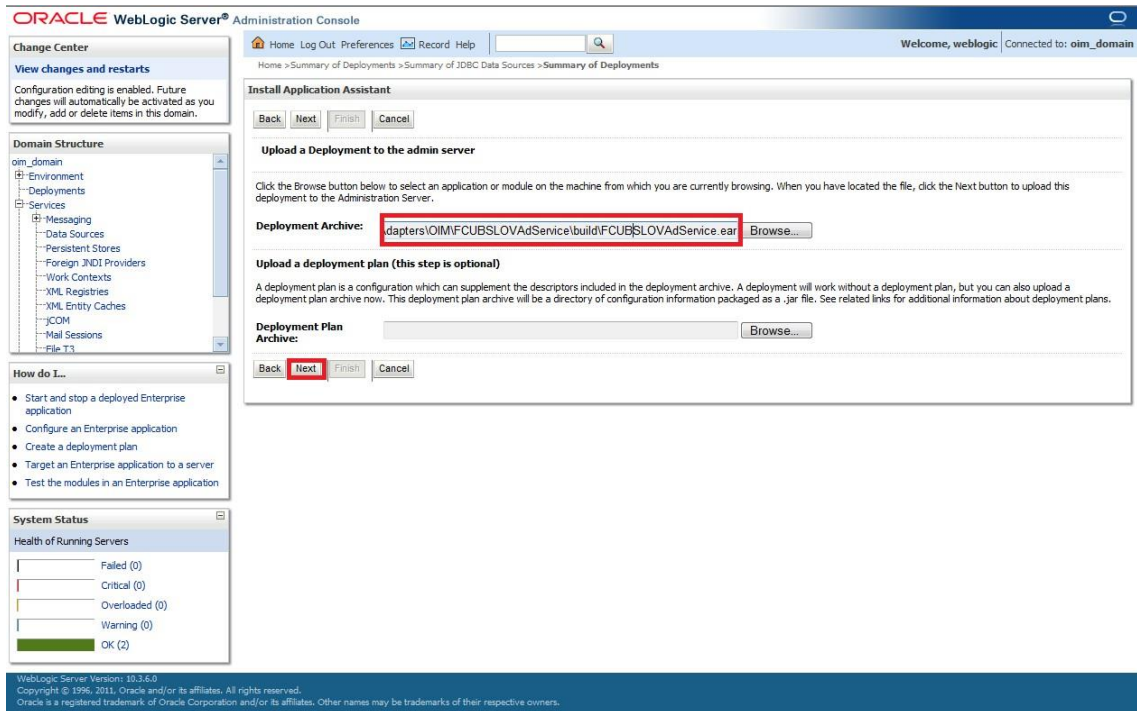

Select the enterprises archive file FCUBSLOVAdService.ear

- a. Click on Next

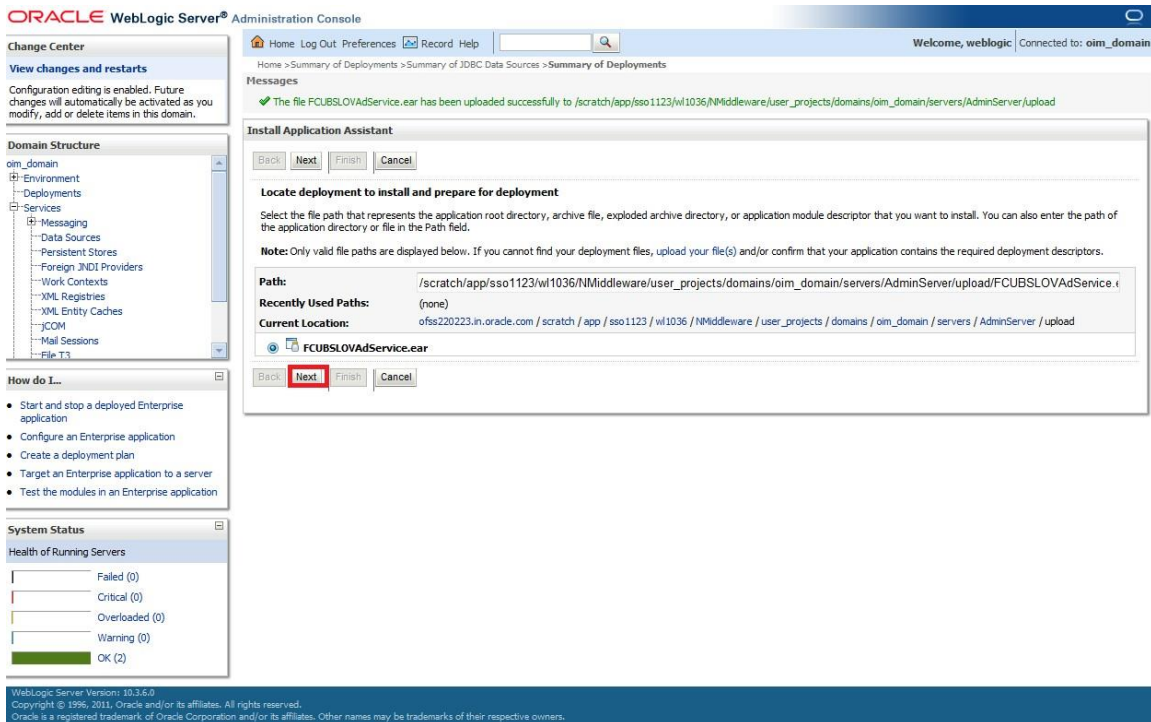

The following screen is displayed.

- a. Select – Install this deployment as an application.
- b. Click on Next.

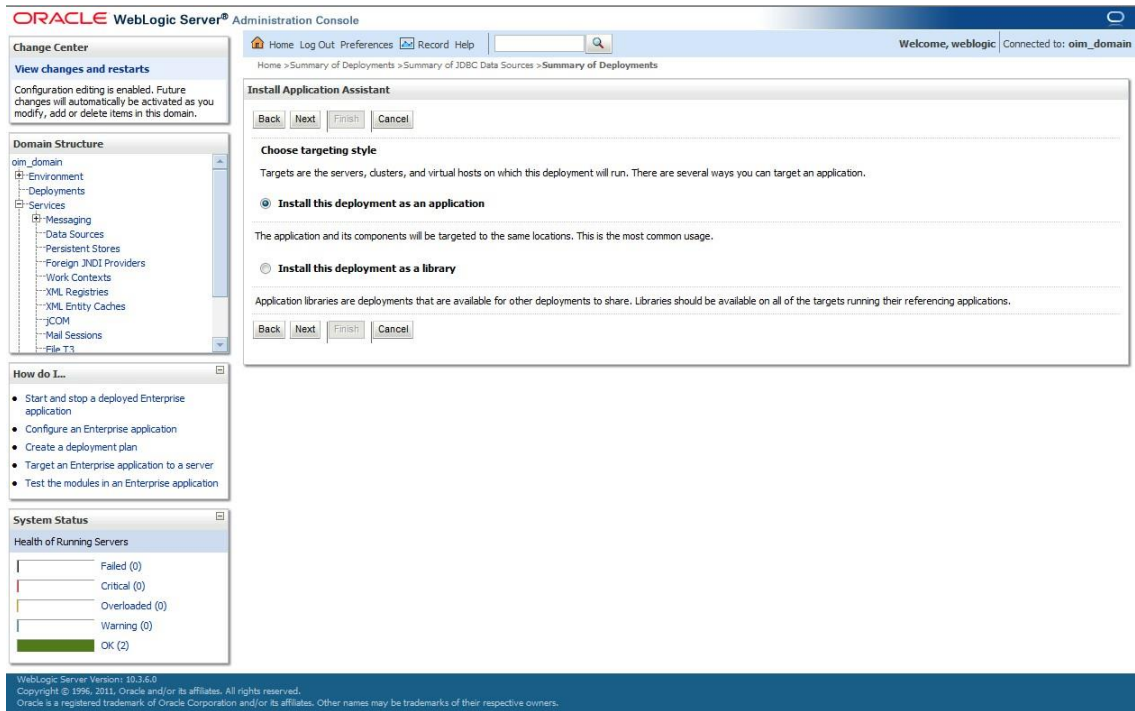

The following screen is displayed.

- a. Select the Application Server Instance in which the FCUBSLOVAdService needs to be deployed.
- b. Click on Next.

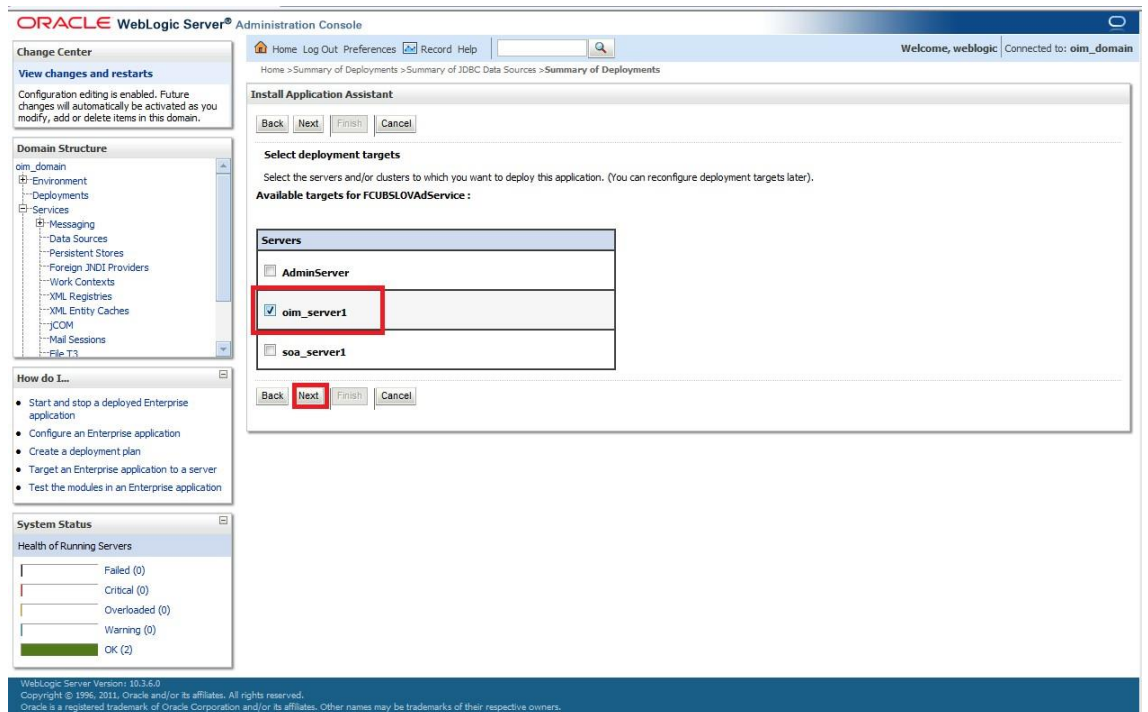



The following screen is displayed.

b. Click on Finish.

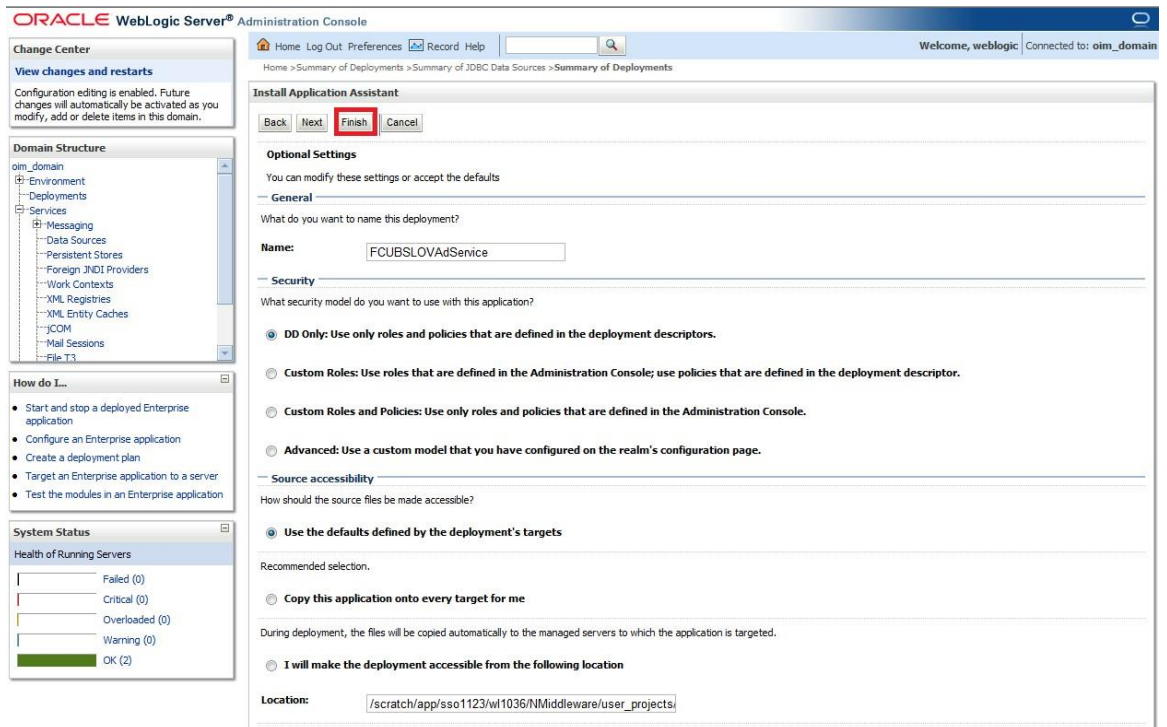

## Deploy FCUBSProvisioningAdService

If the **GW\_EJB\_CALL\_TYPE** is set as **REMOTE** in the **ADOIM\_Prop.xml** then follow the same step as above (Section 5.1.4.2.1) to deploy the FCUBSProvisioningAdService web service with following changes

- Select the ear file from the path <SPMLADAPTER\_INSTALL\_DIR>\OIM\FCUBSProvisioningAdService\build\FCUBSProvisioningAdService.ear
- Give the application name as FCUBSProvisioningAdService.

If the **GW\_EJB\_CALL\_TYPE** is set as **REMOTE** in the **ADOIM\_Prop.xml**, follow the below steps

The following screen is displayed.

1. Make sure that Gateway EJB bean has been deployed there as shown in below screen shot.

ORACLE WebLogic Server® Administration Console

Home Log Out Preferences Record Help Welcome, weblogic Connected to: oim\_domain

Home > Summary of Deployments > Summary of JDBC Data Sources > Summary of Deployments > GWEJB > Summary of Deployments > GWEJB > Summary of JDBC Data Sources > Summary of Deployments

### Summary of Deployments

Control Monitoring

This page displays a list of Java EE applications and stand-alone application modules that have been installed to this domain. Installed applications and modules can be started, stopped, updated (redeployed), or deleted from the domain by first selecting the application name and using the controls on this page.

To install a new application or module for deployment to targets in this domain, click the Install button.

Customize this table

#### Deployments

Install Update Delete Start Stop Showing 11 to 20 of 92 Previous Next

Name	State	Health	Type	Deployment Order
emai	Active		Library	100
emas	Active		Library	100
emcore	Active		Library	100
FCUBSLOVAdService	Active	OK	Enterprise Application	100
FileAdapter	Active	OK	Resource Adapter	321
FMW Welcome Page Application (11.1.0.0.0)	Active	OK	Enterprise Application	5
FtpAdapter	Active	OK	Resource Adapter	325
GWEJB	Active	OK	Enterprise Application	100
Modules				
GW_EJB_Bean.jar			EJB Module	
EJBs				
GWEJB_GW_EJB_Bean			EJB	
Web Services				
None to display				

Refer 5.1.4.2.1 to know more about the deployment steps.

2. Choose the enterprise archive file Path from the build path:

<SPMLADAPTER\_INSTALL\_DIR>\OIM\FCUBSProvisioningAdService\build\

3. Select the enterprises archive file FCUBSProvisioningAdService.ear

4. Click on Finish.

ORACLE WebLogic Server® Administration Console

Home Log Out Preferences Record Help Welcome, weblogic Connected to: oim\_domain

Home > Summary of Deployments > Summary of JDBC Data Sources > Summary of Deployments > GWEJB > Summary of Deployments > GWEJB > Summary of JDBC Data Sources > Summary of Deployments

### Install Application Assistant

Back Next Finish Cancel

#### Optional Settings

You can modify these settings or accept the defaults

##### General

What do you want to name this deployment?

Name: FCUBSProvisioningAdService

##### Security

What security model do you want to use with this application?

DD Only: Use only roles and policies that are defined in the deployment descriptors.

Custom Roles: Use roles that are defined in the Administration Console; use policies that are defined in the deployment descriptor.

Custom Roles and Policies: Use only roles and policies that are defined in the Administration Console.

Advanced: Use a custom model that you have configured on the realm's configuration page.

##### Source accessibility

How should the source files be made accessible?

Use the defaults defined by the deployment's targets

Recommended selection:

Copy this application onto every target for me

During deployment, the files will be copied automatically to the managed servers to which the application is targeted.

I will make the deployment accessible from the following location

Location: /scratch/app/sso1123/wl1036/NMiddleware/user\_projects

### 5.1.5 **Build GWEJB**

To execute the FCUBS Installer for GWEJB build following folder/files should be created/copied at **\ADAPTERS\OIM\FCUBSGW** along with the compiled sources.

- MAIN (Blank folder)
- FCHome.ini (copy from OSDG sources, file will be present at parallel to ADAPTERS folder)

After this GWEJB ear can be build with the source location as **\ADAPTERS\OIM\FCUBSGW** .

For GWEJB build kindly refer the doc **Gateway\_EAR\_Building.doc** .

Deploy the created GWEJB ear in OIM server.

### 5.1.6 **OIM Setup**

**Prerequisite:** Oracle Identity Server & Oracle Design Console.

OIM side setup should be done on the system where OIM server is running. This setup includes

Java code deployment of OIM's pre-populate adapter, entity adapter and schedule task & importing integration specific configuration files into OIM.

The following steps to be followed to do the initial environment setup:

#### 5.1.6.1 **Copy following folders from the FCUBS Software Release area**

- <FCUBS Release Name>\ADAPTERS\OIM\OIM-Config
- <FCUBS RELEASE NAME>\ADAPTERS\OIM\setup

to local machine (say D:\OIM for WINDOWS or /home/kernel/OIM for UNIX).

#### 5.1.6.2 **Building the Lookup Search Scheduled Task deployment units for WINDOWS.**

- Change directory to, D:\OIM\OIM-Config\Sch-Task\setup
- Modify the OIM\_SERVER\_INSTALL\_DIR entry in the build.xml to where OIM Server is installed ( for example D:\Oracle\Middleware\weblogic\Oracle\_IDM1) and JAVA\_HOME entry.
- In the below section of build.xml change the WSDL location hostname and port.

```
<exec executable="{JAVA_HOME}/bin/wsimport">  
  
<arg line="-keep -p com.iflex.fcubs.integration.oim.ws.client http://  
<hostname>:<port>/FCUBSLOVAdService/FCUBSLOVAdServiceSEI?WSDL"/>  
  
</exec>
```

- To execute the build file, type "ant" on the command-prompt and press enter.

Above step creates a JAR file in D:\OIM\OIM-Config\Sch-Task\build\ FCUBSLOV SchTask folder with the name **FCUBSLOV SchTask.Jar**

- Copy this FCUBSLOV SchTask.Jar to the <OIM\_SERVER\_INSTALL\_DIR>\server\ScheduleTask folder and <OIM\_SERVER\_INSTALL\_DIR>\server\apps\oim.ear\APP-INF\lib

#### 5.1.6.3 **Building the Lookup Search Scheduled Task deployment units for UNIX**

- Change directory to /home/kernel/OIM/OIM-Config/Sch-Task/setup
- Modify the OIM\_SERVER\_INSTALL\_DIR entry in the build.xml to where OIM Server is installed ( for example /Oracle/Middleware/weblogic/Oracle\_IDM1 ) and JAVA\_HOME entry.
- In the below section of build.xml change the WSDL location hostname and port.



```

<exec executable="{JAVA_HOME}/bin/wsimport">

<arg line="-keep -p com.iflex.fcubs.integration.oim.ws.client
http://<hostname>:<port>/FCUBSLOVAdService/FCUBSLOVAdServiceSEI?WSDL"/>

</exec>

```

- To execute the build file, type “ant” on the shell and press enter.

Above step creates a JAR file in /home/kernel/OIM/OIM-Config/Sch-Task/build/FCUBSLOVSchTask folder with the name **FCUBSLOVSchTask.Jar**

- Copy this FCUBSLOVSchTask.Jar to the <OIM\_SERVER\_INSTALL\_DIR>/server/ScheduleTask folder and <OIM\_SERVER\_INSTALL\_DIR>/server/apps/oim.ear/APP-INF/lib

#### 5.1.6.4 Deployment of Pre-population Adapters

Below Steps will be valid In case of different name used to create the form in [5.1.5.35](#)

- Change the directory to

```
<AdapterSource>/OIM/OIM-Config/PrePopulateAdapter
```

- Edit the plugin.xml and update the FlexcubeForm into the form name entered in [5.1.5.35](#)

```

<?xml version="1.0" encoding="UTF-8" ?>

<oimplugins xmlns:xsi="http://www.w3.org/2001/XMLSchema-instance">

<plugins pluginpoint="oracle.iam.request.plugins.PrePopulationAdapter">

<plugin pluginclass="com.oracle.oim.utility.eventhandler.UserIDPrepopulateAdapter" version="1.0"

        name="UserIDPrepopulateAdapter">

<metadata name="PrePopulationAdapater">

<value>FlexcubeForm::USERID</value>

</metadata>

</plugin>

<plugin pluginclass="com.oracle.oim.utility.eventhandler.UserNamePrepopulateAdapter" version="1.0"

        name="UserNamePrepopulateAdapter">

<metadata name="PrePopulationAdapater">

<value>FlexcubeForm::USERNAME</value>

</metadata>

</plugin>

<plugin pluginclass="com.oracle.oim.utility.eventhandler.UserPasswordPrepopulateAdapter" version="1.0"

        name="UserPasswordPrepopulateAdapter">

<metadata name="PrePopulationAdapater">

<value>FlexcubeForm::USERPASSWORD</value>

```

```

</metadata>

</plugin>

<plugin pluginclass="com.oracle.oid.utility.eventhandler.EmailPrepopulateAdapter" version="1.0"
    name="EmailPrepopulateAdapter">
    <metadata name="PrePopulationAdapater">
        <value>FlexcubeForm::EMAIL</value>
    </metadata>
</plugin>

<plugin pluginclass="com.oracle.oid.utility.eventhandler.LdapUserPrepopulateAdapter" version="1.0"
    name="LdapUserPrepopulateAdapter">
    <metadata name="PrePopulationAdapater">
        <value>FlexcubeForm::LDAPUSR</value>
    </metadata>
</plugin>

<plugin pluginclass="com.oracle.oid.utility.eventhandler.StartDatePrepopulateAdapter" version="1.0"
    name="StartDatePrepopulateAdapter">
    <metadata name="PrePopulationAdapater">
        <value>FlexcubeForm::STARTDATE</value>
    </metadata>
</plugin>
</plugins>

<plugins pluginpoint="oracle.iam.platform.kernel.spi.EventHandler">
    <plugin pluginclass="com.oracle.oid.utility.eventhandler.UserPasswordPreProcessHandler" version="1.0"
        name="UserPasswordPreProcessHandler"></plugin>
</plugins>
</oimplugins>

```

- Change the directory to

```
<AdapterSource>/OIM/OIM-Config/PrePopulateAdapter /setup
```

- Modify the OIM\_SERVER\_INSTALL\_DIR entry in the build.xml to where OIM Server is installed (for example D:\Oracle\Middleware\weblogic\Oracle\_IDM1) and JAVA\_HOME entry
  - To execute the build file, type “ant” on the shell and press enter.

Above step creates a zip file in <AdapterSource>/OIM/OIM-Config/PrePopulateAdapter/build/ folder with the name **prepopulateadapter.zip**

- Copy the <AdapterSource>/OIM/OIM-Config/PrePopulateAdapter/build/prepopulateadapter.zip into <OIM\_SERVER\_INSTALL\_DIR>/server/plugins/

- <OIM\_SERVER\_INSTALL\_DIR>/server/plugin\_utility/ant.properties should be changed from

```
#####
## The installation directory for WLS or WAS
#####
#wls.home=@wls_home
#was.home=@was_home

#####
# The OIM server directory for OIM. For example: MW_HOME/Oracle_IDM1/server
#####
#oim.home@oim_home

#####
#login file name with path for WAS or WLS
#####
#login.config=${oim.home}/config/authwl.conf
#login.config=${oim.home}/config/authws.conf

#####
# Represents the directory where Oracle Fusion Middleware is installed.
#####
#mw.home=@mw_home
```

To

```
#####
## The installation directory for WLS or WAS
#####
wls.home=<Installation_DIR>/Middleware/wlserver_10.3
#was.home=@was_home

#####
# The OIM server directory for OIM. For example: MW_HOME/Oracle_IDM1/server
#####
oim.home=<OIM_INSTALLATION_DIR>/server/
```

```
#####

#login file name with path for WAS or WLS

#####

login.config=${oim.home}/config/authwl.conf

#login.config=${oim.home}/config/authws.conf

#####

# Represents the directory where Oracle Fusion Middleware is installed.

#####

mw.home=<Installation_DIR>/Middleware
```

- Set the ANT\_HOME & JAVA\_HOME
  - In Command Prompt / SHELL type the below command and Press Enter
  - ant -f pluginregistration.xml register
  - Following Information has to be provided
    - OIM Admin User – xelsysadm
    - OIM Admin User – Password
    - OIM Admin server URL : t3://hostname:portname
    - Full path of adapter which needs to be imported
- <OIM\_SERVER\_INSTALL\_DIR>/server/plugins/prepopulateadapter.zip
- Result will be displayed like

Plugin com.oracle.oim.utility.eventhandler.LdapUserPrepopulateAdapter version 1.0 Registered

Plugin com.oracle.oim.utility.eventhandler.UserIDPrepopulateAdapter version 1.0 Registered

Plugin com.oracle.oim.utility.eventhandler.StartDatePrepopulateAdapter version 1.0 Registered

Plugin com.oracle.oim.utility.eventhandler.UserNamePrepopulateAdapter version 1.0 Registered

Plugin com.oracle.oim.utility.eventhandler.UserPasswordPrepopulateadapter version 1.0 Registered

Plugin com.oracle.oim.utility.eventhandler.EmailPrepopulateAdapter version 1.0 Registered

Plugin com.oracle.oim.utility.eventhandler.UserPasswordPreProcessHandler version 1.0 Registered

- Modify the weblogic.properties under < OIM\_SERVER\_INSTALL\_DIR >/server/bin

```
wls_servername=@servername

application_name=@appname

metadata_from_loc=@metadata_from_loc
```

to

```
wls_servername=oim_server1

application_name=OIMMetadata
```

- Type **sh weblogicImportMetadata.sh** in shell or **weblogicImportMetaData.bat** in command prompt and press enter to execute the command.
- You have to enter Weblogic Admin Server – user name, password and URL ( like t3://localhost:7001 )
- Type **sh PurgeCache.sh all** in shell or **PurgeCache.bat all** in command prompt and press enter to execute the command.
- Now you have to enter oim admin user name ( xelsysadm ), password and oim server URL ( like t3://localhost:14000 )
- Restart the OIM Server to impact the changes done.

#### 5.1.6.5 Create folders for Reconciliation

- For reconciliation, there should be different folder for staging files (yet to be reconciled) and for processed files (after reconciliation). These folders can be anywhere that OIM should be able to access. If it is other than the OIM server system then that network path should be mapped as network drive.
- Create folder to keep staging file, for example

<OIM\_SERVER\_INSTALL\_DIR>\xellerate\GTC\Recon\Staging

- Create folder to keep processed file, for example

<OIM\_SERVER\_INSTALL\_DIR>\xellerate\GTC\Recon\Archive

#### 5.1.6.6 Importing Configuration Files

This step involves import of integration specific configuration files into OIM using OIM provided Deployment Manager.

Prerequisite: Ensure that OIM setup steps have been followed properly.

Note: Do the import in the same order as it is described below.

Open the Oracle Identity Manager Administrative console. (Give the following URL in the browser: http://<hostname>:<oimport>/sysadmin)

Login to Administrative Console

Enter OIM administrator username/password and press Sign In.

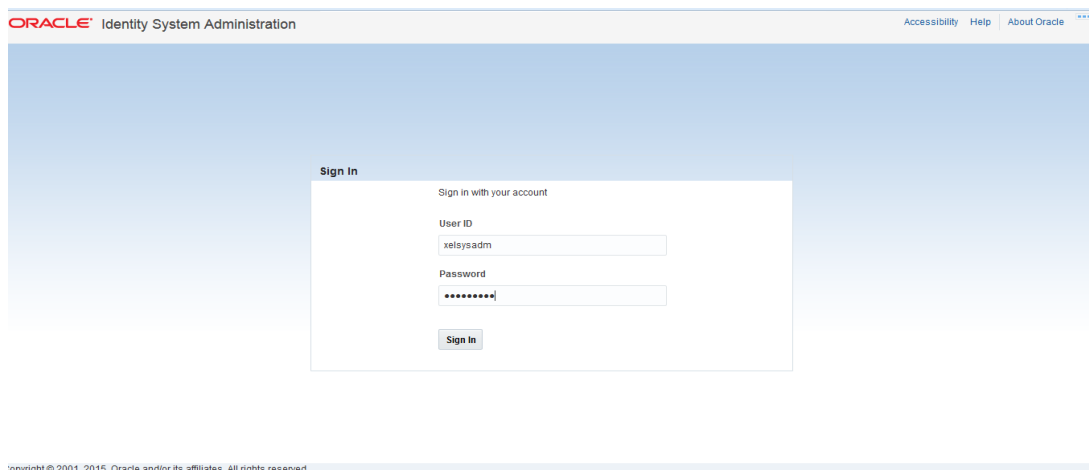

Click on Import option under System Configuration.

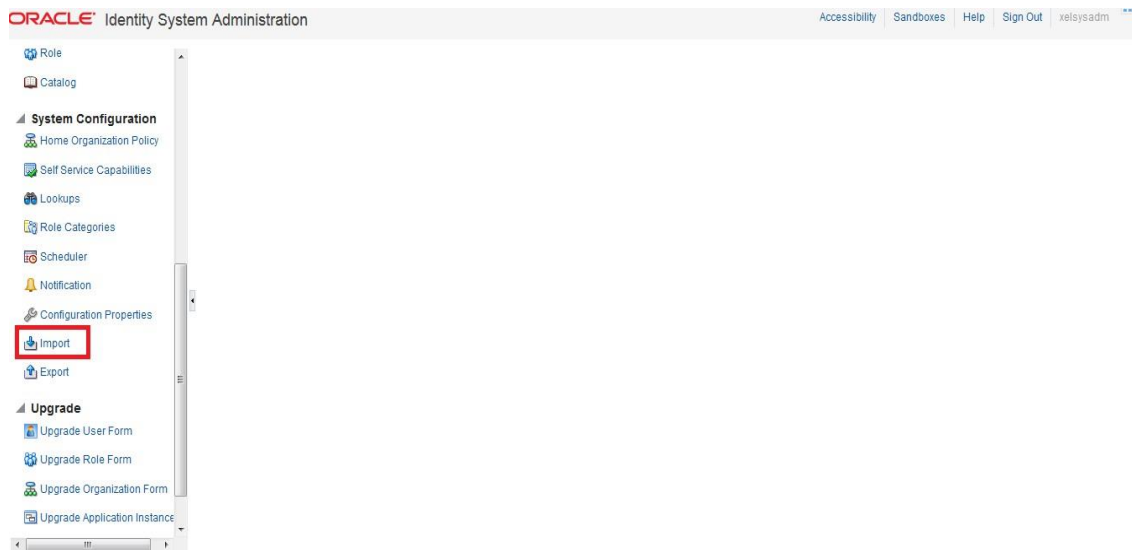

The following screen will get displayed with Add File option.

- a. Select Lookup.xml file from the folder <SPMLADAPTER\_INSTALL\_DIR>\OIM\OIM-Config\Screens-Config.
- b. Click on Open.

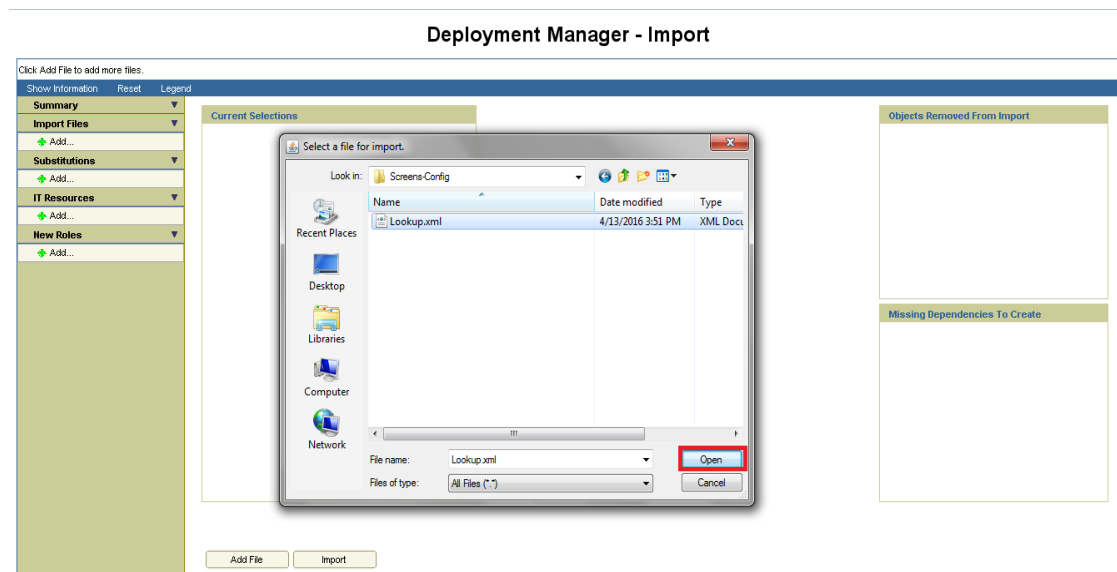

We will get File preview screen

- a. Click on Add file.

## Deployment Manager - Import

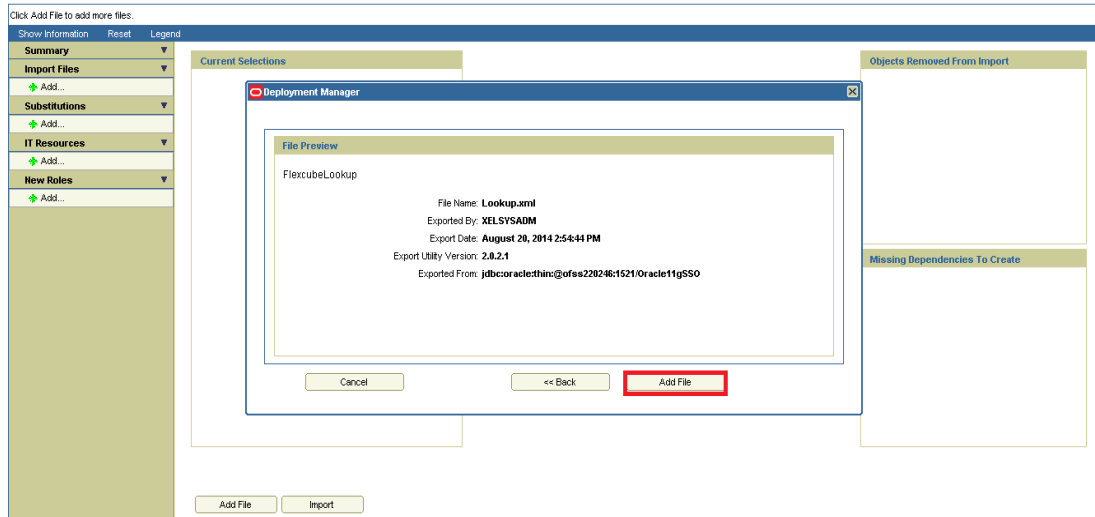

Click on Add File

## Deployment Manager - Import

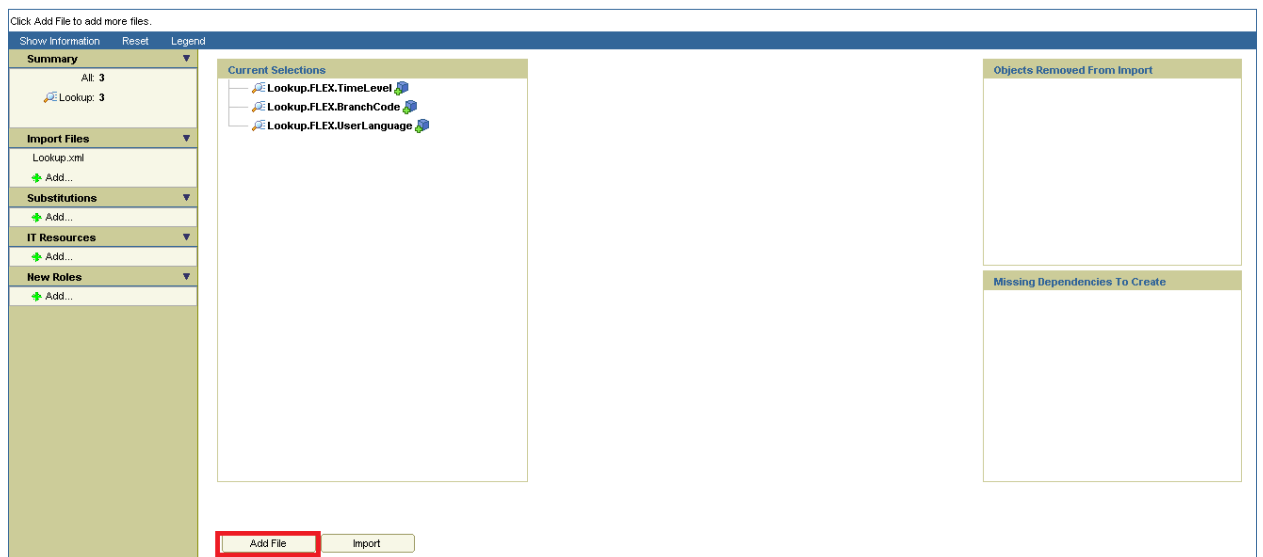

Select SchTask.xml file from the folder

<SPMLADAPTER\_INSTALL\_DIR>\OIM\OIM-Config\Sch-Tasks\Config-XML.

a. Click on Open.



## Deployment Manager - Import

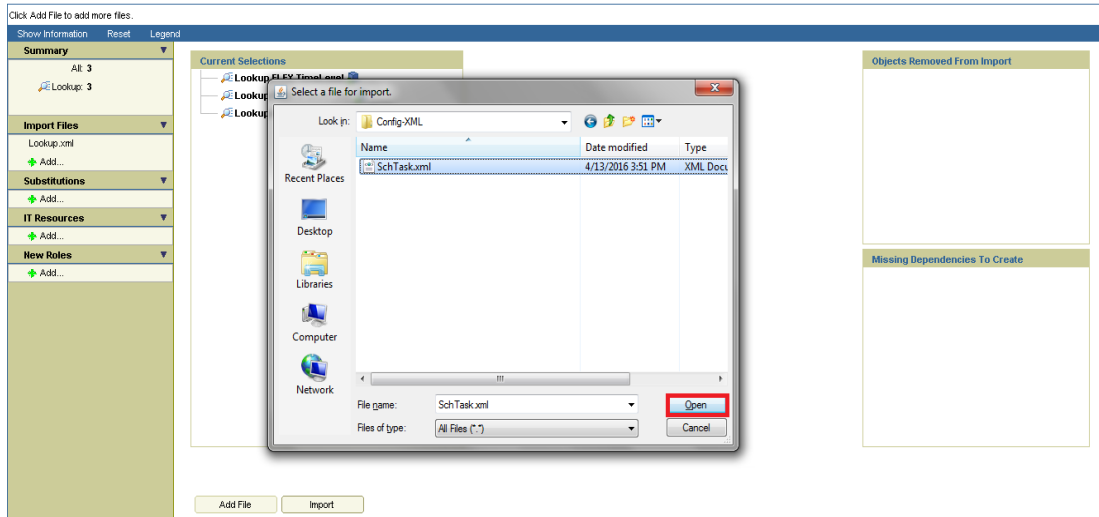

We will get File preview screen

a. Click on Add file.

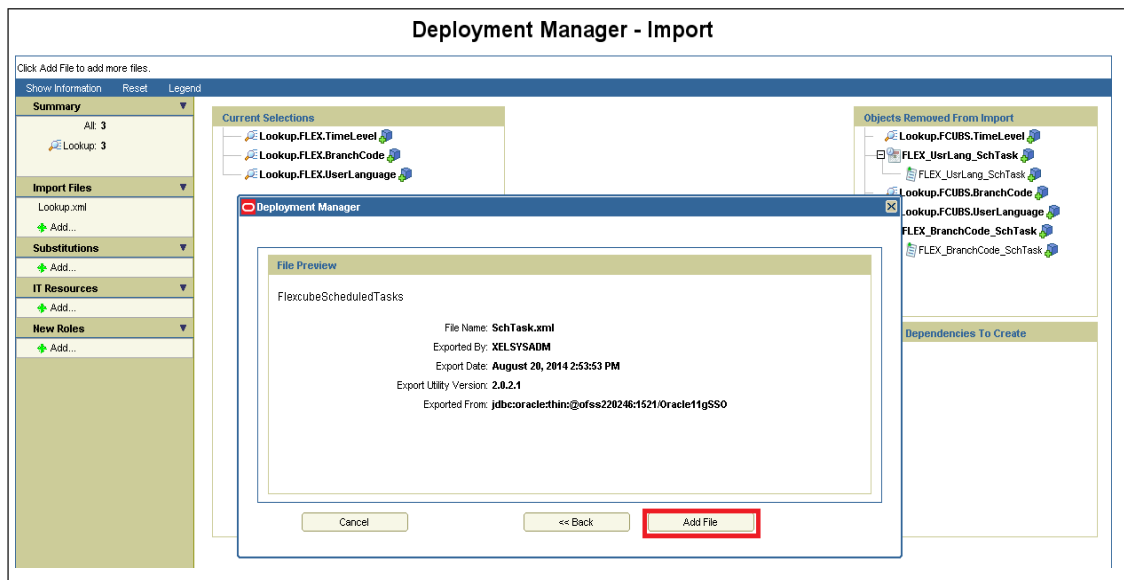

Click on Import.



Above will prompt for Import Confirmation

a. Click on Import to start import.

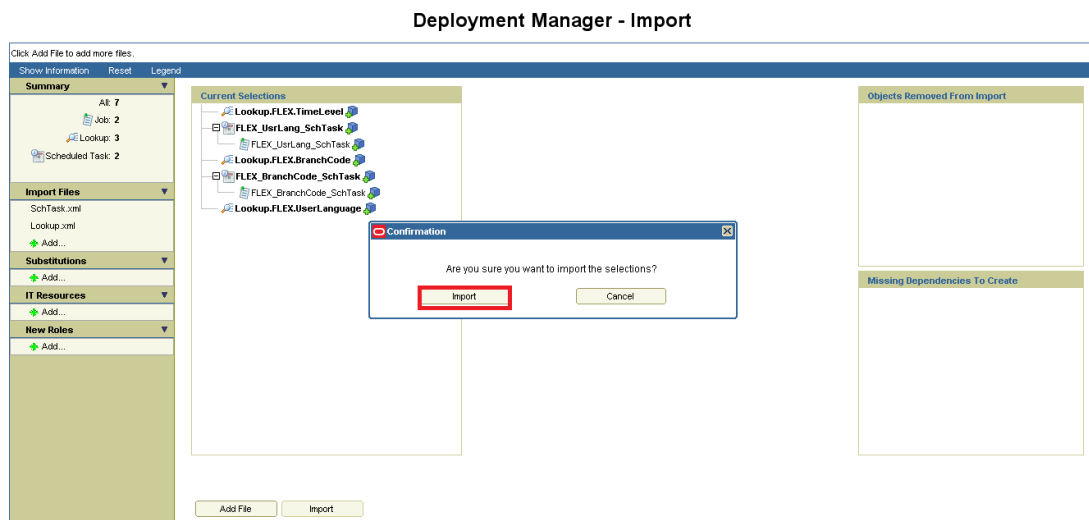

On successful import following screen will come.

- a. Ensure that import is successful and click on ok.

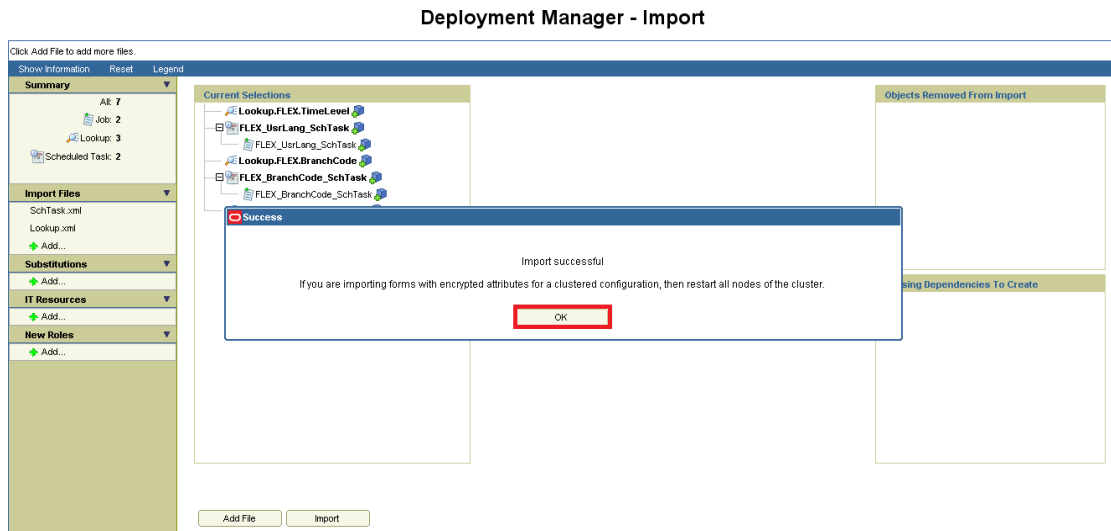

The following screen will get displayed.

- a. Click on Add File.

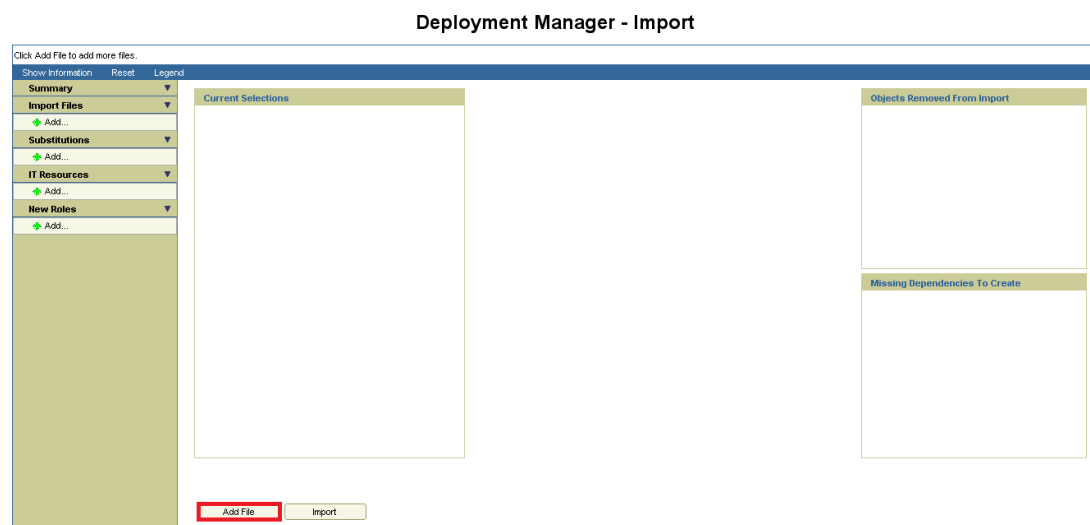

Open file window will get appeared.

- b. Select GTC.xml file from the folder <SPMLADAPTER\_INSTALL\_DIR>\OIM\OIM-Config\GTC-Config\.
- c. Click on Open.

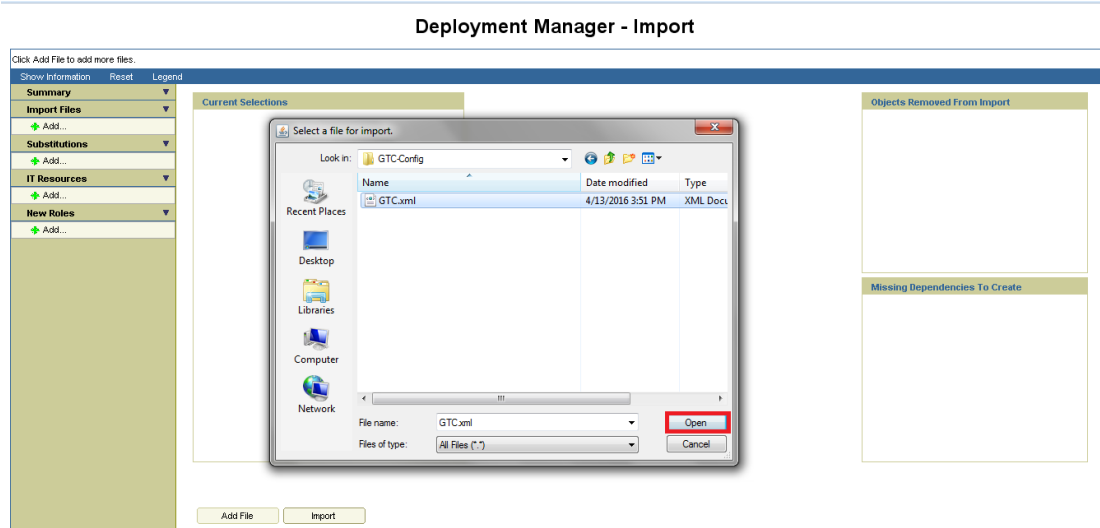

We will get File preview screen

- d. Click on Add file.

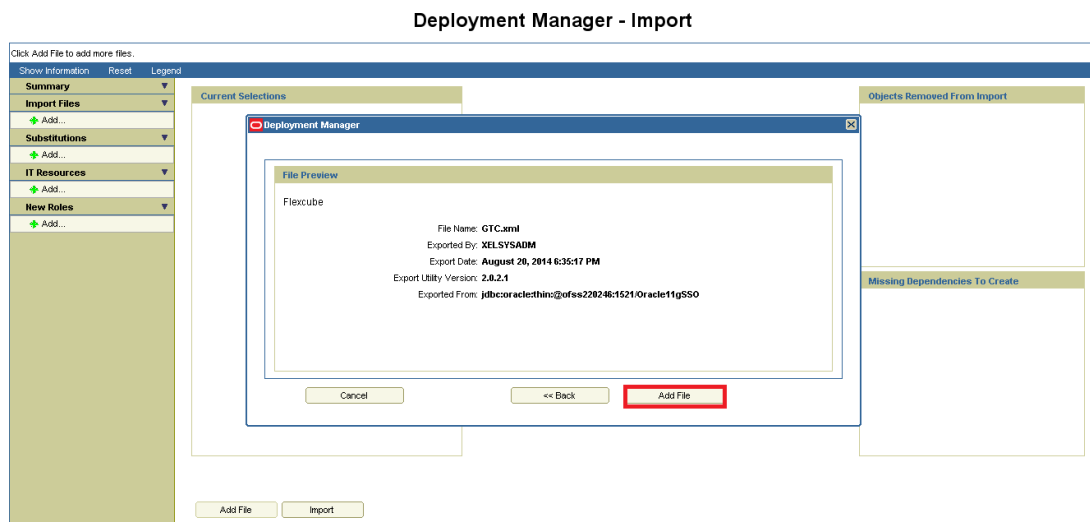

Next screen will be the substitution screen.

- e. If the GTC is imported first time then click on Next.
- f. If GTC have been already imported once successfully, change the Version name for example UD\_FLEXCUBE Version = FLEXCUBE V2.
- g. Click on Next.

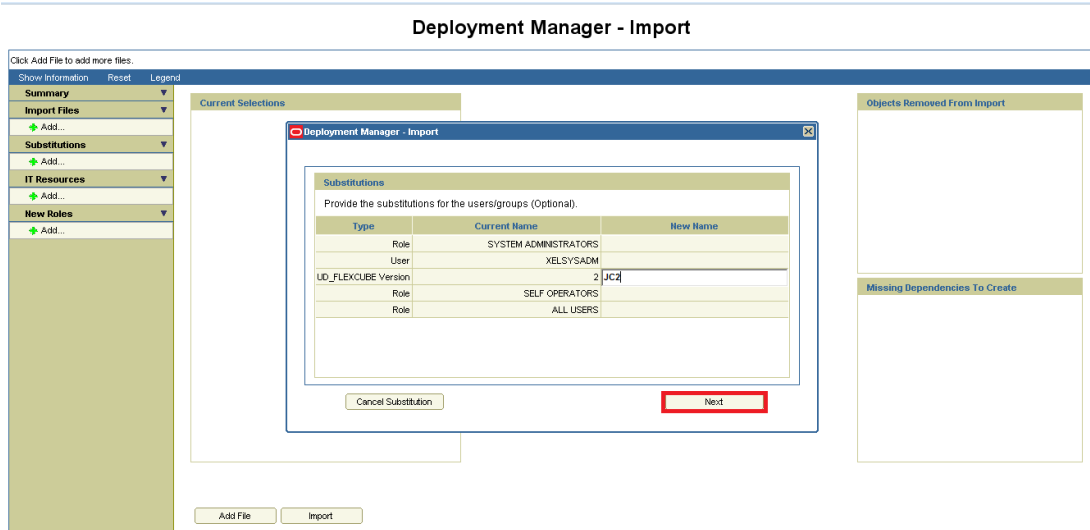

Above will prompt for substitution Confirmation

- h. If any value has been changed on previous screen it will list those substitution otherwise below screen will get displayed. Click on Next.

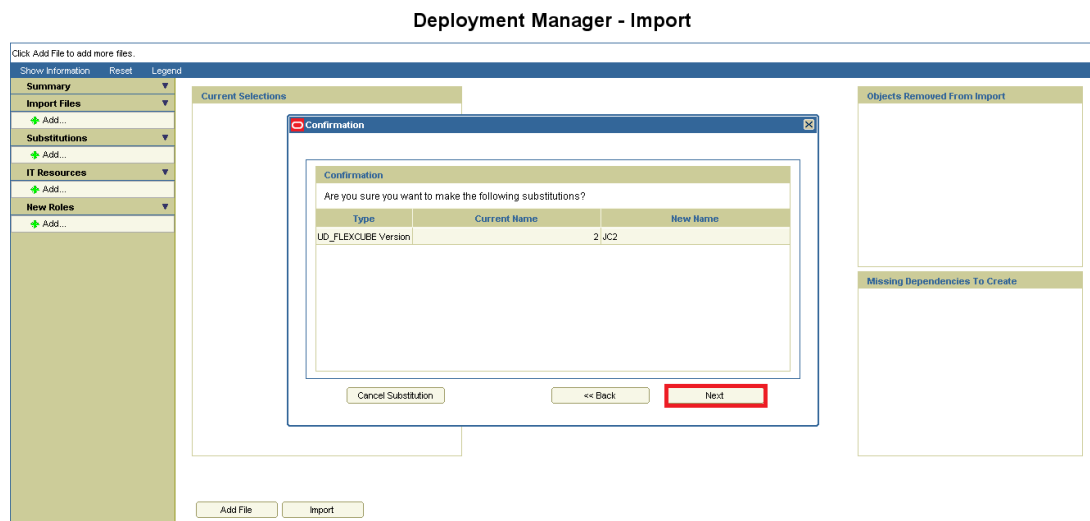

Next, Provide IT resource instance data screen will get displayed.

- i. Ensure that the green arrow should point to FLEXCUBE\_GTC.
- j. Provide followings to the right hand table:

Parameter Name	Parameter Value
SPML_targetID	FLEXCUBE
SharedDrive_filePrefix	SMOIMHOFF
SharedDrive_stageDirParent	Full path of the staging folder created in step 4 of OIM setup Eg: /home/Oracle/Oracle/Middleware/FCUBS-OIM-Config/Staging
Webservices_webserviceURL	Provisioning web service <b>FCUBSProvisioningAdService</b> URL deployed in step .Typically it should be like https://<hostName>:<port>/FCUBSProvisioningAdService/FCUBSProvisioningAdServiceSEI  Eg: https://ofss000000:14001/FCUBSProvisioningAdService/FCUBSProvisioningAdServiceSEI
SharedDrive_archiveDir	Full path of the archiving folder created in step 4 of OIM setup Eg: /home/Oracle/Oracle/Middleware/FCUBS-OIM-Config/Archive
SharedDrive_delimeter	, [Comma ]
SharedDrive_uniqueAttrParent	USERID

- k. Click on Next.

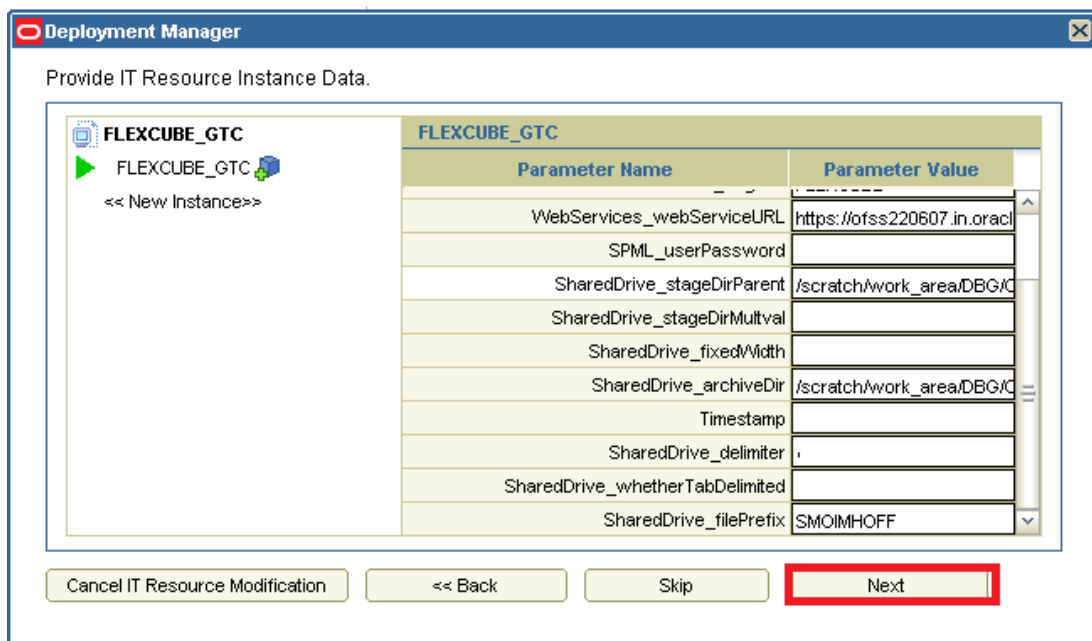
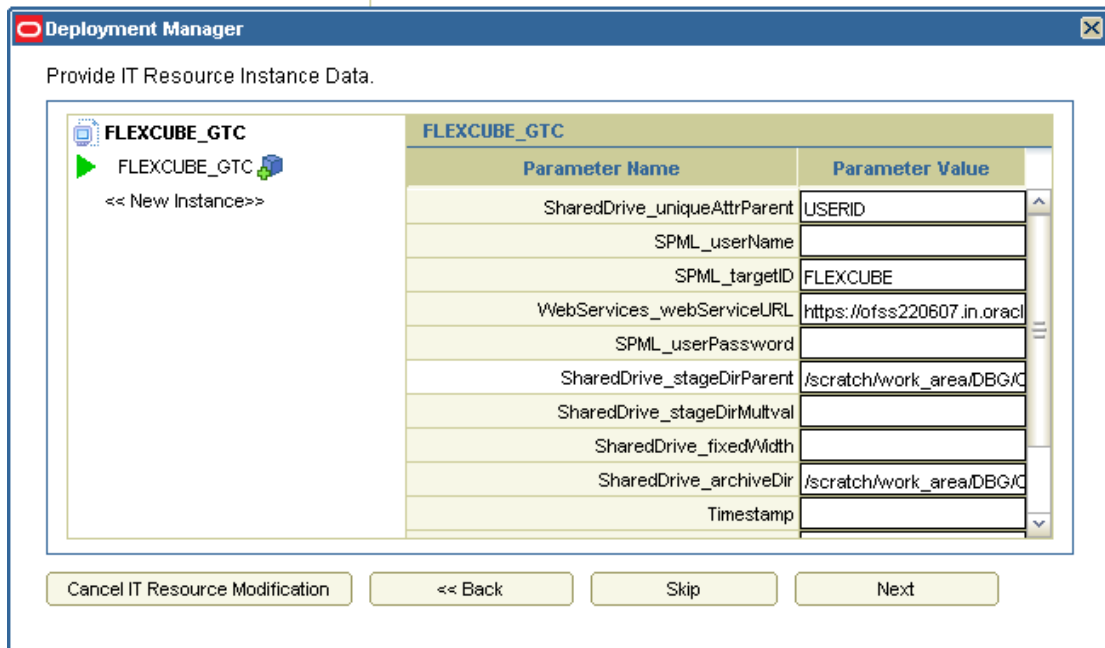



The following screen will get displayed.

- I. Click on Skip.

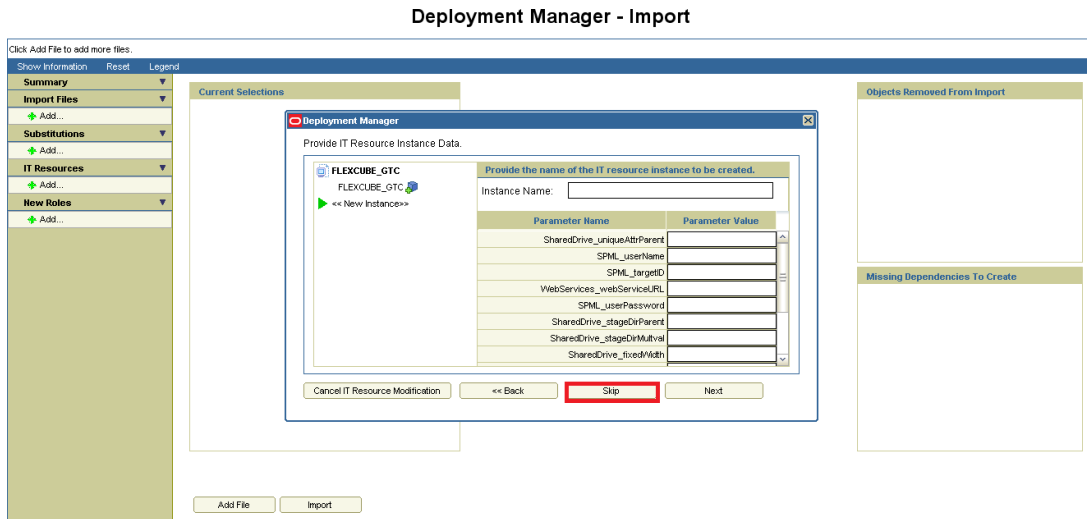

A confirmation window for parameter values will get displayed.

- m. Confirm the values and click on View Selections.

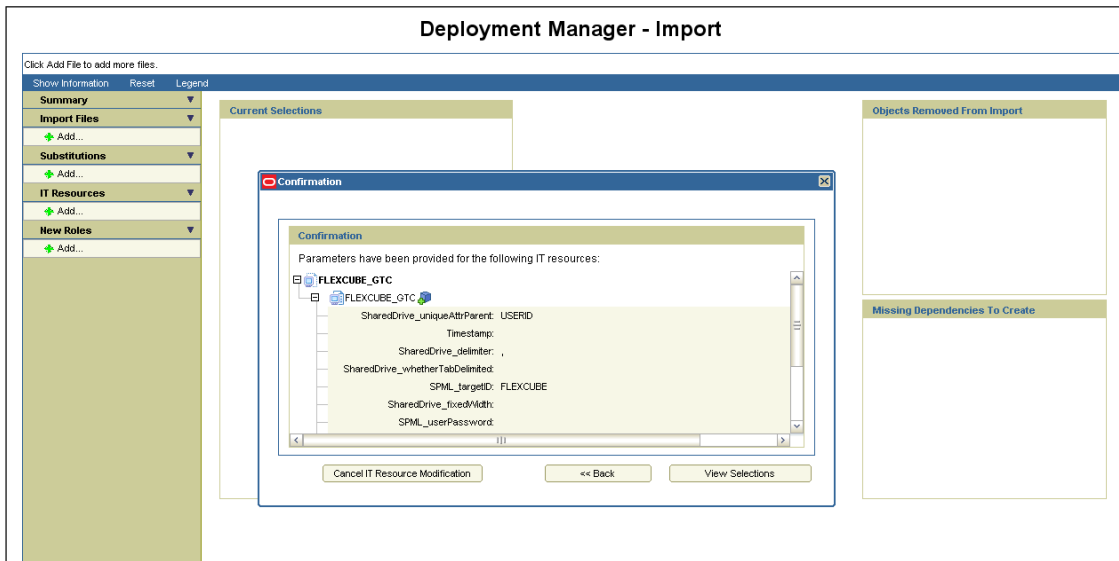

We will get Selection screen that will show all components of GTC.

- n. Make sure that there should be no items in Missing Dependencies to create box on right below of the screen. If so, probably some previous imports has been missed out or not imported successfully. Repeat the earlier imports again.
- o. Otherwise click on Import.

## Deployment Manager - Import

Click Add File to add more files.

Show Information    Reset    Legend

**Summary** Alt: 18

- IT Resource Definition: 1
- Resource: 1
- Task Adapter: 2
- Process Form: 1
- Entity Publication: 2
- Application Instance: 1
- Generic Connector: 1
- Organization: 3
- IT Resource: 1
- Password Policy: 1
- Job: 1
- Data Object Definition: 1
- Process: 1
- Scheduled Task: 1

**Import Files**

GTC.xml

+ Add...

**Substitutions**

+ Add...

**IT Resources**

FLEXCUBE\_GTC (FLEXCUBE\_GT

< | | | >

**New Roles**

**Current Selections**

- FLEXCUBE\_GTC
  - FLEXCUBE\_GTC
  - FLEXCUBE\_GTC
  - FLEXCUBE\_GTC
  - FLEXCUBE\_GTC
  - adpFLEXCUBE\_GTC\_AUTOC
  - UD\_FLEXCUBE\_GTC
  - adpFLEXCUBE\_GTC
  - FLEXCUBE\_GTC
  - ApplicationInstance2
    - Top
    - Default Policy
    - Xellerate Users
    - Requests
  - ApplicationInstance3
    - Requests
  - FLEXCUBE\_GTC
  - FLEXCUBE\_GTC
  - ApplicationInstance2
    - Top
    - Default Policy

**Objects Removed From Import**

**Missing Dependencies To Create**

Add File    Import

Above will prompt for Import Confirmation

p. Click on Import to start import.

### Deployment Manager - Import

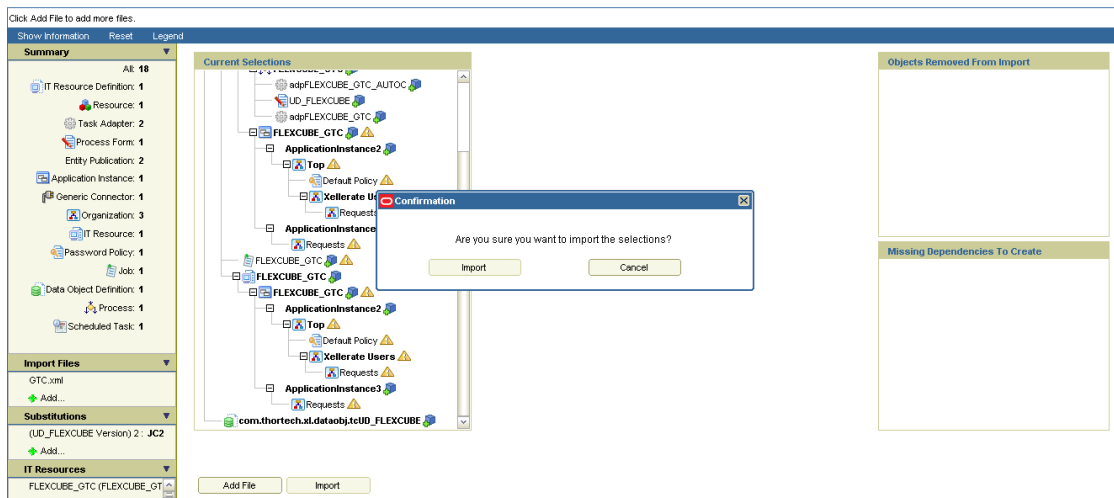

**Note:** Import of GTC.xml may take more time as compare to other imports.

On successful import following screen will come.

q. Ensure that import is successful and click on ok.

### Deployment Manager - Import

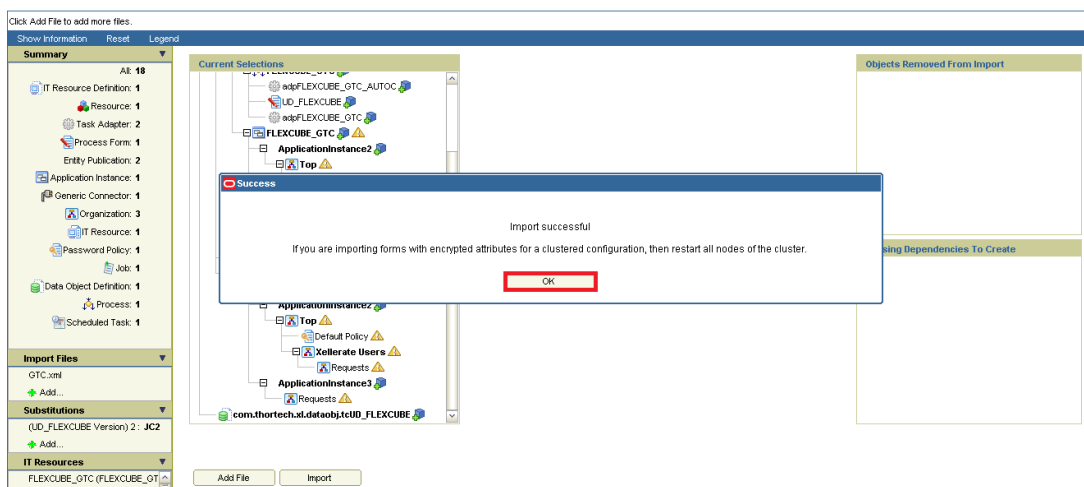

Click on Sandboxes.



Click on Create Sandbox.

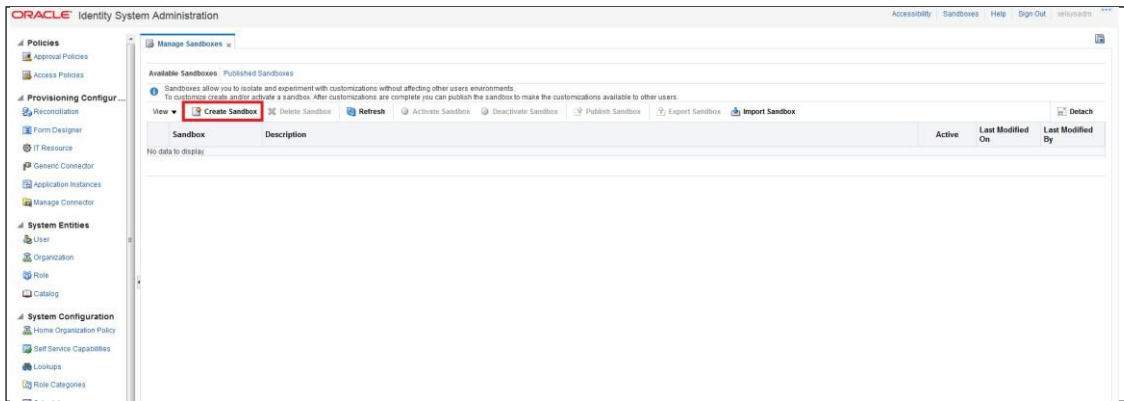

Enter the Below Details and Click on Save and Close.

- r. Sandbox Name : FlexcubeSandbox
- s. Sandbox Description : FlexcubeSandbox

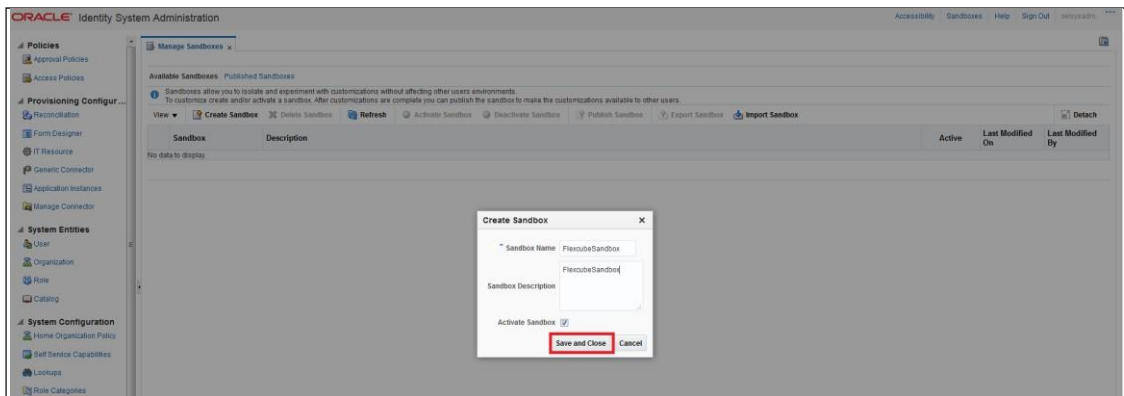

Click on Ok.

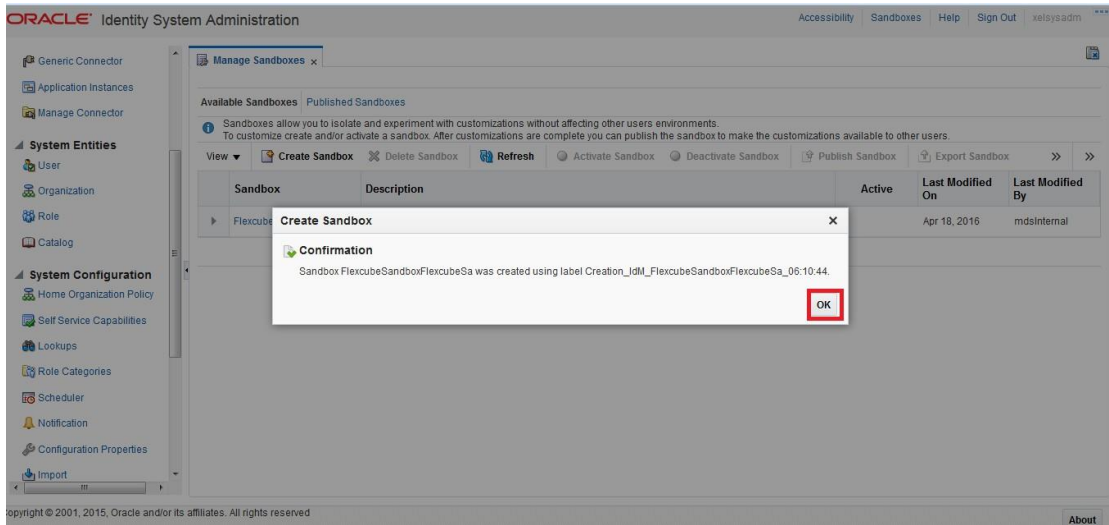

Click on Form Designer under Provisioning Configuration.

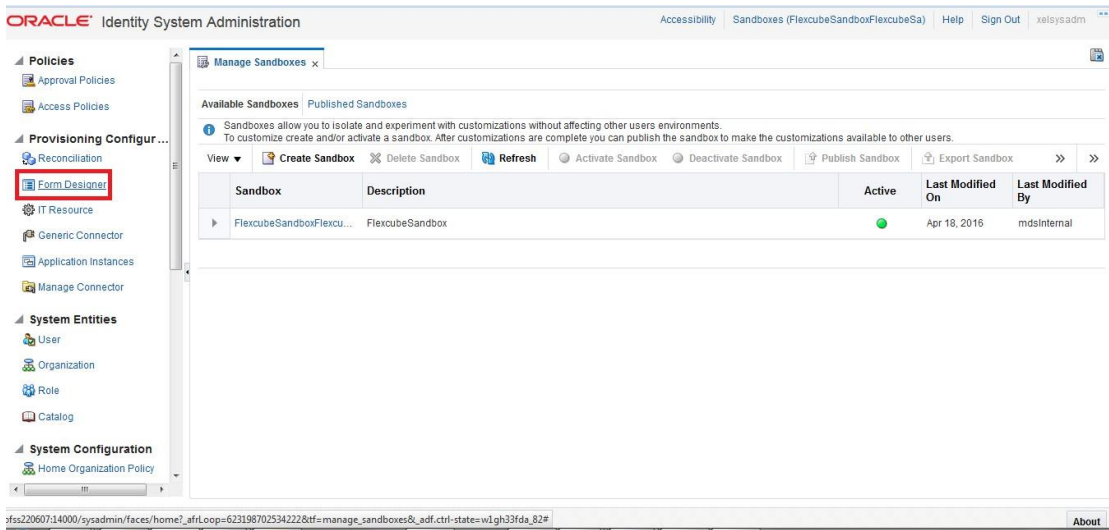

Click on Create

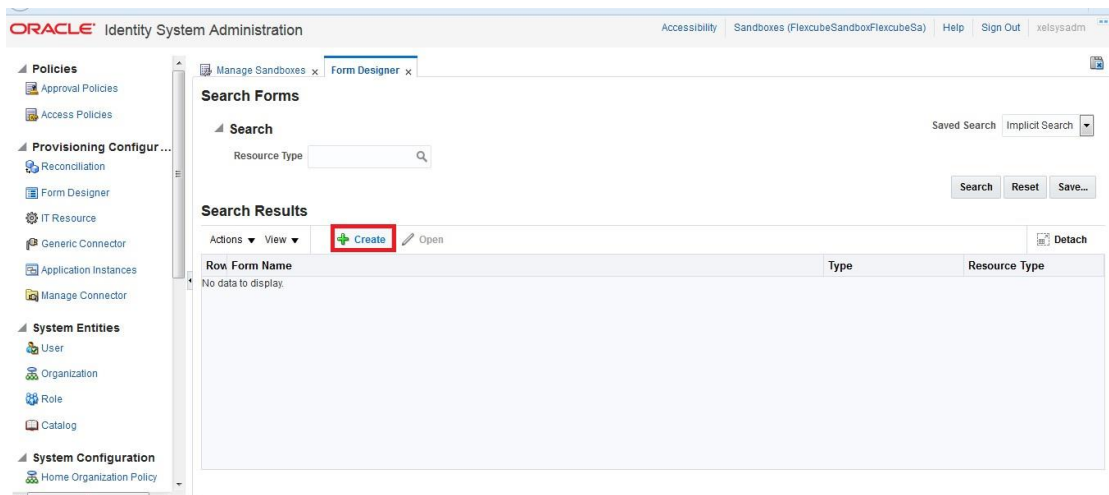

Enter the below details and Click on Create

- Resource Type : FLEXCUBE\_GTC
- Form Name : FlexcubeForm

Note\*: Form Name should be same as above

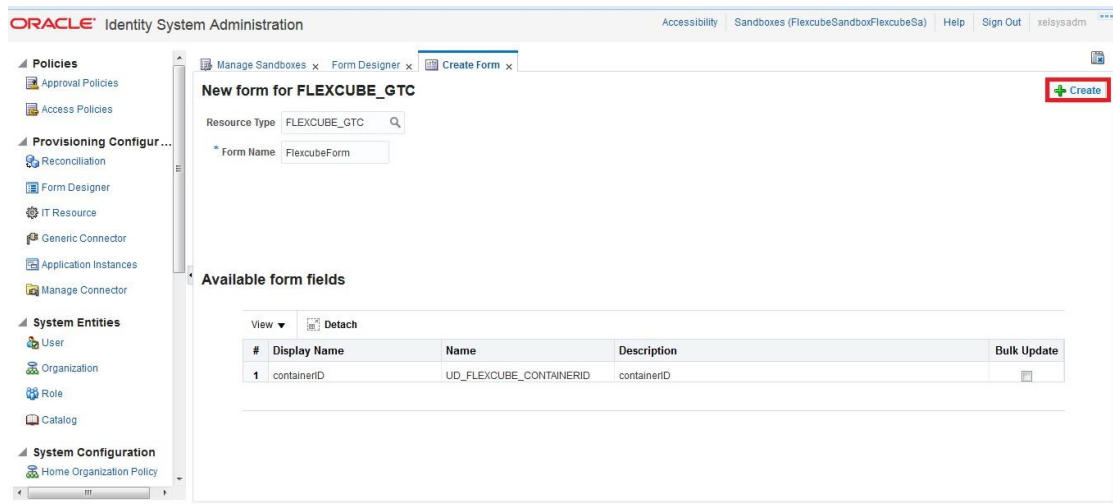

Successful form creation will be like below:

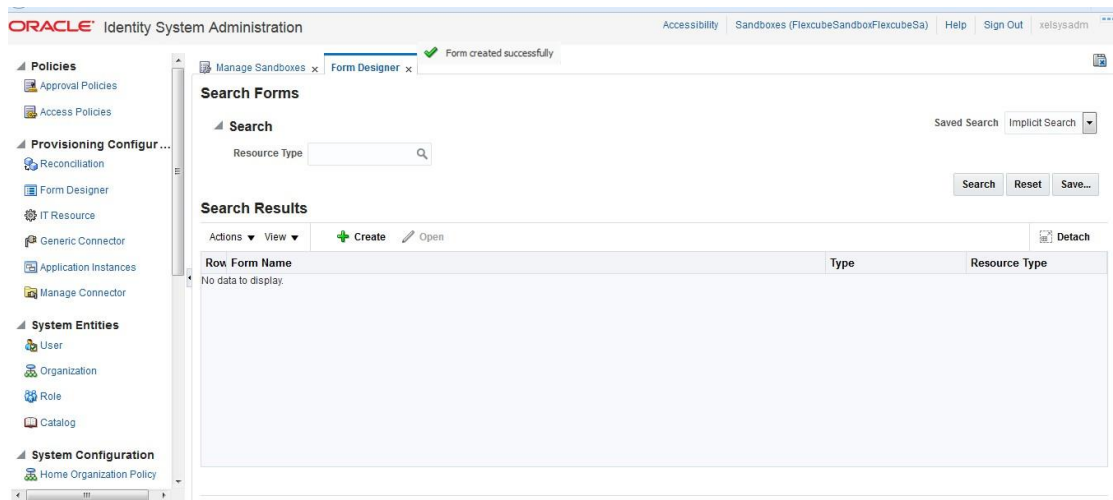

Click on Application Instances under Provisioning Configuration.

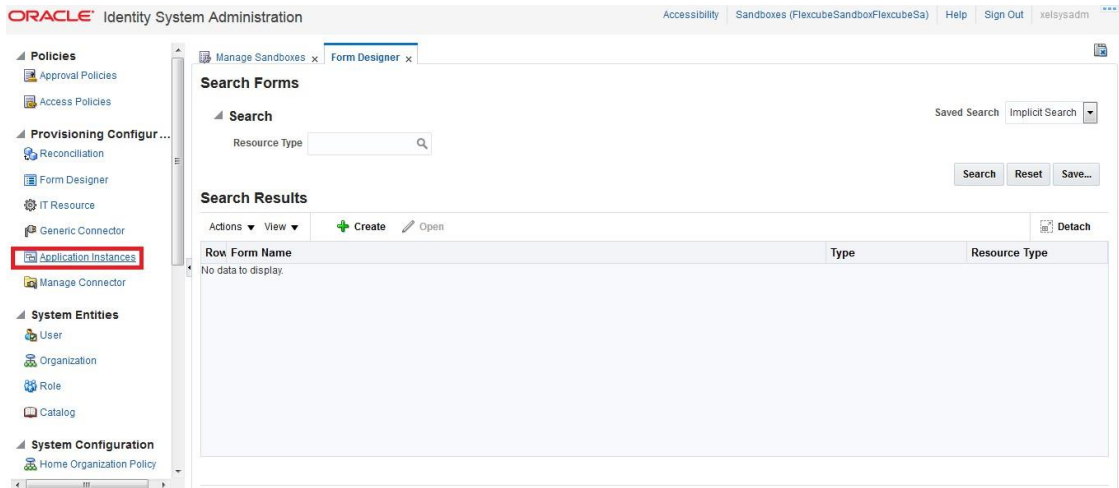

Click on Search.

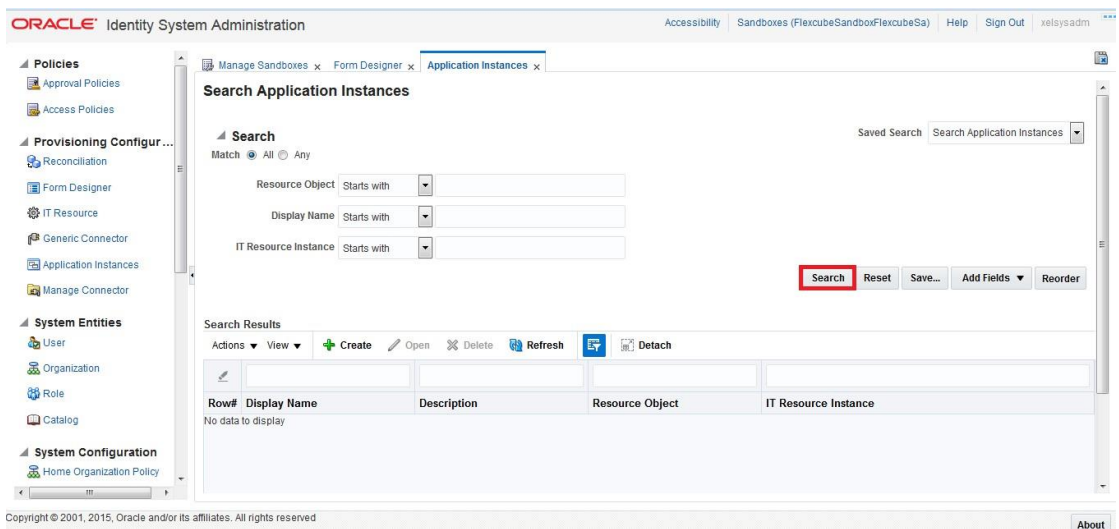

Click on FLEXCUBE\_GTC.

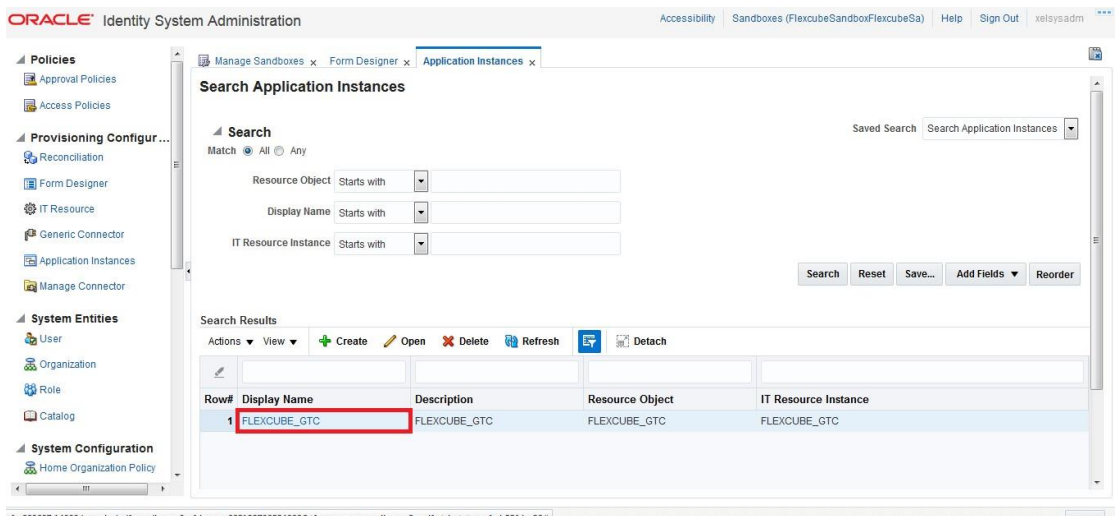

Choose the Form as FlexcubeForm and Click on Apply.



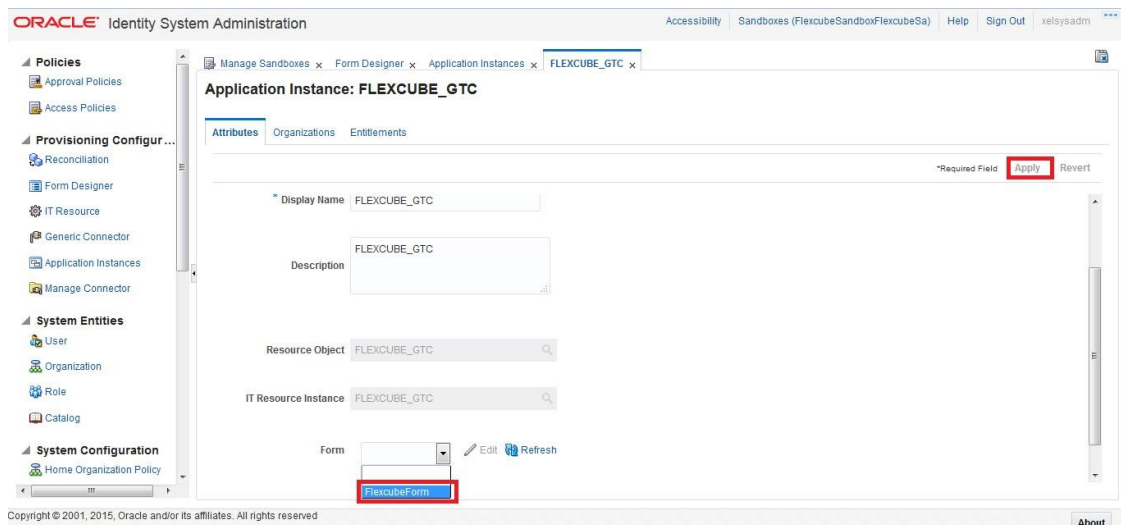

On Successful modification will be shown like below:

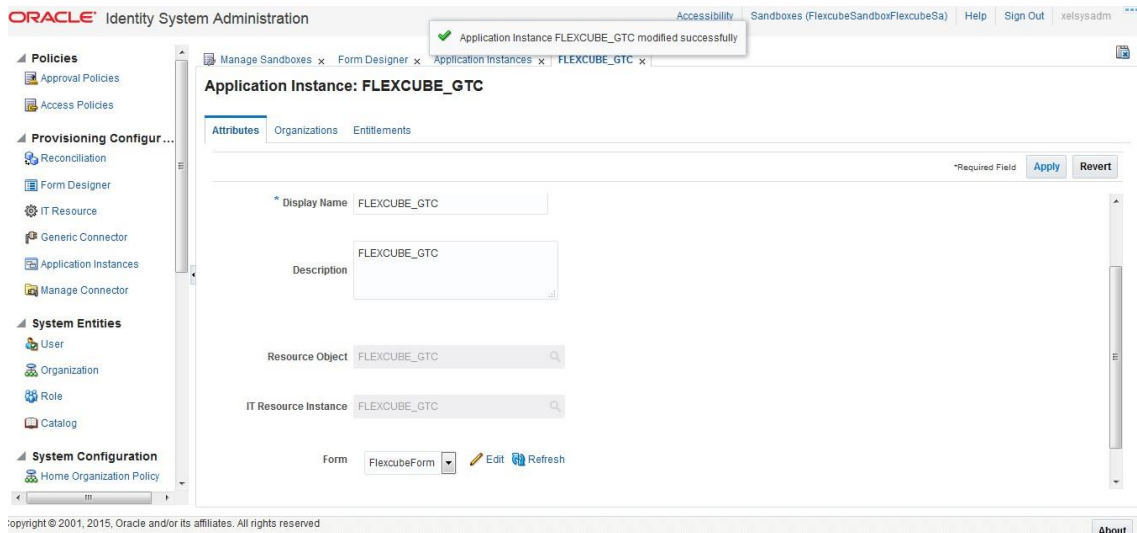

Application Instance belongs to the following Organizations

Note: In case provisioning has to be applied for different Organizations then Create the Organizations under System Entities and map those Organizations to the Application Instance.

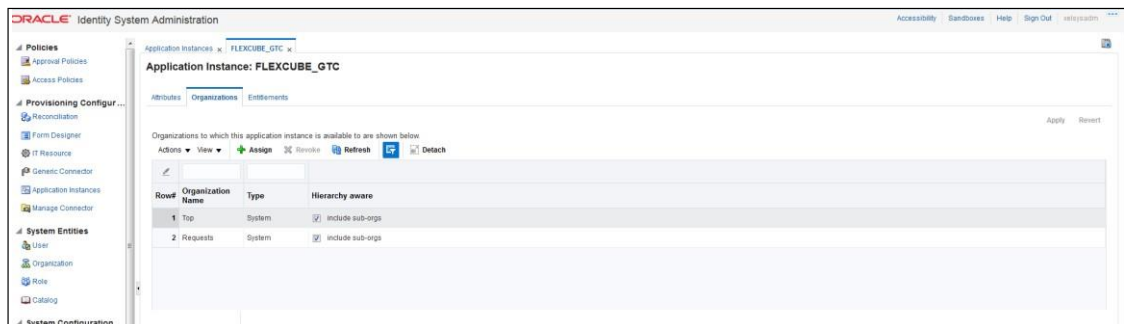

Select and click on Publish Sandbox.

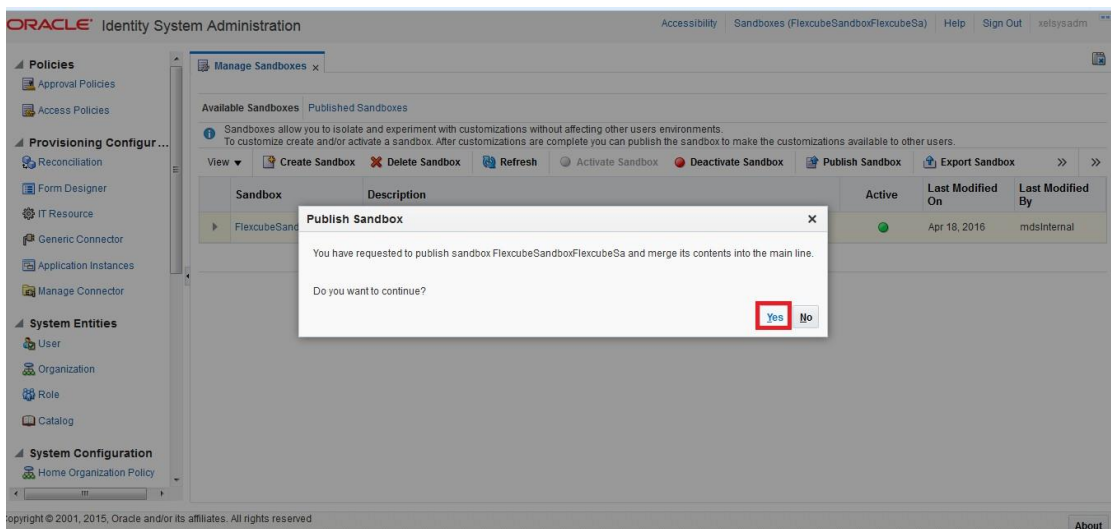
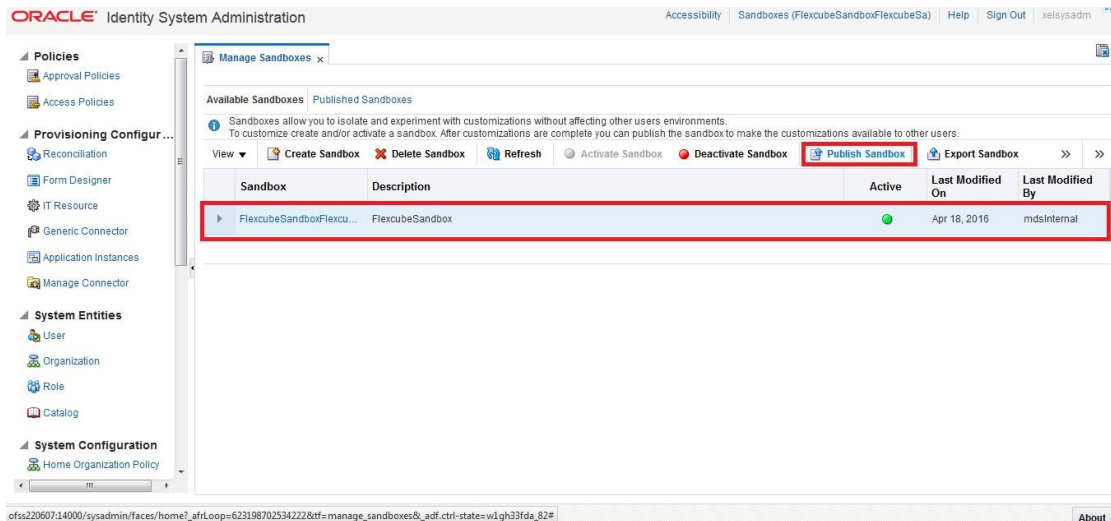

Click on Scheduler under System Configuration.

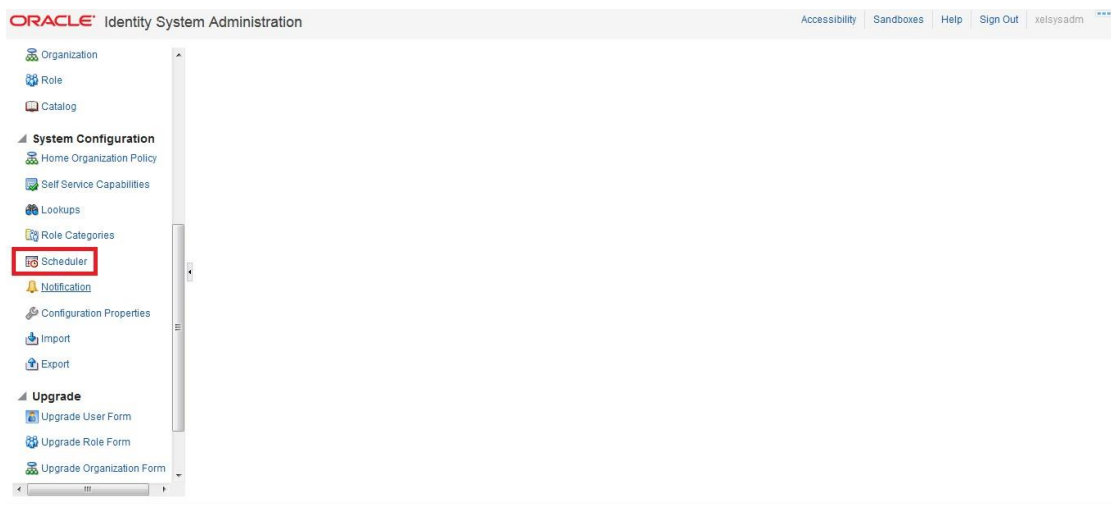

Click on  to Search for Scheduled Job List.

The screenshot displays the Oracle Identity System Administration web interface. At the top, there are navigation tabs for 'Event Management', 'Policies', and 'System Management'. Below these, there are sub-tabs for 'Scheduler', 'Notification', and 'System Configuration'. The main content area is titled 'Search Scheduled Jobs' and features an 'Advanced Search' section with a search icon. Below the search bar, there are icons for 'Actions' and 'View'. The search results area is currently empty, displaying the text 'No search conducted.'.

On the right side of the interface, there is a 'Welcome' section titled 'Welcome to Identity System Administration'. This section contains three main categories of search options:

- Event Management:** Search Reconciliation Events
- Policies:** Search Approval Policies
- System Management:** Search Scheduled Jobs, Search Notification Templates, Search System Properties

At the bottom right corner of the interface, there is a small 'About' link.

## Click on Entitlement List

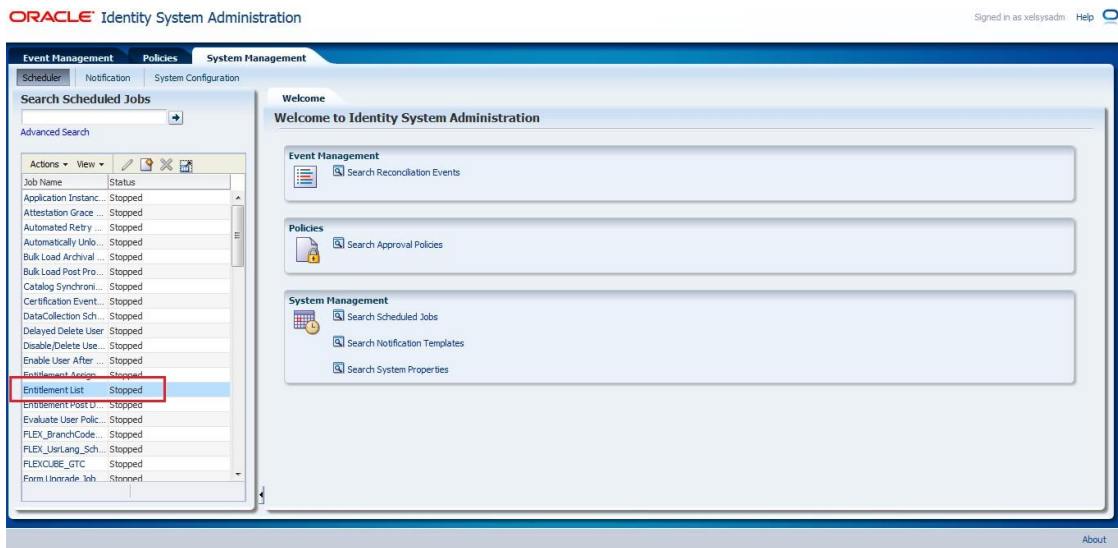

## Click on Run Now.

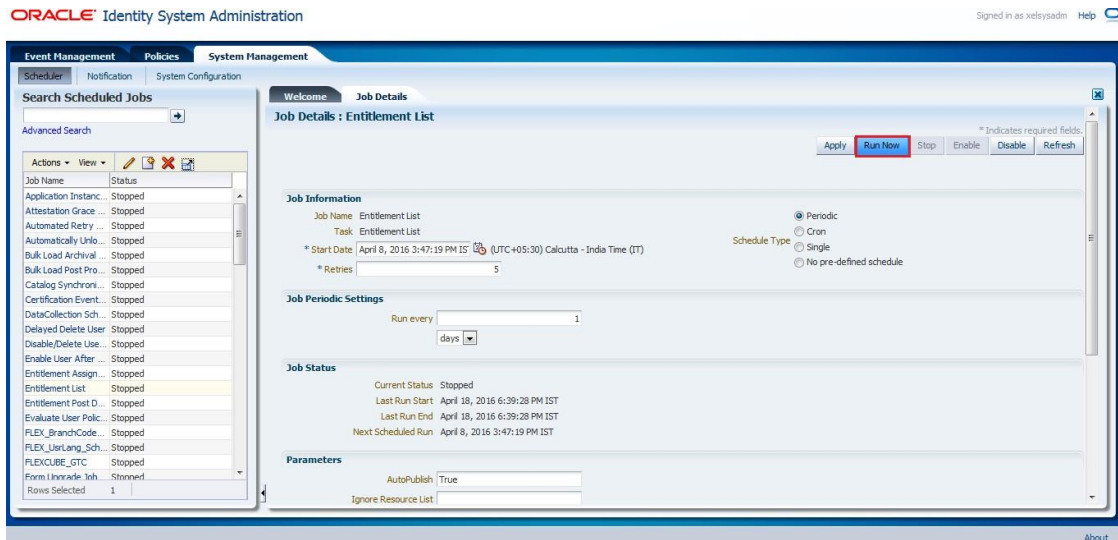

## Schedule Task Setup

This step involves setting up Schedule task parameters.

- 5.1.6.6.1 Open the Oracle Identity Manager Administrative console. (Give the following URL in the browser: <http://<hostname>:<oimport>/sysadmin>)

Enter OIM administrator username/password and press Login.

The screenshot shows the Oracle Identity System Administration web interface. At the top, the header reads "ORACLE Identity System Administration" on the left and "Accessibility Help About Oracle" on the right. The main content area is a light blue gradient with a white "Sign In" box in the center. Inside the box, it says "Sign in with your account". Below this, there are two input fields: "User ID" with the text "xelsysadm" and "Password" with masked characters "\*\*\*\*\*". A "Sign In" button is located at the bottom of the box. At the bottom of the page, there is a copyright notice: "Copyright © 2001, 2015, Oracle and/or its affiliates. All rights reserved."

Click on Scheduler under System Configuration.

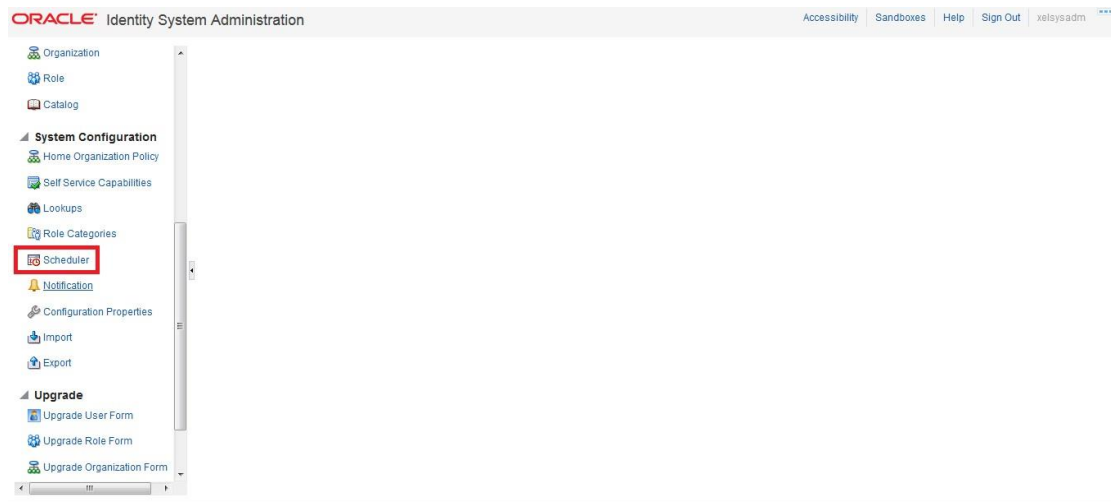

Click on  to Search for Scheduled Job List.

The screenshot displays the Oracle Identity System Administration web interface. At the top, there are navigation tabs for "Event Management", "Policies", and "System Management". Below these, there are sub-tabs for "Scheduler", "Notification", and "System Configuration". The main content area is divided into two sections. On the left, a "Search Scheduled Jobs" panel is active, showing an "Advanced Search" button (highlighted with a red box) and a search results area that currently displays "No search conducted.". On the right, a "Welcome" message reads "Welcome to Identity System Administration". Below this, there are three search panels: "Event Management" with a "Search Reconciliation Events" option, "Policies" with a "Search Approval Policies" option, and "System Management" with three options: "Search Scheduled Jobs", "Search Notification Templates", and "Search System Properties". The bottom right corner of the interface has an "About" link.

Click on FLEX\_BranchCode\_SchTask.

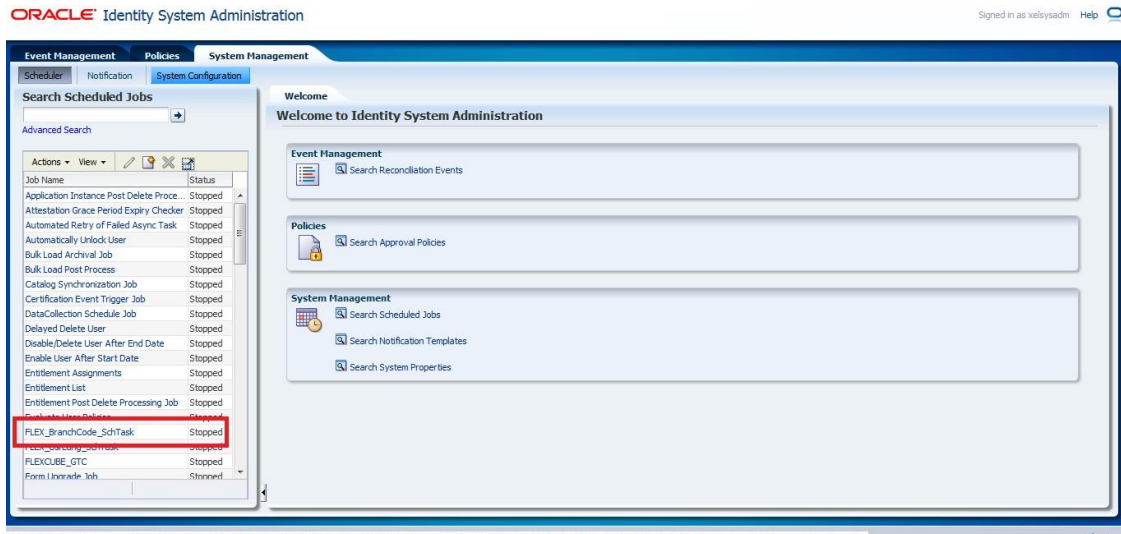

On the Edit Schedule Task screen.

- WebService Url : FCUBSLOVAdService deployed in section [5.1.4.2.1](#)

https://<hostname>:<ssl\_port>/FCUBSLOVAdService/FCUBSLOVAdServiceSEI

- Query :

FCUBS :

select branch\_code||'~'||branch\_code from sttm\_branch order by branch\_code

FCIS :

select moduleid||'~'||moduleid from moduleprofilebasetbl where once\_auth='Y' order by moduleid

- Click on Apply and Click on Run.

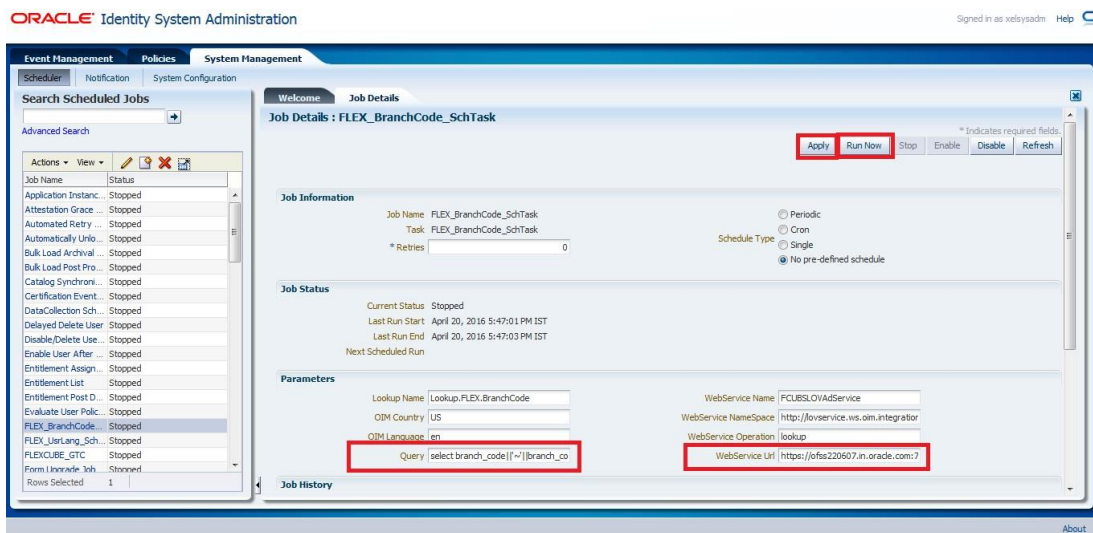



## Modify FLEX\_UsrLang\_SchTask job

- WebService Url : FCUBSLOVAdService deployed in section 5.1.4.2.1  
[https://<hostname>:<ssl\\_port>/FCUBSLOVAdService/FCUBSLOVAdServiceSEI](https://<hostname>:<ssl_port>/FCUBSLOVAdService/FCUBSLOVAdServiceSEI)
- Click on Apply and Click on Run.

ORACLE Identity System Administration Signed in as xelsysadm Help

The screenshot displays the Oracle Identity System Administration interface. The main window is titled 'Job Details: FLEX\_UsrLang\_SchTask'. On the left, there is a 'Search Scheduled Jobs' sidebar with a list of jobs, including 'FLEX\_UsrLang\_Sch' which is selected. The main area shows job information, status, and parameters. The 'Parameters' section includes fields for 'WebService Name' (FCUBSLOVAdService), 'WebService NameSpace' (http://ovservice.ws.aim.integrator), 'WebService Operation' (lookup), and 'WebService Url' (https://ofas220607.in.oracle.com:7). The 'Apply' and 'Run Now' buttons are highlighted with red boxes. The 'Job Status' section shows the current status as 'Stopped' and the last run start time as 'April 20, 2016 5:38:34 PM IST'.

## 5.1.7 System Configurations

### 5.1.7.1 Integration Specific Configurations

#### 5.1.7.1.1 FCUBS Configurations

On FCUBS side following configurations need to be done:

- Maintenance of Maker ID
- Maintenance of External Source

Both configurations can be done using FCJ provided screens.

##### 1. Maintenance of Maker ID

The FCJ screen can be open through Security Maintenance >> Users >> Detailed menu or using the function SMDUSRDF.

##### 2. Maintenance of External Source

For OIM request and response handling, an external source should be maintained in FCUBS database.

The FCJ screen can be open through Gateway >> External System >> Detailed menu or using the function 'GWDEXSYS'.

This external source should be able to do all operations like Create	Modify	Close	Open	View. This can be maintained through function GWDEXFUN or through Gateway >> External System Functions >> Detailed. Required actions and their corresponding details are given as below.
--	--------	-------	------	--

Action	Function	Service Name	Operation Code
NEW	SMGUSRDF	FCUBSSMService	CreateUserMaint
UNLOCK	SMGUSRDF	FCUBSSMService	ModifyUserMaint
DELETE	SMGUSRDF	FCUBSSMService	DeleteUserMaint
CLOSE	SMGUSRDF	FCUBSSMService	CloseUserMaint
REOPEN	SMGUSRDF	FCUBSSMService	ReopenUserMaint
VIEW	SMQUSRDF	FCUBSSMService	QueryUserMaint

Ensure that required maintenance has been done for function CODSORCE (Gateway >> Source>>

Detailed) and for function CODUPLDM (Gateway >> Source Preferences >> Detailed menu).

For maintenance of amendable fields in GWTM\_AMEND\_NODES and GWTM\_AMEND\_FIELDS entries can be made using the function STDAMDMT or through Gateway >> Amendment Maintenance >> Detailed. Following table gives the amendable node and fields details that should be maintained.

Field Name	Value
Amend Nodes section	
Node Name	SMTB_USER
New Allowed	Checked
Delete Allowed	Checked
All Records	Checked
Amend Fields section	
Field Name	HOME_BRANCH
Field Name	START_DATE
Field Name	TIME_LEVEL
Field Name	USER_LANGUAGE
Field Name	USER_NAME
Field Name	USER_PASSWORD
Field Name	SALT

### 5.1.7.2 OIM Configurations

#### 5.1.7.2.1 OID Connector Configuration

For FLEXCUBE single sign on mode, the provisioning process consist of user creation in underlying LDAP directory and then provsioining into FLEXCUBE. OIM porvides out of box connectors for LDAP directorires. This connectors provides facility to connect with LDAP and to do the operation through OIM console.



In this integration, the underlying directory for Oracle access manager is Oracle Internet Directory. OIM porvides out of box connector for it that need to be imported as the connector document provided by OIM. After import, following steps should be followed :

Login to the Design Console.



Navigate to the Administration>>Lookup Definition menu

a. Enter the below details:

- Code: Lookup.OID.Organization
- Click on **Search**  Icon
- Click on **Add**  button
- Enter the below details:
  - Code Key : cn=Users,dc=in,dc=oracle,dc=com
  - Decode : cn=Users,dc=in,dc=oracle,dc=com

b. Click on Save .

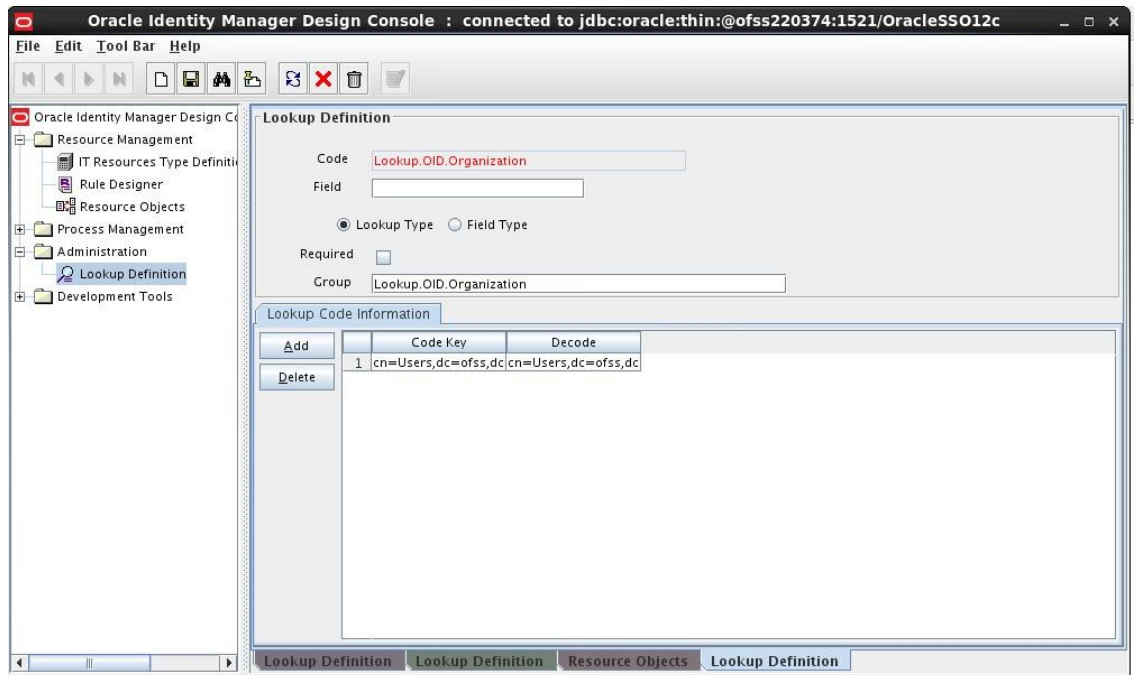

Navigate to the Administration>>Lookup Definition menu

a. Enter the below details:

- Code: Lookup.OID.UM.ProvAttrMap
- Click on Search  Icon
- Modify the Decode value for Code Key Name:
  - From : \_\_NAME\_="uid=\${User\_ID},\${Container\_DN}"
  - To : \_\_NAME\_="cn=\${User\_ID},\${Container\_DN}"

b. Click on Save .

Navigate to the Resource Management>>Resource Objects menu. This will open a blank screen.

- a. Enter FLEXCUBE\_GTC in Name box.
- b. Click on Search icon.
- c. This will show the definition for resource FLEXCUBE\_GTC. Click on Assign button in Depends On tab.

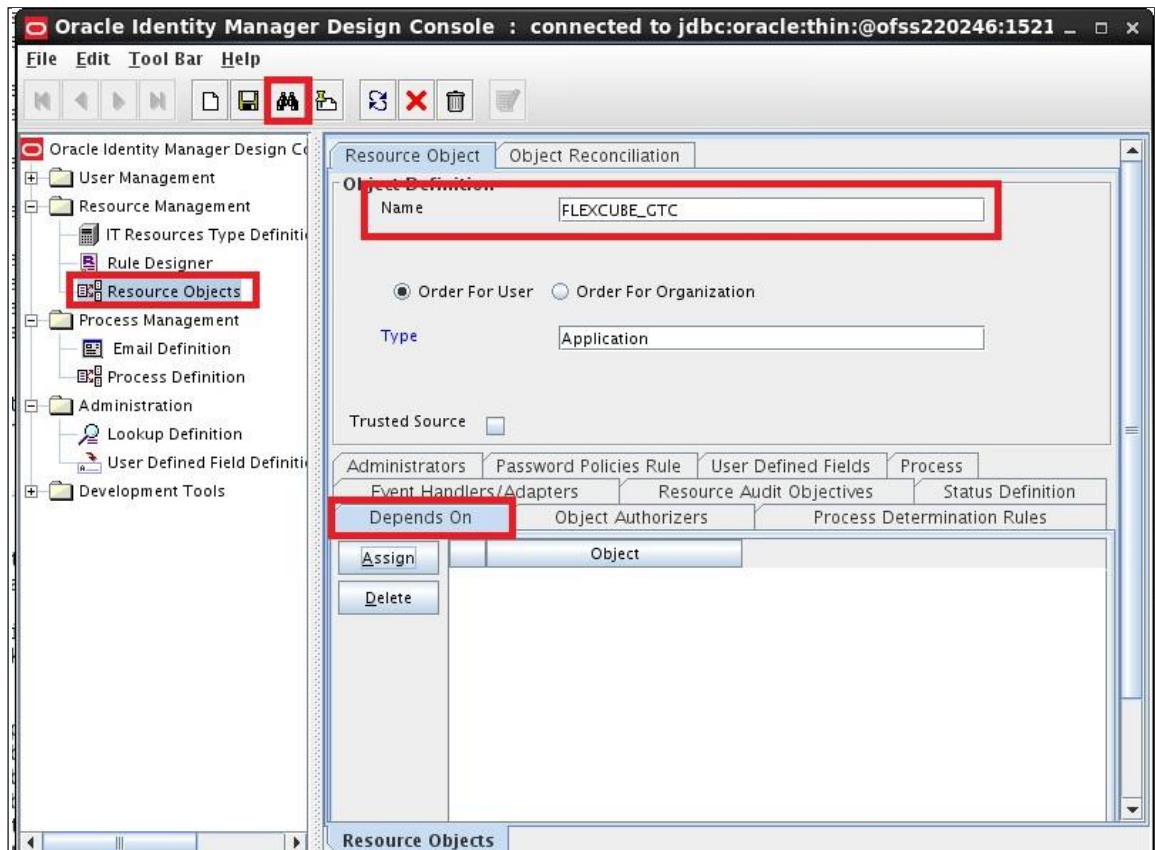

Select the OID User from the Unassigned Objects list. Click on the arrow pointed to Assignend objects.

- a. Click on OK.This will move OID user resource to Assigned objects.

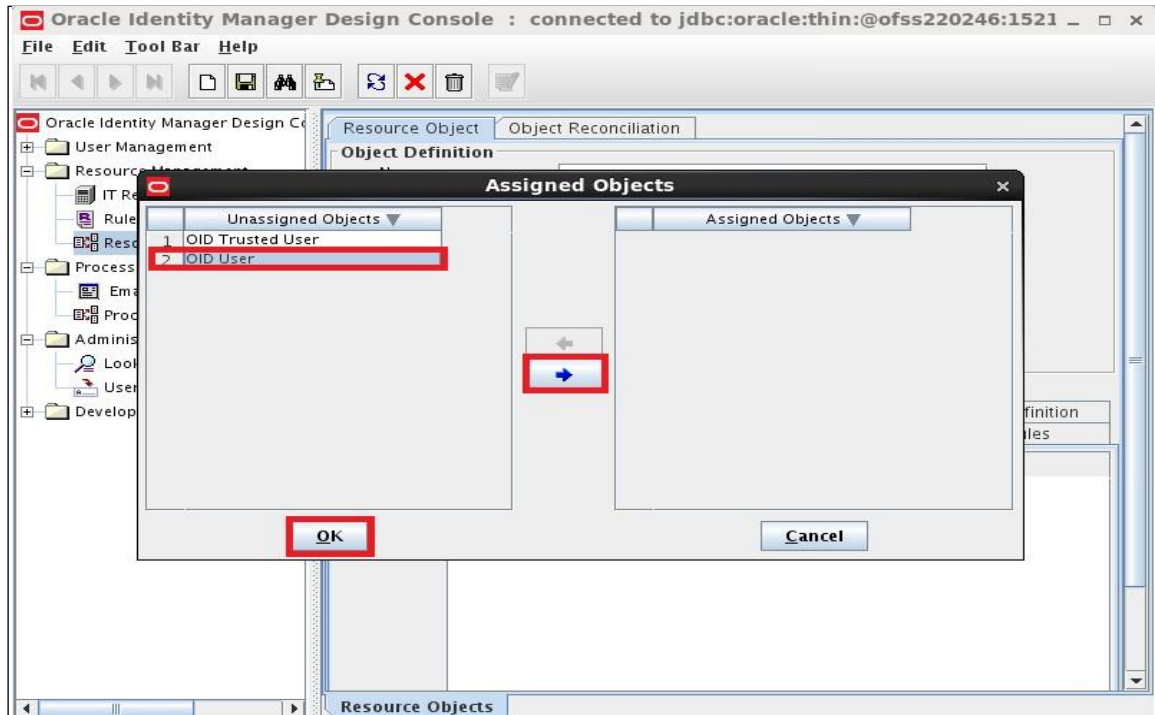

Ensure that OID User will be shown under Object.

- a. Click on Save.

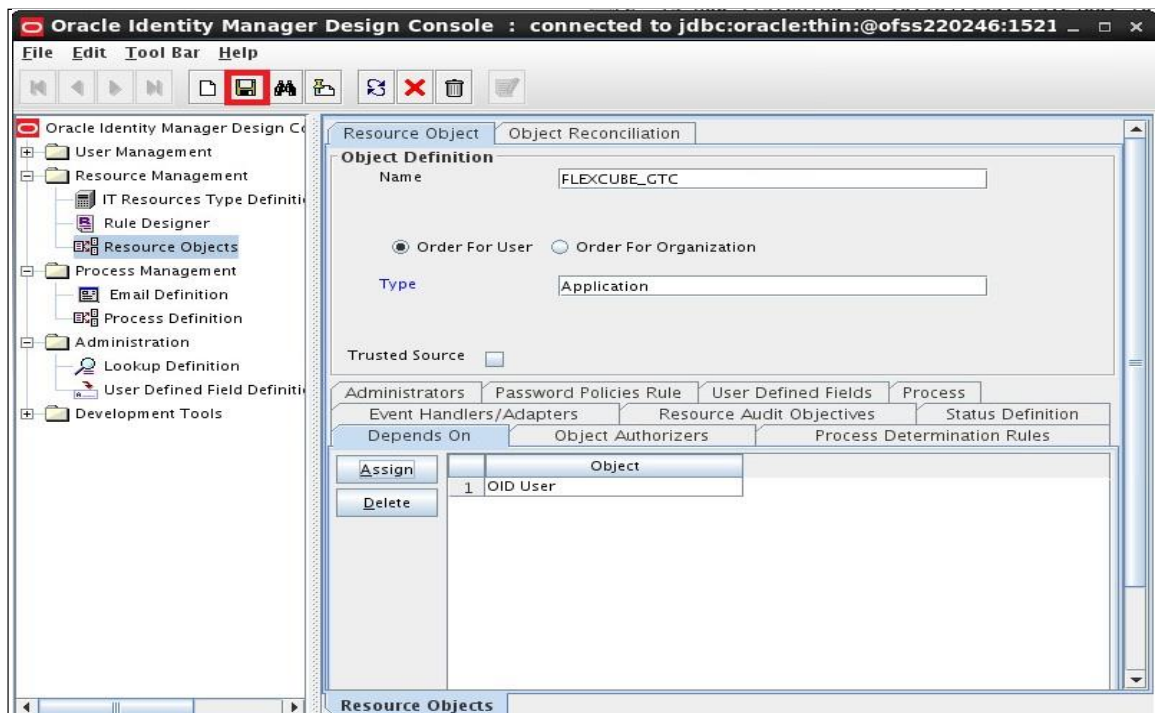

### 5.1.7.2.2 Access Policy Creation for OID

Open the Oracle Identity Manager Administrative console. (Give the following URL in the browser: <http://<hostname>:<import>/sysadmin>)

Login to Administrative Console

- a. Enter OIM administrator username/password and press Sign In.

**Sign In**

Sign in with your account

User ID

xelsysadm

Password

\*\*\*\*\*j

**Sign In**



Click on Access Policies under Policies.

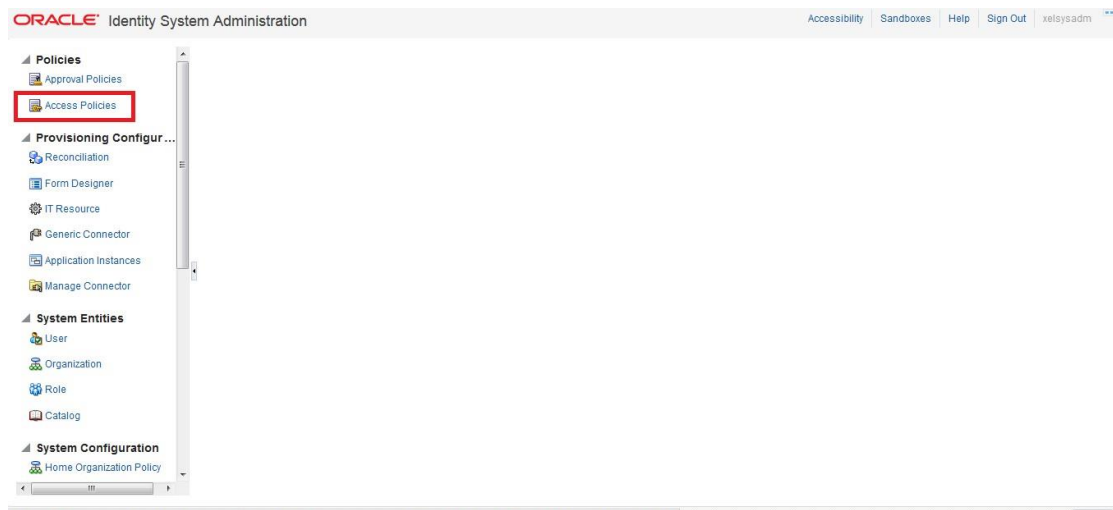

Click on Create Access Policy.

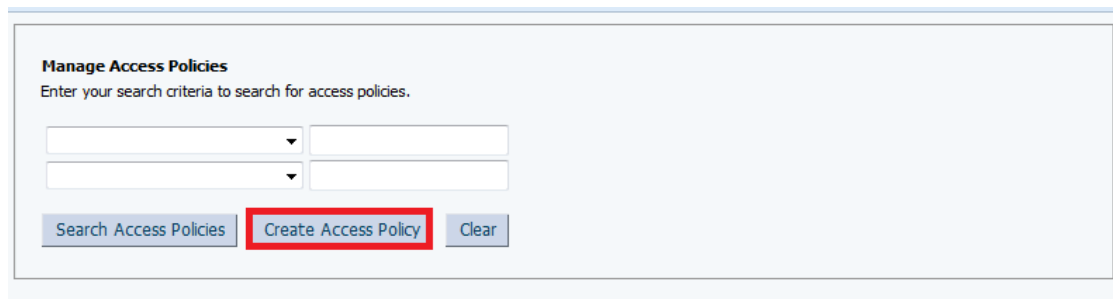

Enter the below details and Click on Continue

- Access Policy Name : OIDAccessPolicy
- Access Policy Description : OIDAccessPolicy
- Policy Owner : ALL USERS
- Retrofit Access Policy : Yes
- Priority : 1

**Create Access Policy**

1 2 3 4

**Step 1: Create Access Policy**

\* Indicates Required Field

Access Policy Name \*

Access Policy Description \*

Policy Owner Role  [Clear](#)

Retrofit Access Policy

Priority \*  Current Lowest Priority=1

[Exit](#) [Continue >>](#)

Perform the below mentioned Operations and Click on Continue.

- Select OID User
- Click on Add Button

**Create Access Policy**

1 2 3 4

**Step 2: Select Resources**

Specify the resources to be provisioned by this access policy.

\* Indicates Required Field

Filter By  [Go](#)

Results 1-2 of 2 First | Previous | Next | Last

<input type="checkbox"/>	Resource Name
<input type="checkbox"/>	FLEXCUBE_GTC
<input checked="" type="checkbox"/>	OID User

First | Previous | Next | Last

[Add >>](#)

[<< Remove](#)

[Selected:](#)

[Exit](#) [<< Back](#) [Continue >>](#)

Click on Continue.

Create Access Policy

1 2 3 4

Step 2: Select Resources

The subsequent pages will guide you through providing the data to associate with the following resources you selected to be provisioned by this Access Policy:

- OID User

Exit << Back Skip This Step **Continue >>**

Select the below Details and Click on Continue.

- Server : OID Server
- Container DN : cn=Users,dc=in,dc=oracle,dc=com
- Preferred Language : English
- Start Date : April 20, 2016 (Current Date)
- End Date : April 20, 2026 (End Date)

Provide the following process details for resource **OID User**:

\* Indicates a required field

User ID	*	<input type="text"/>	
Server	*	OID Server	<a href="#">Clear</a>
Password		<input type="text"/>	
First Name		<input type="text"/>	
Middle Name		<input type="text"/>	
Last Name	*	<input type="text"/>	
Common Name	*	<input type="text"/>	
Container DN	*	cn=Users,dc=ofss,dc=in,dc=	<a href="#">Clear</a>
Department		<input type="text"/>	
Location		<input type="text"/>	
Telephone		<input type="text"/>	
Email ID		<input type="text"/>	
Preferred Language		English	<a href="#">Clear</a>
Time Zone		<input type="text"/>	
Title		<input type="text"/>	
Start Date		April 20, 2016	
End Date		April 20, 2026	
manager		<input type="text"/>	

Click on Continue.

Create Access Policy

1 2 3 4

Step 2: Select Revoke Or Disable Flag

Select if the resources need to be revoked or disabled if the access policy no longer applies.

Resource Name	Revoke if no longer applies	Disable if no longer applies
OID User	<input checked="" type="checkbox"/>	<input type="checkbox"/>

Click on Continue.

**Create Access Policy** 1 2 3 4

**Step 3: Select Resources**

Specify the resources to be denied by this access policy.

\* Indicates Required Field

Filter By:

Results 1-2 of 2 First | Previous | Next | Last

<input type="checkbox"/>	Resource Name	
<input type="checkbox"/>	FLEXCLRE_GTC	<input type="button" value="Add &gt;&gt;"/>
<input type="checkbox"/>	OID User	<input type="button" value="Remove &lt;&lt;"/>

First | Previous | Next | Last

Selected:

Click on Create Access Policy.

<b>Access Policy Name</b>	OIDAccessPolicy
<b>Access Policy Description</b>	OIDAccessPolicy
<b>Policy Owner Type</b>	Role
<b>Policy Owner</b>	SYSTEM ADMINISTRATORS
<b>Retrofit Access Policy</b>	Yes
<b>Priority</b>	1

Resources to be provisioned by this access policy [Change](#)

Resource Name	Revoke if no longer applies	Disable if no longer applies	Process Forms
OID User	✓	✗	OID User <a href="#">Edit</a>

Resources to be denied by this access policy [Change](#)

**i** You have not selected any resources to be denied by this access policy.

Roles for this access policy

Roles Name

Login to Identity Self Services

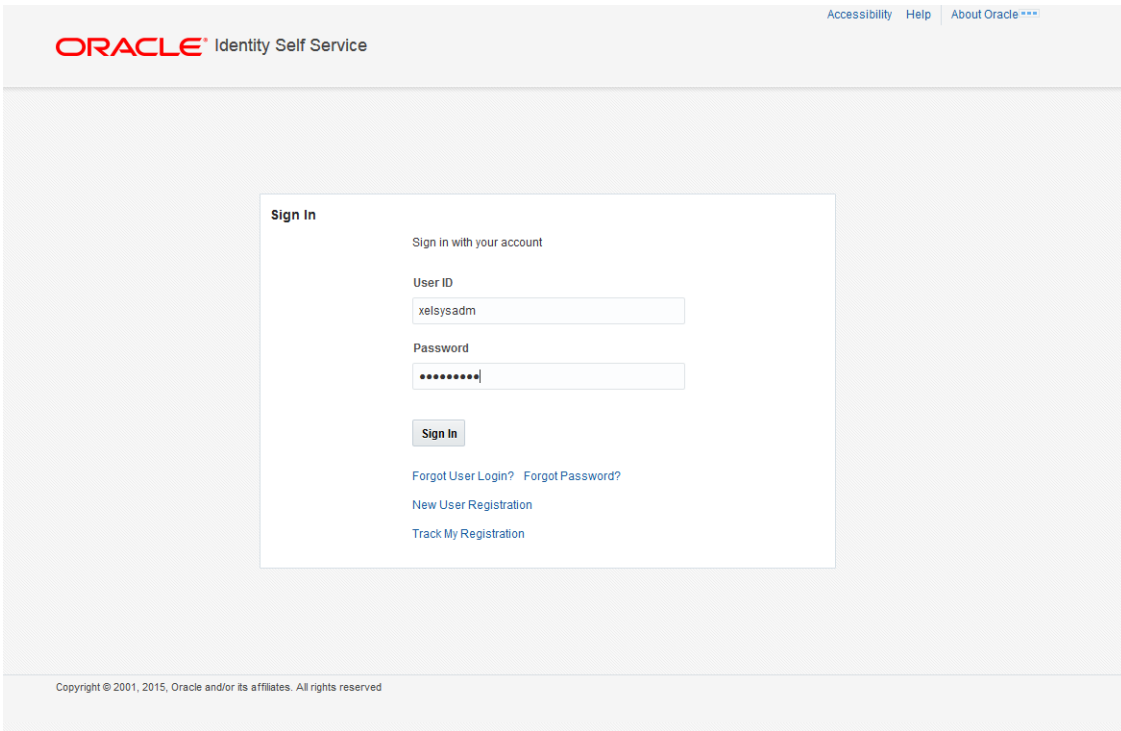

Click on Roles under Manage

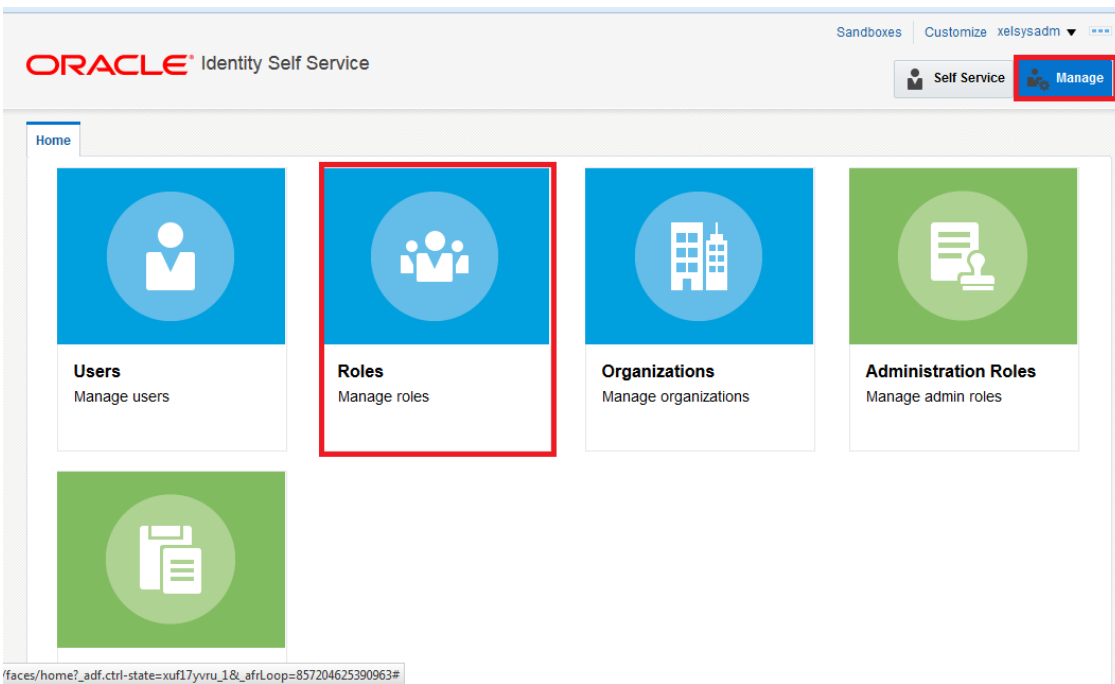

Select ALL USERS to Edit

ORACLE Identity Self Service

Sandboxes Customize xelsysadm

Self Service Manage

Home Roles x

### Roles

Search Name  Advanced

Actions View Create Open Delete Refresh Detach

Name	Role Description
ALL USERS	Default role for all users
Administrators	Administrators role for SOA
BIReportAdministrator	Administrators role for BI Publisher Reports
OPERATORS	Operator role
SELF OPERATORS	Operator role for self registration
SYSTEM ADMINISTRATORS	System Administrator role for OIM

Copyright © 2001, 2015, Oracle and/or its affiliates. All rights reserved

Click on Access Policy

Home Roles x ALL USERS x

### ALL USERS

Apply Revert

Attributes Hierarchy Access Policy Members Organizations

Name ALL USERS

Role Namespace Default

Display Name ALL USERS

Role E-mail

Role Description

Owned By

Click on **+ Add** to Add Access Policy

ORACLE Identity Self Service

Sandboxes Customize xelsysadm

Self Service Manage

Home Roles x ALL USERS x

### ALL USERS

Apply Revert

Attributes Hierarchy Access Policy Members Organizations

Add access policies to define access rights of this role.

Actions View **+ Add** Remove Undo Refresh Detach

Policy Name	Policy Description	Pending Action
No data to display		

Copyright © 2001, 2015, Oracle and/or its affiliates. All rights reserved

Search for the Access Policy & Select the Access Policy Created

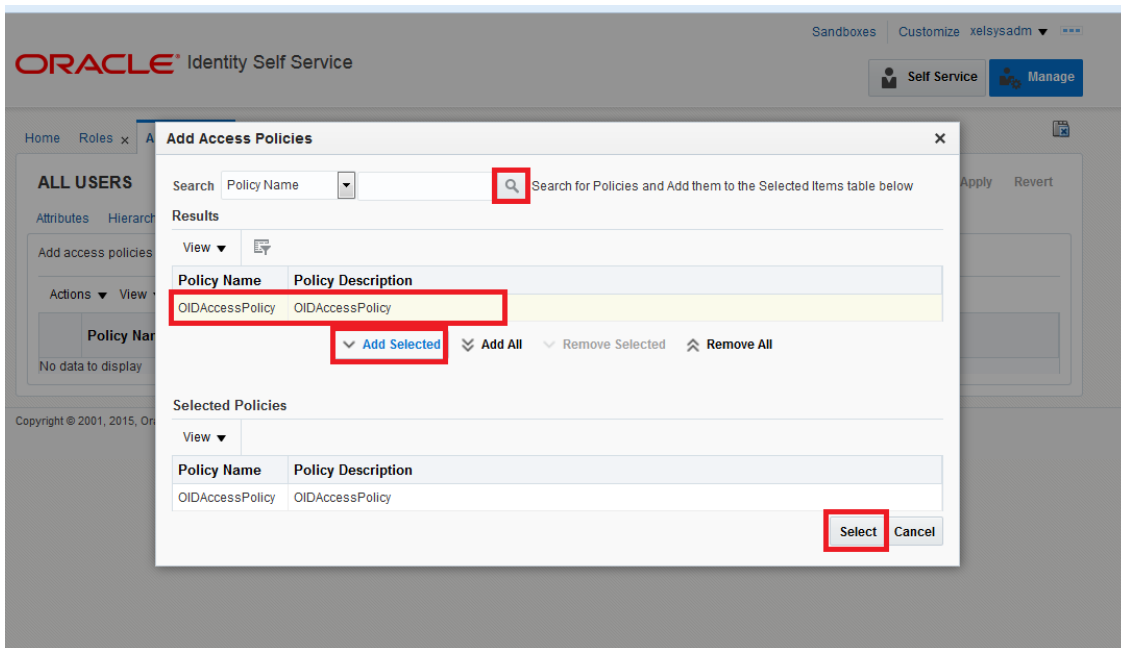

Click on Apply to Save

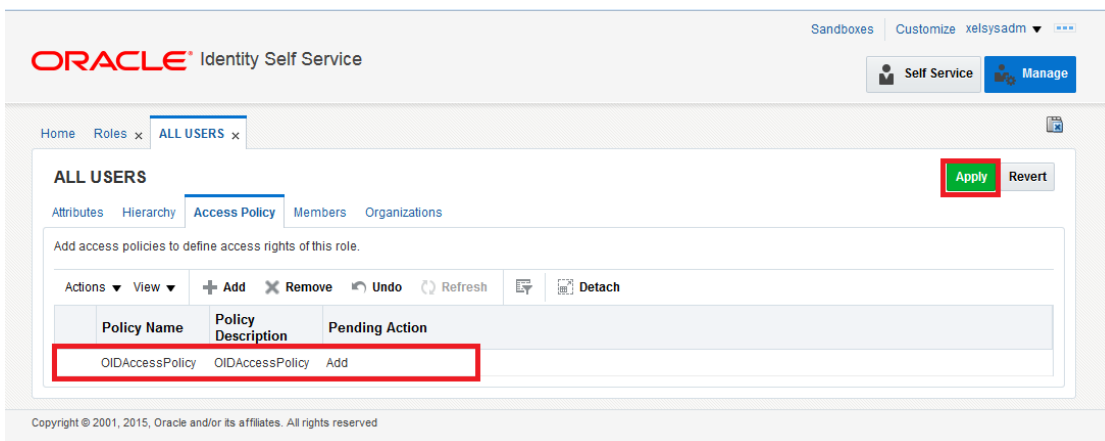

Click on Scheduler under System Configuration.

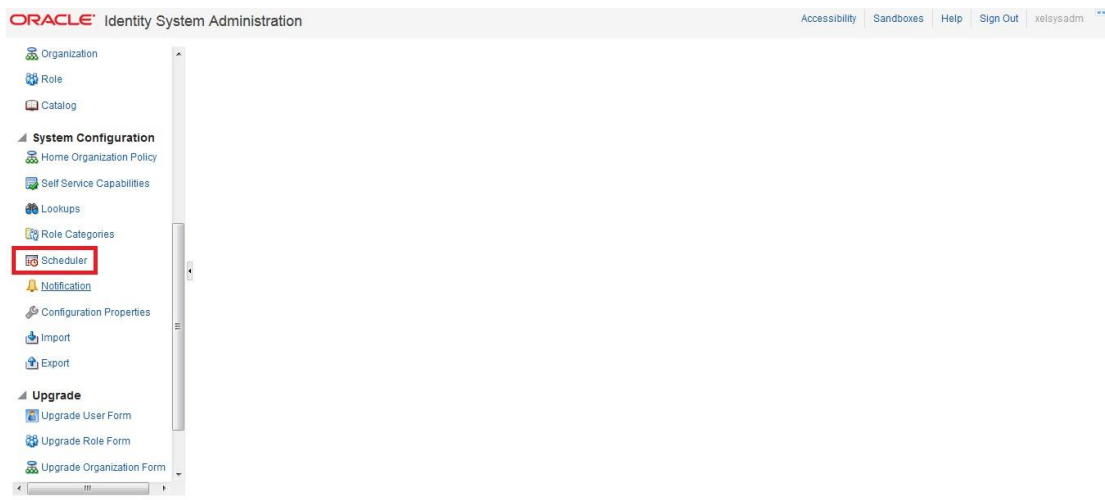

Click on Search shown below:



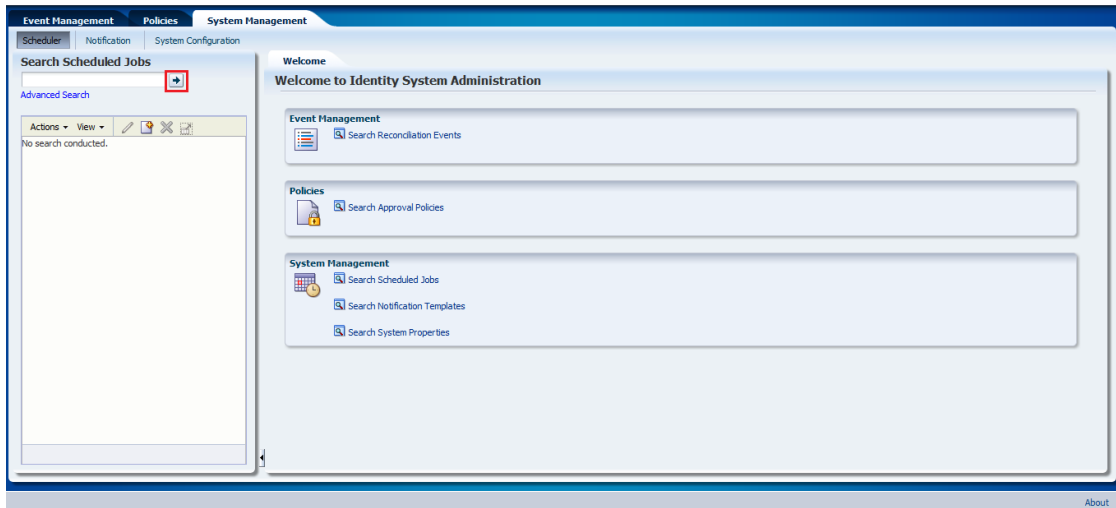

Select Evaluate User Policies.

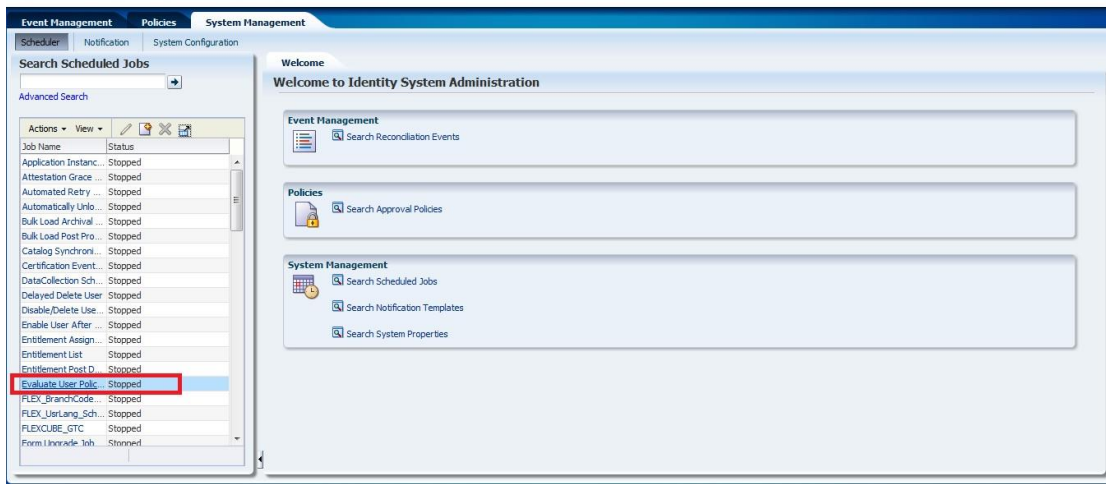

Change the Schedule Type under Job Information, also change Run Every under Job Periodic Setting.

c. Click on Apply.

Job will be scheduled in a periodic manner and it will evaluate the New User Created in Oracle Identity Management Server against the access policies created. If the new user satisfied by the access policy then it will Provision the user to User Account. In this case it's Oracle Internet Directory.

The screenshot shows the Oracle Identity System Administration interface. On the left is a 'Search Scheduled Jobs' sidebar with a list of jobs and their statuses. The main area is titled 'Job Details: Evaluate User Policies'. At the top right of this area are buttons for 'Apply', 'Run Now', 'Stop', 'Enable', 'Disable', and 'Refresh'. The 'Run Now' button is highlighted with a red box. Below the buttons, the 'Job Information' section shows the job name 'Evaluate User Policies', task 'Evaluate User Policies', and a periodic schedule type. The start date is 'April 21, 2016 3:47:19 AM IST (UTC+05:30) Calcutta - India Time (IT)'. The 'Retries' field is set to '10' and is highlighted with a red box. The 'Job Periodic Settings' section shows 'Run every' set to '10' minutes, also highlighted with a red box. The 'Job Status' section shows the current status as 'Stopped', with the last run start and end times as 'April 21, 2016 11:24:55 AM IST'. The 'Parameters' section shows 'Batch Size' as '500' and 'Number of Threads' as '5'.

## 6. Solution / Usage Guidelines

### 6.1 Working with OIM

#### 6.1.1 Creating a user in FLEXCUBE through OIM

To create a user in FLEXCUBE through OIM, first a user must be created in OIM itself. After creating a user in OIM, a user can be created in FLEXCUBE by assigning a resource named FLEXCUBE\_GTC.

Open the Oracle Identity Manager Administrative console. (Give the following URL in the browser: <http://<hostName>:<oimport>/identity>)

Login to Administrative Console

- a. Enter OIM administrator username/password and press **Login**.

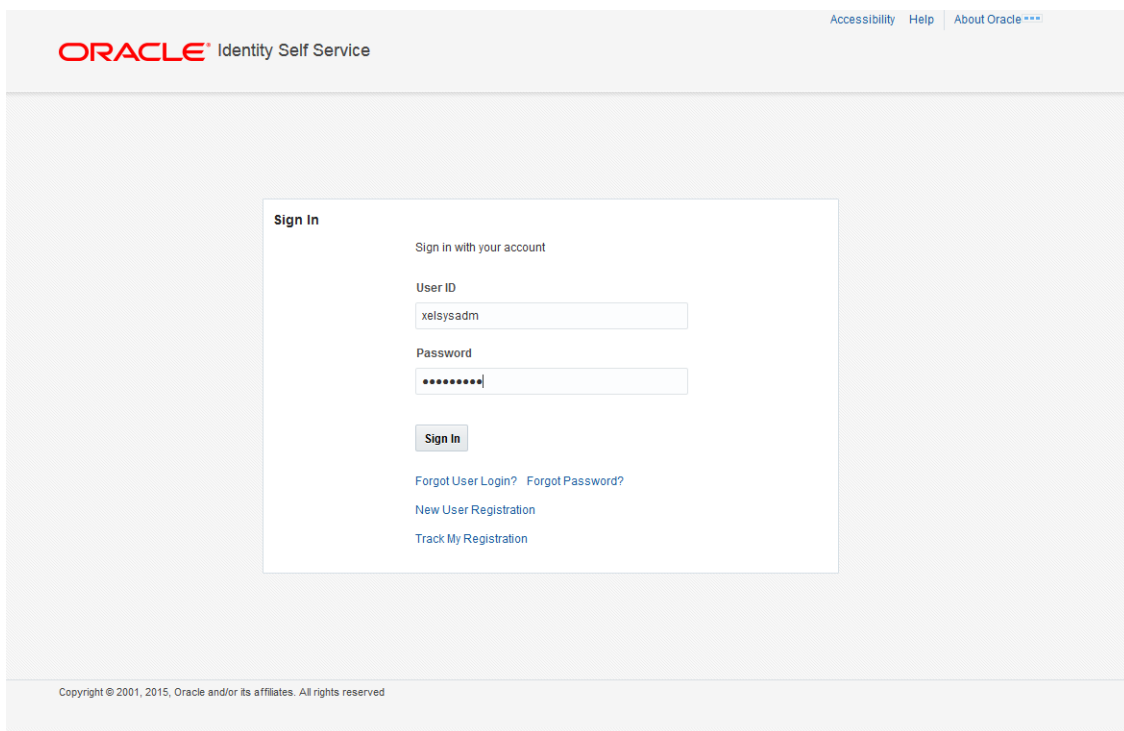

The screenshot shows the Oracle Identity Self Service Sign In page. The page header includes the Oracle logo and "Identity Self Service" text, along with links for "Accessibility", "Help", and "About Oracle \*\*\*". The main content area features a "Sign In" form with the following elements:

- Text: "Sign in with your account"
- Text: "User ID"
- Text input field containing "xelsysadm"
- Text: "Password"
- Text input field containing "\*\*\*\*\*"
- Text: "Sign In" (button)
- Text: "Forgot User Login? Forgot Password?"
- Text: "New User Registration"
- Text: "Track My Registration"

At the bottom of the page, there is a copyright notice: "Copyright © 2001, 2015, Oracle and/or its affiliates. All rights reserved."

Click on Users under Manage.

ORACLE Identity Self Service

Sandboxes Customize xelsysadm

Self Service **Manage**

Home



**Users**  
Manage users



**Roles**  
Manage roles



**Organizations**  
Manage organizations



**Administration Roles**  
Manage admin roles

faces/home?\_adf.no-new-window-redirect=true&\_adf.ctrl-state=b3xqyjoe\_5&\_afriLoop=858257121335836&\_afriWindowMode=2&\_afriWindowId=12dzelp5h#

Click on Create.

ORACLE Identity Self Service

Sandboxes Customize xelsysadm

Self Service **Manage**

Home **Users** x

**Users**

Search

Actions          >>

User Login	Display Name	First Name	Last Name	Organization	Telephone Number	E-mail	Identity Status	Account S
OIMINTERNAL	Internal User	OIMINTERNAL	OIMINTERNAL	Xellerate Users			Active	Unlocked
WEBLOGIC	Weblogic User	WEBLOGIC	WEBLOGIC	Xellerate Users			Active	Unlocked
XELSYSADM	System Adminis...	System	Administrator	Xellerate Users		donotreply@ora...	Active	Unlocked

Copyright © 2001, 2015, Oracle and/or its affiliates. All rights reserved

The Create User screen will get displayed.

a. Below are the mandatory fields, which needs to be entered to Create the User in Oracle Identity Manager

- i. First Name
- ii. Last Name
- iii. Organization
- iv. User Type
- v. E-mail
- vi. Display Name
- vii. User Login
- viii. Password
- ix. Confirm Password
- x. Start Date

Note: Password & Confirm Password are not entered then System will generate some random password & it will mailed to the email address entered.

b. Click on Submit.

The screenshot shows the Oracle Identity Self Service interface for creating a user. The page title is 'ORACLE Identity Self Service'. The breadcrumb navigation shows 'Home Users x Create User x'. The main heading is 'Create User' with a red 'Submit' button, a 'Save As...' dropdown, and a 'Cancel' button. The form is organized into sections: 'Request Information', 'Basic Information', 'Account Settings', 'Account Effective Dates', and 'Provisioning Dates'. The 'Basic Information' section includes fields for First Name (Nandhakumar), Middle Name, Last Name (Vemban), E-mail (nandhakumar.vemban@oracle.com), Manager, Organization (Requests), User Type (Employee), and Display Name (Nandhakumar Vemban). The 'Account Settings' section includes fields for User Login (nvemban-in), Password, and Confirm Password. The 'Account Effective Dates' section includes fields for Start Date (4/25/2016) and End Date. The 'Provisioning Dates' section is currently collapsed.

On successful creation of user "User successfully got created" message will get appeared.

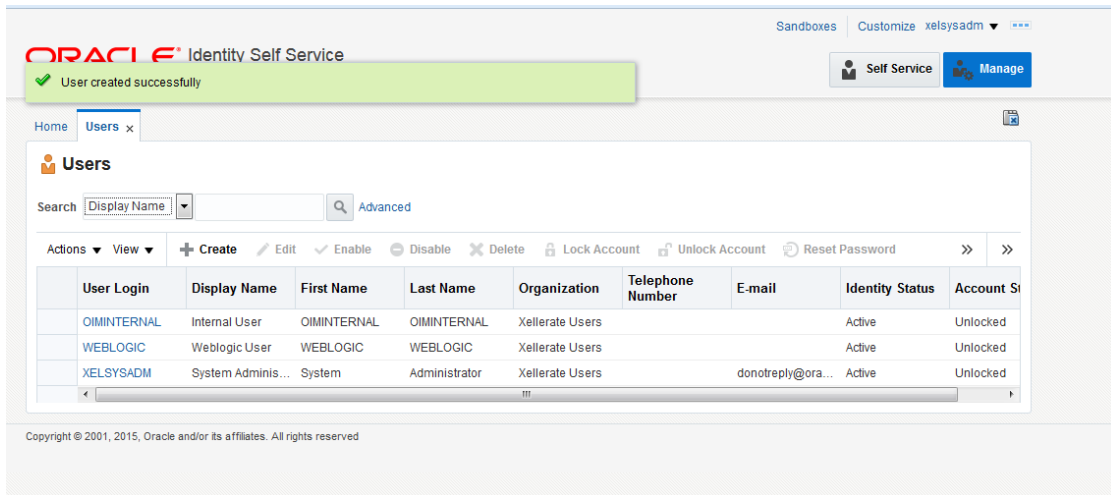

Click on Refresh to fetch the updated user list.

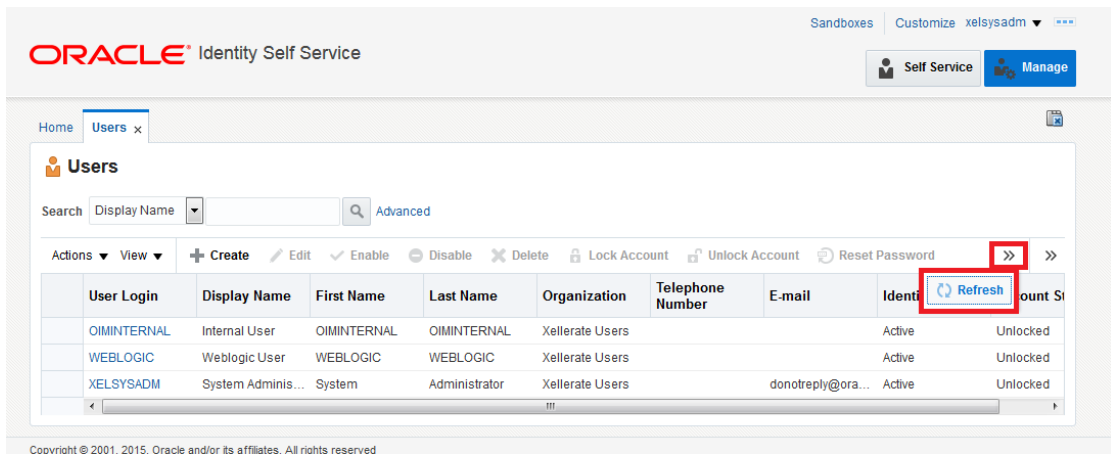

Click on the User created in the step above and Click on Accounts TAB

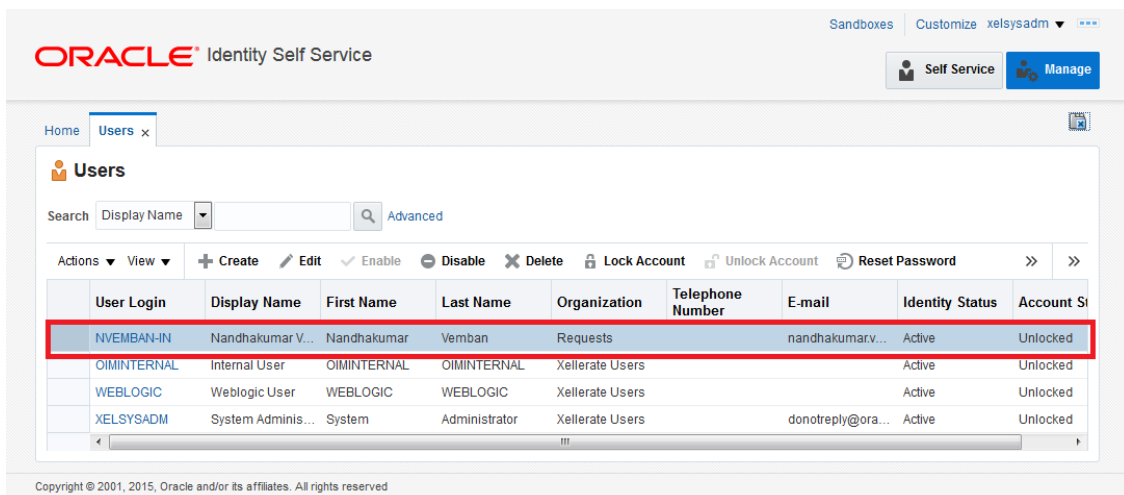

Wait for Time, which has been set to evaluate the user access policy in 5.1.6.2.2.15 and Click on Refresh. In the Accounts TAB, User will be Provisioned with OID User Resource Type.

ORACLE Identity Self Service

Sandboxes Customize xelsysadm

Self Service Manage

Home Users x User Details : Nandhakuma... x

**Nandhakumar Vemban**

Modify Enable Disable Delete Lock Account UnLock Account Reset Password

Attributes Roles Entitlements **Accounts** Direct Reports Organizations Admin Roles

Actions View + Request Accounts Modify Grant Duration Request Entitlement Refresh Resource History Detach

Application Instance	Resource	Account Name	Provisioned On	Status	Account Type	Request ID	Start Date	End Date
OID User	OID User	NVEMBAN-IN	4/25/2016	Provisioned	Primary		4/25/2016	

Copyright © 2001, 2015, Oracle and/or its affiliates. All rights reserved

Click on Request Accounts.

ORACLE Identity Self Service

Sandboxes Customize xelsysadm

Self Service Manage

Home Users x User Details : Nandhakuma... x

**Nandhakumar Vemban**

Modify Enable Disable Delete Lock Account UnLock Account Reset Password

Attributes Roles Entitlements **Accounts** Direct Reports Organizations Admin Roles

Actions View + **Request Accounts** Modify Grant Duration Request Entitlement Refresh Resource History Detach

Application Instance	Resource	Account Name	Provisioned On	Status	Account Type	Request ID	Start Date	End Date
OID User	OID User	NVEMBAN-IN	4/25/2016	Provisioned	Primary		4/25/2016	

Copyright © 2001, 2015, Oracle and/or its affiliates. All rights reserved

Click on **+ Add to Cart** against FLEXCUBE\_GTC.

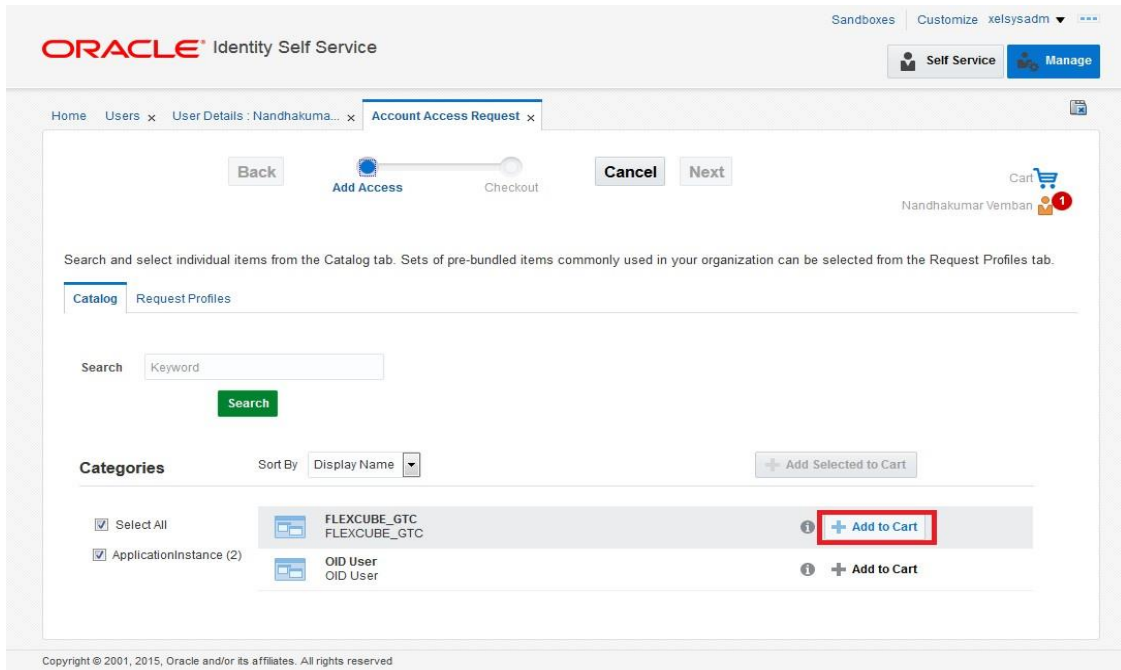

Click on Next Button

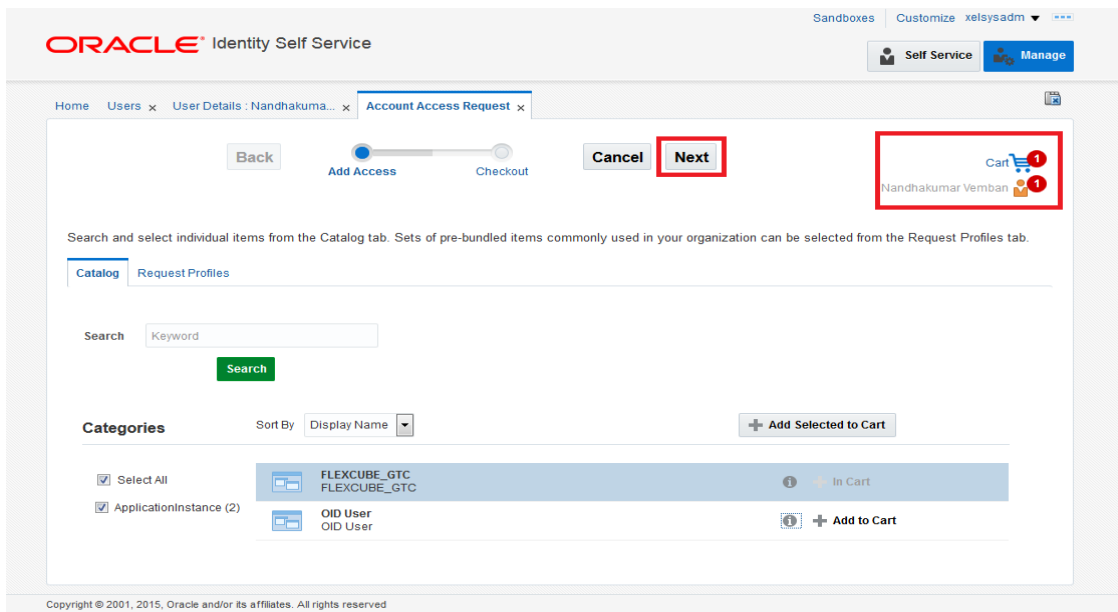

Following screen will appear like below:

- d. Click on Details form  to edit the user details
- e. Select the Home Branch, User Language, Time Level
- f. Click on Update Button

Note: In case like have a different FLEXCUBE USERID populated then it can be modified ( only during Request Account in FLEXCUBE), do not modify any other value, which is pre-populated in this screen.



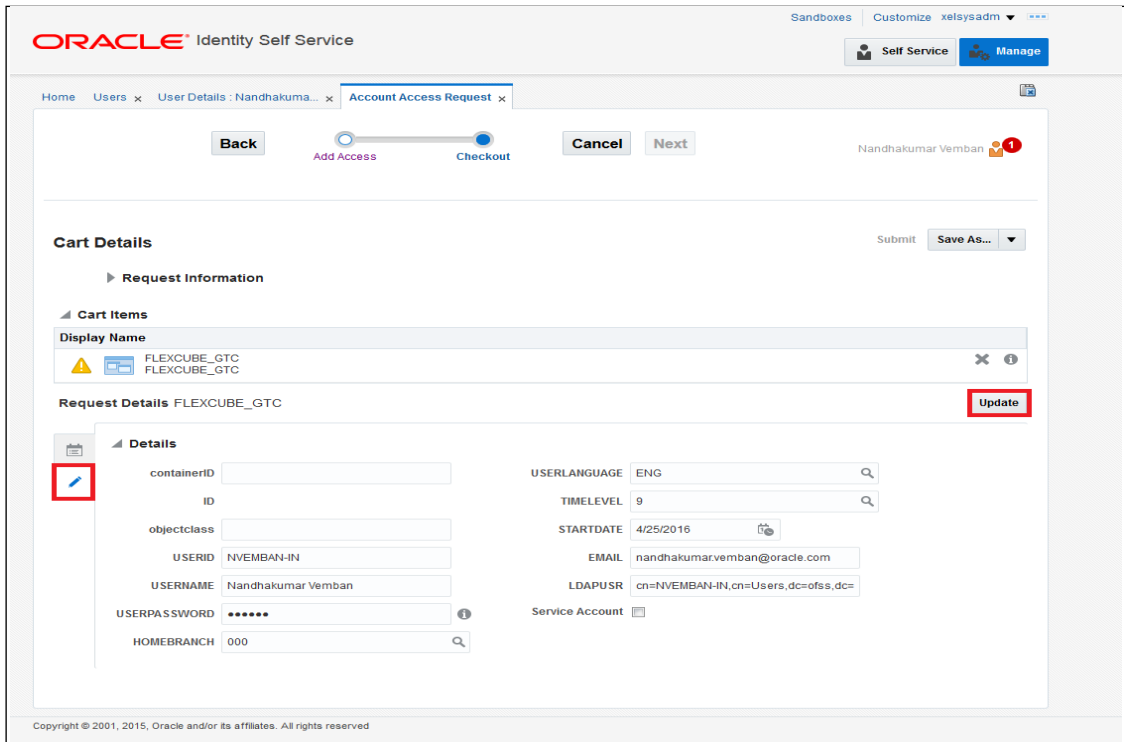

Click on Submit.

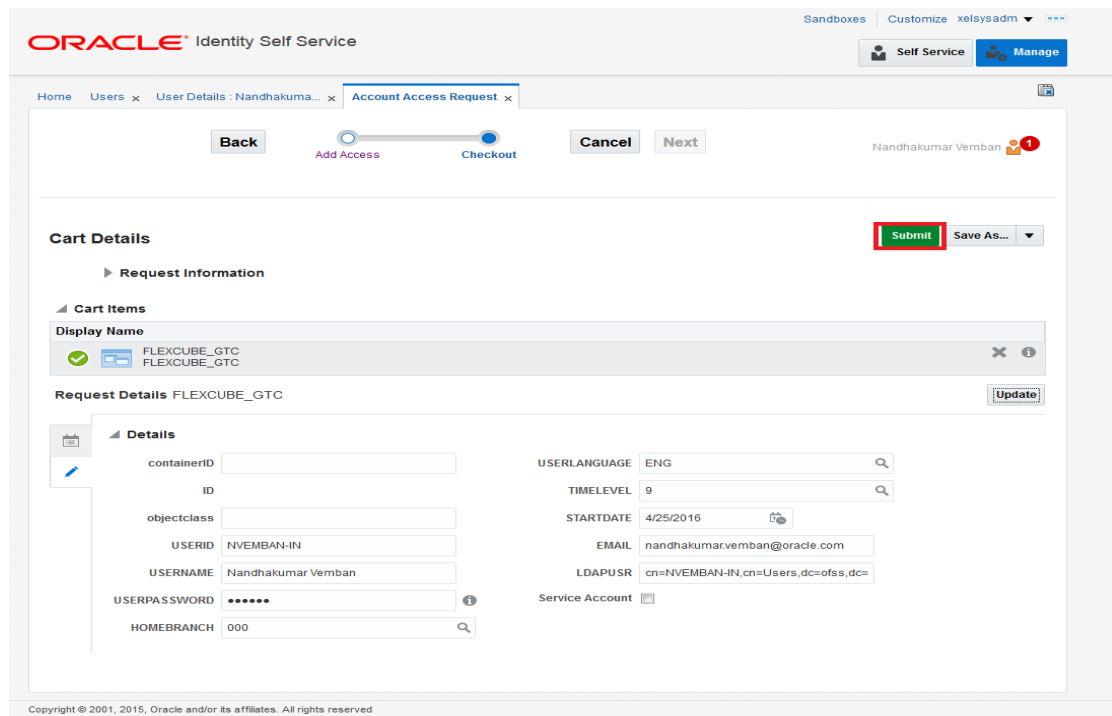

Click on Refresh in Accounts TAB.

ORACLE Identity Self Service

Home Users x User Details : Nandhakuma... x

**Nandhakumar Vemban**

Modify Enable Disable Delete Lock Account UnLock Account Reset Password

Attributes Roles Entitlements **Accounts** Direct Reports Organizations Admin Roles

Actions View Request Accounts Modify Grant Duration Request Entitlement **Refresh** Resource History Detach

Application Instance	Resource	Account Name	Provisioned On	Status	Account Type	Request ID	Start Date	End Date
OID User	OID User	NVEMBAN-IN	4/25/2016	Provisioned	Primary		4/25/2016	

It will show the Requested Account and its status.

If the status is provisioned then the User is created in the Target Application.

ORACLE Identity Self Service

Home Users x User Details : Nandhakuma... x

**Nandhakumar Vemban**

Modify Enable Disable Delete Lock Account UnLock Account Reset Password

Attributes Roles Entitlements **Accounts** Direct Reports Organizations Admin Roles

Actions View Request Accounts Modify Grant Duration Request Entitlement Refresh Resource History Detach

Application Instance	Resource	Account Name	Provisioned On	Status	Account Type	Request ID	Start Date	End Date
FLEXCUBE_GTC	FLEXCUBE_GTC	24	4/25/2016	Provisioned	Primary		4/25/2016	
OID User	OID User	NVEMBAN-IN	4/25/2016	Provisioned	Primary		4/25/2016	

Copyright © 2001, 2015, Oracle and/or its affiliates. All rights reserved

## 6.1.2 Modifying a user in FCUBS through OIM

Navigate to the Accounts TAB>>Select FLEXCUBE\_GTC >> Click on Modify Accounts.

- After successful provisioning User Details like User Name, User Password, Time Level, User Language and Home Branch can be modified.
- Email, LDAP User, Start Date should not be modified.

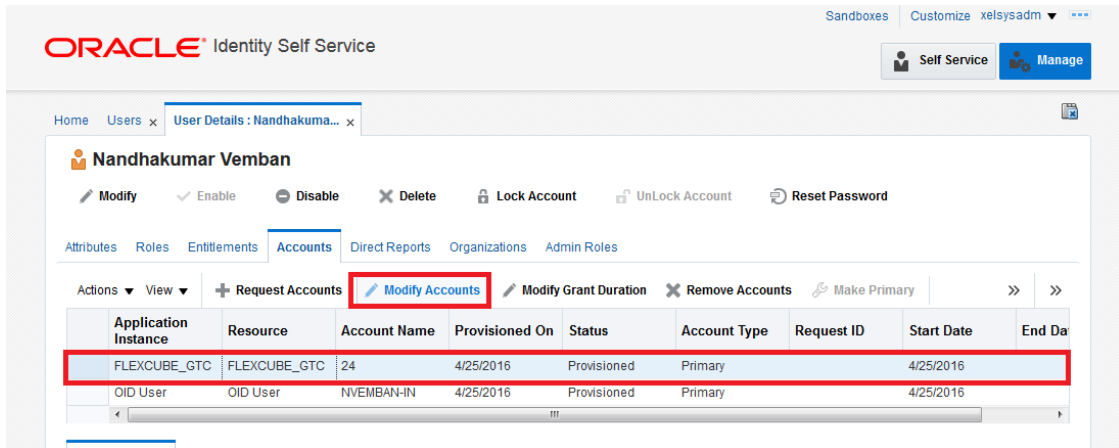

The following screen is displayed.

- Modify the data (Any/All of User Name, User Password, Time Level, Home Branch and User Language).
- Click on Update Button.
- Click on Submit.

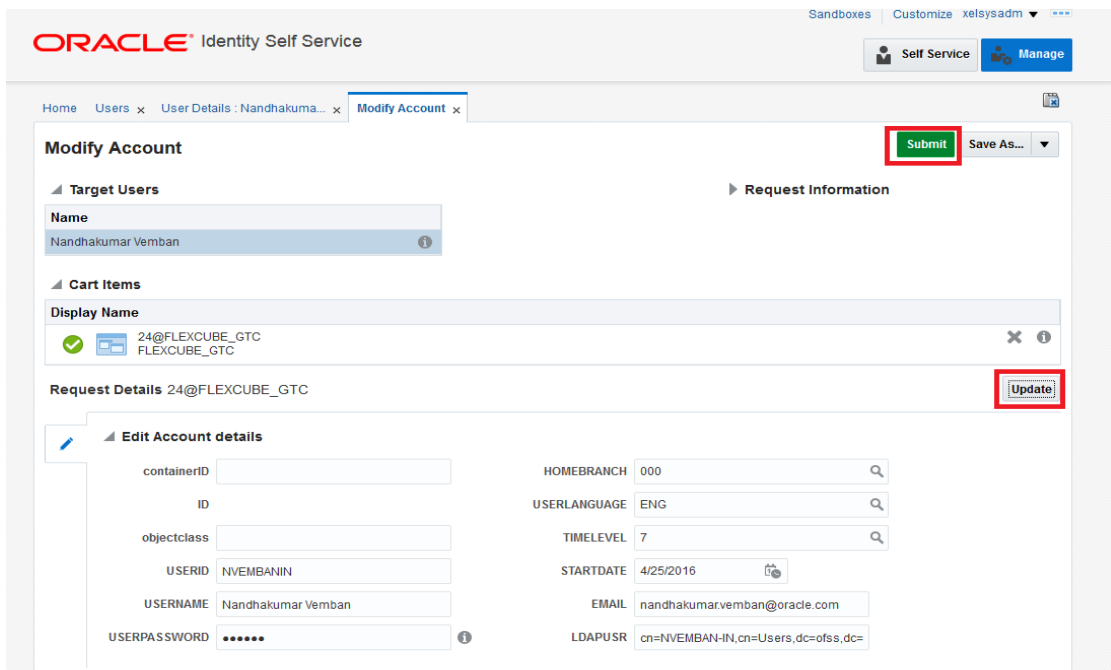

Navigate to the Accounts >> Select FLEXCUBE\_GTC >> Resource History

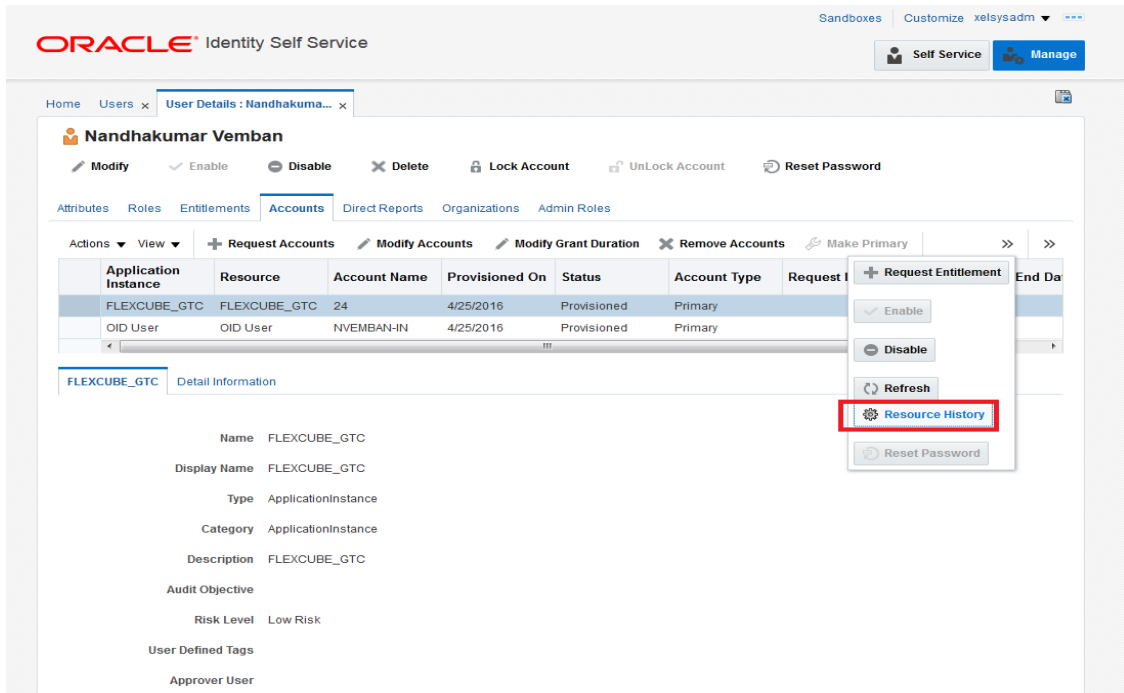

The following screen is displayed.

- a. Based on the modification done it will show the individual field change status (In case of more than one field like User Name, User Password changes it will show USERNAME Updated, HOMEBRANCH Updated etc.).

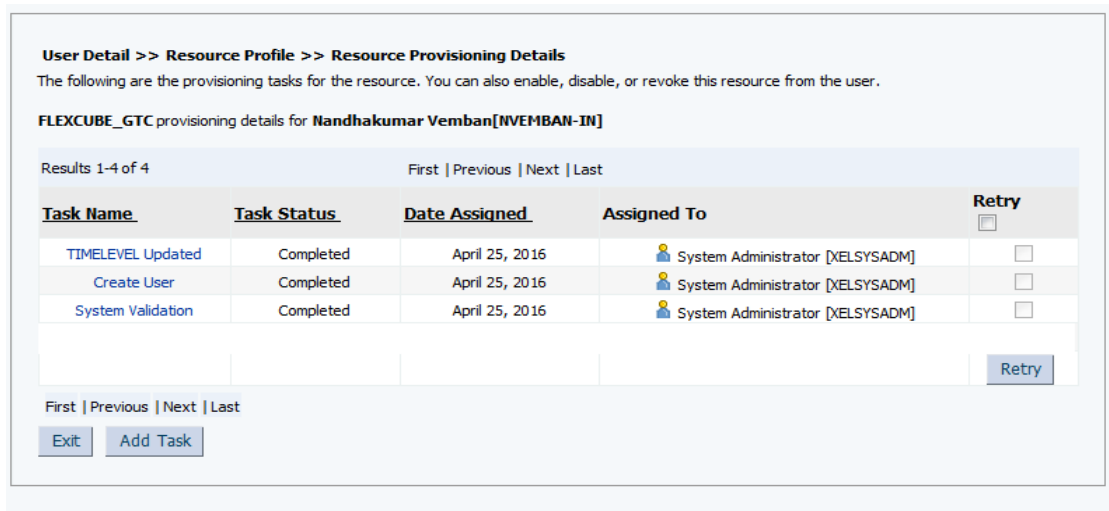

### 6.1.3 Disable/Remove Accounts in FCUBS through OIM

There is a slight difference between Disable and Remove Accounts option. If the account disabled then the same account can be enabled using the Enable option. If the account is Removed then the account cannot be enabled through OIM. But in FCUBS, both Disable and Remove option will close the existing user record.

Remove Accounts will show the Last Known Status

Accounts>>Select FLEXCUBE\_GTC >>Click on Disable/Remove Accounts

The screenshot shows the Oracle Identity Self Service interface for user Nandhakumar Vemban. The 'Accounts' tab is active, displaying a table of application instances. A context menu is open over the first instance, FLEXCUBE\_GTC, with the 'Disable' option highlighted. Below the table, the 'Detail Information' for FLEXCUBE\_GTC is shown.

Application Instance	Resource	Account Name	Provisioned On	Status	Account Type	Request I	Request Entitlement	End Da
FLEXCUBE_GTC	FLEXCUBE_GTC	24	4/25/2016	Provisioned	Primary		Enable	
OID User	OID User	NVEMBAN-IN	4/25/2016	Provisioned	Primary		Disable	

Detail Information for FLEXCUBE\_GTC:

- Name: FLEXCUBE\_GTC
- Display Name: FLEXCUBE\_GTC
- Type: ApplicationInstance
- Category: ApplicationInstance
- Description: FLEXCUBE\_GTC
- Audit Objective:

Disable Confirmation Screen will get displayed

b. Click on Submit.

The screenshot shows the 'Disable Accounts' confirmation screen. The 'Target Users' section lists Nandhakumar Vemban. The 'Cart Items' section shows the application instance FLEXCUBE\_GTC with a green checkmark. A 'Submit' button is highlighted with a red box.

Disable Accounts

Target Users: Nandhakumar Vemban

Cart Items: 24@FLEXCUBE\_GTC, FLEXCUBE\_GTC

Submit

Go to Accounts Tab and Click on Refresh.

a. On successful processing, it will display the FLEXCUBE\_GTC status as Disabled.

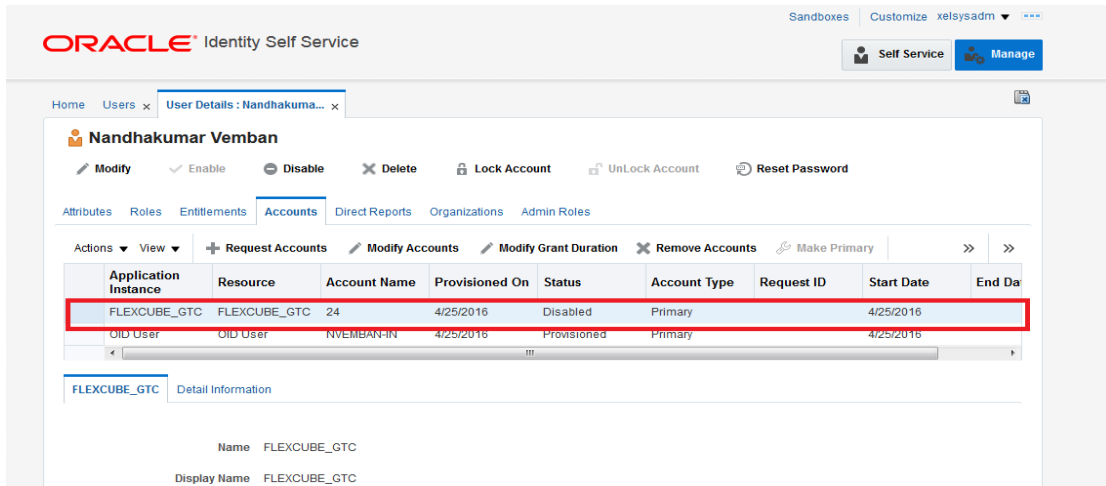

## 6.1.4 Enabling a Disabled user in FCUBS through OIM

Accounts>>Select FLEXCUBE\_GTC >>Click on Enable

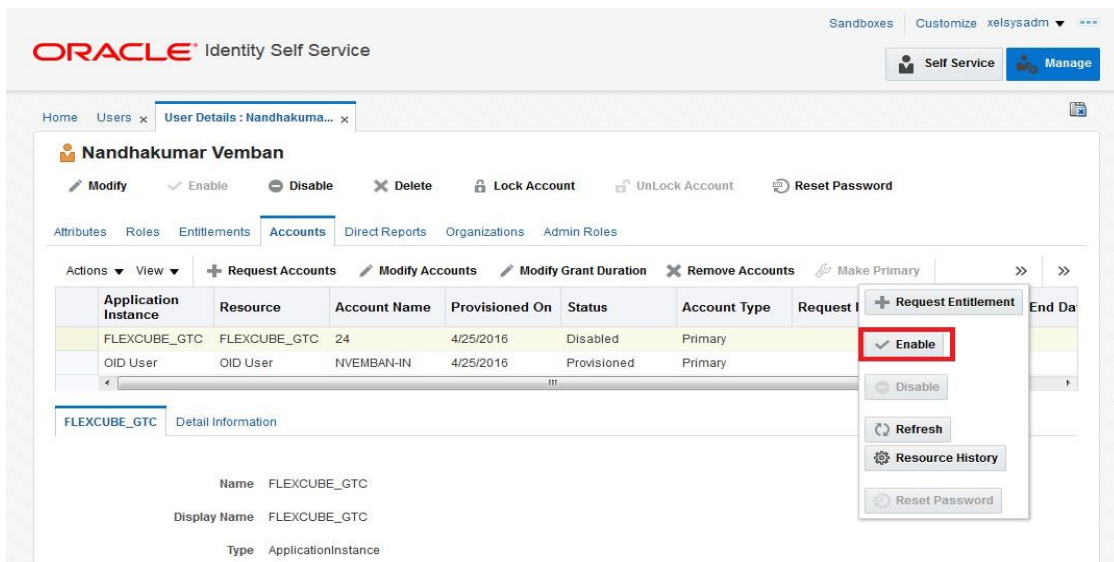

Enable Confirmation Screen will get displayed and Click on Submit

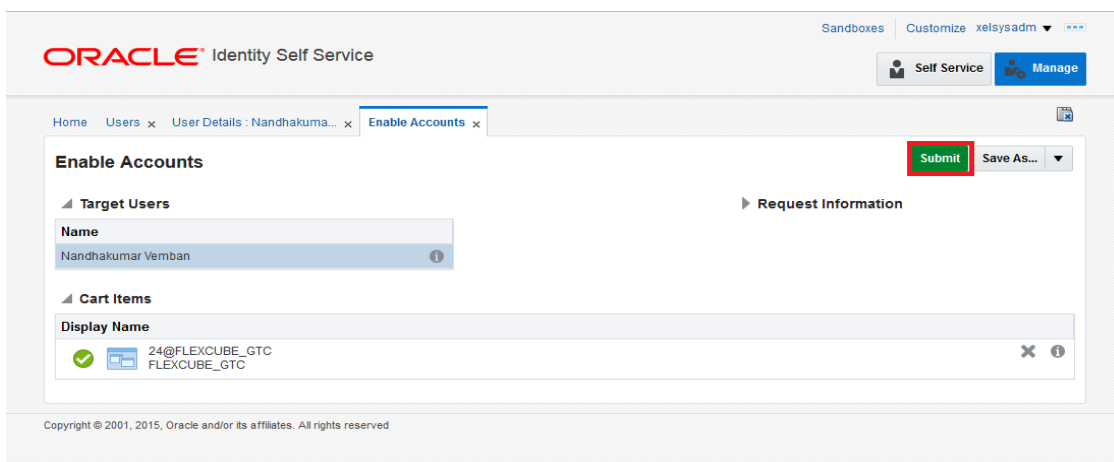

Go to Accounts TAB and Click on Refresh.

a. On successful processing, it will display the FLEXCUBE\_GTC status as Enabled.

The screenshot shows the Oracle Identity Self Service interface for user Nandhakumar Vemban. The 'Accounts' tab is active, displaying a table of account details. The first row, representing the FLEXCUBE\_GTC account, is highlighted with a red border. The table columns are: Application Instance, Resource, Account Name, Provisioned On, Status, Account Type, Request ID, Start Date, and End Date.

Application Instance	Resource	Account Name	Provisioned On	Status	Account Type	Request ID	Start Date	End Date
FLEXCUBE_GTC	FLEXCUBE_GTC	24	4/25/2016	Enabled	Primary		4/25/2016	
OID User	OID User	NVEMBAN-IN	4/25/2016	Provisioned	Primary		4/25/2016	

### 6.1.5 Running Reconciliation in OIM

Copy the reconciliation staging file that is created by function id SMBOIMHF as EOD day activity to the OIM server's staging directory.

Login to OIM Admin Console and Click on Scheduler under System Management.

The screenshot shows the Oracle Identity System Administration console. The left-hand navigation menu is expanded to the 'System Configuration' section. The 'Scheduler' option is highlighted with a red box. Other options in the menu include Organization, Role, Catalog, Home Organization Policy, Self Service Capabilities, Lookups, Role Categories, Notification, Configuration Properties, Import, Export, Upgrade User Form, Upgrade Role Form, and Upgrade Organization Form.

Under System Management tab and search for FLEXCUBE\_GTC Scheduled Job by clicking Search Button.

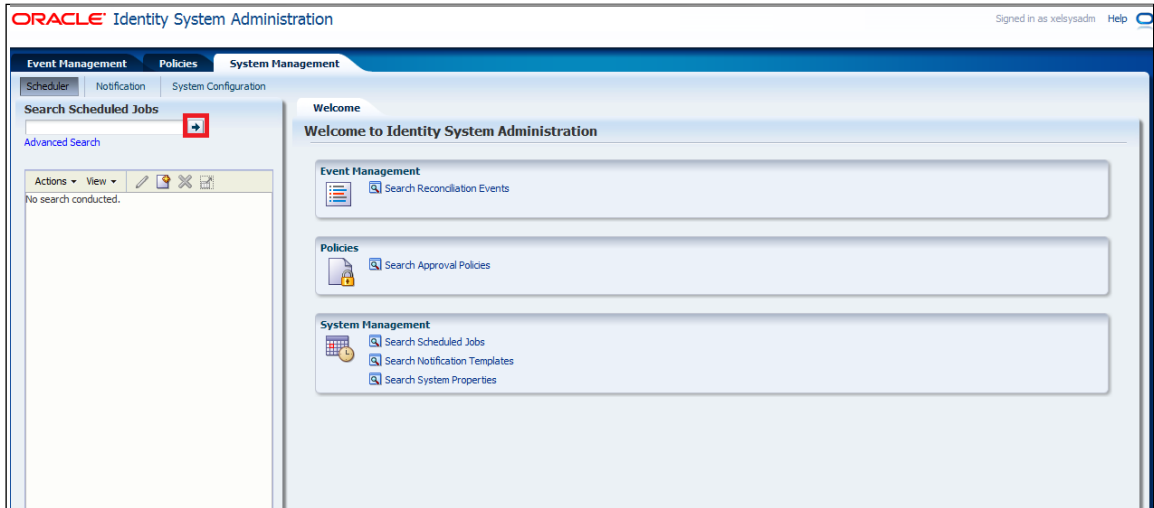

- If the job is scheduled periodically, based on the frequency and scheduled time, system will automatically process the reconciliation. If it not scheduled, user can manually initiate the reconciliation process by clicking the Run Now button.
- After running the process, click Refresh button to view the status of the initiated job. The job history section available in the screen will show whether the job is in progress or it is completed.

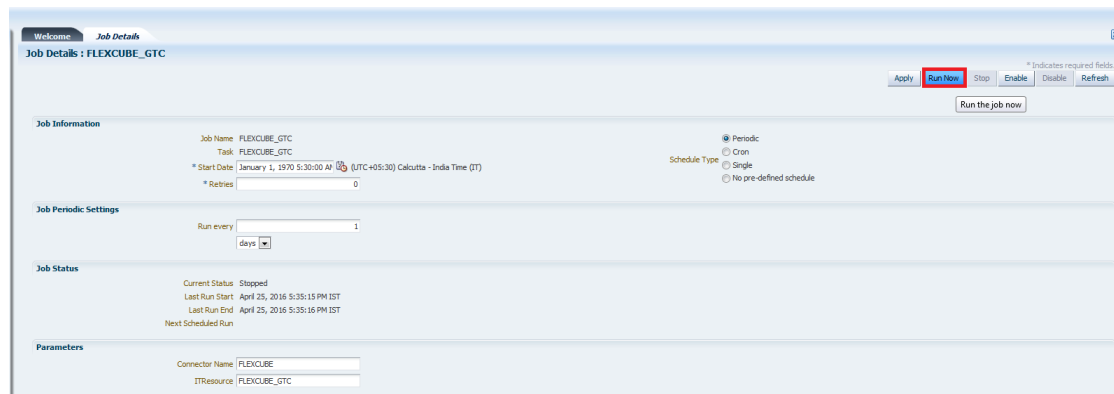
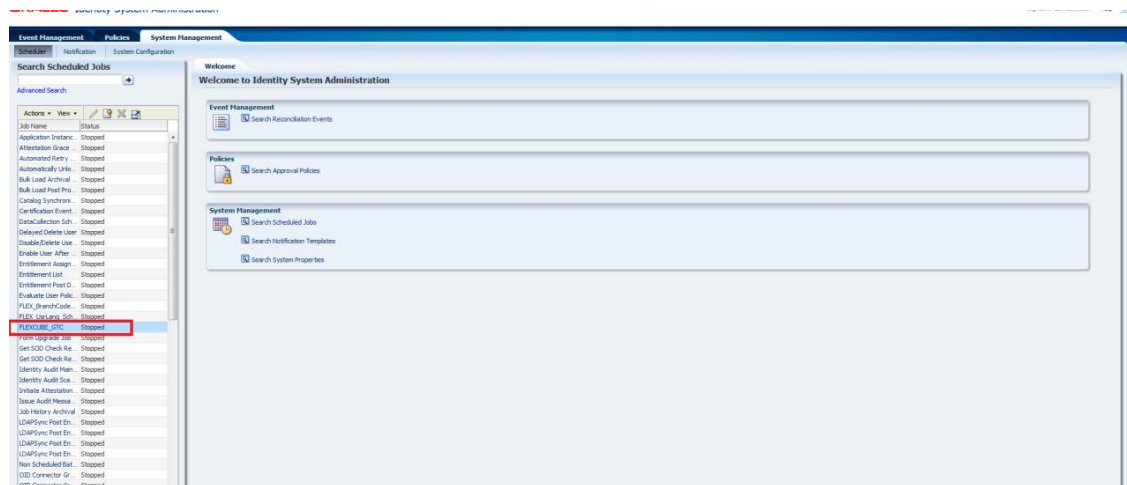



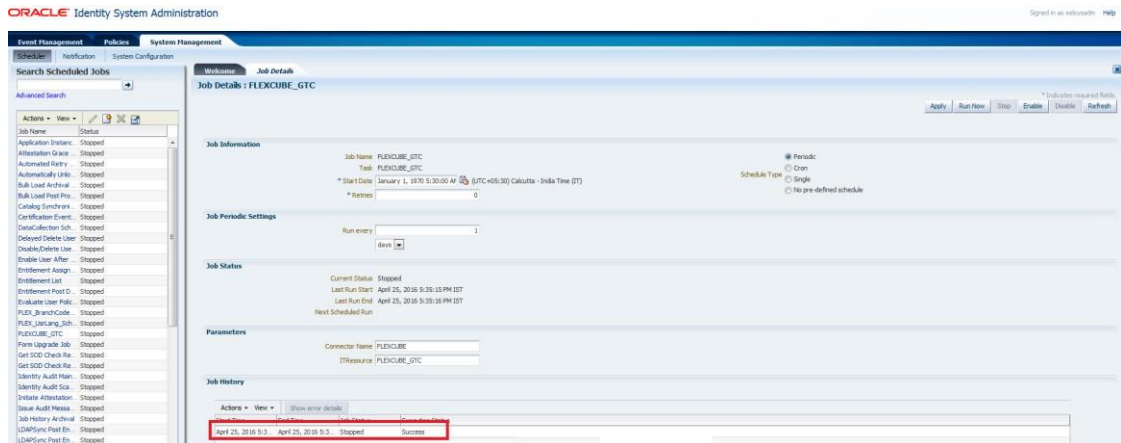

To Check the Status of Reconciliation Process, Click on Event Management Tab and Click the Search button and Click on the Latest Event ID. The screen will show the reconciliation data and the user ID matched for the reconciliation.

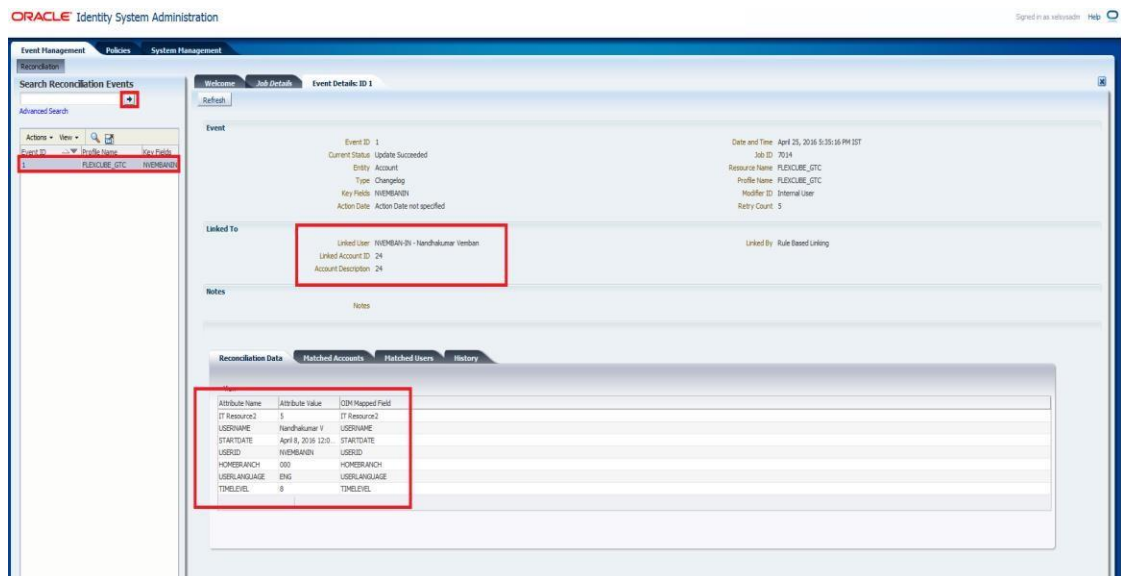

In the Event details screen

- Check the Status: If it is "Update Succeeded" then it means the reconciliation process was able to find a matching user. It also shows the reconciliation data that has been affected.
- If the Liked User is "Not Liked to any user" then it means the reconciliation process was not able to find a matching user.

ORACLE Identity System Administration Signed in as xelsysadm Help

Event Management Policies System Management

Reconciliation

Search Reconciliation Events Advanced Search

Event ID	Profile Name	Key Fields
21	FLEXCUBE_GTC	WKUMAR
1	FLEXCUBE_GTC	ANDY12

Actions View

Welcome Event Details: ID 1 Job Details Event Details: ID 21

Reevaluate Event Close Event Ad Hoc Link Refresh

**Event**

Event ID 21 Date and Time August 26, 2014 3:02:46 PM IST  
 Current Status No User Match Found Job ID 448  
 Entity Account Resource Name FLEXCUBE\_GTC  
 Type Changelog Profile Name FLEXCUBE\_GTC  
 Key Fields WKUMAR Modifier ID Internal User  
 Action Date Action Date not specified Retry Count 5

**Linked To**

Linked User Not linked to any user Linked By

Linked account ID  
 Account Description

**Notes**

Notes

Reconciliation Data Matched Accounts Matched Users History

Attribute Name	Attribute Value	OID Mapped Field
IT Resource2	4	IT Resource2
USERLANGUAGE	ENG	USERLANGUAGE
USERNAME	Anand R	USERNAME
TIMELEVEL	9	TIMELEVEL
HOMEBRANCH	FMG	HOMEBRANCH
STARTDATE	April 8, 2014 12:0...	STARTDATE
USERID	WKUMAR	USERID

Lists all event data

---

## 7. Reference

Document Number	Title
1	<a href="#">Oracle Identity Manager Document.</a>
2	<a href="#">SPML specification Document.</a>

## 8. Appendix

### 8.1 Data Source Creation

1. Open the application server console in the browser by typing Console URL of Weblogic application server

<http://<hostname>:<port>/console/>

2. Login to Administrative Console
3. Enter Weblogic administrator username/password and press Login.



4. Expand Services and click on Data Sources as shown in below screen:

**ORACLE WebLogic Server® Administration Console**

Home > Summary of JDBC Data Sources

**Summary of JDBC Data Sources**

**Configuration** | Monitoring

A JDBC data source is an object bound to the JNDI tree that provides database connectivity through a pool of JDBC connections. Applications can look up a data source on the JNDI tree and then borrow a database connection from a data source.

This page summarizes the JDBC data source objects that have been created in this domain.

**Customize this table**

**Data Sources (Filtered - More Columns Exist)**

Click the **Lock & Edit** button in the Change Center to activate all the buttons on this page.

Name	Type	JNDI Name	Targets
EDNDataSource	Generic	jdbc/EDNDataSource	soa_server1
EDNLocalTxDataSource	Generic	jdbc/EDNLocalTxDataSource	soa_server1
fcjDevDS	Generic	jdbc/fcjDevDS	Applications
fcjdevDS11	Generic	jdbc/fcjdevDS11	Applications
fcjdevDS120	Generic	jdbc/fcjdevDS120	Applications
FCUBS	Generic	jdbc/fcjdevDS	AdminServer, Applications
FCUBS120_XA	Generic	jdbc/fcjdevDS120_XA	Applications
FCUBSScheduler	Generic	jdbc/fcjSchedulerDS	Applications
jdbc/registryDS	Generic	jdbc/registryDS	wls_ods1, wls_of1, osr_server1
mds-om	Generic	jdbc/mds/MDS_REPOS	om_server1

Showing 1 to 10 of 19 Previous | Next

5. Click on Lock & Edit as shown below.

**ORACLE WebLogic Server® Administration Console**

Home > Summary of JDBC Data Sources

**Summary of JDBC Data Sources**

**Configuration** | Monitoring

A JDBC data source is an object bound to the JNDI tree that provides database connectivity through a pool of JDBC connections. Applications can look up a data source on the JNDI tree and then borrow a database connection from a data source.

This page summarizes the JDBC data source objects that have been created in this domain.

**Customize this table**

**Data Sources (Filtered - More Columns Exist)**

Click the **Lock & Edit** button in the Change Center to activate all the buttons on this page.

Name	Type	JNDI Name	Targets
EDNDataSource	Generic	jdbc/EDNDataSource	soa_server1
EDNLocalTxDataSource	Generic	jdbc/EDNLocalTxDataSource	soa_server1
fcjDevDS	Generic	jdbc/fcjDevDS	Applications
fcjdevDS11	Generic	jdbc/fcjdevDS11	Applications
fcjdevDS120	Generic	jdbc/fcjdevDS120	Applications
FCUBS	Generic	jdbc/fcjdevDS	AdminServer, Applications
FCUBS120_XA	Generic	jdbc/fcjdevDS120_XA	Applications
FCUBSScheduler	Generic	jdbc/fcjSchedulerDS	Applications
jdbc/registryDS	Generic	jdbc/registryDS	wls_ods1, wls_of1, osr_server1
mds-om	Generic	jdbc/mds/MDS_REPOS	om_server1

Showing 1 to 10 of 19 Previous | Next

## 6. Expand New and click on Generic Data Source.

The screenshot shows the Oracle WebLogic Server Administration Console. The main content area is titled 'Summary of JDBC Data Sources' and includes a 'Configuration' tab. Below the introductory text, there is a table of data sources. The 'New' button above the table is highlighted with a red box, and a dropdown menu is open, showing 'Generic Data Source' as the selected option. The table contains the following data:

	Type	JNDI Name	Targets
Generic Data Source	Generic	jdbc/EDNDataSource	soa_server1
GridLink Data Source	Generic	jdbc/EDNLocalTxDataSource	soa_server1
Multi Data Source	Generic	jdbc/fgDevDS	Applications
fgDevDS	Generic	jdbc/fgdevDS11	Applications
fgdevDS11	Generic	jdbc/fgdevDS120	Applications
fgdevDS120	Generic	jdbc/fgdevDS120_XA	AdminServer, Applications
FCUBS	Generic	jdbc/fgSchedulerDS	Applications
FCUBS120_XA	Generic	jdbc/registryDS	wls_ods1, wls_of1, osr_server1
FCUBSScheduler	Generic	jdbc/mds/MDS_REPOS	oim_server1
mds-oim			

The following screen will get displayed.

Enter the Data Source Name and JNDI Name as mentioned in the <FCUBS Release Name>\ADAPTERS\OIM\FCUBSLOVAdService\config\lookup\_prop.xml → value of the key FCUBS\_CON\_POOLNAME.

For example value of the key FCUBS\_CON\_POOLNAME is OIM then:

Name	OIM
JNDI Name	jdbc/OIM
Database Type	Oracle

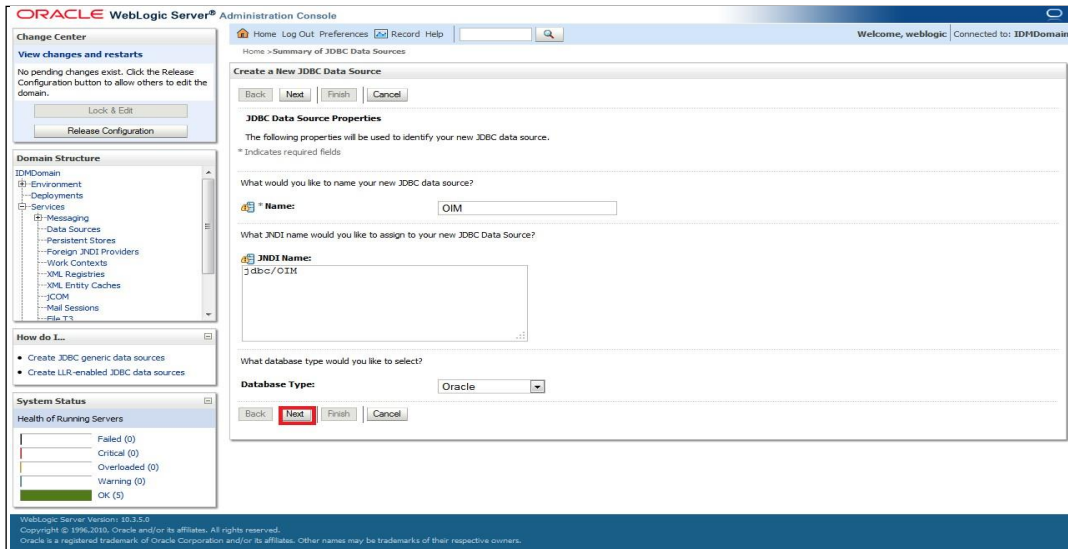

The following screen will get displayed. Select Database Driver as Oracle's Driver (Thin) for Instance connections: Versions 9.0.1 and later. Click on Next.

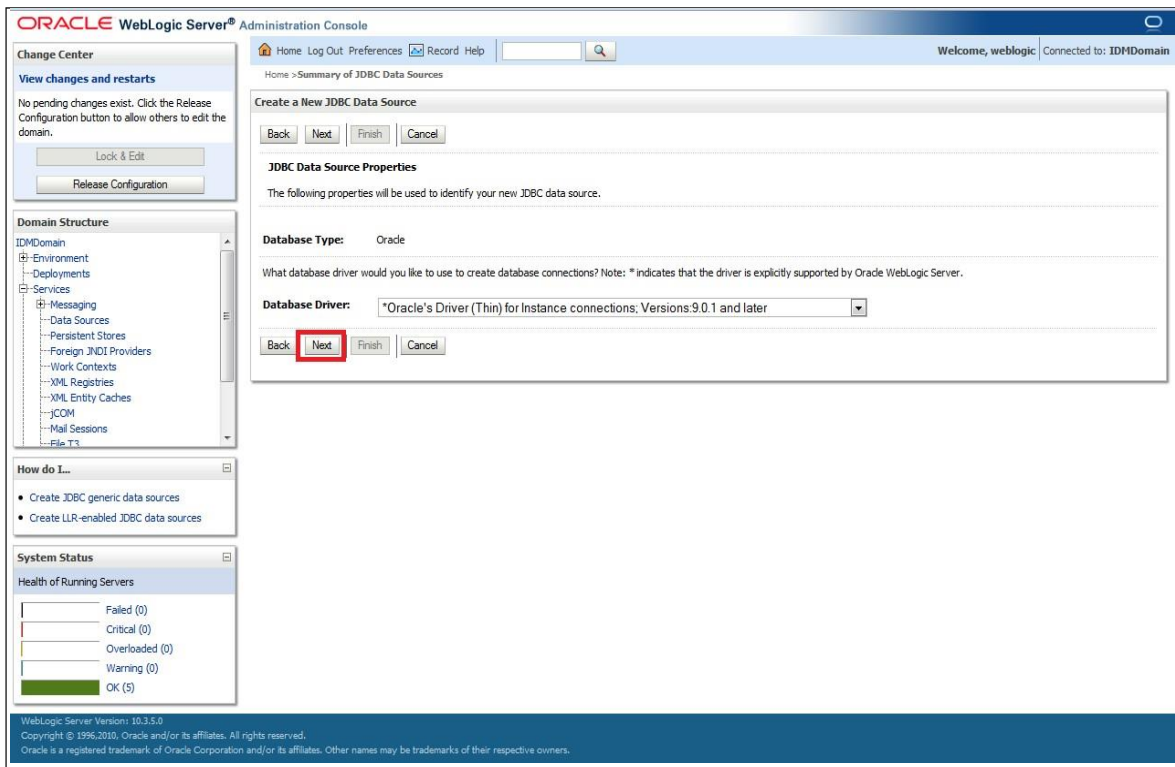

We get the following screen in which un-check Supports Global Transactions and click on Next.



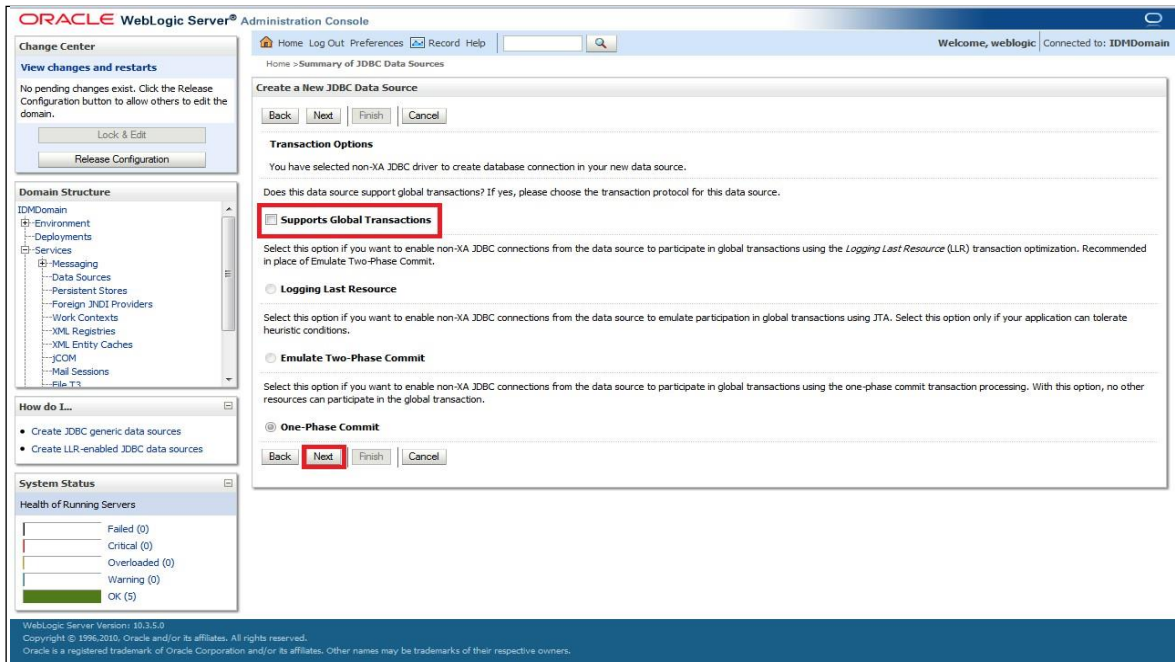

The following screen will get displayed. Enter the Database Name, Host Name, Port, Database User Name, Password and Confirm Password. Click on Next.

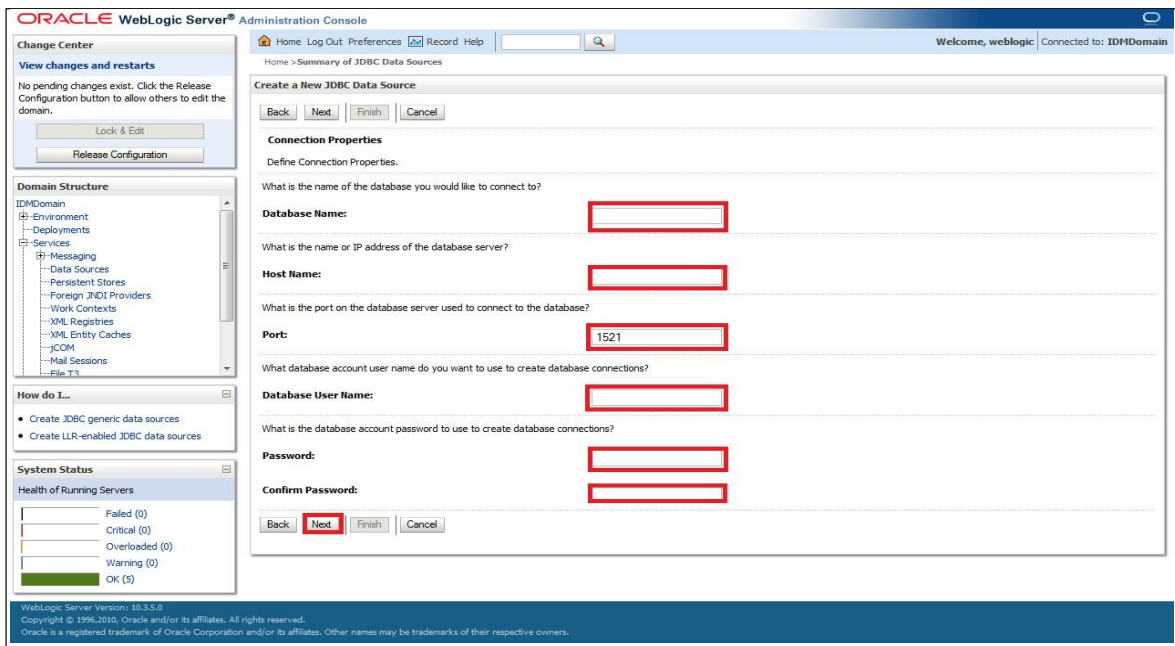

The following screen will get displayed. Click on 'Test Configuration'.

It will display "Connection test succeeded" as shown below. If it is not getting displayed then verify the correctness of all data source properties entered. Click on Finish button.



**ORACLE WebLogic Server® Administration Console**

Home Log Out Preferences Record Help

Welcome, weblogic Connected to: IDMDomain

Messages  
 Connection test succeeded!

Create a New JDBC Data Source  
 Test Configuration Back Next Finish Cancel

**Test Database Connection**  
 Test the database availability and the connection properties you provided.  
 What is the full package name of JDBC driver class used to create database connections in the connection pool?  
 (Note that this driver class must be in the classpath of any server to which it is deployed.)

**Driver Class Name:** oracle.jdbc.OracleDriver

What is the URL of the database to connect to? The format of the URL varies by JDBC driver.  
 (Note that this driver class must be in the classpath of any server to which it is deployed.)

**URL:** jdbc:oracle:thin:@10.11...

What database account user name do you want to use to create database connections?

**Database User Name:** DAY0114

What is the database account password to use to create database connections?  
 (Notes: for secure password management, enter the password in the Password field instead of the Properties field below)

**Password:** DAY0114  
**Confirm Password:** DAY0114

What are the properties to pass to the JDBC driver when creating database connections?

**Properties:**  
 user=DAY0114

The set of driver properties whose values are derived at runtime from the named system property.

The following screen will get displayed. Click on Activate Changes.

**ORACLE WebLogic Server® Administration Console**

Home Log Out Preferences Record Help

Welcome, weblogic Connected to: IDMDomain

Summary of JDBC Data Sources  
 Configuration Monitoring

A JDBC data source is an object bound to the JNDI tree that provides database connectivity through a pool of JDBC connections. Applications can look up a data source on the JNDI tree and then borrow a database connection from a data source.

This page summarizes the JDBC data source objects that have been created in this domain.

Customize this table

Data Sources (Filtered - More Columns Exist)

Name	Type	JNDI Name	Targets
EDNDataSource	Generic	jdbc/EDNDataSource	soa_server1
EDNLocalTxDataSource	Generic	jdbc/EDNLocalTxDataSource	soa_server1
fcjDevDS	Generic	jdbc/fcjDevDS	Applications
fcjDevDS11	Generic	jdbc/fcjDevDS11	Applications
fcjDevDS120	Generic	jdbc/fcjDevDS120	Applications
FCUBS	Generic	jdbc/fcjDevDS	AdminServer, Applications
FCUBS120_XA	Generic	jdbc/fcjDevDS120_XA	Applications
FCUBSScheduler	Generic	jdbc/fcjSchedulerDS	Applications
jdbc/registryDS	Generic	jdbc/registryDS	wls_ods1, wls_of1, osr_server1
mds-om	Generic	jdbc/mds/MDS_REPOS	oim_server1

WebLogic Server Version: 10.3.5.0  
 Copyright © 1996-2010, Oracle and/or its affiliates. All rights reserved.  
 Oracle is a registered trademark of Oracle Corporation and/or its affiliates. Other names may be trademarks of their respective owners.



Oracle Identity Manager Integration Implementation Guide  
[May] [2024]  
Version 14.7.4.0.0

Oracle Financial Services Software Limited  
Oracle Park  
Off Western Express Highway  
Goregaon (East)  
Mumbai, Maharashtra 400 063  
India

Worldwide Inquiries:  
Phone: +91 22 6718 3000  
Fax: +91 22 6718 3001  
<https://www.oracle.com/industries/financial-services/index.html>

Copyright © [2007], [2024], Oracle and/or its affiliates. All rights reserved.

Oracle and Java are registered trademarks of Oracle and/or its affiliates. Other names may be trademarks of their respective owners.

**U.S. GOVERNMENT END USERS:** Oracle programs, including any operating system, integrated software, any programs installed on the hardware, and/or documentation, delivered to U.S. Government end users are "commercial computer software" pursuant to the applicable Federal Acquisition Regulation and agency-specific supplemental regulations. As such, use, duplication, disclosure, modification, and adaptation of the programs, including any operating system, integrated software, any programs installed on the hardware, and/or documentation, shall be subject to license terms and license restrictions applicable to the programs. No other rights are granted to the U.S. Government.

This software or hardware is developed for general use in a variety of information management applications. It is not developed or intended for use in any inherently dangerous applications, including applications that may create a risk of personal injury. If you use this software or hardware in dangerous applications, then you shall be responsible to take all appropriate failsafe, backup, redundancy, and other measures to ensure its safe use. Oracle Corporation and its affiliates disclaim any liability for any damages caused by use of this software or hardware in dangerous applications.

This software and related documentation are provided under a license agreement containing restrictions on use and disclosure and are protected by intellectual property laws. Except as expressly permitted in your license agreement or allowed by law, you may not use, copy, reproduce, translate, broadcast, modify, license, transmit, distribute, exhibit, perform, publish or display any part, in any form, or by any means. Reverse engineering, disassembly, or decompilation of this software, unless required by law for interoperability, is prohibited.

The information contained herein is subject to change without notice and is not warranted to be error-free. If you find any errors, please report them to us in writing.

This software or hardware and documentation may provide access to or information on content, products and services from third parties. Oracle Corporation and its affiliates are not responsible for and expressly disclaim all warranties of any kind with respect to third-party content, products, and services. Oracle Corporation and its affiliates will not be responsible for any loss, costs, or damages incurred due to your access to or use of third-party content, products, or services.