

Messaging User Guide
Oracle Banking Payments
Release 14.7.4.0.0

Part No. G10007-01

June 2024

Messaging User Guide
Oracle Financial Services Software Limited

Oracle Park

Off Western Express Highway
Goregaon (East)
Mumbai, Maharashtra 400 063
India

Worldwide Inquiries:

Phone: +91 22 6718 3000

Fax: +91 22 6718 3001

www.oracle.com/financialservices/

Copyright © 2017, 2024, Oracle and/or its affiliates. All rights reserved.

Oracle and Java are registered trademarks of Oracle and/or its affiliates. Other names may be trademarks of their respective owners.

U.S. GOVERNMENT END USERS: Oracle programs, including any operating system, integrated software, any programs installed on the hardware, and/or documentation, delivered to U.S. Government end users are “commercial computer software” pursuant to the applicable Federal Acquisition Regulation and agency-specific supplemental regulations. As such, use, duplication, disclosure, modification, and adaptation of the programs, including any operating system, integrated software, any programs installed on the hardware, and/or documentation, shall be subject to license terms and license restrictions applicable to the programs. No other rights are granted to the U.S. Government.

This software or hardware is developed for general use in a variety of information management applications. It is not developed or intended for use in any inherently dangerous applications, including applications that may create a risk of personal injury. If you use this software or hardware in dangerous applications, then you shall be responsible to take all appropriate failsafe, backup, redundancy, and other measures to ensure its safe use. Oracle Corporation and its affiliates disclaim any liability for any damages caused by use of this software or hardware in dangerous applications.

This software and related documentation are provided under a license agreement containing restrictions on use and disclosure and are protected by intellectual property laws. Except as expressly permitted in your license agreement or allowed by law, you may not use, copy, reproduce, translate, broadcast, modify, license, transmit, distribute, exhibit, perform, publish or display any part, in any form, or by any means. Reverse engineering, disassembly, or decompilation of this software, unless required by law for interoperability, is prohibited.

The information contained herein is subject to change without notice and is not warranted to be error-free. If you find any errors, please report them to us in writing.

This software or hardware and documentation may provide access to or information on content, products and services from third parties. Oracle Corporation and its affiliates are not responsible for and expressly disclaim all warranties of any kind with respect to third-party content, products, and services. Oracle Corporation and its affiliates will not be responsible for any loss, costs, or damages incurred due to your access to or use of third-party content, products, or services.

Contents

1. About this Manual	1-1
1.1 Introduction	1-1
1.2 Audience	1-1
1.3 Documentation Accessibility	1-1
1.4 Organization	1-1
1.5 Glossary of Icons	1-2
2. Overview	2-1
2.1 Message Flow Diagrams	2-1
2.2 Key Features of Messaging	2-3
2.2.1 Rule Parameter	2-3
2.2.2 Rule Definition	2-3
2.2.3 Rule Group	2-4
2.2.4 Rule Priority	2-4
3. File Exchange	3-1
3.1 Basic Maintenance for File Exchange	3-1
3.2 File Transmission over SWIFTNet	3-2
3.2.1 Connector Network Linkage Maintenance	3-3
3.2.2 Connector - File Type Linkage Maintenance	3-4
4. SWIFT Messages	4-1
4.1 Outgoing Message Browser	4-1
4.1.1 Viewing Outgoing Message Browser Summary	4-1
4.1.2 Invoking Outgoing Message Browser Screen	4-2
4.2 Incoming Message Browser	4-5
4.2.1 Viewing Incoming Message Browser Summary	4-5
4.2.2 Invoking Incoming Message Browser Screen	4-8
4.3 Bulking and De-bulking	4-10
4.4 Local Authentication	4-11
4.4.1 Viewing SWIFT LAU Key Summary	4-12
4.4.2 Detailed Processing Logic for Incoming SWIFT LAU	4-13
4.5 SWIFT FIN Header Configuration	4-13
4.5.1 SWIFT FIN Header Preference	4-13
4.5.2 SWIFT FIN Header Host Preference	4-15
4.5.3 SWIFT FIN Header Processing	4-16
5. SWIFT Messages Via Blockchain	5-1
5.1 SWIFT Message Routing Parameter Detailed	5-1
5.1.1 SWIFT Message Routing Parameter Summary	5-2
5.2 DLT Message Browser Summary	5-3
5.2.1 Retry	5-3
5.3 SWIFT Message Processing	5-4
6. Fedwire Messages	6-1
6.1 Fedwire Message Mapping	6-1
6.1.1 Fedwire Message Mapping Summary	6-2
6.1.2 SWIFT Message Notifications	6-3

7. Function ID Glossary 7-1

1. About this Manual

1.1 Introduction

This manual is designed to help you to quickly get familiar with the messaging functionalities of Oracle Banking Payments in addition to the electronic messaging support available as part of Common-Core. It takes you through the various stages in Messaging functionality.

You can further obtain information specific to a particular field by placing the cursor on the relevant field and striking <F1> on the keyboard.

1.2 Audience

This manual is intended for the following User/User Roles:

Role	Function
Payment Department Operators	Messaging functions Input functions except Authorization.
Back Office Payment Department Operators	Messaging monitoring maintenances/Payment Transaction Input functions except Authorization
Payment Department Officers	Messaging monitoring and authorization
Bank's Financial Controller/ Payment Department Manager	Host level processing related setup for PM module and PM Query functions

1.3 Documentation Accessibility

For information about Oracle's commitment to accessibility, visit the Oracle Accessibility Program website at <http://www.oracle.com/pls/topic/lookup?ctx=acc&id=docacc>.





1.4 Organization

This manual is organized into the following chapters.:

Chapter	Description
Chapter 1	<i>About this Manual</i> gives information on the intended audience. It also lists the various chapters covered in this User Manual.
Chapter 2	<i>Messaging</i> provides information on Messaging functionality in Oracle Banking Payments.
Chapter 3	<i>Function ID Glossary</i> has alphabetical listing of Function/Screen ID's used in the module with page references for quick navigation.

1.5 Glossary of Icons

This User Manual may refer to all or some of the following icons:

Icons	Function
	Exit
	Add row
	Delete row
	Option List

2. Overview

This document details bulker, de-bulker, router and the SWIFTNet connectivity framework to be built in the Oracle Banking Payments to send the bulked files to the SWIFTNet network through SAG with the File Act protocol.

The files are bulked and stored on Application server. The file from Application server will be transmitted to SWIFT over FTA.'

The system technically bulk MT messages and routes them to configured destination.

The system transmits and receives bulked files from SWIFT Network using SAG interface, through the FTA (Folder) connector.

This chapter contains the following sections:

- [Section 2.1, "Message Flow Diagrams"](#)
- [Section 2.2, "Key Features of Messaging"](#)
- [Section 2.3, "Basic Maintenance for File Exchange"](#)
- [Section 2.4, "Bulking and De-bulking of SWIFT MT Messages"](#)
- [Section 2.5, "File Transmission over SWIFTNet"](#)
- [Section 2.6, "SWIFT LAU"](#)
- [Section 2.7, "SWIFT Message Routing Parameter Maintenance"](#)

2.1 Message Flow Diagrams

The below flow diagram depicts the flow of outgoing message:

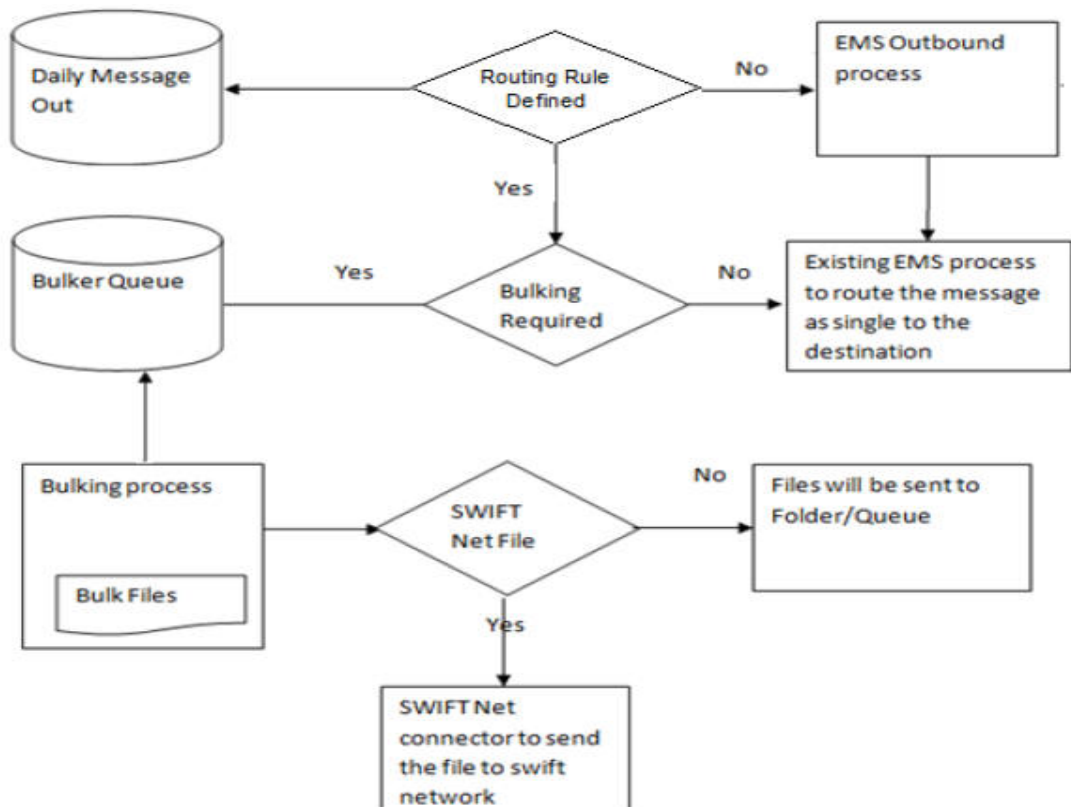

The below diagram depicts the flow of incoming message:

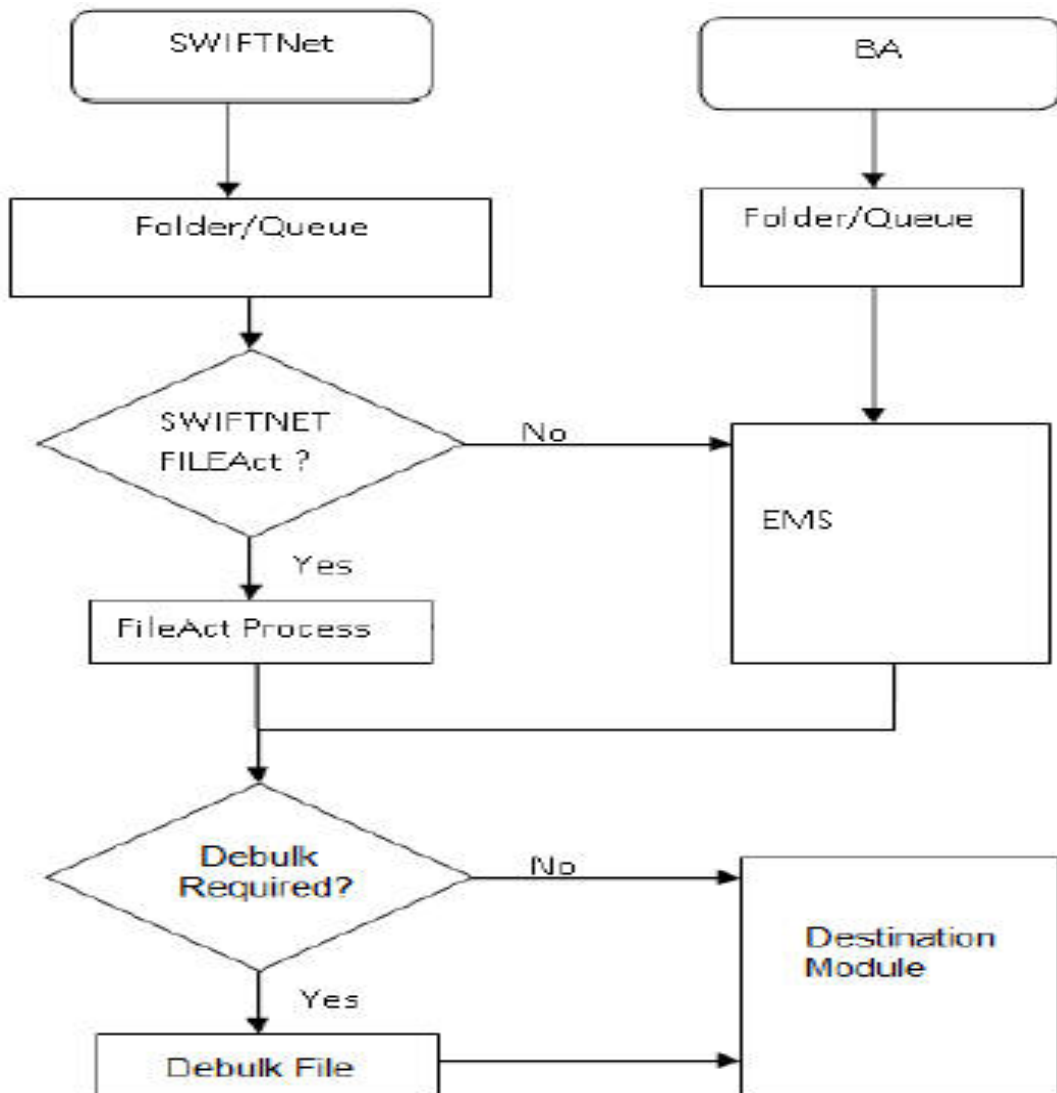

The below diagram depicts the flow diagram of data exchange with SWIFTNet.

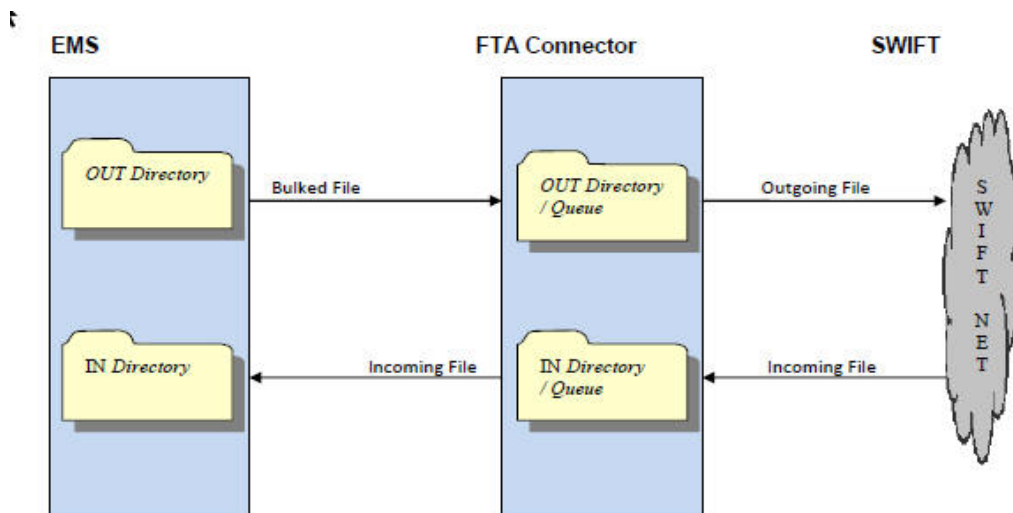

2.2 Key Features of Messaging

Routing rules are defined for each module. Using these routing rules the messages are sent to the mapped destinations. To achieve this multiple maintenances are introduced.

- Rule definition – This screen is used to define the rule and respective destination.
- Rule Group – This maintenance is used to map the modules to different rule groups.
- Rule Priority – This maintenance is used to prioritise the rules.

The following functionalities are developed to support the routing of messages to different destinations.

2.2.1 Rule Parameter

Rule parameters are part of day zero set up. There is no user interface to maintain this.

The following set of standard rule parameters is used for all types of rule definition-

- Amount
- Currency
- Media
- Network Code
- Sender BIC
- Receiver BIC
- Message Type
- Module Name

2.2.2 Rule Definition

Rule configuration maintenance is provided to define the rule and to map it to a specific destination. Standard set of parameters are available while defining a rule. You can also provide values manually for evaluating the rules. On the same screen an option is provided to map a rule to its destination. Each rule must belong to a rule group.

Messaging provides a router implementation which evaluates configured rules and identifies the destination for a message dynamically. The routing capabilities in messaging include the ability to define/modify rule configurations based on a set of pre-defined routing parameters. These parameters are stored in the Database and for each routing configuration; the values for these routing parameters are calculated at runtime, thus enabling dynamic routing configuration.

Destination for any message is mapped on the rule definition screen. This is done by specifying the rules which unambiguously lead to the selection of a single destination to be used for outward transmission of data from messaging.

Routing configuration supports routing based on the messaging standard parameters.

Routing rules can be mapped to the following entities in the system.

- Connectivity Lines
- Bulker
- De-bulker
- Folder
- Queue

2.2.3 Rule Group

You can group one or more modules into different groups. Based on the rule groups a module is associated with, mapped rules are executed to identify the qualifying rule definition and thus destination for any message.

Each module can belong to only one rule group to avoid ambiguous results.

The modules for which routing rules should be used for identifying the destination is added to a default rule group as part of day zero script.

When a message is received from a modules that is not a part of any rule group, the existing EMS flow is considered to identify its destination.

2.2.4 Rule Priority

You can provide priority of rules belonging to a rule group. Based on this priority, rules are executed to identify the qualifying rule definition and thus destination for any message. First rule that matches the message properties is used to identify the destination for that message.

3. File Exchange

3.1 Basic Maintenance for File Exchange

A message is routed to the specific SWIFT connector, bulker, folder or queue if they meet certain user-defined criteria.

Routing Rules are defined for each module. Using these routing rules, the messages are sent to the mapped destinations. To achieve this, the following maintenances are introduced:

- Rule Definition - Used for defining rules and respective definitions.
- Rule Group - Used for mapping modules to different groups
- Rule Priority - Used for prioritizing rules

Below listed key maintenances are referred for File exchange processing:

- Distinguished Name Definition (MSDDSTNM)
 - The Distinguished Name (DN) serves to uniquely identify any entity that sends or receives messages over SWIFTNet.
 - Distinguished name follow an X.500-compliant naming convention. Refer the SWIFTNet Naming and Address Guide from SWIFT for more details.
- SWIFTNet Service Definition (MSDSWTSR)
 - This screen is used to capture SWIFTNet service details.
 - SWIFT Net service should be a valid SWIFT Net service to which the bank has registered to send the message.
 - When the message is sent through the File Act, the service name attribute is sent with the envelope.
 - This service name defined from this screen gets listed in the protocol parameters to choose the service name, which is used for constructing the envelope to send to SWIFT Net.
- Protocol Parameter Definition (MSDPTPRM)
 - This screen is used to capture protocol parameters for FTA protocol used to connect to SWIFT Net. These are additional SWIFTNet connectivity attributes, which are required for SWIFTNet file transfer and communication with SWIFT Network.
- Rule Definition (MSDRLDFN)
 - The Rule Definition screen is provided in EMS module to capture the Rule details.
- Rule Group Definition (MSDRLGRP)
 - Rule Group Definition screen is provided to capture the Rule group details. A logical grouping of the routing rules can be done using this group name.
 - Populate Rules button populates all the routing rules defined which can be moved or swapped.
 - On click of 'populate rules' all the rules marked for the group are listed and priority of which can be changed.
 - From the populated list select a rule priority for swapping and enter another priority visible on search result in Move to/Swap to field to swap the selected rule priority with the priority entered.
 - From the populated list select a priority for moving and enter another priority visible on search result in Move to/Swap to field to move the selected rule priority with the priority entered.

- Rule Group Mapping (MSDRLMAP)
 - Modules can be mapped to the rule groups defined.
 - In case a rule group is mapped to the module then all the rules from rule group are executed and the destination is derived.
 - If there is no rule group mapping for the module then the normal EMS flow should get executed.

For more details about fields of above mentioned maintenance screens, refers to Common Core - Electronic Messaging Service User Guide.

3.2 **File Transmission over SWIFTNet**

The following are the list of functionalities that are part of File Transmission over SWIFTNet:

- A framework that provides the SWIFTNet connectivity for the bulked SWIFT FIN files that were generated by bulker.
- New Maintenance functions to capture configurations that are required to connect SWIFTNet via SAG File Act
- Monitoring and tracking function to track FileAct processing within the system.

Below listed key maintenances are referred for File exchange processing:

- File Transfer Adapter Connector Configuration (MSDFTACN)
 - This new screen is used to capture the parameters required for SWIFT Net FileAct connectivity using FTA.
 - They define the mode of transmission and the parameters required to actually perform the message transmission.
- Connectivity Operation Manager (MSDCNMGR)
 - This screen is used to start and stop the connectivity lines.
 - You can search for the connectivity lines and perform the operation start/stop on the line searched.
- Outbound File Browser (MSSFLBRW)
 - This screen is used to view the bulk files generated for the bulk criteria maintained in the system.
 - You can search based on the Bulk criteria (rule) name, Generated date, File Name and Status.
 - File details like name of the bulker file, status, bulk rule name, file generated time, bulk reference number, Size of the file; number of transactions bulked is shown in the details.
 - File can be resent to the destination if the file status is not processed.
- Inbound File Browser screen (MSSIFBRW)
 - This new screen can be used to view the bulk files received from SWIFT Net through the FileAct connectors.
 - You can search based on the File Name, Received date time and status of the file.
 - Files received through FileAct connectors is sent to the EMS after parsing the payload file.
 - De-bulking of the file happen in the EMS.

For more details about fields of above mentioned maintenance screens, refers to Common Core - Electronic Messaging Service User Guide.

3.2.1 Connector Network Linkage Maintenance

You can link the SWIFTNet connector with the Network defined in OBPM, using this screen.

You can invoke 'Connector Network Linkage Maintenance' screen by typing 'PMDCONNW' in the field at the top right corner of the Application tool bar and clicking on the adjoining arrow button. Click 'New' button on the Application toolbar.

The screenshot shows a web-based application window titled "Connector Network Linkage Maintenance". The window has a standard toolbar at the top with a "New" button and an "Enter Query" button. Below the toolbar, there are two main sections. The left section contains three input fields: "Host Code *", "Connector Name *", and "Network Code *", each with a search icon to its right. The right section contains two input fields: "Host Code Description" and "Connector Type". At the bottom right of the window, there are "Audit" and "Exit" buttons.

You can specify the following:

Host Code

This field is defaulted as the logged in Host.

Host Code Description

System defaults the Host Description of the Host Code defaulted.

Connector Name

Specify the Connector Name from the list of values. All open and authorized connectors maintained and linked to the Host in the maintenances FTA Connector Configuration (Function ID: MSDFTACN) and MQHA Connector Configuration (Function ID: MSDMQHAC) are listed.

Connector Type

Specify the Connector Type of the Connector Name selected.

Network Code

Specify the Network Code from the list of values. All open and authorized Network codes of payment type SEPA CT and SEPA DD are listed

3.2.1.1 Connector Network Linkage Maintenance Summary

You can invoke 'Connector Network Linkage Maintenance Summary' screen by typing 'PMSCONNW' in the field at the top right corner of the Application tool bar and clicking on the adjoining arrow button. Click 'Search' button on the Application toolbar.

Connector Network Linkage Maintenance Summary

Search Advanced Search Reset Clear All Records per page 15

Search (Case Sensitive)

Authorization Status Record Status Network Code Connector Name

Search Results Lock Columns 0

Authorization Status	Record Status	Host Code	Network Code	Connector Name	Connector Type
No data to display.					

Page 1 of 1

Exit

You can search using one or more of the following parameters:

- Authorization Status
- Record Status
- Host Code
- Network Code
- Costumer Name

Once you have specified the search parameters, click 'Search' button. The system displays the records that match the search criteria.

3.2.2 Connector - File Type Linkage Maintenance

You can link the SWIFTNet connector and Network with the File Type defined Non CSM SEPA CT/SEPA DD files, using this screen. This can be a standalone maintenance without maintaining Connector Network linkage maintenance (PMDCONNW).

You can invoke 'Connector - File Type Linkage Maintenance' screen by typing 'PMDCONFL' in the field at the top right corner of the Application tool bar and clicking on the adjoining arrow button. Click 'New' button on the Application toolbar.

Connector - File Type Linkage Maintenance

New Enter Query

Host Code * Connector Name * Network Code * Message Type * Message Version * XSD Path * XSD Name *

Host Code Description Connector Type

Audit Exit

You can specify the following:

Host Code

This field is defaulted as the logged in Host.

Host Code Description

System defaults the Host Description of the Host Code defaulted.

Connector Name

Specify the Connector Name from the list of values. Lists the combinations of all open and authorized maintenances available in PMDCONNW for the connector name and Network.

Connector Type

System defaults the Connector Type of the Connector Name selected.

Network Code

Specify the Network Code from the list of values. The list contains all valid SCT /SDD Networks.

Message Type

Select the Message type and message version combination from the list of values.

Message Version

System defaults the Message Version based on the message version selected from message type field list of values.

XSD Path

Specify the XSD Path.

XSD Name

System defaults the XSD Name of the Message Type selected. User can change the same, if required.

3.2.2.1 Connector - File Type Linkage Maintenance Summary

You can invoke 'Connector - File Type Linkage Maintenance Summary' screen by typing 'PMSCONFL' in the field at the top right corner of the Application tool bar and clicking on the adjoining arrow button. Click 'Search' button on the Application toolbar.

The screenshot shows the 'Connector - File Type Linkage Maintenance Summary' application window. At the top, there is a search bar with 'PMSCONFL' entered. Below the search bar, there are several search criteria fields: 'Authorization Status', 'Record Status', 'Connector Name', 'Message Type', 'Network Code', and 'XSD Path'. A 'Search' button is visible. Below the search fields, there is a table with the following columns: 'Authorization Status', 'Record Status', 'Connector Name', 'Connector Type', 'Message Type', 'Host Code', 'Network Code', 'XSD Path', and 'XSD Name'. The table currently displays 'No data to display.' The page number is 1 of 1, and there are navigation buttons for first, previous, next, and last. An 'Exit' button is located at the bottom right of the screen.

You can search using one or more of the following parameters:

- Authorization Status

- Record Status
- Connector Name
- Message Type
- Network Code

Once you have specified the search parameters, click 'Search' button. The system displays the records that match the search criteria.

4. SWIFT Messages

4.1 Outgoing Message Browser

4.1.1 Viewing Outgoing Message Browser Summary

You can invoke “Outgoing Message Browser Summary” screen by typing ‘PMSOUTBR’ in the field at the top right corner of the Application tool bar and clicking on the adjoining arrow button.

The screenshot displays the 'Outbound Browser Summary' application window. At the top, there is a title bar with window controls and a search field containing 'PMSOUTBR'. Below the title bar, there are search options: 'Search', 'Advanced Search', 'Reset', and 'Clear All'. A 'Records per page' dropdown is set to 15. The main search area is titled 'Search (Case Sensitive)' and contains a grid of search filters. The filters are organized into three columns: the first column includes Branch, Module, Message Format, SWIFT Message Type, Hold/Release Status, Delivery Status, and Funding Status; the second column includes Document Number, Message Type, Receiver, Swift MX Type, Acknowledgement Status, Handoff Status, and Network; the third column includes Reference Number, Connectivity Option, Media, Message Status, Authorization Status, Destination Type, and Network Acknowledgement Status. Below the search filters is a 'Search Results' section with a 'Lock Columns' dropdown set to 0. The results table has columns for Branch, Document Number, Reference Number, Module, Message Type, Connectivity Option, Message Format, Receiver, Currency, Amount, Media, and SWIFT Message Type. The table currently shows 'No data to display.' and a pagination bar indicating 'Page: 1 Of 1'. At the bottom of the window, there is a toolbar with buttons for View, Edit, Hold, Cancel, Release, Authorize, Handoff, Suppress, Generate, Print, and Exit.

You can search using one or more of the following parameters:

- Branch
- Document Number
- Reference Number
- Module
- Message Type
- Connectivity Option
- Message Format
- Receiver
- Media
- SWIFT Message Type
- Swift MX Type
- Message Status
- Hold/Release Status
- Acknowledgement Status
- Authorization Status
- Delivery Status
- Handoff Status
- Destination Type
- Funding Status
- Network
- Network Acknowledgement Status

Note

Queue Access rights is applicable for Outgoing Browser Summary (PMSOUTBR). Refer to Exception Queues user guide, for details on Queue Access Rights.

Once you have specified the search parameters, click 'Search' button. The system displays the records that match the search criteria.

The following are the actions can be performed on the resultant search results:

- View - Displays the selected message
- Edit - Edit and change message content, if not handed off yet
- Hold - Hold a message, if generated & not handed off yet
- Cancel - Cancel a message, which is not handed off yet
- Release - Release a message, if withheld due to a hold rule
- Suppress - Suppress a message, if not handed off yet
- Authorize - Authorize the edited message
- Handoff - Handoff a message to SWIFT alliance, if not released yet
- Generate - Generate a message which is un-generated status
- Print - Print a generated message

Note

- Only Release/Suppress Actions are allowed on messages that are marked as 'Withheld' and requires authorization by another user.
 - Messages that are marked as 'Withheld' can be manually released any time, even before the release rule start time. Release time gets updated on authorization of manual release.
 - If a payment message marked as 'Withheld' is Released on any other business day after 'Message Date', then the system shows 'This payment message cannot be released' information message. Such payment messages are allowed to be suppressed from the outbound browser.
 - Any message with Message Status Un-generated can be generated using the Generate action.
 - A generated or handed off message can be printed using Print action.
 - SWIFT LAU generated for the outgoing SWIFT MT message for payments can be viewed from the Payments Outgoing message browser screen.
 - SWIFT LAU is displayed in summary result which shows the LAU generated for the message.
-

4.1.2 Invoking Outgoing Message Browser Screen

Additional fields are introduced in the outgoing browser to track the status of the message and along with bulk criteria and bulk reference number.

The new fields are bulk status, bulk file reference number and bulk preference name.

If the message is not satisfied with any of the bulk rule defined in the system, then bulk status will be marked as NA (Bulking not applicable).

You can Double click a record or click the 'Details' button after selecting a record in "Outgoing Message Browser Summary" screen 'PMSOUTBR to view the details in 'Message Outgoing Browser' screen PMDOUTBR' screen.

You can specify the following fields:

Operation

The system displays the type of operation.

Any or Original

The system displays if the message was 'Any' or 'Original'.

Message Details

Document Number

Specify the Document Number.

Message Status

The system displays the status of the message.

Reference Number

Specify the reference number

Hold/Release Status

The system displays if the message is in Hold or Released status.

Module

Specify the module name.

Acknowledgement Status

The system displays the acknowledgement status of the message.

Message Type

Specify the type of message.

External Reference

Specify the external reference details.

Receiver

Specify the Receiver details.

Delivery By

Specify the Delivery details of the message.

Currency

Specify the currency that is specified in the message.

RTGS Network

Specify the RTGS Network.

Testing Status

The system checks this box, if the message requires testing.

DCN List

Specify the DCN List details.

Receiver Details**Name**

Specify the name of the Receiver.

Node

Specify the Receiver Node.

Location

Specify the location of the Receiver.

Branch

Specify the branch of the Receiver.

Address

Specify the address details of the Receiver in the lines provided from 1 o 4.

SWIFT Message Type

Specify the SWIFT Message Type.

Priority

The system displays the priority of the message.

Hold Mail

The system check this box, if the mail must be held.

Exception

Specify the Exception details.

Media

Specify the media details.

Test Word Details**Test-word**

Specify the Test Word details.

Test Amount

Specify the Test Amount

Test Date

Specify the date of testing.

Test Currency

Specify the currency used for testing.

Test Word Narrative

Specify the Test Word details.

Network

Specify the Network.

4.2 Incoming Message Browser

4.2.1 Viewing Incoming Message Browser Summary

Payments incoming messages can be viewed from the Incoming Message Browser screen

SWIFT LAU received from incoming message and the check sum calculated by system (LAU_Validation) are displayed in the incoming browser.

You can invoke “Incoming Message Browser Summary” screen by typing ‘PMSINBRW’ in the field at the top right corner of the Application tool bar and clicking on the adjoining arrow button.

The screenshot displays the 'Inbound Browser Summary' application window. At the top, there is a title bar with window controls and a search icon. Below the title bar, there is a toolbar with buttons for 'Search', 'Advanced Search', 'Reset', and 'Clear All'. A 'Records per page' dropdown is set to 15. The main search area is titled 'Search (Case Sensitive)' and contains a grid of search filters. The filters are arranged in three columns: Branch, DCN, Reference Number, Business Message Identifier, Sender, Message Status, Process Status, Network Code, UETR, Network Type Code, Transaction Type, Message Format, Queue, Authorization Status, File Name, Source Type, and Message Type. Each filter has a search icon or a dropdown arrow. Below the search filters is a 'Search Results' section with a 'Lock Columns' dropdown set to 0. The results table has columns for Branch, DCN, Reference Number, Business Message Identifier, Sender, Receiver, Message Status, Process Status, Network Code, and Network Type Code. The table currently shows 'No data to display.' At the bottom of the window, there is a toolbar with buttons for 'View Message', 'View Transaction', 'View Queue(STP Layer)', 'Edit', 'Force', 'Move To Queue', 'Authorize', 'Suppress', 'Retry', and 'Exit'.

You can search using one or more of the following parameters:

- Branch
- DCN
- Reference Number

- Business Message Identifier
- Sender
- Message Type
- Message Status (Suppressed/ Pending Cover Match / Repair / Pending Network Resolution / Moved to Unmatched Queue / Move to Non STP Queue/Move to Process Exception Queue/Move to Business Override Queue/STP Cancelled/Move to Sanctions Check Queue)
- Process Status (Unprocessed / Processed / Repair / Exception)
- Queue
- Network Code
- Network Type Code
- Transaction Type (Incoming / Outgoing)
- UETR
- Authorization Status (Authorized / Unauthorized)
- Message Format
- Source Type

Note

- Queue Access rights is applicable for Incoming Browser Summary(PMSINBRW). Refer to Exception Queues user guide, for details on Queue Access Rights.
- If the Payments incoming messages has UETR then system populates UETR value in the search result section.
- Incoming MT210 message received via SWIFT is logged in Inbound Browser Summary (PMSINBRW) screen with process status “Unprocessed”.
- Incoming MT210 message would be matched to another Inbound SWIFT payment message (MT202, MT205) that is expected to be received later.

Once you have specified the search parameters, click ‘Search’ button. The system displays the records that match the search criteria.

The following operations are available in the Summary screen:

View Message

You can view the message received from SWIFT/RTGS network for the selected record" - Description for View Message button.

The screenshot shows the 'View Message' interface. At the top, there is a search bar with the placeholder text 'Enter Query'. Below the search bar is a large text area with labels 'DCN', 'Branch', and 'Message'. A 'Details' section contains a 'Remarks' field. At the bottom, there are several input fields for 'Maker Id', 'Release Time', 'Latest Version No.', 'Checker ID', 'Checker Date Stamp', and 'Authorized'. A 'View History' button is on the bottom left and an 'Exit' button is on the bottom right.

View Transaction

You can view the Inbound/Outbound transaction view screen based on the Process Status, Message Status, Network Type Code, and Transaction Type (Incoming / Outgoing) of the selected payment message:

- For MT 103/202/205/202COV/205COV messages, on clicking the View Transaction tab, the system launches Inbound / Outbound Cross Border / RTGS Transaction View screens when the incoming MT messages are fully processed (Process Status as 'Processed' and Message Status as Blank). If the Incoming MT messages are in any STP Layer exception queue (or) the Message Status is 'STP Cancelled', then the system displays Inbound SWIFT View (PSDIVIEW) screen.
- For SWIFT CBPRPlus messages, on clicking the View Transaction tab, the system launches Inbound / Outbound SWIFT CBPRPlus Transaction View screens when the incoming SWIFT CBPRPlus messages are fully processed (Process Status as 'Processed' and Message Status as Blank). If the Incoming SWIFT CBPRPlus messages are in any STP Layer exception queue (or) the Message Status is 'STP Cancelled', then the system displays STP Layer Inbound Transaction View screens.
- For TARGET2 messages, on clicking the View Transaction tab, the system launches Inbound / Outbound TARGET2 ISO Transaction View screens when the incoming TARGET2 messages are fully processed (Process Status as 'Processed' and Message Status as Blank). If the Incoming TARGET2 messages are in any STP Layer exception queue (or) the Message Status is 'STP Cancelled', then the system displays STP Layer Inbound Transaction View screens.

This user action is not applicable when the Message Status is 'Move to Sanctions Check Queue'.

View Queue (STP Layer)

- For MT / MX messages, on clicking the View Queue (STP Layer) tab, the system launches the STP Layer exception queue when the Incoming messages are moved to any STP Layer exception queue.

When the Message Status is 'Move to Sanctions Check Queue', Sanctions Check Queue (PQSSNCKQ) screen is invoked with the message reference filtered.

4.2.2 Invoking Incoming Message Browser Screen

This screen is modified to view the incoming message details like source type and SWIFTNet connector name.

You can Double click a record or click the 'Details' button after selecting a record in "Incoming Message Browser Summary" screen PMSINBRW screen to view the details in Incoming Message Browser screen by PMDINBRW screen.

The screenshot displays the 'Incoming Message Browser' interface. At the top, there is a search bar labeled 'Enter Query'. Below this, the screen is divided into several sections for data entry and viewing:

- Search Fields:** A grid of input fields for filtering messages, including DCN, Reference Number, Sender, Media, Swift MX Type, Queue, Required Execution Date, Business Message Identifier, Network Type Code, Message Status, Currency, Amount, Value Date, External Reference, Multi Credit Reference, UETR, Branch, Media Control System, Node, Testword, Repair Reason, Repair Description, gpi Service Type, and Message Type. Many of these fields have search icons.
- Operation:** A dropdown menu for selecting an operation.
- Name and Address:** Fields for Name, Address 1, Address 2, Address 3, Address 4, and Location.
- Process Status:** Fields for Process Status and PDE Flag.
- Suppress Details:** A section for 'Remarks' with a text input field and a speech bubble icon.
- Status Fields:** Fields for Cover Match Status, Suppress Status, Funding Exception Status, and Authorization Status (with a toggle switch).

At the bottom right corner, there are 'Exit' and 'Save' buttons.

You can specify the following fields:

Document Number

Specify the Document Number.

Reference No

Specify the Reference Number of the document.

Sender

Specify the reference number.

Media

Specify the required media.

SWIFT Message Type

Specify the required SWIFT Message Type.

Queue

Specify the queue name.

Required Execution Date

Specify the required execution date.

Operation

Select the required operation.

Name

Specify the name.

Address 1

Specify the address.

Address 2

Specify the address.

Address 3

Specify the address.

Address 4

Specify the address.

Location

Specify the required location.

Status

Specify the required status.

Currency

Specify the required currency.

Amount

Specify the amount.

Value Date

Specify the value date.

External Reference

Specify the external reference number.

Multi Credit Reference

Specify the multi credit reference details.

Branch

Specify the required branch.

Media Control System

Specify the Media Control System.

Node

Specify the required node.

Testword

Specify the testword.

Repair Reason

Specify the Repair Reason.

Reason Description

Specify the description of the reason.

Suppress Details**Process Status**

Specify the status of the process.

PDE Flag

Check the PDE flag if required.

Remarks

Specify the any remarks of the Suppress details.

Suppress Message

Specify the suppress message details.

Cover Match Status

Specify the status of the cover match.

Suppress Status

Specify the status of the suppress.

Funding Exception Status

Specify the status of the Funding Exception.

Authorization Status

Check the Authorization Status box, if required.

4.3 **Bulking and De-bulking**

The following are the list of functionalities that are part of Bulker Framework:

- Ability to bulk the outgoing SWIFT MT messages with a configurable delimiter based on parameters like Message Type, Value Date, Currency, Receiver BIC and Sender BIC.
- Option to schedule automatic bulking with a start and end time with time frequency so that the bulking process runs between start and end time for configured frequency.
- Ability to configure size or volume based bulking.
- File name prefix should be configurable in the system.
- The system supports option to compress the bulk file before sending it to the SWIFTNet network.

Below listed key maintenances are referred for Bulking and De-bulking of SWIFT MT Messages processing:

- Bulk Preference Definition (MSDBLKRL)
 - Bulk Preference Definition screen is used to configure the preferences to be used during the bulking process.
 - It also defines the scheduling parameters to automate the bulking process, like start time, end time and frequency.
 - Compression required and compression type is applicable only for SWIFTNet connectivity not for other destination types.

- Bulker Monitor (MSDBLKMN)
 - This is the screen to monitor the bulk scheduler execution.
 - You can view the bulk preference name and the execution start time, end time, execution status and no of files generated.
 - You can initiate the ad-hoc bulking for the selected bulk preference.
 - To initiate the adhoc manual bulking the detail screen has to be invoked and click on the adhoc bulking button to trigger the adhoc bulking for the chosen bulk preference.
 - To Reprocess the messages which are got failed in the previous bulking process user has to invoke bulk monitor details screen. Then click on the user regenerate button to reprocess the failed message to reprocess.

For more details about fields of above mentioned maintenance screens, refers to Common Core - Electronic Messaging Service User Guide.

4.4 Local Authentication

SWIFT Alliance LAU is enabled in order to secure messaging between Oracle Banking Payments and SWIFT.

If there is any interference with the message as it is transmitted between source and destination, the checksum fails, indicating the message integrity has been breached.

Below listed key maintenances are referred for File exchange processing:

- SWIFT LAU Key Maintenance (MSDLAUMN)
 - This screen can be accessed for maintenance from Head Office only.
 - Specific users with necessary roles can access the maintenance screen. Switching LAU 'ON' or 'OFF' affects all the outgoing SWIFT messages in FCUBS. SWIFT LAU maintenance data is referred by EMS for calculation of checksum for outbound or inbound messages.
 - Message direction must be chosen based on the key is maintained for Outgoing or Incoming SWIFT message.

For more details about fields of above mentioned maintenance screens, refers to Common Core - Electronic Messaging Service User Guide.

4.4.1 Viewing SWIFT LAU Key Summary

You can invoke “SWIFT LAU Key Summary” screen by typing ‘MSSLAUMN’ in the field at the top right corner of the Application tool bar and clicking on the adjoining arrow button.

SWIFT LAU Key Summary

Search Advanced Search Reset Clear All Records per page 15

Search (Case Sensitive)

Authorization Status Message Direction Record Status Host Code

Search Results Lock Columns 0

Authorization Status	Record Status	Host Code	Message Direction	SWIFT LAU Required	Key First Part	Key Second Part
No data to display.						

Page 1 Of 1

Exit

You can search using one or more of the following parameters:

- Authorization Status
- Record Status
- Host Code
- Message Direction

Once you have specified the search parameters, click ‘Search’ button. The system displays the records that match the search criteria for the following:

- Authorization Status
- Record Status
- Host Code
- Message Direction
- SWIFT LAU Required
- Key First Part
- Key Second Part
- Detailed Processing Logic for Outgoing SWIFT LAU
- The messaging module is enhanced to incorporate the new S-block in the SWIFT message. And the same is generated for all outbound messages from FCUBS with message status ‘G’.
- The messaging module fetches the records in outgoing browser with MSG_STATUS = ‘G’ and generates S-Block data.
- For all outbound messages, the generated checksum is appended in S-Block and can be viewed from Outgoing Message Browser front end screen.
- Successful generation of S-Block data and message hand-off to out folder updates the message status to ‘H’
- EMS does not update message status to ‘H’ in Outgoing message browser if, there is failure to append the S block data in the message and the status of message remains ‘G’.

EMS next hand-off job picks the messages with status ‘G’ and regenerates S Block data and appends same in the message which also updates message status to ‘H’.

Refer the Process Flow diagram below:

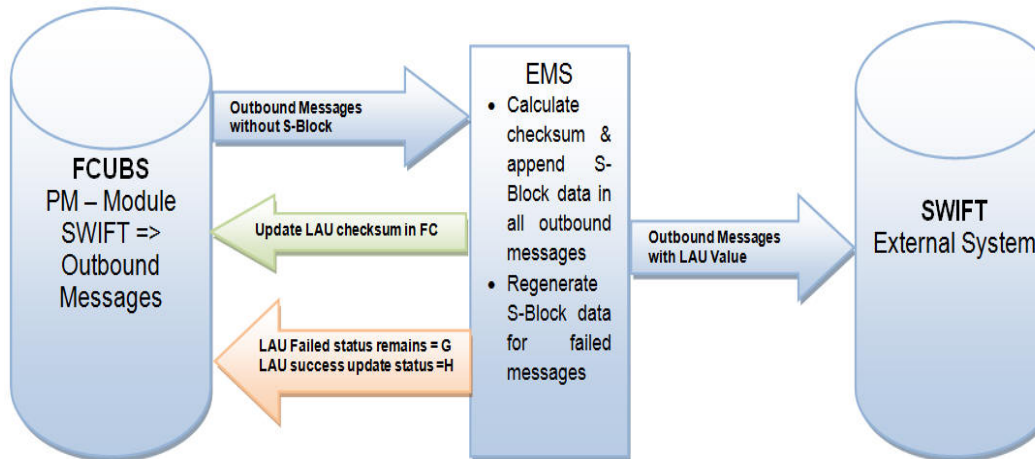

4.4.2 Detailed Processing Logic for Incoming SWIFT LAU

- The messaging module is enhanced to validate inbound messages with S block data.
- Received encrypted S-Block checksum values are validated.
- You can view both, check sum received & generated in SWIFT_LAU & LAU_VALIDATION fields respectively. Messages with status 'R' in Incoming message browser hold differences in check sum data between SWIFT_LAU and LAU_VALIDATION data.
- Incoming message without any data in S Block is uploaded in incoming browser with status 'R' and there is no data updated in SWIFT_LAU field where as EMS generated checksum gets updated in LAU_VALIDATION field.

Refer the Process Flow diagram below:

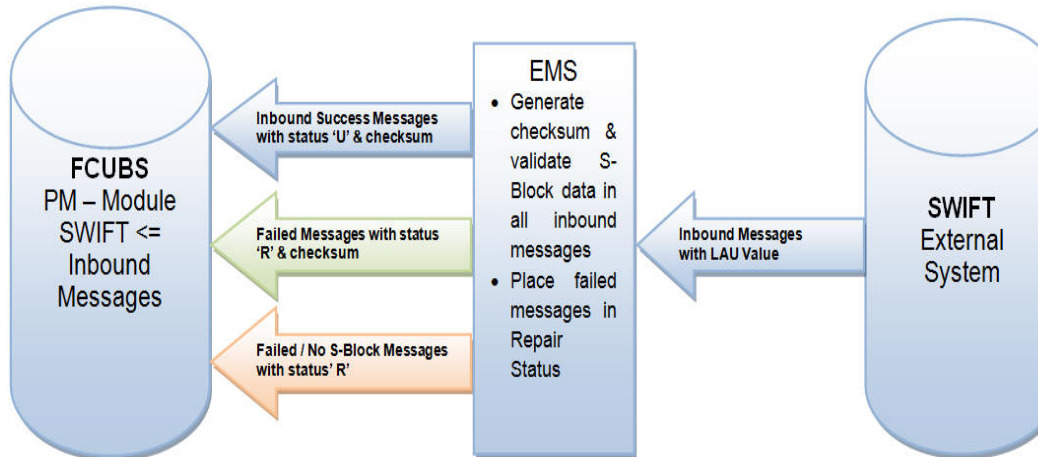

4.5 SWIFT FIN Header Configuration

Provision is given in an application to configure delivery monitoring flag in the FIN message application header. Based on the configuration provided the customer can do the maintenance to receive/not receive MT011 delivery notifications.

4.5.1 SWIFT FIN Header Preference

This screen supports processing of delivery notification messages.

You can invoke 'SWIFT FIN Header Preference screen' by typing 'PXDFNHDR' in the field at the top right corner of the Application tool bar and clicking on the adjoining arrow button.

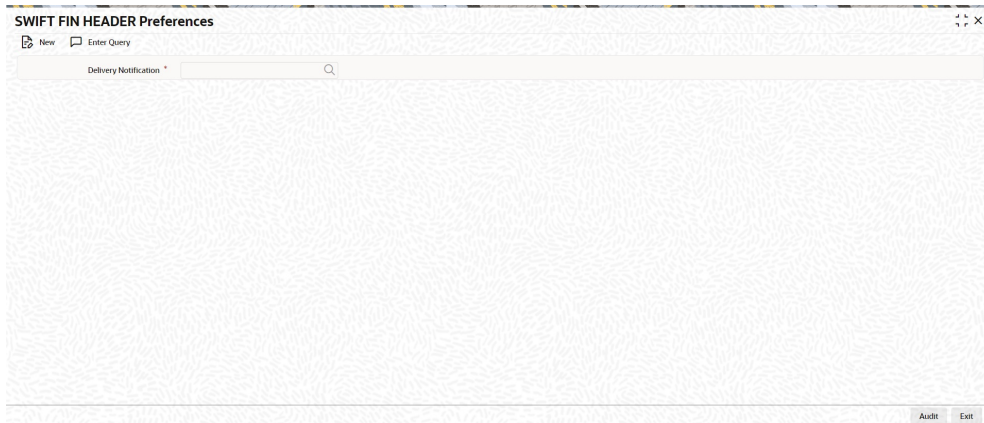

You can specify the following details by clicking on 'New' button to create a new record or verify the existing records by clicking on Enter Query button.

Delivery Notification

Specify the Delivery Notification from the following list of values:

- Required
- Not Required

4.5.1.1 SWIFT FIN HEADER Preferences Summary

You can invoke 'SWIFT FIN HEADER Preferences Summary' screen by typing 'PXSFNHDR' in the field at the top right corner of the Application tool bar and clicking on the adjoining arrow button.

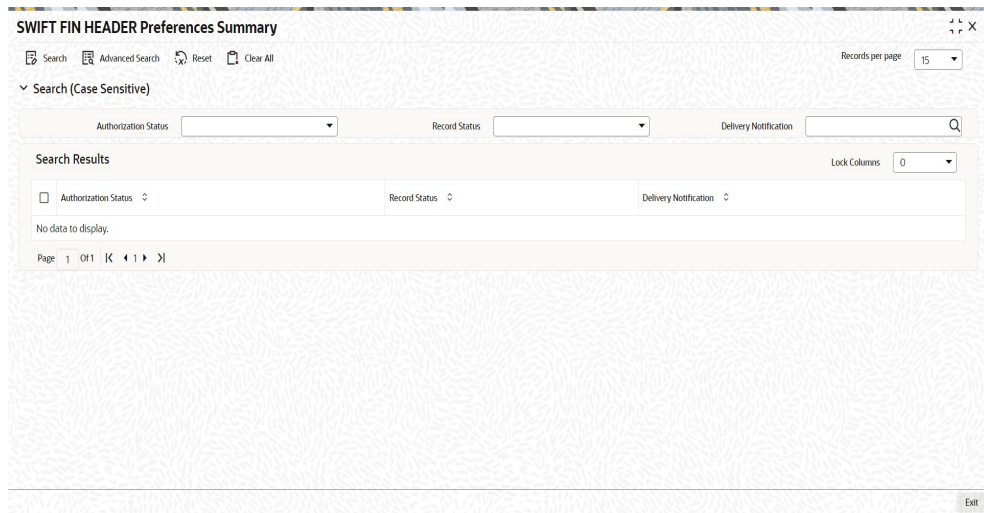

You can search using one or more of the following parameters:

- Authorization Status (Authorized / Unauthorized / Rejected)
- Record Status (Open / Closed)
- Delivery Notification

Once you have specified the search parameters, click 'Search' button. The system displays the records that match the search criteria.

Double click a record after selecting a record to view the detailed screen.

4.5.2 **SWIFT FIN Header Host Preference**

This screen supports processing of delivery notification messages.

You can invoke 'SWIFT FIN Header Host Preference screen' by typing 'PXDFNHST' in the field at the top right corner of the Application tool bar and clicking on the adjoining arrow button.

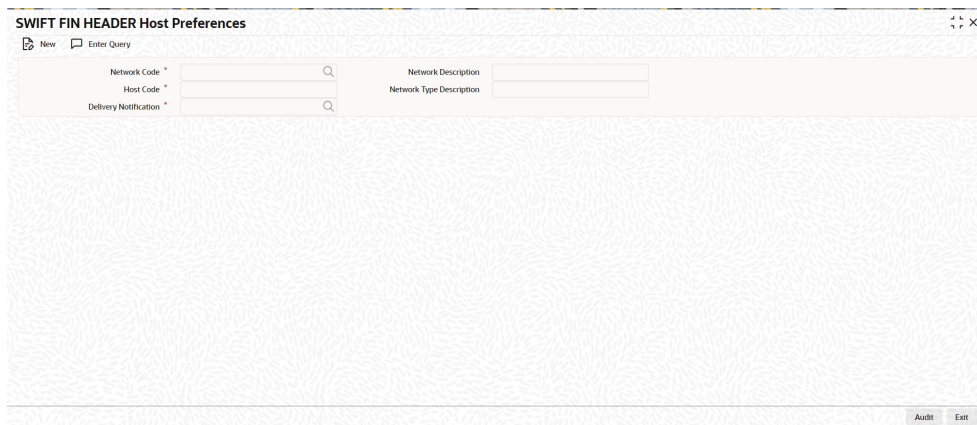

You can specify the following details by clicking on 'New' button to create a new record or verify the existing records by clicking on Enter Query button.

Host Code

System defaults the Host code of the logged in user.

Network Code

This field list all the Network codes maintained for payment types 'Cross Border' and 'RTGS' in the host.

Delivery Notification

Specify the Delivery Notification from the following list of values:

- Required
- Not Required

Network Description

The system defaults the Network Description based on the Network Code selected.

Network Type Description

The system defaults the Network Type Description based on the Network Code selected.

4.5.2.1 **SWIFT FIN HEADER Host Preferences Summary**

You can invoke 'SWIFT FIN HEADER Host Preferences Summary' screen by typing 'PXSFNHDR' in the field at the top right corner of the Application tool bar and clicking on the adjoining arrow button.

SWIFT FIN HEADER Host Preferences Summary

Search Advanced Search Reset Clear All Records per page: 15

Search (Case Sensitive)

Authorization Status: [Dropdown] Record Status: [Dropdown] Host Code: [Text Box]

Network Code: [Text Box] Delivery Notification: [Text Box]

Search Results Lock Columns: 0

Authorization Status	Record Status	Host Code	Network Code	Delivery Notification
No data to display.				

Page: 1 Of 1 [Navigation Icons]

Exit

You can search using one or more of the following parameters:

- Authorization Status (Authorized / Unauthorized / Rejected)
- Record Status (Open / Closed)
- Host Code
- Network Code
- Delivery Notification

Once you have specified the search parameters, click 'Search' button. The system displays the records that match the search criteria.

Double click a record after selecting a record to view the detailed screen.

4.5.3 **SWIFT FIN Header Processing**

Below is the list of messages applicable on Swift Fin Header preferences and Host preferences:

Message Type	Message Description
MT103/103 REMIT/103 STP	Single Customer Credit Transfer
MT202	General Financial Institution Transfer
MT205	Financial Institution Transfer Execution
MT202COV	General Financial Institution Transfer
MT205COV	Financial Institution Transfer Execution
MT200	Financial Institution Transfer for its Own Account
MT210	Notice to Receive

While generating the outgoing MT message, system checks for Delivery Notification maintenance done in the FIN Header Host Preference (PXDFNHST) screen.

If there is no host level message preference maintained, then system checks the FIN Header Preference (PXDFNHDR) screen.

Level 1	SWIFT FIN Header Host Preference
Level 2	SWIFT FIN Header Preference

Based on the Message Priority (i.e. Value provided in Bank priority field) of outgoing transaction input screen and Delivery Notification field value, the Delivery Monitoring field of FIN message application header gets populated

- When Message Priority value is U
 - If Delivery Notification value is 'Required, Field value gets populated with 3.
 - If Delivery Notification value is Not Required, Field value gets populated as 1.
- When Message Priority value is N
 - If Delivery Notification value is 'Required, Field value gets populated with 2.
 - If Delivery Notification value is Not Required, Field value gets blank.

Note

When value of the delivery notification is sent as blank then system do not receive MT011 (i.e. Delivery Notification) from SWIFT.

5. SWIFT Messages Via Blockchain

Cross border Outbound transactions initiated from a particular Branch, with as specific Receiver BIC, Message Type, Transfer Currency and Source Code are processed using block chain network and not via SWIFT network. User can verify the details of transaction initiated in source environment are received in destination environment for the combination maintained.

5.1 SWIFT Message Routing Parameter Detailed

You can invoke 'SWIFT Message Routing Parameter Detailed' screen by typing 'PMDMSGRT' in the field at the top right corner of the Application tool bar and clicking on the adjoining arrow button.



You can specify the following details by clicking on 'New' button to create a new record or verify the existing records by clicking on Enter Query button

Transaction Branch

Specify the Transaction branch in which the transaction is to be booked. Alternatively you can select a valid Transaction Branch from the list of values displayed.

Receiver BIC

Specify a valid Receiver BIC, which is the internal SWIFT routing receiver BIC. Alternatively you can select a valid Receiver BIC from the list of values displayed.

SWIFT Message Type

Specify the SWIFT message Type, for which the SWIFT Routing parameter is to be maintained. Alternatively you can select a valid Receiver BIC from the list of values displayed.

Transfer Currency

Specify the Transfer Currency. Alternatively, you can select a currency code from the list of values displayed.

Source Code

Specify the Source Code. Alternatively, you can select the Source Code from the list of values displayed

5.1.1 SWIFT Message Routing Parameter Summary

You can invoke 'SWIFT Message Routing Parameter Summary' screen by typing 'PMSMSGRT' in the field at the top right corner of the Application tool bar and clicking on the adjoining arrow button.

The screenshot shows the 'SWIFT Message Routing Parameter Summary' application window. At the top, there is a search bar with buttons for 'Search', 'Advanced Search', 'Reset', and 'Clear All'. To the right of the search bar, there is a 'Records per page' dropdown menu set to '15'. Below the search bar, there is a section for search filters with the following fields: 'Authorization Status' (dropdown), 'Receiver BIC' (text input with search icon), 'Record Status' (dropdown), 'SWIFT Message Type' (text input with search icon), 'Processing Branch' (text input with search icon), and 'Source Code' (text input with search icon). Below the filters, there is a 'Search Results' section with a 'Lock Columns' dropdown set to '0'. The results table has the following columns: 'Authorization Status', 'Record Status', 'Processing Branch', 'Receiver BIC', 'SWIFT Message Type', 'Source Code', and 'Transfer Currency'. The table is currently empty, displaying 'No data to display.' and 'Page 1 of 1'. An 'Exit' button is located at the bottom right of the window.

You can search using one or more of the following parameters:

- Authorization Status
- Record Status
- Transaction Branch
- Receiver BIC
- SWIFT Message Type

Once you have specified the search parameters, click 'Search' button. The system displays the records that match the search criteria.

Double click a record or click the 'Details' button after selecting a record to view the detailed screen. You can also export the details of selected records to a file using 'Export' button.

5.2 DLT Message Browser Summary

You can invoke 'DLT Message Browser Summary' screen by typing 'PMSHYLTR' in the field at the top right corner of the Application tool bar and clicking on the adjoining arrow button.

The screenshot shows the 'DLT Message Browser Summary' application window. At the top, there is a search bar with a magnifying glass icon, a 'Search' button, an 'Advanced Search' button, a 'Reset' button, and a 'Clear All' button. To the right of the search bar, there is a 'Records per page' dropdown menu set to '15'. Below the search bar, there is a section titled 'Search (Case Sensitive)' with a dropdown arrow. This section contains several search criteria: 'Sender Branch', 'Receiver Branch', 'Reference Number', 'Sender', 'Receiver', 'Status', 'Generated Reference', 'Source Type', and 'SWIFT Message Type'. Each criterion has a corresponding input field with a magnifying glass icon. Below the search criteria, there is a 'Search Results' section with a 'Lock Columns' dropdown menu set to '0'. The search results section contains a table with columns: 'Sender Branch', 'Receiver Branch', 'Reference Number', 'Sender', 'Receiver', and 'Status'. The table is currently empty, displaying 'No data to display.' Below the table, there is a pagination bar showing 'Page 1 of 1' and navigation icons. At the bottom of the application window, there are 'Retry' and 'Exit' buttons.

You can search using one or more of the following parameters:

- Sender Branch
- Receiver Branch
- Reference Number
- Sender
- Receiver
- Status
- Generated Reference
- Source Type
- SWIFT Message Type

Once you have specified the search parameters, click 'Search' button. The system displays the records that match the search criteria.

You can perform below action:

5.2.1 Retry

This action is allowed for all the outbound messages with Rejected/Failed status. You are required to have user/role level queue access rights, to take this action. Source Type needs to 'Out'.

You can use this action to resubmit the payment message for OFBA to pick up and process the message. This action is allowed for a configured number of times.

This sub screen have following fields as display fields

- DCN
- Generated Reference
- Receiver Branch
- Sender Branch
- Smart Contract ID
- Message Status
- Error Code
- Error Description

Status field is shown as the current status. Please select the option to 'Ready'.

On clicking of OK, the message is populated in the OFBA polling table for pick up by OFBA. The message status is then updated as 'Ready'.

On receiving the response from OFBA table, the ACK/NACK status is updated in the SWIFT Message Notification Browser (MSSNOTIB).

Retry of failed/rejected messages are allowed for the maximum number of retry count value maintained against the parameter 'MAX_OFBA_RETRY_COUNT' [PMDSPM]. The factory shipped value for maximum retry value is 10.

5.3 SWIFT Message Processing

The system refers to the SWIFT Message Routing maintenance (PMDMSGRT) to decide whether to generate SWIFT CBPRplus outbound message and send via OFBA or not.

The system checks transaction Source Code, Booking Branch, Instructed Agent BICFI as Receiver BIC, Transfer Currency, and MX Message Type as the SWIFT Message Type against the routing maintenance.

If the maintenance is satisfied, then the message is handed off via OFBA. The 'Connectivity Option' value is updated as 'DLT'. The message is not handed off via the EMS OUT scheduler.

6. Fedwire Messages

6.1 Fedwire Message Mapping

You can invoke 'Fedwire Message Mapping' screen by typing 'MSDFQMAP' in the field at the top right corner of the Application tool bar and clicking on the adjoining arrow button.

The screenshot shows the 'Fedwire Message Mapping' application window. At the top, there is a title bar with 'Fedwire Message Mapping' and window control icons. Below the title bar, there is a toolbar with 'New' and 'Enter Query' buttons. The main area contains several input fields: 'Media *' with a dropdown menu showing 'American Banker Associations *' and 'Number'; 'Message Type *' with a dropdown menu showing 'FWR'; 'Branch *' with a dropdown menu; and 'Branch Name' with a text input field. Search icons are present next to the dropdown menus. At the bottom right, there are 'Audit' and 'Exit' buttons.

You can specify the following fields:

Media

Specify the required Media from the list of values.

ABA Number

Specify the required ABA Number from the list of values.

Message Type

The system displays the message type by default.

Branch

Select the required branch from the list of values.

Branch Name

This is displayed when you select the branch.

6.1.1 Fedwire Message Mapping Summary

You can invoke “Fedwire Message Mapping Summary” screen by typing ‘MSSFQMAP’ in the field at the top right corner of the Application tool bar and clicking on the adjoining arrow button.

The screenshot shows the 'Fedwire Message Mapping Summary' application window. At the top, there is a search bar with 'MSSFQMAP' entered and a search icon. Below the search bar are buttons for 'Search', 'Advanced Search', 'Reset', and 'Clear All'. The 'Records per page' is set to 15. The search criteria section is titled 'Search (Case Sensitive)' and includes several input fields: 'Authorization Status', 'Record Status', 'Message Type', 'American Banker Associations Number', 'Media', and 'Branch'. Below the search criteria is a 'Search Results' section with a table header and a 'Lock Columns' dropdown set to 0. The table currently displays 'No data to display.' and a pagination bar showing 'Page 1 Of 1'.

You can search using one or more of the following parameters:

- Authorization Status
- Record Status
- Message Type
- ABA Number
- Media
- Branch

Once you have specified the search parameters, click ‘Search’ button. The system displays the records that match the search criteria for the following:

- Authorization Status
- Record Status
- Message Type
- ABA Number
- Media
- Branch

6.1.2 SWIFT Message Notifications

You can invoke 'SWIFT Message Notifications' screen by typing 'MSDNOTIB' in the field at the top right corner of the Application tool bar and clicking on the adjoining arrow button.

SWIFT Message Notifications	
Enter Query	
Document Number *	1724817428990000
Sender	ALL
SWIFT Message Type	NAK
Branch Date	
Reference Number	1724815428960000
Branch	HEL
Running Number	1
Process Status	
Authorization Status	Authorized
Message Reference	
Receiver	
User Reference	1724817428990000
Mod Number	1
Acknowledgement Status	
Delivery Notification	
Non-Delivery Warning	
Failed Delivery Warning	
Maker Id	SYSTEM
Release Time	
Checker ID	SYSTEM
Checker Date Stamp	
Acknowledgement Time	
Delivery Notification Time	
Non-Delivery Warning Time	
Failed Delivery Notification Time	

You can specify the following fields:

Document Number

Specify the Document Number and click on Execute Query button to view the details pertaining to it.

Following details are displayed on clicking Execute Query button:

- Branch
- Sender
- Running Number
- SWIFT Message Type
- Process Status
- Branch Date
- Authorization Status
- Reference No
- Message Reference
- Maker ID
- Receiver
- Release Time
- User Reference
- Checker ID
- Mod Number
- Checker Date Stamp

7. Function ID Glossary

M

MSDFQMAP6-1
MSDNOTIB6-3
MSSFQMAP6-2
MSSLAUMN4-12

P

PMDCONFL3-4
PMDCONNW3-3
PMDINBRW4-8
PMDMSGRT5-1

PMDOUTBR 4-3
PMSCONFL 3-5
PMSCONNW 3-4
PMSHYLTR 5-3
PMSINBRW 4-5
PMSMSGRT 5-2
PMSOUTBR 4-1
PXDFNHDR 4-14
PXDFNHST 4-15
PXSFNHDR 4-14, 4-15