

Oracle Fusion Cloud SCM



Using Manufacturing

24B

Oracle Fusion Cloud SCM
Using Manufacturing

24B

F92853-01

Copyright © 2011, 2023, Oracle and/or its affiliates.

Author: Gayathri Pyapili

Contents

Get Help	i
<hr/>	
1 Overview	1
Overview of Oracle Manufacturing	1
Overview of Manufacturing Job Roles and Work Areas	6
Overview of Manufacturing in Supply Chain Management Business Processes	7
Overview of Dependencies and Interactions With Other Cloud Applications	10
2 Manage Manufacturing Plant	15
Overview of Manufacturing Plants	15
Work Areas	17
Resources	20
Work Centers	27
Standard Operations	33
3 Production Process Design	43
Overview of Production Process Design	43
Overview of the Work Definition Work Area	44
Work Definition Names	44
Overview of Work Definitions	46
How You Manage Work Definitions in the User Interface	48
How You Create Work Definitions	50
Create a Work Definition for Discrete Manufacturing that Includes a Supplier Operation	60
How You Edit Work Definitions	61
How You Create an Assemble to Order (ATO) Model Work Definition	70
How You Create a Configured Item Work Definition	75
Work Definitions for Contract Manufacturing	77
How You Process Item Structure Changes to Work Definitions	81
Synchronize Item Structure Changes to Work Definitions	83
How You Manage Work Definition Versions	86
Automatic Work Definitions	88
How You Manage Work Definitions in a Spreadsheet	91

How You Import Discrete Work Definitions	93
How You Import Process Work Definitions	94
How You Purge Work Definition Records from Interface	95
Calculation of Lead Times	95
Overview of Electronic Signatures and Electronic Records for Work Definition Management	106
How You Capture E-Signatures and Generate E-Records for Work Definition Management	107
Audit Trail for Work Definitions	108
Data Security for Work Definitions	110

4 Manage Production 113

Overview of Production Management	113
Infolet-Based Work Execution Work Area	113
How You Manage Production Calendars	121
Create a Shift Exception	122
How You Manage Work Center Resource Calendars	124
Create a Resource Exception	125
Work Orders	126
How You Manage Work Order Operations	159
How You Manage Work Order Operation Items	163
How You Manage Work Order Operations Resources	166
Work Order Operation Outputs	169
How You Scale Process Work Orders	170
How You Manage Work Order Serials	171
How You Manage Work Order Reservations	172
How You Manage Work Order History	174
How You Manage Work Order Mass Actions	175
Work Order Material Availability	176
Direct Procurement of Materials for Work Orders	189
How You Manage Work Orders for Contract Manufacturing	194
How You Import Discrete Work Orders	195
How You Import Process Work Orders	197
How You Close Work Orders	198
How You Create Configured Item Work Orders	198
How You Create Work Orders from Automatic Work Definitions	199
Considerations for Creating Work Orders from Planning With Alternate Resources and Substitute Components	199
How You Manage Supplier Operations	200
How You Review Supplier Operation Details	204

How You Manage Demand and Supply Side Changes in Outside Processing	205
How You Enable Audit Trail for Manufacturing Work Orders	209
Overview of Electronic Signatures and Electronic Records for Work Order Approval	210
How You Capture E-Records and E-Signatures for Manufacturing Work Order Approval in Deferred Mode	211
How You Purge Work Order Records from Interface	213
Synchronization to IoT Production Monitoring	216
5 Execute Production	219
Overview of Production Execution Tasks	219
How You Review a Dispatch List	220
How You Resequence Work Order Operations	226
Use the Quick Complete Action to Execute a Standard Discrete Manufacturing Work Order	227
How You Initiate Operation Execution at Automation Equipment	228
Production Exceptions	229
Operation Transactions	235
Inspections	268
Production Transactions	277
How You Pick Materials for Work Orders	281
Considerations for Picking Materials	287
FAQs for Picking Materials	289
How You Pick Reserved Assemblies for Rework Work Orders	290
Reservation of Materials	291
Overview of Reservation of Materials for Work Orders	291
How You Reserve Materials for Work Orders in Manufacturing	293
How You Manage Reservations for Work Order Materials in Manufacturing	294
Transfer Transactions from Production to Costing	296
How You Import Production Transactions	297
6 Product Genealogy	301
Overview of Tracing Product Genealogy	301
How You Review Product Genealogy	301
How You View Lot and Serial Number Information	302
How You View Product Genealogy Details	302
How You View Product Genealogy Transaction History	303
7 Reports and Analytics	305
How You Manage Work Definition Reports	305

Work Order Reports	305
How You Print Components List	306
Assess Reports to Pick Materials for Work Orders	307
How You Print Work Order Traveler	309
How You Print Extensible Work Order Traveler	311
How You Modify Copies of Predefined Reports in Manufacturing	311
How You Print Labels	312
How You Print Electronic Production Records	313
OTBI for Oracle Fusion Manufacturing	313
BICC for Oracle Manufacturing	326
Deep Links for Oracle Manufacturing	326

Get Help

There are a number of ways to learn more about your product and interact with Oracle and other users.

Get Help in the Applications

Use help icons  to access help in the application. If you don't see any help icons on your page, click your user image or name in the global header and select Show Help Icons.

Get Support

You can get support at [My Oracle Support](#). For accessible support, visit [Oracle Accessibility Learning and Support](#).

Get Training

Increase your knowledge of Oracle Cloud by taking courses at [Oracle University](#).

Join Our Community

Use [Cloud Customer Connect](#) to get information from industry experts at Oracle and in the partner community. You can join forums to connect with other customers, post questions, suggest *ideas* for product enhancements, and watch events.

Learn About Accessibility

For information about Oracle's commitment to accessibility, visit the [Oracle Accessibility Program](#). Videos included in this guide are provided as a media alternative for text-based topics also available in this guide.

Share Your Feedback

We welcome your feedback about Oracle Applications user assistance. If you need clarification, find an error, or just want to tell us what you found helpful, we'd like to hear from you.

You can email your feedback to oracle_fusion_applications_help_ww_grp@oracle.com.

Thanks for helping us improve our user assistance!

1 Overview

Overview of Oracle Manufacturing

Introduction

Manufacturing delivers core discrete and process manufacturing capabilities in the cloud that allow you to efficiently set up, manage, execute, and cost your production operations. It supports in-house manufacturing activities of standard products for both discrete and process manufacturing. In addition, for discrete manufacturing, it allows configured products to be executed to plan or to order, and supports contract manufacturing of standard products executed to plan or to order. It supports discrete and process manufacturing scenarios where one or more operations of a work order are outsourced to a supplier who provides specialized manufacturing services. You can run both process manufacturing and discrete manufacturing in the same plant. The enhanced capabilities to support batch production of multiple co-products and by-products provide the foundation for mixed-mode manufacturing in the same plant. It supports project-specific manufacturing execution. Manufacturing complements other Oracle Cloud applications in providing a comprehensive and complete supply chain solution for discrete and process manufacturing companies.

Key Capabilities to Support Discrete and Process Manufacturing

Oracle Manufacturing and Oracle Cost Management provide a breadth of capabilities that allow you to do the following:

Set Up Manufacturing Plant Data

Oracle Fusion Cloud Manufacturing empowers manufacturing engineers with web-based interface tools to build a foundation of manufacturing plant data and design the discrete and process manufacturing processes for items. Additionally, the application offers intuitive visualization for ease of use.

Manufacturing enables you to quickly define the necessary manufacturing setup data of your plant hierarchy. It helps you establish process standards with a standardized data model for production operations, which can be adapted to changing business processes and market conditions. The manufacturing plant data includes the following:

- **Manufacturing Plant:** Defines an organization where manufacturing setup data is specified, manufacturing processes are run, and materials management is supported.
- **Manufacturing Calendar:** Defines a production calendar to represent plant working times that includes work days, shifts, and exceptions.
- **Plant Parameters and Profile Options:** Associates a manufacturing calendar to the plant, and set up parameters and profile options to determine the behavior of work definition, work order, and work execution in a plant.
- **Work Areas:** Defines work areas to represent locations in a plant. Each work area is comprised of one or more work centers.
- **Production Resources:** Defines equipment or labor resources and resource instances used in production, and the corresponding resource rates. Define resource as automation equipment to represent a robot or an industrial equipment to automatically perform a work order operation.
Note: Resource rates are defined in Oracle Cost Management.
- **Work Centers:** Defines work centers, such as departments or production lines where an operation is performed. Work centers comprise production resources for which the capacity and availability information is maintained.

- **Standard Operations:** Defines a predefined library of standardized in-house or supplier operations and their resources and usages, in order to add to work definitions and work orders.

In addition, Manufacturing enables you to do the following:

- Design the production process on a work definition for discrete manufacturing and process manufacturing work methods using an advanced graphical editing tool.
- Define a work definition for discrete production where the product is a standard item or configured item that's based on an ATO model.
- Define a work definition for a process with co-products and by-products. The process can complete multiple co-products and by-products at any in-house or supplier operation.
- Print a work definition report and share it internally within the organization, or externally with contract manufacturers for discrete manufacturing.
- Calculate manufacturing lead times for a product in discrete manufacturing and for all outputs in process manufacturing.
- Coordinate engineering changes and revisions to item structures to the corresponding work definitions facilitated either by automation or notification.
- Create and update standard operations using Applications Development Framework Desktop Integrator (ADFdi) or using REST services.
- Associate automation equipment resource to a work definition operation and associate a program file name and equipment parameters file to it.
- Create and update work definitions using file-based data import, ADFdi (currently supported for only discrete manufacturing work method), or using REST services.
- Stay connected with key stakeholders in managing work definitions, and collaborate real-time with cross functional teams by leveraging the power of social collaboration in manufacturing operations through embedded Oracle Social Network.
- Automatically create work definitions applicable in kitting and light assembly manufacturing environments that don't require shop floor control, in discrete manufacturing.
- Capture electronic signatures and generate electronic records while managing standard operations and work definitions.
- Obtain a real time view of machine data collected on the shop floor through a drill down from the Resource Instances section of the Edit Resource page.
- Capture audit trail for manufacturing work definitions, work orders, and standard operations created, updated, and deleted through the user interface, ADFdi spreadsheet, file-based data import (FBDI), or REST services.

Monitor and Manage Production

Manufacturing provides several capabilities that enable production supervisors to effectively monitor and manage production activities. All of these are designed and optimized for use on a tablet, enabling users to take action while on the move. The following infolets in the Overview page provide insight into key production related metrics at plant, work area, or work center levels:

- Work Orders
- Rework (for discrete manufacturing work orders)
- Open Exceptions
- Operations Scheduled Versus Actual
- WIP Inspections
- Operations

- IoT Insights: OEE
- IoT Machines In-Use
- IoT Machines Idle
- IoT Machines Down
- IoT Dashboard Metrics

You can view the IoT infolets on the Work Execution work area overview page, only if your manufacturing plant is enabled for synchronization with IoT Production Monitoring.

Manufacturing provides production supervisors and production operators single click access to drill from the metrics into the details, and take action to resolve issues.

Tip: The Open Exceptions, WIP Inspections, and IoT infolets are applicable only at the plant level.

Manufacturing enables production supervisors to manage plant, work center resource working times by defining shift and resource exceptions. Manufacturing helps in managing work order-based production with in-house and supplier operations by allowing you to do the following:

- Create and manage standard work orders using a work definition as a means to initiate regular production.
- Discrete manufacturing enables you to:
 - Create and manage nonstandard work orders with or without a work definition, typically used for nonstandard production activities, such as prototyping.
 - Create and manage work orders to rework or transform products.
 - Create a standard, nonstandard, rework, and transform work order with project details in an organization that's enabled for inventory tracking by project.
 - View and replace substitute items in a work order.
 - Enforce serialization-enabled manufacturing by associating predefined serial numbers to work orders.
 - Manage work order supplies in advanced fulfillment scenarios, such as back-to-back or configure to order, by providing visibility into the corresponding reservation details.
 - Gain insight into real time work order execution through a drill down from the Edit Work Order page.
 - Use shop floor data to automatically report operation transactions.
 - Use the real time metrics from IoT that provides immediate visibility of shop floor operations for you to make better decisions.
 - Focus on key aspects of your shop floor to help maximize capacity, increase throughput, and improve quality.
- Process manufacturing enables you to:
 - Create a batch or work order based on a process name or the primary output.
 - Scale the batch based on input or output items.
 - Create a standard work order with project details in an organization that's enabled for inventory tracking by project.
 - Report completion of co-products and by-products.
 - View and replace substitute items in a work order.
- Generate electronic records and capture electronic signatures while releasing work orders.
- Perform forward, backward, or midpoint scheduling in an unconstrained mode.

- Configure material availability rules and analyze material shortages to effectively manage work orders.
- Calculate material availability for work orders considering available substitutes and replace components with recommended substitutes from material availability work bench.
- Perform mass actions to update status, change work order priorities, and print work order reports for multiple work orders.
- Capture additional information by using descriptive flexfields.
- Review and manage work order attachments, such as standard operation procedures, and quality specifications.
- Print work order traveler, components list, and product labels.
- Collaborate socially to manage work orders and resolve shop floor issues using embedded social.
- Create and update work orders through the file-based data import infrastructure using predefined macro-enabled spreadsheet templates.
- Manage and resolve production exceptions related to in-house and supplier operations. Capture electronic signatures and generate electronic records while closing production exceptions.
- Trigger automatic creation of purchasing documents and shipment lines for supplier operations.
- Review and manage supplier operations and handle demand and supply side changes in outside processing.
- Procure materials directly for works orders.

Oracle Transactional Business Intelligence (OTBI) for Manufacturing offers real-time, self-service reporting, directly off manufacturing transactions. It provides six different manufacturing subject areas used by production supervisors to analyze production performance, and they're as follows:

- Work Order Performance
- Material Usage
- Resource Usage
- Actual Production
- Production Exceptions
- Purchased Item Usage

Execute Production

Manufacturing offers robust capabilities for work order-based execution for discrete and process manufacturing, and orderless execution for discrete manufacturing. With interfaces designed and optimized for use on a tablet, it provides rich user experience for production operators. Additionally, the application facilitates information driven execution by providing insight into production information with several visual cues allowing users to take appropriate actions. It helps improve productivity of shop floor personnel through simplified reporting, and ability to enter data using scanning devices.

Through a simple, intuitive, easy to use dispatch list, it provides a single place for production operators to do the following:

- Review in-house work order operations sequenced to be worked upon for their specific work center and shift
- Review work order details
- Report operation transactions, such as complete, scrap, reject, and material and resource usages
- Print work order traveler and product labels
- Indicate when the production activity for a work order operation has started or stopped, and calculate the runtimes for a work order operation
- Resequence certain operations in work execution that are defined as resequenceable in a work order

- Navigate to the digital twin view of automation equipment to review contextual telemetry data and real-time execution status of a work order operation

Manufacturing also helps you to:

- Minimize user interactions by providing the ability to record material, resource, and operation transactions in just two clicks.
 - Review work order and operation attachments, and enter additional details, such as lot and serial information, if required to complete a transaction. In addition, you can capture additional information required for reporting production transactions by using descriptive flexfields.
 - Execute work order operations using automatic equipment through Oracle Product Monitoring.
 - Pick materials for work orders and create movement requests to move materials to specified supply subinventory, or issue materials directly to work orders. You can integrate Oracle Manufacturing with Warehouse Management System to pick material for work orders and execute movement requests in WMS.
 - Ensure timely availability of materials for production and maintenance. You can reserve materials for manufacturing work orders, optionally move them to your staging area, and continue with the reservation of the work order.
 - Report production transactions by specific product serial numbers that are pre-associated to work orders. This is to comply with serialization-enabled manufacturing. This is currently supported for only discrete manufacturing.
 - Discrete manufacturing enables you to:
 - Report inspection results and automatically decide on disposition based on inspection results while reporting an operation transaction against a work order operation.
 - Initiate manual inspection from the dispatch list. You can inspect the operation or the end item. Inline and manual inspections are available for both discrete and process manufacturing work orders.
 - Automatically or manually report material and resource usages. You can report material and resource usages based on the work order requirements or on a dynamic basis based on actual usage. For serialization-enabled discrete manufacturing, you can report material usages in reference to specific product serial numbers.
 - Automatically complete work order operations upon receiving completion signal from automation equipment through IoT Production Monitoring.
 - Report operation, material and resource transactions for a project-specific work order.
 - Report production activities without the need to create work orders. You can report orderless completion, or scrap of an item with reference to a work definition. This is currently supported for only discrete manufacturing.
 - Report orderless transactions with project details in an organization that's enabled for inventory tracking by project.
 - Review of work order-based or orderless production transaction history. The transaction details are displayed in a reverse chronological order.
 - Report production exceptions and notify key stakeholders for resolution.
- Note:** Production exceptions are also created automatically by IoT Production Monitoring to notify exception conditions related to execution of a work order operation at automation equipment.
- Import material, resource, and operation transactions through the file-based data import infrastructure. This is possible with the provision of predefined macro-enabled spreadsheet templates.
 - Process manufacturing enables you to:
 - Report multiple outputs

- Report output at or against any operation
- Report manual and automatic outputs
- Import work order, material, resource, and operation transactions, and start and stop operation times into manufacturing by using REST services.
- Capture and view the genealogy data for all work order operation transactions and work order material transactions related to lot control and serial control enabled items.
- Report and manage production exceptions.
- Capture electronic signatures and generate electronic records while reporting production transactions.
- Support dual units of measure in operation transactions, material transactions, output transactions, and orderless transactions. Report materials and products in dual units of measure through the discrete and process manufacturing transactions that update on-hand inventory and conditionally genealogy, if items that are enabled with lot control and genealogy tracking.

Analyze and Control Production Costs

Oracle Cost Management provides robust support for planning, cost accounting, and analysis of manufacturing costs for the discrete or process manufacturing work method. It enables users to determine which work definitions to use in costing, efficiently enter material and resource costs with a spreadsheet import, perform cost rollup and gives a flexible means to cost work orders costing by supporting all the costing methods. Costing methods include standard, actual, and FIFO (first-in, first-out).

Cost Management provides a view of costs by work order, or breakdown of the costs by operation and cost element, and work order variances, and helps identify the manufactured items that aren't in compliance with defined plant cost standards.

For more information about manufacturing accounting, refer to the Oracle Supply Chain Management Using Supply Chain Managerial Accounting guide.

Overview of Manufacturing Job Roles and Work Areas

Oracle Manufacturing provides the following three predefined job roles. Oracle recommends that security administrators don't assign these predefined roles directly to users. Instead, make a copy of a predefined role, remove the privileges that your users don't need, and assign users the role that contains only the privileges they need. So, the names of the roles your enterprise uses may be different from the names in this list.

- **Manufacturing Engineer:** A role responsible for developing, maintaining, and improving manufacturing processes needed to achieve production goals according to product specifications.
- **Production Supervisor:** A role responsible for managing shop floor production resources and activities, to ensure on-time production of products at the required quality levels that meet customer expectations.
- **Production Operator:** A role responsible for efficient operation of equipment, or assembly of goods, based on standard operating procedures, and reporting production progress.

For more information about privileges, refer to the Oracle Supply Chain Management Cloud Security Reference for Manufacturing and Supply Chain Materials Management guide.

Based on the roles assigned to the user, manufacturing tasks are accessed and performed through the following two distinctly different work areas:

- **Work Definition:** This work area provides insight into key setup information for a manufacturing plant, and lists all the tasks to define and manage manufacturing setup data.
- **Work Execution:** This work area provides insight into plant, work area, and work center level production information, and lists all the tasks to manage and execute production activities.

Related Topics

- [Overview of the Work Definition Work Area](#)
- [Overview of the Work Execution Work Area](#)

Overview of Manufacturing in Supply Chain Management Business Processes

Being a part of the Oracle Fusion Cloud Supply Chain Management, Oracle Manufacturing plays an important role in supporting the following cross-functional and advanced fulfillment processes:

Plan-to-Produce

Plan-to-produce refers to scenarios where products are manufactured based on a forecast. Sales orders are typically filled from existing stock, and work orders are created to replenish that stock based on planning recommendations.

The plan-to-produce process starts with running the plan in Oracle Supply Chain Planning, and releasing the planned order recommendations for work execution. This leads to the creation of supply orders in Oracle Supply Chain Orchestration, which then initiates the creation of work orders in Manufacturing. Once created, the work orders are released to the shop floor for production.

After reporting product completion at the final operation, the finished goods inventory is updated, and work orders are finally closed.

Note: Plan-to-produce flow is currently supported for both discrete and process manufacturing (constraint-based supply planning).

For more information about plan-to-produce process, refer to the Oracle Supply Chain Management Using Supply Planning guide.

Back-to-Back

Back-to-back order fulfillment flow refers to scenarios where the supply for fulfilling a sales order is created only after the order is booked. And in some cases, the demand is fulfilled by manufacturing the product representing a build to order scenario.

The back-to-back process begins with order capture, and scheduling of the sales order in Oracle Order Management. Once scheduled, Oracle Global Order Promising promises the back-to-back orders, and releases supply recommendations or the supply picture to Supply Chain Orchestration. Once the sales order fulfillment line is scheduled, Order Management releases fulfillment line information or the demand picture to Supply Chain

Orchestration. Supply Chain Orchestration processes the demand picture from Order Management, and the supply picture from Global Order Processing, to create a supply order in Supply Chain Orchestration.

In a scenario where the product must be manufactured to fulfill the order, the supply document is a work order, and Supply Chain Orchestration initiates the creation of the work order in Manufacturing. As soon as the work order is created in Manufacturing, it's tied to the back-to-back sales order in the form of a reservation in Oracle Fusion Inventory Management.

Production activities are reported for the work order and the final operation completion transaction yields finished goods to inventory, which are then shipped to the customer to fulfill the back-to-back sales order.

For more information about back-to-back order fulfillment, refer to the Implementing Back-to-Back Fulfillment chapter in the Oracle Supply Chain Management Implementing Manufacturing and Supply Chain Materials Management Guide.

Note: Back-to-back flow is currently supported for only discrete manufacturing.

Configure to Order

Configure to Order process is essentially a back-to-back fulfillment process with a few key differences in the processing of a configured item in relation to a standard item. This flow assumes that the order is created in Oracle Fusion Order Management, but the source of configured orders could be Oracle Fusion Configure, Price, and Quote, Oracle Order Management, Oracle Configurator, or another source.

- This process starts with a sales order customer being created in Order Management with the Assemble to Order (ATO) model item as the ordered item. When an ATO model is ordered, the customer has the ability to configure the model, and select the options.
- Once the options are selected, the model and selected options are sent to Supply Chain Orchestration to determine if the configuration already exists.
- If a match is found, the existing configured item is passed back to Order Management. If there is no match, the configured item creation process is initiated, and a new configured item is created in Oracle Product Model using attributes values from the base model item. The new item is then passed back to Order Management.
- Next, the sales order is booked in Order Management, and is sent to Global Order Promising so that the order can be scheduled and the source of supply can be determined based upon sourcing rules set up at the model level. The supply and demand information for the configured item is then sent to Supply Chain Orchestration, and a supply order is created.
- If the supply has to be fulfilled by manufacturing the configured item, Supply Chain Orchestration initiates the creation of the work order for the configured item in Manufacturing. The work order for the configured item is created using a dynamically-generated configured item work definition based on the ATO model work definition in Oracle Fusion Manufacturing.
- The work order is then executed and completed. Once the configured product is available, it's shipped to the customer, showing the model and options selected on the bill of lading, and the order is fulfilled.

Sales Order attachments from back-to-back sales orders for standard items and configured items are displayed in the Reservations tab of the work order.

Note: Configure to order flow is currently supported for only discrete manufacturing.

Contract Manufacturing

Contract manufacturing refers to scenarios where an original equipment manufacturer (OEM) outsources the manufacturing of a standard product to an external supplier referred to as a contract manufacturer (CM).

A contract manufacturing flow could be initiated either to fulfill a sales order created in Order Management, or as a result of running a supply chain plan in Planning Central and releasing the planned orders. In either case, supply orders are created in Supply Chain Orchestration, following which it initiates the creation of a work order in Manufacturing to track the progress of manufacturing at the contract manufacturer's facility.

Supply Chain Orchestration then sends a request to Purchasing for creating a purchase order on the contract manufacturer for the contract manufacturing service item. Once the manufacturing process is completed, the contract manufacturer reports completion to the OEM. Manufacturing receives the details and automatically initiates the creation of a receipt of the contract manufacturing service item against the purchase order.

Next, it automatically reports completion of the last operation of the work order that results in increasing the contract manufacturing finished good item inventory, and backflush of contract manufacturing service item in the contract manufacturing organization.

Contract Manufacturing is applicable for standard products. It's not supported for configured (ATO, CTO) products. For more information about Contract Manufacturing, refer to the Implementing Contract Manufacturing chapter in the Oracle Supply Chain Management Implementing Manufacturing and Supply Chain Materials Management Guide.

Note: Contract manufacturing flow is currently supported for only discrete manufacturing.

Outside Processing

Outside processing is a commonly observed business process where one or more operations of a work order are outsourced to a supplier who provides specialized manufacturing services. These services may vary depending on the nature of the industry.

The first step is to create and release a work order with supplier operations in Manufacturing. Work orders are scheduled using the unconstrained logic in Oracle Planning Central and Supply Planning. Once the work order is released, a request is sent to Supply Chain Orchestration to create a purchase requisition. Supply Chain Orchestration in turn creates a supply order and triggers the creation of a purchase requisition in Self Service Procurement. An outside processing purchase order is created in Purchasing using the details maintained in the outside processing blanket agreement.

The next step is to execute work order by reporting quantities as completed at the operation prior to the supplier operation following which, a request is sent to Supply Chain Orchestration to create a shipment line. Supply Chain Orchestration in turn creates a supply order line and triggers the creation of a shipment line in Shipping. A shipment is manually created for the shipment line which is then confirmed and closed. Based on the options set for the Ship Confirm Rule, the processes to print packing slip and bill of lading are automatically launched.

The next step is to receive the goods from the supplier in Receiving and deliver them to manufacturing. You can optionally create an Advance Shipment Notice (ASN) in Oracle Fusion Supplier Portal or Oracle Fusion Receiving which can be used to create a receipt. However, ASN creation is mandatory in case of consecutive supplier operations. For a non-serialization enabled supplier operation, receipt and delivery of goods to manufacturing results in automatic completion of quantities at the supplier operation. Supplier operations are then managed and tracked in manufacturing. The receipt, delivery and operation transactions result in receipt and cost accounting in Oracle Cost Management.

For more information about Outside Processing, refer to the Implementing Outside Processing chapter in the Oracle Supply Chain Management Implementing Manufacturing and Supply Chain Materials Management guide.

Inventory Replenishment Min-Max Planning

Min-max planning is an inventory replenishment method where replenishment supply requests are generated based on the specification of minimum and maximum inventory levels for items.

Min-max planning in Oracle Inventory Management optionally considers work order supply and work order component demand in replenishment calculations, and generates replenishment work order requests for manufactured items. This in turn leads to the creation of supply orders in Supply Chain Orchestration, which then initiates the creation of work orders in Oracle Manufacturing. Production activities are reported for the work orders and the final operation completion transaction replenishes the finished goods in inventory. In process manufacturing scenarios, only the primary item can be planned using min-max planning.

For more information about Min-Max Planning, refer to the Plan Inventory Replenishment chapter in the Oracle Supply Chain Management Using Inventory Management Guide.

Direct Procurement of Materials for Work Orders

In some scenarios, materials that are consumed in the manufacturing process aren't planned in advance. They are instead procured directly for work orders. In such scenarios, you can procure material directly for a work order by creating a requisition and then associating the requisition to the work order and the desired operation in Self Service Procurement. A purchase order is created for the requisition, and material is received and delivered directly to the work order. You can review the details of purchase requisitions, purchase orders, and receipts from the work order, and perform corrective actions, such as correcting receipt quantities and returning materials.

Project-Specific Manufacturing

Project-specific manufacturing refers to a supply chain management scenario where manufacturing activities are tracked by project. In such scenarios, executing work orders and manufacturing transactions in the context of a project is essential to ensure that the right material and resources are used and manufacturing costs are allocated to the right project. In addition, it's necessary to ensure that only the eligible raw material and subassemblies are used in project-specific manufacturing work orders and completed products are put away into project-specific inventory.

Supply Chain Management along with Oracle Fusion Project Portfolio Management application provides an end-to-end, integrated solution to support project-specific manufacturing execution. This solution supports business processes of both manufacturing, and asset intensive companies. It provides the ability to execute project-specific manufacturing by creating a work order, or through orderless execution, issue components from common, or project-specific inventory, and put away the end product into project-specific inventory. You can purchase outside processing services, procure material directly for project-specific work orders, and import material and resource costs to the project.

Overview of Dependencies and Interactions With Other Cloud Applications

To support discrete and process manufacturing business processes, Oracle Manufacturing integrates with the following supply chain management applications:

Oracle Product Management Applications: Manufacturing references items and item structures maintained in Oracle Product Model to create and manage work definitions, work orders, and record material transactions. Manufacturing processes the item structure changes in Product Model to the impacted work definitions. Manufacturing lead times calculated in Manufacturing are updated in the Product Model.

Production Exceptions reported in Manufacturing are stored and maintained as Quality Issues in the Oracle Quality Issue and Action Management application.

Oracle Fusion Supply Chain Management Common Components: Manufacturing references Plant Parameters, Unit of Measure (UOM), calendars, shifts, and exceptions maintained in the Supply Chain Management Common Components application, for work definition and work execution. The IoT Production Monitoring application defined

as a Third-Party Application in the Setup and Maintenance work area is used by manufacturing through Supply Chain Common Component services to drill down to the IoT Production Monitoring application. Default Expenditure Types defined in the Supply Chain Management Common Components application are defaulted on to project-specific work orders, resource, and orderless transactions. Manufacturing interacts with Supply Chain Management Common Components to perform Project cost transaction validations.

Oracle Fusion Trading Community Model: Labor resource instances in Manufacturing can be optionally associated to a person record maintained in the Trading Community Model. Employees and Contingent Workers defined in Human Capital Management can be associated to Manufacturing through the Trading Community Model.

Oracle Fusion Cloud Supply Chain Planning Applications: Manufacturing interacts with Oracle Fusion Production Scheduling for constrained work order scheduling. Oracle Supply Chain Planning applications collect manufacturing data for unconstrained and constrained supply planning, replenishment planning, and sales and operations planning. Oracle Supply Chain Planning applications use the lead time values calculated by Manufacturing and stored in the Product Model.

Oracle Fusion Cloud Inventory Management: Subinventories, locators, lots and serials maintained in Inventory Management are used in Manufacturing for work order-based and orderless execution. Material transactions created in Manufacturing are interfaced to Inventory Management. On-hand and reservation details maintained in the Inventory Management application are displayed in work orders. Work order supply reservations in Inventory Management are updated when performing operations transactions in Manufacturing. Manufacturing uses inventory on-hand quantities maintained in Inventory Management to calculate the material availability and shortage at work order level. Manufacturing interacts with Inventory Management to pick materials that are required to execute a work order.

Oracle Manufacturing integrates with Warehouse Management System via Inventory Management to pick material for work orders and execute movement requests in WMS.

Oracle Fusion Cloud Supply Chain Orchestration: Supply Chain Orchestration interacts with Manufacturing to create and update work orders against supply orders. It interacts with work order business events to get details related to progress on a work order. Manufacturing interacts with Supply Chain Orchestration to create purchase requisitions and shipment lines and manage demand side changes in outside processing. Supply Chain Orchestration communicates details of purchase orders and shipments that are created in outside processing to Manufacturing. In the event of any supply side changes in outside processing, Supply Chain Orchestration communicates such changes that results in logging of supplier operation exceptions in Manufacturing.

Oracle Fusion Cloud Cost Management: Work definitions maintained in Manufacturing are referenced by Cost Management for cost planning. Work order status updates, operations and resource transactions in Manufacturing are transferred to Cost Management for cost accounting.

Oracle Fusion Cloud Procurement Applications: For procuring materials directly for work order operations, Manufacturing provides a list of work orders and related operations for displaying in the Oracle Fusion Self Service Procurement application to create a requisition with reference to a work order operation. Manufacturing references the related purchase requisition and purchase order details maintained in the Procurement applications to display in the Review Purchased Item Details page.

For contract manufacturing, Manufacturing references purchase order details maintained in the Oracle Fusion Purchasing application for display in contract manufacturing work orders.

For outside processing, Manufacturing interacts with Purchasing to display outside processing requisitions and purchase orders in the Review Supplier Operations Details page for a work order operation.

For direct item procurement for work orders, Manufacturing provides a list of work orders and the related operations to display in the Self-Service Procurement application to create a purchase requisition with reference to a work order operation. In addition, Manufacturing references the related purchase requisition and purchase order details maintained in the Procurement applications to display in the Review Purchased Item Details page.

Oracle Shipping: Manufacturing interacts with Shipping to display outside processing shipment details from the Review Supplier Operation Details page.

Oracle Receiving: In contract manufacturing, manufacturing interacts with Receiving for the creation of the receipt of the contract manufacturing service item. In outside processing, Receiving interacts with Manufacturing to progress quantities at supplier operations after the receipt and delivery of the outside processing service item. Manufacturing interacts with Receiving to display the outside processing receipt and delivery details, and manage corrections and returns from the Review Supplier Operation Details page. It also interacts with Receiving to display the receipt and delivery details for items procured directly for work orders from the Review Purchased Items Details page.

Oracle Quality Inspection Management: Inspection characteristics and inspection plans are defined and maintained in Quality Inspection Management. Manufacturing initiates inspection plans during work order operation transactions to report inspection results, and to automatically decide on dispositions of the inspected quantities or serials. Inspection results captured while reporting manufacturing transactions and stored in the Quality Inspection Management application can be accessed from the Work Execution Work Area.

Oracle Fusion Cloud Asset Lifecycle Management: Material transactions (work order based transactions and orderless transactions), and operation transactions performed in Manufacturing are interfaced to Asset Lifecycle Management for tracking product genealogy. Equipment resource instances are referenced from Asset Lifecycle Management. Equipment resource instances defined in Manufacturing are optionally associated to Assets defined in Asset Lifecycle Management.

Oracle Fusion Electronic Signatures and Electronic Records: Manufacturing interacts with Electronic Signatures and Electronic Records to capture electronic signatures and generate electronic records while managing standard operations, work definitions, reporting work execution transactions, and closing production exceptions in Manufacturing.

Oracle IoT Production Monitoring: Oracle Internet of Things (IoT) Production Monitoring Cloud in manufacturing environments helps you to monitor production flow and equipment health because it can detect statistical and pattern anomalies. The IoT Production Monitoring makes predictions based on equipment sensor attributes, configurable key performance indicators (KPIs), and a rules engine. IoT has built-in artificial intelligence (AI) and machine learning (ML) models and algorithms.

The prebuilt integration between Manufacturing and IoT Production Monitoring application provides operational visibility into real-time production monitoring and actionable insights by sharing connected equipment resource instances, and synchronizing manufacturing work orders. Manufacturing work orders are automatically synchronized with IoT Production Monitoring, including information about the work orders' plant, products, equipment and labor resources, and equipment and labor resource instances. In addition, it allows you to extend your current manufacturing workflows to natively include robotic and automation equipment by providing the following capabilities:

- Define a manufacturing resource as automation equipment
- Associate a program file name, location, and version to automation equipment resource
- Execute an operation based on a start signal sent to the automation equipment
- Navigate to digital twin view of automation equipment to review real-time contextual telemetry and transactional data related to work order operation execution
- Automatically create completion transactions in Manufacturing upon receiving completion signal from automation equipment
- Automatically create completion and rejection transactions in Manufacturing upon receiving quality disposition details from Quality Management, based on the data received from automation equipment
- Review real-time contextual telemetry and transactional data related to work order operation execution in the digital twin view of the automation equipment
- Automatically complete an operation based on the signal received from the automation equipment

- Automatically report production exceptions in exception situations

Oracle Project Portfolio Management Cloud Applications: Expenditure types defined in Project Portfolio Management are associated to resources. Projects and Tasks defined in Project Portfolio Management are referenced on work orders and orderless transactions.

Oracle Fusion Cloud Maintenance Management: An equipment profile defined in Maintenance Management (part of Oracle Fusion Cloud Supply Chain & Manufacturing) can be assigned to a standard operation resource, work definition operation resource, or a work order operation resource in Manufacturing. If an equipment profile is associated, an equipment resource instance is qualified during assignment of work or reporting equipment usage.

Oracle Fusion Cloud Talent Management: A job profile defined in Talent Management (part of Oracle Fusion Cloud Human Capital Management) can be assigned to a standard operation resource, work definition operation resource, or a work order operation resource in Manufacturing. If a job profile is associated, operator is qualified during assignment of work or reporting labor usage.

Business Intelligence: Manufacturing uses Oracle Transactional Business Intelligence (OTBI) and BI Publisher (BIP) for real-time, self-service reporting of manufacturing work orders and transactions. Business users can use the subject areas exposed in OTBI to build their own custom analyses. You can also use predefined BIP reports or build your own custom BIP reports, which require formatted layouts.

External Integration: Manufacturing supports importing Work Definitions through ADFdi (ADF Desktop Integration) templates. Work Definitions, Work Orders, Operations, Resources, and Material Transactions can be imported into Manufacturing through File-Based Data Import (FBDI) and REST web services. All view objects (VO) belonging to Manufacturing are exposed in BI Console Connector (BICC) for you to extract data out of the Manufacturing and integrate with your own external data warehouse or reporting tool.

Oracle Visual Builder Add-In for Excel: Oracle Manufacturing Cloud supports the use of Oracle Visual Builder Add-in for Excel to integrate Microsoft Excel spreadsheets with many of the Manufacturing Cloud REST services to retrieve, analyze, and edit business data from the REST service. For example, you can download your work order data to an Excel spreadsheet, work with it, and upload your changes back to the REST service. After you install the add-in, a new ribbon tab (Oracle Visual Builder) appears in Microsoft Excel. You can use the buttons in this ribbon tab to configure a worksheet to integrate with a REST service and download the data to a data table that you create in the worksheet. After you create the data table and populate it with data, you can review, modify, and create data before uploading changes to the REST service. After you integrate the Excel worksheet with the REST service, you can optionally publish the Excel workbook that contains the integrated worksheet.

For more information, see the Get Started with the Oracle Visual Builder Add-in for Excel chapter in the Oracle Cloud Using the Oracle Visual Builder Add-in for Excel guide.

2 Manage Manufacturing Plant

Overview of Manufacturing Plants

A manufacturing plant is a type of inventory organization in which the manufacturing of a product is carried out. Manufacturing plants are categorized as:

- In-house manufacturing
- Contract manufacturing

Using the Setup and Maintenance work area, an SCM implementor sets an inventory organization either as an in-house manufacturing plant or a contract manufacturing plant in the **Manage Inventory Organization Parameters** page. Further, using the **Manage Plant Parameters** task, the parameters are set which influence the nature of the plant.

To know more about this, refer to the Implementing Manufacturing chapter in the Implementing Manufacturing and Supply Chain Materials Management guide.

Manufacturing plants are made up of work areas, which comprise work centers, resources, and resource instances. Here's an illustration:

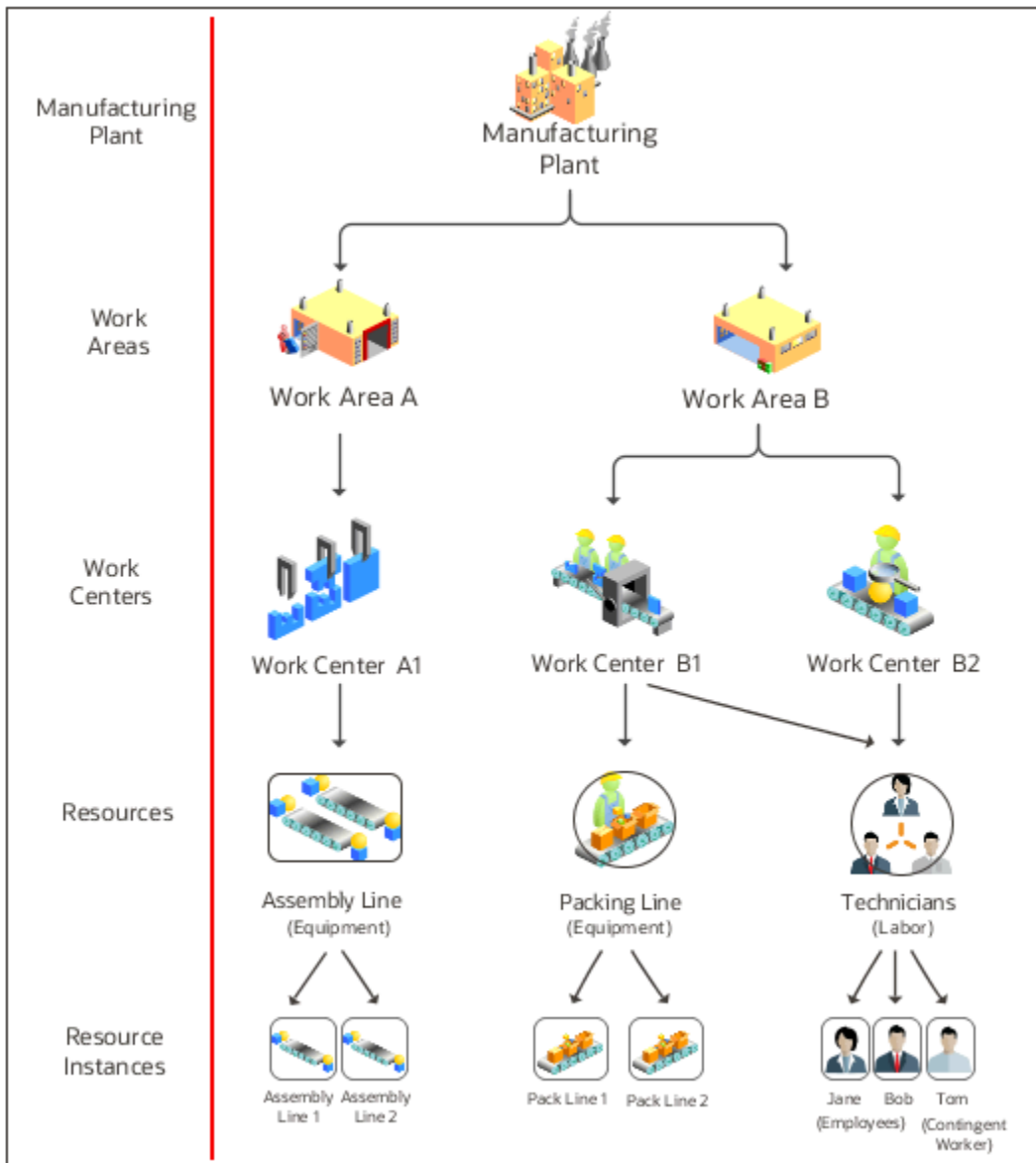

Figure 1 An illustration of a manufacturing plant.

Overview of the Steps to Set Up Your Manufacturing Plant

As a manufacturing engineer, you must set up the manufacturing plant that's used by a production supervisor or a production operator for their day-to-day manufacturing tasks. Here's how you set up your manufacturing plant:

1. Create work areas.

A work area is a specific region in the manufacturing plant where you execute production activities.

2. Create resources.

Resources are people, equipment, and tools allocated to a work center.

3. Create work centers and associate each of them with an appropriate work area.

Work centers are specific production units that consist of people or equipment.

4. Assign resources to work center and allocate resource units to shifts of your manufacturing plant. This helps you to maintain a work center resource calendar for each resource.
5. (Optional) Create specific instances of each resource that you created. Resource instances are specific equipment or individual people working in your shop floor.
6. (Optional) Create standard operations, where you define the attributes and assign specific resources to it. So, when you reference a standard operation to a work definition, all its attributes and resources are carried forward to the work definition. This helps you save effort and time by enabling reuse of the standard operation.

You can use the user interface to create the setup data. To create or update setup data in bulk, you can use the export and import of CSV file packages or Excel spreadsheets.

Note: For more information about how to export and import CSV files to and from manufacturing setup objects, such as work areas, work areas centers, and resources, refer to the Export and Import CSV File Packages topic of the Using Functional Setup Manager guide.

Related Topics

- [How You Manage Work Areas](#)
- [How You Manage Resources](#)
- [How You Manage Work Centers](#)
- [How You Manage Standard Operations](#)

Work Areas

How You Manage Work Areas

A work area is a specific region in the manufacturing plant where you execute production activities. The work area is a physical, geographical, or logical grouping of work centers.

Here's an illustration of how work areas relate to manufacturing plants and work centers.

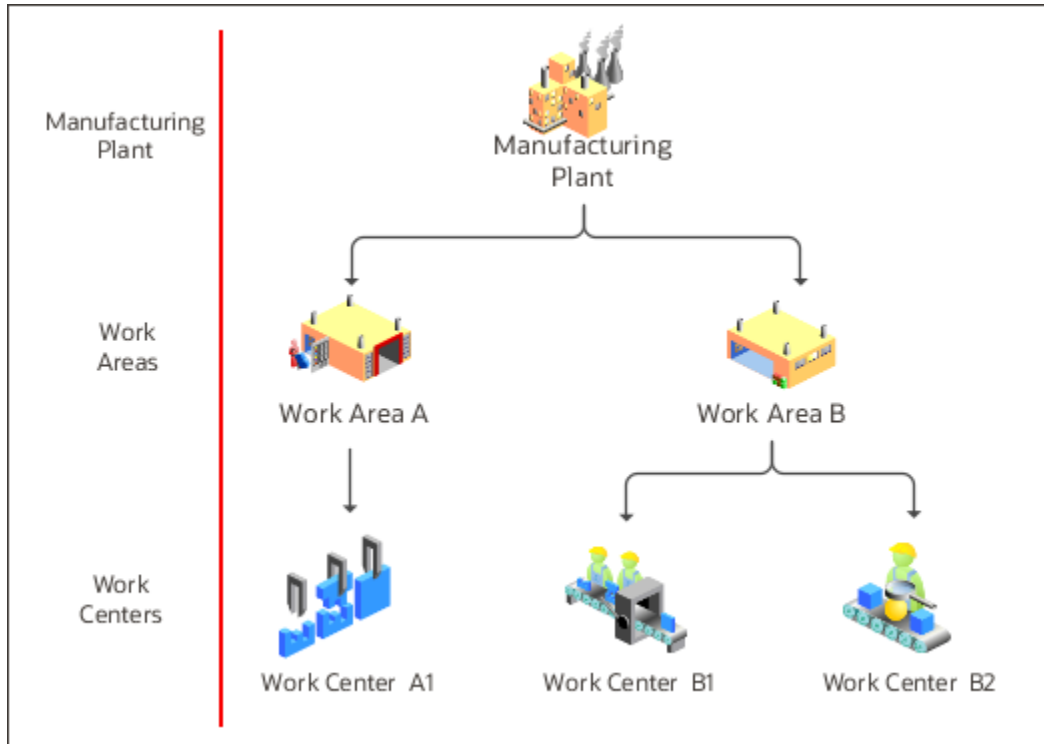

Figure 2 An illustration of how work areas relate to manufacturing plants and work centers.

As a manufacturing engineer, you must define at least one work area for a manufacturing plant and at least one work center for each work area. Use the **Manage Work Areas** page to create, edit, and delete work areas.

A production operator can report material, resource, and operation transactions performed at work centers that belong to a specific work area.

Navigate to the **Manage Work Areas** page using one of two ways:

- Click **Navigator > Work Definition**.
In the Tasks pane, select **Manage Work Areas**.
- In the Setup and Maintenance work area, go to the following:
 - Offering: Manufacturing and Supply Chain Materials Management
 - Functional Area: Manufacturing Master Data
 - Task: Manage Work Areas

Related Topics

- [How You Manage Work Centers](#)
- [How You Manage Resources](#)
- [Overview of Manufacturing Plants](#)

Create a Work Area

To create a work area:

1. On the **Manage Work Areas** page, click the **Add** icon.
2. On the Create Work Area page, add these work area details:
 - o A unique name for the work area
 - o A unique code for the work area
 - o A description of the work area
3. Click **Save** and **Close**.

Edit a Work Area

To edit a work area:

1. On the **Manage Work Areas** page, click the work area link that you want to edit.
2. On the Edit Work Area page, you can update the work area name, code, or description details.
3. Click **Save** and **Close**.

Deactivate a Work Area

To deactivate a work area:

1. In the Work Definition work area , on the **Manage Work Areas** page, click the work area link that you want to deactivate.
2. On the Edit Work Area page, you can update the date in the **Inactive On** field to a future date.
3. Click **Save** and **Close**.

To use a deactivated work area, you must first reactivate it.

Delete a Work Area

To delete a work area, select the work area and that you want to delete and click Delete. You can't delete a work area that's in use.

Note: You can also query, create, update, or delete a work area using a REST API.

Resources

How You Manage Resources

Resources are people, machines, and tools allocated to a work center. Resources are of two types:

- Labor
- Equipment

If you're responsible for manufacturing engineer tasks for your enterprise, you can search for, create, edit, and delete the resources using the **Manage Resources** page.

Navigate to the **Manage Resources** page using one of two paths:

- Click **Navigator > Work Definition**.
In the Tasks pane, select **Manage Work Areas**.
- In the Setup and Maintenance work area, go to the following:
 - Offering: Manufacturing and Supply Chain Materials Management
 - Functional Area: Manufacturing Master Data
 - Task: Manage Production Resources

Here's an illustration of how the resources and resource instances associate to a work center.

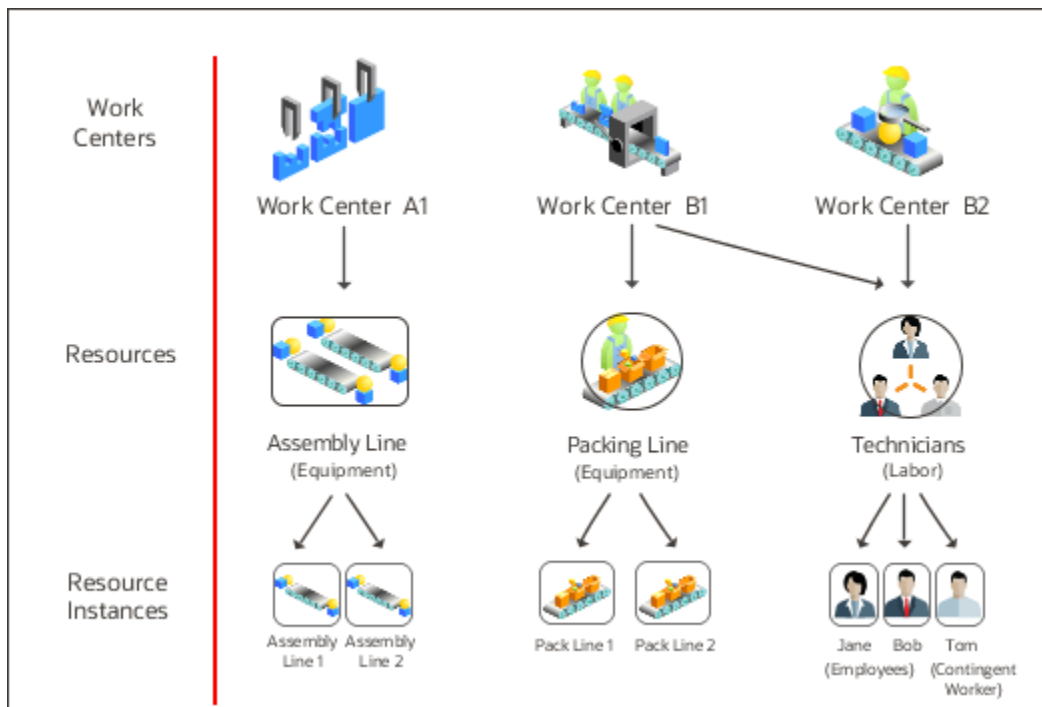

Figure 3 An illustration of how the resources and resource instances associate to a work center.

You can schedule a resource in a work definition and work order if the usage UOM belongs to the UOM class as defined in the profile SCM Common: Default Service Duration Class (RCS_DEFAULT_UOM_CLASS_CODE_FOR_SVC_DURATION). For any scheduled resource, it's recommended that this profile be set to a UOM class that represents units of measure for Time.

Resource Instances

Resource instances are granular representations of a resource in the Oracle Fusion Cloud Manufacturing application. One or more resource instances can be associated to a resource. You can identify a resource by a unique code known as the identifier, and a name.

You can also optionally assign a primary work center to the resource instance to identify the department or location that the resource instance primarily works in.

Tip: Assigning a primary work center to a resource instance helps in quick assignment of the resource instance in work orders and work execution transactions.

You can deactivate or reactivate a resource instance by updating the Inactive On field. When a resource instance is deactivated, it's not available for further use until reactivated. You can delete a resource instance only if it's not used in work execution.

Associate Labor Resource Instances

A labor resource instance represents the names of actual people working in the manufacturing shop floor. A labor resource instance can be optionally associated to a person record available in the Oracle Trading Community Architecture. Such associations are unique within a plant.

Note: Oracle Trading Community Architecture represents a repository of person and organization parties identified through their party usages. Oracle Manufacturing allows the subset of Oracle Trading Community Architecture person party records to assign person type resource instances.

Person types in Oracle Trading Community Architecture that can be associated to a resource instance and can be any of the following:

- Employee
- Contingent Worker
- Partner Contact

You can define persons of types Employees or Contingent Workers in Oracle Fusion Cloud Human Capital Management (HCM) and are automatically propagated to the Oracle Trading Community Architecture through the HCM - Oracle Trading Community Architecture auto-sync process.

You can set up persons of type Partner Contact in the Oracle CRM application, which are automatically available in the Oracle Trading Community Architecture.

Associate Equipment Resource Instances

An equipment resource instance represents the names of actual machines being used in the manufacturing shop floor. An equipment resource instance can optionally associated to an Asset Number defined in Oracle Fusion Cloud Maintenance. Such associations are unique within a plant.

Assets must be defined in a location corresponding to the plant and a location type work center in order to be eligible for association to the equipment resource instance.

If you intend to use the equipment qualification feature, then you must associate an asset number to the equipment resource instance. You can view the qualifications defined for the asset number in Maintenance Management using the View Asset qualifications button.

Use the IoT Insights icon provided in the Equipment Resource Instances region, to drill down to the Oracle Production Monitoring, part of the Oracle Fusion Cloud IoT Intelligent Applications to view machine performance, real time sensor data, and insights into analytics, anomalies, predictions, and trends.

Related Topics

- [How You Manage Work Centers](#)
- [How You Manage Work Areas](#)
- [Overview of Manufacturing Plants](#)

Create a Resource

To create a resource:

1. On the **Manage Resources** page, click the **Add** icon.
2. On the Create Resource page, add these resource details:
 - A unique name
 - A unique code
 - A description
3. Select these resource attributes:
 - Type of the resource
The type determines whether the resource is a labor or equipment
 - Class of the resource
The lookup code for this resource class is defined in the Setup and Maintenance work area
 - Usage UOM, which is the unit of measure for the planned and actual usage of the resource
4. If you require to define cost rates for the resource, select the **Costing enabled** check box.
5. (Optional) If your organization is enabled for tracking by project, and you want to cost this resource, select these attributes:
 - Costing enabled check box
 - The default expenditure type of the resource
The specified expenditure type is used while transferring the resource transactions to Costing
6. Click **Save** and **Close**.

You can schedule a resource in a work definition and work order if the usage UOM belongs to the UOM class as defined in the profile SCM Common: Default Service Duration Class (RCS_DEFAULT_UOM_CLASS_CODE_FOR_SVC_DURATION). For any scheduled resource, it's recommended that this profile be set to a UOM class that represents units of measure for Time.

Note: After you create a resource, you can check the Automation equipment attribute of equipment resource to define to represent a robot or an industrial equipment that can automatically perform a work order operation. You would need to define document items in fusion cloud product development to represent program files used by the automation equipment and associate one or more program files to it by clicking on the Program files icon. You can review the current revision of a program file represented by that of the document item. Changes to the program file are managed by managing changes to the corresponding document items. The definition of a resource as automation equipment is synchronized to IoT Production Monitoring for further configuration and onboarding.

Note: The Automation equipment attribute of a resource is displayed only if the Automate manufacturing execution with robotic and industrial equipment plant parameter is enabled.

Edit a Resource

To edit a resource:

1. Click the resource link that you want to edit.
2. On the Edit Resource page, you can update the resource name, code, description, class, or costing enabled details.
3. Click **Save** and **Close**.

When you edit a resource, you can't do any of these:

- Edit the resource type when a resource instance is associated.
- Change the usage UOM of a resource when it's associated with a work center.

You can't uncheck the automation equipment attribute of the resource if one or more program files are associated to it.

Deactivate a Resource

To deactivate a resource:

1. In the Work Definition work area , on the **Manage Resources** page, click the resource link that you want to deactivate.
2. On the Edit Resources page, you can update the date in the **Inactive On** field to a future date.
3. Click **Save** and **Close**.

To use a deactivated resource, you must first reactivate it.

Delete a Resource

To delete a resource, select the resource that you want to delete and click Delete.

You can't delete an active resource or a resource that's assigned to a work center.

Note: You can also query, create, update, or delete a production resource using a REST API.

How You Manage Resource Instances

Resource instances are detailed representations of a labor or equipment resource in the Oracle Fusion Cloud Manufacturing application. You can define specific instances of each resource. For example, you might identify the machines used on your shop floor, and the name of people working there. You can associate one or more resource instances to a resource.

Labor Resource Instances

A labor resource instance is the name of a person working in the manufacturing shop floor. You can optionally associate specific person types to a labor resource instance. A person type in the Manufacturing application must be an employee, a contingent worker, or a partner contact. Here's how each person type is set up:

Person Type	How It's Set Up
Employee and Contingent Worker	Employees and contingent workers are defined in Oracle Fusion Cloud Human Capital Management, and are automatically propagated by the auto-sync process to the Oracle Trading Community Model.
Partner Contact	A partner contact is set up in an Oracle Fusion Cloud Customer Relationship Management, which is automatically available in the Oracle Trading Community Model.

Equipment Resource Instances

An equipment resource instance is the name of a machinery being used on the manufacturing shop floor.

You can optionally associate assets to your equipment resource instances. You must define assets in Maintenance with a location corresponding to your manufacturing plant and a location type Work Center.

View IoT Insights

If you have set up your integration with IoT Production Monitoring, you can view your resources and resource instances belonging to your manufacturing plant in IoT.

Additionally, you can view useful insights by navigating through the IoT Insights icon provided for each equipment resource instance. Here's the list of IoT insights that you can view:

- Machinery performance
- Real time sensor data
- Insight into analytics, anomalies, predictions, and trends

Create a Labor Resource Instance

To create a labor resource instance:

1. On the **Manage Resources** page, click the resource link for which you want to create a resource instance.
2. On the Edit Resource page, in the Resource Instances section, click the **Add** icon.

3. Provide these resource instance details:
 - o A unique code as an identifier
 - o A name to the resource instance
4. Select and assign a primary work center to the resource instance to identify the department or location that the resource instance primarily works in.
5. (Optional) Select the person name working in the manufacturing shop floor. Such associations are unique within a plant.
6. Click **Save** and **Close**.

Create an Equipment Resource Instance

To create an equipment resource instance:

1. On the **Manage Resources** page, click the resource link for which you want to create a resource instance.
2. On the Edit Resource page, in the Resource Instances section, click the **Add** icon.
3. Provide these resource instance details:
 - o A unique code as an identifier
 - o A name to the resource instance
4. Select and assign a primary work center to the resource instance to identify the department or location that the resource instance primarily works in.
5. (Optional) Select an asset number defined in the Maintenance Cloud. Such associations are unique within a plant.
6. Click **Save** and **Close**.

Edit a Resource Instance

Edit a Resource Instance:

1. On the **Manage Resources** page, click the resource link that you want to edit.
2. On the **Edit Resource** page, in the Resource Instances section, you can update the resource instance identifier or the resource instance name details.
3. Click **Save** and **Close**.

Deactivate a Resource Instance

To deactivate a resource instance:

1. In the Work Definition work area , on the **Manage Resources** page, click the resource instance link that you want to deactivate.
2. On the Edit Resources page, you can update the date in the **Inactive On** field to a future date.
3. Click **Save** and **Close**.

To use a deactivated resource instance, you must first reactivate it.

Delete a Resource Instance

Delete a Resource Instance:

1. On the **Manage Resources** page, click the resource link that you want to delete.
2. On the **Edit Resource** page, in the Resource Instances section, select the resource instance and click **Delete**.

You can't delete a resource instance that's in use in work execution.

Note: You can also query, create, update, or delete a labor resource instance using a REST API. Similarly, you can also query, create, update, or delete an equipment resource instance using a REST API.

Synchronize Resource and Resource Instances to IoT Production Monitoring

In a manufacturing plant, you can obtain operational visibility into real-time production monitoring and obtain actionable insights by integrating with the IoT enabled sensors attached to the equipment in your shop floor. You can set up integration of your manufacturing plant with IoT Production Monitoring by enabling the plant parameter Enable synchronization to IoT Production Monitoring.

For more information about setting up the integration, see the Implementing Manufacturing and Supply Chain Materials Management guide.

After you have set up your integration with Oracle Fusion Cloud IoT Production Monitoring, labor and equipment resources and its resource instances are synchronized in real time using a push mechanism. This synchronization ensures that the latest information in Oracle Manufacturing is available in IoT Production Monitoring in a real time basis.

Here's a list of entities that are synchronized to IoT Production Monitoring:

- Synchronize Equipment Resources
- Synchronize Labor Resources
- Synchronize Equipment Resource Instances
- Synchronize Labor Resource Instances

Synchronize Equipment Resources

Equipment resources are synchronized as **Machine Types** in IoT Production Monitoring. When you create, update, or delete equipment resources in Manufacturing, the application automatically synchronizes the corresponding changes in IoT Production Monitoring. You can then associate device references to these **Machine Types** in IoT Production Monitoring.

Synchronize Labor Resources

Labor resource instances are synchronized as Operators in Oracle Production Monitoring, part of the Oracle Fusion Cloud IoT Intelligent Applications. When you create, update, or delete labor resource instances in Manufacturing, the application automatically synchronizes the corresponding changes in Production Monitoring.

Synchronize Equipment Resource Instances

Equipment resource instances are synchronized as **Machines** in IoT Production Monitoring. When you create, update, or delete equipment resource instances in Manufacturing, the application automatically synchronizes the corresponding changes in IoT Production Monitoring. You can then associate the actual devices to these **machines** in IoT so that you can automatically report production to Manufacturing.

Synchronize Labor Resource Instances

Labor resource instances are synchronized as **Users** with an Operator role in IoT Production Monitoring. When you create, update, or delete labor resource instances in Manufacturing, the application automatically synchronizes the corresponding changes in IoT Production Monitoring.

Work Centers

How You Manage Work Centers

Work centers are specific production units that consist of people or equipment. You can associate each work center with an active work area.

As a manufacturing engineer, here's what you can do using the Manage Work Centers page in the Work Definition work area:

- Create, edit, and delete work centers
- Add resources to a work center and allocate resources to different shifts
- View and manage exceptions associated to the resources

Navigate to the **Manage Work Centers** page using one of two paths:

- Click **Navigator > Work Definition**.
In the Tasks pane, select **Manage Work Centers**.
- In the Setup and Maintenance work area, go to the following:
 - Offering: Manufacturing and Supply Chain Materials Management
 - Functional Area: Manufacturing Master Data
 - Task: Manage Work Centers

Related Topics

- [How You Manage Work Areas](#)
- [How You Manage Resources](#)
- [How You Manage Work Center Resource Calendars](#)
- [Overview of Manufacturing Plants](#)
- [Create a Resource Exception](#)

Create a Work Center

To create a work center:

1. On the **Manage Work Centers** page, click the **Add** icon.
2. On the **Create Work Center** page, add these work center details:
 - o A unique name
 - o A unique code
 - o A description
3. Select an active work area and supply subinventory to which the work center is associated.
4. Click **Save** and **Close**.

Edit a Work Center

To edit a work center:

1. On the **Manage Work Centers** page, click the work center link that you want to edit.
2. On the **Edit Work Center** page, in the General Information section, click the **Show More** link.
3. Update the work center name, code, description, work area, supply subinventory, or supply locator details.
4. Click **Save** and **Close**.

Note: You can deactivate a work center when you're editing it. To do so, update the **Inactive On** date to any future date. To use a deactivated work center, you must first reactivate it.

Delete a Work Center

To delete a work center, select the work center and click Delete.

If you're unable to delete a work center, there are three possible reasons why:

- A resource is associated with it
- It's being referenced in work definition operation
- It's being referenced in work order operation

Note: You can query, create, update, and delete a work center using a REST API.

Assign Resources to a Work Center

Now that you have created a work center, assign some resources to it. You can assign the resources that are either labor or equipment.

1. Click the work center link to which you want to assign resources.
2. On the **Edit Work Center** page, click the **Add** icon in the Resource Availability section.
3. Select the resource name.
4. In the **Default Units Available** field, provide the total number of resource units available in the work center.
5. Select the **Available 24 Hours** check box if this resource is working round the clock.

Leave it unchecked if you want the resource to be available in shifts. You must allocate these resource units to specific shifts.

24 hour resources are available all 24 hours (midnight to midnight) on all working days of the calendar. Work center resource exceptions can't be defined for such resources. However, when you define a shift exception in the production calendar, the 24 hour resources become completely available when you add shifts on a non-working day or become unavailable when you remove all shifts of a working day.

6. Select the **Check Capable to Promise** check box if you want the Global Order Promising engine to consider the capacity of this resource during order promising.
7. In the Utilization field, enter the percentage of the resource time available for manufacturing.

For example, if you enter 50%, the scheduler doubles the length of time that the resource is required to complete a work order.

8. In the efficiency field, enter the percentage of the time a resource takes to complete manufacturing operations.
9. Click **OK**.
10. Click **Save** and **Close**.

You can also add resources to a work center while creating a work center.

Here's an example of how you can assign the resources to work centers.

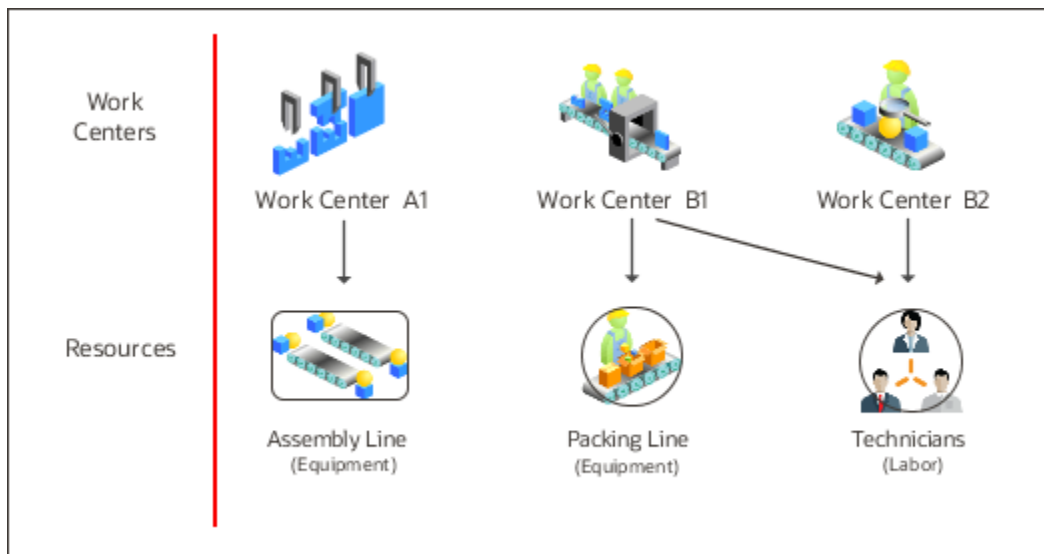

Figure 4 An illustration of how you can assign the resources to work centers.

How You Allocate Resource Units to Shifts

If you don't select the Available 24 Hours check box while assigning the resource to a work center, then units of that resource are made available in shifts.

You need to allocate the number of resource units for each shift. You do this on the **Edit Work Center** page in the column for each shift. If you don't manually specify the number of units, default number of units available in that work center is used for each shift.

The default units available are automatically assigned to all the shifts of your calendar, which you can modify.

Example

Let's say you assign four resources, **R1**, **R2**, **R3**, and **R4** to a work center **WC1**.

- WC1 functions in two shifts, **Day Shift** and **Night Shift**.
- 2 units of each resource are available in work center **WC1**.
- You didn't select the **Available 24 Hours** check box while assigning any resource, so resource units are allocated to shifts

Let's say you have varying resource requirements. Let's consider each one and understand how you implement them.

For R1: You want two units of R1 for the day shift only.

1. In the Resource Availability Region, in the Day Shift column for R1, enter a value of 2.

For R2: You want one unit of R2 for the day shift and one unit for the night shift.

1. In the Resource Availability Region, in the Day Shift column for R2, enter a value of 1.
2. In the Night Shift column also, enter a value of 1.

For R3: You want both units of R3 available for both shifts.

1. In the Resource Availability Region, in the Day Shift column for R3, enter a value of 2.
2. In the Night Shift column also, enter a value of 2.

For R4: You want R4 available all day.

1. Click the resource link.
2. Select the **Available 24 Hours** check box.
3. Click **OK**.

Here's what your resource availability looks like now:

Resource	Default Units Available	Day Shift	Night Shift
R1	2	2	-
R2	2	1	1

Resource	Default Units Available	Day Shift	Night Shift
R3	2	2	2
R4	2	-	-

Note: The **Resource Calendar** icon is enabled and visible for those resources that are available in shifts.

When you're done, click **Save and Close**.

You can also use the Functional Setup Manager (FSM) to bulk export and import work center resource units allocated in a plant calendar shift without work center calendar overrides in the Setup and Maintenance work area. When migrating setup data between test and production environments, you can export work center resource shifts data from one environment and import it into another environment.

Associate Override Calendars to a Work Center

Specify one or more calendars with different date ranges within a work center to override the plant-level production calendar and model variations in shifts and resource capacity and availability.

If your work center operates in different shift timings or calendar than the manufacturing calendar specified in Plant Parameters of the manufacturing plant, then you can specify override calendars at the work center level by associating a different calendar for a specific date range effectivity.

All resources belonging to the work center inherits its capacity and operating times from this override calendar. Further you can associate multiple calendars to the work center for different date range effectivity to model production capacity variations due to seasonal demands. The date range effectivity for work center-calendar association will be enforced to be nonoverlapping and contiguous.

You can see the Override Schedule check box on the Edit Work Center page, which isn't selected by default.

To associate override calendars:

1. On the **Edit Work Center** page, select the **Override Schedule** check box in the General Information section and the Work Center Calendar region displays.
2. The application automatically adds an entry for Plant calendar with null start date in this region. The existing resources of the work center are automatically defaulted with resource units.
3. Add an override calendar by selecting an override calendar name and specifying a start date. The application automatically adds an end date to the earlier calendar. The existing resources and the shift units are automatically defaulted for the newly added override calendar, and you can optionally update the shift units specific to the override calendar.

You can add multiple override calendars. Also, you can modify, delete an override calendar if the start date is in the future.

If you add a resource in the context of an override calendar, then that resource would be by default assigned only to that calendar and to the plant calendar. The resource shift units will be defaulted with the default shift units, and you can update them.

You can delete only a latest override calendar provided its in the future date.

You can update the start date of the override calendar provided its in the future date.

You can use the Functional Setup Manager (FSM) to export the work center details along with the override schedule indicator and the override calendars. Also, you can import a new work center or update an existing work center with the Override schedule indicator and provide the details of the override calendars and the calendar association start dates.

Note: Using FSM, you can import resource shift units for the work center resources only for the manufacturing plant calendar.

How Utilization and Efficiency Percentages Impact Scheduling

Utilization and efficiency percentages determine the duration of the resources that are scheduled on a work order.

Work Center Settings That Affect Scheduling

- Utilization percentage
- Efficiency percentage
- Shift assignments

How Scheduling Is Calculated

By default, the utilization and efficiency percentages are set to 100 percent. When you set these percentages to less than 100, the scheduled duration of the resources gets extended.

Let's say you want two hours of work done using a resource. You begin with the assumption that your resources will be fully utilized, and at full efficiency. To know whether your work will be done in two hours, divide the number of work hours by the product of your utilization and efficiency percentages. That's $2 / (1*1)$, which equals 2. This confirms that your work will be done in two hours.

Now let's say you halve the utilization and efficiency percentages. The new calculation is $2 / (0.5*0.5)$, which equals 8. This means your work will take longer to complete, and that's because your resource isn't being fully utilized at 100 percent.

How You Manage Resource Exceptions

You use the work center resource calendar to manage the exceptions related to the resources. Exceptions may also be created in the production calendar. In case of a conflict, the exceptions granted in the work center resource calendar override the ones granted in production calendar.

Related Topics

- [How You Manage Work Center Resource Calendars](#)
- [Create a Resource Exception](#)

Standard Operations

How You Manage Standard Operations

As a manufacturing engineer, you can define similar operations in the manufacturing process as standard operations, which you can reuse in multiple work definitions and work orders. Standard operations are of two types: In-House operations, which are executed in your manufacturing plant, and Supplier operations, which are outsourced to suppliers.

Use the **Manage Standard Operations** page in the Work Definition work area to search for, create, edit, and delete standard operations.

Related Topics

- [Overview of Manufacturing Plants](#)
- [How You Create Work Definitions](#)
- [Create Standard Discrete Work Orders](#)
- [Create Nonstandard Work Orders](#)

Search for the Standard Operations

Here are some pointers to aid your search:

- Search for a standard operation using the name, code, description, work center, or work center code, or supplier of the standard operation.
- Select the **Include inactive operations** check box to include the standard operations that are inactive.

Create a Standard Operation

Standard operations are of two types: In-House operations, which are executed in your manufacturing plant, and Supplier operations, which are outsourced to suppliers.

Create an in-house standard operation

1. On the **Manage Standard Operations** page, click the **Add** icon.
2. On the **Create Standard Operation** page, select **In-house** as an operation type.
3. Add these standard operation details:
 - A name for the standard operation
 - A unique code for the standard operation which you can't update when a standard operation is in use in a work definition or a work order.
 - A description of the standard operation
4. Select the active work center you want to associate this standard operation with.

5. Enable one of these based on/considering reporting requirement:

- Count point, to perform the operation and report manually. The Count point and Automatically transact attributes are mutually exclusive.
- Automatically transact, so that the operation is reported automatically, the pull components are backflushed, and the resources are automatically charged when the next count point operation is completed.

Note: If you don't select either of these attributes, this standard operation is said to be an optional operation.

6. (Optional) Select the date on which the standard operation becomes inactive.

7. (Optional) Add attachments. You can attach either a file, or text or an URL file type.

8. (Optional) Select the **Default for automatic work definition** check box to set this operation as default for automatic work definitions.

9. Select the material transaction and operation completion validations:

- Whether or not to allow issue of any additional materials that aren't defined in the work order with push supply type, or manually issue quantities greater than those specified in the work order.
- Whether or not to allow operation completions when materials with push supply type haven't been issued. The possible values are Allow, Allow with warning, and Do not allow.
- Whether or not to allow operation completions when there are any open exceptions. The possible values are Allow, Allow with warning, and Do not allow.

Resources subsection:

10. In the Resources section, click the **Add** icon to assign resources to this standard operation.

11. In the new row, add these standard operation resource details:

- The resource sequence.
- The name of an active resource that's associated to the work center.
- The number of assigned resource units, which can't exceed the available units for the resource as defined in the work center resource availability definition.
- The usage amount of the standard operation resource.
- Whether the resource usage is Fixed or Variable. Select Fixed if the resource usage is fixed per product quantity produced or Variable if it varies with the product quantity produced.

The usage unit of measure as defined in the resource definition. This is a read only field inherited from the resource definition.

- Whether or not this resource is a scheduled resource.
- Whether this resource is the principal resource within a group of simultaneous resources.
- Whether the resource charge type is Manual or Automatic. Select Manual if it's an optional operation.
- The job profile for a labor resource.

A job profile comprised of a set of qualifications that are required for an operator to perform a job. When a job profile is specified for an operation resource, then only those labor resource instances that meet the qualifications can perform the operation.

- The equipment profile for an equipment resource.

An equipment profile specifies the set of qualification requirements that an equipment must possess when performing operations in manufacturing. When an equipment profile is specified for an operation resource, then only those equipment resource instances that meet the qualifications can perform

the operation. You set up the profile, requirements, and asset qualifications in Oracle Fusion Cloud Maintenance.

12. Expand the row.
 - o Select the activity type of this standard operation resource.
 - o Select the date on which the standard operation becomes inactive.

13. (Optional) Attach any attachments by clicking the **Add** icon.

You can attach either a file, or text or an URL file type.

Alternate resources subsection:

14. (Optional) Attach any alternate resources that are ranked by priority by clicking the **Add** icon.

In the Alternates page, you can't update the Basis, Scheduled, and Charge Type which are inherited from the primary resource. The Usage, Inverse Usage and Units Assigned are defaulted from the primary resource definition, which you can update.

Note: If your resource cost is charged to the work order then the **Costing enabled** field is selected by default. This is a read only field inherited from the resource definition. If the check box is enabled, then the Resource cost is charged to Work Order. This is a read only field and is inherited from the resource definition.

15. Click **Save and Close**.

Create a supplier standard operation

1. On the **Manage Standard Operations** page, click the **Add** icon.
2. On the **Create Standard Operation** page, select **Supplier** as an operation type.
3. Add these standard operation details:
 - o A name of the standard operation.
 - o A unique code for the standard operation which you can't update when a standard operation is in use in a work definition or a work order.
 - o A description of the standard operation.
4. Select the work center to associate this standard operation.
You can assign an active work center to an operation.
5. (Optional) Select the date on which the standard operation becomes inactive.
6. (Optional) Attach any attachments by clicking the **Add** icon.
You can attach either a file, or text or an URL file type.
7. Select the material transaction and operation completion validations:
 - o Whether or not to allow issue of any additional materials that aren't defined in the work order with push supply type, or manually issue quantities greater than those specified in the work order.
 - o Whether or not to allow operation completions when materials with push supply type haven't been issued. The possible values are Allow, Allow with warning, and Do not allow.
 - o Whether or not to allow operation completions when there are any open exceptions. The possible values are Allow, Allow with warning, and Do not allow.
8. In the Supplier Operation Details section, search and select these supplier operation details:
 - o The outside processing item that represents the value-added service being performed on the assembly in outside processing.
The item is defined in Product Information Management.

- o The recommended supplier used in creating the requisition.
The supplier is an external party who provides specialized manufacturing services to manufacture a product.
- o A recommended supplier site.
- o The unit of measure for the lead time of a supplier operation.
- o The fixed lead time for the operation which is independent of the order quantity.
- o The variable lead time for the operation which is dependent on the quantity.

9. Click **Save and Close**.

Edit a Standard Operation

You can add, delete, and update the resources and their alternates associated with this standard operation.

Edit a Standard Operation

1. On the **Manage Standard Operations** page, click the standard operation link that you want to edit.
2. On the Edit Standard Operation page, you can update these standard operation details:
 - o The standard operation details such as name, description, inactive date, and attachments.
 - o The Work Center attributes only if there are no resources associated with this standard operation.
3. Click **Save and Close**.

Delete a Standard Operation

To delete a standard operation, on the Manage Standard Operations page, select the standard operation that you want to delete and click Delete.

You can't delete the standard operation if it's being referenced in any work definition operation or any work orders.

How You Use Standard Operations

When you assign a standard operation to a work definition or a work order, all the attributes of this standard operation are inherited by the work definition or the work order. This includes the resources, descriptive flexfields, and attachments assigned to the standard operation.

Use the standard operations in one of two ways:

When You Use The Standard Operation Mode	What You Need To Do	What Happens
Reference a standard operation	Select the Referenced check box when you add the standard operation in the work definition or a work order.	The changes that you make to the standard operation are automatically reflected in the work definitions that reference the standard operation.

When You Use The Standard Operation Mode	What You Need To Do	What Happens
		<p>You can't edit any resources assigned to the standard operation in the work definition. Referencing also ensures that any future changes to the standard operation are reflected in the work definition operation.</p>
<p>Copy a standard operation</p>	<p>Clear the Referenced check box when you add the standard operation in the work definition or work order.</p>	<p>Any future changes that you make to the standard operation aren't reflected in the work definitions and work orders that reference the standard operation.</p> <p>If you require any changes in the copied standard operation, enter them manually for the specific work definition or work order.</p> <p>You can edit and update any attributes. After you remove the reference to a standard operation, you can't reference it again. When you remove the reference to a standard operation, you can add or delete the resources assigned to the standard operation in the work definition.</p>

Manage Standard Operations in a Spreadsheet

If you need to work offline, then manage your standard operations using a Microsoft Excel spreadsheet. You can mass create and update the standard operations and resources by using the Oracle Application Development Framework Desktop Integration (ADFdi).

Here's how the ADFdi feature benefits you:

- After you download the standard operation data hosted on the Oracle Fusion Cloud Manufacturing application to a spreadsheet, you can modify it even when you're disconnected from the application.
- You can perform bulk entry and update of data with ease through a spreadsheet.

To manage standard operations in spreadsheet, you must first download and run the ADFdi Installer:

1. Click **Navigator > Tools > Download Desktop Integration Installer**.
2. Click **Save File** to download the desktop integration installer.
3. Double-click the executable file to install the ADF Desktop Integration Installer.
4. Click **Install** to proceed with the installation process.
5. Click **Close** to complete the installation process.

Then, download the standard operation data:

1. Click **Navigator > Work Definition**.
In the Tasks pane, click the **Manage Work Definitions in Spreadsheet** link to download the worksheets.
2. Select the **Open with** option to open the Work Definition Excel file.
The three worksheets are Standard Operations, Standard Operations Resources, and Standard Alternate Resources.

3. Click **Yes** to connect to the application.
4. Login with your credentials and start working.

Here's how you manage the standard operations in a spreadsheet:

1. Create and update the standard operations and resources in bulk by using the ADFdi.
You must create the standard operation header details first, and then define the resource details and alternate resources for it.
2. Search for the standard operation details based on the search criteria available on each spreadsheet.
You must search for the standard operation header or resource details before you can update any of the attributes.
You must not run a blind report with values not specified for any of the parameters.
3. Update the data by overwriting the data in the search results table.
After the update, an indicator appears in the Changed column for each updated row. The inactive cells are read only fields and are not included in the upload process.
4. Click **Upload** when you're ready to synchronize the changes with the Oracle Fusion applications. Any data validation errors will be shown in the spreadsheet after the upload. Check the Row Status column to know if the upload was successful.

Note: You can upload, query, or update the descriptive flexfields details in the work definitions using ADFdi. However, while uploading or updating the descriptive flexfields in the standard operation using ADFdi, only data type validations are performed. You can also query, create, update, or delete a standard operation using a REST API.

Overview of Electronic Signatures and Electronic Records for Standard Operation Management

Manufacturing engineers use the Oracle Fusion E-Signatures and E-Records to securely capture, store, retrieve, and print e-records and e-signatures inline while creating and updating a standard operation in the Work Definition work area.

The E-Signatures and E-Records feature is disabled by default. When enabled, the e-signature approval process is initiated and approvers are required to authenticate transactions.

Here are the details that an e-record contains with:

- Standard Operation Details
- Attachment Details
- Resource Details
- Resource Level Attachment Details
- Alternate Resource Details

As an SCM implementation consultant, you need to enable and configure this feature.

Enable:

1. In the Setup and Maintenance work area, go to the following:
 - Offering: Manufacturing and Supply Chain Materials Management

- Functional Area: Facilities
 - Task: Configure Electronic Signature Preferences
2. Click the **Configure Electronic Signature Preferences** link.
 3. On the **Configure E-Signature Preferences** page, in the Organization section, select the organization that you want to enable the E-Signature for Standard Operation Management transaction.
 4. On the right pane, select the check box in the **Signature Enabled** column for the transactions for which to activate e-signatures.
 5. Click **Save and Close** .

Configure:

1. In the Setup and Maintenance work area, go to the following:
 - Offering: Manufacturing and Supply Chain Materials Management
 - Functional Area: Facilities
 - Task: Manage Task Configurations for Supply Chain Management
2. On the **BPM Worklist** page, select the Task Configuration tab from where you can create or edit a rule.
3. Search for the **StandardOperationApproval** task and click the **Edit** icon.
4. Configure the approval rule.
5. Click **Save and Close** .
6. Enter comments in the text box and click **OK** .

For more information about implementing E-Signatures and generating E-Records, refer to the Implementing E-Signatures and E-Records chapter of the Oracle SCM Cloud Implementing Manufacturing and Supply Chain Materials Management guide.

Related Topics

How You Capture E-Signatures and Generate E-Records for Standard Operation Management

As a manufacturing engineer, you initiate an inline process to generate e-records and capture e-signatures, by defining a standard operation and submitting it for approval.

Note: The process to generate E-Records and capture E-Signatures isn't initiated when a standard operation is created and updated through ADF desktop integration (ADFdi). When you create or edit the standard operation, you can also be an approver. You can review the electronic records, enter comments, indicate your approval or rejection, and sign the E-Record in the E-Signature page.

Notifications are sent to other approvers who can access them through the bell notifications in the Oracle Cloud application. Approvers can review the electronic records before adding their electronic signature, enter their comments, indicate their approval or rejection and sign the electronic record by entering their password. The standard operation isn't saved until all approvals are completed based on defined rule. Depending upon the outcome of the approval, the standard operation creation or update is either saved or rolled back.

You can search and view the existing E-Records for standard operations from the Electronic Records work area.

For more information about capturing E-Signatures and generating E-Records, refer to the Oracle SCM Cloud Using E-Signatures and E-Records guide.

Audit Trail for Standard Operations

How You Enable Audit Trail for Standard Operations

To enable audit trail for standard operations, use the Manage Audit Policies task in the Setup and Maintenance work area. After audit is enabled, any changes to standard operations are recorded and time stamped as they occur. It includes creation, update, and deletion of standard operations and its child objects, using the user interface, ADFdi spreadsheet, and REST services. You can enable all or any of the standard operation and its child objects.

The hierarchy of business objects enabled for work definition audit is as follows:

<input type="checkbox"/>	▲ Standard Operations
<input type="checkbox"/>	▲ Standard Operation
<input type="checkbox"/>	Standard Operation Attachments
<input type="checkbox"/>	▲ Resource
<input type="checkbox"/>	Resource Attachments
<input type="checkbox"/>	Alternate Resource

Related Topics

- [Audit Policies](#)
- [Audit Configuration for Business Object Attributes](#)
- [Overview of Audit Configuration](#)

How You View Audit Report for Standard Operations

Audit history for standard operation is available from the Audit Reports work area. To search for standard operation changes, select Common Work Setup under Product, and Standard Operation under Business Object Type. You must enter a Date criteria. Optionally, you can filter the results by specifying a specific user or event type, like insert (create), update, or delete. You can export the search results to Excel for detailed analysis.

You can use the Description field to search for specific standard operation records. You can enter the standard operation name in the Description field, or to narrow down the results, you can use a part of the Description displayed on the search results. For example, if you specify Name:STANDARD_OPERATION_NAME/Resource:RESOURCE_CODE, it would then return specific standard operation records for the specified standard operation name with the specified resource code, and the corresponding child objects.

To retrieve audit records for the child objects, select **Include child objects**. Depending on what has been configured by your administrator, the following standard operation child objects would be retrieved:

- Standard operation attachments
- Standard operation resources, their descriptive flexfields, alternate resources, and attachments

Creation, update, and deletion of standard operation are tracked automatically down to the attributes level. To display updates to the attributes, select **Show Attribute Details**. The old value and new value are displayed for each update.

Additional contexts are available to uniquely identify a record. To display contexts, select **Show additional object identifier columns**. There are two contexts available: Organization for Context 1, and Sequence for Context 2, which is the Resource Sequence.

The description of the audit record captures the unique reference for each business object type, whether it is the standard operation header, standard operation resource, standard operation alternate resource, and so on. Specifying a part of the description in the Description search field allows you to search the change history for specific standard operation records that you are interested in.

3 Production Process Design

Overview of Production Process Design

A manufacturing engineer can use the work definitions feature in Oracle Fusion Cloud Manufacturing to design and manage production processes. In the case of discrete manufacturing, an Assembly could be a standard item or configured item that's based on an Assemble to Order (ATO) model that's completed in discrete units, at the final operation. In the case of process manufacturing, this will be a batch production where manufacturing involves moving batch quantities through each stage of the production process instead of the individual discrete units. You can design a work definition that represents the production operations, materials, outputs, and resources needed to make a product or a production batch.

In mixed-mode manufacturing, producing bulk intermediate material that's packaged into finished goods typically requires a hybrid of process and discrete manufacturing capabilities within the same plant. This is achieved through the plant setup with the help of two plant parameters; Enable Process Manufacturing and Default Work Method. If you select the Enable Process Manufacturing attribute in plant parameters, the capabilities for process manufacturing work definitions become available. If the plant is enabled for process manufacturing, you can optionally set the default work method to process manufacturing.

Oracle Application Development Framework Desktop Integrator (ADFdi) enables you to mass create and update the work definitions using Microsoft Excel spreadsheet. The work definitions are uploaded into and downloaded from the Oracle Fusion Manufacturing.

You can import process manufacturing work definitions through FBDI or using the REST services. Separate FBDI templates are available to import discrete and process manufacturing work definitions.

Based on planning and costing priorities, you can define primary and alternate manufacturing processes. The manufacturing lead times are calculated based on the primary work definition. Work definition versions are used to monitor and implement the changes that occur in the manufacturing process. The work definition report includes information on all the operations and their associated materials, outputs and resource requirements. This report can be shared internally within the enterprise or externally with the contract manufacturers, as in the case of a discrete manufacturing.

Item structure changes implemented by a product engineer in Product Management are either automatically or manually synchronized to the impacted work definitions. When an item structure change requires a manual user action, a work list notification is sent to manufacturing engineers or cost accountants having the function Receive Item Structure Change Notification for Work Definitions (WIS_RECEIVE_ITEM_STRUCTURE_CHANGE_NOTIFICATIONS_PRIV) privilege.

To summarize, you can perform the following tasks in the **Work Definition** work area:

- Manage the work definition names
- Manage the work definitions in user interface
- Assess the item structure change impact on the work definitions and make changes accordingly
- Create the work definition versions
- Calculate the manufacturing lead times
- Mass create and update work definitions using ADFdi
- Import manufacturing work definitions using FBDI templates

Note: You must set up the organization as a manufacturing plant in order to perform the tasks in the Work Definition work area. For more information about mandatory setups of plant parameters, refer to the topic Set Up a Manufacturing Plant of the Oracle SCM Cloud Implementing Manufacturing and Supply Chain Materials Management guide.

Related Topics

- [Overview of the Work Definition Work Area](#)
- [Overview of Work Definitions](#)
- [How You Process Item Structure Changes to Work Definitions](#)
- [How You Manage Work Definition Versions](#)

Overview of the Work Definition Work Area

The Work Definition Overview page is the landing page for you if you've been assigned a job role your enterprise uses for manufacturing engineer work.

On this page, you can do a quick view of a key setup matrix for a manufacturing plant, and you have quick access to the daily tasks that you need to perform.

The following panels are shown in the **Work Definition Overview** page:

- **Recently Updated Work Definition:** Shows the most recent work definitions that were last updated either automatically or manually.
- **Plant Resources:** Shows the total number of resources that are of equipment type and the total number of resources that are of labor type.
- **Work Centers by Work Area:** Shows the five work areas with the most number of work centers.
- **Work Center Resources:** Shows the five work centers with the most number of resources.
- **Tasks:** Shows the primary tasks you need to perform as a manufacturing engineer.
- **Additional Tasks:** Shows the less frequent tasks you need to perform as a manufacturing engineer.

Related Topics

- [Overview of Manufacturing Plants](#)
- [Overview of Production Process Design](#)

Work Definition Names

The work definition names are used to define the different ways of making a given product and are used in both discrete manufacturing and process manufacturing work definitions. There may be a primary manufacturing process and other alternate manufacturing processes to make a product.

In addition, work definition names Rework and Transform (internal names ORA_REWORK and ORA_TRANSFORM) are predefined and can be used to define a rework work definition and a transform work definition. In the case of Transform

or Rework work definitions, you can create a circular reference or loop between the work definition item and operation items referenced in the work definitions by specifying different work definition names.

Note: The process to create work definition names should be centralized and controlled. The work definition names can be referenced by multiple products.

The following table lists all the fields and their corresponding descriptions which helps you to choose or select values in order to create a work definition name:

Field	Description
Display Name	The name of the work definition that's shown.
Internal Name	The unique identifier of a work definition name. The value can't be edited once the name is used in a work definition.
Description	The description of the work definition name.
Type	Determines the work definition type as Standard, Rework, or Transform. The default value is Standard.
Used in Planning	If selected, you can assign a production priority for the work definition that references the work definition name. As a result, supply chain planning will plan for the materials and resources based on the work definition. You can't edit the value after the work definition name is used in a work definition.
Start Date	The date on which the work definition name becomes effective.
End Date	The date on which the work definition is no longer effective.

Note: The work definition name is used in aligning lower-level phantom work definitions in the work definition explosion process while creating the work order for the product. To explode a component that has been defined as phantom, the work definition explosion process selects the work definition of the phantom with the same name as the work definition of the finished good.

Note: You can also query work definition names using a REST API.

Related Topics

- [Overview of Work Definitions](#)
- [How You Manage Work Definitions in the User Interface](#)
- [How You Create Work Definitions](#)
- [How You Edit Work Definitions](#)

Overview of Work Definitions

You can define discrete work definitions and process work definitions in a single manufacturing plant only if Enable Process Manufacturing is selected in the plant parameter. A work definition defines the manufacturing process for a product. It is essentially a template to create a work order for the work execution.

Note: You can define both discrete and process work definitions for a given item.

A discrete work definition defines the manufacturing process for a product that consists of operations, materials, and resources. The work definition effectively combines an item structure and routing into a single view. It corresponds to a single buildable level of the item structure. If a product consists of several subassemblies that are also manufactured, then you define a work definition for the product and a work definition for the subassemblies.

A process work definition consists of operations, outputs, materials, and resources. You can define multiple outputs in addition to the primary output that's defined at the work definition header. The manufacturing process moves in batch quantity instead of discrete unit.

You can define more than one work definition for a product. A primary work definition of an item is the work definition using work definition name of type Standard with the production priority equal to 1. The primary work definition is used by the supply chain planning applications to generate the planned orders and create the standard work orders of the item. You can also define alternate work definitions to account for variations in the operations, components, and resources. When there are more than one work definitions for an item, you can rearrange their priority; however there must always be a work definition with production priority equal to 1.

If you have a prescribed way of reworking a product, you can define a rework work definition using work definition name of type Rework. If the Rework work definition item is serial-controlled, then the work definition is always serial-tracked. If you perform upgrade or downgrade to a product to produce a finished good that's of higher or lower specifications, you can define a transform work definition using work definition name of type Transform.

Note: Rework and Transform are currently supported for only discrete manufacturing.

You can define a work definition that enables the serial tracking through the manufacturing process, provided that the item's serial generation attribute is to Predefined. You identify the work definition operation from which serial-tracking must be enabled. Throughout the execution process, the serial-tracking is enforced in operation completions, material and resource transactions.

Note: Serial tracked work definitions are currently supported for only discrete manufacturing.

The table summarizes some key differences between discrete work definitions and process work definitions.

Feature	Supported in Discrete Work Definitions	Supported in Process Work Definitions
ATO Model	Yes	No
Rework, Transform	Yes	No

Feature	Supported in Discrete Work Definitions	Supported in Process Work Definitions
Work Definition Header: Item Structure Reference	Yes	Yes
Work Definition Header: Serial Tracked	Yes	No
Work Definition Operation: Serialization	Yes	No
Work Definition Operation Outputs	Not applicable	Yes ad hoc items
Work Definition Operation Items	Item structure components Ad hoc items	Item structure components and Ad hoc items
Process Item Structure Changes	Yes	Yes
ADFdi	Yes	No

A work definition consists of the following elements:

- Header
- Operations
- Operation Outputs (applicable to process work definitions)
- Operation Items
- Operation Resources

Header

The work definition header captures details such as the work method, the product being produced, the production priority, and optionally costing priority. In a discrete work definition, completion subinventory and completion locator are captured at the header level, but in a process work definition, they're captured at the operation output level.

Operations

The work definition operations define the sequence of manufacturing steps to be performed in making the item. The operations are executed in a linear path based on the operation sequence. You can also define operations that can be resequenced during work execution. A work definition must have at least one operation. An operation must be associated to a work center. You can use either standard operations, or you can manually enter the operations. If an operation isn't indicated as a count point or an automatically transact operation, then it's considered as an optional operation. You can define descriptive flexfields for an operation.

Operations Outputs

In a process work definition, the operation outputs are the products and by-products that are yielded by the process. Product is materials of value that are desired and intentionally produced, whereas By-product is materials of value that are produced as a residual of, or incidental to, the production process. Outputs are assigned as ad hoc items. You can define descriptive flexfields for an operation output.

Operation Items

The operation items define the material requirements for operations. You assign the components of the item structure of the product to the operations where they're required. You can also assign existing items that aren't components of the item structure to operations. They are considered ad hoc items. Assigning ad hoc items requires the Override Item Structure Components in Work Definition privilege. You can define descriptive flexfields for an operation item.

Operation Resources

The operation resources define the resource requirements for operations. The pool of resources available comes from the work center assigned to the operation. A resource represents either a labor or equipment that adds value to the manufacturing process. You can define descriptive flexfields for an operation resource.

Tip: If you use a referenced standard operation, you wouldn't be able to add, edit, or delete the resources, as the resources are a part of the standard operation definition. You must update the resources on the **Manage Standard Operations** page.

Related Topics

- [How You Manage Work Definitions in the User Interface](#)
- [How You Manage Work Definitions in a Spreadsheet](#)
- [How You Create an Assemble to Order \(ATO\) Model Work Definition](#)

How You Manage Work Definitions in the User Interface

You can use the Manage Work Definitions page in the Work Definition work area as a starting point to create a new work definition and manage the existing work definitions. You can have your key work definitions shown automatically by creating a saved search and setting it as a default. The Search Results region shows the work definitions matching the search criteria.

Search for a Work Definition

You can use the basic search or the advanced search to search for the existing work definitions on the **Manage Work Definitions** page. Advanced search enables you to use search operators other than equal to, and add additional search fields. You have the option of saving the search criteria and it will be shown in the **Saved Search** list.

Create a Work Definition

You can create a new work definition or copy an existing work definition.

The reasons for copying a discrete work definition can be:

- To define the same manufacturing process to make a different product
- To define the same manufacturing process for an alternate item structure that makes the same product (the product is the same, but the structure name is different)
- To define an alternative manufacturing process to make the same product (the product and structure name are the same, but the work definition name is different)

The reasons for copying a process work definition can be:

- To define the same manufacturing process to make the same primary output for a different batch quantity
- To define the same or similar manufacturing process to make a different primary output with variations in materials and other products or by-products

Edit a Work Definition

You can edit a work definition by clicking on the work definition name link in the search results table to take you to the details page of the work definition. You can update some attributes of the work definition header, operations, operation outputs (applicable to process manufacturing), operation items, and operation resources.

Note: You can query, create, and update a work definition using a REST API.

Delete a Work Definition

You can delete a work definition that you created by mistake. You can use the Manage Work Definitions page to delete either manual or automatic work definitions. It will delete all versions of the work definition name for an item. You can't delete a work definition, which is referenced by work orders or is used in published cost scenarios. Deleting a work definition removes its visibility in planning, work execution, and costing.

Note: Deleting a work definition is currently supported only by using the user interface, and not by using ADFdi, FBDI, or REST.

Deactivate a Work Definition

You can deactivate a work definition as a mechanism to make it obsolete. For example, you must deactivate a work definition if the manufacturing process it represents is no longer valid. You can deactivate a specific work definition from the Manage Work Definitions page, using file-based data import, or a REST service.

Deactivating a work definition deactivates all the versions of the work definition and it becomes inactive immediately. The end date for the last version of the work definition is left as null. The work definition status changes from Active to Inactive. The Inactive On date is populated with the system date when you deactivate the work definition, or when the import work definitions scheduled process is completed. You can't update an inactive work definition, including the work definition version end date, and inactive on date.

You can search and view an inactive work definition, and create a new work definition by copying an inactive work definition. However, inactive work definitions aren't available for use by consuming applications. You can't create a work order using an inactive work definition in Manufacturing. However, any existing work orders using an inactive work definition can continue. Planning wouldn't create planned orders using inactive work definitions. Costing wouldn't use inactive work definitions in cost rollup if the cost scenario effective date is greater than the inactive on date. In the event that a work definition that has been used in an existing unpublished cost scenario is deactivated, the status of the cost scenario will be updated to indicate to the user that cost rollup has to be re-run.

If E-Signature for the Work Definition Management transaction is enabled, you can deactivate only approved work definitions. Deactivating a work definition initiates the approval process and updates the work definition status to Pending Inactivation. After the last required approver approves, the work definition status becomes Inactive. Inactive On date is the date on which the last required approver approves.

Reactivate a Work Definition

You can reactivate a work definition to make it available again for use in work order creation, supply chain planning, and costing. You can reactivate a specific work definition from the Manage Work Definitions page. You can also reactivate inactive work definitions using file-based data import (FBDI) or a REST service, by specifying the action as UPDATE, and the work definition status as Active.

Reactivating a work definition reactivates all the versions of an inactive work definition. The work definition status is updated from Inactive to Active, and the Inactive On date is cleared. You can't update the inactive on date.

For a given item, if a work definition that's reactivated has the same production priority and/or costing priority as an active work definition, then the reactivated work definition will be automatically assigned the next highest production priority and/or costing priority. For example, initially you had work definition Production for an item. You deactivated it, and created work definition Main to replace it. As a result, both Production and Main have production priority 1. Because production priority must be unique, when you reactivate work definition Production, the system will automatically update its production priority from 1 to 2.

If E-Signature for the Work Definition Management transaction is enabled, reactivating a work definition initiates an approval process and updates the work definition status from Inactive to Pending Reactivation. Upon approval, the work definition status is updated to Active, and the Inactive On date is cleared. If it's rejected, the work definition status goes back to Inactive. If the system automatically updates the production priority and/or costing priority, the updated priority will be reflected in the electronic record.

Note: Any item structure changes occurring between the deactivation and reactivation of a work definition must be manually synchronized to the impacted work definitions instead of using the Process Item Structure Changes to Work Definitions scheduled process. The scheduled process doesn't synchronize item structure changes to inactive work definitions.

Related Topics

- [Overview of Work Definitions](#)
- [How You Manage Work Definitions in a Spreadsheet](#)
- [How You Create Work Definitions](#)
- [How You Edit Work Definitions](#)

How You Create Work Definitions

You can create a work definition using the Manage Work Definitions page in the Work Definition work area. You can create a work definition in two ways: by creating a new work definition, or by copying from an existing work definition. You can create a discrete work definition or a process work definition based on the work method you choose.

Here's how you can create a discrete work definition:

1. Enter the discrete work definition header details.
2. Create the operations.
3. Assign items to the operations.
4. Assign resources to the operations.

Here's how you can create a process work definition:

1. Enter the process work definition header details.
2. Create the operations.

3. Assign outputs to the operations.
4. Assign items to the operations.
5. Assign resources to the operations.

Enter Discrete Work Definition Header Details

On the Manage Work Definitions page, click the Add icon or from the Actions menu, select: Add. This opens the Create Work Definition dialog box. Retain the option as New work definition.

Here are a list of the work definition header related fields and their descriptions:

Field	Description
Work Method	If an organization is enabled for process manufacturing, then both Process Manufacturing and Discrete Manufacturing work methods are available. The value in the Work Method drop-down list is defaulted from what's specified in the plant parameter Default Work Method. If an organization isn't enabled for process manufacturing, then only work method Discrete Manufacturing is available.
Product section:	The product area.
Item	The product for which you're creating the work definition.
Description	The description of an item. The item description is automatically populated after you enter an item.
Structure Name	This is an optional field. If the item has a primary item structure, then that item structure is referenced. If you don't enter an item structure, then the item structure isn't shown on the Edit Work Definition Details page.
Structure Item Type	The value is automatically populated after you enter an item structure. The item structure type is Standard for a standard item and Model for an assemble-to-order model item.
Preassign Lots	You can enable preassign lots for work definition if the product is lot controlled, or lot and serial controlled. Note: The preassign lots attribute is applicable only for standard and transform work definitions, but not applicable for rework work definition.
Serial Tracked	You can create a serial tracked work definition if the item's serial generation is set up as Predefined serial number.
Completion Subinventory	The value is derived from the plant parameter and can be overridden.
Completion Locator	The value is derived from the plant parameter and can be overridden.
Minimum Transfer Quantity	The minimum transfer quantity is defined for an item to schedule overlapping and sequential operations of work orders. You can start the next operation or work order when the minimum transfer quantity is completed in the prior operation of the work order.

Field	Description
	<p>You can specify minimum transfer quantity when creating a work definition using file-based data import (FBDI), Application Development Framework desktop integration spreadsheet (ADFdi) and using a REST service.</p> <p>Note: You can't define a minimum transfer quantity for a standard operation.</p> <p>Note: The minimum transfer quantity isn't work definition version specific, it's applicable for all versions.</p>
Work Definition section	The work definition area.
Name	Select a work definition name that hasn't been used in an existing work definition for the item. A work definition name is either predefined or defined prior to creating a work definition.
Type	<p>Based on the selected work definition name, the work definition type is displayed.</p> <p>Note: If the work definition type is Transform, then you must specify the Transform-from Item. This is the item being transformed to the work definition item.</p>
Version	The value is set to 1 and can be overridden.
Start Date	The value is set to the application date and can be overridden.
Production Priority	The production priority value for the first work definition of an item, that uses a work definition name for which the Used in Planning check box is selected, is enforced as 1. The value for subsequent work definition for the same item is derived sequentially.
Costing Priority	This is an optional field. The value is used in costing planning scenario to determine which work definition to use when rolling up costs.
Costing Batch Output Size	This is an optional field. The value is the assumed batch size for the purposes of computing a standard cost. For discrete manufacturing, it's defaulted from the Standard Lot Size, if defined for the work definition item. If not, Costing considers the value of 1.
Attachments	<p>Attachments of type file, text, or URL in the work definition. The attachments are automatically carried over to the work order header.</p> <p>You can perform a mass upload of attachments for work definition headers and operations if your enterprise has implemented the needed SOAP service, the ERP Object Attachment service. For more information about this SOAP service, refer to the How You Upload Work Definition and Work Definition Operation Attachments Using a SOAP Service chapter in the Oracle Supply Chain Management Cloud Implementing Manufacturing and Supply Chain Materials Management guide.</p>

Enter Process Work Definition Header Details

On the Manage Work Definitions page, click the Add icon or from the Actions menu, select: Add. This opens the Create Work Definition dialog box. Retain the option as New work definition.

Field	Description
Work Method	If an organization is enabled for process manufacturing, then both Process Manufacturing and Discrete Manufacturing work methods are available. The value in the Work Method drop-down list is defaulted from what's specified in the plant parameter Default Work Method. If an organization isn't enabled for process manufacturing, then only work method Discrete Manufacturing is available.
Process section	The process work method area.
Name	A unique identifier of a process work definition. Name must be unique within the manufacturing plant.
Primary Output	The intended product to be produced.
Description	The description of the primary output. It's automatically populated after you enter a primary output.
Structure Name	This is an optional field. If the item has a primary item structure, then Primary is defaulted. If you don't enter a structure name, then an item structure isn't shown on the Edit Work Definition Details page.
Structure Item Type	The value is automatically populated after you enter a structure name. The structure item type is Standard for a standard item.
Preassign Lots	You can enable preassign lots in process work definition only if the primary output is lot controlled. This attribute enables preassigning of lot numbers to products and by-products.
Batch Quantity	The quantity of the production batch used for batch sizing and scaling, where all input and output quantities are defined in terms of the batch quantity.
UOM	The UOM of batch quantity. It's defaulted to the primary output item's primary UOM.
Work Definition section	The work definition area.
Name	Select a work definition name that hasn't been used in an existing work definition for the item. A work definition name is either predefined or defined prior to creating a work definition.
Type	Based on the selected work definition name, the work definition type is displayed.
Version	The value is set to 1 and can be overridden.
Start Date	The value is set to the application date and can be overridden.
Production Priority	The production priority for the first work definition of an item that uses a work definition name for which the Used in Planning check box is selected, is enforced as 1. The value for subsequent work definition for the same item is derived sequentially.

Field	Description
Costing Priority	This is an optional field. The value is used in costing planning scenario to determine which work definition to use when rolling up costs.
Costing Batch Output Size	This is an optional field. The value is the assumed batch size for the purposes of computing a standard cost. For process manufacturing, it's defaulted from Batch Quantity. If not defined, Costing considers the value as 1.
Minimum Transfer Quantity	<p>The minimum transfer quantity is defined for an item to schedule overlapping and sequential operations of work orders. You can start the next operation or work order when the minimum transfer quantity is completed in the prior operation of the work order.</p> <p>You can specify minimum transfer quantity when creating a work definition using file-based data import (FBDI), Application Development Framework desktop integration spreadsheet (ADFdi) and using a REST service.</p> <p>Note: You can't define a minimum transfer quantity for a standard operation.</p> <p>Note: The minimum transfer quantity isn't work definition version specific, it's applicable for all versions.</p>
Attachments	<p>Attachments of type file, text, or URL in the work definition. The attachments are automatically carried over to the work order header.</p> <p>You can perform a mass upload of attachments for work definition headers and operations if your enterprise has implemented the needed SOAP service, the ERP Object Attachment service. For more information about this SOAP service, refer to the How You Upload Work Definition and Work Definition Operation Attachments Using a SOAP Service chapter in the Oracle Supply Chain Management Cloud Implementing Manufacturing and Supply Chain Materials Management guide.</p>

Create Operations

After specifying the details of the work definition header, click **Next** to create the work definition operations.

There are three ways to create a work definition operation:

- *Reference a standard operation:* You can reference a standard operation by selecting the code of the standard operation and retaining the **Referenced** check box as selected. You can't edit any attributes in this case.

Note: When you reference a standard operation, you can't edit the resources assigned to the standard operation in the work definition. Referencing also ensures that any future changes to the standard operation are reflected in the work definition operation.

- *Copy a standard operation:* You can copy a standard operation by selecting the code of the standard operation and deselecting the **Referenced** check box. You can edit and update the attributes. After you remove the reference to a standard operation, you can't reference it again.

Note: When you remove the reference to a standard operation, you can add or delete the resources assigned to the standard operation in the work definition. Any future changes to the standard operation aren't reflected in the work definition operation.

- *Manually enter an operation:* You can create an operation by manually entering the name, work center, and specifying whether it's a count point or automatically transact operation. To enter a description and add attachments, expand the operation row.

The following are the operation related fields:

Field	Description
Sequence	The value is derived from the plant parameters Starting Operating Sequence and Operation Sequence Increment. The value can be overridden but must be unique.
Standard Operation Code	The code of the standard operation when you choose to reference or copy a standard operation.
Standard Operation Referenced	Indicates that the standard operation definition is referenced in the work definition operation. Any future changes to the standard operation are reflected in the work definition operation. Once you deselect the Referenced check box, you can't select it again.
Operation Type	Indicates if an operation is executed in-house or outsourced to suppliers.
Name	The name of the operation.
Description	The description of the operation.
Work Center	The work center that's associated to the operation.
Work Center Inactive Date	The inactive date of the work center that's associated to the operation.
Start Date	The start date of the operation, which is aligned to the work definition version start date.
End Date	The end date of the operation, which is null initially.
Count Point	Indicates that the operation completion needs to be explicitly reported. The last operation in a work definition has to be a count point operation. The Count Point and Automatically Transact attributes are mutually exclusive.
Automatically Transact	Indicates that the operation is automatically completed, the pull components are backflushed, and the resources are automatically charged when the next count point operation is completed. The Count Point and Automatically Transact attributes are mutually exclusive.
Serialization	Indicates that the operation is a serialization start operation. It can be selected only if the work definition item is set up as serial-tracked. Serialization is applicable to only discrete work definitions. Note: Currently supported for only discrete manufacturing.
Allow Resequencing	Indicates that the operation can be resequenced during work execution. Here are the rules to consider: <ul style="list-style-type: none"> • Only count point operations can be defined as resequenceable operations.

Field	Description
	<ul style="list-style-type: none"> Resequenceable operations can't be the first and last operations of a work definition. A resequenceable operation can't be a serialization start operation. A set of resequenceable operations must be preceded and succeeded by count point operations. In other words, an automatically transact or optional operation can't be defined next to a resequenceable operation. You can define multiple sets of resequenceable operations within a work definition, and any number of resequenceable operations within a given set. <p>Note: You can't use ADFdi to create, update, or delete resequenceable operations, or search for work definitions with resequenceable operations.</p>
Lead Time Percent	The offset of a given operation as a percentage of the manufacturing lead time considering all operations of the work definition. These lead time percent values are used as an input in the calculation of cumulative lead times.
Attachments	<p>Attachments of type file, text, or URL for the work definition operation. The attachments are automatically carried over to the work order operation.</p> <p>You can perform a mass upload of attachments for work definition headers and operations if your enterprise has implemented the needed SOAP service, the ERP Object Attachment service. For more information about this SOAP service, refer to the How You Upload Work Definition and Work Definition Operation Attachments Using a SOAP Service chapter in the Oracle Supply Chain Management Cloud Implementing Manufacturing and Supply Chain Materials Management guide.</p>
Additional Manual Material Issue	Specifies if operators can manually issue additional materials that aren't defined in the work order with push supply type, or manually issue quantities greater than those specified in the work order. The possible values are Allow and Don't allow.
Completions with Under Issues	Specifies if operators can report operation completions when materials with push supply type haven't been issued. The possible values are Allow, Allow with warning, and Don't allow.
Completions with Open Exceptions	Specifies if operators can report operation completions when there are open exceptions. The possible values are Allow, Allow with warning, and Don't allow.

Supplier Operation Details

The defining characteristics of a supplier operation is that it's always a count point operation, and it can't have resources. You can define one or more supplier operations and they can be consecutive. A supplier operation can be the last operation sequence in a work definition. Supplier operations can't be defined as resequenceable operations in a work definition.

In an assemble-to-order model work definition, a supplier operation can be defined either as a mandatory or option-dependent operation. If it's defined as a mandatory operation, then the supplier operation will always be included in the resulting configured item work definition and work order. If it's defined as an option-dependent operation, then the supplier operation will be included in the resulting configured item work definition and work order if the option associated to the operation is selected by you. This is the same behavior as an in-house operation.

The following are the supplier operation related fields:

Field	Description
Outside Processing Item	<p>An item that represents the value-added service being performed on the assembly in outside processing. The item is defined in the Product Information Management work area. For discrete manufacturing, the primary UOM of the outside processing item must be the same as the primary UOM of the work definition item. For process manufacturing, the primary UOM of the outside processing item must be the same as the unit of measure of the batch quantity.</p> <p>If the finished goods item is a dual units of measure item, which means the Tracking Unit of Measure is set to primary and secondary, then the outside processing item should be defined as a dual units of measure item as well.</p> <p>Note: For more information about setting up items for outside processing, refer to the Implementing Outside Processing chapter in the Oracle Supply Chain Management Cloud Implementing Manufacturing and Supply Chain Materials Management Guide.</p>
Item Description	The description of the outside processing item.
Supplier	The recommended supplier used in creating the requisition. The supplier is an external party who provides specialized manufacturing services to manufacture a product. The field is mandatory if the prior operation is also a supplier operation.
Supplier Site	The recommended supplier site. The field is mandatory if the prior operation is also a supplier operation.
Generate Shipment	<p>This is used to indicate if shipment needs to be created to print the shipping documents for the outside processing item. The default value is based on the outside processing item's Shippable attribute. It's unchecked if the prior operation is a supplier operation or if the supplier operation is the first operation in sequence.</p> <p>Note: If you check the Generate Shipment check box, Manufacturing sends a request to Supply Chain Orchestration, to create a shipment line to ship the goods to the supplier once the goods are reported as completed at the operation prior to the supplier operation. Supply Chain Orchestration creates a supply order line based on the request sent by manufacturing and orchestrates the automatic creation of a shipment line in Shipping.</p>
Lead Time UOM	The unit of measure for the lead time of a supplier operation.
Fixed Lead Time	The fixed lead time for the operation and is independent of the order quantity.
Variable Lead Time	The variable lead time for the operation and is dependent on the quantity.

Assign Outputs to Operations

After creating operations, click Save and Edit. The Edit Work Definition Details page opens. The operations are shown in the work definition region. If you're creating a process work definition, the Outputs vertical tab will be shown where the primary output item card is displayed. After you assign the primary output to an operation, a check mark is shown

on the primary output item card. The primary output must be assigned to an operation in order to have a valid process work definition.

You can assign multiple outputs to an operation. To assign an output to an operation, perform a search for the item in the Outputs vertical tab. An item card for the output that you search is displayed in the search results. You can assign an output to an operation either by performing drag and drop or right-click Assign action. The Assign Operation Output dialog box opens, where you can enter the output attributes, and then click the OK button.

You can't assign outputs to resequenceable operations in a work definition.

Assign Items to Operations

After creating operations, click **Save and Edit**. The Edit Work Definition Details page opens. The operations are shown in the work definition region. The item structure is shown in the Item Structure vertical tab. A count badge is shown against the components indicating their assigned quantity out of total quantity.

There are multiple ways to assign an item structure component to an operation:

- **Drag and drop:** You can drag and drop an item structure component to an operation for which the component is required. The entire quantity of the component is assigned. After a successful assignment, the component is shown in the work definition region under the operation. After assigning a component, a check mark is shown against the component in the item structure region. In discrete manufacturing, this indicates that the quantity assigned in the work definition is equal to the item structure component quantity. In process manufacturing, this indicates that the component has been assigned in the work definition, regardless whether the operation item quantity is less than, equal to, or greater than the item structure component quantity.
- **Right-click Assign action:** You can right-click an item structure component and from the Actions menu, select Assign. The Assign Operation Item dialog box opens. You can edit the operation item attributes if needed, and then click the OK button.
- **Multiselect item structure components:** You can click the Collect icon in the Item Structure vertical tab. The Not Collected icon is shown against the item structure components. The component is now collected as indicated by the count against the Collected Items icon. Select the other components that you want to assign. You can do this by either dragging and dropping the Collected Items to an operation for which they're required or by right-clicking the Collected Items and from the Actions menu, select Assign. The Assign Operation Items dialog box opens. You can edit the operation item attributes if needed and then click the OK button.

To assign an ad hoc item to an operation, click the Items vertical tab. Perform a search for the item. Then, from the search results, either drag and drop the item card to an operation or right-click the item and from the Actions menu, select Assign.

Note: The Items vertical tab isn't shown if you don't have the Override Item Structure Components in Work Definition privilege.

Assign Resources to Operations

The resource tree hierarchy is shown in the Resources vertical tab. It shows the work center and the resources available in the work center.

There are multiple ways to assign a resource to an operation:

- **Drag and drop:** You can drag and drop a resource to an operation for which it's required. The Assign Operation Resource dialog box opens. You can edit the operation resource attributes if needed and then click the

OK button. After a successful assignment, the resource is shown in the work definition region against the operation.

- Right-click Assign action: You can right-click a resource and from the Actions menu, select: Assign. The Assign Operation Resource dialog box opens. You can edit the operation resource attributes if needed and then click the OK button.
- Multiselect resources: You can click Collect in the Resources vertical tab. The Not Collected icon is shown against the resources. When you click the Not Collected icon to select a resource, the icon is activated. The resource is now collected as indicated by the count against the Collected Items icon. Select the other resources that you want to assign. Drag and drop the basket icon to an operation for which they're required. Or right-click the basket icon and from the Actions menu, select: Assign. The Assign Operation Resources dialog box opens. You can edit the operation resource attributes if needed and then click the OK button.

Copy an Existing Discrete Work Definition

On the Manage Work Definitions page, click on the Add icon or from the Actions menu, select: Add. The Create Work Definition dialog box opens. Select the Existing work definition option. The Create Work Definition dialog box opens with Existing Work Definition region and New Work Definition region. Select Discrete Manufacturing as the Work Method. Enter the Item and Work Definition Name of the existing work definition. Enter the Item, Structure Name, and Work Definition Name of the new work definition.

Rules for creating a new discrete work definition from an existing discrete work definition:

- Operations and operation resources are copied.
- If the item and structure name are the same, then the operation items are copied.
- If the item is changed in the new work definition, then the operation items aren't copied.
- If the item is the same, but the structure name is changed in the new work definition, then the operation items aren't copied.
- Based on the work definition type selected for the existing work definition, only the work definition names of the same type can be selected for the new work definition.

Copy an Existing Process Work Definition

On the Manage Work Definitions page, click on the Add icon or from the Actions menu, select: Add. The Create Work Definition dialog box opens. Select the Existing work definition option. The Create Work Definition dialog box opens with Existing Work Definition region and New Work Definition region. Select Process Manufacturing as the Work Method. Enter the Process Name of the existing work definition. Enter the Process Name, Primary Output, Batch Quantity, UOM, and Work Definition Name of the new work definition. Determine whether you want to copy operation items and operation outputs from the existing work definition to the new work definition.

Rules for creating a new process work definition from an existing process work definition:

- Operations and operation resources are copied.
- If the primary output and structure name are the same, then the operation items are copied. Copy items can't be unchecked.
- If the primary output is the same but the structure name is different, then the operation items aren't copied. Copy items can't be checked.
- If the primary output is different, whether structure name is the same or different, then the operation items aren't copied. Copy items can't be checked.

- If the primary output is the same and structure name isn't specified, then operation items are copied if Copy items is checked.
- If the primary output is different and structure name isn't specified, then operation items are copied if Copy items is checked.
- Operation outputs are copied if Copy outputs is checked.
- If the primary output of the existing work definition is the same as the primary output of the new work definition, then the primary output item and the primary output indicator are copied.
- If the primary output of the existing work definition is different from the primary output of the new work definition, then the primary output item is copied, but the primary output indicator isn't copied. You will have to assign the primary output of the new work definition explicitly.

Related Topics

- [Overview of Work Definitions](#)
- [Work Definition Names](#)
- [How You Edit Work Definitions](#)

Create a Work Definition for Discrete Manufacturing that Includes a Supplier Operation



Watch video

As a Manufacturing Engineer, you can create a work definition for discrete manufacturing that includes a supplier operation.

For more information about the supplier operation, see the Supplier Operation Details section in the How You Create Work Definitions topic.

Here's how you can create a work definition with three work definition operations, starting with an in-house operation, followed by a supplier operation, and then another in-house operation.

1. Navigate to the **Work Definition** work area.
2. On the Overview page, click the **Tasks** panel.
3. Click the **Manage Work Definitions** link.
4. On the Manage Work Definitions page, click the **Add** icon.
Now, let's add a new work definition.
5. On the Create Work Definition dialog, the work definition option defaults to the New Work Definition option.
6. Search and select the item as **AS4751100**.
7. Though optional, select the structure name as **Production** from the drop-down list.
8. Select the work definition name as **Main** from the drop-down list and click **Next**.
You have now created a work definition. Now, let's create three operations.
9. On the Create Work Definition Operations dialog, click on the **Add** icon.
10. For the first operation 10, from the standard operation code drop-down list, click **Search**.
11. In the Search and Select: Code pop up, provide the code name as **Tablet Assembly** and click **OK**.

12. On the Create Work Definition Operations dialog, click **Add** to add another row.
13. For the second operation 20, select the **Supplier Testing** standard operation code for a supplier operation. Since you selected a supplier operation, this row expands and populates more information. You can collapse the operation 20 row.
14. Click **Add** to add last row.
15. Select the **Tablet Packing** standard operation code for an in-house operation.
16. Click **Save and Edit**.
Now that you saved the work definition operations, proceed to edit the work definition.
Now, let's assign items to the work definition operations.
17. On the Edit Work Definition page, in the Item Structure vertical tab, click the **Collect** icon and multiselect the following components:
 - o **CM4751101**
 - o **CM4751103**
 - o **SB4751105**
 - o **SB4751108**
18. In the Item Structure vertical tab, click the **Collected Items** icon and drag and drop them on the first operation, **10 Tablet Assembly**.
19. Similarly, select the **CM6530007** component from the Item Structure vertical tab, right-click, then click **Actions**, and then click **Assign**.
20. On the Assign Operation Item dialog, select the operation as **30 Tablet Packing**.
Now, edit the operation item attributes, such as the supply type.
21. Select the **Push** supply type and click **OK**.
Resources associated with standard in-house operations are automatically assigned. Note that the product is completed in the last operation in a discrete manufacturing work definition. But, it is not explicitly shown as assigned to the last operation.
22. Click the **Expand All** icon to show the entire work definition.
23. Now that you have assigned the required items and resources to the standard operations, click **Save and Close**.
Now, let's review the work definition that you created.
24. In the Search region, provide the **AS4751100** item and select the **Main** work definition name, and click **Search**.
The **Main** work definition that you created with three work order operations now appears in the search results.
25. Click the work definition name link **Main** to view the work definition details.
On the Edit Work Definition page, you can review the discrete manufacturing work definition with in-house and supplier operations.

Now, you have created a work definition for discrete manufacturing that includes a supplier operation.

How You Edit Work Definitions

When a work definition is created, certain header information, operations, operation outputs, operation items, and operation resource attributes can be updated. However, you can't add or delete an operation in the current effective

work definition version. You will have to create a new version in order to add or delete an operation. The start date of a work definition is set to the application date. While creating the work definition, you can update the start date to a future date so that you can continue adding or deleting operations while designing the work definition.

The manufacturing work definition is a social object. If you enable it for use in Oracle Social Networking, the Social icon will appear on the Edit Work Definition page. For more information about Oracle Social Networking setups, refer to the Implementing Manufacturing chapter of the Oracle Supply Chain Management Cloud Implementing Manufacturing and Supply Chain Materials Management guide.

Edit Discrete Work Definition Header Details

You can update Completion Subinventory, Completion Locator, Costing Batch Output Size, and Attachments in the Edit Work Definition Details dialog box. You can also update the production priority and costing priority on Edit Priorities dialog box, which can be accessed either from the Search Results region on the Manage Work Definitions page or in the Edit Work Definition Details dialog box from the Edit Work Definition Details page.

Edit Process Work Definition Header Details

You can update Process Name, Batch Quantity, UOM, Costing Batch Output Size, and Attachments in the Edit Work Definition Details dialog box. You can also update the production priority and costing priority on Edit Priorities dialog box, which can be accessed either from the Search Results region on the Manage Work Definitions page or in the Edit Work Definition Details dialog box from the Edit Work Definition Details page.

Edit Operations

You can rename an operation and associate it to a different work center. You can rearrange the operations by updating the operation sequence. If you use a referenced standard operation whose definition no longer reflects how the operation is performed, you can deselect the Referenced check box. Now, the Count Point and Automatically Transact attributes can be edited. For example, a count point operation can now be made an automatically transact operation by deselecting the Count Point check box and selecting the Automatically Transact check box. You can edit a count point operation to select or deselect the allow resequencing attribute.

To add a new operation, click the Operations vertical tab, and drag and drop the new operation card into the work definition region. You can also right-click on the work definition region and select Assign to add a new operation. The Add Operation dialog box opens. Enter the details of the operation. You can also search for a standard operation, then drag and drop the standard operation card into the work definition region.

To copy an operation, right-click the operation card in the work definition region, and then from Actions menu, select: Duplicate. The Create Operation dialog box opens. The operation items and operation resources from the existing operation are copied to the new operation.

To delete an operation, right-click the operation card in the work definition region, and then from the Actions menu, select: Delete.

Note: You can't add or delete an operation in the current effective work definition version. You have to create a new version to add or delete an operation.

Edit Operation Outputs

Most of work definition operation output attributes can be updated, with the exception of Primary output indicator and Costing Priority of the primary output.

The following are the operation outputs related fields:

Field	Description
Operation	The operation to which the output is assigned.
Sequence	The material sequence of the operation output. The value must be unique in an operation.
Output	The item which you're producing in the production process.
Description	The description of the output.
Output Type	The possible values are Product and By-product. A product is a material that's intentionally produced in the production process and it can be a primary or a co-product. Co-products are produced in the production process due to product or process similarities. Both are defined with an output type of Product. A by-product is a material that's produced as a residual of, or incidental to, the production process. It is defined with an output type of By-product.
Primary Output	The indicator that an output is the primary product, produced in the production process. This is a Read-Only field. It's enabled only for the primary output identified on the work definition header and disabled for a co-product.
Quantity	The quantity of the output produced in an operation.
UOM	The unit of measure of the operation output quantity. It's defaulted to the item's primary unit of measure, and can be updated to a convertible UOM.
Secondary Quantity	The secondary quantity of the output produced in an operation. The field is displayed only when the item is set up as a dual unit of measure item. You can enter either the primary/transactional quantity or secondary quantity, and the application will automatically calculate the other based on the predefined UOM conversion.
Secondary UOM	The secondary unit of measure of the operation output quantity. It's defaulted to the item's secondary unit of measure and can't be updated.
Completion Type	Completion type of an output can either be automatic or manual. Automatic is when the output completion is reported automatically when a work order operation is completed. Manual is when the output completion must be manually reported by the user independent of when a work order operation is completed. Relationships between completion type and a count point, automatically transact, or optional operation: <ul style="list-style-type: none"> Count point operation can have completion type Automation or Manual Automatically transact operation can have completion type Automatic only Optional operation can have completion type Manual only
Completion Subinventory	The completion subinventory where the output is expected to be completed to.

Field	Description
Completion Locator	The completion locator where the output is expected to be completed to.
Cost Allocation	This field specifies whether the cost of an output is rolled up or manually entered. The possible values are Percentage and Fixed value. Cost allocation percentage represents the percentage of costs that will be allocated to the output up through the operation where it's being produced. Total cost allocation percentage can't exceed 100 percent for all outputs in an operation. If the cost of an output is manually entered, then select fixed value.
Costing Priority	This is an optional field. The value is used to identify a priority for cost rollup of an output when the output can be produced by multiple work definitions. For a primary output, the field is disabled, because its costing priority is the costing priority on the work definition header.
Attachments	Attachments of type file, text, or URL for the work definition operation output. The attachments are automatically carried over to the work order operation output.

Edit Operation Items

The value for several of the work definition operation item attributes is derived from the item structure. Certain attributes require the Override Item Structure Components in Work Definition privilege to update the value that's derived from the item structure.

The following are the operation item related fields:

Field	Description
Operation	The operation to which the item is assigned.
Sequence	The material sequence of the operation item. The value must be unique in an operation.
Item	The name of the item.
Item Description	The description of the item.
Find Number	<p>The find number of the component in the item structure. It uniquely identifies a specific instance of a component in a standard item structure, and therefore allows the same component to be repeated in an item structure. For example, a desktop computer is built with a left speaker and right speaker. The speaker appears twice in the item structure, with a unique find number for each instance.</p> <p>Note: Find number is always referenced from the item structure and hence, can't be updated.</p>
Basis	<p>Determines whether the quantity of the component that's used, is a fixed amount or varies linearly with the quantity produced. The value is either Fixed or Variable.</p> <p>Note: Basis is always referenced from the item structure and hence, can't be updated.</p>

Field	Description
Quantity	<p>The quantity of the operation item required in an operation. In a standard item work definition, you can split the quantity of an item structure component to multiple operations. For example, if component A123 has quantity of 10, you can assign quantity of 6 to one operation and the remaining quantity of 4 to another operation.</p> <p>The quantity can be negative if the work definition type is Rework or Transform.</p> <p>Note: You need the Override Item Structure Components in Work Definition privilege to update the total quantity of an operation item to exceed the quantity on the item structure.</p>
Inverse Quantity	<p>Inverse Quantity is equal to 1 divided by quantity. If a value for the Quantity attribute is entered, then value for the Inverse Quantity attribute is calculated automatically. If a value for the Inverse Quantity attribute is entered, then value for the Quantity attribute is calculated automatically.</p> <p>Note: Inverse quantity is typically used in situations where the component quantity per assembly is a large fractional number that's difficult to enter and maintain while it's easy to enter the inverse of the fractional number. After you enter the inverse of fractional quantity in the Inverse Quantity field, the application automatically calculates and stores the desired component quantity per assembly. Storing the exact fractional quantity per assembly prevents any undesirable material usage variances that might occur in work orders with large build quantities.</p>
UOM	<p>The unit of measure of the operation item quantity. The value is derived from the item structure.</p> <p>Note: You need the Override Item Structure Components in Work Definition privilege to update the unit of measure. The UOM drop-down list shows all the units of measure that have the standard UOM conversions and the item specific UOM conversions, including the inter-class and intra-class UOM conversions.</p>
Secondary Quantity	<p>The secondary quantity of the operation item required in an operation. The field is displayed only when the item is set up as a dual unit of measure item. You can enter either the primary/transactional quantity or secondary quantity, and the application will automatically calculate the other based on the predefined UOM conversion.</p> <p>Note: Secondary Quantity is applicable only to process work definitions.</p>
Secondary UOM	<p>The secondary unit of measure of the operation item quantity. It's defaulted to the item's secondary unit of measure and can't be updated.</p> <p>Note: Secondary UOM is applicable only to process work definitions.</p>
Item Yield	<p>The amount of good or acceptable material available after the completion of a process. A yield factor of 0.90 means that only 90% of the usage quantity of the component is acceptable to be included into the finished good. The value is derived from the item structure.</p> <p>Note: You need the Override Item Structure Components in Work Definition privilege to update the item yield.</p>

Field	Description
Supply Type	<p>Controls how the materials are consumed in the work orders. The hierarchy to default the supply type is in the following order: item structure, item master. If the supply type isn't defined in the item master, then it's set to Push. You can update the default value. A list of supply types and their uses:</p> <ul style="list-style-type: none"> • Assembly pull: The material is backflushed when the product is completed into inventory. • Operation pull: The material is backflushed when a subsequent count point operation is completed. • Push: The material is manually issued. • Phantom: The components under a phantom are exploded and added to a work order. • Bulk: Bulk materials requirement can be viewed. These materials aren't automatically backflushed or defaulted while manually issuing the materials. • Supplier: Represents the materials supplied by supplier. These materials aren't automatically backflushed or defaulted while manually issuing the materials.
Supply Subinventory	<p>The supply subinventory from which the material is supplied. The hierarchy to default the supply subinventory is in the following order: work center, item structure, item master, plant parameter. You can update the default value.</p>
Supply Locator	<p>The supply locator from which the material is supplied from. The hierarchy to default the supply locator is in the following order: work center, item structure, item master, plant parameter. You can update the default value.</p>
Include in planning	<p>The Include in planning indicator is deselected for the operation item with supply type as Supplier, based on the plant parameter, Supply Types to Include in Planning by Default for Operation Items.</p>
Start Date	<p>The start date of the component in the item structure. This field is read only and the start date is referenced from the Product Information Management work area.</p>
End Date	<p>The end date of the component in the item structure. This field is read only and the end date is referenced from the Product Information Management work area.</p>
Ad hoc item	<p>The indicator that an operation item is an ad hoc item, which means that the item doesn't come from the item structure.</p>
Attachments	<p>Attachments of type file, text, or URL for the work definition operation item. The attachments are automatically carried over to the work order operation item.</p>
Substitutes	<p>If an item structure component has substitutes defined in Product Information Management, then the substitutes are automatically pulled to the work definition. You can't add, delete, or edit substitutes in the work definition. If the primary component quantity is split across multiple operations, the substitute quantity is proportionally distributed among the operations.</p>

Tip: For more information about how changes in item structure affect the work definition operation items including substitutes, refer to the Process Item Structure Changes to Work Definitions: Explained topic in this guide.

Edit Operation Resources

You can edit operation resource attributes if the work definition operation is manually entered or created by removing the reference to a standard operation. You can only view operation resource attributes if the work definition operation is created by referencing a standard operation.

The following are the operation resource related fields:

Field	Description
Operation	The operation to which the resource is assigned.
Sequence	The resource sequence of the operation resource.
Resource	The name of the resource.
Resource Code	The code of the resource.
Units Assigned	The assigned units can't exceed the available units for the resource as defined in the resource definition.
Basis	The valid values are: Fixed and Variable. Select Fixed if the resource usage is fixed per product quantity produced. Select Variable if the resource usage varies with the product quantity produced.
Usage	The usage amount of the operation resource.
Inverse Usage	Inverse Usage is equal to 1 divided by Usage. If the Usage attribute is entered, then the Inverse Usage attribute is calculated automatically. If the Inverse Usage attribute is entered, then the Usage attribute is calculated automatically.
UOM	The usage unit of measure as defined in the resource definition.
Scheduled	The indicator that the resource is a scheduled resource. A resource can be scheduled if the Usage UOM belongs to the UOM class defined in the profile option RCS_DEFAULT_UOM_SRVCE_DURATION_CLASS.
Principal	The indicator that a resource is the principal resource within a group of simultaneous resources (resources sharing the same resource sequence number).
Charge Type	The valid values are: Automatic and Manual. Select Manual if it's an optional operation.
Job Profile	The job profile for a labor resource. Indicates a profile in HCM that's comprised of a set of qualifications that are required for a job. Applicable only to an in-house operation. When a job profile is specified for an operation resource, then only resource instances that meet the qualifications can be reported for resource transactions.
Equipment Profile	The equipment profile for an equipment resource. Indicates a profile defined in Oracle Fusion Cloud Maintenance that specifies the set of qualification requirements that an equipment must possess when performing operations in manufacturing. When

Field	Description
	it's specified for an operation resource, then only those resource instances that meet the qualifications can perform the operation.
Activity	The predefined values are: Setup, Run, and Tear Down. The lookup can be extended by adding new values.
Costing enabled	The indicator that the resource cost is charged to the work order.
Inactive On	The date on which the resource becomes inactive.
Attachments	Attachments of type file, text, or URL for the work definition operation resource. The attachments are automatically carried over to the work order operation resource.
Alternates	Alternate resources are ranked by priority. Basis, Scheduled, and Charge Type are inherited from the primary resource and can't be updated. Usage, Inverse Usage and Units Assigned are defaulted from the primary resource definition and can be updated.
Program File Name	Indicates the program file associated to the work definition operation resource from the list of program files associated to the resource in it's definition. Note: This is applicable to resources that are set up as automation equipment.
Current Version	The current version of the program file associated to to the work definition operation resource. Note: This is applicable to resources that are set up as automation equipment.
Equipment Parameters File	Indicates the comma separated value file associated to the work definition operation resource that contains the equipment control attribute values and names of inspection characteristics. Note: The inspection characteristic names in the equipment parameters file must be entered in the local language of the user that's configured in Production Monitoring for Manufacturing Cloud integration. Note: This is applicable to resources that are set up as automation equipment.

Item Revision and Date

On the Edit Work Definition Details page, the Item Revision list displays the item revisions that fall within the date range of the work definition version being viewed or edited. If an item structure isn't referenced, the Date list shows either the version start date or the item revision effective date. If an item structure is referenced, the Date list shows the distinct component effective start dates that correspond to the item revision selected in the Item Revision list. In an ATO model work definition, the Date list includes the distinct component effective start dates of the lower level components also. If the date was introduced through an Engineering Change Order, the Change Order Number, and the Change Order Line Number will be appended to the Date.

Selecting an item revision in the Item Revision drop-down list and a date in the Date drop-down list does the following:

- Updates the item structure view and shows the effective components as of that date.
- Updates the work definition region and shows the effective work definition as of that date.

Consider the following example:

The following table lists the fields and their respective values for Item A123 Revision A dated 1/1/16.

Component	Quantity	Start Date	End Date	Change Order Number	Change Order Line Number
C123	1	1/1/16	Blank	Blank	Blank
C124	3	1/1/16	Blank	Blank	Blank
C125	6	1/1/16	Blank	Blank	Blank
C126	1	3/1/16	Blank	Blank	Blank

The following table lists the fields and their respective values for Item A123 Revision B dated 6/1/16.

Component	Quantity	Start Date	End Date	Change Order Number	Change Order Line Number
C123	1	1/1/16	Blank	Blank	Blank
C124	4	1/1/16	Blank	Blank	Blank
C125	8	1/1/16	Blank	Blank	Blank
C126	1	3/1/16	Blank	Blank	Blank
C127	2	6/1/16	Blank	MFG-1040	10
C128	2	8/1/16	Blank	Blank	Blank

The following table shows the work definition Version 1 of the item A123. The start date of the version is 1/15/16. The end date of the version is 5/31/16.

Field	Value
Item Revision	Revision A

Field	Value
Date	<ul style="list-style-type: none"> • 1/15/16 • 3/1/16

The following table shows the details of work definition Version 2 of the item A123. The start date of the version is 6/1/16. The end date of the version isn't specified.

Field	Value
Item Revision	Revision B
Date	<ul style="list-style-type: none"> • 6/1/16 MFG-1040.10 • 8/1/16

Note: If the work definition version start date is later than the item revision date, then the work definition version start date is shown in the Date drop-down list.

Search Within a Work Definition

On the Edit Work Definition Details page, expand the Search: Work Definition region to access the search functionality within a work definition. The Contains search is conducted across the operations, operation outputs (applicable for only process work definitions), operation items, and operation resources based on the keywords, such as item name, output name, item description, output description, and supply type. The search result cards for the matching entities are displayed in the search results pane and they're also highlighted in the work definition region. You can then drag and drop the same type of objects to the Collected Items icon for updating. You can also right-click the search result card to perform an action, such as edit.

Related Topics

- [Overview of Work Definitions](#)
- [How You Create Work Definitions](#)
- [How You Manage Work Definition Versions](#)

How You Create an Assemble to Order (ATO) Model Work Definition

Oracle Fusion Cloud Manufacturing supports configured item fulfillment flow for a make-to-order configured product. The customer order is created with the Assemble to Order (ATO) model as the ordered item. When an ATO model is ordered, the customer has the ability to configure the model and select the options. The selected options result in a configuration and for each unique configuration, the application creates a configured item. Then, the work order to fulfill the customer order is created against the configured item.

Note: Assemble to Order work definitions are currently supported for only discrete manufacturing.

To create a work order for a configured item, a primary work definition for the ATO model must be defined first. There are a few traits about an ATO model work definition that are different from a standard item work definition. The specifics are highlighted and discussed here in more detail.

ATO Model Work Definition Operations

In an ATO model work definition, the Create Operation, Assign Operation, and Edit Operation dialog boxes display the Option Dependent Details region.

The following table lists all the fields and their corresponding descriptions which helps you to choose or select values in order to create an ATO model work definition:

Field	Description
Option dependent	<p>Indicates that an operation is an option dependent operation. An option dependent operation is included in the configured item work order in case of either of the following:</p> <ul style="list-style-type: none"> The optional components that are assigned to the operation are selected in the configuration. The criteria, as defined in the applicability rule, are met. <p>If the option dependent check box isn't selected, then the operation is considered a mandatory operation. A mandatory operation is always included in the configured item work order.</p>
Applicability Rule	<p>Defines the criteria to include an option dependent operation in the configured item work order. There can be only one applicability rule for an option dependent operation.</p>
Planning Percentage	<p>The percentage of the nominal resource usage that's applied when planning the resource capacity requirements to satisfy a demand forecast of the parent model item.</p>

ATO Model Work Definition Operation Items

You can create an ATO model work definition only for the ATO model item structure with the structure name as Primary. The item structure visualization displays the multilevel ATO model item structure. You can expand option classes to view the options. You can also expand standard item phantoms to view the components that make up the phantoms. However, you can't expand child ATO models.

Note: The supply type of option classes and standard item phantoms must be set to Phantom at the item structure component level. This setup is required to expand option classes and standard item phantoms to see options and lower level components respectively, when viewing the item structure in the work definition.

The count badge that you see against an item structure component card indicates the number of components for a single parent node. The count badge, shown only for a leaf node, indicates the assigned quantity over the component total quantity. The count badge turns into a check mark after the component is assigned to an operation. If you hover over the check mark icon, you can view the operation sequence to which the component is assigned to.

You can assign any component from any level to an operation. The rules governing this feature:

- If the parent is assigned, the children can't be assigned.
- If the children are assigned, assigning the parent automatically deletes the children's assignments.

This means for an option class, you can choose whether to assign the option class or the options. Similarly for a standard item phantom, you can choose whether to assign the parent phantom or the components. Assigning an option class to an option-dependent operation means that the operation is included in the configured item work order if any of the options of the specific option class is selected.

Note: There are no enforcements between the type of operations, that's, mandatory or option dependent, and the type of the component that can be assigned, that's, mandatory or optional. If you assign an optional component to a mandatory operation, then the operation is always included in the configured item work order. But the optional component isn't included if it's not selected in the configuration.

There are two operation item attributes that are specific to ATO model work definitions. These attributes are referenced from Oracle Product Hub and hence, can't be updated. The operation item attributes specific to ATO model work definitions are:

- **Planning Percentage:** The percentage that's used by Planning in forecast explosions. A planning percent can be greater than 100 to plan for a component in excess.
- **Optional:** Indicator that a component is an optional component. If the Optional check box isn't selected, then the component is considered as a mandatory component.

Note: In an ATO model work definition, you must assign the entire component quantity to an operation. You can't update the quantity, inverse quantity, unit of measure, and yield. You also can't assign ad hoc items, which are existing items that aren't components of the ATO model item structure.

Tip: The item structure visualization displays a multilevel ATO model item structure with a maximum of 10,000 components. If you have a large ATO model item structure that exceeds 10,000 components, and the **operation item assignments are done at the first level components** of the ATO model, then it's recommended that you model the first level option classes as child ATO models. Else, you can also create a child ATO model, and make the child ATO model as the parent of the first level option class. You must set the supply type of the child ATO model to phantom. A child ATO model isn't exploded in the work definition user interface.

For more information, refer to the How You Process Item Structure Changes to Work Definitions topic in this chapter.

Applicability Rule

An applicability rule can be assigned to an option dependent operation. The rule defines the criteria to include the operation in the configured item work order. The operation is included in the work order only if the criteria are met. You can define an applicability rule using optional components, option classes, transactional item attributes (TIA), or any of the combinations.

Consider an example, in which, there are two types of performance tests as a part of building tablets. Depending on the selected CPU option, one of the performance test operation is executed. You can model this by doing the following:

- Create two option dependent operations for the two types of performance tests.

- Assign an applicability rule defining the criteria to select the performance test based on which CPU option is selected.

If you want to use the TIAs in the applicability rule to determine when to include the option dependent operations, then while defining the TIAs, the TIAs must be assigned to application scope Configuration Matching. The TIAs are used in the configuration matching process to determine if a configuration already exists. The TIAs are also leveraged by Manufacturing to determine the operations that are to be executed to build a configured item.

Transactional item attributes are defined in Product Hub. Because TIA is associated with an item class, all items that belong to the item class will inherit the TIA. Based on the item class setup, you can define TIA for the top-level ATO model, optional components, or child ATO models. You can define an applicability rule using transactional item attributes with either numeric or string data type, as long as the associated value sets have a validation type of either independent or subset.

Note: Assign either the optional components or an applicability rule to an option-dependent operation. If you assign both, then the applicability rule isn't evaluated.

Create an Applicability Rule

To create an applicability rule, you must select the Option dependent check box in the Option Dependent Details region. This enables the Add icon. Click the Add icon to open the Add Applicability Rule dialog box. Unlike the Edit Work Definition Details page, the item structure visualization in the Add Applicability Rule dialog box shows the multilevel item structure of an ATO model. However, only the optional components are displayed. The current and future effective components and TIAs are shown based on the date selected in the Date list on the Edit Work Definition Details page. From the first-level components, you can expand the option classes to view the lower-level optional components. You can't expand a child ATO model. If you have defined the transactional item attributes, then they appear as the child nodes of a component. And expanding the transactional item attribute node shows the attribute values.

In the item structure, once you locate the item or TIA value that you need for defining the rule, you can do either of the following:

- Drag and drop the item or TIA card to the Rule Text region.
- Right-click the item or TIA card, from Actions menu, select: Insert into Rule Text.

After you drag and drop or insert the rule text, the Rule Text region shows the component hierarchy of the item or transactional item attribute. A component hierarchy is the relative path of the item node to the top-level ATO model node.

The following example shows the item structure and component hierarchy of ATO MODEL 1:

- OPTION CLASS 1: ATO MODEL 1.OPTION CLASS 1
 - OPTION 11: ATO MODEL 1.OPTION CLASS 1.OPTION 11
 - OPTION 12: ATO MODEL 1.OPTION CLASS 1.OPTION 12
- OPTION CLASS 2: ATO MODEL 1.OPTION CLASS 2
 - OPTION 21: ATO MODEL 1.OPTION CLASS 2.OPTION 21
 - OPTION 22: ATO MODEL 1.OPTION CLASS 2.OPTION 22

The Rule Text region has various operators that can be used to define an applicability rule. You can have a combination of items and TIAs in a rule, and build a complex expression using AND and OR conditions. Click the Validate button to

validate the rule you're defining. If the rule fails to meet the valid syntax, an appropriate error message is shown. You have to correct the error before you can save the rule.

For numeric attributes, the valid operators are:

- Equal to
- Not equal to
- Less than
- Less than or equal to
- Greater Than
- Greater than or equal to

For string attributes, the valid operators are:

- Equal to
- Not equal to
- STARTSWITH
- ENDSWITH
- CONTAINS
- DOESNOTCONTAIN

Valid rule syntax:

- Keyword ITEM is used to specify an item, that's, ITEM is equal to 'ATO MODEL 1'.OPTION CLASS 1'
- Keyword TRANSACTIONALATTRIBUTE is used to specify a transactional item attribute, that's, 'ATO MODEL 1'.OPTION CLASS 1'.OPTION 11'. TRANSACTIONALATTRIBUTE ["Finish"] is equal to "Matte"
- Item numbers are wrapped within single quotes
- Transactional item attribute name and value are wrapped within double quotes
- Dot is used as a separator in the component hierarchy
- Operators are in upper case and aren't translatable

The Add Applicability Rule dialog box shows the display name of a transactional item attribute, which is translatable. If the value set used by a TIA is translatable, then the item structure visualization shows the internal name of the value and the translated value next to it in parenthesis. The applicability rule is evaluated against the value of the internal name and not the translated value.

Note: Using drag and drop or selecting Insert into Rule Text from the Actions menu ensures that the rule syntax is valid. However, you can also create or edit a rule in the Rule Text region by entering the syntax manually.

Export Operation Item Assignments

The **Export Operation Item Assignments** action is available in the Actions menu in the Edit Work Definition page. It enables you to export the complete multilevel ATO model item structure to Excel in an indented view. The Excel captures the following information:

- Displays the operations to which components are assigned.
- Indicates if there is pending work in the Assignment Status column.

- Lists other relevant item and item structure attributes such as User Item Type, Item Revision, and Structure Item Type.

Assignment status can be Complete, Incomplete, Explicit, or Implicit. An Explicit assignment status shows to which operation a component is directly assigned to. An Implicit assignment status applies to the children when their parent is directly assigned to an operation. Incomplete and Complete assignment status is derived by the application. In a parent-child scenario, if you have assigned all the children, then the assignment status for the parent is Complete, but if you haven't assigned all the children, then the assignment status for the parent is Incomplete.

You can quickly find out whether or not there is pending work by looking at the assignment status of the top level ATO model. If it's Incomplete, then it means you still have pending work in terms of operation item assignments. If it's Complete, then it means you have fully completed operation item assignments.

Related Topics

- [Overview of Production Process Design](#)
- [Overview of Work Definitions](#)
- [Define Common SCM Configuration: Define Advanced Item](#)

How You Create a Configured Item Work Definition

Configure to Order (CTO) is the process of ordering and fulfilling configured products. The configured products, also referred as configured items, are either procured or made to order. The configured item work definition defines the manufacturing process to build the configured item.

Note: Configured item work definitions are currently supported for only discrete manufacturing.

Process to Create a Configured Item Work Definition

When Oracle Manufacturing receives a request to create a work order for the configured item:

- First, it creates the configured item work definition.
- Then, based on the configured item work definition, it creates the configured item work order

A configured item work definition is created dynamically using the primary ATO model work definition, selected options, and transactional item attributes. Unlike the ATO model work definition, the configured item work definition isn't saved in the database. Also, you can't create a work definition for a configured item manually or search for it in the user interface.

The following figure illustrates the steps to create a configured item work definition dynamically. First, the application retrieves the configuration details that include the selected options, TIA, and mandatory components. Then, the application creates the configured item work definition header based on the base ATO model work definition header. It includes all the mandatory operations, mandatory components, and related resources. Based on the options and transactional item attributes that are selected during the configuration process, it includes the corresponding option-dependent operations along with the optional components and related resources. The application also explodes standard items with supply type as phantom for the ATO model and includes the components that make up the phantom according to the item structure. A configured item work order is then created based on the configured item work definition. The parameter Phantom Operation Inheritance is applicable for standard item work order creation and not for configured item work order creation.

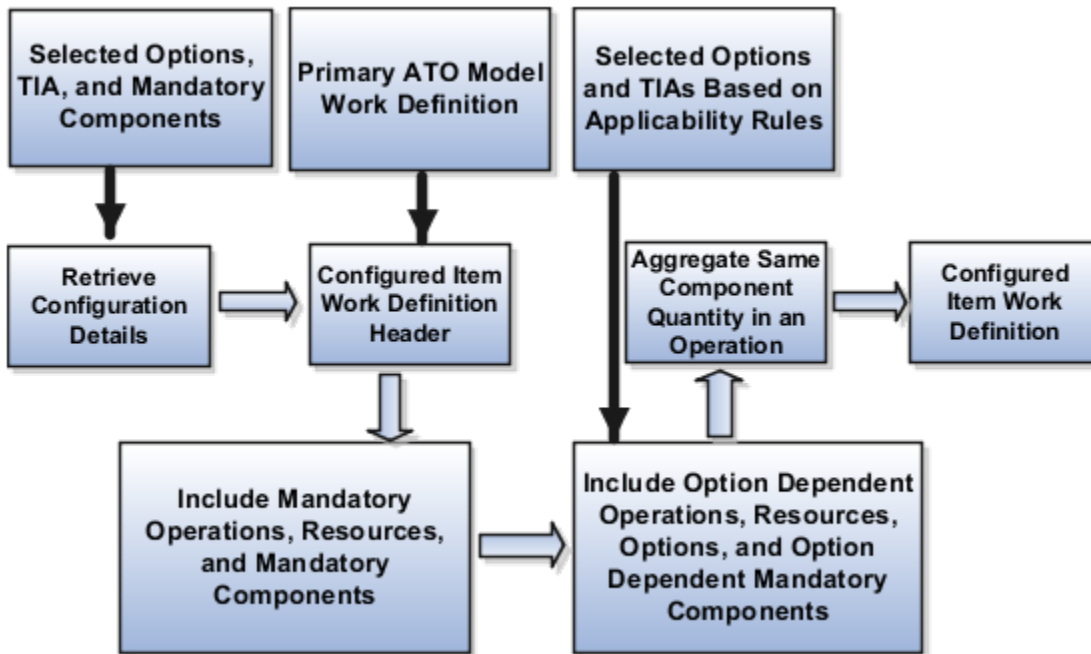

Example to Create a Configured Item Work Definition

The following example illustrates how a configured item work definition is created.

The following shows how a configured item is created from the item structure:

- ATO MODEL 1
 - OPTION CLASS 1
 - OPTION 11: (selected option: Y)
 - OPTION 12
 - MANDATORY COMP 13
 - OPTION CLASS 2
 - OPTION 21: (selected option: Y)
 - OPTION 22
 - MANDATORY COMP 23 (Phantom)
- MANDATORY COMP 23
 - COMP 231
 - COMP 232

The following table illustrates the various attributes of the work definition for ATO Model 1:

Operation Sequence	Operation Name	Option Dependent	Operation Item	Applicability Rule
10	Assembly	N	MANDATORY COMP 3 OPTION CLASS 1	Blank
20	Hand insertion	Y	OPTION CLASS 2	Blank
30	Performance Test A	Y	Blank	If OPTION 21 is selected
40	Performance Test B	Y	Blank	If OPTION 22 is selected
50	Pack	N	MANDATORY COMP 4	Blank

The following table illustrates the various attributes of the work definition for configured item ATO Model 1:1:

Operation Sequence	Operation Name	Operation Item
10	Assembly	MANDATORY COMP3 OPTION 11
20	Hand insertion	OPTION 21 COMP 231 COMP 232
30	Performance Test A	Blank
50	Pack	MANDATORY COMP 4

- Note:** The component quantity is calculated in the configured item work definition based on the following points:
- The quantity recorded on the sales order is the quantity that's used for selected options and child ATO models.
 - The quantity defined in Oracle Fusion Product Model is the quantity that's used for mandatory component.

Work Definitions for Contract Manufacturing

Contract manufacturing is a business process in which an organization, known as the original equipment manufacturer (OEM), outsources manufacturing to another organization, known as the contract manufacturer to manufacture a specific part or a full product. The contract manufacturer manufactures the product to exact specifications of the original equipment manufacturer's label. The original equipment manufacturer may supply some or all components to the contract manufacturer. Contract manufacturing allows the original equipment manufacturer to completely

outsource their manufacturing process to the contract manufacturer. You can't add operations that can be resequenced to a work definition in contract manufacturing organization.

Note: Work definitions for contract manufacturing are currently supported for only discrete manufacturing. You can enable preassign lots / serial tracked indicators for the work definition in the contract manufacturing organization. This is applicable only if the work definition product is lot / serial controlled.

The contract manufacturing business flow in Oracle Manufacturing involves two types of items:

- Contract Manufacturing Finished Good: Refers to the item that's in demand. It is the ordered item on the customer sales order. The work definition and work order in manufacturing is created for this item.
- Contract Manufacturing Service Component: Refers to the item with which the supply is fulfilled. It is the item on the purchase order. This item is issued to the manufacturing work order as a component.

In contract manufacturing scenarios, the work definition is the source document, business object that's used internally by the Oracle Fusion Supply Chain Orchestration to create the work order and communicate with the contract manufacturer. The following figure is a quick overview of the manufacturing related business processes that are involved:

The following figure explains how the various applications are involved in completion of the contract manufacturing business flow. This diagram partially depicts the flow, starting with creation of a sales order in Order Promising and ending in creation of a purchase order in Purchasing.

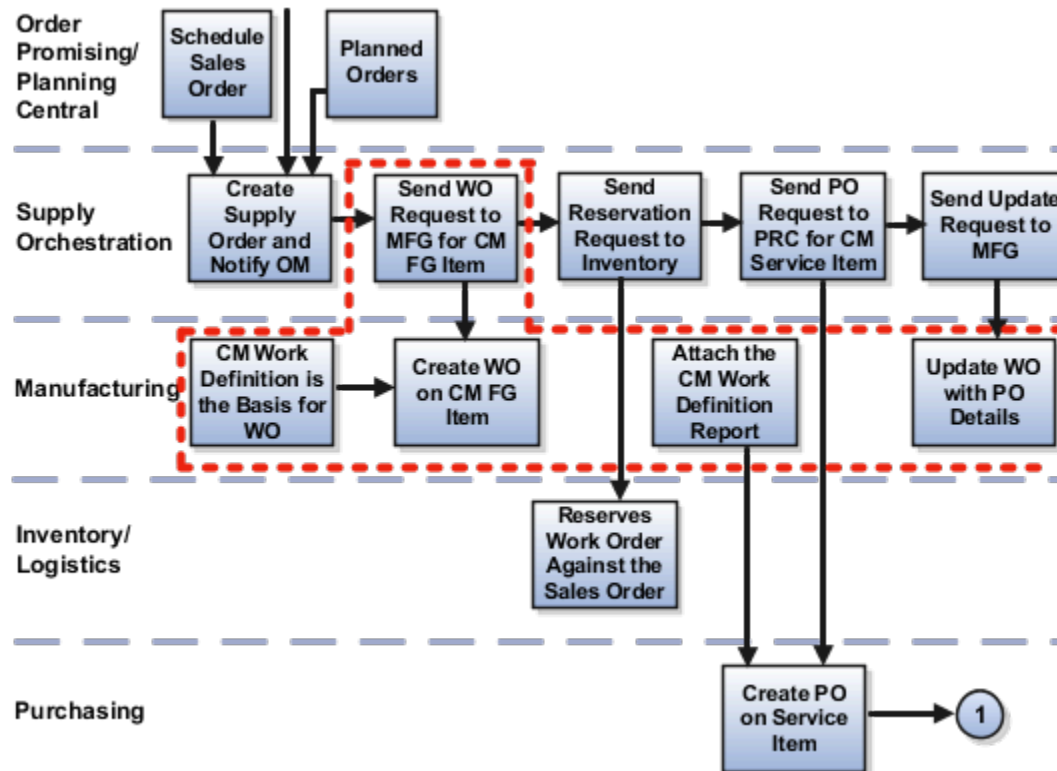

The following figure is a continuation of the previous diagram and explains the contract manufacturing business flow after a purchase order has been created in Purchasing. The flow ends with the work order completion notification sent to supply orchestration and then notifying supply availability for the service item.

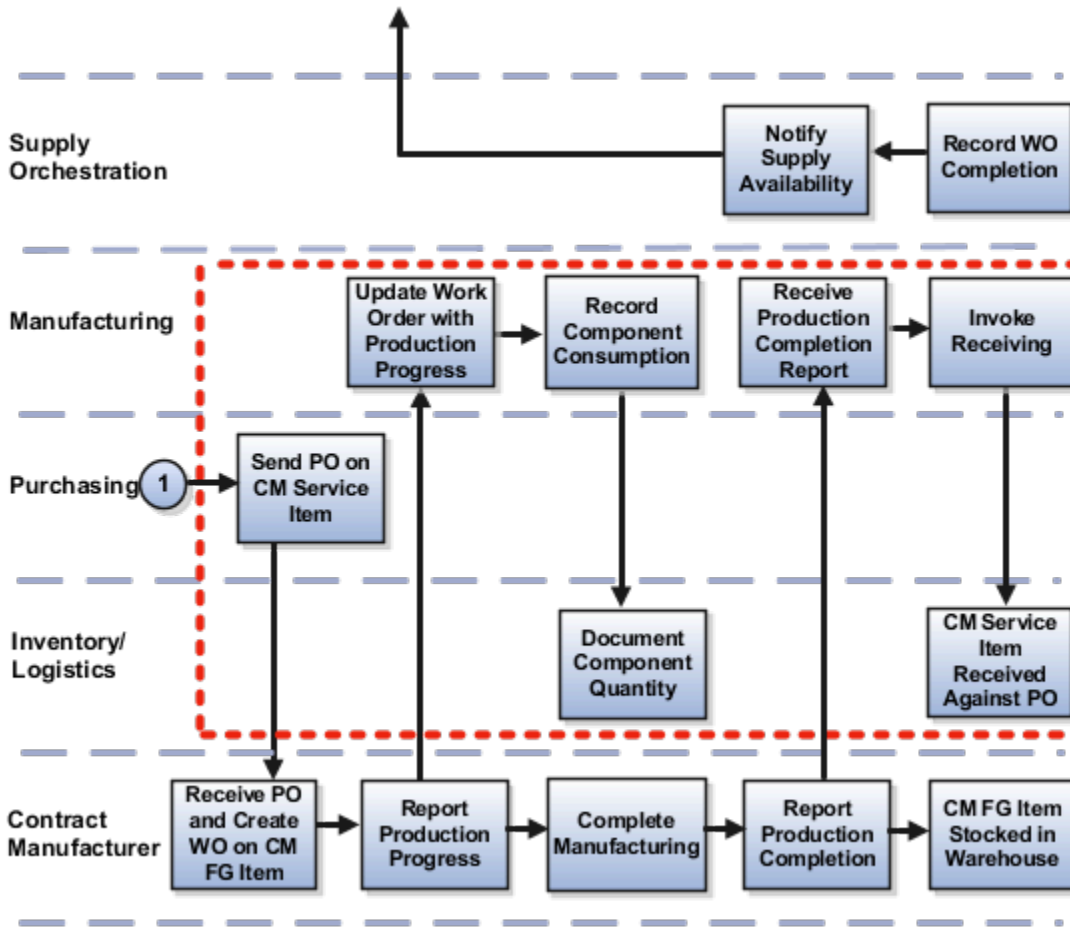

The following table summarizes key setup aspects in a contract manufacturing flow:

Setup	Considerations
Define the Contract Manufacturer	<p>Do the following:</p> <ul style="list-style-type: none"> Set up a supplier and supplier site for the supplier who represents the contract manufacturer. Setup a manufacturing plant that represents the facility of contract manufacturer. <p>In the Plant Parameters page, ensure you have set the plant as a contract manufacturer with the supplier and supplier site as defined.</p>
Grant access to the manufacturing plant modeled as the contract manufacturer	Same as that for an in-house manufacturing plant.
Define the contract manufacturing service item	<p>Use the Contract Manufacturing Service Component item template provided in Oracle Fusion Product Information Management.</p> <p>If the contract manufacturing finished goods item is a dual units of measure item, which means the Tracking Unit of Measure is set to primary and secondary, then the contract manufacturing service item should be defined as a dual units of measure item as well.</p>

Setup	Considerations
	For more information about setting up items for outside processing, refer to the Implementing Contract Manufacturing chapter in the Oracle Supply Chain Management Cloud Implementing Manufacturing and Supply Chain Materials Management Guide.
Define the contract manufacturing finished goods item and complete the item structure in Oracle Fusion Product Information Management	Use the Contract Manufacturing Finished Goods item template provided in Oracle Fusion Product Information Management. The finished product for the contract manufacturing should be a standard product and not a configured product.
Complete the definition of the contract manufactured item by defining the item structure	Ensure that the service item is included as a component in the item structure or bill of materials. Also, ensure that the supply type of the component items is correct. For example, Supplier for the supplier provided components and Push for the OEM provided components.
Attachment categories and the related item setup in Oracle Fusion Product Information Management	Optional and is to ensure that the attachment of the work definition document is possible if used at the item definition level against the service item. In most of the scenarios, the work definition report is attached to the Blanket Purchase Agreement in Oracle Fusion Purchasing.

In order for Supply Chain Orchestration to create a work order for a Contract Manufacturing Finished Good item, a primary work definition must be defined first. The contract manufacturing work definition has a few different business rules compared to a standard item work definition. The specifics are highlighted and discussed here in more detail.

In the context of a contract manufacturing work definition operation, the following simple business rules are reinforced:

- The contract manufacturing service item must have a supply type of **Assembly Pull**. It is also recommended that there is only one service component on the work definition and consumed as such on the last count point operation of the work definition.
- All other operation items on the work definition can use the following supply types only: Phantom, Assembly Pull, or Operation Pull for Original Equipment Manufacturer provided items and Supplier for Supplier provided items.
- Contract manufacturing isn't applicable for supplier operations.
- Job profile and an equipment profile won't be enforced for contract manufacturing work orders.

Note: It is important that the work definition is printed as a report after the production definition is complete. This report can then be made available in the business process flow, so that it's sent as an attachment to the contract manufacturer.

Related Topics

- [Overview of Production Process Design](#)
- [Overview of Work Definitions](#)
- [Implementing Contract Manufacturing](#)

How You Process Item Structure Changes to Work Definitions

While Oracle Manufacturing maintains the manufacturing process, that's the work definition, for a product; an item structure, which is maintained in the Product Information Management work area, defines the product bills of materials.

It's recommended that a business keeps these two structures aligned.

Based on the successful completion of the Process Item Structure Changes to Work Definitions scheduled process, the manufacturing engineer gets notified through a worklist notification of any item structure changes implemented in Product Information Management that require a manual user action. To reflect these changes in work definition, the enterprises typically implement one of the following:

- Edit an existing work definition version to reflect these item structure changes. The exact version to update mostly depends on the time from which these changes become effective.
- Create a new effective work definition version to implement the item structure changes. A few such scenarios would involve adding new operations for a change order implemented in Product Information Management OR for component changes that introduce a meaningful change to the production process.

The Notification Detail page provides a summary and detailed view of the item structure changes. If the component changes in the item structure were initiated due to implementation of an Engineering Change Order in Product Information Management, an attribute with the label Change Order is displayed on the page which shows the change order number and the change order line number. You can click the **Impacted work definitions** link to navigate to the **Manage Work Definitions** page, the search results of which show the pre-queried work definitions that were impacted by these changes. For item structure changes that aren't completed through an Engineering Change Order, the notification consolidates all the component changes for a given item that have occurred at the time, the Process Item Structure Changes to Work Definitions scheduled process was executed.

A worklist notification is generated when all the following conditions are met:

- At least one change to the item structure components that require a manual user action.
- Product Information Management publishes the business events generated for item structure component changes.
- The Process Item Structure Changes to work definitions delivered by Manufacturing picks up the business events published by Product Information Management and the scheduled process completes successfully.
- There's at least one work definition in manufacturing referencing the item structure for which the component changes were completed in Product Information Management.

Note: If you're a manufacturing engineer but prefer not to receive the notifications, your user account must exclude the function **Receive Item Structure Change Notification for Work Definitions** (WIS_RECEIVE_ITEM_STRUCTURE_CHANGE_NOTIFICATIONS_PRIV) privilege. The recommended action is for your security administrator to create a configured job role without this privilege and assign it to users with such a need.

Item Structure Component Replacements Automation

You can perform a component replacement in an item structure using the Replace action in Product Hub or Product Development. This marks the original component as disabled, and the replacement component as added. In Manufacturing, using the Process Item Structure Changes to Work Definitions scheduled process, you can automate

the component replacement to the corresponding manufacturing work definitions. The replacement component is automatically assigned to the same operation as the original component in the existing versions of the impacted work definitions without sending a notification. Through the automation, the replacement component attributes in the item structure including basis type, quantity, inverse quantity, UOM, supply type, and yield in addition to substitute components are inherited to the corresponding work definition operation item. In the work definition, the automation also copies the operation item attributes for supply subinventory, supply locator, and ad hoc from the original component and increments the material sequence for the replacement component.

In the following cases, a workflow notification is sent for your review and action instead of automating the component replacement in work definitions:

- The original component isn't assigned to any work definition operation.
- The original component has been assigned to more than one work definition operation.
- The replacement component has been assigned as an ad hoc item to the same operation as the original component.
- The manufacturing plant is enabled for ERES (Electronic Records and Electronic Signatures). As per the ERES functionality, you must create a new work definition version, manually assign the replacement component, and submit the new work definition version for approval.

The following table summarizes the item structure component changes that are automated and those that aren't automated, and hence require a manual user action.

Item Structure Changes	Standard Item	ATO Model (applicable for only discrete manufacturing)
Quantity/Inverse Quantity	Automated if the whole quantity is assigned to one operation. Not automated if the quantity is assigned to multiple operations. Not automated if ERES is enabled.	Automated. The whole quantity must be assigned to one operation.
UOM	Automated if it wasn't overridden in the work definition. Not automated if overridden.	Automated
Yield	Automated if it wasn't overridden in the work definition. Not automated if overridden.	Automated
Basis	Automated	Automated
Optional	Not Applicable	Automated
Planning Percent	Not Applicable	Automated
Supply Type	Not Automated	Not Automated
Add a Component	Not Automated	Not Automated
Replace a Component	Automated. Not automated if ERES is enabled.	Automated Not automated if ERES is enabled.

Item Structure Changes	Standard Item	ATO Model (applicable for only discrete manufacturing)
Disable or End Date a Component	No user action is required. You don't need to delete the operation item.	No user action is required. You don't need to delete the operation item.
Substitutes	Automated	Automated

Related Topics

- [Overview of Production Process Design](#)
- [Synchronize Item Structure Changes to Work Definitions](#)

Synchronize Item Structure Changes to Work Definitions

This example demonstrates how to review the worklist notification and make changes to the production process for a standard product.

In this scenario, the manufacturing plant in Atlanta for Computer Service and Rentals has an effective work definition as of Aug 01 2015 to manufacture the standard item Vision Tablet. For compliance reasons, a change order ECO-2015-Tabs-204 is initiated for the Vision Tablet to add a new component SD20011, which is effective from Oct 30 2015. The change order is already Scheduled to be implemented. Another item structure change effective immediately, on Sept 01 2015, is the update to the component quantity for CM86324, from 1 to 4.

The following table lists components and their attributes for which a change order has been initiated. The table also lists the original values for each component and attribute and the corresponding updated values after the change order is approved.

Component	Attribute	Original Value	Updated Value
CM86324	Check ATP	No	Yes
CM86324	Basis	Variable	Fixed
CR40002	Required to Ship	No	Yes

The following table summarizes key considerations in this scenario:

Consideration	In this Example
You have been granted access to the manufacturing plant that's in context.	Yes

Consideration	In this Example
You have been granted the function privilege Receive Item Structure Change Notification for Work Definitions so as to receive the manufacturing worklist notifications.	Yes
You have successfully completed the item structure change in the Product Information Management work area.	Yes
A work definition for the item structure already exists in the manufacturing plant that's in context.	Yes
The scheduled program Process Item Structure Changes to Work Definitions has been successfully completed for the manufacturing plant that's in context.	Yes
After reviewing the item structure changes in the worklist notification, you decided to make the corresponding changes to the manufacturing work definitions.	Yes

As a response to the implemented item structure changes, the manufacturing engineer must perform the following tasks:

- Review the worklist notification to identify the impacted work definitions.
- Make the changes in the work definitions, either by creating a new work definition version or editing an existing work definition version.

Review the Worklist Notification

Let us suppose that the scheduled program Process Item Structure Changes to Work Definitions, which ran successfully on Sept 02 2015, finds both the eligible changes to process. That is, the changes through change order number ECO-2015- Tabs-204, and the changes completed on Sept 01 2015.

1. Changes completed through the Change Order, ECO-2015-Tabs-204.10: The change order detail, ECO-2015-Tabs-204.10 is displayed in the notification header whereas the details section captures the newly added component SD20011 that requires a manual user action for the work definition.
2. Changes completed with immediate effect on Sept 01 2015: CM86324 is not captured in the Notification. Since the component was assigned to a single work definition operation, the scheduled program Process Item Structure Changes to Work Definitions, automatically synchronizes the quantity changes.

Make Changes to the Work Definition

The manufacturing engineer decides to create a new work definition version to implement the change order ECO-2015-Tabs-204 for the Vision Tablet. The user models this change by creating a new operation and assigning the component SD20011 to it along with an operation resource, as needed.

The manufacturing engineer performs the following steps to make the necessary changes to the work definitions:

1. On the **Notification Detail** page, the manufacturing engineer clicks the **Impacted Work Definitions** link. The **Manage Work Definitions** page opens in a new browser session.
2. The manufacturing engineer clicks the prequeried work definition version for editing.

The following table lists certain attributes for different operation items and their corresponding values assigned by the change order:

Operation	Operation Item	Attribute	Assigned Value
10 (Assemble)	CM86324	Check ATP	Not Applicable
10 (Assemble)	CM86324	Basis	Fixed
10 (Assemble)	CR40002	Required to Ship	Not Applicable
Not Applicable	SD20011	Not Applicable	Not Assigned

3. There is no user action required for any of the attribute changes to the currently assigned components. Updates to the **Basis** and **Quantity** attributes for CM86324 are synchronized automatically whereas the changes to **Check ATP** and **Required to Ship** attributes are also reflected automatically, since these are not tracked in the Manufacturing Work Definition.
4. For the newly added component SD20011, the manufacturing engineer creates a new work definition version 1.1, with an effective start date of Oct 30 2015, to add a new operation, Operation 25. The manufacturing engineer then assigns the operation items and resources for the operation.

The following table lists certain attributes of different operation items after a new work definition is created based on the change order:

Operation	Operation Item	Attribute	Assigned Value
10 (Assemble)	CM86324	Quantity	4
10 (Assemble)	CM86324	Check ATP	Not Applicable
10 (Assemble)	CM86324	Basis	Fixed
10 (Assemble)	CR40002	Required to Ship	Not Applicable
25 (Testing-Dest)	SD20011	Quantity	1

5. The manufacturing engineer clicks **Save** and **Close**.

Related Topics

- [Overview of Production Process Design](#)
- [How You Process Item Structure Changes to Work Definitions](#)

How You Manage Work Definition Versions

A work definition version defines the dates for which a production process is effective. A work definition always has an effective start date, whereas the effective end date can be null. A work definition with an effective end date as null means that it's open ended and is effective.

The following table explains the predefined rules that govern the creation of a work definition version

Change	Predefined Business Rule
Adding a new operation	A new version is mandatory only if the work definition being edited is currently effective, that's, the version start date is earlier than or equal to the system date.
Deleting an existing operation	A new version is mandatory only if the work definition being edited is currently effective, that's, the version start date is earlier than or equal to the system date.
Any other changes	A new version is optional. Changes to an existing version would make them applicable from the effective start date of that version.

Note: If an operation is effective across multiple work definition versions, then any changes to the operation such as adding or deleting operation items, operation outputs, or operation resources, will be applicable in the work definition versions where that operation is effective.

Create a Work Definition Version

You can use either of the following navigational flows to create a work definition version:

- On the Manage Work Definitions page, click the Versions icon. The **Manage Versions** dialog box opens. Click the Add icon and a new row with prepopulated data is shown. You can modify this pre-populated data.
- On the Edit Work Definition page, from the Actions menu, select Manage Versions.

When you create a new version, and if the prior version is current effective, the start date is defaulted to the current system date and time. If the prior version is future effective, the start date is left blank. Ensure to enter the correct start date, the date on which the version becomes effective. After it gets saved, the version start date can't be updated. After a new version is created, the prior version will be end dated automatically by the application. The version end date can't be updated.

In the new version, the operations from the prior version continue to be effective unless they are deleted. When you delete an operation, that operation will be end dated automatically by the application in the prior version. The end date of the operation is equal to the end date of that prior version.

Generally, upcoming production process changes would necessitate creating a future effective work definition version. For example, you need to create a new operation, and reassign either an operation item, operation output, or an operation resource from an existing operation to the new operation. To ensure that these changes are reflected only in the new version, and not prior version (due to operation effectivity spanning across versions), here are the steps that you need to perform:

1. Create a new work definition version, for example, **Version 2**.
2. Specify the start date of the new version.
3. Create a new operation, for example, **OP40**.
4. Select the operation to which the item needs reassigning is currently assigned, for example, **OP10**.
5. Right-click and select **Duplicate**.

This action creates a new OP10 operation and copy the operation items, operation outputs, and operation resources.

6. Delete the old **OP10** operation.
7. Delete the operation item that needs reassigning from the new OP10 operation.
8. Assign the operation item to the new operation **OP40**.
9. Save the work definition.

Note: If an operation is effective across multiple work definition versions, then any changes to the operation such as adding or deleting operation items, operation outputs, or operation resources, will be applicable in the work definition versions where that operation is effective.

Edit a Work Definition Version

Once you save a version, you can't edit the Version and Start Date attributes. These are the unique identifiers of the version and hence, can't be edited. Editing a work definition version is same as explained in the Edit Work Definitions: Explained topic.

Delete a Work Definition Version

You can delete a work definition version by clicking the Version icon on the Manage Work Definitions page. You can't delete past and current effective work definition versions. You can delete a future effective version if it's not the first version created. To maintain data integrity, you can't delete a future effective version if it's referenced by work orders or used in published cost scenarios.

Related Topics

- [Overview of Production Process Design](#)
- [Overview of Work Definitions](#)
- [How You Edit Work Definitions](#)

Automatic Work Definitions

Considerations for Generating Automatic Work Definitions

If you have an applicable manufacturing scenario in your enterprise, you can choose to have your work definitions generated automatically. For example, there are some kitting and light assembly manufacturing scenarios that require minimum shop floor control and capacity requirements planning.

Note: Automatic work definitions are applicable for only discrete manufacturing.

After the work definition is created automatically, you can use it to create a standard work order for execution.

The main advantage of creating a work order from an automatic work definition is that you don't have to manually maintain the work definition in case of item structure changes. You don't need to run the Process Item Structure Changes to Work Definitions scheduled process to synchronize item structure changes to automatic work definitions. Changes to the item structure will be reflected automatically on the new work order that's created using the automatic work definition.

Automatic Work Definition Setup in the Work Definition Work Area

Some steps must be completed in the Work Definition work area before product management takes the action to create an automatic work definition.

The following are the required steps:

- Ensure that the predefined work definition name ORA_MAIN is active. This predefined work definition name is used to create the automatic work definition.
- Select a standard operation that's to be used in automatic work definitions by enabling the attribute **Default for automatic work definition**.
 - An automatic work definition can have only one operation.
 - When a standard operation is selected as the default, the standard operation is enforced as count point enabled. You can update the default standard operation, but there can be only one default at a given point in time.
 - You can update the resources associated to the default standard operation, and the update will be reflected on the new work order that's created using the automatic work definition.
- Ensure that you don't create manual work definitions prior to creating an automatic work definition. When the application creates an automatic work definition, it's assigned production priority 1. If a manual work definition already exists with production priority 1, the automatic work definition creation fails.

Using Work Definitions Created Automatically

If your enterprise uses automatically created work definitions, the work definitions inherit certain specific characteristics.

They are as follows:

- On the Manage Work Definitions page, a column attribute named automatic indicates that a work definition is created automatically.
- You can't view the details of an automatic work definition.
- You can't update an automatic work definition except for the production priority and costing priority.
- You can't search for your automatic work definitions using ADFdi.
- You can't print a work definition report for an automatic work definition.

If the production process changes and you require more shop floor control you can create a manual work definition to use instead. Swap the manual work definition as the primary work definition by updating its production priority to 1.

Related Topics

- [How Automatic Work Definitions Are Created](#)
- [How You Create Work Orders from Automatic Work Definitions](#)

How Automatic Work Definitions Are Created

Automatic work definitions can be created using either the user interface or a scheduled process. You can access the user interface from the Product Information Management work area. You can access the scheduled process from the Create Automatic Work Definitions task in the Work Definition work area.

How Automatic Work Definitions Are Created in the User Interface

The product manager must follow these steps to create an automatic work definition:

1. Navigate to the Product Information Management work area and select the Manage Items task.
2. Search for the item and navigate to the Edit Item page.
3. On the Structures tab of the Edit Items page, click the Actions menu.
4. Select the option Create Automatic Work Definition.

Note: The option is enabled only if the organization is set up as a manufacturing plant.

5. Save the changes.

The product manager can create an automatic work definition for only the primary item structure of an approved standard item.

The following table lists all the values for the attributes you can find on the automatic work definition header.:

Attribute	Value
Automatic	Yes
Item	Item Name
Structure Name	Primary

Attribute	Value
Structure Item Type	Standard
Preassign Lots	Selected if the item is a lot-controlled item. Note: For automatic work definitions, the Preassign Lots attribute is selected and can't be changed. Prior to reporting product completion transactions, you must preassign lot numbers in work orders that are based on the automatic work definition.
Serial Tracked	Selected if the item serial generation is set to Predefined. Note: For automatic work definitions, the Serial Tracked attribute is selected and can't be changed. Prior to reporting product completion transactions, you must generate serial numbers in work orders that are based on the automatic work definition.
Completion Subinventory	From plant parameters
Completion Locator	From plant parameters, otherwise not defined
Work Definition Name	Main (internal name ORA_MAIN)
Version	1
Start Date	SYSDATE
End Date	Not defined
Production Priority	1
Costing Priority	Not specified
Costing Batch Output Size	From item master, otherwise not defined

Note: The action to create an automatic work definition must be performed once for each item. Changes to the item structure are synchronized automatically to the work definition.

How Automatic Work Definitions Are Created Using a Scheduled Process

You can create an automatic work definition for a set of items using Create Automatic Work Definitions scheduled process. The parameters of the scheduled process are Organization, User Item Type, Item Category, From Item, and To Item.

You can use a scheduled process to create a large number of automatic work definitions for a given user item type, or item category, or both. You can also schedule the process to run periodically so that as new items are created, automatic work definitions are subsequently created.

Related Topics

- [Considerations for Generating Automatic Work Definitions](#)

How You Manage Work Definitions in a Spreadsheet

The Oracle Application Development Framework Desktop Integration (ADFdi) enables you to combine the third party desktop productivity applications with the Oracle web applications. So, you can use a program like Microsoft Excel as an interface to access the Oracle web application data.

Note: Managing work definitions in a spreadsheet is currently supported for only discrete manufacturing.

In the **Navigator**, in the **Tools**, select the **Download Desktop Integration Installer** to install the desktop integration installer. After installing it, on **Work Definition Overview** page, in the **Tasks** pane, click the **Manage Work Definitions in Spreadsheet** link to download the worksheets. Then, you can log in and start working.

You can mass create and update the work definitions and their operations, items, and resources by using the ADFdi. There are five worksheets representing the Work Definitions and Operations, Operation Items for Standard Assemblies, Operation Items for ATO Model, Operation Items - Multilevel ATO, and Operation Resources. You can search for the work definition details based on the search criteria available in each spreadsheet. To update the data, you can overwrite the data in the search results table. After the update, an icon appears in the Changed column for each updated row. The cells that are read only fields and aren't included in the upload process. Press the Upload button when you're ready to synchronize the changes with the Oracle Fusion applications. Any data validation errors will be shown after the upload. And the success or failure of each row being uploaded is reflected in the Row Status column.

Note: The attributes Basis, Quantity, Inverse Quantity, UOM, Yield, Optional, and Planning Percent in Operation Items for ATO Model worksheet are referenced from Product Information Management and they're read-only.

During creation, you must identify the product and work definition details, and then define the sequence of the operations. You must separately build the associations between the operations and the components and resources used in each operation. During update, you must first search for the work definitions, operations, operation items, or operation resources before you can update any of the attributes. You must not run a blind report with values not specified for any of the parameters.

As a manufacturing engineer, you can use the Application Development Framework Desktop Integration (ADFdi) **Operation Items - ATO Model** spreadsheet to upload and download Assemble to Order (ATO) model work definitions with visibility to the first level of the model structure in order to assign items to operations. To build the operation item assignments in a multilevel Assemble to Order (ATO) model work definition, a separate spreadsheet **Operation Items - Multilevel ATO** tab is available.

The spreadsheet tab enables you to do the following:

- View all the levels of the option class and phantom structures, including the hierarchy from a component to the top parent item.

- Build the operation item assignments for an ATO model work definition and provides you the same flexibility in assigning items to operations as in the user interface.
- Assign an item from any level in the item structure, such as child ATO model, option class, option, phantom, or mandatory component, to a work definition operation. For example, lower level components, such as options can inherit their operation assignment based on their parent's assignment, such as option class.
- Search for ATO model work definitions and operations that use a specific material and perform a mass update, such as replacing an option that appears under different option classes.
- Create and update the expanded levels of ATO model work definitions using the ADFdi spreadsheet enables more accurate data setups and easier change management for the work definitions of product configurations created through the Configure to Order (CTO) business process.

To assign the components to different operations the following sequence must be followed:

1. Query based on Organization and ATO Model in **Operation Items - Multilevel ATO** worksheet.
2. Review Component Hierarchy and Level in addition to other details before assigning the component.
3. After completing the component assignments, requery based on Organization and ATO Model and check the assignment status of all components.

Tip: You can define operation applicability rules based on selected options and Transactional Item Attributes (TIA) only in the user interface.

If you have same work area, resources, work centers and standard operations defined in two organizations, you can use ADFdi to copy the work definitions from one organization to another organization. In the Work Definitions and Operations worksheet, create the work definition header and operations. Copy all the details of the organization from which you want to copy the work definition and paste them in the same worksheet. Modify the dates as required and change the organization to the organization in which you want the copied work definition. Then, upload all the details.

CAUTION: The standard item and Assemble to Order (ATO) model work definitions are supported in ADFdi. However, you can't create, query, or update configured item work definitions in the user interface or ADFdi. Also, you can't create Rework and Transform work definitions using ADFdi.

Note: You can upload, query, or update the descriptive flexfields details in the work definitions using ADFdi. However, while uploading or updating the descriptive flexfields in the work definitions using ADFdi, only data type validations are performed.

The Find Number and the Suggested Operation Sequence columns have been added to the following worksheets when creating or updating operation items for discrete manufacturing work definitions:

- Operation Items - Standard
- Operation Items - ATO Model
- Operation Items - Multilevel ATO

To assign a component that repeats multiple times in the item structure to a work definition operation using ADFdi, you must perform a search, then assign the item with the unique find number returned in the search results. You can copy the suggested operation sequence to the operation sequence field if the suggested operation sequence is accurate or enter the correct operation sequence for the item.

Using the ADFdi feature is beneficial for you in the following ways:

- Once you have downloaded the work definition data hosted on the Manufacturing application to a spreadsheet, you can modify it even when you're disconnected from the application.

- You can perform bulk entry and update of data with ease through a spreadsheet.
- You can use the Microsoft Excel features, such as macros and calculation.

Related Topics

- [Overview of Work Definitions](#)
- [How You Manage Work Definitions in the User Interface](#)

How You Import Discrete Work Definitions

You can use the work definition import method to create and update work definitions through the cloud import framework using spreadsheets. You can also provide the descriptive flexfields information during the work definition import. To import discrete work definitions using the cloud import framework, you can download and use the WorkDefinitionTemplate.xlsm. The .xlsm template organizes the work definition information in these tabs:

- **Instructions and CSV Generation:** The procedure to import work definitions using the .xlsm template.
- **Import Batch:** The batch identifies the group of work definitions that are being imported.
- **Work Definition Headers:** The work definition header information is identified uniquely by a Header Number within a batch. You can import work definitions across plants within a batch.
- **Work Definition Operations:** You can optionally specify work definition operation information against the Batch Code and Header Number. For an ATO model work definition, you can define operation applicability rules for option-dependent operations only in the user interface.
- **Work Definition Operation Items - Standard Items:** You can optionally specify work definition operation items information for standard items against the Batch Code, Header Number, and Operation Sequence.
- **Work Definition Operation Items - ATO Model:** You can optionally specify work definition operation items information for ATO models against the Batch Code, Header Number, and Operation Sequence.
- **Work Definition Operation Resources:** You can optionally specify work definition operation resources information against the Batch Code, Header Number, and Operation Sequence.
- **Work Definition Operation - Alternate Resources:** You can optionally specify work definition operation alternate resources information against the Batch Code, Header Number, and Operation Sequence.

You can import discrete work definitions in batches using create and update modes either by providing the basic work definition header details or by providing the complete details of work definition header, operation requirements, operation item requirements, operation resource and alternate resource requirements. You can create or update discrete work definitions using the modes of import documented in the table.

Here are the modes of import you can use to create or update work definitions:

User Preference	Header Action	Operations Action	Operation Items Action	Operation Resources and Alternate Resources
To create work definition with header and a minimum of one operation	CREATE	CREATE	Not Applicable	Not Applicable
To create work definition with header and details	CREATE	CREATE	CREATE	CREATE

User Preference	Header Action	Operations Action	Operation Items Action	Operation Resources and Alternate Resources
To update work definition	UPDATE	CREATE, UPDATE	CREATE, UPDATE	CREATE, UPDATE

You can see the successfully imported discrete work definitions as well as the errors if any, in the Schedule Process output.

Note: For more information about file-based data imports to import or update legacy and other data into Supply Chain Management Cloud from external applications, refer to the File-Based Data Import for Oracle Supply Chain Management Cloud Development Guide.

How You Import Process Work Definitions

You can use the work definition import method to create and update work definitions through the cloud import framework using spreadsheets. You can also provide the descriptive flexfields information during the work definition import.

To import process work definitions using the cloud import framework, you can download and use the ProcessWorkDefinitionTemplate.xlsm. The .xlsm template organizes the work definition information in these tabs:

- **Instructions and CSV Generation:** The procedure to import work definitions using the .xlsm template.
- **Import Batch:** The batch identifies the group of work definitions that are being imported.
- **Work Definition Headers:** The work definition header information is identified uniquely by a Header Number within a batch. You can import work definitions across plants within a batch.
- **Work Definition Operations:** You can optionally specify work definition operation information against the Batch Code and Header Number.
- **Work Definition Operation Items:** You can optionally specify work definition operation items information for standard items against the Batch Code, Header Number, and Operation Sequence.
- **Work Definition Operation Outputs:** You can specify work definition operation outputs information for products and by-products against the Batch Code, Header Number, and Operation Sequence.
- **Work Definition Operation Resources:** You can optionally specify work definition operation resources information against the Batch Code, Header Number, and Operation Sequence.
- **Work Definition Operation - Alternate Resources:** You can optionally specify work definition operation alternate resources information against the Batch Code, Header Number, and Operation Sequence.

You can import process work definitions in batches using create and update modes either by providing the basic work definition header details or by providing the complete details of work definition header, operation requirements, operation item requirements, operation resource and alternate resource requirements. You can create or update process work definitions using the modes of import documented in the table.

Here are the modes of import you can use to create or update work definitions:

User Preference	Header Action	Operations Action	Operation Items Action	Operation Resources and Alternate Resources
To create work definition with header and a minimum of one operation and a primary output	CREATE	CREATE	Not Applicable	Not Applicable
To create work definition with header and details	CREATE	CREATE	CREATE	CREATE
To update work definition	UPDATE	CREATE, UPDATE	CREATE, UPDATE	CREATE, UPDATE

You can see the successfully imported process work definitions as well as the errors if any, in the Schedule Process output.

For more information about file-based data imports to import or update legacy and other data into Supply Chain Management Cloud from external applications, refer to the File-Based Data Import for Oracle Supply Chain Management Cloud Development Guide.

How You Purge Work Definition Records from Interface

You can run the Purge Records from Interface scheduled process, for interface name work definition, to remove records with status COMPLETED_ERRORS from the work definition interface tables.

These records are populated through file based data import (FBDI) or REST. In case of FBDI, they fail validations during the Import Work Definitions process, and in case of REST, they fail the REST request validations. Correcting file-based data import (FBDI) records that resulted in errors using ADFdi spreadsheet isn't supported for work definitions.

Calculation of Lead Times

Lead Times Usage in Oracle Manufacturing

Lead time represents the duration in days required to manufacture or buy an item used in manufacturing a product. Lead times of make items are calculated using the work definition. Supply chain planning uses lead times of items to plan for material requirements. The lead time calculation determines requirement dates for available-to-promise calculations in order promising.

Note: Available-to-promise calculations are currently supported for only discrete manufacturing.

The following table illustrates all the key concepts related to lead time calculation.

Attribute	Description
Lead Time Lot Size	<p>Quantity of an item used to calculate manufacturing lead times. The default lead time lot size is 1 but you can modify it to represent the typical lot size in which the item is manufactured or purchased.</p> <p>Note: For process manufacturing items, the lead time lot size is considered from the expected output quantity of the standard batch size of the primary work definition</p>
Fixed Lead Time	<p>This represents the time to process all the manufacturing steps which are independent of the lot size of an item. You can either manually enter the fixed lead time value, or it can be calculated as part of the lead time scheduled process. It's expressed in days.</p>
Variable Lead Time	<p>This represents the time to process all the manufacturing steps which are dependent on the lot size. You can either manually enter the variable lead time value, or it can be calculated as part of the lead time scheduled process. It's expressed in days per unit.</p> <p>Note: For process manufacturing items, the variable lead time is converted to days per unit in the item's primary unit of measure.</p>
Processing Lead Time	<p>The time required to make or buy an item.</p> <ul style="list-style-type: none"> For a make item, it represents the number of working days taken to manufacture the lot size of an item while considering the shift duration of the plant. It's calculated by summing the fixed lead time, and the variable lead time multiplied by the lot size. <p>Processing lead time = Fixed lead time + (Variable lead time * lead time lot size)</p> <ul style="list-style-type: none"> For a buy item, it represents the time required by the supplier to supply the item. It represents the lead time from the time the purchase order is released to the time when the item is received. You must manually assign a value. <p>It's expressed in days.</p>
Preprocessing Lead Time	<p>Component of the lead time that represents the time required to release a purchase order or create a work order from the time you learn of the requirement. You can manually enter preprocessing lead time for both make and buy items. It's expressed in days.</p>
Postprocessing Lead Time	<p>For buy items, it's the component of the lead time that represents the time to have a buy item available in inventory from the time you receive it.</p> <p>For make items, it's the lead time of activities performed after manufacturing operations are completed, but before the item is available for shipping or the next stage of the manufacturing process.</p> <p>You must manually assign a value for each item. It's expressed in days.</p>
Cumulative Manufacturing Lead Time	<p>Total time required to make an item if you had all raw materials in stock, but had to make all subassemblies level by level. It's expressed in days.</p>
Cumulative Total Lead Time	<p>Total time required to make an item if no inventory existed, and you had to order all the raw materials and make all subassemblies level by level. It's expressed in days.</p>

The manufacturing lead time calculation calculates the fixed and variable lead times in order to calculate the processing lead times. It's calculated based on the primary work definition of the item. The plant calendar shift exception and the work center resource exception aren't considered in the calculation.

The lead time percent value is calculated and updated for each operation in the primary work definition. The lead time percent represents the offset of a given operation as a percentage of the manufacturing lead time considering all operations of the work definition. These lead time percent values are used as an input in the calculation of cumulative lead times to compute the cumulative manufacturing lead time and cumulative total lead time.

In discrete manufacturing, manufacturing lead times can be computed optionally for assemble-to-order models. However, this will represent inflated lead time values for all possible configurations within that assemble-to-order model item. Manufacturing lead time calculation isn't supported for assemble-to-order configured items. The calculation of the cumulative lead times aren't supported for assemble-to-order model items and configured items

For computation of cumulative lead times, the hierarchy to roll up lead times are calculated using the primary work definitions at each level.

Note: Lead times aren't computed for items in a reference organization.

Submit the Scheduled Process to Calculate Lead Times

The following section explains the procedure to submit the scheduled process to calculate lead times.

Perform these actions to submit the scheduled process that calculates the manufacturing lead times and rolls up the cumulative manufacturing and total lead times. Based on the manufacturing lead time calculation, the lead time percent will be calculated and updated at the operation level in the primary work definition. The lead time percent will also be used as an input to calculate the cumulative manufacturing and cumulative total lead times.

1. In the **Work Definition** work area, in the Tasks pane, click the **Calculate Lead Times and Roll Up Cumulative Lead Times** link. This will direct you to the scheduled process page.

You can also initiate the scheduled process from the **Navigator> Tools> Scheduled Processes**.

2. On the **Calculate Lead Times and Roll Up Cumulative Lead Times** page, you must specify certain values.

The following table lists the fields and the corresponding values you must specify in the **Parameters** tab to calculate lead times:

Field	Value
Scope	<p>You can specify whether you want to calculate only single-level manufacturing lead time, or only cumulative lead times, or both. The default value is Calculate Manufacturing Lead Time. Alternatively, you can choose Calculate Cumulative Lead Times or Calculate Manufacturing and Cumulative Lead Times.</p> <p>If you are running the scheduled process for the first time, or for new items, it is recommended that you first calculate the manufacturing lead times, followed by calculating the cumulative lead times. Alternatively, you can select the Calculate Manufacturing and Cumulative Lead Times option to run a combined scheduled process.</p>

Field	Value
Organization	Select the unique code of your manufacturing plant.
Item Catalog	Select the item catalog which may be striped by any of the functional areas in the application.
From Item	Enter the name of the item that defines the start of the range of items that you want to include.
To Item	Enter the name of the item that defines the end of the range of items that you want to include.
Item Category	Select the item category that includes the items you have specified.
Calculation Date	Enter the date on which the lead time is to be computed for the selected items. This date should have a valid work definition version existing prior to this date.
Planner	Enter the planner responsible for the items. If specified, the lead time calculation is restricted to the items belonging to the specified planner.
Include ATO Model	<p>Select whether or not items of the ATO model category should be included in the lead time calculation for discrete manufacturing. The default value is No.</p> <ul style="list-style-type: none"> ○ If set to No: The calculation process excludes ATO model items from the manufacturing lead time calculation. ○ If set to Yes: The calculation process includes only the ATO model items in the manufacturing lead time calculation.

3. Click **Submit**. A scheduled process request is submitted. Note the process request ID and click **OK**.
4. Navigate to the **Scheduled Processes** work area.
5. Review the progress of the submitted scheduled process. The **Calculate Lead Times and Roll Up Cumulative Lead Times** program will calculate the lead times based on the primary work definition and then trigger a child scheduled process called **Item Import**, which in turn may spawn off more child scheduled processes. Track the completion of all the scheduled processes till the status changes to **Succeeded**
6. Click the **Succeeded** status link to view additional information. You can click the **(1 more)** link and open the text file which lists all details for the calculated lead times of the selected items.

After you have reviewed all calculation details, you can verify if the lead times have been correctly updated in the item. Follow these steps:

1. In the **Product Information Management** work area, in the **Tasks** pane, select the **Manage Items** task.
2. Search for the required item. Select the item corresponding to the organization you based your search on.
3. Click the **Specifications** tab, and click the **Planning** link.
4. In the **Lead Times** region, verify the values of the following lead times, depending on what was the scope of your lead time calculation when you submitted the scheduled process:
 - Processing Days
 - Fixed
 - Variable

- Cumulative Manufacturing
- Cumulative Total
- Lead Time Lot Size (only for process manufactured items)

You can also search for the primary work definition and check if the lead time percent, as determined by the manufacturing lead time calculation, is updated at the operation level.

Considerations for Calculating Lead Times

When you run the Calculate Lead Times and Roll Up Cumulative Lead Times scheduled process to calculate the manufacturing lead times, cumulative total lead times, and cumulative manufacturing lead times for certain items, there are a few validations that the application performs which you must consider:

Key Considerations for Lead Time Calculation

The following points are key considerations for lead time calculations in manufacturing:

- The application only considers the primary work definition with production priority of 1 of an item when calculating its lead times. The calculation is done considering whether the work method selected for production priority of 1 at each level is discrete manufacturing and process manufacturing.
- The item must be set up either as a make or a buy item in the Product Information Management work area.
- For any level in the item hierarchy, if a phantom item is encountered, then the application explodes it till no further lower-level phantoms can be exploded and the flattened list of component items are included as part of that particular level.
- While calculating, if any of the values aren't available because either you didn't specify or if the scheduled process was never run previously for the manufacturing lead times, the application treats the empty values as zero.
- If a same component is assigned more than once to different operations, the component is evaluated twice because it's consumed twice in two operations.
- The precision of the lead time values are displayed in the output text file based on the value set in the profile Time Duration Decimal Precision. The precision of the final lead time values stored in Item definition is based on the precision set in Oracle Product Information Management.
- For process manufacturing, manufacturing lead time calculation considers all operations of the primary work definition irrespective in which operation the output item is yielded.
- For process manufacturing, the manufacturing lead time of the primary product is copied over to the co-product or the by-product if:
 - the co-product or by-product is within the domain of items selected in the scheduled process
 - the co-product or by-product doesn't have a primary work definition of its own
 - the manufacturing lead time for the co-product or by-product wasn't calculated previously in the current scheduled process.Once the lead time of a co-product or by-product is computed, it's not overwritten by a subsequent calculation.
- For process manufacturing, the cumulative manufacturing lead time of the primary product is copied over to the co-product or the by-product if:

- o the co-product or by-product doesn't have a primary work definition of its own
- o the cumulative manufacturing lead time for the co-product or by-product wasn't calculated previously in the current scheduled process.

Once the lead time of a co-product or by-product is computed, it's not overwritten by a subsequent calculation.

For details about which factors impact lead time scheduling when calculating lead time duration, refer to the How Work Orders are Scheduled section in the Manage Production chapter.

- The manufacturing lead time calculation supports an adjustment when resources of the first operation don't start in the first shift of the plant. In such cases, the scheduled start time is different from the start time of the first shift. A correction factor computes the difference between the schedule start time and the first shift's start time. This correction factor adjusts the calculated manufacturing lead time to improve lead time accuracy in case of partial shift assignments.
- The manufacturing lead time calculation program always considers the plant calendar when calculating the lead times, even if the work definition includes work centers with override calendars.

Related Topics

- [Lead Times Usage in Oracle Manufacturing](#)
- [Submit the Scheduled Process to Calculate Lead Times](#)
- [Example of How Lead Times are Calculated in Discrete Manufacturing](#)

Example of How Lead Times are Calculated in Discrete Manufacturing

This topic provides you a detailed illustration of how lead times are calculated for items whose primary work definition has a work method as discrete manufacturing.

The example covers the calculation logic for manufacturing lead times, cumulative total lead times, and cumulative manufacturing lead times for a simple item hierarchy.

For brief descriptions on the various types of lead times used in manufacturing, take a look at the topic Concepts Related to Lead Times Used in Manufacturing: Explained.

In this example, the total number of days as per the manufacturing calendar is 5 days, with an 8 hour shift for each work day. We are also assuming that the lot size for all items is 1 each.

In this example, we are taking a simple item hierarchy of two levels for calculation purposes. The top-level at the hierarchy is item A which is a make item. A is made up of B which is a buy item, and C which is a make item. C is again made up of item D which is a buy item.

The following table provides you the sample values of the various user-defined lead times for the two buy items, B and D that we are going to use in this example.

Item	Lot Size	Processing Lead Time	Preprocessing Lead Time	Postprocessing Lead Time
Item B	1	2	1	1

Item	Lot Size	Processing Lead Time	Preprocessing Lead Time	Postprocessing Lead Time
Item D	1	0	1	3

The following table provides you the sample values of the various user-defined lead times for the two make items, A and C that we are going to use in this example.

Item	Lot Size	Preprocessing Lead Time	Postprocessing Lead Time
Item A	1	2	2
Item C	1	1	2

Manufacturing Lead Time Calculation

In this item hierarchy, there are two make items for which we need to calculate their manufacturing lead times: A and C.

- Let's first look at the Work Definition of Item A to determine the lead times:

Operation Sequence	Resource Sequence	Resource	Basis	Usage	Scheduled	Items Assigned	Lead Time Percentage
10	10	RES1	Fixed	8 hours	Yes	Item B	0
20	10	RES2	Variable	8 hours	Yes	Item C	50

- Lead times are calculated by considering the usage of resources that has the Scheduled flag as Yes.
- Fixed lead time** for A: usage of the fixed resource divided by the total shift duration. In this example, that can be calculated as $8/8 = 1$ day. The fixed lead time is independent of lot size.
- Variable lead time** for A: (usage of the variable resource divided by the total shift duration)/lot size. In this example, that can be calculated as $(8/8)/1 = 1$ day/unit.
- Processing lead time** for A: fixed lead time (1) + {variable lead time (1)*lot size (1)} = 2 days.
- The lead time percentage is calculated as the offset percentage value of the start of a given operation to the total manufacturing lead time for all the operations of the work definition. The calculated values are shown in the table.
- Now let's look at the Work Definition of Item C to determine the processing lead time:

Operation Sequence	Resource Sequence	Resource	Basis	Usage	Scheduled	Items Assigned	Lead Time Percentage
10	10	RES1	Fixed	8 hours	Yes	None	0
20	10	RES2	Variable	16 hours	Yes	Item D	33.33

8. **Fixed lead time** for C: usage of the fixed resource divided by the total shift duration. In this example, that can be calculated as $8/8 = 1$ day. The fixed lead time is independent of lot size.
9. **Variable lead time** for C: (usage of the variable resource divided by the total shift duration)/lot size. In this example, that can be calculated as $(16/8)/1 = 2$ days/unit.
10. **Processing lead time** for C: fixed lead time (1) + {variable lead time (2)*lot size (1)} = 3 days.
11. The lead time percentage is calculated as the offset percentage value of the start of a given operation to the total manufacturing lead time for all the operations of the work definition. The calculated values are shown in the table.

Cumulative Manufacturing Lead Time Calculation

Now let's find out the cumulative manufacturing lead time for both the make items. For calculating the cumulative manufacturing lead times for a make item, here is the calculation logic:

Cumulative manufacturing lead time for a make item at any level= processing lead time + Maximum [0, preprocessing lead time, (cumulative manufacturing lead time - offset days)] + postprocessing lead time.

1. The application first calculates the cumulative manufacturing lead time for the make item at the lowest level of the hierarchy and then it traverses to higher levels. First let's calculate the cumulative manufacturing lead time for Item C.

For **Item C**, the processing lead time is 3 days. The maximum would be 1 the preprocessing lead time is 1 and because there is no make item below C in the item hierarchy. The postprocessing lead time is 2 days, as defined by the user. Therefore, the cumulative manufacturing lead time is calculated as $3 + 1 + 2 = 6$ days.

2. For **Item A**, the processing lead time is 2 days. Item C is the only make item under A and is used in operation 20, which has an lead time percent of 50% causing the offset to be $0.5 * 2 = 1$ day. The maximum therefore would be cumulative manufacturing lead time of Item C minus the offset days, which is $6 - 1 = 5$ days. The postprocessing lead time is 2 days, as defined by the user. Therefore, the cumulative manufacturing lead time is calculated as $2 + \text{Maximum}[0, 2, (6-1)] + 2 = 2 + 5 + 2 = 9$ days.

Cumulative Total Lead Time Calculation

1. First let's calculate the cumulative total lead time for the buy items B and D using this formula:

Preprocessing lead time + processing lead time + postprocessing lead time.

Here are the lead times for items B and D, defined in their work definitions.

Item	Processing Lead Time	Preprocessing Lead Time	Postprocessing Lead Time
Item B	2	1	1
Item D	0	1	3

For **item B**, the cumulative total lead time is $2 + 1 + 1 = 4$ days.

For **item D**, the cumulative total lead time is $0 + 1 + 3 = 4$ days.

- Now let us calculate the cumulative total lead time for both the make items, A and C. For calculating the cumulative total lead time calculation for a make item, here is the calculation logic:

Cumulative total lead time of a make item at any level = processing lead time + maximum [0, preprocessing lead time, (cumulative total lead time - offset days) for any make or buy component] + postprocessing lead time

For **item C**, the processing lead time is 3 days. The preprocessing lead time is 1 day, as defined by the user. The number of offset days is 1 because the component D is required at the end of day 1. The cumulative total lead time is 4 days as derived from the cumulative total lead time for the buy item component item D. The postprocessing lead time is 2 days, as defined by the user. Therefore, the cumulative manufacturing lead time is calculated as $3 + \text{Maximum} [0, 1, (4-1)] + 2 = 3+3+2 = 8$ days.

For **item A**, the processing lead time is 2 days. The preprocessing lead time is 2 days as defined by the user. The number of offset days is 0 for component B as it's required on the first day itself, and 1 for component C because it's required at the end of day 1. The cumulative total lead time is 4 days as derived from the cumulative total lead time for the item component B, and 7 days as derived from the cumulative total lead time of the item component C. The postprocessing lead time is 2 days, as defined by the user. Therefore, the cumulative manufacturing lead time is calculated as $2 + \text{Maximum} [0, 2, (4-0), (8-1)] + 2 = 2+7+2 = 11$ days.

- Based on all the calculations and derivations, here's a final summary of all the lead time values:

Item	Type	Lot Size	Fixed Lead Time	Variable Lead Time	Processing Lead Time	Preprocessi Lead Time	Postprocess Lead Time	Cumulative Manufactur Lead Time	Cumulative Total Lead Time
Item A	Make	1	1	1	2	2	2	9	11
Item B	Buy	1	Not applicable	Not applicable	2	1	1	Not applicable	4
Item C	Make	1	1	2	3	1	2	6	8
Item D	Buy	1	Not applicable	Not applicable	0	1	3	Not applicable	4

Related Topics

- [Lead Times Usage in Oracle Manufacturing](#)
- [Considerations for Calculating Lead Times](#)
- [Submit the Scheduled Process to Calculate Lead Times](#)

Example of Calculation of Process Manufacturing Lead Times

This topic provides you a detailed illustration of how lead times are calculated for for items whose primary work definition has a work method as process manufacturing.

The example covers the calculation logic for manufacturing lead times. The cumulative total lead times and cumulative manufacturing lead times follows the same logic as the example for discrete manufacturing.

For brief descriptions on the various types of lead times used in manufacturing, take a look at the topic Concepts Related to Lead Times Used in Manufacturing: Explained.

In this example, we are taking a simple item hierarchy of two levels for calculation purposes. The top-level at the hierarchy is item A which is a make item and the primary output of the work definition. A1 is a co-product yielded from the same work definition. A is made up of C, which is a buy item, and B, which is a make item. In the work definition of B, B is the primary output item and B1 is a by-product. B is made up of items D and E, both of which are buy items.

Manufacturing Lead Time Calculation

In this item hierarchy, there are two make items for which we need to calculate their manufacturing lead times: A and B. We will copy the calculated manufacturing lead times to the co-product and by-product: A1 and B1. For item A, the primary UOM is drums, where 1 drum = 10 Liters and for item A1, the primary UOM is Dz. For items B and B1, the primary UOM is Liters.

1. Let's first look at the work definition of Item A. The standard batch size of the work definition is 100 Ga, in which 70 Liters of item A and 30 Ea of item A1 are expected to be yielded.

Operation Sequence	Output Items	Input Items	Resource Usage	Lead Time Percentage
10	N/A	N/A	Resource: RES 1 Basis type: Fixed Usage: 1 UOM: Days	0
20	Item: A1 Quantity: 30 UOM: Ea	Item: B Quantity: 50 UOM: Liters	Resource: RES 2 Basis type: Variable Usage: 1 UOM: Days	33
30	Item: A Quantity: 70 UOM: Liters	Item: C Quantity: 50 UOM: Ea	Resource: RES 3 Basis type: Variable Usage: 1 UOM: Days	66

2. **Fixed lead time** for A: The fixed lead time is independent of lot size. In this example, it is 1 day.
3. **Variable lead time** for A: Since the basis type is variable, it takes $1+1 = 2$ days to manufacture 70 Liters of A, which is 7 drums (as 1 drum = 10 Liters), the variable lead time is $2/7 = 0.2857$ days/drum.

4. **Lot size** for A: The lot size for process manufacturing items is determined from the primary work definition. In this example, the primary work definition yields 70 Liters of item A. However since the primary UOM is drums, the lot size is updated as 7 drums.
5. **Processing lead time** for A: fixed lead time (1) + {variable lead time (0.2857)*lot size (7)} = 3 days.
6. The lead time percentage is calculated as the offset percentage value of the start of a given operation to the total manufacturing lead time for all the operations of the work definition. The calculated values are shown in the table.
7. Let us now calculate the manufacturing lead time of the co-product A1.
8. **Fixed lead time** A1: The fixed lead time is copied over from A, which is 1 day.
9. **Variable lead time** for A1: The variable lead time of 2 days is copied over to and restated considering the primary unit of measure of item A1. The primary work definition is expected to yield 30 Ea, which when restated in primary UOM is 2.5 Dz (1 Dz = 12 Ea). So the variable lead time is 2/2.5 = 0.8 days/Ea.
10. **Lot size** for A1: The lot size for process manufacturing items is determined from the primary work definition. In this example, the primary work definition yields 30 Ea of item A1. However since the primary UOM is Dz, the lot size is updated as 2.5 Dz..
11. **Processing lead time** for A1: The processing lead time is copied from A, which is 3 days
12. Now, let us look at the work definition of item B to determine the processing lead time:

Operation Sequence	Output Items	Input Items	Resource Usage	Lead Time Percentage
10	Item: B1 Quantity: 40 UOM: Liters	Item: D Quantity: 80 UOM: Liters	Resource: RES 1 Basis type: Fixed Usage: 2 UOM: Days	0
20	N/A	N/A	Resource: RES 2 Basis type: Variable Usage: 1 UOM: Days	40
30	Item: B Quantity: 60 UOM: Liters	Item: E Quantity: 20 UOM: Liters	Resource: RES 3 Basis type: Variable Usage: 2 UOM: Days	60

13. **Fixed lead time** for B: The fixed lead time is independent of lot size. In this example, it is 2 days.
14. **Variable lead time** for B: Since the basis type is variable, it takes 2+1 = 3 days to manufacture 60 Liters of B, the variable lead time is 3/60 = 0.05 days/Liter.
15. **Lot size** for B: The lot size for process manufacturing items is determined from the primary work definition. In this example, the primary work definition yields 60 Liters of item B.

16. **Processing lead time** for B: fixed lead time (2) + {variable lead time (0.05)*lot size (60)} = 5 days.
17. The lead time percentage is calculated as the offset percentage value of the start of a given operation to the total manufacturing lead time for all the operations of the work definition. The calculated values are shown in the table.
18. Let us now calculate the manufacturing lead time of the by-product B1.
19. **Fixed lead time** B1: The fixed lead time is copied over from A, which is 2 days.
20. **Variable lead time** for B1: The variable lead time of 3 days is copied over to and stated in the primary unit of measure of item B1. The primary work definition is expected to yield 40 Liters, So, the variable lead time is 3/40 = 0.075 days/Liter.
21. **Lot size** for B1: The lot size for process manufacturing items is determined from the primary work definition. In this example, the primary work definition yields 40 Liters of item B1.
22. **Processing lead time** for B1: The processing lead time is copied from B, which is 5 days

Related Topics

- [Lead Times Usage in Oracle Manufacturing](#)
- [Considerations for Calculating Lead Times](#)
- [Submit the Scheduled Process to Calculate Lead Times](#)
- [Example of How Lead Times are Calculated in Discrete Manufacturing](#)

Overview of Electronic Signatures and Electronic Records for Work Definition Management

Oracle Electronic Records and Electronic Signatures is a framework you can configure for securely capturing, storing, retrieving, and printing electronic records and signatures. Using this framework, you can review electronic records for work definitions and capture electronic signatures.

A work definition is available for use in production after the first version for that work definition is in **Approved** status. A work definition version that's not in **Approved** status isn't available for creating a work order or be used in Planning or Costing. When you submit a work definition version for approval, the process of generating electronic records is initiated. The **Submit** action is available after creating and updating a work definition version. Note that you can't update an existing approved version.

Note: You can't create or update work definitions using spreadsheet (ADFdi), file-based data import (FBDI), or REST service, if Electronic Records and Electronic Signatures (ERES) is enabled for work definition management in an organization.

To capture electronic signatures and generate electronic records for work definition management in an organization, you need to set up the following:

- Enable Manufacturing Work Definition Management for the Organization. Follow these steps:
 - a. In the Setup and Maintenance work area, go to the following:
 - Offering: Manufacturing and Supply Chain Materials Management
 - Functional Area: Facilities
 - Task: Configure Electronic Signature Preferences
 - b. Enable the E-Signature for the Work Definition Management transaction.

Note: You can't disable E-Signatures for work definitions when one or more work definition versions exist in draft or pending approval status.

- Configure the Business Process Rules to Determine the Approvers for Work Definition Management. Follow these steps:
 - a. In the Setup and Maintenance work area, go to the following:
 - Offering: Manufacturing and Supply Chain Materials Management
 - Functional Area: Facilities
 - Task: Manage Task Configurations for Supply Chain Management
 - b. Define approval rules for Work Definition Management.

Note: For more information about implementing E-Signatures and generating E-Records, refer to the Implementing E-Signatures and E-Records chapter of the Oracle SCM Cloud Implementing Manufacturing and Supply Chain Materials Management guide.

Related Topics

- [Overview of Electronic Signatures and Electronic Records for Standard Operation Management](#)
- [How You Capture E-Signatures and Generate E-Records for Standard Operation Management](#)

How You Capture E-Signatures and Generate E-Records for Work Definition Management

You can enable the ability to capture electronic signatures and generate electronic records for work definition creation, and work definition update.

The electronic record that you automatically generate for a work definition has the following information:

- Work Definition Details
- Attachment Details
- Operation Details
- Operation Item Details
- Operation Output Details, for a process work definition
- Substitute Details for an Operation Item, for a discrete work definition
- Operation Resource Details
- Alternate Resource Details for an Operation Resource

After you enable electronic signatures for a manufacturing work definition, the created work definition has a version in **Draft** status. You can continue to save changes to a Draft work definition version.

Work definition version status works simultaneously with the workflow for the deferred approval and can have one of the following statuses:

- Draft

- Pending Approval
- Approved

You can initiate the deferred electronic signature capture process when you submit the work definition for approval. Approvers can access notifications in the Oracle Cloud application. They can review the electronic records before adding their electronic signature. Approvers can also enter comments, indicate their approval or rejection, and sign the electronic record by using a password. Approvers also have the visibility to the current status of the approval process in the approval **History** region in the approval workflow notification. Electronic records are generated and the electronic signatures are captured during this approval process. The work definition version is updated as **Approved** for an approved outcome and **Draft** for a rejected outcome.

The behavior for the work definition operations, operation materials and resources for an approved work definition version is the same as the work definition that is pending approval. The only exceptions are when:

- Further changes can be made by creating a new work definition version.
- Work definition priorities can be changed without requiring a new electronic signature.
- In the case of a discrete work definition, the item structure component changes approved and completed in the Oracle Fusion Product Model are processed by the Process Item Structure Changes to Work Definitions scheduled process.

A new work definition version and any changes introduced including the deletion of any operations go through the same electronic signature process. The deleted operation or any changes are only available for use in production after these are approved.

You can search and retrieve electronic records in the electronic records work area using multiple search criteria like the contents of the report title, the transaction type, organization, signed date, and status. The electronic records are stored in secured document repository and cannot be modified or deleted. Oracle E-Signatures and E-Records store both the approved and rejected records.

Note: For more information about capturing E-Signatures and generating E-Records, refer to the Oracle SCM Cloud Using E-Signatures and E-Records guide.

Signature History

You can enable the ability to capture electronic signatures and generate electronic records for work definition creation and work definition update.

Audit Trail for Work Definitions

How You Enable Audit Trail for Work Definitions

To enable audit trail for work definitions, use the Manage Audit Policies task in the Setup and Maintenance work area. After audit is enabled, any changes to work definitions are recorded and time stamped as they occur. It includes creation, update, and deletion of work definitions and its child objects, using the user interface, ADFdi spreadsheet, file-based data import (FBDI), and REST services. You can enable all or any of the work definition and its child objects.

The hierarchy of business objects enabled for work definition audit is as follows:

<input type="checkbox"/>	▲ Work Definitions
<input type="checkbox"/>	▲ Work Definition
<input type="checkbox"/>	▲ Operation
<input type="checkbox"/>	▲ Material
<input type="checkbox"/>	Substitute Material
<input type="checkbox"/>	Material Attachments
<input type="checkbox"/>	▲ Output
<input type="checkbox"/>	Output Attachments
<input type="checkbox"/>	▲ Resource
<input type="checkbox"/>	Alternate Resource
<input type="checkbox"/>	Resource Attachments
<input type="checkbox"/>	Operation Attachments
<input type="checkbox"/>	Work Definition Version
<input type="checkbox"/>	Work Definition Attachments

Related Topics

- [Audit Policies](#)
- [Audit Configuration for Business Object Attributes](#)
- [Overview of Audit Configuration](#)

How You View Audit Report for Work Definitions

Audit history for work definition is available from the Audit Reports work area. To search for work definition changes, select Common Work Setup under Product, and Work Definition under Business Object Type. You must enter a Date criteria. Optionally, you can filter the results by specifying a specific user or event type, for example, insert (create), update, or delete. You can export the search results to Excel for detailed analysis.

The Description field can be used to search for specific work definition records. You can enter the work definition item in the Description field, or to narrow down the results, you can use a part of the description displayed on the search results. For example, if you specify "Item:ITEM_NAME/Sequence:10," it will then return specific work definition records for the specified item with operation sequence 10, and the corresponding child objects.

To retrieve audit records for the child objects, select **Include child objects**. Depending on what has been configured by your administrator, the following work definition's child objects would be retrieved:

- Work definition versions
- Work definition attachments
- Work definition operations and their descriptive flexfields
- Work definition operation items (including documents), their descriptive flexfields, substitute components, and attachments
- Work definition operation outputs, if it is a process manufacturing work definition, their descriptive flexfields, and attachments
- Work definition operation resources, their descriptive flexfields, alternate resources, and attachments
- Work definition operation item substitute details for discrete and process manufacturing work orders

Creation, update, and deletion of work definitions are tracked automatically down to the attributes level. To display updates to the attributes, select **Show Attribute Details**. The old value and new value are displayed for each update.

Additional contexts are available to uniquely identify a record. To display contexts, select **Show additional object identifier columns**. There are 3 contexts available: Work Definition for Context1, which is the Work Definition Name, Organization for Context2, and Version for Context3. Work definition audit report shows the impacted work definition versions for any changes to operations, operation items, operation outputs, or operation resources that are done for an operation that is effective in multiple versions. The impacted versions information changes dynamically. The values captured for the Version context may vary depending on when the audit report is ran and what versions are applicable at that point.

The description of the audit record captures the unique reference for each business object type, whether it is the work definition header, work definition version, work definition operation, work definition operation material, etc. Specifying a part of the description in the Description search field allows you to search the change history for specific work definition records that you are interested in.

Item structure component attributes that are referenced from Oracle Product Hub, such as basis type and substitute material unit of measure cannot be audited as part of the manufacturing work definition. You can implement change orders to track these item structure component attribute changes.

Data Security for Work Definitions

Overview of Data Security for Work Definitions

You can control a user's access to maintain (create, update, delete) or view manufacturing work definitions using data security policies.

For example, a set of users can maintain work definitions of the engine product line, but they can only view work definitions of the transmission product line.

A data security policy is defined by specifying a seeded or custom condition and one or more actions and is assigned to seeded or custom job roles. Three conditions have been seeded in the application, by user item type, by item category, and by work definition name. Use the code of user item type and item category and use the internal name of work definition name when you specify the parameters. You can also define your own custom conditions. When defining a custom condition, you can specify either Filter or SQL Predicate as a condition type. Choose Filter when you what to use

the attribute tree picker user interface to define a simple condition. Choose SQL Predicate when you know the attributes names of your condition and you want to define an SQL WHERE clause, for example to specify a dynamic condition, using a parameterized SQL predicate. For more information on how to define a custom condition, refer to the Managing Oracle Fusion Applications Data Security Policies documentation.

Two actions have been seeded in the applications, and you can't define custom actions. The first seeded action is Maintain. This action allows access to create, update, and delete work definitions, including deactivate and reactivate work definitions. Maintain action doesn't encompass the View action. The second seeded action is View. This action allows access to search and view work definitions, including print work definition report.

If a user through their roles has been granted only the View action and not also Maintain action, upon trying to either create, update, delete, deactivate or reactivate a work definition, they'll receive an error message: You're not authorized to create, update, delete, deactivate, or reactivate work definition <work definition name> for item <item name>. Data security applies to both discrete and process manufacturing, and to all interfaces, which are the user interface, Application Development Framework Desktop Integration (ADFdi), File-Based Data Import (FBDI), and REST service.

Consider the following points before enabling data security for manufacturing work definitions:

- If you enable data security for manufacturing work definition without first defining data security policies, then users won't have access to any work definitions.
- If you need certain users to be able to access all work definitions, you can define a policy with a rule where the row set is specified as all values.
- To maintain work definitions using the user interface and ADFdi, you must assign both View and Maintain actions, whereas using FBDI and REST, you need to assign only Maintain action.
- How function privilege and data security interacts is that the most restrictive access between the privilege and specified action applies. For example, if the user has the Manage Work Definitions function privilege, but the data security policy allows only View action, then they can access the work definitions in view only mode.
- There's no change to organization access, which will continue to be granted using the Manage Manufacturing Plant Data Access for Users task.

For more information, refer to the Managing Oracle Fusion Applications Data Security Policies documentation.

How You Enable Data Security for Work Definitions

The enablement for control access to manufacturing work definitions using data security is achieved by performing the setup in the Setup and Maintenance work area within the Manufacturing and Supply Chain Materials Management offering.

The functional areas are Users and Security and Manufacturing Master Data, and the corresponding tasks are Manage Data Security Policies and Manage Data Security Controls for Manufacturing.

Enabling data security for manufacturing work definitions is a 2-step process. The first step is to define data security policies, and the second step is to enable data security for manufacturing work definition business object.

To define data security policies in the security console, use the Manage Data Security Policies task in the Setup and Maintenance work area. Navigate to the Administration page, then to the Manage Database Resources page. Search for object name WIS_WORK_DEFINITIONS and click on the plus icon to create a new policy. First, specify the policy name and start date, and optionally description. Then, specify the job roles that will be granted the access.

Next, specify the rule. There are 3 values for row set: multiple values, all values, and single value. If row set is specified as multiple values, you can use either a seeded or custom condition. If row set is specified as all values, then the users will

have access to all work definitions. If row set is specified as single value, then you'll have to specify the work definition ID, and the users will have access to that specific work definition.

Lastly, you must specify the actions. The two seeded actions are Maintain and View, and you can't create custom actions.

To enable data security for manufacturing work definition business object, use the Manage Data Security Controls for Manufacturing task in the Setup and Maintenance Work Area. The Enable Data Security check box is defaulted to unchecked in the current update. Select the check box and save the setting. You've now enabled data security for manufacturing work definitions.

4 Manage Production

Overview of Production Management

Oracle Manufacturing provides various capabilities that enable production supervisors to efficiently manage production activities.

By providing visibility into production performance and exceptions, it facilitates information driven management and helps in proactive resolution of shop floor issues. It enables production supervisors to manage production calendars by creating shift exceptions and work center resource exceptions to represent shop floor conditions.

Manufacturing supports discrete and process production work methods and provides the ability to manage a work order through its entire life cycle. This includes tasks, such as creating work orders, releasing them to production, pre-assigning serials, editing the work order details to adapt to changes in production priorities, reviewing supply reservations and production progress, tracking production transaction history, and finally closing the work orders after production completion.

Through predefined macro-enabled spreadsheet templates, it enables users to create and update work orders using the file-based data import infrastructure.

A typical day in a life of a production supervisor starts by accessing the **Work Execution** work area to review key production information and manage production activities.

Related Topics

- [Overview of Production Execution Tasks](#)
- [How You Manage Work Areas](#)
- [How You Manage Work Centers](#)
- [Overview of Manufacturing Plants](#)

Infolet-Based Work Execution Work Area

Overview of the Work Execution Work Area

The Overview page in the Work Execution work area serves as a landing page for shop floor personnel to review, manage, and report production activities. It provides insight into plant, work area, work center level production details, and lists all the work execution-related tasks used to manage and execute discrete production.

You can access the Work Execution work area if you've been assigned a job role your enterprise uses for production supervisor or production operator work.

The Work Execution Overview page has a collection of infolets providing high-level summary of the production details of the selected manufacturing plant. The page also has a Panel drawer that lets you directly access the tasks and Reports and Analytics for your manufacturing plant. The Panel drawer can be accessed from the Overview page or any other page within this work area.

Infolets

If you've been assigned a job role your enterprise uses for production supervisor, you see the following infolets relevant to manage and execute production:

- Work Orders
- Rework (for discrete manufacturing work orders)
- Open Exceptions
- Operations Scheduled Versus Actual
- WIP Inspections
- Operations
- IoT Insights: OEE
- IoT Machines In-Use
- IoT Machines Idle
- IoT Machines Down
- IoT Dashboard Metrics

If you've been assigned a job role your enterprise uses for production operator work, you see a subset of infolets relevant to production execution:

- Operations Scheduled Versus Actual
- WIP Inspections
- Operations

The metrics displayed in the **Work Orders**, **Rework**, **Operation Scheduled Versus Actual** and **Operations** infolets are displayed based on the values you set by clicking the **View By** icon.

To change the basis on which the metrics are displayed in the infolets, click **View By** on the Overview page.

- To view plant level metrics, leave both the **Work Area** and **Work Center** fields to the default value of All.
- To view work area specific metrics, select the required **Work Area**.
- To view work center level metrics, select the correct combination of both the **Work Area** and **Work Center** fields.

Note: The **Open Exceptions** and **WIP Inspections** infolets aren't affected by this setting and are always applicable at the plant level.

After you have set the value for **View By** and can view metrics relevant to your work area or work center of your manufacturing plant, you can now click a specific metric and drill down to the underlying page such as the Manage Work Orders page, or the Review Dispatch List page for more detailed information or to perform further actions.

Tasks

If you've been assigned a job role your enterprise uses for production supervisor, additional manufacturing tasks you can perform:

- Manage Work Orders
- Material Availability Rules
- Material Availability Assignments

- Manage Production Exceptions
- Manage Supplier Operations
- Close Work Orders
- Transfer Transactions from Production to Costing
- Review Product Genealogy
- Manage Production Calendar
- Manage Work Center Resource Calendar
- Review Dispatch List
- Report Production Exception
- Create Inspection
- Inspections
- Report Material Transactions
- Report Resource Transactions
- Report Orderless Completion
- Report Orderless Return
- Review Production Transaction History
- Print Work Order Traveler
- Print Components List
- Pick Materials for Work Orders
- Import Work Orders
- Import Material Transactions
- Import Resource Transactions
- Import Operation Transactions
- Purge Records from Interface
- Correct Work Orders and Transactions for Import

These tasks are displayed in the panel drawer in the Work Execution work area, based on the privileges granted to the job roles that are assigned to you. If you've been assigned a job role your enterprise uses for production operator work, you're able to view and access only a subset of these tasks.

Reports and Analytics

Using Reports and Analytics, you can create and view reports or analysis related to your manufacturing plant. You can use Oracle Transactional Business Intelligence to create analysis and Oracle Business Intelligence Publisher to create reports.

Related Topics

- [Infolet Related to Production Exceptions](#)
- [Infolets Related to Work Execution](#)
- [Infolet Related to Inspections](#)
- [How You Use and Personalize Infolets in Oracle Fusion Cloud SCM and Procurement](#)

Infolets Related to Work Orders

You can view the following infolets in the Work Execution work area if you've been assigned a job role your enterprise uses for production supervisor work.

Work Orders Infolet

The **Work Orders** is a text layout-based infolet that displays count of work orders having at least one operation within the selected work area or work center.

The infolet shows three key metrics:

On Hold: Displays the count of those work orders in On Hold status.

Past Due: Displays the count of those work orders having the following:

- In Released status.
- Scheduled completion date of work order is past due the current date.

Unreleased: Displays the count of those work orders in Unreleased status.

Each count drills down to the Manage Work Orders page with the appropriate query criteria filtered. You can search for your required work order and track its progress.

Rework Infolet

The **Rework** infolet is a text layout-based infolet that displays count of work orders having at least one operation within the selected work area or work center.

The infolet shows two key metrics:

Rework: Displays the count of those work orders having the following:

- Work order type is defined as Rework.
- In Unreleased, On Hold, or Released status.

Transform: Displays the count of those work orders having the following:

- Work order type is defined as Transform.
- In Unreleased, On Hold, or Released status.

Each count drills down to the Manage Work Orders page with the appropriate query criteria filtered. You can search for your required work order here and track its progress.

Note: Both the Work Orders infolet and the Rework infolet can't be flipped or expanded.

Note: Rework infolet flow is currently supported for only discrete manufacturing.

Related Topics

- [Overview of the Work Execution Work Area](#)

Infolets Related to Work Execution

The Operations infolet and the Operations Scheduled Versus Actual infolet shows key metrics at either the plant level or the work area or work center level that you have selected using the View By icon.

Operations Infolet

The Operations infolet is a text-layout-based infolet that displays the count of operations which are Past Due, Ready and Reject, belonging to the selected work area or work center.

The infolet shows three key metrics:

Past Due: Displays the count of operations having the following:

- Operation type is specified as in-house.
- In Ready or Reject status.
- Scheduled completion date of the operation is past due the current date.
- Operation type is specified as in-house.

Reject: Displays the count of operations having the following:

- Operation type is specified as in-house.
- In Reject status.

Ready: Displays the count of operations having the following:

- Operation type is specified as in-house.
- In Ready status.

Each count drills down to the Review Dispatch List page with the appropriate query criteria filtered. You can search for your required operation here and track its progress.

Note: The Operations infolet can't be flipped or expanded.

Operations Scheduled Versus Actual Infolet

The Operation Scheduled Versus Actual infolet is a ring-chart-based infolet.

It shows the following two kinds of metrics:

Scheduled Quantity: Displays the total quantity scheduled for production in the current shift. This is the sum of all work order quantities against operations which have the following:

- Scheduled completion date of the operation is within the current shift of the plant calendar.
- Operation type is specified as in-house.

Operation Quantity by Dispatch Status: The ring segments are color-coded to represent operation quantities in their corresponding dispatch status such as Ready, Complete, Reject and Scrap.

The **Not Ready** metric calculation is derived as the total of Ready, Scrapped, Rejected, and Completed quantity deducted from the Scheduled total quantity. If Not Ready is calculated as negative in any of the operations, it's displayed as zero.

You can view more details regarding the operations in your work center and the progress of each work center based on the shift you select by clicking the **Expand** icon on the infolet.

The expanded view of this infolet is a list of records which displays the operation quantities and their completion progress by work center. This list is sorted in the ascending order of the least performing work centers. The **Progress** percentage is calculated as Completed Quantity divided by Total quantity.

Each metric on the infolet in either the front view or expanded view directs you to the Review Dispatch List page with the appropriate query criteria filtered. You can search for your required operation here and track its progress.

Related Topics

- [Overview of the Work Execution Work Area](#)
- [How You Use and Personalize Infolets in Oracle Fusion Cloud SCM and Procurement](#)

Infolet Related to Production Exceptions

You can view the Open Exceptions infolet in the Work Execution work area if you've been assigned a job role your enterprise uses for production supervisor work.

Open Exceptions Infolet

The **Open Exceptions** infolet is a text-layout based infolet that displays the count of open exceptions that are reported in the plant.

The infolet shows two key metrics:

New: Displays the count of exceptions having the following:

- Status is Open.
- Exceptions reported on the current date as reflected in the application.

Total: Displays the count of exceptions in Open status.

You can view more details of the total count of open exceptions by clicking the expanded view icon. The expanded view of Open Exceptions infolet is a ring chart based infolet. It displays two key metrics:

- Total
- By Exception Type

The ring-based expanded view of the Open Exceptions infolet shows the number of total exceptions in the center of the ring. The ring itself is color-coded to identify the different exception types which are:

- Component
- Resource

- [Supplier Operations](#)
- [Work Area](#)
- [Work Center](#)
- [Miscellaneous](#)

Each count in either the front view or expanded view drills down to the Manage Production Exceptions page with the appropriate query criteria filtered. You can search for your required work order exception and take required actions.

Related Topics

- [Overview of the Work Execution Work Area](#)
- [How You Use and Personalize Infolets in Oracle Fusion Cloud SCM and Procurement](#)

Infolet Related to Inspections

Some operations in your manufacturing plant may have required inspection predefined for them. As a production supervisor or operator you can perform the inspection and complete the transaction to decide the disposition for those operations. You can complete, reject or even scrap quantities of such operations based on your privileges.

Inspections Infolet

The Work-in-Process Inspections infolet is a text-layout-based infolet that displays the percentage of rejected work-in-process (WIP) samples or serials compared to the WIP samples or serials inspected in the last 7 days in the plant.

The calculations are derived based on the following criteria:

- Operation samples or serials inspected by a work-in-process inspection plan.
- Inspection disposition is either completed or rejected.
- The inspection date for the samples or serials is 7 days or less prior to the current date.

The percentage count drills down to the View Inspections: Inspection Results List page. You can search for your required operations which have required inspection and track their progress.

Related Topics

- [Overview of the Work Execution Work Area](#)
- [How You Use and Personalize Infolets in Oracle Fusion Cloud SCM and Procurement](#)

Infolets Related to IoT Production Monitoring

If your manufacturing plant is enabled for synchronization with Oracle IoT Production Monitoring, as a production supervisor, you can view the following infolets on the Work Execution work area overview page:

- [IoT Insights: OEE](#)
- [IoT Machines In-Use](#)
- [IoT Machines Idle](#)

- IoT Machines Down
- IoT Dashboard Metrics

These real time metrics from IoT provides immediate visibility of shop floor operations for you to make better decisions. You can focus on key aspects of your shop floor to help maximize capacity, increase throughput, and improve quality. You can click on any of the metrics displayed in these infolets, which will take you to the Factory Dashboard of your manufacturing plant in IoT Production Monitoring Cloud, where you can view more details about the metric.

You can hide infolet cards that aren't relevant for your use.

IoT Insights: OEE

The IoT Insights OEE infolet is a ring-chart-based infolet. You can view the Operational Equipment Effectiveness (OEE) of the plant and track this metric to monitor and focus on operational efficiency of your shop floor in your manufacturing plant. This metric is displayed in the infolet in Oracle Manufacturing when the corresponding IoT metric **Overall Equipment Effectiveness** is added to the Factory Dashboard.

The plant level OEE metric is derived by aggregating machine level OEE metric, which is calculated as follows:

Availability x Performance x Quantity

Calculation considerations

- Availability considers events that stop planned production time due to reasons such as machine breakdown, material shortages, change over time, so on so forth. These are tracked by the IoT Production Monitoring cloud using the machine state.
- Performance considers anything that causes the manufacturing process to run at less than the maximum possible speed when it's running. This is calculated by the IoT Production Monitoring cloud using the ideal cycle time of the machine, total production count, and machines in-use time.
- Quality considers manufactured parts that don't meet quality standards, including parts that need rework.

You can click on the OEE metric in the IoT Factory Dashboard, which displays the breakup of Availability, Performance, and Quality metrics for the selected time period and product.

IoT Machines In-Use

The IoT Machines In-Use infolet is a text layout-based infolet that displays a count of plant machines that are in use. The machines in IoT are the resource instances belonging to your Manufacturing Plant in IoT. This metric is displayed in the infolet in Manufacturing when the corresponding IoT metric **Total In Use Machines** is added to the Factory Dashboard.

IoT Machines Idle

The IoT Machines Idle infolet is a text layout-based infolet that displays a count of plant machines that are idle. This metric is displayed in the infolet in Manufacturing when the corresponding IoT metric **Total Idle Machines** is added to the Factory Dashboard.

IoT Machines Down

The IoT Machines Down infolet is a text layout-based infolet that displays a count of plant machines that are down and are unavailable. This metric is displayed in the infolet in Manufacturing when the corresponding IoT metric **Total Machines Down** is added to the Factory Dashboard.

IoT Dashboard Metrics

The IoT Dashboard Metrics infolet is a list layout-based infolet that displays all the predefined and user-defined metrics configured to be displayed in the dashboard of IoT Production Monitoring. The predefined metrics can belong to either a factory metric or a machine metric. You can define user-defined metrics in IoT by specifying the calculation schedule and formula. The metrics in the infolet are displayed in the same sequence in which it's configured in the IoT Dashboard.

For more information about IoT Production Monitoring, refer to the Using Oracle Internet of Things Production Monitoring Cloud Service guide in the Help Center.

How You Manage Production Calendars

A production calendar represents the manufacturing calendar associated using the Manage Plant Parameters page or override calendars associated to a specific work center. You can use the Setup and Maintenance work area to define the shifts, workday patterns, and schedules. Oracle Manufacturing only supports shifts that are of type Time and shift detail that are of type Punch or None. If the work center isn't selected, the production calendar indicates the operational time of a plant. If a work center is selected, then it indicates the operational time based on the override calendars of the work centers. You can define shift exceptions to make modifications to the shift duration. The shifts and shift exceptions displayed in the production calendar are interpreted in the plant time zone as defined in Manage Inventory Organization Parameters.

If a work center isn't selected, the shift and shift exceptions created are applicable for all the resources of all work centers that don't have any override calendars. If a work center is selected, the shift and shift exceptions created are applicable for all its resources. However, a specific shift exception can be defined for one or more work center resources to override the Default Availability. This collectively determines the resource availability considered for calculation of the lead times and scheduling of work order dates.

Manage Shift Exceptions

A shift exception is a change in the shift assigned to the manufacturing plant or work centers with override calendars. This exception affects the availability of all shift based work center resources defined within the plant. You can identify shift exceptions and standard shifts on the production calendar. The shift exceptions are also color-coded to for you to analyze with ease.

You use the **Manage Production Calendar** page from the **Work Execution Overview** page to perform the following tasks:

- Creating a shift exception
- Editing a shift exception
- Deleting a shift exception

Creating a Shift Exception:

You can create a shift exception to add a new shift or make changes to an existing shift for a day or a period of time. The start time and end time displayed, or the start time entered on this page is assumed to be in the plant time zone.

The following exception types are supported for an existing shift:

- Change shift
- Remove shift

- Split shift

The following exception type is supported for a nonworking time shift:

- Add shift

Editing a Shift Exception:

You can only edit a future shift exception. However, you can edit the end date of a current shift exception.

To edit a shift exception, perform the following steps:

1. On the **Manage Production Calendar** page, click the shift exception in the calendar that you want to edit. Then, from the right-click menu or the **Actions** menu, select *Edit Shift Exception*.
2. On the **Manage Production Calendar: Edit Shift Exception** page, edit the fields that you want to change.
3. Click the **Save and Close** button.

Deleting a Shift Exception:

You can only delete a future shift exception. To delete a shift exception, on the **Manage Production Calendar** page, click the shift exception in the calendar that you want to edit. Then, from the right-click menu or the **Actions** menu, select *Delete Shift Exception*.

Related Topics

- [How You Manage Work Center Resource Calendars](#)
- [Create a Shift Exception](#)
- [Create a Resource Exception](#)

Create a Shift Exception

You can create four types of shift exceptions in a production calendar: They are Add Shift, Change Shift, Remove Shift, and Split Shift. The following examples illustrate the steps to create each of these shift types.

Note: You can extend a shift by creating a shift exception for the shift. In the **Manage Production Calendar** page, select a shift and right-click on it to create a shift exception

Add Shift

Add Shift exception type is used when the plant needs an additional shift for any reason such as addressing the backlog or seasonal loads. To add a shift, perform the following steps:

1. On the **Manage Production Calendar** page, in the calendar, click a specific date for which you want to create the shift exception. Ensure that you click outside the existing shift time. Then, from the **Actions** menu, select: **Create Shift Exception**.
2. On the **Manage Production Calendar page: Create Shift Exception** page, enter a name for the shift exception.
3. In the **Reason** field, enter the reason for adding the shift exception. This is an optional field.
4. In the **Repeats Until** field, enter the end date of the new exception. This is the date until which the exception is created. You can add a shift exception for only a day by leaving this field blank.

5. In the **Start Time** field, enter the start time of the new shift in the plant time zone.
6. In the **Duration** field, enter the duration of the new shift.
7. Click the **Save and Close** button.

Change Shift

Change shift exception type is used when you need to have a different start time or end time or both for an existing shift for one or more workdays. To change a shift, perform the following steps:

1. On the **Manage Production Calendar** page, in the calendar, click a specific date for which you want to create the shift exception. Ensure that you click inside the shift time that you want to change. Then, from the right-click menu or the **Actions** menu, select: **Create Shift Exception**.
2. On the **Manage Production Calendar page: Create Shift Exception** page, enter a name for the shift exception.
3. In the **Reason** field, enter the reason for adding the shift exception. This is an optional field.
4. In the **Repeats Until** field, enter the end date of the new exception. This is the date until which the exception is created. You can add a shift exception for only a day by leaving this field blank.
5. From the **Exception Type** list, select **Change Shift**.
6. In the **Start Time** field, enter a new time in the plant time zone if you want to change the start time of the shift.
7. In the **Duration** field, enter a new duration if you want to change the duration of the shift.
8. Click the **Save and Close** button.

Remove Shift

Remove Shift exception type is used when the plant does not need a shift for one or more workdays. To remove a shift, perform the following steps:

1. On the **Manage Production Calendar** page, in the calendar, click a specific date for which you want to create the shift exception. Ensure that you click inside the shift time that you want to change. Then, from the right-click menu or the **Actions** menu, select: **Create Shift Exception**.
2. On the **Manage Production Calendar page: Create Shift Exception** page, enter a name for the shift exception.
3. In the **Reason** field, enter the reason for adding the shift exception. This is an optional field.
4. In the **Repeats Until** field, enter the end date of the new exception. This is the date until which the exception is created. You can add a shift exception for only a day by leaving this field blank.
5. From the **Exception Type** list, select **Remove Shift**.
6. Click the **Save and Close** button.

Split Shift

Split Shift exception type is used when a break is required within an existing shift for one or more workdays. To split a shift, perform the following steps:

1. On the **Manage Production Calendar** page, in the calendar, click a specific date for which you want to create the shift exception. Ensure that you click inside the shift time that you want to change. Then, from the right-click menu or the **Actions** menu, select: **Create Shift Exception**.
2. On the **Manage Production Calendar page: Create Shift Exception** page, enter a name for the shift exception.
3. In the **Reason** field, enter the reason for adding the shift exception. This is an optional field.
4. In the **Repeats Until** field, enter the end date of the new exception. This is the date until which the exception is created. You can add a shift exception for only a day by leaving this field blank.
5. From the **Exception Type** list, select **Split Shift**.
6. In the **Start Time** field, enter a time in the plant time zone at which you want to start the break in the shift. This time cannot be the start time of the shift.
7. In the **Duration** field, enter the duration of the break. This is a required field.

You must ensure that the break time does not overlap with the start and end time of the shift

8. Click the **Save and Close** button.

Related Topics

- [How You Manage Production Calendars](#)
- [How You Manage Work Center Resource Calendars](#)
- [Create a Resource Exception](#)

How You Manage Work Center Resource Calendars

A resource exception is a change in the availability of units of a resource belonging to a work center. The exception is applicable to the specific work center resource only and doesn't affect the whole plant. You can't define resource exceptions for the resources that are 24 hours available. The exceptions created in the work center resource calendar overrides the shift exceptions created in the production calendar. The shifts and exceptions displayed in the work center resource calendar are interpreted in the plant time zone as defined in Manage Inventory Organization Parameters.

Manage Resource Exceptions

A resource exception is a collection of changes to one or more resources. The exception is applicable to one or many resources of the work center and doesn't affect the whole plant.

Example scenarios for such exception are:

- A few workers coming to work on a weekend to address a backlog.
- A few workers leaving the work on a workday to attend a mandatory training.

You use the **Manage Work Center Resource Calendar** page to perform the following tasks:

- Creating a resource exception
- Editing a resource exception
- Deleting a resource exception

The **Manage Work Center Resource Calendar** page can be accessed from the **Work Execution Overview** page and the **Edit Work Center** page.

Creating a Resource Exception:

You can create a resource exception to do the following:

- Add a new shift for one or more resources.
- Change the start time or duration of an existing shift for one or more resources. The start time entered on this page is assumed to be in the plant time zone.
- Change the resource availability in an existing shift.

Refer the [Create a Resource Exception: Worked Example](#) topic for instruction on creating the resource exceptions to achieve different results.

Editing a Resource Exception:

You can only edit a future resource exception. However, you can edit the end date of a current resource exception.

To edit a resource exception, perform the following steps:

1. On the **Manage Work Center Resource Calendar** page, click the resource exception in the calendar that you want to edit. Then, from the right-click menu or the **Actions** menu, select *Edit Resource Exception*.
2. On the **Manage Work Center Resource Calendar: Edit Work Center Resource Availability** page, edit the fields that you want to change.
3. Click the **Save and Close** button.

Deleting a Resource Exception

You can delete a future resource exception only. To delete a resource exception, on the **Manage Work Center Resource Calendar** page, click the resource exception in the calendar that you want to edit. Then, from the right-click menu or the **Actions** menu, select *Delete Resource Exception*.

Related Topics

- [How You Manage Work Center Resource Calendars](#)
- [How You Manage Production Calendars](#)
- [Create a Resource Exception](#)

Create a Resource Exception

You can create a resource exception in the work center resource calendar to fulfill the following requirements:

- Make a work center resource available
- Make few or all the units of a work center resource unavailable

The following examples illustrate steps to create a resource exception with respect to each of these two scenarios.

Make a Work Center Resource Available

When you want a work center resource to be available during a nonworking time such as duration outside a regular shift, you can create a resource exception. To create a resource exception for making a work center resource available, perform the following steps:

1. On the **Manage Work Center Resource Calendar** page, in the calendar, click a specific date for which you want to create the resource exception. Ensure that you click outside the existing shift time. Then, from the **Actions** menu, select *Create Resource Exception*.
2. On the **Manage Work Center Resource Calendar: Create Work Center Resource Availability** page, in the **Repeats Until** field, enter the end date of the new exception. This is the date until which the exception is created. You can add a work center resource exception for only a day by leaving this field blank.
3. In the **Start Time** field, enter the start time from which the resource availability is required to be changed. Ensure that the start time is a nonworking time for the resource and is defined in the plant time zone.
4. In the **Duration** field, enter the duration for the resource availability change. Ensure that the duration is such that the computed end time is also a nonworking time for the resource.
5. In the **Resource Availability and Overrides** region, the **Default Availability** column shows zero. In the **Availability Override** column, against the specific resource, enter the quantity of the resource units that you want to assign to the duration.

6. Click the **Save and Close** button.

Make Few or All the Units of a Work Center Resource Unavailable

When you want a work center resource to be either completely unavailable or some units of the resource to be unavailable during a working time such as a duration within a regular shift, you can create a resource exception. To make few or all the units of a work center resource unavailable, perform the following steps:

1. On the **Manage Work Center Resource Calendar** page, in the calendar, click a specific date for which you want to create the resource exception. Ensure that you click inside the shift time that you want to change. Then, from the right-click menu or the **Actions** menu, select **Create Resource Exception**.
2. On the **Manage Work Center Resource Calendar: Create Work Center Resource Availability** page, in the **Repeats Until** field, enter the end date of the new exception. This is the date until which the exception is created. You can add a work center resource exception for only a day by leaving this field blank.
3. In the **Start Time** field, enter the start time from which the resource availability is required to be changed. Ensure that the start time is a working time for the resource and is defined in the plant time zone.
4. In the **Duration** field, enter the duration for the resource availability change. Ensure that the duration is such that the computed end time is also a working time for the resource.
5. In the **Resource Availability and Overrides** region, the **Default Availability** column shows the number of resource units that are available for that specific shift. In the **Availability Override** column, against the specific resource, enter either zero to make the resource completely unavailable or a lesser number than the current number of resources available as displayed to make few units of the resource unavailable for the duration.
6. Click the **Save and Close** button.

Related Topics

- [How You Manage Work Center Resource Calendars](#)
- [How You Manage Production Calendars](#)
- [Create a Shift Exception](#)

Work Orders

Overview of Work Orders

A work order refers to a document that conveys the authority for the production of a specific product. It contains information about what, how to, how many, and when to manufacture a product. The product item, work definition details, operations, resources, components, quantities, and dates are specified in the work order. As a production supervisor, you can use the **Manage Work Orders** page to perform work execution tasks such as search, create, and update work orders. In addition, you can create user-defined statuses for work orders. The **Manage Work Order** page is designed for tablet-friendly user interfaces, and is optimized for a high resolution.

Some of the key features of discrete work orders are:

- Work orders are created by Supply Chain Orchestration as supplies for the following:
 - Planned orders from Planning Central
 - Sales orders for back-to-back ordered make items
 - Sales orders for configured items
 - Contract manufactured items

- Enables collaboration using Oracle Social Networking to communicate with stakeholders for better fulfillment of work order supply.
- Supports serialized manufacturing by previously assigning serials.
- Helps to prioritize work orders by reviewing sales order reservation details of the work order.
- Maintains work order and production transactions history for each work order, which can be viewed at any time.
- Work orders can be created and updated through cloud import framework using the .xism template.
- Enables collaboration using Oracle Social Networking to communicate with stakeholders for better fulfillment of work order supply.

Some of the key features of process work orders are:

- Supports multiple output items in a work order in the form of co-products and by-products.
- Supports scaling of work definition batch in the work order, based on changes in either batch quantity, input item quantity, or output item quantity.
- Maintains work order and production transactions history for each work order, which can be viewed at any time.
- Work orders can be created and updated through cloud import framework using the .xism template.
- Enables collaboration using Oracle Social Networking to communicate with stakeholders for better fulfillment of work order supply.

Search Work Orders

You can use the **Manage Work Orders** page to search for work orders to review or update. You can perform basic search using important attributes, such as Work Order, Item, Status, Start Date and Completion Date. You can also perform advanced search using additional criteria, such as work order Type, Subtype, Work Definition, Priority, Customer, Serial Number, Work Center, and so on. Additional attributes, such as Work Method, Process Name, Output Item, and Output Item Description have been added to make the search for process work orders more effective.

By default, search enables you to retrieve all work orders which start today and the next seven days, in predefined statuses such as Unreleased, Released, or On Hold and available user-defined statuses. You can personalize search criteria using the saved search feature, and set them as the default search if required. Work order records are presented in a tabular format with visual indicators to highlight past due work orders, and indicate work order progress. In process work orders, multiple outputs of a work order can be viewed in search results.

You can also personalize search criteria using source system fields such as source system type (values such as internal or external) and source system code.

Click the IoT Insights icon in the Manage Work Orders page to drill down to the work order view in IoT Production Monitoring to view work order details, factory-level metrics, and machine-level details. In the Manage Work Orders search results page and the Edit Work Order page History tab, you can drill down to the work order view in IoT Production Monitoring to gain insights into the actual production progress of the work order.

Note: For a work order, you can print Components List, Labels, or Work Order Traveler from the Manage Work Orders page.

Note: You can't query / search work orderless transactions on the Manage Work Orders page.

Create Work Orders

The Create Work Order page captures minimal mandatory information to quickly create work orders. You can create discrete work orders based on attributes such as Item, Work Order Status, Work Order Quantity, Start Date or Completion Date, Work Definition, and so on. You can also select a user-defined status to create work orders. You can only create standard process work orders based on either the process name or primary output item.

Update Work Orders

You can update the following work order details:

- Work order header attributes such as Quantity, Priority, and so on
- Reschedule the work order by updating the Start or Completion Dates
- Update the work order status to predefined or user-defined statuses
- Manage operations, material, and resource requirements
- Add or delete attachments
- Perform mass actions to update work order status or priority
- Capture values for descriptive flexfields

New attributes are displayed for process manufacturing work orders in the Process and Primary Output regions. You can optionally update the batch quantity or the primary output item quantity. Based on the update to one attribute, the other is recalculated.

Pick Materials for Work Orders

On the Manage Work Orders page, you can select one or more work orders and click Release to release them to the shop floor for production. You can also click Release and Pick Materials to directly initiate the scheduled process Pick Materials for Work Orders. A dialog box with the following picking parameters is displayed. The parameters are defaulted from the plant parameters.

- Pick Slip Grouping Rule, which is a required parameter
- Print pick slips
- Hours Ahead
- Hours Behind
- From Operation Sequence
- To Operation Sequence
- Pick a work order only if all eligible materials are available

You can integrate Oracle Manufacturing with Warehouse Management System to pick material for work orders and execute movement requests in WMS. For more information about picking of materials for work orders refer to the Using Inventory Management guide.

Note: Pick Slip Grouping Rule, and Print pick slips parameters are not applicable if Oracle Manufacturing is integrated with Warehouse Management system.

This dialog box is also displayed when you click the **Release and Pick Materials** action on the Manage Material Availability Assignments page to initiate the scheduled process. You can review and update the parameters as required and click OK to start the process.

This will ensure that a movement request is created for materials to be either directly issued to the work order from inventory or to be transferred to a destination subinventory from where it can be used. You can take this action for work orders that are in released status so that materials are available on the shop floor during production.

You can also route the pick slip report to the output devices such as fax, printer, and email, based on the plant parameters defined up in the Manage Inventory Document Output Preferences task in Inventory. You can configure these output devices through the Manage Inventory Document Output preferences inventory task for the Pick Materials for Work Orders scheduled process.

For more information about picking of materials for work orders refer to the How You Pick Materials for Work Orders topic in this guide.

Note: You can manage work orders using a REST API. However, you can't add, update, or delete attachments of a work order, operations, materials, and resources using a REST API.

Attachments

Attachments for work order entity can be used to readily access files such as work instructions, drawings, checklists, standard operating procedures, and so on. Work orders support attachments at the following levels:

- Work Order Header
- Operations
- Operation Items
- Operation Resources
- Operation Output (applicable only for process work orders)

During work order creation, if a work definition is specified, all attachments from the work definition which correspond to the earlier mentioned levels are copied into the work order. When a standard operation is added to the work order, the operation and operation resource level attachments are copied to the work order. Once the attachments are copied, they reside independently within the work order. You can add more attachments, or delete existing attachments as required.

Attachments belonging to the Miscellaneous category are always displayed by default. However, other user-defined attachment categories may be configured and displayed based on the security setup. Security can be enabled using the standard attachment security framework provided in the Setup and Maintenance work area and the Security Console.

Descriptive Flexfields

Descriptive flexfields enable you to configure the work order entity to capture additional information. Work orders support descriptive flexfields to capture user-defined data for the following levels:

- Work Order Header
- Operations
- Operation Items
- Operation Resources
- Operation Output (applicable only for process work orders)

Descriptive flexfields if enabled are available as Additional information in the user interface. You can also manage descriptive flexfields through work order import.

Social Collaboration

Work orders are enabled for social collaboration using Oracle Social Network. The production supervisor can use this framework to collaborate with stakeholders. You can enable the following attributes for the work order object, so that it's shared on the OSN object wall and the subsequent streaming updates.

- Work Order Number

- Start Date
- Completion Date
- Item
- Item Description
- Quantity
- Unit of Measure (UOM)
- Status
- Actual Completion Date
- Customer

IoT Production Monitoring Integration at Work Order Level

Internet of Things (IoT) Production Monitoring can be deployed in manufacturing environments to monitor production flow and equipment health.

You can drill down from a specific work order in Manufacturing to view a KPI dashboard and digital twin simulation of the real time and predicted status of a work order or equipment in IoT Production Monitoring. Quick access from Manufacturing to IoT Production Monitoring insights is provided in multiple pages:

- Manage Work Orders page
- Edit Work Order page, in the History tab

With anomaly detection and predictive analytics of IoT Production Monitoring, you can decide what actions to take in Manufacturing or IoT Production Monitoring. Using the IoT Insights button provided in the Manage Work Orders page, drill down to the work order view in IoT Production Monitoring to view work order details, factory-level metrics, and machine-level details.

Related Topics

- [Overview of Work Definitions](#)
- [Overview of Production Execution Tasks](#)

Overview of Standard Work Orders

Standard work orders are used as a means to initiate regular production. It is a type of work order and always has a work definition. When a user creates a standard work order, the automatic pre-selection logic is used to derive the work definition name and version based on the item, and the date specified on the work order. You can create standard work orders in both discrete and process manufacturing based on the work method.

A standard work order is created quickly with minimal header details. On saving the work order record, the application automatically does the following:

- For the specified work definition, the work definition explosion logic is used to determine the work order material and resource requirements for all the operations.
- Using the scheduling logic, the work order, operation, material and resource dates are determined.

If the plant parameter is enabled for process manufacturing, you can optionally set the default work method to process manufacturing. There are two ways to create a standard process work order, based on the Process Name or Primary Output.

Related Topics

- [Overview of Work Orders](#)
- [Create Standard Discrete Work Orders](#)

Create Standard Discrete Work Orders

You can create a standard work order for discrete or process manufacturing based on the work method. The standard discrete work order is created in the following sequence in the user interface:

1. Specify the Work Method. In this case, select Discrete Manufacturing option instead of Process Manufacturing. Selection of the Work Method is applicable only if the organization is enabled for both discrete and process manufacturing.
2. Specify the item to be manufactured. A primary work definition must exist for the item to create a standard work order.
3. Specify the work order quantity. This will always be in the primary unit of measure of the item.
4. The work order start date is by default the current date and time. You can update the field if required. If the work order is created by specifying the start date, the application automatically performs a forward scheduling to calculate the rest of the dates.

Note: You can create a standard discrete work order by specifying this minimal information. The application selects the primary work definition of the item to explode the operation, material and resource requirements into the work order and perform scheduling to compute the rest of the dates of the work order. All other information required for the creation of work order is automatically derived in the background, and the standard discrete work order is created in Unreleased status.

Tip: To create a standard discrete work order with additional details, click the **Show More** link.

5. Optionally, you can enter a work order number manually. The application automatically generates a unique work order number if you don't enter the number.
6. If you enter the completion date of the work order, the start date of the work order is blanked out. When the work order is saved, the application performs a backward scheduling from the completion date to calculate the rest of the dates.
7. The primary work definition is selected by default and displayed in the user interface. You can select an alternate work definition, if available.
8. Work definition date is displayed by default from either the start or completion date, as provided by the user. You can modify the work definition date to a specific date, if it's required to select the corresponding version of the work definition.
9. On selecting the work definition name and work definition date, the work definition version and the item structure details such as item structure name, revision, and version are automatically displayed on the user interface.
10. Status field is by default Unreleased. You can also select predefined statuses, such as Released or On Hold status or any user-defined status for the work order to be created in the specified status.
11. Optionally, you can specify the work order description and work order subtype.

Note: When you save the work order with this additional information, the application uses the specified work definition of the item to explode the operation, material, and resource requirements into the work order, and perform scheduling to compute the rest of the dates of the work order.

Tip: Attachments are copied over from the work definition to the work order. All other information required for the creation of work order is automatically derived in the background.

Related Topics

- [Overview of Work Orders](#)
- [Overview of the Work Definition Work Area](#)

Create Standard Process Work Orders

You can create a standard work order for discrete or process manufacturing based on the work method. If the plant parameter is enabled for process manufacturing, you can optionally set the default work method to process manufacturing. There are two methods to create a standard work order for process manufacturing. First method is based on the Process Name and the second method is Primary Output. The Process Name is a unique identifier for a specific process manufacturing work definition that can produce multiple outputs.

If the organization is enabled for both discrete and process manufacturing, you will have the choice of both work methods. The standard process work order is created in the following sequence in the user interface:

1. Specify the Work Method. In this case, select Process Manufacturing option instead of Discrete Manufacturing.
2. Specify the Creation Basis. It can be either Process Name or Primary Output. Currently, use the Process Name as the default attribute.
3. If you enter a Process Name value, the Batch Quantity and UOM will be automatically defaulted. Also, the work definition details are selected. You can optionally update the Batch Quantity.
4. If you specify Primary Output, the Primary Output Quantity and UOM will be defaulted based on the Process Name that is selected. The Process Name is selected based on the lowest production priority. You can search and select another process name.
5. Start Date: The work order start date is by default the current date and time. You can update the field if required. If the work order is created by specifying the start date, the application automatically performs a forward scheduling to calculate the rest of the dates.
6. You can now save the standard process work order.

Note: To create a standard process work order with additional details, click the **Show More** link. You will also find primary output details and work definition details when you click this link.

Overview of Phantom Explosion in Work Orders

A phantom represents a product that is physically built but not stocked, before being used in the next stage or level of manufacturing. It is a method to move around a group of components having the same item name. When you create a work definition for a parent product item, you can specify the supply type of a component as phantom. You can define work definitions for phantoms in the same way as any other product items.

During the creation of a work order which references a work definition, the following happens:

- The application selects the appropriate work definition version based on the work definition date specified and explodes the work definition by copying its operations, resources and component items.

- When a component item with phantom supply is required for an operation, the application looks for a work definition for the phantom item, explodes the same by copying its constituent components and resources to the same operation.
- The action of whether only components or both components and resources must be inherited is determined by the plant parameter **Phantom Operation Inheritance**.
- If multiple levels of phantoms are encountered during the explosion process, the application keeps exploding though all levels until no further child phantoms are encountered.
- At any level, if the explosion process does not find a work definition for a phantom, it uses the item structure to explode that phantom level and its lower levels. If an item structure is also not defined for a phantom item, further explosion is not performed for that node.

Note: Phantom assemblies act like normal assemblies when they represent a top-level assembly, such as when you create a work order on it. However, as a subassembly, they lose their identity as distinct assemblies, and are a collection of their components and resources.

Note: The same item can be used in a phantom supply in certain work definitions and a regular stock component in other work definitions.

Phantom Explosion in Process Manufacturing

The phantom explosion in process manufacturing adheres to the following business rules:

- During explosion of a phantom input item, the application restricts to Process Manufacturing work method with no mingling of Discrete Manufacturing and Process Manufacturing work methods.
- Components and resources are inherited to the same operation as phantom input item honors plant parameter for phantom operation inheritance, but ignores multiple output items from the phantom work definition.
- Considers phantom item structures if no phantom work definition exists
- In case of phantom within a phantom, if structure is considered, the work definitions will not be considered again and the explosion continues based only on the structure.

Related Topics

- [Overview of Standard Work Orders](#)
- [Create Standard Discrete Work Orders](#)

How Work Orders are Scheduled

Oracle Manufacturing uses unconstrained scheduling engine in the background to schedule work orders during create and certain update actions. In addition, the scheduling engine is also used to compute the manufacturing lead time of a product based on its primary work definition.

The scheduling engine uses the information provided at the resource definition, work order operation resource level and the resource's calendar to determine the resource's start date and completion date for in-house operations. While scheduling work orders, resources are assumed to have infinite capacity and the scheduling engine disregards loads on the resources from other work orders. It rolls up the resource dates to determine the start and completion dates of each in-house operation. For supplier operations, the scheduling engine uses the lead time information specified at the operation level to calculate the start and completion date of the operation. Eventually the operation dates are

rolled up to determine the work order dates. The required date of the operation items are updated to the start date of its operation. The following types of scheduling methods are supported by the scheduling engine:

- Forward Scheduling
- Backward Scheduling
- Midpoint Scheduling

Forward Scheduling: When a work order is forward scheduled, the scheduling engine uses the start date of the work order as an input to determine the start and completion dates for each scheduled resource (for in-house operations), the start and completion dates for each operation and eventually the completion date of the work order. The application automatically performs forward scheduling when the start date of a work order is provided. Forward scheduling is also used by the lead time calculation program to determine the manufacturing lead time of the product.

Backward Scheduling: When a work order is backward scheduled, the scheduling engine uses the completion date of the work order as an input to determine the start and completion dates for each scheduled resource (for in-house operations), the start and completion dates for each operation and eventually the start date of the work order. The application automatically performs backward scheduling when the completion date of a work order is provided.

Midpoint Scheduling: When a work order is midpoint scheduled, the user selects an operation to perform midpoint scheduling by specifying either the operation start date or the operation completion date. If Midpoint scheduling is performed from the operation start date, all the prior operations are backward scheduled while the selected operation and succeeding operations are forward scheduled. If Midpoint scheduling is performed from the operation completion date, all resources of the prior operations and the selected operation are backward scheduled while the succeeding operations are forward scheduled.

The following actions trigger scheduling or rescheduling of work orders:

- **Create Work Orders:** When work definition is specified, application automatically performs either forward or backward scheduling depending on whether start date or completion date is provided.
- **Update Work Order - Start Date or Completion Date:** Updating one of these date nulls out the other and application automatically performs either forward or backward scheduling.
- **Update Work Order - Work Definition name or Work Definition Date or Work Order Quantity:** Updating any of these fields on the work order triggers the application to prompt forward scheduling or backward scheduling method to reschedule the work order.

The following attributes influence the scheduling behavior:

- **Quantity:** The work order quantity influences the scheduled duration of a work order.

For discrete manufacturing, the work order quantity is considered for calculation of the work order operation resource dates when the resource's Basis Type is Variable.

For process manufacturing, the work order batch quantity is considered for calculation of the work order operation resource dates by scaling the work order operation resource usage from its work definition batch when its Basis Type is Variable.

For manufacturing lead time calculation of an item using discrete manufacturing work method, the lot size specified in the item definition is considered.

For manufacturing lead time calculation of an item using process manufacturing work method, the output quantity of the standard batch defined in the primary work definition is considered.

- **Work Order Start Date or Completion Date:** Serves as the anchor point to perform forward or backward scheduling.

- **Work Order Operation / Execution Sequence:** Scheduling engine considers the operation sequence to schedule the operations and its resources. However, in the case of released work orders with resequenceable operations, the execution sequence will be considered instead of the operation sequence.
- **Work Order Operation Start Date or Completion Date:** Serves as the anchor point to perform midpoint scheduling.
- **Work Order Operation Resources Sequence Number:** Resources which have unique sequence numbers within an operation are scheduled sequentially in the ascending order. Resources which share a common sequence number within an operation are considered as simultaneous resources and are scheduled in parallel.
- **Work Order Operation Resources Name:** Used by the scheduling engine to determine the work center resource calendar to schedule the resources.
- **Work Order Operation Resources - Required Usage:** Used by the scheduling engine to schedule the resource duration.
- **Work Order Operation Resources - UOM:** Used by the scheduling engine to schedule the resource duration. The resource usage is converted from the specified unit of measure to the scheduling unit of measure using the profile Hour Unit of Measure (ORA_RCS_HOUR_UOM). The UOM set in this profile must belong to the UOM class specified in the other profile SCM Common: Default Service Duration Class (RCS_DEFAULT_UOM_CLASS_CODE_FOR_SVC_DURATION). For any scheduled resource, it's recommended that this profile be set to a UOM class that represents units of measure for Time.
- **Work Order Operation Resources - Scheduled Indicator:** Resources which have Scheduled = Yes are considered by the scheduling engine to compute the duration of the resource. The resources which have Scheduled = No aren't scheduled and assumed to have the zero duration, such that the resource's planned start date = planned completion date. For the resources that have Scheduled = No or defined with zero duration, work order scheduling doesn't consider the calendar work times.
- **Work Order Operation Resources - Assigned Units:** The required usage of the resource is divided by the assigned units to compute the scheduled duration of the resource.
- **Work Center Resources - Available 24 Hours Indicator:** Resources which have this indicator set to **No** are scheduled within the shifts associated with it. Resources which have this indicator set to **Yes**, are assumed to be available 24 hours.
- **Work Center Resources - Efficiency and Utilization Percentages:** The scheduling engine inflates the required usage of a resource if its efficiency and, or utilization percentages are less than 100%.
- **Work Center Resources - Shift Assignments:** Scheduling engine considers the availability of resources based on the shifts assigned to the work center resource. In the case of work centers with override calendars, the scheduling is based on the availability of resources of the override calendar that's effective for the scheduling date.
- **Work Center Resource Availability:** Scheduling engine considers the shift exceptions and work center resource exceptions to determine the availability of resources within shifts assigned to it.
- **Work Center Override Calendars:** In the case of work centers with override calendars, the scheduling is based on the availability of resources of the override calendar that's effective for the scheduling date.
- **Supplier Operation Lead Time Attributes:** For supplier operations the scheduling engine uses the Fixed Lead Time, Variable Lead Time, and Lead Time UOM information provided at the operation level to calculate the start and completion dates of the operation. In the case of work centers with override calendars, the scheduling of supplier operations is based on plant calendar only.
- **Maximum Scheduling Duration in Months:** Scheduling engine considers this plant parameter setting to determine the maximum allowed scheduling duration for a work order when its created or updated.
- **Plant Time zone:** The plant time zone represents the time zone where the plant is geographically located and its identified by the setting in Manage Organization Parameters using the FSM task Manage Inventory

Organizations. The shifts and its timings defined for the calendar associated to the manufacturing plant is interpreted in this plant time zone. Scheduling of work orders are carried out in this time zone.

- **User Time zone:** Though this time zone doesn't influence the scheduling logic, it influences the value displayed in the date time fields on the work order. This plant parameter should be set to the time zone of the user accessing the Manufacturing application by navigating to Set Preferences and then Regional.

The following scenarios list some of the errors when scheduling a work order:

- **Work center resources without shift assignments:** When a work center resource isn't a 24 hour resource and isn't assigned to any of the shifts of the production calendar, then the scheduling engine can't derive the availability of this resource and hence will error out. The most likely cause for such as situation is when you associate a new calendar to the plant in Manage Plant Parameters task and forget to reassign the existing work center resources to the new shifts.
- **Plant calendar effective dates aren't enough:** If the work order quantity is such that the sum of resource duration of all operations are computed to be larger than the calendar effective dates, then scheduling will error out. For example, when a user manually creates a work order by specifying a start date and a large work order quantity, the calendar's effective end date should be greater than the work order completion date calculated based on the work order's resource duration. Likewise, when Supply Planning creates a work order by specifying the completion date, the calendar effective start date must be lesser than the work order start date calculated based on the work order's resource duration.
- **Plant parameter of maximum scheduling duration is violated:** Scheduling will error out if the computed duration of the work order is greater than the parameter value set for the Maximum Scheduling Duration in months in Manage Plant Parameter.

Schedule Work Orders Manually

Now, you can manually schedule or reschedule manufacturing work orders based on the scheduling method that you select on the user interface.

You can create work orders manually or through supply chain planning, or maintenance programs using the scheduling method value as default scheduling. The work orders are always scheduled automatically with no gap or overlap using the user interface. However, you can now schedule work orders manually to enable gap or overlap between operations or resource when you select the scheduling method value as user or external scheduling.

You can perform the following when you schedule the work orders manually:

- Select the work order scheduling method
- Schedule work orders manually
 - Manual update of work order attributes
 - Manual update of work order start and completion dates
 - Manual update of work order operation start and completion dates
 - Manual update of work order resource start and completion dates

Select the work order scheduling method

The scheduling method is displayed at the work order header for work orders. You can select one of the following two values:

- Default Scheduling
This scheduling method is the default option when a work order is created through the user interface.
- User or External Scheduling

When you select this scheduling method, you can schedule or reschedule the work order manually by updating the work order dates, operation dates, and resources dates. Also, the firm check box is automatically selected, and you can optionally deselect the firm flag.

Schedule work orders manually

- Manual update of work order attributes

If you update the work order quantity, then the work order isn't rescheduled. However, the material and resource requirements are recalculated.

If you update the work definition name or date, then the scheduling method is automatically updated as default scheduling and the work order is automatically scheduled. The work order is re-exploded with the details of the new work definition.

- Manual update of work order start and completion dates

You can use this scheduling method only in the user interface. However, the FBDI and REST services continue to work with the default scheduling method.

- Manual update of work order operation start and completion dates

You can manually update the start and completion dates of the work order operations. The unconstrained scheduling won't be invoked if your scheduling method is **User or External Scheduling**. However, the work order start and completion dates gets synchronized with the earliest operation start date and the latest completion date, if they are outside the work order start and completion date.

- Manual update of work order resource start and completion dates

You can manually update the start and completion dates of the work order resources. The unconstrained scheduling won't be invoked if your scheduling method is **User or External Scheduling**. However, the work order operation start and completion dates and the work order start and completion dates gets synchronized with the earliest resource start date and the latest resource completion date, if they are outside the work order or operation dates.

During work order execution, if you resequence the operation, then the work order wouldn't be automatically scheduled if the scheduling method is **User or External Scheduling**.

Oracle Fusion Cloud Supply Planning, including Production Scheduling will consider manually scheduled work orders during scheduling. If Oracle Supply Planning, including Production Scheduling update the work order dates, Oracle Fusion Cloud Manufacturing will honor the recommendations.

Related Topics

- [How You Update a Work Order](#)
- [Overview of Phantom Explosion in Work Orders](#)

Example of Work Order Scheduling

Work order scheduling behavior for in-house operations and the various scheduling methods are explained using the following example. A plant works continuously in a single 9 hour shift from 8:00 a.m. to 5:00 p.m. on all days of a week. This shift time is interpreted in the plant time zone.

The following table explains a scenario where different resources are available in the plant to manufacture a product **A** and lists the efficiency percentage, utilization percentage and availability of each resource:

Work Center	Resource Name	Efficiency Percentage	Utilization Percentage	Available 24 Hours
Machine Shop	CNC Milling	100%	50%	No
	Technician	100%	100%	No
	QA Inspector	100%	100%	No
Assembly Line	Operator	100%	100%	No
	Conveyor Line	100%		
Packing Line	Auto Packer	50%	100%	Yes

All the **Conveyor Line** resources belonging to **Assembly Line** work center are unavailable on day 2 from 9:00 am to 11:00 am due to the monthly preventive maintenance schedule. To reflect this in the application, the supervisor defines a work center resource exception.

To manufacture a quantity of **8** each of a product **A**, the following operations of a work order are used:

Work Order123, with **Operation** 10: Machining, and **Work Center** Machine Shop.

The following table lists the details of three different resources:

Sequence	Resource Name	Required Usage	UOM	Assigned Units	Scheduled
10	CNC Milling	2	Hours	1	Yes
20	Technician	2	Hours	2	Yes
30	QA Inspector	1	Hours	1	No

Work Order 123, with **Operation** 20: Assembly, and **Work Center** Assembly Line.

The following table lists the details of two different resources:

Sequence	Resource Name	Required Usage	UOM	Assigned Units	Scheduled
10	Operator	4	Hours	1	Yes
10	Conveyor Line	4	Hours	2	Yes

Work Order 123, with Operation 30: Packing, and Work Center Packing Line.

The following table lists the details of one resource:

Sequence	Resource Name	Required Usage	UOM	Assigned Units	Scheduled
10	Auto Packer	1	Hours	1	Yes

1. During the scheduling process, the application computes the duration of a resource in the following manner:

$$\text{Resource duration} = \frac{(\text{Required usage} / \text{Assigned units})}{(\text{Resource Efficiency \%} * \text{Resource Utilization \%})}$$

2. In operation 10, the resource **CNC Milling** has a utilization of 50%. This has an effect of extending the usage of this resource by twice its required usage.
3. In operation 10, since the resource sequence number of the resources is different, the resources are scheduled sequentially. In operation 20, since the resources share the same resource sequence number, the resources are scheduled in parallel.
4. The **Conveyor** resource used in operation 20 is unavailable for 2 hours on day two, and so the application does not schedule this resource during that period.
5. In operation 30, the resource **Auto Packer** has an efficiency of 50%. This has an effect of extending the usage of this resource by twice its required usage.
6. The resource **Auto Packer** is available 24 hours and so its resource usage is done even if it is outside the plant shift duration.

Forward Scheduling

If the work order is created using the start date of day 1 at 8:00 a.m., the application forward schedules the work order and computes the completion date as day 1 at 7:00 p.m. The resource duration is displayed in the following chart:

The following figure shows Forward Scheduling with six resources:

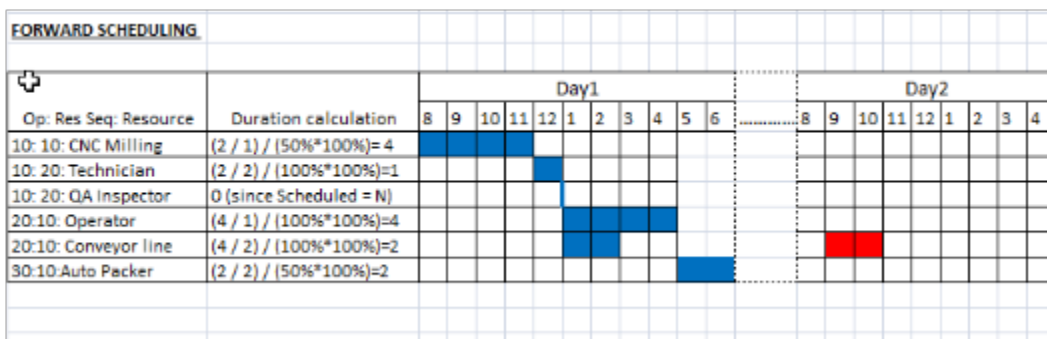

If the work order is created using the start date of day 1 at 8:00 a.m., the application forward schedules the work order and computes the completion date as day 1 at 7:00 p.m.

The following table presents the information that has been explained diagrammatically for Forward Scheduling:

Operation Sequence	Resource Sequence	Resource Name	Resource Duration	Scheduled Dates With Explanation
10	10	CNC Milling	$(2/1) / (50\% * 100\%) = 4$ hours	Forward Scheduling logic is applied from the first resource of the first operation. The first operation is the Machining operation. Since the work order is being requested to start at 8:00 a.m., the first resource required for this operation is CNC Milling with required resource duration of 4 hours. The CNC Milling resource is scheduled from 8:00 a.m. to 12:00 noon.
10	20	Technician	$(2/2) / (100\% * 100\%) = 1$ hour	The Technician performing the task after CNC Milling resource is scheduled from 12:00 noon to 1:00 p.m.
10	20	QA Inspector	0 hours (Since Scheduled=N)	The QA Inspector has no duration but shares the same resource sequence as the Technician, so the scheduled start and end time is 1:00 p.m.
20	10	Operator	$(4/1) / (100\% * 100\%) = 4$ hours	The next operation is the Assembly operation. The Operator takes 4 hours to complete the task and is scheduled from 1:00 p.m. to 5:00 p.m.
20	10	Conveyor Line	$(4/2) / (100\% * 100\%) = 2$ hours	The Conveyor Line resource is used in Assembly operation and is scheduled to start in parallel with the Operator. So the conveyor line operation starts at 1:00 p.m. and ends at 3:00 p.m.
30	10	Auto Packer	$(2/2) / (50\% * 100\%) = 2$ hours	The Packing operation starts after Assembly operation at 5:00 p.m. and ends at 7:00 p.m. With this, the work order is completed.

Operation Sequence	Resource Sequence	Resource Name	Resource Duration	Scheduled Dates With Explanation

Backward Scheduling

If the work order is created using the completion date of day 2 at 1:00 p.m., the application backward schedules the work order and computes the start date as day 1 at 9:00 a.m. The resource duration is displayed in the following chart:

The following figure shows Backward Scheduling with six resources:

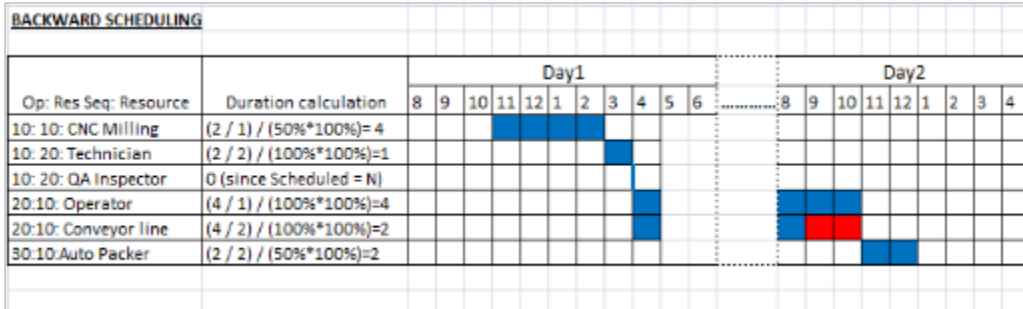

If the work order is created using the completion date of day 2 at 1:00 p.m., the application backward schedules the work order and computes the start date as day at 11:00 a.m.

The following table presents the information that has been explained diagrammatically for Backward Scheduling:

Operation Sequence	Resource Sequence	Resource Name	Resource Duration	Scheduled Dates With Explanation
30	10	Auto Packer	$(2/2) / (50\% * 100\%) = 2$ hours	Backward Scheduling logic is applied and we start with the last resource of the last operation and compute the start date by scheduling operations in a reverse sequence of forward scheduling. Since the work order is being requested to be completed on day 2 1:00 p.m., and the Auto Packer resource requires 2 hours, Packing operation starts on day 2 at 11:00 a.m. and ends at 1:00 p.m.
20	10	Conveyor Line	$(4/2) / (100\% * 100\%) = 2$ hours	Next the prior operation Assembly is scheduled. The Conveyor Line resource used in this operation is unavailable for 2 hours on day 2 from 9:00 a.m. to 11:00 a.m., and so the application does not schedule this resource during that period. The

Operation Sequence	Resource Sequence	Resource Name	Resource Duration	Scheduled Dates With Explanation
				Conveyor Line resource is used in Assembly operation and is scheduled from 8:00 a.m to 9:00 a.m. on day 2, and 4:00 p.m. to 5:00 p.m. on day 1.
20	10	Operator	$(4/1) / (100\% * 100\%) = 4$ hours	The Operator working in the Assembly operation takes 4 hours to complete the task and is scheduled from 8:00 a.m. to 11:00 a.m. on day 2, and 4:00 p.m. to 5:00 p.m. on day 1.
10	20	QA Inspector	0 hours (Since Scheduled=N)	The QA Inspector has no duration but shares the same resource sequence as the Technician, so the scheduled start and end times is 4:00 p.m. on day 1.
10	20	Technician	$(2/2) / (100\% * 100\%) = 1$ hour	The Technician performing the Machining operation is scheduled from 3:00 p.m. to 4:00 p.m. on day 1.
10	10	CNC Milling	$(2/1) / (50\% * 100\%) = 4$ hours	CNC Milling requires 4 hours and is scheduled from 11:00 a.m. to 3:00 p.m. on Day 1 based on Backward Scheduling. So, the work order starts on day 1 at 11:00 a.m.

Midpoint Scheduling

If the work order is updated by invoking midpoint scheduling of work order operation 20 such that the operation 20 starts on day 2 at 11:00 am, the application performs midpoint scheduling as displayed in the following chart, such that the work order's start date is day 1 at 3:00 p.m. and completion date is day 2 at 5:00 p.m.

The following figure shows Midpoint Scheduling with six resources:

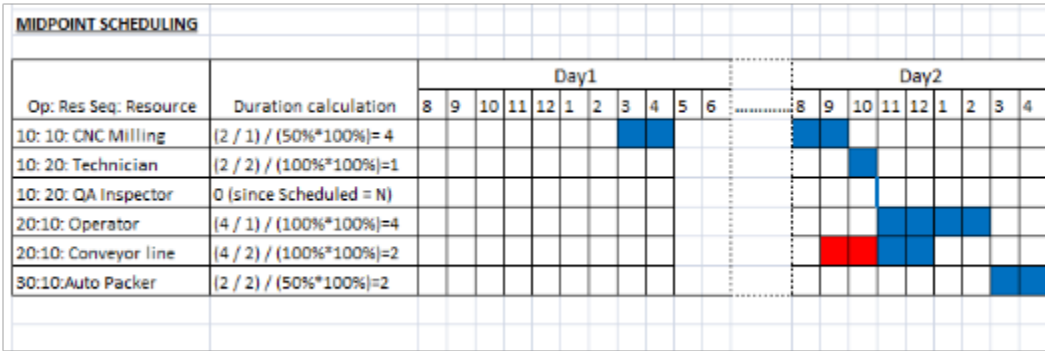

If the work order is updated by invoking midpoint scheduling of work order operation 20 such that the operation 20 starts on day 2 at 11:00 am, the application performs midpoint scheduling as displayed in the following chart, such that the work order's start date is day 1 at 3:00 p.m. and completion date is day 2 at 5:00 p.m.

The following table presents the information that has been explained diagrammatically for Midpoint Scheduling:

Operation Sequence	Resource Sequence	Resource Name	Resource Duration	Scheduled Dates With Explanation
20	10	Operator	$(4/1) / (100%*100%) = 4$ hours	Invoking Midpoint Scheduling of work order operation 20, such that operation 20 starts on day 2 at 11:00 a.m. The Operator takes 4 hours to complete the task and is scheduled from 11:00 a.m. to 3:00 p.m. on day 2.
20	10	Conveyor Line	$(4/2) / (100%*100%) = 2$ hours	All downstream operations are scheduled using Forward Scheduling logic. So, the Conveyor Line resource is used in Assembly operation from 11:00 a.m. to 1:00 p.m. on day 2.
30	10	Auto Packer	$(2/2) / (50%*100%) = 2$ hours	The Packing operation starts on day 2 at 3:00 p.m. and ends at 5:00 p.m. With this the work order is completed.
10	20	QA Inspector	0 hours (Since Scheduled=N)	All upstream operations are scheduled using Backward Scheduling logic. So, the QA Inspector has no duration but shares the same resource sequence as the Technician, so the scheduled start and end times is 11:00 a.m. on day 2.

Operation Sequence	Resource Sequence	Resource Name	Resource Duration	Scheduled Dates With Explanation
10	20	Technician	(2/2)/ (100% *100%) = 1 hour	Invoking Backward Scheduling, the Technician performing the Machining operation is scheduled from 10:00 a.m. to 11:00 a.m. on day 2.
10	10	CNC Milling	(2/1)/ (50% *100%) = 4 hours	The Technician shift time ends at 11:00 a.m. on day 2. The resource duration required is 4 hours. The CNC Milling resource shift is scheduled from 8:00 a.m. to 10:00 a.m. on day 2 and from 3:00 p.m. to 5:00 p.m. on day 1. This determines the work order start day as day 1 at 3:00 p.m.

Related Topics

- [How Work Orders are Scheduled](#)
- [Create Standard Discrete Work Orders](#)

Overview of Nonstandard Work Orders

Nonstandard work orders are used to initiate rework, repair, prototype work, and other non-regular production activities. It is a type of work order and can be created with or without a work definition. If a work definition is referred, the behavior is same as that of the standard work order. The nonstandard work order is created in Unreleased or On Hold status, if the work definition isn't specified. The next step is to add operations, components, and resources for the operations. After an operation is added to the work order, the work order can be released.

Note: Nonstandard work orders are currently available for only the discrete manufacturing work method.

Related Topics

- [Overview of Work Orders](#)
- [Create Nonstandard Work Orders](#)
- [Create Standard Discrete Work Orders](#)

Create Nonstandard Work Orders

The nonstandard work order is created in the following sequence using the user interface:

1. Optionally, you can enter a work order number manually. The application automatically generates a unique work order number if this is not provided.
2. Specify the item to be manufactured. A work definition need not exist for this item.
3. Specify the work order quantity. This will always be in the primary unit of measure of the item.
4. A work definition is not selected by default, and the valid work definitions are available for you to select.
5. The work order start date is by default the current date and time. You can update the field if required. If a work definition is specified, you must provide either a start date or completion date. If a work definition is not specified, you can provide both the start date and completion date.
6. Status field is by default Unreleased. If a work definition is specified, you can create the work order in Unreleased, Released or On Hold status. If a work definition is not specified, but you can create the work order only in Unreleased or On Hold status.
7. If a work definition is specified, the work definition date is displayed by default from the start or completion date fields, as provided earlier. You can modify the work definition date to a specific date, if it is required to select the corresponding version of the work definition.
8. On selecting the work definition name and work definition date, the work definition version and the item structure details such as item structure name, revision and version are automatically defaulted on the user interface.
9. Optionally, you can specify the work order description and work order subtype.

When the work order is saved, the following behaviors are applicable:

- If work definition is specified, the application uses the specified work definition of the item to explode the operation, material and resource requirements into the work order and perform scheduling to compute the rest of the dates of the work order. Attachments are copied over from the work definition to the work order. All other information required for the creation of work order is automatically derived in the background.
- If work definition is not specified, the application saves only the work order header. You can update the work order to add operations, resources, and items manually. At least one operation must be added to release the work order.

Note: If a work definition is specified, the behavior of the nonstandard work order is similar to the standard work order.

Related Topics

- [Overview of Standard Work Orders](#)
- [Overview of Nonstandard Work Orders](#)
- [Create Nonstandard Work Orders](#)

Overview of Rework Work Orders

Oracle Manufacturing provides you with additional options in scenarios where the finished item must be reworked.

A rework work order is created in Manufacturing, where a defective assembly from inventory is issued to that work order, and rework operations are executed on the shop floor. The component that's defective is removed from the assembly and replaced with a new component. For example, the defective battery of a mobile phone is replaced with a new battery, returning it to working condition. Then, the reworked assembly is completed in inventory as a finished item.

As a production supervisor, or as a production operator, here's what you can do in a rework work order:

- Create rework work order with or without specifying a rework work definition.
- Specify a **negative quantity** for work order operation items. You can specify the same item in two item sequences, such as a sequence with a positive quantity, and a sequence with a negative quantity.

You can execute rework work order in one of two ways:

- By manually issuing the assembly item to a rework work order.
- By automatically issuing to the first operation of the work order when it's released.

Here's an illustration of the Rework work order process flow:

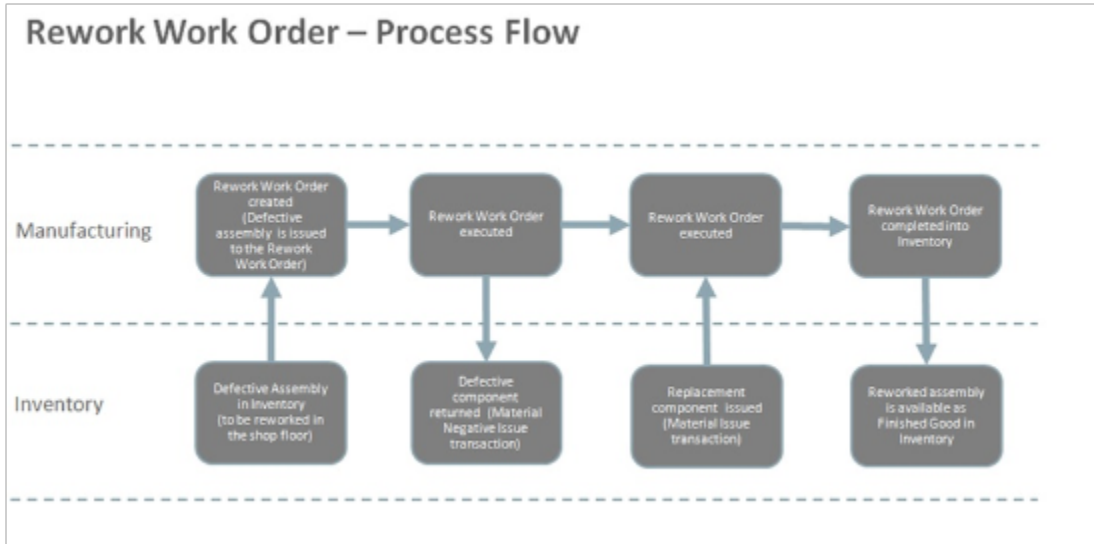

The process flow diagram for a Rework work order shows how a defective assembly in inventory can be reworked on the manufacturing shop floor, completed as a finished good, and returned to inventory after rectifying the defect.

You can rectify the defect by removing a defective component and by replacing it.

Here's what the Rework work order enables in material transactions:

- Supports material-negative issue transactions to transact items with negative quantities.
- Enables transact ad hoc items with negative quantity in material transactions.

Note: Using FBDI (.xslm) templates (similar to the importing standard and nonstandard work orders), you can import Rework work orders. For Rework work orders, the sheets added are to denote Assembly Item, Material Lot, and Material Serial.

Note: Rework work orders are currently available for only the discrete manufacturing work method.

Related Topics

- [How You Rework a Work Order](#)
- [Overview of Transform Work Orders](#)
- [How You Create a Transform Work Order](#)

How You Rework a Work Order

You can create a rework order in manufacturing. Use the Work Definition and Work Execution work areas to do this.

Work Order

As a production supervisor, here's how you create a Rework work order:

1. Select the specific work order type.
2. Create the new Rework work order.
3. Select one of the displayed valid Rework work definitions defined for the item.
4. (Optional) Create a Rework work order without a work definition.

Based on your organization's plant parameter **Manually issue assembly to rework work order**, you can choose to execute a rework work order in one of two ways:

- **Automatic:** When the plant parameter is disabled.
The current subinventory is the subinventory from where the rework item is automatically issued to the first operation of the work order when it is released. The rework item that was automatically issued to the first operation of the work order displays when it is released. However, you cannot update the item details.
- **Manual:** When the plant parameter is enabled.
Issue the assembly item manually to a rework work order with appropriate revision. Perform operation completion up to the quantity of the assembly component item that you issued to work order. This option also lets you to do additional tasks such as:
 - Return the rework work order.
 - Update the rework work order quantity.
 - Cancel the rework work order.
 - Update the supply subinventory and locator for an assembly item.
 - Associate assembly serials after releasing the work order and so associate serials from multiple sub inventories.
 - For Lot enabled items, you need not associate the assembly lot details. The lot tab is updated based on assembly lot selected during assembly issue transaction.

The items with negative quantity can be assigned to the work order operations. Items with negative quantity are inherited through the work definition explosion, or can be ad hoc items specified for the operation.

Note: For an operation, an item can be defined as positive quantity and negative quantity in different item sequences.

Overview of Transform Work Orders

A finished goods assembly can be transformed into a different assembly by removing or adding components. To support this business practice, Oracle Manufacturing provides the following capabilities:

- You can create transform work order with or without specifying a transform work definition.
- You can specify **Transform from Item** for a transform work order.
- You can specify a **negative quantity** for work order operation items. The same item can be specified in two item sequences, such as a sequence with a positive quantity, and a sequence with a negative quantity.

In material transactions, material-negative issue transactions are supported to transact items with negative quantities. Additionally, ad hoc items with negative quantity can be transacted in material transactions. The genealogy of the reworked assembly can be reviewed for serial tracked Rework work orders.

The following figure illustrates the Transform work order process flow:

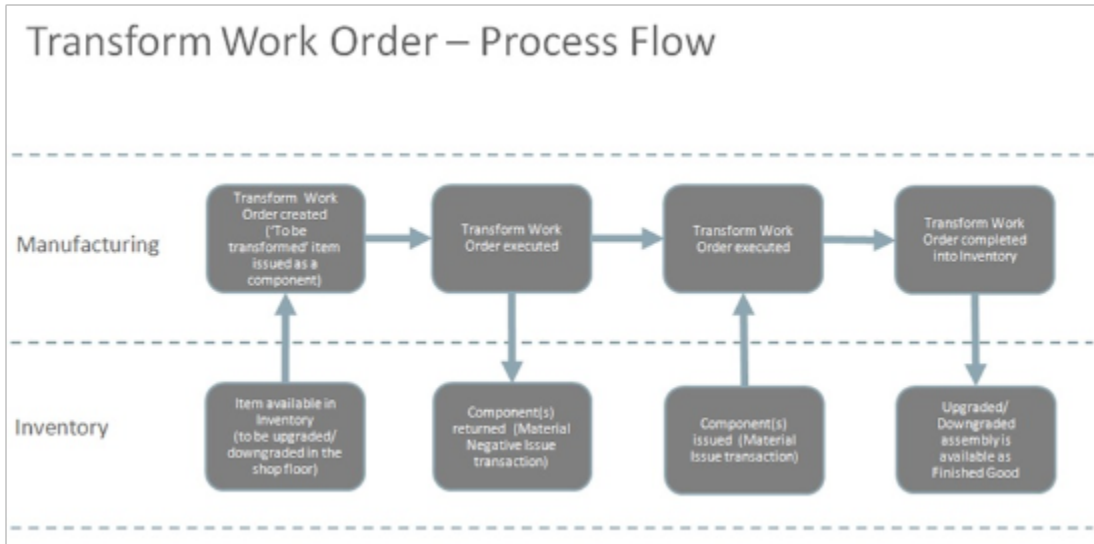

The business flow diagram for the transform work order process flow shows how an assembly in inventory can be transformed into another assembly in the manufacturing shop floor and completed as a finished good back in inventory. The transformed assembly can be an upgraded or downgraded version of the original assembly.

A Transform work order is created in the Manufacturing, where the assembly to be transformed is issued from Oracle Fusion Cloud Inventory to the work order, and operations are executed on the shop floor. One or more components are removed from the assembly and they can be replaced with new components. The assembly now gets transformed to another item because of change in components. For example, 32GB RAM is removed and replaced with 128GB RAM, by which the assembly is upgraded to a higher version. Then, the transformed assembly is completed in Inventory as a finished item.

Note: Using FBDI (.xslm) templates (similar to the importing standard and nonstandard work orders), you can import Transform work orders. For Transform work orders, the sheets added are to denote Assembly Item, Material Lot, and Material Serial.

Note: Transform work orders are currently available for only the discrete manufacturing work method.

How You Create a Transform Work Order

To create transform work order in Oracle Manufacturing, you must complete tasks in both the Work Definition and Work Execution work areas:

Work Order

You can select a specific work order type to create a transform work order. If you have access to **Manage Work Orders**, you can create the new Transform work order. For a Transform work order, the work definition is optional. However, you must specify the **Transform from Item** field. Transform from Item is the item from which the work order item is being transformed to.

The valid work definitions of type **Transform** which are defined for the work order item, and the Transform from Item combination are displayed. You can select any one of them. You can create the Transform work order in a Released, Unreleased, or On-hold status if a work definition is provided. You can create it in an Unreleased or On-hold status if a work definition is not provided. The rest of the behavior is similar to that of a standard or a nonstandard work order.

You must manually specify the **Transform from Item** as an item in any of the work order operations. Items with a negative quantity are inherited through the work definition explosion.

Additionally, the items with negative quantity can be assigned to the Transform work order operations as ad hoc items.

Note: For an operation, an item can be defined with positive quantity and negative quantity in different item sequences.

Note: Transform work order flow is currently supported for only discrete manufacturing.

How You Create Project-Specific Work Orders

You can create and update a work order with project details in an organization that's enabled for inventory tracking by project.

- For Discrete Manufacturing work method, you can create project-specific standard, nonstandard, rework, and transform work orders.
- For Process Manufacturing work method, you can create project-specific standard work orders.

You can create and update work orders with project details using the Edit Work Order user interface, File-Based Data Import (FBDI), or REST APIs. You can perform error corrections using Application Development Framework Desktop Integration (ADFdi).

In the Edit Work Order page, the Project Details region lists the project-related fields. You can see the Project Details region if the **Enable inventory tracking by project** check box is selected in the plant parameter of the inventory organization. The project-related fields are Project Number, Task Number, Expenditure Item Date, Expenditure Type, and Expenditure Organization. Here are some details about the project-related fields that you must know:

- Project Number is an optional field. You can create a work order that's not associated with a project even though a plant is enabled for inventory tracking by project.

- The default Expenditure Item Date is derived from the work order completion date while Expenditure Organization is set to the manufacturing plant. The manufacturing plant must be classified as a project expenditure organization.
- You can define the defaults for Expenditure Type and User-Defined Attributes in Functional Setup Manager. While creating a work order, after specifying a Task Number, the default values for Expenditure Type and User-Defined Attributes are based on the setup. Expenditure Type of a project-specific work order is used to calculate work center and plant overhead.

Project cost transaction validations are performed upon defining the defaults, saving, and releasing a work order. If the validations fail, you must fix the errors before the changes are saved. Project details can be updated only when the work order status is Unreleased.

In the Manage Work Orders page, Project Number and Task Number are available as search fields. These fields are also listed as column names in the search results. Searching by Project Number and Task Number returns the work orders with the corresponding project, task, or both.

In a back-to-back fulfillment scenario, when a work order in Oracle Manufacturing is automatically created as a supply to fulfill a project-specific sales order, the project details of the sales order are passed on, and carried forward in the project-specific work order. The work order in a back-to-back scenario is always created in the Released status, which you can conditionally set the status to Unreleased. If the project-specific back-to-back work order is in Unreleased status,

- you can update the other project costing attributes such as the Expenditure Type
- you can't update the project and task attributes if its reserved to a sales order

The finished goods in a back-to-back scenario are complete into work order specific project inventory like other project-specific work order execution flows.

Related Topics

How You Update a Work Order

You can use the Edit Work Order page to update a work order in the user interface. Additionally, multiple work orders can be updated using mass actions. To view or update work orders, you need the following privileges:

- **View Work Order:** Enables query and view of work order details.
- **Manage Work Order Headers:** Enables creation of work orders and update of work order header and general information, except status update for closing a work order.
- **Manage Work Order Operations:** Allows addition and update of work order operations and its entities.
- **Manage Work Order Lots:** Allows preassigning lots to work order output items.
- **Manage Work Order Serials:** Allows entry of work order serials and related actions.

During the lifecycle of the work order, it's updated by the user or the application to transition the statuses. You can update the attributes of a work order in any status with the certain exceptions. Certain attributes such as work order number, product, reservation details, and so on can't be updated once a work order is created. The following tabs are available in the **Edit Work Order** page:

- **General Information:** Work order header level information, such as product, work definition, work order status, attachments and so on.

- **Operations:** Work order operation information, such as operation name, work center, components and resources requirements.
- **Lot Numbers:** Lot numbers, parent lot number, and lot expiration date are specified for work order outputs if preassigned lot is enabled in the work definition.
- **Serial Numbers:** Product serial numbers which are associated with the work order for serial-tracked manufacturing.
- **Reservations:** Supplies from a work order that are reserved against one or more sources of demand.
- **History:** Work order execution history such as status, dates, and quantities.

You can update the release date of a work order in the **General Information** tab based on certain validations. If you're changing the work order from unreleased, or on hold status to released status, the release date will be defaulted with the current application date. You can update it to a previous date. You also can't change the release date to a future date. The release date of a work order is updated in the **History** tab accordingly. You can't change the release date when you change the work order from released status to on hold, completed, closed, or canceled status.

You can update the closed date of a work order in the General Information tab based on certain validations. If you're changing the work order from any status to closed status, the closed date will be defaulted with the current application date. You can update it to a previous date, not earlier than the last transaction date. You also can't change the closed date to a future date. The closed date of a work order is updated in the History tab accordingly.

You can associate or dissociate lot numbers for the work order product in the Lot Numbers tab based on certain validations.

	What you can do on the Lot Numbers tab	What you can't do on the Lot Numbers tab
Discrete Work Order	You can associate lot numbers using either the Generate Lot action, Select Lot from the list of values, Manually enter a lot, or default the work order number as the lot number based on the plant parameter. You can generate Parent Lot Number, or manually enter the value depending upon the item setup for child lot control. You can also capture Lot Expiration Date, if the item lot expiration control is set as User-defined expiration date.	You can't dissociate a preassigned lot, if any transaction has been performed with that lot number.
Process Work Order	You can associate lot numbers using either the Generate Lot action, Select Lot from the list of values, Manually enter a lot, or default the work order number as the lot number based on the plant parameter. You can generate Parent Lot Number, or manually enter the value depending upon the item setup for child lot control. You can also capture Lot Expiration Date, if the item lot expiration control is set as User-defined expiration date.	You can't dissociate a preassigned lot, if any transaction has been performed with that lot number. If there are any product completion transactions without preassigning a lot number, then you can't preassign lot number for the respective product or by-product.

Related Topics

- [How You Manage a Work Order Header](#)
- [How You Manage Work Order Operations](#)
- [How You Manage Work Order Mass Actions](#)

How You Manage a Work Order Header

A work order header stores some of key attributes of the work order business object. The work order header uniquely identifies the work order, describes the nature of work being carried out, and captures the details of the item being manufactured, the required quantity, the work definition to be used, and the start and completion dates.

The header attributes are displayed in the General Information tab of a work order.

The following table summarizes the attributes present in a work order header:

Name	Description
Work Order Number	A work order number identifies the work order and is unique within a plant. During creation of the work order, a unique number is automatically assigned from the numbering scheme defined per the plant parameters (Work Order Prefix, Work Order Starting Number). You can also manually enter a work order number during creation. Once a work order is created, the work order number can't be updated.
Status	This represents the status of the work order during its lifecycle. The predefined statuses supported are Unreleased, Released, On Hold, Completed, Closed, and Canceled. In addition, you can update work order status work order status to predefined or user-defined statuses.
Start Date	Planned start date and time of the work order.
Completion Date	Planned completion date and time of the work order.
Description	Description of the work order.
Work Order Priority	Represents the work order execution priority.
Item	Also referred as product or assembly. It represents the primary item that's to be manufactured. The item attributes Build in WIP and Transactable indicators must be enabled to create a work order. After the work order is created, the item can't be updated. This is applicable to only discrete manufacturing work orders.
Quantity	Quantity of the work order that's planned for and started with. This is applicable to only discrete manufacturing work orders.
Undercompleted	Represents that the work is undercompleted based on the undercompletion tolerance value.
UOM	Represents the unit of measure of the quantity being manufactured. It is always the primary unit of measure of the item. This is applicable to only discrete manufacturing work orders.
Process Name	It is a unique identifier for a specific process manufacturing work definition that can produce multiple outputs. It can't be updated after the work order is released This is applicable to only process manufacturing work orders.

Name	Description
Batch Quantity	<p>It is the batch quantity of the process manufacturing work order. During work order creation, this is defaulted from the work definition and can be scaled up or down. The batch quantity moves through operations until work order completion.</p> <p>This is applicable to only process manufacturing work orders.</p>
Batch Quantity UOM	<p>Represents the unit of measure of the batch quantity being processed. It is defaulted from the work definition and can't be updated on the work order.</p> <p>This is applicable to only process manufacturing work orders.</p>
Primary Output	<p>The Primary Output item is the most intended output for the process name specified in the process work order. The item attributes Build in WIP and Transactable Indicators must be enabled to create a process manufacturing work order. Once the work order is created, the primary output item can't be updated.</p> <p>This is applicable to only process manufacturing work orders.</p>
Version	<p>Represents the version of the primary output item.</p> <p>This is applicable to only process manufacturing work orders.</p>
Primary Output Quantity	<p>It is the quantity of the primary output item. The primary output item and its quantity are displayed in both work order header and work order output items. Any change in quantity in one place will automatically update the other. The primary output quantity can't be updated in the work order header when the work order is released.</p> <p>This is applicable to only process manufacturing work orders.</p>
Primary Output UOM	<p>Represents the unit of measure of the quantity of the primary output item. It is referred from the work definition and can't be updated.</p> <p>This is applicable to only process manufacturing work orders.</p>
Work Definition Name	<p>Work definition name of the item being manufactured. In a discrete manufacturing work order, the work definition is exploded to determine the operation, resource, and material requirements in the work order. It can't be updated after the work order is released.</p> <p>In a process work order, the work definition is exploded to determine the operation, resource requirements, material requirements, and expected outputs. It can't be updated in the work order.</p>
Work Definition Date	<p>Work definition date represents the effective date used to derive the work definition version.</p>
Work Definition Version	<p>Represents the version of the work definition. It is derived and displayed based on the work definition name and date specified.</p>
Production Priority	<p>Production priority identifies the primary and alternate work definitions of an item. A production priority of 1 indicates the primary work definition. The production priority is derived and displayed based on the work definition name specified.</p>

Name	Description
Preassign Lots	This indicates if the output lot numbers can be preassigned to the work order. This is derived from the work definition and you can't edit this attribute.
Serial-Tracked Production	This indicates if serial-tracking is enforced for the work order. This is derived from the work definition and you can't edit this attribute. This is applicable to only discrete manufacturing work orders.
Item Structure Name	Represents the item structure name that's referenced on the work definition selected on the work order. This is applicable to only discrete manufacturing work orders.
Item Structure Revision	Represents the revision of the item whose item structure is referenced on the work definition selected on the work order. This is applicable to only discrete manufacturing work orders.
Item Structure Version	Represents the version of the item whose item structure is referenced on the work definition selected on the work order. This is applicable to only discrete manufacturing work orders.
Work Order Type	Indicates whether the type of work order selected during creation is Standard, Nonstandard, Rework, or Transform. For process manufacturing work orders, only the standard work order type is supported.
Work Order Subtype	Represents the specific nature of work being performed such as Standard Production, Prototyping, or Repair. Costing can derive work order accounts based on this attribute.
Work Method	Refers whether the work order is Discrete Manufacturing and Process Manufacturing. If an organization is enabled for process manufacturing, then both the work methods are available during the creation of work orders. If the organization is enabled for only discrete manufacturing, then the work method is discrete by default.
Firm	Indicator to enable or prevent Planning from suggesting rescheduling recommendations for the work order.
Back-to-Back	Indicator that this work order is created as a supply for a back-to-back sales order. You can't edit this attribute. This is applicable to only discrete manufacturing work orders.
Contract Manufacturing	Indicates a contract manufacturing work order. You can't edit this attribute. This is applicable to only discrete manufacturing work orders.
Released Date	Indicates the date when the work order is released.
Closed Date	Indicates the date when the work order is closed.

Name	Description
Scheduling Method	Indicates the scheduling method (User or external scheduling, or Default scheduling) to schedule or reschedule work orders.
Supply Type	Represents the default supply types to be considered in the work order for operation items.
Completion Subinventory	Represents the default completion subinventory to be considered in the work order for product completion. This is applicable to only discrete manufacturing work orders.
Completion Locator	Represents the default completion locator of the subinventory to be considered in the work order for product completion. This is applicable to only discrete manufacturing work orders.
Overcompletion Tolerance Type	Indicates the tolerance type (percent or quantity) for overcompletion of the work order quantity. <ul style="list-style-type: none"> • The Overcompletion tolerance in a discrete work order is supported / calculated based on product quantity. • The overcompletion tolerance is supported for the process manufacturing work order batch quantity only. • The overcompletion tolerance isn't applicable for Transform and Rework work orders.
Overcompletion Tolerance Value	Indicates the editable field that displays the percent or quantity that's allowed to be completed over the work order quantity.
Undercompletion Tolerance Type	Indicates the undercompletion tolerance type (percent or quantity) that's allowed for the work order quantity. <ul style="list-style-type: none"> • The undercompletion tolerance in a discrete work order is supported / calculated based on product quantity. • The undercompletion tolerance is supported for the process manufacturing work order batch quantity only. • The undercompletion tolerance isn't applicable for Transform, Rework, and Contract Manufacturing work orders.
Undercompletion Tolerance Value	Indicates the editable field that displays the percent or quantity of the selected tolerance type that's allowed to be completed lesser than the work order quantity.

Update Work Order Status

You can use status of a work order to manage the work order through its entire lifecycle. Work orders are generally created in the **Unreleased** status. You can then update the status to **Released** once the work order is ready for execution. On executing the work order, when the last operation is complete, the work order is automatically updated to **Completed** status. You then update the status of the work order to **Closed**. You can also update the work order status to **On Hold** or **Canceled**.

Note: You can query work orders using the available predefined and user-defined statuses using a REST API.

The following table lists the valid status transitions allowed for a work order:

From Status	To Status Unreleased	To Status Released	To Status On Hold	To Status Completed	To Status Closed	To Status Canceled
From Status Unreleased	Not applicable	Allowed	Allowed	Not allowed	Allowed	Allowed
From Status Released	Conditionally allowed Updating the work order status from Released to Unreleased isn't allowed when transactions or pending transactions against the work order exist.	Not applicable	Allowed	Allowed only by application	Conditionally allowed Updating the work order status from Released to Closed isn't allowed when pending transactions against the work order exist.	Allowed
From Status On Hold	Conditionally allowed Updating the work order status from On Hold to Unreleased isn't allowed when transactions or pending transactions against the work order exist.	Allowed	Not applicable	Not allowed	Conditionally allowed Updating the work order status from Released to Closed isn't allowed when pending transactions against the work order exist.	Allowed
From Status Completed	Not allowed	Allowed only by application	Not allowed	Not applicable	Allowed	Not allowed
From Status Closed	Conditionally allowed Updating the work order status from Closed to Unreleased is only allowed when any of the Released, Completed, or Canceled dates weren't available on the work order.	Conditionally allowed Updating the work order status from Closed status to Released is only allowed if there is a Released Date but no Completion or Canceled date on the work order.	Not allowed	Conditionally allowed Updating the work order status from Closed to Completed status isn't allowed when the completion date isn't available on the work order.	Not applicable	Conditionally allowed Updating the work order status from Closed to Canceled isn't allowed when the canceled date isn't available on the work order.
From Status Canceled	Conditionally allowed Updating the work order status from Canceled to Unreleased isn't allowed when transactions	Allowed	Allowed	Not allowed	Conditionally allowed Updating the work order status from Canceled to Closed isn't allowed if any pending transactions	Not applicable

From Status	To Status Unreleased	To Status Released	To Status On Hold	To Status Completed	To Status Closed	To Status Canceled
	or pending transactions against the work order exist.				against work order exist.	

The following table summarizes the work order status change rules specific to supplier operations::

From Status	To Status Unreleased	To Status Released	To Status On Hold	To Status Completed	To Status Closed	To Status Canceled
From Status Unreleased	Not applicable	Purchase requisition creation initiated, if eligible as per plant parameter setting.	Not applicable	Not applicable	Not applicable	Not applicable
From Status Released	Not allowed if purchase requisitions exist.	Not applicable	Not applicable	Not applicable	Change Management Action: Attempt canceling any associated purchasing documents as appropriate.	Change Management Action: Attempt canceling any associated purchasing documents as appropriate.
From Status On Hold	Not allowed if purchase requisitions exist.	Purchase requisition creation initiated, if eligible as per plant parameter setting if the work wasn't released before.	Not applicable	Not applicable	Change Management Action: Attempt canceling any associated purchasing documents as appropriate.	Change Management Action: Attempt canceling any associated purchasing documents as appropriate.
From Status Completed	Not applicable	Not applicable	Not applicable	Not applicable	Not applicable	Not allowed
From Status Closed	Not applicable	Purchase requisition creation initiated, if eligible as per plant parameter settling.	Not applicable	Not applicable	Not applicable	Not applicable
From Status Canceled	Not applicable	Purchase requisition creation initiated, if eligible as per plant parameter setting.	Not applicable	Not applicable	Not applicable	Not applicable

Note:

All the status change validations including the user-defined statuses are as per the predefined status to which the user-defined status is mapped.

Update Work Order Quantity

If you update the work order quantity of a work order, the required quantities of operation items and required usage of operation resources are recalculated. You are prompted to make a selection to either forward schedule from the start date or backward schedule from the completion date to schedule the work order based on the new quantity.

The work order quantity can be reduced to the extent of the ready quantity available in the first count point operation. If the updated work order quantity equals the sum of the completed quantity at the last operation and scrapped quantities across all operations, then the work order is automatically set to **Completed** status.

When the work order quantity is increased, and if the work order is in **Completed** status, then the work order status is automatically updated to **Released** status. In the case of process work orders, the batch quantity will be considered as the work order quantity.

Note: If the work order quantity is reduced to the extent of completed quantity for a partially completed work order, then the work order status will be automatically set to Completed.

Update Work Definition

You can update the work definition name or work definition date only when the work order is in **Unreleased** status. When you update these two attributes, all the existing operations, operation items, and operation resources of the work order are deleted, and a re-explosion of the updated work definition is triggered. In the case of process work orders, the work definition name can't be updated. Instead, you can update the process name to achieve the same behavior.

Update Work Order Date

Update the following attributes in order to reschedule and calculate new dates of the work order:

- Start Date
- Completion Date
- Quantity
- Work Definition Name (applicable to only discrete work orders)
- Work Definition Date
- Process Name (applicable to only process work orders)
- Scaling Action (applicable to only process work orders)

Note: Performing scaling action by updating batch quantity, primary output quantity, input item quantity, or output item quantity can reschedule process work orders. Refer to the Scheduling of Work Orders section for more details.

Related Topics

- [How You Manage Work Order Operations](#)
- [How You Manage Work Order Operations Resources](#)
- [How You Manage Work Order Serials](#)
- [How You Manage Work Order Reservations](#)
- [How You Manage Work Order History](#)

How You Manage Work Order Operations

The Operations tab provides a list view of all operations with its component and resource requirements. It helps you do the following:

- Displays the summary of the operations, operation items, operation resources, purchased items, and operation outputs of the work order along with operation attachments
- Displays the details of execution progress for the operations, operation items, operation resource, and operation outputs
- Add, Edit, and Delete Operations
- Edit Operation Items
- Edit Operation Resources
- Edit Operation Outputs (applicable to only process work orders)
- Reschedule an operation using midpoint scheduling

You can use the actions in the list view to add or edit or delete operations. The **Work Order Operations** consists of information about the list of operations that are performed in a work order. Work order operations are either inherited by explosion of work definition or are manually added.. You can use the **Edit Operation** action to do the following:

- Add Operations
- Edit Operation Details
- Delete Operations

The following actions are displayed if the operation type is Supplier:

- Midpoint Reschedule
- Review Supplier Operation Details

Note: Midpoint Reschedule action is displayed subject to at least one of the lead times specified for the operation being greater than 0.

The following table lists the different attributes of a work order operation:

Name	Description
Operation Sequence Number	This is the sequence in which operations are performed in the work order. The starting sequence and increments in sequence are determined by the plant parameters Starting Operation Sequence and Operation Sequence Increment .
Operation Code	Represents the standard operation code that's used to define the operation. If an operation is created using a standard operation, the details of the operation and its resources are copied to the work order and aren't referenced thereafter.
Operation Type	Indicates if an operation is executed in-house or outsourced to suppliers. If the Operation Type is in-house, the following attributes apply.

Name	Description
Operation Name	Represents the name of the operation and it's mandatory to be specified when defining a nonstandard operation.
Description	Description of the operation.
Work Center	Work center where the operation is executed.
Count Point	Indicator of an operation being performed in the shop floor and reported manually in the application during execution.
Automatically Transact	<p>Indicator of an operation being performed in the shop floor and reported automatically in the application during execution. This may be the case when the operation transaction is insignificant to manually record it. Count point and Automatically transact indicators are mutually exclusive.</p> <p>Optional Operation: An operation is designated as optional if both the count point and auto transact indicators are unchecked. You can manually report component and resource usages at an optional operation</p>
Allow Resequencing	Indicates that the operation can be resequenced during work execution. Only count point operations can be defined as resequenceable operations. Resequenceable operations can't be the first and last operations of a work order.
Start Date	Represents the planned start date of the operation and also referred as scheduled start date. The operation start date is generally calculated by the scheduling engine. This is a mandatory attribute. The operation start date must be encompassed within the work order start and completion date.
Completion Date	Represents the planned completion date of the operation and also referred as scheduled completion date. The operation completion date is generally calculated by the scheduling engine. This is a mandatory attribute. The completion date must be encompassed within the work order start and completion date.
Serialization indicator	Derived from the work definition and is a display only attribute in the work order. Indicates if the operation is enabled for Serialized production reporting.
Additional Manual Material Issue	Specifies if operators can manually issue additional materials that aren't defined in the work order with push supply type, or manually issue quantities greater than those specified in the work order. The possible values are Allow and Do not allow.
Completions with Under Issues	Specifies if operators can report operation completions when materials with push supply type haven't been issued. The possible values are Allow, Allow with warning, and Do not allow.
Completions with Open Exceptions	Specifies if operators can report operation completions when there are open exceptions. The possible values are Allow, Allow with warning, and Do not allow.

A work order must have at least one count point operation in it. Additionally, the last operation of a work order has to be a count point operation.

When a work order is released, the work order quantity is placed in the ready state of the first count point operation of the work order. When the work order quantity is increased or decreased, the differential quantity is updated at the first count point operation.

The following table shows quantities of an operation as updated and displayed for the operation in the list view, during execution. The quantities are displayed in the primary unit of measure

Quantity	Description
Ready quantity	Represents the quantity that's ready for execution for the operation.
Completed quantity	Represents the quantity completed for the operation.
Scrapped quantity	Represents the quantity scrapped, if any, for the operation.
Rejected quantity	Represents the quantity rejected, if any, for the operation.

If the operation type is Supplier, then the operation is always a Count Point operation. An operation with the operation type Supplier can't be deleted if the operation is associated to any purchasing document, or the creation of purchasing documents is in process (which is treated as a pending transaction) or any transaction has been made against the operation. Resources can't be added to an operation with operation type Supplier. Supplier operations can't be defined as resequenceable operations in a work order.

The following table lists the values you must select for the different attributes of a supplier operation, in the Supplier Operation Details section:

Field	Description
Outside Processing Item	<p>An item that represents the value added service being performed on the assembly in outside processing. The item is defined in Oracle Fusion Product Information Management.</p> <p>If the finished goods item is a dual units of measure item, which means the Tracking Unit of Measure is set to primary and secondary, then the outside processing item should be defined as a dual units of measure item as well.</p> <p>For more information about setting up items for outside processing, refer to the Implementing Outside Processing chapter in the Oracle Supply Chain Management Cloud Implementing Manufacturing and Supply Chain Materials Management Guide.</p> <p>Note: You can updated the outside processing attributes (Outside Processing Item and Generate Shipment) of the supplier operation only if the Work Order Status is Unreleased, or On Hold (without release date).</p> <p>Note: You can't add an outside processing item as a component to an operation.</p>
Item Description	The description of the outside processing item.

Field	Description
Supplier	The recommended supplier used in creating the requisition. The supplier is an external party who provides specialized manufacturing services to manufacture a product. The field becomes required if the prior operation is also a supplier operation.
Supplier Site	The recommended supplier site. The field becomes required if the prior operation is also a supplier operation.
Generate Shipment	This is used to indicate if shipment needs to be created to print the shipping documents for the outside processing item. The default value is based on the Outside Processing Item's shippable attribute. It's unchecked if the prior operation is a Supplier Operation (consecutive outside processing) or if the supplier operation is the first operation in sequence.
Lead Time UOM	The unit of measure for the lead time of a supplier operation.
Fixed Lead Time	The fixed lead time for the operation independent of the order quantity.
Variable Lead Time	The variable lead time for the operation dependent on the order quantity.

Note: If you check the **Generate Shipment** check box, Oracle Fusion Manufacturing sends a request to Oracle Fusion Supply Chain Orchestration. Supply Chain Orchestration creates a shipment line to ship the goods to the supplier once the goods are reported as completed, in the operation prior to the supplier operation. Supply Chain Orchestration automatically creates a shipment line and creates a supply order line based on the request sent by Manufacturing.

How You Define Resequenceable Operations in a Work Order

You can define a work order with operations that can be resequenced in work execution. You can define resequenceable operations for all work methods, including serial tracked production and for all work order types. You can define an operation as a resequenceable operation by selecting the Count Point and Allow resequencing options in the Create or Edit Operations dialog.

You can define a work order with resequenceable operations either by inheriting it from its work definition or by manually adding it in an unreleased work order. However, the first and last operations of a work order can't be defined as resequenceable operations. A set of resequenceable operations must be preceded and succeeded by count point operations. You must complete the first count point operation before you can execute a set of resequenceable operations. Also, you must execute all resequenceable operations before executing the succeeding count point operation.

You can't define automatically transact or optional operations next to a resequenceable operation. You can have any number of resequenceable operations within a set and any number of such sets within a work order.

When a work order with operations that can be resequenced is released, the execution sequences are stamped in all the operations in the same order as the operation sequences. You can see these stamped operations in the Operations tab of a work order. Execution sequences are not stamped at operation level if the work order doesn't have any resequenceable operations. You can't add resequenceable operations or modify the Allow Resequencing option after the work order has been released.

During work execution, as a production operator, you can execute the operations in a different order because of which the execution sequences are altered. If a released work order is rescheduled, the operation dates are scheduled based on the order of execution sequences.

How You Add Operations to Work Orders in Released Status

You can add one or more count point and automatically transact operations to a work order in released status. You can't add a new operation prior to a completed operation and can't add a new operation as the last operation either if there are any product completions or reversals at the last operation. However, if you can reverse the completions at an operation, you can add operations prior to the previously completed operation. You can't add resequenceable operations for a released work order.

For a serial tracked work order, the newly added operations prior to the serial start operation won't be serial tracked and the newly added operations after the serial start operation will always be serial tracked.

You can add supplier operation as the first or last operation, intermediate operation, or as a consecutive supplier operation. You can't add any operation in between consecutive supplier operations.

You can reschedule the work order manually using midpoint rescheduling after adding new operations. The existing validation of the last operation being a count point operation is enforced. For rework work order you can't add a count point operation prior to the existing first count point operation. Also, when you add new operations ensure that the existing validations are fulfilled.

Note: The ability to add operations for released work orders is supported in UI and REST only.

How You Manage Work Order Operation Items

The Work Order Operation Items are also referred to as materials or components. The Work Order Operations Items contain information about the operation item requirements for the Work Order Operations.

The Edit Operation Item action helps you do the following:

- Add operation items
- Edit operation item details
- Delete operation items
- View and replace operation items with substitutes

Note: Work order scaling for operation items is supported in process manufacturing.

The following table lists the attributes of the work order operation items:

Name	Description
Operation Sequence Number	Represents the operation sequence number where the operation item is required.
Material Sequence Number	Represents a unique sequence assigned to the operation item.

Name	Description
Operation Item	<p>Identifies the item required to perform the operation.</p> <p>Note: For process work orders, an output item can't be referenced as an input item.</p>
Quantity Per Product	<p>Represents the quantity required to manufacture per unit of the product.</p> <p>Note: This attribute is currently supported for only discrete manufacturing.</p>
UOM	<p>Represents the unit of measure of the quantity. It is always the primary unit of measure of the item.</p>
Secondary Quantity	<p>The secondary quantity of the operation item required in an operation.</p> <p>The field is displayed only when the item is set up as a dual unit of measure item. You can enter either the primary/transactional quantity or secondary quantity, and the application will automatically calculate the other based on the predefined UOM conversion.</p> <p>Note: Secondary Quantity is applicable only to process work orders.</p>
Secondary UOM	<p>The secondary unit of measure of the operation item quantity. It's defaulted to the item's secondary unit of measure and can't be updated.</p> <p>Note: Secondary UOM is applicable only to process work orders.</p>
Inverse	<p>Represents the inverse of the Quantity Per Product. This is applicable when the material Quantity Per Product is fractional but its inverse is an integer.</p> <p>Note: This attribute is currently supported for only discrete manufacturing.</p>
Basis	<p>Quantity consumption can be either Fixed or Variable, indicating constant or proportional usage of the material with respect to the work order product quantity.</p>
Yield	<p>Represents the factor to calculate the required quantity of the operation item to accommodate component wastage. The value of yield must be 0 lesser than yield lesser than or equal to 1. However, yield value greater than 1 is allowed with a warning message. Based on the plant parameter Include component yield in material requirements, the yield is considered in the calculation of the required quantity.</p>

Name	Description
Required Quantity	Represents the operation item quantity required to manufacture the work order quantity. This is calculated and defaulted from the Quantity Per Product depending on the Basis type as follows: If Basis is equal to Fixed, the Required Quantity is equal to Quantity Per Product divided by Yield. If Basis is Variable, the Required Quantity is Quantity Per Product multiplied by Work Order Quantity divided by Yield
Required Date	Represents the date when the materials are required to perform the operation. The required date must not be outside the operation start and completion dates.
Supply Type	<p>Controls how the materials are consumed in the work orders. The hierarchy to default the supply type is in the following order:</p> <ul style="list-style-type: none"> • Default operation item's supply type with work order header supply type if it's not equal to Based on Work Definition. • Default from item setup if the header supply type is Based on Work Definition. • Default to Push if it's not present in item setup. <p>You can update the default value. A list of supply types and their uses:</p> <ul style="list-style-type: none"> • Assembly pull: The material is backflushed when the product is completed into inventory. • Operation pull: The material is backflushed when a subsequent count point operation is completed. • Push: The material is manually issued. • Bulk: Bulk materials requirement can be viewed. These materials aren't automatically backflushed or defaulted while manually issuing the materials. • Supplier: Represents the materials supplied by supplier. These materials aren't automatically backflushed or defaulted while manually issuing the materials. <p>Note: For operation items with material transaction enabled as N in item setup, the supply type must be Bulk.</p>
Supply Subinventory	The supply subinventory from which the material is supplied. The hierarchy to default the supply subinventory is in the following order: work definition, item definition, plant parameter. You can update the default value.
Supply Locator	The supply locator from which the material is supplied. The hierarchy to default the supply locator is in the following order: work definition, item definition, plant parameter. You can update the default value.
Include In Planning	Indicates whether this operation item requirement must be considered by planning run for planning its supply.
Issued Quantity	Represents the net issued quantity of the operation item.
Open Quantity	Represents the quantity that's yet to be issued.
On Hand Quantity	Represents the quantity available in Inventory as on hand balance at plant level.

Name	Description
Allocated Quantity	Quantity of materials allocated to the work order during the picking process when a movement request is created for a work order operation item.
Picked Quantity	Quantity of materials that's picked when the pick slip is confirmed and is issued either directly to the work order or is moved to the staging subinventory.

You can now view the item substitutes in the Edit Operation Items user interface. An icon indicating there are substitutes for an item shows whenever substitutes are defined in the item structure. Upon clicking the icon, a new window opens showing all the substitutes and the priority.

You can select to replace any of the substitutes in place of the primary item using the OK button for all unreleased work orders. After the work order is released, you would be able to only view the substitutes but not replace them.

How You Manage Work Order Operations Resources

The Work Order Operation Resources contain information about the resource requirements for the Work Order Operations. The Edit Operation Resources action enables you to do the following:

- Add Operation Resources
- Edit Operation Resource Details
- Delete Operation Resources

The following table lists attributes of the work order operation resources:

Name	Description
Resource Sequence Number	Resource Sequence Number is used to define the sequence in which resources work together in finishing the operation. When multiple resource lines have the same resource sequence number, it indicates that the resource is scheduled in parallel, such as simultaneous resource.
Resource Name	Represents the name of the resource.
Code	Represents the code of the resource.
Description	Represents the description of the resource.
Usage Rate	Represents the resource usage required to manufacture per unit of the product.
UOM	Represents the unit of measure of the resource usage.
Inverse	Represents the inverse of the Usage Rate. This is applicable when the resource usage rate is fractional but its inverse is an integer.

Name	Description
Required Usage	Represents the resource usage required to manufacture the work order quantity. This is calculated and defaulted from the Usage rate depending on the Basis type as follows: If Basis is Fixed, then the Required Usage is equal to Usage Rate If Basis is Variable, the Required Usage is equal to Usage Rate multiplied by Work Order Quantity
Scheduled	Indicates if the resource is scheduled or not. The resource can be scheduled, if the unit of measure of the resource belongs to the time unit of measure class specified in the profile SCM Common: Default Service Duration Class (RCS_DEFAULT_UOM_SERVICE_DURATION_CLASS). For any scheduled resource, it's recommended that this profile be set to a UOM class that represents units of measure for Time.
Charge Type	Represents whether the resources are charged manually by the user or automatically when completing the operation.
Job Profile	Represents the job profile for a labor resource.
Equipment Profile	Represents the equipment profile for an equipment resource.
Assigned Units	Represents the number of resource units assigned to perform the operation.
Start Date	Represents the planned start date of the resource and also referred as scheduled start date. The resource start date is generally calculated by the scheduling engine. This is a mandatory attribute. The resource start date must be encompassed within the operation start and completion date
Completion Date	Represents the planned completion date of the resource and also referred as scheduled completion date. The resource completion date is generally calculated by the scheduling engine. This is a mandatory attribute. The resource completion date must be encompassed within the operation start and completion date.
Activity	Represents the activity of the resource in the operation such as setup, run, and tear down.
Principal	Represents a primary resource among the group of simultaneous resources. One of the simultaneous resources must be a principal resource.
Actual Resource Usage	Represents the net actual usage of the assigned resource.

Associating Work Order Operation Resource Instances

As a production supervisor, you can optionally assign resource instances to work order operation resources using the Edit Work Order Operation Resource dialog. If resource type is equal to Equipment, you can assign resource instances representing actual machines used on the shop floor. If resource type is equal to Labor, you can assign resource instances representing actual persons on the shop floor.

You can assign any number of resource instances to a resource and this doesn't affect scheduling of the resource. While assigning resource instances to the work order, by default you will be able to pick those resource instances whose primary work center is the same as the work order operation's work center. However, as a production supervisor, you can search for resource instances belonging to other primary work centers and assign them to this operation resource.

The following table lists attributes of the work order operation resource instances:

Name	Description
Resource Instance Name	Resource instance name is name of the person or equipment associated with the resource.
Identifier	Unique code identifying the resource instance.
Person Type	Represents the type of person associated to the labor resource instance.
Person Name	The name of the person associated to the labor resource instance.
Asset Number	The asset number associated to the equipment resource instance.
Asset Description	The asset number description associated to the equipment resource instance.
Actual Usage	Represents the actual hours charged at the resource instance level.
Program File Name	<p>Indicates the program file associated to the work order operation resource instance. The value is copied from the work definition resource when the resource instance is assigned to the work order operation resource.</p> <p>Note: This is applicable to resources that are set up as automation equipment.</p>
Current Version	<p>The current version of the program file associated to to the work order operation resource instance.</p> <p>Note: This is applicable to resources that are set up as automation equipment.</p>
Equipment Parameters File	<p>Indicates the comma separated value file associated to the work definition operation resource that contains the equipment control attribute values and names of inspection characteristics.</p> <p>Note: This is applicable to resources that are set up as automation equipment.</p>

The equipment profile is validated when assigning work to an equipment resource instance. You can confirm the equipment's qualifications when assigning an equipment resource instance to a manufacturing work order operation. In the event that the equipment resource instance doesn't qualify during the assignment to a work order operation, you receive a warning and can proceed or replace with another qualified equipment resource instance.

The job profile is validated when assigning work to an operator. You can confirm the operator's qualifications when assigning a labor resource instance to a manufacturing work order operation. In the event that the operator does not qualify during the assignment to a work order operation, you receive a warning and can proceed or replace with another qualified operator.

Work Order Operation Outputs

In a work order where the work method is process manufacturing, there can be many output items. The output items of such a work order are displayed in the output items user interface. The item on the header of the work order is the primary output item.

This item is also displayed in the output items user interface with the output type Product. Each output item in the Output Items user interface is identified by the Output Type field as a product or by-product.

The following table displays the attribute name and the attribute description of the work order operation outputs:

Name	Description
Operation Sequence Number	Represents the operation sequence number where the output item is expected to be yielded.
Output Sequence Number	A unique sequence number which identifies the output item within an operation.
Output	<p>The item which identifies the output item expected or actually yielded from one of the work order operations.</p> <p>Note: For process work orders, input items can't be referenced as an output item.</p>
Output Description	The description of the output item.
Output Type	The output type identifies if the output item is a co-product or a by-product. One of the Output items with output type as product is the primary output item and the rest are considered as co-products.
Quantity	The quantity expected to be yielded from the work order operation. This can be zero or a positive number.
UOM	The unit of measure of the output item which is used to express the expected and actual completion quantities.
Secondary Quantity	<p>The secondary quantity of the operation output required in an operation.</p> <p>The field is displayed only when the item is set up as a dual unit of measure item. You can enter either the primary/transactional quantity or secondary quantity, and the application will automatically calculate the other based on the predefined UOM conversion.</p>
Secondary UOM	The secondary unit of measure of the operation output quantity. It's defaulted to the item's secondary unit of measure and can't be updated.
Completion Type	The completion type identifies how the output item will be reported in work execution. It can be either Manual or Automatic.

Name	Description
Completion Subinventory	The completion subinventory where the output item is expected to be yielded.
Completion Locator	The completion locator where the output item is expected to be yielded.
Primary Output	An indicator identifying the primary output item of a work order. This indicator is automatically checked by the application for the output item specified in the work order header.
Cost Allocation Basis	The basis for cost allocation for output items in a process manufacturing work order. It can be either percentage or fixed value.
Cost Allocation Percentage	The percentage value that's associated if the cost allocation basis of the output item is percentage.
Actual Completion Quantity	The actual completion quantity of the output item. This is read only and is updated by work execution transactions in the unit of measure that's associated to the output item.
Attachments	Attachments associated to the output items.
Descriptive Flexfields	Additional information captured in the form of descriptive flexfields for output items.

Work order scaling for operation outputs is supported only for process work orders. Dual units of measure isn't supported for work order operation items and outputs. The user can add a dual unit of measure item as an operation item or as an output item, but the secondary unit of measure and quantity aren't displayed in the work order user interface. You can't assign outputs to resequenceable operations in a process manufacturing work order.

How You Scale Process Work Orders

In a work order where the work method is process manufacturing, you can scale up or scale down an unreleased work order using input item or output item.

After selecting the operation input item or operation output item, you can scale based on percent or you can mention the new quantity of the item selected. Based on scaling percent, batch quantity, input, output, and resource quantity are recalculated.

1. To scale based on an input item or output item, select an item and click the Scaling button.
2. A separate window opens where you can enter the new quantity in the same UOM as mentioned in input item or output item or you can mention a percentage.
3. Choose the appropriate scheduling method to reschedule the work order.
4. Click the OK button to start the scaling process.

Note: Only proportional scaling is supported. You cannot perform scaling based on ad hoc components and ad hoc output items.

The following table displays the attribute name, the attribute description, and the attribute type of the work order scaling:

Name	Description	Type
Item	The selected input item or output item from the Operation Output or Operation Input user interface	String
Item Description	The description of the item.	String
Quantity	The item quantity from the Operation Output or Operation Input user interface.	Number
New Quantity	New Operation Output or Operation Item Quantity for the selected Item. The Ration of New quantity and Quantity is used to scale the work order.	Number
Percent	The percentage value that is used to scale batch work order. The value cannot be zero.	Number

Note: You can also scale the work order by updating the batch quantity or primary output item quantity at the work order header. The primary output item quantity can't be updated once the work order is released.

How You Manage Work Order Serials

If a work definition that's serial-tracked is referred in the work order, the preassigned serial numbers can be associated. You can transact serial components during work order execution for specific work order product serials. The following actions can be performed:

- **Generate and associate serials:** For the quantity specified, the application generates serial numbers for the work order product in inventory, and associates them to the work order.
- **Manually associate serials:** You can search and select serials that are already defined and associate them to the work order.
- **Delete serials:** You can select and delete a serial. This is applicable to serials that are in associated status.

Note: Work order serials is currently supported for only discrete manufacturing.

The following table lists details of the serial numbers tab displayed:

Name	Description
Associated Quantity	Represents the quantity of serial associated to the work order in the primary unit of measure.
Open Quantity	Represents the quantity of serial yet to be associated to the work order in the primary unit of measure.

Name	Description
Item Serial Number	Represents the serial number that's associated to the work order product.
Serial Status	Represents the internal work execution status of the serial number.
Last Transacted Operation	The operation sequence number where the serial was last transacted.
Operation Name	The name of the operation.
Work Center	The work center name of the operation.

The following table lists serial statuses that are displayed when the work order is executed:

Serial Status	Description
Associated	Serial is assigned in the work order.
In Process	When the first transaction is performed for the serial at the operation.
Rejected	Serial is rejected at any operation.
Scrapped	Serial is scrapped at any operation.
Completed	Serial is completed at the last operation into Inventory.

How You Manage Work Order Reservations

The work order as a source of supply can be reserved against a sales order demand. The reservations are typically created by the application when a back-to-back sales order or a configured item sales order is reserved for the work order.

The following table lists the attributes that are displayed if the work order has any reservation details:

Name	Description
Work Order Quantity	Represents the quantity of the work order in its primary unit of measure.
Total Reserved Quantity	Represents the work order that's reserved against one or more demand documents.
Reserved Quantity	Represents the quantity of the work order that's reserved against each demand document.

Name	Description
UOM	Primary unit of measure of the quantity reserved.
Document Type	Represents the document type of the demand. Typically, this is Sales Order.
Customer Number	Number identifying the customer of the demand.
Customer	Name identifying the customer of the demand.
Document Number	Number identifying the document of the demand. Note: An Attachments icon is conditionally displayed if there are any sales order header or sales order line attachments. You can click the icon to view the attachments in separate tabs.
Document Line Number	Number identifying the document line of the demand.
Due Date	Represents the due date of the demand document.
Line Quantity	Represents the quantity of the document line of the demand.
UOM	Unit of measure the demand quantity.

When you reduce the work order quantity, the existing sales order reservations are reduced appropriately. Similarly, when you change the status of the work order to canceled or closed, the existing sales order reservations are removed.

Sales Order attachments from back-to-back sales orders for standard items and configured items are displayed in the Reservations tab of the work order. You can optionally control which attachments can be viewed by the production supervisor.

Attachments belonging to the Miscellaneous category are always displayed by default. However, other user-defined attachment categories may be configured and displayed based on the security setup. Security can be enabled using the standard attachment security framework provided in the Setup and Maintenance work area and the Security Console.

Note: Work orders can be manually reserved against sales orders in inventory.

Maintain Detailed Reservations

This feature helps you create detailed reservations for customer orders for items using the back-to-back process, or orders where you manually reserve the work order to the sales order.

Maintain Detailed Reservations for Work Orders

You can create reservation in the following levels when the work orders are completed.

- Subinventory
- Locator
- Lot
- Serial
- Project
- Task

This feature creates detailed reservation of the sales order to subinventory, locator, lot, or serial level, when the quantity on the work order is completed. Here's how it happens.

- The work order completion transaction transfers the reservation from the work order to the on hand document type.
- The return of the work order product updates the reservation and transfers the reservation back to the work order.
- The serial numbers associated to the reservations are removed from the reservation on work order product return.

Related Topics

- [How You Manage a Work Order Header](#)
- [How You Manage Work Order History](#)
- [How You Manage Work Order Operations](#)

How You Manage Work Order History

When you create and execute the work order, the quantity, date and status information is displayed as work order history. This information is available for a work order throughout its life cycle.

The following table summarizes the work order attributes as displayed on the History tab:

Name	Description
Remaining Quantity	Quantity of work order yet to be completed in the last operation.
Completed Quantity	Quantity of work order completed in the last operation.
Scrapped Quantity	Sum of scrapped quantities across all operations.
Released Date	Date when the work order is released.
Completion Date	Date when the work order is completed.

Name	Description
Closed Date	Date when the work order is closed.
Canceled Date	Date when the work order is canceled.
Canceled Reason	User specified reason for cancellation of the work order.

The following table provides details about work order status history:

Name	Description
Date	Date when the work order status is changed.
From Status	Work order status (includes predefined and user-defined) before the change
To Status	Work order status (includes predefined and user-defined) after the change.
Status Change Date	The actual date if specified by the user when the work order status is changed.
Reason	User-specified reason when the work order is canceled.
User	User who updated the status.

In addition, you can use the **Transaction History** link to view to the production transaction history for the work order. You can use the **Inspection History** link to view the production inspection history for the work order.

You can use the **IoT Insights** link to drill down to the work order view in IoT Production Monitoring Cloud to gain insights into the actual production progress of the work order.

Related Topics

- [How You Manage a Work Order Header](#)
- [How You Manage Work Order Operations](#)
- [How You Manage Work Order Operation Items](#)

How You Manage Work Order Mass Actions

If you've been assigned a job role your enterprise uses for production supervisor work, you can perform work order mass actions, such as update work order status and change work order priorities, on the Manage Work Orders page in the Work Execution work area.

You can update statuses for more than one work orders to release, unrelease, hold, cancel, and close them. You can select more than one work order from the search results list and perform these actions.

The following is a list of mass actions for work orders with their corresponding descriptions:

Mass Action	Description
Release	The selected work orders are set to released status.
Unrelease	The selected work orders are set to Unreleased status.
Hold	The selected work orders are set to on hold status.
Cancel	The selected work orders are set to canceled status and the cancellation reason is to be provided.
Close	The selected work orders are set to closed status. You can also set the closed date to a previous date than the application date, but not earlier than the last transaction date.
Change Priority	The selected work orders are updated with the new priority that's to be provided.

When the mass action is performed, a confirmation message is displayed with the count of work orders that were successfully processed. If there is an error, the individual work orders and their corresponding error details are displayed. You can choose to proceed with or cancel the mass action. If you choose to proceed with the mass action, the successfully validated work orders are processed, and the work orders with errors are discarded from the mass action.

Work Order Material Availability

Overview of Work Order Material Availability Workbench

In your manufacturing organization, you must ensure that all materials are available to execute a work order prior to its release. As a production supervisor you can use the material availability workbench to configure rules to recommend a prioritized list of work orders and assess the material availability for those prioritized work orders.

The work order material availability workbench helps you in the following manner:

- Configure material availability rules to
 - Prioritize work orders by specific attributes such as item, customer, or date criteria.
 - Include work orders on the basis of time fence, work order status, or work order subtype.
 - Exclude noncritical materials from material availability check.
 - Exclude work orders from material unassignment on manual adjustment.
 - Manage material shortages by recommending using substitutes.

- Review the prioritized list of work orders and the material assigned to the work orders to identify the material availability (considering substitutes / not considering substitutes) and shortages as calculated by the material availability rules.
- Review materials with shortages and affected work orders and expected supplies to address the material shortages.
- Adjust material assignments for work order prioritization and preview the force assigned and unassigned work orders.
- Change work order status to release the prioritized work orders with critical materials available, and hold work orders with material shortages.

In the Work Execution work area, perform the tasks using the material availability workbench in the following order:

1. Create rules using the Material Availability Rules task.
2. Initiate the background process Calculate Material Availability (considering substitutes / not considering substitutes).
3. View and assess the assignment priority sequence in the Material Availability Assignments task.
4. View the substitute recommendations and accept substitute to replace component with substitutes in work order.
5. Change priority of work orders by force assigning or force unassigning materials based on expected supplies.
6. Release or hold work orders after you're satisfied with your changes.

Related Topics

- [How Work Order Material Availability Rules and Assignments Work Together](#)
- [How You Manage Work Order Material Availability Assignments](#)
- [Defining Work Order Material Availability Rules: Worked Example](#)

How Work Order Material Availability Rules and Assignments Work Together

You can prioritize the work orders in your manufacturing organization for release to the shop floor based on certain parameters like availability of materials. Use the Work Execution work area in Oracle Manufacturing to create rules to assign materials to the work orders in your organization, and execute work orders based on the assignment priority sequence.

Note: In the Setup and Maintenance work area, you must set up your organization as a manufacturing plant or a contract manufacturing organization using the Manage Inventory Organizations task by specifying the Manage Inventory Organization parameters.

Material Availability Rules

In the Work Execution work area, select the **Material Availability Rules** task from the Manage Production section in the Tasks panel.

Create a set of rules and recommend a list of work orders based on those rules to assign and unassign materials to work orders of higher priority. Your recommendations determine which work orders are prioritized when materials are scarce or unavailable.

Perform the various actions to create a set of material availability rules in the following three tabs:

- **Work Order Assignment Priority:** Assign a rule sequence to various attributes of a work order such as work order type, scheduled start date, customer, and so on. The list can be also be sorted in an ascending or descending order based on attributes like planned start date or planned completion date of work orders.

The following table lists all the attributes that you can use to define the work order assignment priority and their corresponding descriptions:

Attribute	Description
Item	It represents the work order output item, which is an assembly item.
Item Category	Name of the category that's used to group items for specific purposes such as reporting, usage, and so forth.
User Item Type	Indicator or classification for an item, such as finished or purchased.
Work Order Status	Current status (includes predefined and user-defined) of the work order during the manufacturing lifecycle.
Work Order Type	Classification of the nature of work being performed for standard, nonstandard, rework, and transform work orders.
Work Order Subtype	Attribute representing the specific nature of work being performed, such as standard production, prototyping, or repair
Work Order Priority	Attribute defined by the user to represent the priority of work order execution.
Planned Start Date	Date on which a work order is planned to start.
Planned Completion Date	Date on which a work order is planned to be complete.
Customer	Name of a customer for whom the product is being manufactured. In this case the work order is reserved as supply for a sales order.
Ship-to Country	Name of the country to which the final product will be shipped.
Scheduled Ship Date	Date on which the product is scheduled for shipment.

- **Inclusion Criteria:** Include work orders or materials in the assignment criteria based on specific attributes such as work orders within a specified time fence or materials of a specific supply type scale.

The following table lists the key criteria values based on which you can create the material availability inclusion criteria.

Attribute	Description	Default Value
Work Order Date Type	Select the type of date criteria on the basis of which you want to classify work orders.	Start Date
Time Span	Specify the number of hours from the current time that you want to be considered for material availability calculations.	48 hours
Work Order Status	Select the type of status (includes predefined and user-defined) based on which you would like to plan for the work orders that must be included in material calculations.	Released, Unreleased
Work Order Type	Select the type based on which you would like to plan for the work orders that must be included in material calculations.	Standard
Work Order Subtype	Select the subtype based on which you would like to plan for the work orders that must be included in material calculations.	All
Component Supply Type	Select the supply type of the materials which you want to plan availability for.	All
Build in WIP Items	Check box you must select to determine whether or not to include in material calculations the component items that are internally manufactured.	Yes

- **Forced Assignment Criteria:** Manually adjust the material assignment criteria by creating a list of work orders for which materials can't be unassigned during material availability calculations.

Note: The attributes that you can use to define the forced assignment criteria are the same as the attributes you use to create the work order assignment priority.

Material Availability Assignments

In the Work Execution work area, select the **Material Availability Assignments** task from the Manage Production section in the Tasks panel.

You can calculate material availability considering or without considering substitutes. You must click Calculate Material Availability or Calculate Material Availability with Substitutes to initiate the background process which will create the list of work orders and their corresponding assignment sequence based on the rules you have earlier defined.

You can view the list of work orders to which materials are assigned based on the rules you create and the applicable assignment criteria. You can also view the material availability indicator to understand if materials are completely assigned, partially assigned, or not assigned to a work order considering or without considering substitutes. You can accept substitute recommendation and also view assignment details to preview expected supplies of materials.

You can view the work orders and material assignment in the workbench in the following tabs:

- **Work Orders:** View all work orders in your manufacturing organization with their assigned prioritization sequence based on the rules that were enforced.
- **Materials:** View a list of all materials that are included in material availability calculations based on the inclusion criteria.

After you have assessed the assignment priority of the work orders and reassigned materials to work orders based on expected supplies of materials in the workbench, you can either release work orders or place work orders on hold. You can select work orders individually to change their status or select the **Mass Action** drop-down list and change the status of a set of work orders.

Related Topics

- [How You Manage Work Order Material Availability Assignments](#)
- [Defining Work Order Material Availability Rules: Worked Example](#)

Defining Work Order Material Availability Rules: Worked Example

You're a production supervisor who wants to ensure that work orders of higher priority are released to the shop floor. Create a set of rules based on which materials are assigned to the various work orders. This example shows how you can perform the Materials Availability Rules task to set up the assignment criteria based on which materials are calculated and assigned to work orders.

Consider the following scenario where you're using the **Material Availability Rules** task to define the rules and create a material assignment for your manufacturing organization.

The following table summarizes key decisions and corresponding tasks for this scenario:

Decisions to Consider	Task to Perform
How do you sort work orders based on their priority?	Set up the rule sequence for various work order attributes in the Work Order Assignment Priority tab.

Decisions to Consider	Task to Perform
How do you decide which work orders and materials will be used to plan for material assignment?	Create an inclusion criteria for work orders and work order components in the Inclusion Criteria tab.
How do you select certain work orders for which you can't deprioritize material availability calculations?	Adjust the assignment criteria by defining work order attributes in the Forced Assignment Criteria tab, which ensures that materials can't be unassigned for those work orders in case of force assignment.

Note: You can perform these tasks in any order. You can also choose to perform either one or two. In such a case, a default priority sequence will be assigned by the application considering only the parameters you have selected.

Material Availability Rules: Work Order Assignment Priority

1. In the Material Availability Rules: Work Order Assignment Priority tab, set up the following attributes with the applicable rule sequence:

This is a table that lists all the values of attributes and the corresponding rule sequences.

Attribute	Attribute Value	Sort Order	Rule Sequence	Consideration
Item	AB1	Not applicable	10	All work order operations that use the Item AB1 would fall in this category. This rule sequence gets a priority of 1. Work orders that don't use this item will follow in the assignment priority sequence based on the other rule sequence values defined by you.
Planned Completion Date	Not applicable	Ascending	20	All work orders will be sorted in an ascending order based on the planned completion date from the current date. This rule sequence will get a priority of 2.
Planned Start Date	Not applicable	Descending	30	All work orders will be sorted in a descending order based on the planned start date from the current date. This

Attribute	Attribute Value	Sort Order	Rule Sequence	Consideration
				rule sequence will get a priority of 3.
Work Order Type	Standard	Not applicable	40	All standard work orders will fall in this category. This rule sequence gets a priority of 4. Work orders that are nonstandard, rework, or transform will follow in the assignment priority sequence based on the other rule sequence values defined by you.

Note: If you don't define any assignment sequence, a default assignment priority sequence will be applied. The default assignment sequence is based on ascending order of work order planned completion date first, and planned start date next.

- Click Save and select the tab Inclusion Criteria.

Material Availability Rules: Inclusion Criteria

- On the Inclusion Criteria tab, specify the following values as described in the following table.

This is a table that specifies values for some of the parameters in the Inclusion Criteria tab.

Parameter	Value	Consideration
Time Span	24	You want to plan for material availability only for work orders which will be completed in 24 hours as calculated from the current time.
Work Order Status	Released, Unreleased	You want to plan for material availability only for work orders which are currently in Released or Unreleased status (includes predefined and user-defined).
Build in WIP Items	Yes	You want to include in the material availability calculations those component items that are internally manufactured.

- Click Add in the **Excluded Components** section to specify component items which you don't want to include in the material availability calculations.

You can exclude certain component items from material availability calculations by specifying the item name and item category of those component items. You can do this for certain component items that are noncritical in the manufacturing of a final assembly, or for items that are in abundance in inventory.

Note: The Item Category list of values displays all categories of the catalog assigned to an item in the Inventory work area.

3. Click Save and select the tab Forced Assignment Criteria.

Material Availability Rules: Forced Assignment Criteria

1. Click Add in the Forced Assignment Criteria tab to exclude certain work orders from being lowered in priority on manual adjustment of the material assignment of other work orders.

For example, if a work order WO123 is reserved against sales orders for a customer of high priority, you can specify the customer name in this tab and ensure that materials used to fulfill this work order aren't distributed to other work orders, even though they might have a higher priority based on the assignment sequence and inclusion criteria.

This is a table that provides certain attribute values that you can specify to create a criteria to exclude work orders from being lowered in priority.

Attribute	Attribute Value	Consideration
Customer	ABC	All work orders reserved against sales orders for this customer will be excluded from being lowered in priority on manual adjustment of materials.
Item Category	Servers	All work orders that use items within the specified item category as their materials will be excluded from being lowered in priority on manual adjustment of materials.

2. Click Save and Close.
You have successfully defined a set of rules that's used to calculate material availability assignments.

How You Manage Work Order Material Availability Assignments

Use the Material Availability Assignments task in the Work Execution work area to view the assignment priority sequence of all work orders in your manufacturing organization. This assignment is calculated based on how you define rules using the Material Availability Rules task.

You can perform the following tasks on the Material Availability Assignments page:

- View and adjust material assignments for work order prioritization.
- Identify work orders with material availability and shortages.

- Assign materials to work orders of higher priority, from the available-to-transact quantity in inventory.
- Run the material availability background process considering or without considering substitutes either at scheduled intervals or based on business need.
- Review the work orders where substitutes are recommended. Accept substitute recommendation to replace work order materials with substitutes.
- View expected supplies of materials to address shortage.
- Manually adjust work orders assignments by performing a force assign or force unassign action.
- Change status of work orders based on material assignments.
- Export the data to a spreadsheet to analyze the material availability assignments.

Calculate Material Availability

In the Work Orders tab of the Material Availability Assignments page, you must first select the Calculate Material Availability background process to initiate the calculation engine. This identifies the work orders and work order materials for the material availability check. The calculations include materials for availability check based on the inclusion criteria rules you have specified earlier. The background process uniquely identifies the assignment priority for the list of work orders.

After the assignment priority is associated with the work orders, the material inventory available-to-transact quantity in the organization is retrieved as part of background processing, and assigned to the work order materials to arrive at the material shortage at the work order level.

If material availability is calculated considering substitutes, the scheduled process assign substitutes for Unreleased / On hold with no Release date work orders, if full quantity of the component in the work order isn't available to assign for the work order operation item.

- The scheduled process always tries to assign the component that's present in the work order first. If the component in the work order isn't available in full quantity (work order required quantity), the scheduled process tries to assign substitutes.
- The substitutes will be assigned only for the Unreleased and On Hold (no released date) work orders.
- After assigning the original component for full component requirement, if the full component quantity isn't available; substitutes would be assigned.
- Priority from structure / work definition will be honored till full quantity of primary /substitute available.
- In case of partial quantity available for the primary and substitute components, only primary components will be assigned.

For an organization that's enabled for inventory tracking by project, the material availability is calculated considering:

- The project and task referenced on the work orders, and
- The project and common inventory on-hand of the component items

View and Assess Material Assignment Priority

The Material Availability Assignments page helps you view and assess the material assignments in two separate tabs.

On the **Work Orders** tab you can view the list of recommended work orders in the order of the assignment priority. After the work orders are identified by the background process, the assignment priority is assigned to the work orders based on the unique rule sequence you defined for the various attributes of the work orders.

On the **Materials** tab you can view the various work orders that require materials and the corresponding availability and shortages pertaining to the materials. It must be noted that you can't run the Calculate Material Availability background process from the Materials tab.

After the assignment priority is associated with the work orders on completion of the background process, the following attributes are displayed:

- **Available-to-Transact Quantity:** The on-hand quantity of a material that's available for transaction in the subinventories and that has material status as nettable in the organization.
- **Projected Available Quantity:** The quantity of material available based on the work order assignment priority as defined by you.
- **Open Quantity:** The quantity of a material which is pending for issue against the final assembly of a work order.
- **Allocated Quantity:** The quantity of a material that's allocated to a work order during the picking process when a movement request is created for a work order operation item.
- **Picked Quantity:** The quantity of a material that's picked when the pick slip is confirmed and is issued either directly to the work order or is moved to the staging subinventory.
- **Shortage Quantity:** The difference of open quantity and projected available quantity of a material.
Material shortage quantity = Open quantity - (Projected Available quantity + Allocated quantity - Picked quantity)
- **Materials Available:** This is a visual indicator that shows you if materials are completely available, partially available, or not available at the work order level. This is derived from the required quantity and shortage quantity of materials.
- **Expected Supplies:** In case of shortages, you can view the expected supplies of materials against various supply documents. The documents include purchase requisitions, purchase orders, interorganization transfers, transfer orders, and work orders.

The following three tables provide an explanation of how the calculation is derived for these various quantities:

This table shows you the calculation logic before the material pick release action has taken place. The available to transact quantity for the materials box, processor, and storage unit in the manufacturing organization M1 is 100 Ea. The allocated and the picked quantity is 0 for the materials.

Work Order	Work Order Item	Start Quantity	Assignment Priority	Material	Available-to-Transact	Projected Available	Open Quantity	Allocated Quantity	Picked Quantity	Shortage Quantity	Material Available
WO1	Server1	70	1	Box	100	100	70	0	0	0	Available
				Processor	100	100	70	0	0	0	
				Storage Unit	100	100	70	0	0	0	
WO2	Server1	40	2	Box	100	30	40	0	0	0	Partially Available
				Processor	100	30	40	0	0	0	
				Storage Unit	100	30	40	0	0	0	

This table shows you the calculation logic for when the materials for the Work orders WO1 and WO2 are pick released but are yet to be pick confirmed. In this case, the available to transact quantity is depleted by the allocated quantity for the component. So the total allocated quantity for box is 70+30=100. The available to transact quantity is 100-100=0.

The shortage quantity for the material box for WO1 is 0 if (projected quantity + allocated quantity - picked quantity) is greater than or equal to the open quantity.

The shortage quantity for box for WO2 = open quantity - (projected available quantity + allocated quantity - picked quantity) which is 40-(0+30+0)=10 Ea

Work Order	Work Order Item	Start Quantity	Assignment Priority	Material	Available-to-Transact	Projected Available	Open Quantity	Allocated Quantity	Picked Quantity	Shortage Quantity	Material Available
WO1	Server1	70	1	Box	0	0	70	70	0	0	Available
				Processor	0	0	70	70	0	0	
				Storage Unit	0	0	70	70	0	0	
WO2	Server1	40	2	Box	0	0	40	30	0	10	Partially Available
				Processor	0	0	40	30	0	10	
				Storage Unit	0	0	40	30	0	10	

This table shows you the calculation logic for when the materials for the Work orders WO1 and WO2 are pick released and also pick confirmed. In this case, the available to transact quantity is incremented with the picked quantity for the materials. So for the material box for WO2, the shortage quantity = open quantity - (projected quantity + allocated quantity - picked quantity) which is 40-(30+30+30)=10 Ea.

Work Order	Work Order Item	Start Quantity	Assignment Priority	Material	Available to Transact	Projected Available	Open Quantity	Allocated Quantity	Picked Quantity	Shortage Quantity	Material Available
WO1	Server1	70	1	Box	100	100	70	70	70	0	Available
				Processor	100	100	70	70	70	0	
				Storage Unit	100	100	70	70	70	0	
WO2	Server1	40	2	Box	100	30	40	30	30	10	Partially Available
				Processor	100	30	40	30	30	10	
				Storage Unit	100	30	40	30	30	10	

You can then manually adjust the work order material assignments based on your assessment of which materials are more critical for work orders of higher priority.

Force Assign and Force Unassign Materials

You can manually change the material assignments from the list of prioritized work orders in the Work Orders tab.

You can force assign materials to a work order, which has a material shortage. The application reassigns materials by taking materials that are assigned to work orders of lower assignment priority to satisfy the material requirement of a higher priority for which you're force assigning materials. You can assign only the primary component of a work order from higher priority work orders from all work orders' statuses including Unreleased/Released/ On Hold.

Similarly, you can force unassign materials from a work order, for which materials are either completely or partially available. The application reassigns the primary / substitute materials by taking materials from the work order you force unassigned, and assigns them to work orders, which have a material shortage. After force unassignment, some substitute components may have partial assignment.

For an organization that's enabled for inventory tracking by project, you can force unassign project-specific inventory currently assigned to a work order. The unassigned components are assigned to other work orders considering the project and task details and the **User from common** item attribute for components.

Note: When you force assign a work order, the materials are taken from work orders in the descending order of assignment priority. When you force unassign a work order, the materials are released to work orders in the ascending order of assignment priority.

The following table illustrates an example of such a scenario:

Work Order	Assignment Priority	Action Taken	Material Available	Result
WO1	4	Force Assign	Partially Available	Materials are unassigned from WO2, WO3, and WO4 respectively to fulfill the shortage required for the manufacturing of an assembly for the work order WO1.
WO2	3	Not applicable	Partially Available	Material quantity assigned to this work order is unassigned first by the application when you select force assign for WO1. As shortage isn't yet satisfied, it keeps moving down the list of work orders.
WO3	2	Not applicable	Partially Available	Material quantity assigned to this work order is unassigned second by the application when you select force assign for WO1. As shortage isn't yet satisfied, it keeps moving down the list of work orders.
WO4	1	Not applicable	Completely Available	Material quantity assigned to this work order is unassigned third by the

Work Order	Assignment Priority	Action Taken	Material Available	Result
				application when you select force assign for WO1. Now shortage is satisfied for WO1.

While changing the material assignment, you can preview the changes affecting the selected work order and other impacted work orders that are prioritized or lowered in priority. A visual indicator of reassigned materials is also displayed in the list of work orders once you implement your changes.

Replace Components with Substitutes

You can now calculate material availability for work orders using an additional option, Calculate Material Availability with Substitutes for all manufacturing work orders. Upon choosing this option, the material availability calculation, includes the substitutes defined for the items and gives an indication of material availability including substitute inventory availability.

The Accept and Confirm Substitutes action will be enabled for only work orders where substitutes are recommended based on material availability assignment scheduled process.

The Accept and Confirm Substitutes action will work for work orders in Unreleased and On Hold (No Released date) statuses. When you accept the the substitute recommendation, the components are successfully replaced in work order and the the Accept and Confirm Substitutes button will not be displayed. The Substitute recommended icon disappear and a check mark icon would be displayed.

You can replace the full quantity of a component with a substitute in a unreleased work order. However, partial quantity replacement isn't supported.

Here are a few things that you will see observe when components are replaced with substitutes:

- The attributes such as item, description, quantity per product, required quantity, and UOM are copied from the substitute item.
- The subinventory and locator are copied as per item definition (or from Plant parameter, in the same order).
- Attachment from primary item gets deleted while swapping the substitute component. The DFFs will be copied in the substituted item.
- Reservation for the primary item, if available will be deleted when the components are substituted.
- Attachments aren't copied when components are replaced with substitutes.
- The Substitute icon would disappear, and tick mark would be displayed for substituted.
- The substitutes in the header section display with Substituted status.
- The substitute column gets updated to substituted status from the Substitute Recommended icon.
- An icon indicating substitutes recommended for the work order is shown in the results window. The icon indicates if materials are available for a work order for all primary items on the item structure, or using substitutes for one or more items.

Here's what indicates when there's any change in the Substitutes column:

- If substitutes are defined and assigned (including for some of the components for which substitute is defined), then the icon is enabled
- If substitutes are defined but not assigned, then the icon is disabled
- If substitutes are not defined, then displays as blank

Change Status of Work Orders

You can either change status of a single work order or status of multiple work orders in the Work Orders tab after you have previewed the material assignments and adjusted your changes accordingly.

Select one of the following mass actions to change status of multiple work orders simultaneously:

- **Release:** Release the prioritized work orders with all critical materials available to the shop floor for execution.
- **Release and Pick Materials:** Release the prioritized work orders and initiate the scheduled process for picking of materials that are required for the production on the shop floor.
- **Unrelease:** Unrelease the previously released work orders if they're of a lower priority.
- **Hold:** Place work orders with material shortages on hold until expected supplies are available in inventory.
- **Cancel:** Cancel work orders which are no longer required in your organization.

Related Topics

- [Overview of Work Order Material Availability Workbench](#)
- [How Work Order Material Availability Rules and Assignments Work Together](#)
- [How You Pick Materials for Work Orders](#)
- [How Shortage Quantity Is Calculated](#)
- [Defining Work Order Material Availability Rules: Worked Example](#)

How Shortage Quantity Is Calculated

On the Manage Material Availability Assignments page in the Work Execution work area, you can view the assignment priority sequence of all work orders in your organization. You can also view the various work orders that require material and the corresponding availability and shortage pertaining to the material.

The following is the calculation logic for shortage quantity of a material:

Shortage quantity = Open quantity - (Projected available quantity - Allocated quantity - Picked quantity)

Related Topics

- [How You Manage Work Order Material Availability Assignments](#)
- [How You Pick Materials for Work Orders](#)

Direct Procurement of Materials for Work Orders

Overview of Direct Procurement of Materials

You can procure materials directly for work order operations. You can do the following:

- Initiate the creation of a purchase requisition against a work order operation to manually procure items that are required to execute a specific work order operation.

This capability is also supported for project-specific work orders. The project and task on the work order are defaulted onto the requisition line and you are required to enter other project costing attributes such as expenditure type and expenditure item date. It's important to note that the project/task on the requisition line must match with project and task on the associated work order.

This capability is also supported for items that are directly procured for work orders with lot and / or serial controlled items.

- View the list of items procured for work order operations in a work order and the purchasing document details.
- Initiate corrective actions required to manage the purchased items, such as returning materials to suppliers or receiving and correcting receipt or return quantities from Receiving.
- Display purchased items for work orders in production reports and transaction history.
- View lot and serial numbers of items that are directly procured for work orders in transaction history.
- Analyze purchased items for work orders in Oracle Transactional Business Intelligence (OTBI) which displays the analysis of purchased items for work orders.

How You Review Purchased Item Details

In your organization, there might be a scenario where you need to ensure that you can make certain unplanned parts or items that are required for work order completion.

Select the work order using the Manage Work Orders task, and in the Edit Work Order page, you can view the details of the purchased items for each operation. You can also click the Review Purchased Item Details action to navigate to the page to review the purchasing and receipt details of items that are procured for the work order.

If your organization is set up as a maintenance organization in the Manage Plant Parameters page in the Setup and Maintenance work area, you can also select the **Create Requisitions** action and navigate to the self-service page in Procurement to shop and create requisitions for items that you want to directly purchase for a work order. You can track the requisition, purchase order, and receipt details of items procured for your maintenance or manufacturing work orders on the Purchased Item Details page.

Note: In your organization, if the **Allow Direct Purchases for Work Orders** parameter is set up, you will be able to create requisitions for items that you want to directly purchase for a work order. For a maintenance organization, this parameter is enabled by default, and for a manufacturing organization, it's disabled by default.

The following table lists all the details that you can review and track on the Purchased Item Details page.

Attribute	Description
Operation Sequence	The specific operation that you selected on the Operations tab on the Edit Work Order page.
Item	The unique number of an item that has been purchased for the work order operation. You can click on the icon beside the item for more details.
Item Description	The description of the item as defined in the item-organization setup.

Attribute	Description
Requisitioned Quantity or Amount	Total requested quantity in all approved purchase requisitions and in pending approval status for the item. Requisition quantities in incomplete, rejected, withdrawn, canceled, and returned statuses aren't considered.
Ordered Quantity or Amount	Total ordered quantity in all approved purchase order lines for the item. Only approved orders in open and closed statuses are considered.
Received Quantity or Amount	Total quantity delivered against all purchase order lines for the item. This also takes into account the quantity that's returned to supplier and to receiving.
Details	You can click on the Details icon to drill down into the purchasing and receiving details.

Note: Dual units of measure is supported in item procurement. To support dual units of measure tracking of items that are procured directly for work orders, the Purchasing and Receiving Details regions of the Review Purchased Item Details page have been enhanced to display the secondary quantity and secondary unit of measure for requisitions, purchase orders, and receipts. In addition, users can now enter secondary quantity while performing receipt corrections and returns.

Related Topics

- [How You Track Purchasing Details of Procured Items in Manufacturing](#)
- [How You Track Receiving Details of Procured Items in Manufacturing](#)

How You Track Purchasing Details of Procured Items in Manufacturing

Review and track the items for which your organization has created requisitions on the Purchased Item Details page. You can select the Details icon beside any of the purchased item for a work order operation to further drill down into the details of purchase order lines and receipt lines.

In case there is a disparity in the requisitioned, ordered, and received quantities, you can view the Purchasing Details section to analyze the details and decide if you want to return the item to the supplier or return the item to receiving. You can take corrective actions from Receiving to correct the quantity and amount if the data has been be wrongly entered.

The following table lists all the details that you can review in the Purchasing Details section:

Attribute	Description
Requisition Number	You can click on the specific requisition identification number to view the requisition document.

Attribute	Description
Requisition Line	The number of the requisition line for the purchased item.
Requisition Quantity or Amount	The quantity or amount of item that was specified in the requisition.
Requisition Requested Date	Date on which your organization requested for purchase of items, as specified in the requisition document.
Requisition Status	Status of a receipt line for a purchased item. The status can be approved or pending.
Purchase Order Number	You can click on the specific purchase order identification number to view the purchase order document.
Purchase Order Line	The number of the purchase order line for the purchased item.
Purchase Order Schedule	Number assigned by the application to track multiple schedules for the purchase order line
Purchase Order Quantity or Amount	Quantity or amount that was specified for the single line in the purchase order.
Purchase Order Requested Date	Date as specified on the purchase order on which the items were requested to be delivered by the supplier.
Purchase Order Promised Date	Date as specified on the purchase order on which the items were promised to be delivered by the supplier.
Purchase Order Status	Status of a purchase order line for the requisitioned item. The status can be closed, or open.
Received Quantity or Amount	Quantity of the purchased item that's delivered to the work order.
Supplier	Name of the supplier as specified in the purchase order, who supplies the item that has been requisitioned.
Supplier Site	Name of the supplier site as specified in the purchase order, from where the requisitioned item is supplied.

Related Topics

- [How You Review Purchased Item Details](#)
- [How You Track Receiving Details of Procured Items in Manufacturing](#)

How You Track Receiving Details of Procured Items in Manufacturing

Review and track the items for which your organization has created requisitions on the Purchased Item Details page. You can select the Details icon beside any of the purchased item for a work order operation to further drill down into the details of purchase order lines and receipt lines. While reviewing the Purchasing Details, you can also click on any purchase order line and review the receipt details for that line.

The following table lists all the details that you can view in the Receiving Details section for a particular purchase order line that you have selected.

Attribute	Description
Receipt	You can click on the specific receipt identification number to view the document and track the received quantities of the purchased item.
Line Status	Status of a specific receipt line for the purchase order.
Quantity	Quantity of purchased item that has been delivered to the work order.
Transaction Date	Date on which the delivery transaction was reported.
Transacted By	Name of the person who completed the delivery transaction.

If you're not satisfied with the delivered items, you can return the items. You can also take the following actions from Receiving:

- **Correct:** You can correct clerical errors in delivered quantity or in returns to receiving and return to suppliers. This will correct the receipt quantity if the status is Deliver, or it will correct the returned quantity if the line status is Return to Supplier or Return to Receiving.
- **Return to Supplier:** You can initiate a return of the purchased item to directly to the supplier from whom you procured the item. This can be done if the receipt line status is Deliver.
- **Return to Receiving:** You can initiate a return of the purchased item to directly to the receiving department. This can be done if the receipt line status is Deliver.

Note: For amount-based purchase orders, you can only correct the amount. You can't return the item to supplier or receiving.

Related Topics

- [How You Review Purchased Item Details](#)
- [How You Track Purchasing Details of Procured Items in Manufacturing](#)

How You Manage Work Orders for Contract Manufacturing

Contract Manufacturing refers to scenarios where an Original Equipment Manufacturer (OEM) outsource their manufacturing process to another organization commonly known as a Contract Manufacturer (CM).

A contract manufacturing flow can be initiated either to fulfill a sales order, or as a result of implementation of supply chain planning recommendations. In either case, supply orders are created in Oracle Supply Chain Orchestration, after which Supply Chain Orchestration initiates the creation of a work order in Oracle Manufacturing, to track the progress of manufacturing at the contract manufacturer's facility. Supply Chain Orchestration sends a request to Purchasing to create a purchase order on the contract manufacturer, for the contract manufacturing service item.

In a contract manufacturing plant:

- You can search for work orders based on purchase order header and line.
- You can't create a standard work order.
- You can't create a nonstandard order.
- You can't update the work order. However, for serialized assemblies, you can edit the serial numbers.
- You can't perform work order mass actions.
- You can't create a rework or a transform work order.
- You should ensure that there is a one-to-one correlation between a contract manufacturing work order and the corresponding purchase order line.
- You should not group multiple requisition lines into a single purchase order line.
- Although you can specify the job profile and equipment profile for a resource in the work order, it won't be enforced for contract manufacturing work order transactions.

In a contract manufacturing plant, you can preassign output lot numbers and the work order number can be defaulted as the preassigned lot number during the work order creation based on the plant parameter setting. When Supply Chain Orchestration creates a work order in manufacturing, the preassigned lot is automatically written to an .xml file.

In a contract manufacturing plant, it's recommended to set the attribute **Autogenerate of Serials at Creation of Work Order at Plant Level** to **Yes** for serialized manufacturing. When Supply Chain Orchestration creates a work order in manufacturing, the serials are automatically generated, and the generated serials are automatically written to an .xml file.

This .xml file is automatically attached to the work order with attachment type **To Supplier**. You can view the same attachment containing the lot / serials in the Purchase Order line.

Note: You can't import contract manufacturing work orders using the FBDI template or through REST services.

Note: Process work orders for contract manufacturing are currently not supported.

Related Topics

How You Import Discrete Work Orders

Work order import is a method of creating and updating work orders through the user interface. You can use the cloud import framework to import the work order using spreadsheets. You can also provide the descriptive flexfields information during the work order import.

To import discrete work orders using the cloud import framework, you can download and use the WorkOrderTemplate.xlsm.template. The .xlsm template organizes the work order information in the following tabs:

- **Instructions and CSV Generation:** The procedure to import work orders using the .xlsm template.
- **Import Batch:** The batch identifies the group of work orders that are being imported.
- **Work Order Headers:** The work order header information is identified uniquely by a header number within a batch. You can import work orders across plants within a batch.
- **Work Order Operations:** You can optionally specify work order operation information against the batch code and header number.
- **Work Order Operation Materials:** You can optionally specify work order operation item information against the batch code, header number, and operation sequence.
- **Work Order Operation Resources:** You can optionally specify work order operation resources information against the batch code, header number, and operation sequence.
- **Work Order Serial Numbers:** You can optionally specify product serial information against the batch code and header number for serial-tracked work orders.
- **Work Order Operation Resource Instances:** You can optionally specify work order operation resource instances information against the batch code, header number, and operation sequence.
- **Material Lots, Serials, Lots and Serials:** Applicable only for rework work orders

Work orders can be imported in batches using create and update modes either by providing the basic work order header details or by providing the complete details of work order header, operation requirements, resource requirements, component requirements, and serial details.

The following table lists the various modes of import that enable you to create or update work orders:

User Preference	Header Action	Operations Action	Items and Resources Action	Serials Action	High-Level Considerations
To create work order with header only (standard work order or nonstandard work order with work definition)	CREATE	Not Applicable	Not Applicable	Not Applicable	You must specify the following with other necessary details: Work Definition details Allow Explosion =Y Scheduling method = DEFAULT_SCHEDULER
To create work order with header and details, and to allow the scheduling engine	CREATE	CREATE	CREATE	ASSOCIATE_SERIAL	You must specify the following with other necessary details:

User Preference	Header Action	Operations Action	Items and Resources Action	Serials Action	High-Level Considerations
to determine the dates.					Work Definition details (for Standard work orders) Allow Explosion = N Scheduling method = DEFAULT_SCHEDULER
To create work order with header and details with dates specified.	CREATE	CREATE	CREATE	ASSOCIATE_SERIAL	You must specify the following with other necessary details: Work Definition details (for Standard work orders) Allow Explosion = N Scheduling method = NO_SCHEDULING
To update the work order.	UPDATE	CREATE, UPDATE	CREATE, UPDATE	ASSOCIATE_SERIAL, DE_ASSOCIATE_SERIAL	Not Applicable

Tip: If the Plant parameter **Automatically associate serial numbers during work order import** is enabled during import, the serials are automatically generated and associated for serial-tracked work orders.

You can create, update, and query for a work order using a REST API.

The successfully imported work orders as well as the errors if any are displayed in the Schedule Process output.

Correct Work Orders for Import

You can use the **Correct Work Orders and Transactions for Import** task in the Work Execution work area to view all the file-based data import records that resulted in errors, and you can also export them into ADFdi spreadsheets to correct the errors. After you have corrected the errors in ADFdi, you can upload the spreadsheet to resubmit the records that returned errors for processing.

Note: You can use this task to correct errors only for transaction records where the mode of import was file-based data import. You can't correct errors for import transaction records created through REST API.

Follow these steps to correct the errors and resubmit the completed data for work order import:

1. In the Work Execution work area, select the Correct Work Orders and Transactions for Import task from the Tasks panel.

2. Use the filters to search for specific import transaction entries. You can use a combination of the following filters to search for the work orders import transactions:
 - o Select the import transaction type as **Work orders import**.
 - o Search for the unique batch code identifier of your import batch.
 - o Search for the transaction based on the batch status. If the batch completed but has some errors that you must redress, you can search with **Completed with errors**. If the batch is still in process due to server failure or any other application error, you can search with **In process**.
 - o Search for the transaction record based on the request identifier of the corresponding import work orders scheduled process.
3. The search results displays a list of all the relevant import transaction records. Click **Manage in Spreadsheet** to initiate the correction process through ADFdi.
4. The Work Orders Import ADFdi has separate worksheets for its various attributes. You can manually correct the errors and then set the batch status of the individual rows to Ready.
5. After you have corrected all the errors and saved the statuses as ready, click Upload to resubmit the corrected records for processing. You have to upload each worksheet individually.
6. You can refresh your search on the Correct Work Orders and Transactions for Import or search on the basis of the batch status as Ready to view if the corrected records were successfully processed.

Note: For more information about file-based data imports to import or update legacy and other data into Supply Chain Management Cloud from external applications, refer to the File-Based Data Import for Oracle Supply Chain Management Cloud Development Guide.

Note: Correct work orders for import is supported for both discrete and process manufacturing.

Related Topics

How You Import Process Work Orders

Work order import is a method of creating and updating work orders through the user interface. You can use the cloud import framework to import the work order using spreadsheets. You can also provide the descriptive flexfields information during the work order import.

To import work orders using the cloud import framework, you can download and use the ProcessWorkOrderTemplate.xlsx template. The .xlsx template organizes the work order information in the following tabs:

- **Instructions and CSV Generation:** The procedure to import work orders using the .xlsx template.
- **Import Batch:** The batch identifies the group of work orders that are being imported.
- **Work Order Headers:** The work order header information is identified uniquely by a header number within a batch. You can import work orders across plants within a batch.
- **Work Order Operations:** You can optionally specify work order operation information against the batch code and header number.
- **Work Order Operation Resources:** You can optionally specify work order operation resources information against the batch code, header number, and operation sequence.

- **Work Order Operation Resource Instances:** You can optionally specify work order operation resource instance information against the batch code, header number, and operation sequence.
- **Work Order Serial Numbers:** You can optionally specify product serial information against the batch code and header number for serial-tracked work orders.
- **Work Order Operation Resource Instances:** You can optionally specify work order operation resource instances information against the batch code, header number, and operation sequence.
- **Work Order Operation Materials:** You can optionally specify work order operation item information against the batch code, header number, and operation sequence.
- **Work Order Operation Outputs:** You can optionally specify work order operation output information against the batch code, header number, and operation sequence.

How You Close Work Orders

You can periodically close work orders after they have been executed by using the Close Work Orders program. Through this program, you can select multiple work orders using parameters such as work order number, dates, status, and items. The close program will ignore the pending transaction records in the interface that are more than 30 minutes old and you need not run purge program every time for closing work orders. The successfully closed work orders as well as the errors if any, are displayed in the scheduled process output. You can't make any further updates to closed work orders.

Note: You can update the closed date for work orders when you close them using the scheduled process.

Related Topics

How You Create Configured Item Work Orders

Configure to Order (CTO) is the process of ordering and fulfilling configured products. Configured products are either procured or made to order, and can result in back-to-back purchase orders, drop ship purchase orders, back-to-back internal material transfers, or back-to-back production orders. Typically, Supply Chain Orchestration creates the work order for the parent Assemble to Order (ATO) model configuration. Work orders for child ATO model configuration are created by Supply Chain Planning.

A work order is created based on the configured item work definition. A configured item work definition is created dynamically by taking the base Assemble to Order (ATO) model work definition, selected options, Transactional Item Attributes (TIA), and applicability rules as entries. When the application automatically creates work orders for the configured items in the CTO flow, the application considers the primary ATO Model work definition. You can manually create work orders for a configured item, and you can choose any particular work definition of the related ATO model for work order creation.

Features of work execution and manufacturing execution, such as manually creating work orders in the user interface, are also available for configured items work order.

When configuring the order in Oracle Fusion Configurator, you can select and enable Transactional Item Attributes (TIA). The TIA based applicability rules defined in the ATO model work definition determine the operations to be included in the configured item work definition.

Configured item work orders and manufacturing execution user interfaces display the TIA information, if TIA application scope is enabled for Configuration Matching and Manufacturing Execution. The TIAs can be viewed for information purposes in:

- Work Order Header
- Work Order Operation
- Detail Complete-Product User Interface

When you create a work order either manually (through the user interface, web services or bulk load), or automatically (by the application in a CTO flow) for a configured item, the **Configuration Transactional Item Attributes** selected during order configuration are displayed.

Related Topics

How You Create Work Orders from Automatic Work Definitions

If the work definitions your enterprise uses are created automatically, your work orders incorporate certain characteristics.

If there are changes to the item structure in future, these changes are synchronized automatically to the work definition. These changes then reflect on the standard work order.

When you create a standard work order from an automatic work definition, the work order has only one operation, which is the standard operation selected as the default for the automatic work definition. All of the item structure components are assigned to this default standard operation.

The work definition effective date as displayed on the Create Standard Work Order dialog box determines which components are effective in the item structure on that date, and those are the components that are included as work order operation items.

Related Topics

- [Considerations for Generating Automatic Work Definitions](#)
- [How Automatic Work Definitions Are Created](#)

Considerations for Creating Work Orders from Planning With Alternate Resources and Substitute Components

In your enterprise, there can be a scenario where your supplier is unable to deliver components timely, or there is an unexpected breakdown of a critical equipment resource. In such cases, Oracle Fusion Supply Chain Planning can create

recommendations for alternate resources and substitute components from the work definition to support the execution of a standard work order.

When planning recommends alternate resources and substitute components for work orders, the following points must be considered:

- Components are replaced with their substitutes at the first level, and not at the phantom level.
- Resources are replaced with the alternates at the first level, and not at the phantom level.
- The required quantity of the substituted component is calculated based on aggregated yield if the same component is repeated at multiple levels.
- A standard item can only be substituted with another standard item and a primary item is added in the list of substitutes.
- The replacement of alternate resources is always a full replacement.
- The replacement of substitute components can be a partial replacement.

Related Topics

- [Guidelines for Using Alternate Resources and Substitute Components for Planned Orders](#)

How You Manage Supplier Operations

Use the Manage Supplier Operations page in Work Execution work area to manage and execute supplier operations in outside processing. It lists the quantities at supplier operations (with operation type Supplier) by the dispatch statuses in a tabular format. This format has several visual cues highlighting the records that require attention.

The Manage Supplier Operations page serves as a single place for production supervisors to perform the following tasks:

- Report operation transactions by quantity or serial number associated with the work orders at a supplier.
- Report component usage at a supplier operation by quantity or serial number.
- Review work order details.
- Print work order traveler and product labels.
- Review supplier operation details.
- Review supplier operation exceptions.
- Report production exception at a supplier operation.

You can access the Manage Supplier Operations page by selecting the Manage Supplier Operations task in action panel tab in the Work Execution work area.

Note: You can access the Review Supplier Operation Details page if a role assigned to you has the Review Supplier Operation Details (WIP_REVIEW_SUPPLIER_OPERATION_DETAILS_PRIV) privilege. For more information about privileges, refer to the Oracle Supply Chain Management Cloud Security Reference for Manufacturing and Supply Chain Materials Management guide.

Using the search feature in the Manage Supplier Operations page, you can do the following:

- You can search for the supplier operations by using the most commonly used search attributes such as work order, status, start date, completion date, item, serial, purchase order, purchase order line, purchase order schedule, receipt number, and outside processing item.
- You can use the application default search that retrieves the supplier operations which have quantities in In Process and Ready status. By default the records are sorted by the earliest completion date.
- You can also create and use a personalized saved search.
- You can configure the search to run automatically every time you sign into the application.

Note: When querying for supplier operations based on start date or completion date, shift times are interpreted by the application in the plant time zone. However, named dates such as Today, Yesterday, and so on are interpreted in the user time zone.

Using the Manage Supplier Operations Page

The Manage Supplier Operations page displays work order operation records

The following table lists all the attributes of a supplier operation along with their descriptions:

Field	Description
Quantity	Refers to the quantity of the work order operation in a specific dispatch status.
UOM	Represents the unit of measure of the quantity being manufactured.
Status	Represents the current dispatch status of quantities at any specific supplier operation, such as In Process, Ready, Completed, Scrapped, or Rejected.
Item	Refers to the item on the work order that must be manufactured.
Item Description	Refers to the description of the item that must be manufactured.
Work Order	Refers to the work order number suffixed with the operation sequence. The work order number is displayed as a link that enables you to navigate to the work order page to review the work order details.
Operation Name	Refers to the name of the operation.
Attachments	<p>The Attachment icon is conditionally displayed beside the work order operation or in the expanded region of the work order operations. The attachments from the following entities are displayed in separate tabs when you click the Attachments icon:</p> <ul style="list-style-type: none"> • Work order • Work order operation • Work order operation instructions • Work order operation material • Work order operation resource

Field	Description
	<p>Note: Based on your opt-in, you can see attachments in the Work Order Operation Instructions tab from document items in the work order operation that displays the attachments including documents, images, pictures, 3D views or any form of visual documents. You see the active revision of the attachment from currently effective revision of the document from Master Organization.</p> <p>In addition, the attachments from the following are also displayed in separate tabs for work orders which are reserved as supply to back-to-back sales orders for standard and configured items.</p> <ul style="list-style-type: none"> • Sales order header • Sales order line <p>If you're a production operator, you can also add new work order operation attachments from the dispatch list</p>
Exceptions	<p>The Exceptions icon is conditionally displayed beside the work order operation. The following information is presented to you in a separate tab when you click the Exceptions icon:</p> <ul style="list-style-type: none"> • Exception Number • Exception Type • Description • Severity • Operation Sequence • Exception Status • Reported On • Reported By <p>You can close an exception by selecting a row. You can also click on a specific exception number to drill into that exception and edit the exception.</p>
Start Date	<p>Refers to the scheduled start date and time of the work order operation.</p> <p>Note: The start date and time is displayed and with a warning icon if it's past due and the corresponding quantity is in Ready dispatch status.</p>
Completion Date	<p>Refers to the scheduled completion date and time of the work order operation</p> <p>Note: The completion date and time is displayed and with a warning icon if it's past due and the corresponding quantity is in Ready or Reject dispatch status.</p>
Priority	<p>Refers to the work order execution priority.</p>
Customer	<p>Refers to the customer name on the sales order to which the work order is reserved as a supply. If there are multiple customers, then the page displays Multiple instead of the individual customer names.</p>
Report Material Transactions	<p>Refers to the functional icon to navigate to the Report Material Transactions page to manually report the material used at a supplier operation.</p>

Field	Description
Report Resource Transactions	Refers to the functional icon to navigate to the Report Resource Transactions page to manually report resources used at a supplier operation.
Supplier	Refers to the supplier name on the related outside processing purchase order. If the operation is outsourced to more than one supplier, then the page displays Multiple instead of the individual supplier names.
Supplier Site	Refers to the supplier site on the related outside processing purchase order. If the operation is processed at more than one supplier site, then the page displays Multiple instead of the individual supplier site names.
Outside Processing Item	Refers to the outside processing item that's associated with the supplier operation.
Review Supplier Operation Details	Refers to the functional icon to navigate to the Review Supplier Operation Details page to review purchasing, shipping and receiving details related to the supplier operation and take supplier operation actions.

For any specific record displayed in the Manage Supplier Operations page, you can do the following:

- Report operation transactions at a supplier operation by quantity or serial number at a supplier operation by expanding the record and using the Quick Complete or Complete with Details action. If the material or work order product/output is a dual units of measure item, which means the Tracking Unit of Measure is set to primary and secondary, then you can specify the secondary quantity for the material or product/output.

In a non-dual units of measure scenario, if the last operation is a supplier operation, the application automatically completes the supplier operation if the product isn't lot or serial enabled. The quantity of the outside processing service item's receipt is used as the completed quantity of the product.

In a dual units of measure scenario, if the last supplier operation is a supplier operation, the application automatically completes the supplier operation if the product has defaulting control Fixed and isn't lot enabled. The application moves the last supplier operation to the Ready status if the product has defaulting control Default or No Default. The secondary quantity of the outside processing service item's receipt isn't used as the secondary quantity of the outside processing finished good. While completing the supplier operation, if the defaulting control of the product is Default, then the application defaults the secondary quantity of the product, which you can override. If the defaulting factor of the product is No Default, then you must manually specify the secondary quantity of the product.

Note: You can report operation transactions if a role assigned to you has the Report Operation transactions (WIP_REPORT_OPERATION_TRANSACTIONS_PRIV) privilege associated to it. For more information on reporting operation transactions at a supplier operation, refer to the Report Operation Transactions topic in the Execute Production chapter.

- Print work order traveler and product labels by selecting the option from the Action menu.
- Review the related work order details by clicking the work order link.
- Review production exceptions if any, for a supplier operation if any by clicking on the exceptions icon displayed beside the work order and operation sequence.

- Report material usage at a supplier operation by clicking the report material transaction icon. If the material is a dual units of measure item, which means the Tracking Unit of Measure is set to primary and secondary, then you must specify the secondary quantity for the material.
- Report output completion at a supplier operation by clicking the report output transaction icon. If the output is a dual units of measure item, which means the Tracking Unit of Measure is set to primary and secondary, then you must specify the secondary quantity for the output.
- Report resource usage at a supplier operation by clicking the report material transaction icon.
- Review the supplier operation details by clicking the review supplier operation details icon.
- Report a production exception by selecting the option from the Action menu.

Related Topics

- [How You Review Supplier Operation Details](#)

How You Review Supplier Operation Details

Oracle Manufacturing enables you review the related details for a supplier operation in the Review Supplier Operation Details page.

You can access the Review Supplier Operation Details page by clicking any of the following:

- Supplier Operation Details action for a supplier operation in the Work Order Operations tab.
- Review Supplier Operation Details functional icon in the Manage Supplier Operations page.
- Supplier Operation link of a supplier operation in the Exception tab.

Note: You can access the Review Supplier Operation Details page only if a role assigned to you has the Review Supplier Operation Details (WIP_REVIEW_SUPPLIER_OPERATION_DETAILS_PRIV) privilege. For more information on privileges, refer to the Oracle Supply Chain Management Cloud Security Reference for Manufacturing and Supply Chain Materials Management guide.

The Review Supplier Operation Details page does the following:

- Displays purchasing (such as requisitions and POs), shipping and receiving details related to a supplier operation..
- Provides links to review additional details of purchase orders, shipments, and receipts.

The Review Supplier Operation Details page also provides several actions to manage supply side exceptions in outside processing. These actions are conditionally enabled and allow you to do the following:

- Create Purchase Requisition: Using this action, you can reinitiate purchase requisition creation to create supply for the deficit quantity in case of supply failures (such as requisition creation failures, PO cancellation, and PO quantity reduction).
- Correct, Correct Overreceipt, Return to Supplier, and Return to Receiving: Using these actions you can handle issues related to the quality and the quantity of the goods that are delivered to, or returned from manufacturing.

Related Topics

- [How You Manage Supplier Operations](#)

How You Manage Demand and Supply Side Changes in Outside Processing

Demand side changes in outside processing refer to changes to a work order with supplier operations, or as a result of reporting transactions at a count point operation prior to the supplier operation which impacts the associated purchasing and shipping documents.

The following table details the demand side change events and the corresponding actions that are automatically initiated or performed by users to handle such changes:

Event	Actions
<p>Work order quantity change</p>	<p>The work order quantity changes are propagated to Oracle Fusion Cloud Purchasing by automatically requesting Oracle Supply Chain Orchestration to create or update purchase requisitions for the differential quantity.</p> <p>Work order quantity increase:</p> <p>The Purchase Requisition Trigger plant parameter determines how work order quantity increase is propagated for supplier operations:</p> <ul style="list-style-type: none"> • If the Purchase Requisition Trigger plant parameter is set to Work order release, then a purchase requisition is created for the differential work order quantity for all the supplier operations of the work order. • If the Purchase Requisition Trigger plant parameter is set to Prior operation completion and if the first count point operation of the work order is a supplier operation, then a purchase requisition is created only for the first supplier operation for the differential work order quantity. <p>In the above cases, if a requisition creation fails, the failed record can be viewed and resubmitted from Supply Chain Orchestration.</p> <p>Work order quantity decrease:</p> <p>The Purchase Requisition Trigger plant parameter determines how work order quantity decrease is propagated for supplier operations:</p> <ul style="list-style-type: none"> • If the Purchase Requisition Trigger plant parameter is set to Work order release, then the purchase requisitions or purchase orders belonging to all the supplier operations of the work order are updated to reflect the reduced work order quantity. • If the Purchase Requisition Trigger plant parameter is set to 'Prior operation completion' and if the first count point operation of the work order is a supplier operation, then the purchase requisition or purchase order belonging to it's updated to reflect the reduced work order quantity. <p>In the above cases, if change propagation fails, a supplier operation exception is logged.</p>
<p>Work order status change</p>	<p>Work order release:</p> <p>When a work order is updated to Released status for the first time or if the work order is directly created in Released status, purchase requisitions are automatically created for the work order quantity based on the Purchase Requisition Trigger plant parameter setting. This is done by automatically requesting Supply Chain Orchestration.</p>

Event	Actions
	<ul style="list-style-type: none"> • If the Purchase Requisition Trigger plant parameter is set to Work order release, then purchase requisitions are created for the work order quantity for all the supplier operations of the work order. • If the Purchase Requisition Trigger plant parameter is set to Prior operation completion, and if the first count point operation of the work order is a supplier operation, then a purchase requisition is created for the work order quantity only for the first supplier operation. When a work order in Canceled or Closed status is subsequently updated to Released status, purchase requisitions are automatically triggered only for the eligible 'not executed' quantity. <p>In all the above cases, if a requisition creation fails, the failed record can be viewed and resubmitted from Supply Order Orchestration.</p> <p>Work order unrelease:</p> <p>A work order is allowed to be updated to Unreleased status from Released status or On Hold status (when Released date is populated) or Closed status or Canceled status only if there is no purchase requisition or purchase order, or any pending purchase requisition creation requests for any of the supplier operations on the work order.</p> <p>Work order cancellation:</p> <p>When work order is updated to Canceled status for reasons such as upstream demand cancellation, a warning message is displayed if any open purchase requisition or purchase order or any pending purchase requisition creation requests exist for any of the supplier operations on the work order.</p> <p>If the user decides to proceed with the status change, then a request is automatically sent to Supply Chain Orchestration to cancel the purchase requisitions or purchase orders or any open shipments created for the supplier operations on the work order.</p> <p>If the change propagation fails, a supplier operation exception is logged.</p> <p>Work order closure:</p> <p>When work order is updated to Closed status for reasons such as upstream demand cancellation or decrease in demand, a warning message is displayed if any open purchase requisition or purchase order or any pending purchase requisition creation requests exist for any of the supplier operations on the work order.</p> <p>If the user decides to proceed with the status change, then a request is automatically sent to Supply Chain Orchestration to cancel the purchase requisitions or purchase orders or any open shipments created for the supplier operations on the work order.</p> <p>If the change propagation fails, a supplier operation exception is logged.</p>
<p>Work order supplier operation date changes</p>	<p>When the supplier operation completion date is either moved in or moved out due to changes in upstream demand, then a request is automatically sent to Supply Chain Orchestration to propagate the changes in the associated purchasing documents in cases where purchase request has been initiated but the requested quantity hasn't yet been fully received, that's, receipt quantity is less than purchase order requested quantity.</p> <p>If the change propagation fails, a supplier operation exception is logged.</p> <p>Requested delivery date calculation logic:</p> <p>The requested delivery date for supplier operations is calculated while creating and updating the associated purchasing document using the following logic:</p> <ul style="list-style-type: none"> • If the supplier operation is the either the first or an intermediate operation of the work order, then the requested delivery date is determined by subtracting the postprocessing purchase lead time (in days) of the outside processing item from the next operation's start date.

Event	Actions
	<ul style="list-style-type: none"> • If the supplier operation is the last operation of the work order, then the requested delivery date is determined by subtracting the postprocessing purchase lead time (in days) of the outside processing item from the completion date of the supplier operation. • During the above scenarios, if the calculated need-by-date is less than the current date, then the need-by-date is passed as the current date.
Overcompletion	<p>When the quantity is over completed at the first count point operation, the following is applicable:</p> <p>If the Purchase Requisition Trigger plant parameter is set to Work order release, then a request is automatically sent to Supply Chain Orchestration to create purchase requisitions for all the supplier operations of the work order by an amount equivalent to the over completed quantity.</p> <p>If the Purchase Requisition Trigger plant parameter is set to Prior operation completion, then a request is automatically sent to Supply Chain Orchestration to create a purchase requisition only for the first supplier operation in sequence by an amount equivalent to the over completed quantity.</p> <p>In the above cases, if requisition creation fails, the failed records can be viewed and resubmitted from Supply Chain Orchestration.</p>
Scrap at prior count point operation	<p>When a quantity at any count operation prior to a supplier operation is scrapped, the following is applicable:</p> <p>If the Purchase Requisition Trigger plant parameter is set to Work Order Release, then a request is automatically sent to Supply Chain Orchestration to decrease the quantity on existing purchase orders for the supplier operation and all the subsequent supplier operations by an amount equivalent to the scrapped quantity.</p> <p>If the change propagation fails, a supplier operation exception is logged.</p>
Reversal of scrap at prior count point operation	<p>When a scrapped quantity is reversed to ready at any count operation prior to a supplier operation, the following is applicable:</p> <p>If the Purchase Requisition Trigger plant parameter is set to Work Order Release, then a request is automatically sent to Supply Chain Orchestration to create purchase requisitions for the supplier operation and all the subsequent supplier operations for an amount equivalent to the scrapped quantity that's reversed to ready.</p> <p>In the above cases, if requisition creation fails, the failed records can be viewed and resubmitted from Supply Chain Orchestration.</p>
Reversal of completion at prior count point operation	<p>When a completed quantity is reversed to ready at a count operation immediately prior to a supplier operation, the following is applicable:</p> <p>If the Purchase Requisition Trigger plant parameter is set to Prior operation completion, then a request is automatically sent to Supply Chain Orchestration to decrease the quantity on existing purchase order for the supplier operation by an amount equivalent to the completed quantity that's reversed to ready. Subsequent supplier operations for which the supply creation isn't yet initiated won't be impacted.</p> <p>If the change propagation fails, a supplier operation exception is logged.</p>

Supply side changes in outside processing refer to the changes to an outside processing purchase order in Oracle Fusion Purchasing. These also include supply issues related to quality and quantity of goods in outside processing that are received from or returned to the supplier.

The following table details the supply side change events and the corresponding actions that are automatically initiated or performed by users to handle such changes:

Event	Actions
<p>Requisition creation failure</p>	<p>Whenever there is failure during requisition creation, SCO notifies Oracle Manufacturing and a new production exception is automatically created indicating what needs to be done to resolve the purchase requisition creation issues.</p> <p>A production supervisor reviews the details of the exception and collaborates with a Supply Chain Application Administrator who has access to the Supply Orchestration work area to further review the details in the Supply Chain Orchestration pages. Based on the reasons of failure, users can fix the issues, and resubmit to reprocess the failed supply request or supply order line marked in exception. Alternatively, the supply request or the supply order line can be canceled requiring re-initiation of the requisition creation from the Review Supplier Operation Details page.</p>
<p>Purchase order quantity change</p>	<p>When the quantity on an outside processing purchase order is reduced due to supplier's inability to supply the requested quantity, Supply Chain Orchestration listens to the change event and communicates the details to Manufacturing. A supplier operation exception is automatically logged.</p> <p>A production supervisor reviews the supplier operation exception, navigates to the Review Supplier Operations page and triggers creation of a purchase requisition for the deficit quantity by clicking on the Create Purchase Requisition action and specifying the required quantity, suggested supplier, and supplier site.</p>
<p>Purchase order status change</p>	<p>When an outside processing purchase order is canceled due to supplier's inability to supply the requested quantity, Supply Chain Orchestration listens to the change event and communicates the details to Manufacturing. A supplier operation exception is automatically logged.</p> <p>A production supervisor reviews the supplier operation exception, navigates to the Review Supplier Operations page and triggers creation of a purchase requisition for the deficit quantity by clicking on the Create Purchase Requisition action and specifying the required quantity, suggested supplier, and supplier site.</p>
<p>Purchase order requested delivery date change</p>	<p>When the need-by-date of an outside processing purchase order is moved out due to supplier's inability to supply on the requested date, Supply Chain Orchestration listens to the change event and communicates the details to Manufacturing. A supplier operation exception is automatically logged.</p> <p>A production supervisor reviews the supplier operation exception, and takes appropriate action such as rescheduling the supplier operation to complete at a later date, or cancel the existing purchase order and create a new purchase requisition and a purchase order on a different supplier.</p>
<p>Overreceipt</p>	<p>In cases where the quantity received is more than the quantity requested or shipped on an outside processing purchase order, a production operator can use the Correct Overreceipt action in the Review Supplier Operations Details page to correct the overreceipt quantity. You need to select the desired receipt in the Receiving Details region in the Review Supplier Operations Details page for the supplier operation and click on the Correct Overreceipt button and enter the quantity to correct.</p> <p>The overreceipt quantity at a supplier operation is automatically reduced by an equivalent amount if you do either of the following:</p> <ul style="list-style-type: none"> • Report completion at the count operation that immediately precedes a supplier operation. • Confirm the shipment (if applicable) at the supplier operation.
<p>Return to supplier</p>	<p>In cases where quantities need to be returned to the supplier for reasons such as bad quality, a production supervisor can use the 'Return to Supplier' action in the Review Supplier Operations Details page to return the quantities to the supplier. You need to select the desired receipt in the Receiving</p>

Event	Actions
	Details region in the Review Supplier Operations Details page for the supplier operation and click on the Return to Supplier button and enter the quantity to return.
Return to receiving	In cases where quantities need to be returned to the receiving for reasons such as bad quality, a production supervisor can use the Return to Receiving action in the Review Supplier Operations Details page to return the quantities to the supplier. You need to select the desired receipt in the Receiving Details region in the Review Supplier Operations Details page for the supplier operation and click on the Return to Receiving button and enter the quantity to return.
Receipt and return corrections	In cases where quantities that were received or returned need to be corrected for reasons such as wrong data entry, a production supervisor can use the Correct action in the Review Supplier Operations Details page to return the quantities to the supplier. You need to select the desired receipt or return transaction in the Receiving Details region in the Review Supplier Operations Details page for the supplier operation and click on the Correct button and enter the quantity to correct.

Note: You must use the Review Supplier Operations page to correct or return quantities after they're delivered to Manufacturing. The quantities must be in **Ready** dispatch status to perform a correction or a return transaction. If you use the file-based data import process or web service to correct or return quantities after they're delivered to manufacturing, you must ensure that the requisite quantity exists in Ready status in the work order operation.

How You Enable Audit Trail for Manufacturing Work Orders

If you're an application administrator, you can enable audit trail for manufacturing work orders to comply with the US Code of Federal Regulations (CFR 21 Part 11) for electronic record and electronic signature requirements. By doing so, you let your internal and external auditors have more visibility of the work order change history.

Here's the list of work order entities for which you can enable audit trail:

- Work order
- Work order operation
- Work order operation material
- Work order operation resource
- Work order operation resource instance
- Work order operation material lot
- Work order operation material serial
- Work order operation material substitutes
- Work order product serial
- Work order operation output

What happens when you enable audit trail:

- The work order updates if any, are automatically tracked in the audit tables.

- The audit records capture the attributes that got updated. The records also capture the old and new values for each update, the date of the update, and the user who performed the update.
- You can search the change history for a specific work order.

Here are the different modes of updates which are supported for audit trail:

- Work order create and update actions are performed in the Manage Work Order page.
- Work order update action is performed in the Edit Work Order page.
- Work order create and update actions are performed through work order REST services.
- Work order update actions are performed through the FBDI process, SCO, and work order transactions.

Here's the list of work order attachments for which you can enable audit trail in the Manage Audit Policies Setup for Work Orders page:

- Work order
- Work order operation
- Work order operation material
- Work order operation resource
- Work order operation output

In addition, you can enable audit trail for the project manufacturing attributes in the Manage Audit page.

Overview of Electronic Signatures and Electronic Records for Work Order Approval

Oracle Electronic Records and Electronic Signatures is a framework you can configure for securely capturing, storing, retrieving, and printing electronic records and signatures. Using this framework, you can review electronic records for work orders and capture electronic signatures.

The Electronic Records and Electronic Signatures process for work order is initiated when the work order is put in **Released** status (or a custom status associated to **Released** status) for the first time through the user interface.

The approval process is initiated in deferred mode. Note that when the work order is put in **Pending Approval** status, and you can't edit it. The work order will be in view only mode.

After the approval flow is complete, and if the E-Record is approved, the work order is put in **Released** status (or the custom status). If the E-Record was rejected, the work order is put in the original status (this could be Unreleased or on hold or any custom status associated with these statuses).

If the E-Record was rejected, you can edit the work order and resubmit for approval to initiate a fresh Electronic Records and Electronic Signatures process. All the status changes are captured in status history.

To capture electronic signatures and generate electronic records for work order approval in an organization, you need to set up the following:

- Enable Manufacturing Work Order Approval for the Organization. Follow these steps:
 - a. In the Setup and Maintenance work area, go to the following:
 - Offering: Manufacturing and Supply Chain Materials Management
 - Functional Area: Facilities

- Task: Configure Electronic Signature Preferences
- b. Enable the Manufacturing Work Order Approval transaction.

Note: You can't disable E-Signatures for work order release when one or more work orders exist in pending approval status.

- Configure the Business Process Rules to Determine the Approvers for Work Order Approval. Follow these steps:
 - a. In the Setup and Maintenance work area, go to the following:
 - Offering: Manufacturing and Supply Chain Materials Management
 - Functional Area: Facilities
 - Task: Manage Task Configurations for Supply Chain Management
 - b. Define approval rules for Work Order Approval. The task to be configured is WorkOrderDeferredApproval.

Note: For more information about implementing E-Signatures and generating E-Records, refer to the Implementing E-Signatures and E-Records chapter of the Oracle SCM Cloud Implementing Manufacturing and Supply Chain Materials Management guide.

Related Topics

- [Overview of Electronic Signatures and Electronic Records for Standard Operation Management](#)
- [How You Capture E-Signatures and Generate E-Records for Standard Operation Management](#)

How You Capture E-Records and E-Signatures for Manufacturing Work Order Approval in Deferred Mode

You can enable the ability to capture electronic signatures and generate electronic records for work order creation, and work order update.

The Electronic Records and Electronic Signatures process for work order is initiated when the work order is put in **Released** status (or a custom status associated to **Released** status) for the first time through the user interface.

The approval process is initiated in deferred mode. Note that when the work order is put in **Pending Approval** status, and you can't edit it. The work order will be in view only mode.

After the approval flow is complete, and if the E-Record is approved, the work order is put in **Released** status (or the custom status). If the E-Record was rejected, the work order is put in the original status (this could be Unreleased or on hold or any custom status associated with these statuses).

The manufacturing work order e-record contains the following information as applicable in the work order:

- Work order header and details
- Transactional item attributes if it is a configured product
- Preassigned product lot and serial details
- Project details
- Operation details, including operation items, operation outputs, operation resources, operation item substitutes, and documents

- Material reservations
- Production exceptions
- Attachment details

You can search and retrieve electronic records in the electronic records work area using multiple search criteria like the contents of the report title, the transaction type, organization, signed date, and status. The electronic records are stored in secured document repository and cannot be modified or deleted. Oracle E-Signatures and E-Records store both the approved and rejected records.

Using a deferred approval process with notifications, the work order is held in a Pending Approval status until the approvals are obtained. Depending upon the outcome of the approval, the work order is saved in the Approved status or rolled back to the previous status. The status change history captures the change from and to Pending approval status.

Here are a few considerations for you when you capture E-Records and E-Signatures for a manufacturing work order release in deferred mode:

- You can configure different approval rules based on the work method.
- You can submit a work order for approval when the initially changing to a user-defined status that is associated with the system status of Released.
- You can't update a work order in Pending Approval status through the UI, File Based Data Import (FBDI), or REST. You must wait for the approval process to complete as approved or rejected before making further changes.
- You can't create work orders in the Released status through the UI if e-records and e-signatures are enabled for the organization. However, you can create work orders in the Released status through FBDI and REST.
- You can't submit a work order that has been previously released for e-record and e-signature approval again. Instead, you can enable audit trail to track work order changes.
- You can't release and pick a work order in a single action when e-records and e-signatures is enabled. Instead, you can release a work order and submit it for approval before picking materials.
- You can't release a work order for e-record and e-signature approval through FBDI, REST, the Material Availability Assignments page, and the Edit Production Exception page.
- You can't prevent changes to material reservations for work orders in Pending Approval status. However, you can manually coordinate when material reservation changes in Inventory need to be implemented for the affected work order before initiating the e-record and e-signature approval process.
- You can't configure the suppression of the e-signature approval based on specific conditions. However, you can configure an automatic, conditional approval based on approval rules.

Note: For more information about capturing E-Signatures and generating E-Records, refer to the Oracle SCM Cloud Using E-Signatures and E-Records guide.

How You Purge Work Order Records from Interface

Oracle Manufacturing execution transactions like work order transactions, operation transactions, material and resource transactions, order less transactions and output transactions performed via Rest, FBDI or UI are done through batch and interface records.

Post transaction completion, the batch and interface records may be retained depending on outcome status. Over a period of time, when large volume of such records get accumulated, the Purge Records from interface job can be scheduled to remove them.

Within ADFDI, you mark the header or detail interface records to be deleted, then delete the records. The records are then deleted from the table. To delete the interface batch record from ADFDI, you must run the purge program. When you run the purge program, it checks and deletes any interface batch records that had no interface header and detail records. When the header record gets deleted, all detail records for that header are deleted automatically.

SOAP services can include import material, and operation transactions that were expected to be used by contract manufacturers for milestone reporting, or in cases where the transactions reported in Manufacturing Execution System (MES) need to be imported to Manufacturing. Because, there was no way to correct and resubmit error records, the purge program was introduced to remove such records from the work order, material, resource and operation transaction interface tables.

Here's a table that explains how you can manage transactions with the **Purge Records from Interface** scheduled process.

Entity	User Interface	REST	FBDI	Error Correction and Submission
<p>Work Orders</p> <p>(For all work order types which include discrete and process and work order actions, such as create and update)</p>	<p>The data is directly inserted into the production tables.</p> <p>There's no interface table. So, there's no possibility of records getting stuck in the interface.</p> <p>Purge action isn't applicable.</p>	<p>The data is directly inserted into the production tables.</p> <p>There's no interface table. So, there's no possibility of records getting stuck in the interface.</p> <p>Purge action isn't applicable.</p>	<p>The interface table is used for processing.</p> <p>During the import process, data is populated in the interface table, and then inserted into the production table.</p> <ol style="list-style-type: none"> 1. A batch can contain multiple header interface records. Each header interface record can have multiple detail interface records. 2. If the header interface record and it's detail interface records are processed successfully, then they're deleted. 3. If the header interface record and it's detail interface records aren't processed successfully, then all are marked with 	<p>The interface table used for processing.</p> <p>ADFdi correction sheet is used to correct the error records, delete the header and child records. When a header is deleted, a cascade delete is done for all detail type records. Batch level deletion isn't supported.</p> <p>The batch records can be deleted using the Purge program, if there are no header and detail records for the batch.</p> <p>Records must not get stuck in the interface tables. If the upload contains a batch and details, but not header, when import runs it updates the batch as an error. The detail records remains at ready status. ADFdi doesn't display the details because the header</p>

Entity	User Interface	REST	FBDI	Error Correction and Submission
			<p>status completed error and aren't deleted.</p> <p>4. If all the header interface and detail interface records for the batch are processed successfully, then the batch record is deleted.</p>	<p>doesn't exist, so the details can't be deleted. Purge can't be done for the batch because details exist. The user can't do anything with them.</p>
Work Order Operation Transactions	<p>Interface records created from UI in status COMPLETED_ERRORS, COMPLETED_WARNINGS, GENEALOGY_COMPLETED are purged. IN_PROCESS records are purged after time out of 30 minutes.</p>	<ol style="list-style-type: none"> 1. IN_PROCESS status batch records and interface records with 30 minute time out are purged. 2. COMPLETED_ERRORS, COMPLETED_WARNINGS status batch and interface records are purged. 3. COMPLETED status batch records are purged, Interface records are deleted by Genealogy API. 4. GENEALOGY_COMPLETED, batch and interface records are purged. 5. Orphan batch records are to be purged in any status. 	<ol style="list-style-type: none"> 1. COMPLETED status batch records are purged, Interface records are deleted by Genealogy API. 2. GENEALOGY_COMPLETED status batch and interface records are purged. 3. COMPLETED_WARNINGS status batch and interface records are purged. 	<p>COMPLETED_ERRORS from FBDI are left for error correction.</p> <p>ADFdi correction sheet is used to correct the error records, delete the header and child records. When a header is deleted, a cascade delete is done for all detail type records. Batch level deletion isn't supported.</p>
Work Order Material Transactions	<p>Interface records created from UI in status COMPLETED_ERRORS, COMPLETED_WARNINGS, GENEALOGY_COMPLETED are purged. IN_PROCESS records are purged after time out of 30 minutes.</p>	<ol style="list-style-type: none"> 1. IN_PROCESS status batch records and interface records with 30 minute time out are purged. 2. COMPLETED_ERRORS, COMPLETED_WARNINGS status batch and interface records are purged. 3. COMPLETED status batch records are purged, Interface records are deleted by Genealogy API. 4. GENEALOGY_COMPLETED, batch and interface records are purged. 	<ol style="list-style-type: none"> 1. COMPLETED status batch records are purged, Interface records are deleted by Genealogy API. 2. GENEALOGY_COMPLETED status batch and interface records are purged. 3. COMPLETED_WARNINGS status batch and interface records are purged. 	<p>COMPLETED_ERRORS status batch and interface records aren't purged and left for error correction.</p> <p>ADFdi correction sheet is used to correct the error records, delete the header and child records. When a header is deleted, a cascade delete is done for all detail type records. Batch level deletion isn't supported.</p>

Entity	User Interface	REST	FBDI	Error Correction and Submission
		<ol style="list-style-type: none"> 5. Orphan batch records are to be purged in any status. 		
Output Transactions	Interface table is used for processing. Purge deletes the stuck (IN_PROCESS) records after half an hour.	<p>Interface table is used for processing. Purge deletes the stuck (IN_PROCESS) records after half an hour.</p> <p>Purge also deletes the successful records and error records.</p>	<p>The interface table used for processing.</p> <p>During the import process, data populated in the interface table; then inserted into the production table. If header is process successfully, header and detail records are deleted. If all headers are processed successfully, the batch is deleted. If an error is found, all interface records are marked as completed errors and not deleted.</p>	ADFDi correction sheet is used to correct the error records and delete the header and child records. When a header is deleted, a cascade delete is done for all detail type records.
Orderless Transactions	The interface table is used for processing. Purge deletes the stuck (IN_PROCESS) records after half an hour. During orderless transaction, records are inserted in WIE_WORK_ORDERS_B as well. Any stale records in WIE_WORK_ORDERS_B isn't purged by an ESS job.	The interface table is used for processing. Purge deletes the stuck (IN_PROCESS) records after 30 minutes. Purge also deletes the successful records and error records.	The interface table is used for processing. During the import process, data populated in the interface table, and then inserted into the production table. If header is processed successfully, header and detail records are deleted. If all headers are process successfully, the batch is deleted. If an error is found, all interface records are marked as completed errors and not deleted.	ADFDi correction sheet is used to correct the error records and delete the header and child records. When a header is deleted, a cascade delete is done for all detail type records.
Work Order Resource Transactions	Interface records created from UI in status COMPLETED_ERRORS, COMPLETED_WARNINGS, GENEALOGY_COMPLETED are purged. IN_PROCESS records are purged after time out of 30 minutes.	<ol style="list-style-type: none"> 1. IN_PROCESS status batch records and interface records with 30 minute time out are purged. 2. COMPLETED_ERRORS, COMPLETED_WARNINGS status batch and interface records are purged. 3. COMPLETED status batch records are purged. 4. Orphan batch records are to be purged in any status. 	COMPLETED status batch and interface records are purged.	COMPLETED_ERRORS status batch and interface records aren't purged and left for error correction.

Note: Using the Purge Records from Interface scheduled process, you can purge all the interface records and also purge unprocessed interface records. However, interface records that are yet to be interfaced to Genealogy won't be purged.

Related Topics

Synchronization to IoT Production Monitoring

How you Synchronize Work Orders

After you have set up your integration with Oracle Production Monitoring, part of the Oracle Fusion Cloud IoT Intelligent Applications, work orders are synchronized in real time using a push mechanism. This synchronization ensures that the latest information in Oracle Fusion Cloud Manufacturing is available in Production Monitoring on a real time basis.

You must synchronize the Equipment and Labor Resources and Resource Instances to Production Monitoring before synchronizing the work orders. As a part of work order synchronization, these entities are synchronized.

- Product
- Work Order Header
- Work Order Operation
- Work Order Operation Output
- Work Order Operation Resource
- Work Order Operation Resource Instance

As a part of the work order synchronization process, Product item is synchronized first.

When you create or update a work order, header information, such as work order number, expected production quantity, status, dates, and so on are synchronized in Production Monitoring.

When you create, update, or delete a work operation, the corresponding operation information is synchronized in Production Monitoring.

When you create, update, or delete an operation output, the corresponding co-products and by-products information is synchronized in Production Monitoring.

When you create, update, or delete a work operation resource, the corresponding resource information is synchronized in Production Monitoring.

When you assign or delete a work operation resource instance, the corresponding changes are synchronized in Production Monitoring.

After work order information and resource instance assignments are synchronized, Production Monitoring can automatically report operation completion transactions using sensor data connected to the machines.

How You Manage Synchronization Errors

After you have set up your integration with Oracle Fusion Cloud IoT Production Monitoring, data is continuously synchronized from Oracle Manufacturing to IoT Production Monitoring. There may be instances of technical errors when sending information to IoT Production Monitoring, such as environment instance is down, login credentials have changed, network error, and so on. There may be also instances where IoT Production Monitoring can't process the synchronization for reasons, such as a dependent entity like resource instance is missing, a technical server error and so on. In all such cases, you will be able to complete your task in manufacturing without interruption while the application will automatically track the synchronization errors separately in the background.

Review Synchronization Errors

You can view the summary count and review details of errors encountered during synchronization using the Monitor and Resubmit IoT Synchronization Errors user interface. You can then take corrective actions to resolve the source of errors.

Resubmit Synchronization Errors

You can process the errors manually by selecting specific records and resubmit them for synchronization using the Monitor and Resubmit IoT Synchronization Errors user interface. You can also automatically reprocess errors at regular intervals by running the Synchronize with IoT Production Monitoring cloud scheduled process in the Error Reprocessing mode.

5 Execute Production

Overview of Production Execution Tasks

Oracle Fusion Cloud Manufacturing offers several features that facilitate the work order based and orderless production executions for discrete manufacturing. For process manufacturing, work order based execution is supported. The production reporting is simplified by enabling you to report the production transactions in just two clicks.

You can use the Work Execution work area to complete all tasks related to production execution if you've been assigned a job role your enterprise uses for production operator work.

For work order-based execution, you can use the dispatch list that provides all the information that a production operator requires to perform the tasks. You can use the dispatch list to report the material, operation, and resource transactions from one single location. You can review the work order details and attachments and print the work order travelers and product labels. If the next operation is delayed for want of resources or materials, you can also resequence a subsequent operation to be executed next to avoid such delays to make further progress. For process work orders you can also report output transactions. You can also initiate inspections from the dispatch list for a work order operation.

You can report the material and resource usages automatically or manually. The material and resource transactions can be reported based on the work order requirements or actual usage. The serial tracked manufacturing supported for discrete manufacturing enables you to report material and operation transactions by product serials that are associated with the work order. The lean manufacturing is supported by enabling you to report orderless production activities without creating any work orders in discrete manufacturing. The orderless transactions are reported by referencing a discrete work definition. You can review the work order based and orderless transactions that are reported by the shop floor personnel. For process work orders the output items can be reported automatically or manually in any operation.

The import feature is supported by enabling you to import the material, resource, operation, and orderless transactions using the file-based data import infrastructure. You can use the predefined macro enabled spreadsheet templates for performing an import. Additionally, the external applications can record the material and operation transactions in Manufacturing by using the publicly available web services. You can also import output transactions for process work orders. There are separate FBDI templates that you can use to import material and operation transaction for discrete and process work orders.

The descriptive flexfields (DFF) are supported for operation transactions, resource transactions, lot / serial attributes for products in complete with details and orderless transactions, and for output transactions. Lot / serial attributes are also supported for components. However, for components you can only view the lot attributes, but you can't edit them. If any of these DFF attributes are required, you must enter a value, else you can't save the transaction.

IoT Integration for Work Execution

You can automate the real time reporting of operation completion transactions and output transactions for manufacturing work orders in real-time by integrating with Oracle Fusion Cloud IoT Production Monitoring. The shop floor transactional data collected by the IoT devices connected to the equipment resource instances of a work order operation can be used to automatically report completed, scrapped and rejected quantities of operation transactions, and actual quantities of output transactions. To be eligible for reporting, the resource instance must belong to the resource with the highest resource sequence number within the work order operation being reported.

For more information, refer to the Verify Work Order Status and Produced Quantities topic in the Using Oracle Internet of Things Production Monitoring Cloud Service guide.

In addition, you can extend your current manufacturing workflows to natively include robotic and automation equipment as follows:

- Define a production resource as automation equipment and an instance of the resource. The instance of an automation equipment used to process an operation is synchronized with Production Monitoring as a machine to establish communication with the equipment.
- Define a document item to represent a program file, its location and current revision and associate the program file name to an automation equipment resource.
- Associate a program file name to a work definition operation resource to be defaulted and used by a resource instance when its assigned to a work order operation resource.
- Generate and associate equipment parameters file to a work definition operation resource to be defaulted and used by a resource instance when its assigned to a work order operation resource.
- Execute an operation by sending a start signal to the automation equipment through IoT Production Monitoring.
- Navigate from dispatch list to digital twin view of automation equipment in IoT Production Monitoring to review real-time operation execution status with contextual telemetry, and transactional data.
- Create operation completion transaction automatically when the automation equipment signals completion.
- Perform automatic quality inspection and disposition through integration with Oracle Quality Management, based on the data received from automation equipment. Create completion or rejection transactions automatically in Manufacturing based on disposition information received from Oracle Quality Management.
- Create a production exception automatically in Manufacturing Cloud upon manually stopping the execution, or receiving a execution failure signal from automation equipment.
- Monitor operation execution status real-time with contextual telemetry, and transactional data from the automation equipment.
- Automatically report an operation completion transaction when the automation equipment signals completion.
- Automatically create a production exception in Manufacturing Cloud upon manually stopping the execution, or receiving a execution failure signal from automation equipment.

For more information, refer to the Using Oracle Internet of Things Production Monitoring Cloud Service guide.

Related Topics

- [How You Review a Dispatch List](#)
- [How You Report Operation Transactions](#)
- [How You Report Material Transactions](#)
- [How You Report Resource Transactions](#)
- [How You Report Orderless Transactions](#)

How You Review a Dispatch List

Use the Review Dispatch List task in the Work Execution work area to view the work order operations to be worked on for a selected work area and one or more work centers.

The dispatch list shows the in-house count point and optional operations of the released and completed work orders. It lists the quantities by the dispatch statuses in a tabular format with several visual cues highlighting the records that require attention.

The dispatch list serves as a single place for production operators to perform the following tasks:

- Initiate execution of an operation at automation equipment through IoT Production Monitoring
- Report operation transactions by quantity or serial number associated to the work orders
- Report material transactions by quantity or serial number
- Report resource transactions
- Report output transactions
- Resequence operations
- Enter inspection details
- Review work order details
- Print work order traveler and product labels
- Navigate to digital twin view of automation equipment in IoT Production Monitoring to review real-time operation execution status

Note: The dispatch list doesn't display operations of the type Supplier.

You can access the Review Dispatch List page by clicking any of the following in the Overview page in Work Execution work area:

- Review Dispatch List task in action label tab in the Work Execution work area.
- Ready, Complete, Reject, and Scrap segments of the ring chart in the Operations Scheduled versus Actual infolet.
- Past Due, Scrap, or Reject count in the Operations infolet.

Note: You can access the Review Dispatch List page if a role assigned to you has the Review Dispatch List (WIP_REVIEW_DISPATCH_LIST_PRIV) privilege. For more information on privileges, refer to the Oracle Supply Chain Management Cloud Security Reference for Manufacturing and Supply Chain Materials Management guide.

Using the search feature in the review dispatch list page, you can do the following:

- You can search for the work order operations by using the most commonly used search attributes such as work method, work area, work center, status, work order, start date, completion date, item, and serial. In contract manufacturing plant, you can also search based on the purchase order and purchase order line.

Note: Work method is part of the Advanced Search feature and not the basic search and is available only for process manufacturing organizations.

- You can use the application default search that retrieves the work order operations assigned to all the work centers belonging to the first work area in an alphabetic order (ascending) and have quantities in Ready status. By default the records are sorted by the earliest completion date.
- For process manufacturing-enabled organizations, the dispatch list supports an advanced search option. You can query work orders based on work method of Discrete Manufacturing or Process Manufacturing or both if you don't select any value from the work method drop-down list. However, there is no option as Both in the drop-down list. You can also use various search criteria for existing attributes in the advanced search.

- When querying based on shifts for operation start or completion dates, if a single work center is specified, the application searches for operations belonging to the shifts of the override calendar of that work center. If more than one work center is specified, then the application searches for operations belonging only to the shifts of the plant calendar.
- You can also create and use a personalized saved search.
- You can configure the search to run automatically every time you sign into the application.

To generate the dispatch list for a specific work center every time you sign into the application, create a personalized saved search and set it as default to run automatically.

Tip: When querying the dispatch list based on start date or completion date, shift times are interpreted by the application in the plant time zone. However, named dates such as Today, Yesterday, and so on are interpreted in the user time zone.

You can query for a dispatch list using a REST API.

Using the Dispatch List:

The following table shows how the dispatch list displays work order operation records in a tabular format:

Column	Description
Quantity	Refers to the quantity of the work order operation in a specific dispatch status.
UOM	Represents the unit of measure of the quantity being manufactured.
Status	Represents the current dispatch status of quantities at any specific in-house operation, which are as follows: <ul style="list-style-type: none"> • Ready (that's, to be worked upon) • In Process (applicable to operations that are executed by automation equipment instances) • Completed • Scrapped • Rejected
Work Order	Refers to the work order number suffixed with the operation sequence. The work order number is shown as a link that enables you to navigate to the work order page to review the work order details.
Attachments	The Attachment icon is conditionally displayed beside the work order operation or in the expanded region of the work order operations. The attachments from the following entities are displayed in separate tabs when you click the Attachments icon: <ul style="list-style-type: none"> • Work order • Work order operation • Work order operation instructions • Work order operation material • Work order operation resource

Column	Description
	<p>Note: Based on your opt-in, you can see attachments in the Work Order Operation Instructions tab from document items in the work order operation that displays the attachments including documents, images, pictures, 3D views or any form of visual documents. You see the active revision of the attachment from currently effective revision of the document from Master Organization.</p> <p>In addition, the attachments from the following are also displayed in separate tabs for work orders which are reserved as supply to back-to-back sales orders for standard and configured items.</p> <ul style="list-style-type: none"> • Sales order header • Sales order line <p>If you're a production operator, you can also add new work order operation attachments from the dispatch list</p>
Resequence	<p>The resequence icon is conditionally displayed beside the work order operation for resequencing operations. The following information is presented to you in a separate dialog when you click the Resequence icon:</p> <ul style="list-style-type: none"> • Select • Sequence • Operation Name • Work Center <p>Operations that are eligible for resequencing are displayed. You can select an operation that you want to execute next.</p>
Execution Sequence	<p>Represents the sequence of execution of the operation for work orders having resequenceable operations.</p> <p>You can modify the execution sequence by performing the resequence action. For work orders that don't have resequenceable operations, the execution sequence is not stamped.</p>
Exceptions	<p>The Exceptions icon is conditionally displayed beside the work order operation. The following information is presented to you in a separate tab when you click the Exceptions icon:</p> <ul style="list-style-type: none"> • Exception Type • Exception Status • Exception Number • Severity • Operation Sequence • Description • Reported On • Reported By <p>You can close an exception by selecting a row. You can also click on a specific exception number to drill into that exception and edit the exception.</p>
Item	Refers to the item on the work order that needs to be manufactured.
Work Center	Refers to the work center in which the operation is processed.
Start Date	Refers to the scheduled start date and time of the work order operation.

Column	Description
	<p>Note: The start date and time is displayed with a warning icon if it's past due and the corresponding quantity is in Ready dispatch status.</p>
Completion Date	<p>Refers to the scheduled completion date and time of the work order operation.</p> <p>Note: The completion date and time is displayed with a warning icon if it's past due and the corresponding quantity is in Ready or Reject dispatch status.</p>
Start or stop operation	<p>Refers to start and stop times for the work order operation.</p> <p>The start and stop icons allow you to track the time spent at each work order operation. If it is enabled at the serial number level, you can collect information by serial number at the work order operation. If not, the time spent is collected at the work order operation level.</p>
Report Material Transactions	<p>Refers to the functional icon to navigate to the Report Material Transactions page to manually report the material used at a supplier operation. The icon is enabled if a role assigned to you has the Report Material Transactions (WIP_REPORT_MATERIAL_TRANSACTIONS_PRIV) privilege.</p>
Report Resource Transactions	<p>Refers to the functional icon to navigate to the Report Resource Transactions page to manually report resources used at a supplier operation. The icon is enabled if a role assigned to you has the Report Resource Transactions (WIP_REPORT_RESOURCE_TRANSACTIONS_PRIV) privilege.</p>
Priority	<p>Refers to the work order execution priority.</p>
Operation Name	<p>Refers to the name of the operation.</p>
Item Description	<p>Refers to the description of the item that needs to be manufactured.</p>
Customer	<p>Refers to the customer name on the sales order to which the work order is reserved as a supply. If there are multiple customers, then the dispatch list displays Multiple instead of the individual customer names.</p>
Report Output Transactions	<p>Refers to the functional icon to navigate to the Report Output Items to manually report output items for a process manufacturing work order. The icon is enabled if a role assigned to you has the Report Operations Transactions (WIP_REPORT_OPERATION_TRANSACTIONS_PRIV) privilege.</p>
Report Inspection Details	<p>Refers to the functional icon to navigate to the Report Inspection Results to initiate ad hoc inspection for a work order operation. This icon for inspection is provided in all organizations, both discrete and process manufacturing.</p>
Work Method	<p>Refers to the value populated based on the organization you have selected. If you select a manufacturing organization, you will see a list of two work methods, Discrete Manufacturing and Process Manufacturing.</p>

Column	Description
Purchase Order Header	Refers to the purchase order header number associated with the contract manufacturing work order.
Purchase Order Line	Refers to the purchase order line number.

Sales Order attachments from back-to-back sales orders for standard items and configured items are displayed in work execution. You can optionally control which attachments can be viewed by the production operator. Attachments belonging to the Miscellaneous category are always displayed by default. However, other user-defined attachment categories may be configured and displayed based on the security setup. Security can be enabled using the standard attachment security framework provided in the Setup and Maintenance work area and the Security Console.

For any specific record displayed in the dispatch list, you can do the following:

- Print work order traveler and product labels by selecting the option from the Action menu.
- Initiate execution of an operation that's processed by automation equipment.
- Review the related work order details by clicking the work order link.
- Report operation transactions by quantity or serial number at a count point operation by expanding the record and using the Quick Complete or Complete with Details action.

Note: This isn't applicable for operations that are processed by automation equipment.

- Operation transactions can be reported:
 - If one of the roles assigned to a user has the Report Operation transactions (WIP_REPORT_OPERATION_TRANSACTIONS_PRIV) privilege associated to it
 - If the operation is a count point operation. (For auto transact operations, operation transactions are reported automatically at the next count point operation)
- Report material transactions by quantity or serial number by clicking the report material transactions functional icon.

If the plant parameter Material Reporting Level for Serialization Operations is set to Item Serial, material reporting is enabled for each item serial.

- Report resource transactions by clicking the report resource transactions functional icon.
- Report output items for process manufacturing work orders by clicking the report output transactions functional icon.
- Report inspection results by clicking the report inspection details functional icon.
- Indicate start or pause for the operation by clicking the start or pause icon.

If the plant parameter Capture Level for Serialization Operations is set to Item Serial, you can indicate start or pause for each item serial by clicking the start or pause icons for the respective item serial.

Related Topics

- [Overview of Production Execution Tasks](#)
- [How You Report Operation Transactions](#)
- [How You Report Material Transactions](#)
- [How You Report Resource Transactions](#)
- [How You Resequence Work Order Operations](#)

How You Resequence Work Order Operations

As a production operator, you can resequence a subsequent operation to be executed next to avoid waiting for availability of resources or materials for an operation. The resequencing of operations enables you to avoid any time delays in executing work order while continuing to make progress.

Let’s take an example of a work order with 5 operations, 10,20, 30, 40, and 50. Now, you define the operations 20, 30, and 40 as resequenceable operations because these can be executed in any sequence. Operations 10 and 50 are count point operations.

As a production operator, when you report completion of operation 10, all the resequenceable operations 20, 30, and 40 are available in the dispatch list for execution. However, the ready quantity is by default available for operation 20. Let’s assume that materials required to perform operation 20 are unavailable and resources required to perform operation 30 are unavailable. Hence you would like to perform operation 40 next to continue to make progress and meet the customer delivery date. To do this, you must invoke the resequence action.

To resequence an operation, follow these steps:

1. On the Review Dispatch List page, search for the work order that has resequenceable operations. All resequenceable operations display for the work order. The Ready quantity is available only for the operation that has the next execution sequence. Here’s how the dispatch list looks for our example:

Work Order - Operation Sequence	Execution Sequence	Status	Start Date	Quantity
WO1000 - 10	1	Complete	T1	10
WO1000 - 20	2	Ready	T2	10
WO1000 - 30	3	Ready	T3	0
WO1000 - 40	4	Ready	T4	0

2. Select the work order operation that you want to resequence. For example, operation 20.
3. Click the **Resequence** icon besides the work order operation 20. A dialog opens for you to resequence the operation.
4. Choose an operation that you want the operation to be resequenced as next operation, that’s operation 40.
5. Click **Save and Close**.

Results:

On the Review Dispatch List page, the operation 40 is now resequenced as a next operation with execution sequence 2. The Ready quantity is now available for the resequenced operation. Also, the operations are rescheduled automatically in the background so that the operation start, and completion dates are now realigned with the execution sequences. Here is how the dispatch list looks after the resequence action for our example:

Work Order - Operation Sequence	Execution Sequence	Status	Start Date	Quantity
WO1000 - 10	1	Complete	T1	10
WO1000 - 40	2	Ready	T2	10
WO1000 - 20	3	Ready	T3	0
WO1000 - 30	4	Ready	T4	0

You can reject, or scrap and also perform inspections on a resequenceable operation similar to a count point operation. If you complete partial quantities in resequenceable operations, the rest of the quantities must traverse the same path. However, you can reverse the entire quantity in an operation and select a different execution path. You can't report outputs in resequenceable operations.

Integrating applications like Supply Planning, Production Scheduling, and Costing will consider the execution sequence to plan, schedule, and cost the work order operations respectively. When you complete all the resequenceable operations 40, 20, and 30, the ready quantity moves to the succeeding count point operation 50.

Note: You can't use FBFI to perform resequence action while transacting operations.

Note: You can't resequence work order operation quantities that are in in process status.

Related Topics

- [How You Review a Dispatch List](#)

Use the Quick Complete Action to Execute a Standard Discrete Manufacturing Work Order



Watch video

As a production operator, you can search for an order on a dispatch list and complete the work order and its operations using the Quick Complete action.

Here's how you can use the Quick Complete action and complete a standard discrete manufacturing work order and its operations. Using the Quick Complete action, you can complete a work order in just two clicks.

1. Navigate to the **Work Execution** work area.

2. On the Overview page, click the **Tasks** pane.
3. Select the **Review Dispatch List** link.
The dispatch list displays released work orders with operation quantities in various statuses.
4. On the Review Dispatch List page, enter the search criteria for the fields and click **Search**.
 - o Work Area assigned to you and its related Work Center.
 - o Select the **Ready** status.
 - o Work Order for which you want to perform the transaction.
5. Select and expand the work order operation for which you want to complete the work order and its operations.
The quantity to be completed, defaults to the ready quantity.
6. Click **Quick Complete**.
You can complete a work order using **Quick Complete** in two clicks.
The simple Quick Complete action initiates background processes that backflush materials, charge resources, and perform work order costing.
You have now completed the first work order operation and the quantity after completion moves to the next operation.
7. To complete multiple work order operations one by one, select and expand the next count point operation in the work order.
8. Click **Quick Complete**.
You have now completed the next work order operation.
Now, the work order no longer appears in the dispatch list in the Ready status because the work order operations for this work order are now completed.
9. In the search region, select the **Complete** status and click **Search**.
The work order for which you completed the work order operations now appears in the dispatch list.
10. Select the work order operation that you completed.
11. Click the selected work order link to review its work order details.
On the Edit Work Order page, you can see the work order status is **Completed** on the General Information tab.
12. Click the **Operations** tab.
You can see that the work order operations and its quantities are now set to the **Completed** status.

Now, you have searched, and completed a standard discrete manufacturing work order and its operations using the Quick Complete action.

How You Initiate Operation Execution at Automation Equipment

Follow these steps to initiate start of operation at automation equipment :

1. Navigate to the Work Execution work area.
2. On the Overview page, click the Tasks panel.

3. Select the Review Dispatch List link.
4. Expand the work order operation that uses automation equipment and has quantity in Ready status.
5. Click on the Execute button.

Oracle Manufacturing sends the work order operation details such as the work order number, operation sequence, quantity to be processed, preassigned serials and lots to be used in IoT Production Monitoring. In addition, it sends the name of the program file, the current revision to be used, the location of the program file if defined, equipment parameter values, inspection characteristics names, to IoT Production Monitoring to further communicate with the automation equipment. If an inspection plan is defined, Oracle Manufacturing also sends the identifier of the plan for IoT Production Monitoring through the integration with Oracle Quality Management, to orchestrate automatic quality inspection and disposition based on the sensor data received from automation equipment.

Upon successful communication with the automation equipment and initiation of operation execution, a confirmation message displays based on the response received from IoT Production Monitoring. In addition, the previous quantity in Ready status is moved to in-process status. The in-process status is applicable to in house operations that use automation equipment and indicates that the quantity is currently being processed by the equipment.

Note: This capability is supported in the following use cases:

- Serial-tracked operation execution
- Discrete work order execution with a single preassigned lot
- Work order operations with a single resource, the resource being enabled as an automation equipment, and that has a single resource instance assigned to it. An error message displays if the operation has multiple resources or resource instances associated to the operation.

From the dispatch list, you can also navigate to the digital twin view of the automation equipment in IoT Production Monitoring to review the real time contextual telemetry data, and execution status of the operation by clicking on the **Monitor Equipment** button after expanding a work order operation record that has a quantity either in the Ready, or in In Process status.

Production Exceptions

Overview of Production Exceptions

One of the key execution capabilities that Oracle Manufacturing offers is that you can report and manage production exceptions. As a production operator or the production manager, you can report the problems that occur on the shop floor. These might be problems that can affect the smooth progress of a work order and are thus reported as production exceptions.

You can also associate other work orders to a particular exception. These might be work order operations that are impacted by the problems. For example, if 3 work orders use a particular component which is in short supply, an exception can be reported and all 3 work orders can be associated to it.

All users having the production supervisor role (WIP_MANAGE_PRODUCTION_EXCEPTIONS_PRIV) privilege and required access to the manufacturing plant will be notified about the production exception.

After an exception has been reported, you can manage (query, create, update, and review of production exceptions) if you've been assigned (WIP_MANAGE_PRODUCTION_EXCEPTIONS_PRIV) privilege. You can also take specific actions to resolve the problems and then close the exception. You can collaborate with all interested stakeholders using the **Oracle Social Network** and resolve the exception accordingly.

An exception can be reported when progress can't be made on a particular work order due to problems like shortage of a particular component. The following are the types of production exceptions reported in a plant:

- Work Area
- Work Center
- Resources
- Components
- Miscellaneous
- Supplier Operations

Note: Exceptions for supplier operations are automatically reported by the application. You can't manually report an exception for a supplier operation.

The manufacturing issue types are predefined and you can't extend these predefined issue type values.

The process of reporting exceptions will fail in these scenarios:

- If Issue Types corresponding to Production Exception is set to the User-defined or Inherited from Parent options, the process of creating them will fail. So, ensure that you use these settings only for legacy data import, if at all. It is recommended to always set them to Sequence-generated.
- If additional mandatory fields have been added to quality issue through the application composer.

IoT Integration for Production Execution

Oracle Fusion Cloud IoT Production Monitoring can automatically log production exceptions on resource instances in Manufacturing Cloud. You can configure rules to detect changes in machine conditions that indicate failure or predicted failure and use this information to log machine incidents in IoT Production Monitoring. Along with these machine incidents, you can configure automatic creation of a corresponding production exception in Manufacturing Cloud and a maintenance work order in Maintenance Cloud, so that appropriate action can be taken.

Production exceptions are created with a resource exception type referencing the resource instance. Maintenance work orders are created on the asset number mapped to the resource instance. When the production exception is closed in Manufacturing, the corresponding incident is closed in IoT and vice versa.

For more information, refer to the Production Exceptions for Machine Incidents topic in the Using Oracle Internet of Things Production Monitoring Cloud Service guide.

Exceptions of the Resource type are automatically generated by IoT Production Monitoring for resources defined as automation equipment upon manually stopping the execution, or receiving a execution failure signal from automation equipment. For more information, refer to the Using Oracle Internet of Things Production Monitoring Cloud Service guide.

Related Topics

- [Report Work Order Exceptions](#)
- [Associate Work Orders to an Exception](#)
- [How You Manage Production Exceptions](#)

Report Work Order Exceptions

You can create or report an exception if you're a production operator or a production manager in a manufacturing plant.

To create an exception, follow these steps:

1. Navigate to the Work Execution work area.
2. On the Overview page, click the **Tasks** panel.
3. Select the **Review Dispatch List** link.
4. Select the work order operation against which you want to report an exception.
5. Click **Actions** menu and select the option **Report Production Exception**.
6. Enable the Report Production Exception transaction.

A separate window opens where you can select the **Exception Type** from a list. If you select **Resource** as the exception type, the application automatically populates the **Resource** field only if there is one resource associated with the particular work order operation. Additionally, you can also select the resource instance if it's mentioned in the work order. The application dynamically displays the attribute based on the exception type you choose.

Note: As a production operator, you can report an exception with or without reference to a particular work order operation. Additionally, you can associate the same exception to other impacted work order operations.

Exception notifications are sent by default to users who have Edit or View Exception privileges (WIP_MANAGE_PRODUCTION_EXCEPTIONS_PRIV) privilege, and who have the Data Role of the plant in which the exception was reported.

Note: Exceptions of type **Supplier Operation** are automatically generated. You can't manually create them.

Related Topics

- [Overview of Production Exceptions](#)
- [Associate Work Orders to an Exception](#)
- [How You Manage Production Exceptions](#)

Associate Work Orders to an Exception

To ensure material-tracking and timely availability of materials to the staging area of production, you can initiate the Pick Materials for Work Orders scheduled process in the Work Execution work area. After the scheduled process runs and completes successfully, you can view the generated reports in the Scheduled Processes work area.

For organizations tracked by project, you can search production exceptions by Project Number and Task Number and report the exceptions. Project and Task Numbers are also displayed for the impacted work order operations and in the Production Exception Notification.

To associate work order operations to an open exception, follow these steps:

1. On the Overview page, scroll over to the **Tasks** panel and select **Manage Production Exceptions**.
2. Click the **Open Exceptions** infotile which gives you a list of all exceptions reported in your manufacturing plant.
3. Select an exception from the list to which you want to associate work order operations. This directs you to a separate **Exceptions** tab.

This tab displays additional information regarding the exception such as its type, status, description, and so on.

4. Move to the Impacted Work Order Operations area and click the **Add** icon. This opens a dialog box **Search for Work Order Operations**.
5. Search for the operation you want to associate with the exception. Click the **Add** button.
6. The Impacted Work Order Operations area is automatically populated with details about the operation that you have added. Click the **Save and Close** button at the header of the page.

You can now choose to collaborate with all the stakeholders through the Oracle Social Network to resolve the exception. For this click the **Social** icon at the header of the page. You can add the work order operation on which you want to act as the social object and start a conversation.

Note: For more information about how to use the Oracle Social Network to collaborate and accomplish such tasks, refer to Chapter 6: Social Network in the Oracle Applications Cloud Using Common Features guide.

Related Topics

- [Overview of Production Exceptions](#)
- [Report Work Order Exceptions](#)
- [How You Manage Production Exceptions](#)

How You Manage Production Exceptions

When you receive a notification about an exception, as a production supervisor you can navigate to the Manage Production Exceptions page in the Work Execution work area and view the reported exceptions. You can also search for various work orders and review if they have any exceptions associated with them or not.

Analyzing Infotiles Related to Exceptions

There are a set of different infotiles which provide you various aspects of information about the open exceptions.

They're as follows:

- **Open Exceptions:** This infotile shows you the total number of open exceptions you can act upon.
- **Exception Type:** This infotile groups the exceptions by the type such as component shortage, resource problems and so on. It is depicted in the form of a pie chart.
- **Reported On:** This infotile groups the exceptions by the various shifts during which they were reported.
- **Severity:** This infotile groups the exceptions by the level of criticality such as high or low.

You can click any one of these infotiles to drill down further into the problem and get more information regarding the exception and associated work orders.

Identifying Exceptions for Work Order Operations

In the **Review Dispatch List** table, you can easily locate which of the work orders have exceptions associated with them. An icon is displayed beside the work order operation. When you hover over the icon, it shows the number of open exceptions. If you click the icon, it takes you to the **Exceptions** tab of the work order.

As a production supervisor you can also navigate to the Manage Work Orders page to search for the work orders which have exceptions associated with them. You can search for a particular work order here and if the icon is situated beside the work order in the Search Results area, you can follow the same steps to drill down further.

You can go to the Edit Work Orders page and select the **Operations** tab. If you open the **Edit Operation Items**, you find the same icon displayed beside the components that have associated with them. These are the components that have some shortage and are in turn affecting the progress of the work order operations they're a part of.

Note: You can't edit exceptions of type **Supplier Operation**.

Closing Work Order Exceptions

As a production supervisor, once you have assessed all the open exceptions that were notified to you, you can now choose to close the exceptions that have been resolved. You can either close the entire exception or only one or a few work order operations associated with the exception.

On the Overview page of the Work Execution work area, select the task **Manage Production Exceptions** from the Tasks panel. If you drill down to the **Open Exceptions** infotile, you get a list of all open exceptions. You can choose to select the **Close Exception** button here by selecting a particular exception from the list. This closes the exception for all the work order operations associated with it.

You can also close an exception in the **Exceptions** tab. If you select an exception you're directed to the **Exceptions** tab. You can set the **Exception Status** to **Closed** by selecting that option from the list. Before closing an exception, you can also set the status of the work order to **On Hold**. After an exception is resolved, you can set the work order status to **Released** and then close the exception.

You can also close the exception only for particular work order operations and not on the whole. In the **Exceptions** tab, move to the Impacted Work Order Operations area. Select all the work order operations for which you have resolved the exception. Click the **Close Exception** button at the header of the table. **Save and Close** your changes.

Note: A work order consists of several operations. You associate an exception not to the whole work order but to certain operations which might be impacted by the exception. When an operation is deleted from a work order during the process of production, the application automatically disassociates the exceptions from that operation.

Tip: You can manually close exceptions of type Supplier Operation.

Related Topics

- [Associate Work Orders to an Exception](#)
- [Report Work Order Exceptions](#)
- [Overview of Production Exceptions](#)

Overview of Electronic Signatures and Electronic Records for Production Exception Closure

You can enable the ability to capture electronic signatures and generate electronic records in a deferred mode while closing a production exception.

To capture electronic signatures and generate electronic records for Production Exception Closure in an organization, you need to set up the following:

- Enable E-Signature for Production Exception Closure as Required for the Organization. Follow these steps:
 - a. In the Setup and Maintenance work area, go to the following:
 - Offering: Manufacturing and Supply Chain Materials Management
 - Functional Area: Facilities
 - Task: Configure Electronic Signature Preferences
 - b. Enable the E-Signature for Production Exception Closure transaction.
- Configure the Business Process Rules to Determine the Approvers for Production Exception Closure. Follow these steps:
 - a. In the Setup and Maintenance work area, go to the following:
 - Offering: Manufacturing and Supply Chain Materials Management
 - Functional Area: Facilities
 - Task: Manage Task Configurations for Supply Chain Management
 - b. Define approval rules for Production Exception Closure.

Note: For more information about implementing E-Signatures and generating E-Records, refer to the Implementing E-Signatures and E-Records chapter of the Oracle SCM Cloud Implementing Manufacturing and Supply Chain Materials Management guide.

How You Capture E-Signatures and Generate E-Records for Production Exception Closure

When you enable electronic signatures and electronic records for Production Exception Closure, the process to generate electronic records and capture electronic signatures is initiated in a deferred mode when you submit a production exception for closure in the following ways:

- From the Manage Production Exceptions page: On the Manage Production Exceptions page, click on the Open Exceptions infolet to display all open production exceptions. Select the specific production exception you want to close. Click the Close Exception button. You can also select more than one production exception.
- At the header level from the Edit Exception page: For a specific exception, on the Edit Exception page, you can change the Exception Status from Open to Closed and save the exception.

- At the Work Order Operation level from the Edit Exception page: On the Edit Exception page, in the Impacted Work Order Operations area, select the specific Work Order Operation you want to close. Click the Close Exception button. You can also select more than one Work Order Operation.
- From the Edit Work Order page, Exceptions tab: On the Edit Exception page, in the Impacted Work Order Operations area, select the specific Exception you want to close. Click the Close Exception button. You can also select more than one Exception.

The E-record for a Production Exception contains information about the following:

- Exception Information
- Attachment Details
- Impacted Work Order Operations

Note: If multiple exceptions are submitted for closure through a single action, then the process to generate electronic records and capture electronic signatures is initiated for every production exception that's submitted for closure.

When you submit a production exception for closure, the status of the exception is set to **Pending Approval for Closure**.

Notifications are sent to other approvers who can access them through bell notifications in the Oracle Cloud application. Approvers can review the electronic records before adding their electronic signature, enter their comments, indicate their approval or rejection and sign the electronic record by entering their password. The status of the exception remains as Pending Approval for Closure until all approvals are completed. Depending upon the outcome of the approval, the production exception is either closed or is set back to open status.

You can search and view the existing E-Records for Production Exceptions from the Electronic Records work area.

Note: For more information about capturing E-Signatures and generating E-Records, refer to the Oracle SCM Cloud Using E-Records, refer to the Oracle SCM Cloud Using E-Signatures and E-Records guide.

Operation Transactions

How You Report Operation Transactions

As a production operator, you can manually report the progress at a work order operation level by reporting operation transactions. You can report operation transactions such as complete, scrap, and reject from ready status at the in-house count point operation including operations that can be resequenced, from the Review Dispatch List page in the Work Execution work area. You can report operation transactions, such as complete, scrap, or reject from the ready status at the supplier operation from the Manage Supplier Operations page in the Work Execution work area.

For in-house operations, a quantity or serial is placed in ready status when the work order is released and the operation is the first count point operation in sequence, or the quantity is completed at the prior count point operation when the operation is an intermediate or last operation in sequence. Discrete manufacturing has only one output, which is the last stage of the work order. Process manufacturing can have multiple outputs and can be at any stage. You can view the outputs for an operation in the process manufacturing work order. You can specify multiple output items as products or by-products for an operation. One of the output items in the work order is a primary output. The other output items are products or by-products. Process manufacturing work orders don't have serial tracked operations.

Note: Dual units of measure is supported in operation transactions. If you want to issue a material with dual units of measure, you must mention secondary quantity. If you want to complete a product with dual units of measure, you must mention the secondary quantity. In all transactions, the secondary unit of measure is derived from the item definition in Oracle Product Hub. Only the secondary quantity is entered by the user.

For supplier operations, a quantity or serial is in in-process status when the work order is released and the supplier operation is the first operation in sequence, or the quantity is completed at the prior count point operation when the supplier operation is an intermediate or last operation in sequence. The in-process dispatch status represents quantities at supplier operations that have been completed at the prior count operation, but haven't yet been received from the supplier after processing. Operation transactions can't be reported when the quantity or serial is in in-process status. After receiving and delivering to Oracle Manufacturing, the quantity at a supplier operation that's not a serial-tracked operation is automatically reported as completed. In case of a serial-tracked supplier operation, the serial is automatically placed in ready status.

Tip: Supplier operations are displayed in the Manage Supplier Operations page and can only be transacted from this page. Supplier operations aren't listed in the dispatch list.

There are two modes to manually report the operation transactions at an in-house or a supplier operation:

- **Quick Complete:** You can use the quick complete mode to create the operation transactions in two clicks. This mode can be used only if the work order has all the necessary data for the transaction setup and the transaction doesn't require any additional inputs. The quick complete mode can also create multiple operation transactions to perform the complete, scrap, and reject transactions in one transaction cycle.
- **Complete with Details:** You can use the complete with details mode when the transaction requires you to review and update the transaction data, such as materials consumed, resources charged, and so on. You can also use this mode when you need to provide the additional details for the transaction, such as lot and serial information for the components, supply subinventories for the components, and so on. This mode requires navigation through multiple pages but provides the flexibility to update the transaction data that's derived from the work order. In discrete manufacturing, if the transaction is an operation completion at the last operation, the product is completed to inventory. You can initiate the operation transaction for process work orders in the same way as that of discrete work orders. The process manufacturing work orders can have output items in any operation. Output items setup in work order as automatic will be automatically completed at the operation while performing complete with details. Use the complete with details mode to change the output item quantities and add and update output items or serials for process manufacturing work orders.

Note: This section is applicable for operations without inspections. For operations with inspections, refer to the Manage Inspections: Explained topic in this guide.

You can perform the following operation transactions:

- Complete a quantity in ready status at an operation.
- Complete a quantity in ready status at the last operation and inventory the product (for process work orders, output items can be inventoried during completion of any operation).
- Scrap a quantity in ready status at an operation. You must have the required scrap privilege to perform the transaction .
- Reject a quantity in ready status at an operation for further review to decide on the disposition action.
- Complete a rejected quantity if the rejected quantity is decided as acceptable.
- Scrap a rejected quantity if the rejected quantity is decided as unacceptable. You must have the required scrap privilege to scrap quantities.

- Complete to complete for overcompletions (allowed only in in-house count point operations).
- Perform the undercompletion for the last operation using quick complete or complete with details action.

Additionally, you can also correct any errors by performing a reverse transaction. The reverse transaction reverses the quantity transacted earlier. The forward and reverse transactions are recorded as separate transactions. The reverse transactions can be performed from the complete, scrap, or reject dispatch statuses. You can perform the following reverse transactions:

- Reverse a completed quantity to ready at an operation.
- Reverse the product at the last operation for discrete manufacturing work orders. (for process manufacturing work orders, it can be at any operation).
- Reverse a scrapped quantity to ready. You must have the WIP_REPORT_SCRAP_TRANSACTIONS_PRIV privilege to perform the transaction.
- Reverse a rejected quantity to ready.

Tip: You can't manually reverse a quantity or a serial at a supplier operation from ready to in-process status. When you return quantities to either receiving or supplier, or perform a receipt or return correction, the quantity or a serial in ready status is automatically reversed to in-process.

The operation transactions for the automatically transact operations are automatically reported when an operation transaction for the next count point operation is reported. Similarly, for the reverse transactions, the quantity is automatically reversed at the automatically transact operation if the quantity is manually reversed at the previous count point operation.

Note: The operation transactions aren't supported for optional operations.

When the Restrict lot numbers during return plant parameter is enabled, you can select and return only those lot numbers that have been issued from the lot numbers list at the work order operation. However, you can return any lot numbers though the same lot hasn't been issued in the following conditions

- if **Restrict lot numbers during return** plant parameter is NOT enabled
- if you have the **Allow unrestricted return to lot numbers** privilege when **Restrict lot numbers during return** plant parameter is enabled

Validate Operation Completion

If operation attribute **Completions with Under Issues** is set to **Allow with warning** and all the required materials with push supply type aren't issued, then operators will get a warning message giving them the option of whether or not they want to report the operation transaction.

If the operation attribute **Completions with Under Issues** is set to **Don't allow**, then operators won't be able report operation completions unless all the required material with push supply type are issued.

If operation attribute **Completions with Open Exceptions** is set to **Allow with warning** and if there are open exceptions, then operators will get a warning message giving them the option of whether or not they want to report the operation transaction.

If the operation attribute **Completions with Open Exceptions** is set to **Don't allow**, then operators can't report operation completions unless all the exceptions are closed.

Note: When operation attributes **Completions with Under Issues** and **Completions with Open Exceptions** are set to **Allow with warning**, operation transactions reported through REST will be processed with the **Allow** setting.

Overcompletion

The completing or scrapping of the quantity that's over the work order quantity at the first in-house count point operation in the work order operations is called overcompletion. This is supported if the work order overcompletion tolerance is setup either at work order level or at the Default Overcompletion Tolerance Percentage plant parameter. At the work order level, the overcompletion can be set up as the percentage of the work order quantity or as the absolute quantity. However, the plant parameter is used to set up a default value for overcompletion in percentage. The overcompletion set up at the work order level always overrides the overcompletion set up in the plant parameter.

Note: Overcompletions can't be reported at supplier operations.

Undercompletion

The work is undercompleted based on the undercompletion tolerance value.

The completing or scrapping of the quantity that's less than the work order quantity at the last operation of the work order is called undercompletion. This is supported if the work order undercompletion tolerance is set up either at work order level or at the Default Undercompletion Tolerance Percentage plant parameter. At the work order level, the undercompletion can be set up as the percentage of the work order quantity or as the absolute quantity. However, the plant parameter is used to set up a default value for undercompletion in percentage. The undercompletion set up at the work order level always overrides the undercompletion set up in the plant parameter.

Undercompletion is also applicable for a supplier operation.

Generate UDI

You can generate and store a Unique Device Identifier (UDI), which is a series of alphanumeric characters that's assigned to uniquely identify a medical device. A UDI improves the identification, traceability, and safety of medical devices. You can generate a UDI consists of the following information:

- Device Identifier - fixed and mandatory element of the UDI. It uniquely identifies the specific version or model of a medical device and the manufacturer (information managed in Oracle Fusion Cloud Product Lifecycle Management).
- ProductionIdentifier - conditional and variable component of the UDI, which may include information like the lot or batch number, the serial number, the expiration date, and the manufacturing date of the device (managed in Oracle Fusion Cloud Manufacturing).

A UDI generation is initiated during product completion of discrete manufacturing work orders or during orderless completions.

1. Identify if UDI generation is required in the item definition
2. Derive the device identifier from the GTIN in the item definition
3. Identify applicable production identifiers and generate attribute values
4. Generate and populate the UDI in lot or serial number table
5. Display the generated UDI in product labels, electronic production record, and in transaction history pages

For more information about setups, refer to the PIM User Guide.

The UDI generation logic is defined based on attributes at the item level or during transaction:

- GTIN value
- Lot
- Serial number
- Expiration date

- Manufacturing date

The UDI is generated as part of the discrete work order product completion or orderless completion and you can see the generated UDI in the following workflows:

- Production transaction history
- Product labels generated during operation transactions
- Electronic production record

The generation and storage of a full UDI string enables in:

- Efficient tracking and tracing of medical devices throughout their lifecycle
- Adherence to regulatory requirements and standards for safety and quality
- Minimizing risks associated with device errors, recalls, and patient safety

Reporting Operation Transactions in a Contract Manufacturing Plant

In a contract manufacturing plant, when you report the completion of the last operation, the application receives the contract manufacturing service item against the contract manufacturing plant into inventory. The application then completes the last operation which backflushes the contract manufacturing service item and posts the assembly into inventory.

Note: Contract manufacturing is currently supported for only discrete manufacturing.

For successful completion of the last operation in a contract manufacturing plant, you must do the following:

- Set up the default item transaction for inventory.
- Set up the default supply subinventory and locator in the contract manufacturing plant. You must ensure that the subinventory and locator in the contract manufacturing plant is same as that in the default Item transaction.
- Set the receipt routing for the purchase order as Direct.

You should not report an operation transaction for a contract manufacturing work order if it's not linked to a purchase order. Reporting an operation transaction for a contract manufacturing work order that's not linked to a purchase order will result in negative inventory of the contract manufacturing service item. You can't reverse such an operation transaction.

In a contract manufacturing plant, you can't perform the following:

- Scrap a quantity at an operation
- Reject a quantity at an operation
- Reverse to Ready at the final operation

Quick Complete

The quick complete mode is available only if there's no lot or serial control enabled operation pull component in the work order operation.

Note: For process manufacturing work orders, there should not be any lot or serial-controlled output items for automatic reporting at the operation. There can be manual outputs that are lot and serial controlled and you can still quick complete at the operation.

Irrespective of the availability of the Quick Complete button, a transaction is eligible for quick complete only if / when:

- There's no lot or serial numbers to be entered for the product or automatic output items. The quick complete isn't supported if the transaction has to report the product or output items that are serialized at receipt, because you're required to enter the lot or serial number.
- There are no lot control or serial control enabled pull components to be backflushed. The backflush components can be assembly pull or operation pull. The scrap transactions that have lot-controlled or serial-controlled assembly pull components aren't eligible for quick complete.
- If in a set of multiple transactions, if one of the transactions isn't eligible for quick complete, all the transactions will fail.
- The default supply subinventories for all the pull components must be specified in the work order or in the Default Supply Subinventory plant parameter if there are pull components to be backflushed.
- The default subinventory for product completion must be specified in the work order or in the Default Completion Subinventory plant parameter if the transaction is a product completion. The plant parameters Default Completion Subinventory and Default Completion Locator are mandatory plant parameters.
- If you are completing a quantity less than that of the work order quantity and within the undercompletion tolerance, the work order will be set to completed status when you select the undercomplete check box. However, if you don't select the check box, and complete a quantity less than the work order quantity, the work order will continue to be in released status.
- The quick complete action isn't allowed for those operations that has at least one resource with a job profile or equipment profile whose charge type is Automatic.

Note: For manufacturing plants which are enabled to track inventory by the country of origin, when completions are performed using quick complete actions, the products are completed without the country of origin. Also, the materials are backflushed without country of origin.

Note: The quick complete action isn't available for operations that are processed by automation equipment.

Complete with Details

Using the complete with details mode, you can create only one type of operation transaction at a time, that's, you can either complete or scrap or reject in one transaction. You can't perform more than one transaction type in a transaction. The quantity entered should not exceed the quantity available for transaction. The quantity available for transaction is the quantity that's available in the current dispatch status. However, if the operation is the first count point operation and if any overcompletion quantity is set up in the work order, then the total transaction quantity can exceed the quantity in the current dispatch status to the extent allowed by overcompletion tolerance. Overcompletion is allowed only at the first count point operation in the work order operation from Ready status.

For transactions initiated from Reject dispatch status, you will have three attributes Complete, Scrap or Reverse to Ready to complete, scrap or reverse the quantity to ready status. The user can complete or scrap or reverse a quantity to ready. The total quantity entered should not exceed the quantity in the current dispatch status.

Note: If the operation has a required inspection setup, then multiple types of operation transactions can be created. Refer to the appropriate section on Manufacturing Inspections for details.

For transactions initiated from Complete or Scrap dispatch status, you will have only one attribute Reverse to Ready to enter the quantity that's to be reversed to ready status. The total quantity entered should not exceed the quantity in the current dispatch status.

Note: For operations that are executed by an instance of automation equipment, the complete with details action is enabled only if the Report Operation Transactions Performed by Automation Equipment privilege is assigned to the job role, to either reverse the in-process quantity to ready, or complete the quantity. This is used in exception situations where the quantity can't be automatically progressed to the next operation in sequence.

The flow for reporting an operation transaction consists of the following four train stops:

Product Train Stop

In the Product train stop, you can review the transaction. The following table lists the attributes in the Product train stop:

Field	Description
Transaction Date	<p>The following two validations must be honored:</p> <ul style="list-style-type: none"> Transaction date must be same or later than the work order released date. Transaction date can't be a future date.
Attachments	<p>The list of attachments from the work order. You can add work order operation attachments. The attachments of the following types are displayed:</p> <ul style="list-style-type: none"> Work order operation Work order header Work order operation material Work order operation resource Sales order header Sales order line <p>Note: The last two attachment types are applicable only for work orders which are reserved as a source of supply for sales orders.</p>
Available to Transact	The quantity that can be transacted with the dispatch status.
Transaction Type	The transaction type for the current transaction.
Quantity	The current transaction quantity. You can update this field up to the quantity specified in Available to Transact field. This field is read-only when you navigate back to the page from an upstream page.
Undercomplete	<p>The work is undercompleted based on the undercompletion tolerance value.</p> <p>The work order will be set to completed status when you select the undercomplete check box. However, if you don't select the check box, and complete a quantity less than the work order quantity, the work order will continue to be in released status.</p>
Print Label	If selected, the labels will be printed as per the predefined template.
Transaction Note	The note for the transaction.

Field	Description
Operation Transaction Summary	The region has the following three attributes that show the current status of transacted quantity in the work order operation: <ul style="list-style-type: none"> • Complete • Reject • Scrap
Additional Information Region	The additional information region is enabled for serial-tracked and nonserial-tracked operations.
Additional Serial Information Region	The additional serial information region is enabled for serial-tracked operations.

Note: If the descriptive flexfields attributes are set up, you can add additional information for operation transactions. If serial attributes flexfields are set up, you can add additional serial information in serial-tracked operations.

For serial-tracked operations, the serial numbers previously generated and associated in the work orders are displayed in the expanded region of the dispatch list row. The transaction is initiated by selecting the check box in the dispatch status region for a serial number and then clicking the Complete with Details action. Only one serial can be transacted at a time for this action.

Backflush Materials Train Stop

The Backflush Materials train stop is displayed if the Allow Quantity Changes During Backflush plant parameter is set as Both or Material. The following table lists the attributes in the Materials train stop:

Field	Description
Status	Icon to show the status whether the required attributes have been entered for the row.
Operation Sequence	Operation sequence in the work order from which the material was derived. This can be the current operation or a previous automatically transact operation.
Component	Item number of the component. Component is for discrete work order user interface. <p>Note: For a supplier operation, the component represents Original Equipment Manufacturer-supplied component associated to the supplier operation with the supply type as "Operation Pull" or "Assembly Pull".</p>
Material	Item number of the component. Material is for process work order user interface.
Basis	Basis type as defined in the work order operation materials for the component.
UOM	Unit of measure as defined in the work order materials or in organization item definition.

Field	Description
Required	Required quantity as defined in the work order for nonserial-tracked items. For serial-tracked items defined in the work order, the required quantity is 1 for each row and there can be as many rows as the quantity of item required for the transaction.
To Transact	Set to required quantity for nonserial-tracked items with minimum as 1.
Secondary Quantity	Set to secondary quantity for nonserial-tracked items.
Secondary UOM	Secondary unit of measure as defined in the work order materials or in organization item definition.
Component Lot Number	Lot number for the item. Component Lot Number and Component Serial Number in the discrete manufacturing user interface.
Lot Number	Lot Number in the process manufacturing user interface.
Serial Number	Serial number for the item in the process manufacturing user interface.
Country of Origin	<p>For manufacturing plants which are enabled to track inventory by the country of origin, operators can optionally specify the country of origin from the list of countries. When the country of origin is specified, the on hand balances for the country are updated. If the country of origin isn't specified, the on hand inventory tracked without the country of origin will be updated. When the required balances aren't available, negative balances are created if the organization allows negative balances.</p> <p>You can perform discrete and process manufacturing transactions without providing the country of origin for specific items or items assigned to a specific category even when the organization mandates otherwise. You can define an attribute tracking exception for the country of origin at the item or item-category level using the Configure Inventory Attribute Exceptions setup task for Inventory Management.</p>
Additional Information Region	The additional information region is enabled for serial-tracked and nonserial-tracked operations.

Lots can be defaulted or manually entered by the user, based on the setting of the plant parameter, Lot Selection During Backflush.

- If the parameter is set to Manual, the lots aren't defaulted and the user manually enters the lots.
- If the parameter is set to Lot FIFO, the lots are defaulted on the basis of first in first out, using the receipt date.
- If the parameter is set to Lot FEFO, the lots are defaulted on the basis of first expiration first out, using the expiration date.

Autotransact Resources Train Stop

The Autotransact Resources train stop is displayed only if the Allow Quantity Changes During Backflush plant parameter is set up as Both or Resources. The following table lists the attributes in the Resources train stop:

Field	Description
Status	Icon to show the status whether the required attributes have been entered for the row.

Field	Description
Operation Sequence	Operation sequence in the work order from which the material was derived. This can be the current operation or a previous automatically transact operation.
Sequence	This is the resource sequence as in the work order operation resources.
Resource	Name of the resource.
Resource Instance	Name of the resource instance.
Resource Type	Resource type as defined in the work order resources or in resource definition.
Activity	Resource activity as defined in the work order resources or in resource definition.
Basis	Basis type as defined in the work order operation for the resource.
UOM	Unit of measure as defined in the work order resources or in organization item definition.
Required	Required quantity as defined in the work order resources.
To Charge	Set to Required quantity to make changes.

The job profile is validated when reporting labor. You can confirm the operator's qualifications when reporting an operation or resource transaction using the labor resource instance. During operation completion or resource charging, you can't proceed with an unqualified operator and need to reassign to a qualified operator.

The equipment profile is validated when reporting an equipment resource. When reporting equipment resources in the Autotransact Resources train stop of complete with details, the system will enforce an entry of a qualified equipment resource instance. The operation transaction date is used to validate whether the resource instance possesses a valid qualification on this date. You can't proceed with an unqualified equipment resource instance or without specifying a resource instance and need to assign a qualified equipment resource instance to complete the transaction.

Note: Although resources can't be associated to supplier operations on a work order, you can report specific resource usages at a supplier operation from the Autotransact Resources train stop.

Inventory Train Stop

In discrete manufacturing work orders, inventory train stop is displayed only if the operation is a product completion or reverse at the last operation. For process manufacturing work orders inventory train stop is displayed for all operations. This page displays all output items setup as automatic in the work order output items.

The following table lists the attributes in inventory train stop:

Field	Description
Status	Icon to show the status whether the required attributes have been entered for the row.
Output	Output item for process manufacturing work orders.
Description	Description of the output item.
Output Type	Output item type: can be product or by-product. This is for only process manufacturing work orders.
Operation Sequence Number	Operation sequence number can be the current operation sequence or the sequence number of a prior auto-transact operation.
UOM	Unit of measure for the output item quantity
Secondary UOM	Secondary unit of measure for the output item quantity.
Expected	Expected quantity for output based on transaction quantity, work order output quantity and the work order quantity. it's zero for ad hoc output items.
To Transact	The default transaction quantity. You can also update it to generate multiple rows for the transaction quantity. The total quantity in the rows must match the transaction quantity.
Secondary Quantity	The secondary transaction quantity.
Lot Number	<p>Preassigned lot numbers of the product display in the drop-down list. The work order number is defaulted as the lot number when the plant parameter "Default Lot Number for Work Order Product Completion" is enabled. This plant parameter defaults work order number as lot number even if there are no lot numbers preassigned.</p> <p>If the work order has multiple preassigned lots, the defaulting will be done during product completions only if the work order number is one of the lot numbers preassigned. If there is only one lot number preassigned in the work order for a product, it will be defaulted. In case, you delete the work order number from the preassigned lot numbers manually in the work order, then the lot number won't be defaulted.</p> <p>For process work orders, the defaulting of work order number as lot number is applicable for lot controlled primary output item only.</p> <p>You can't generate lot numbers during product completion or return if there are preassigned lot numbers for the product.</p>
Parent Lot Number	Parent Lot Number is used to group lot numbers. If the item attribute Child Lot Enabled is selected, you can optionally specify the parent lot number. You can either manually enter the parent lot number or you can click Generate Parent Lot to automatically generate the parent lot number. If an existing lot is used, the parent lot number can't be edited. If the existing lot doesn't have a parent lot number, the parent lot number can't be captured during completion transactions. For more information about parent lot numbers, refer to the Item Inventory Specification Attributes section in the Using Product Master Data Management guide.
Lot Expiration Date	The date on which the lot will expire.

Field	Description
	<p>Note: You can update the lot expiration date for the lots at the time of product completion. However, you can update the lot expiration date only if the lot expiration control attribute in item definition is set as User-defined expiration date. If the Lot Origination Date is updated, the Lot Expiration Date and the Hold Until Dates will be recalculated. Update of Lot dates is supported for work order and orderless transactions.</p>
Lot Origination Date	<p>The date on which the lot is manufactured. The Lot Origination date defaults to the Transaction date, which you can edit.</p> <p>Note: You can update the lot origination date for the lots that are either preassigned to the work order or for any lots at the time of product completion. Updating the lot origination date at the time of product completion automatically updates the Lot Expiration Date and Hold Until Dates as set up in the item definition.</p>
Hold Until Date	<p>The date until which the lot will be on hold. The Hold until date defaults to Lot Origination date + Hold days as in item definition, which you can edit during product completions.</p>
Serial Number	<p>Serial number of the product.</p>
Subinventory	<p>Completion subinventory as defined in the work order or in plant parameter Default Completion Subinventory.</p>
Locator	<p>Completion subinventory as defined in the work order or in plant parameter Default Completion Locator.</p>
Country of Origin	<p>For manufacturing plants which are enabled to track inventory by the country of origin, operators can optionally specify the country of origin from the list of countries. When the specific country of origin is specified, the on hand balances for the country of origin are updated. If the country of origin isn't specified, the on hand inventory tracked without the country of origin will be updated.</p> <p>You can perform discrete and process manufacturing transactions without providing the country of origin for specific items or items assigned to a specific category even when the organization mandates otherwise. You can define an attribute tracking exception for the country of origin at the item or item-category level using the Configure Inventory Attribute Exceptions setup task for Inventory Management.</p>
Additional Information Region	<p>The additional information region is enabled for serial-tracked and nonserial-tracked operations.</p>

- For process manufacturing work orders, you can add and delete output items in the work order operation. You can use the icons for adding and deleting output items at the table level. There are two buttons Generate Lot and Generate Serial in the table level. They are displayed only if the item is lot or serial-controlled at receipt. For process manufacturing, the Generate Lot and Generate Serial buttons are always displayed.
- If the product is set up as **Full lot control** enabled in the Product Information Management work area, you can select the required number of rows and click **Generate Lot** in Inventory train stop to automatically generate sequential lot numbers for your product. Generate Lot and Generate Serial buttons are always displayed for process manufacturing work orders.

- If the product is set up as serial control enabled, and it has the serial generation attribute set up as **Dynamic entry at inventory receipt** in the Product Information Management work area, you can select the required number of rows and click **Generate Serial** in Inventory train stop to automatically generate sequential serial numbers for your product.

Tip: You can also enter lot and serial numbers manually.

If the product is lot control enabled or serial control enabled, the additional information captures lot and serial attributes.

Note: If you have enabled Electronic Signatures and Electronic Records, you can submit the operation transaction for approval. An E-Signature page opens where you can view the status of the approval process of the operation transaction.

Work Order Operation is an inline signature approval flow. So, the user or operator who initiated the flow must not leave the transaction until it's approved by the approver. If the user leaves the transaction midway, the transaction gets into an unknown state and will have to be redone. Additionally, the user must refresh the signature page to ensure that the page doesn't time out after the inactivity time out that's set in their environment. After the approver approves or rejects the transaction, the user can see the approval status on the signature page and complete the transaction.

You can perform the undercompletion for the last operation using quick complete or complete with details action. You can't perform any operation transaction except reverse to ready in last operation for an undercompleted work order.

After the work order is undercompleted and status changes to completed, the work order header has a checkbox to indicate if the work order is Undercompleted. You can check the status of a work order if it is undercompleted from the details section of the work order header.

Using undercompletion tolerance to complete work orders helps you to decide to automatically have the work order to completed status whenever the production quantities fall short of expected quantity.

Note: You can update the lot control dates such as Lot origination date, Expiration date, and Hold Until date at the time of product completion using user interface, REST services and file-based data import (FBDI).

Related Topics

- [Overview of Production Execution Tasks](#)
- [How You Report Material Transactions](#)
- [How You Report Resource Transactions](#)
- [How You Report Orderless Transactions](#)
- [How You Manage Inspections](#)

Report an Operation Transaction for Discrete Work Orders

In this example, you can perform an operation transaction.

Steps to Perform for an Operation Transaction

The example discusses the steps required for completing the required quantities to inventory for a work order operation for a discrete manufacturing work order.

1. In the Work Execution work area, verify the manufacturing organization on the page. If it is not the correct organization, click the Change Organization and set it to the required organization.
2. On the Work Execution Overview page, in the Tasks pane, click the Review Dispatch List link.
3. On the Review Dispatch List page, use the Search region to search for the work order for which you want to perform the transaction. You can also search for a work order in a specific status.

The following table lists the specific values if you want to search for a work order by its status:

Field	Value
Work Area	Select the work area of the work order.
Work Center	Select the work center of the work order.
Status	Select the status of the work order. The valid values are: Complete, Optional, Ready, Reject, and Scrap.
Work Order	Enter the work order.
Work Method	Select the work method of the work order. The valid values are Discrete Manufacturing and Process Manufacturing. For discrete manufacturing work orders, select the Discrete Manufacturing work method. For process manufacturing work orders, select the Process Manufacturing work method.

4. Click the Search button. The records that fulfill the search criteria are displayed. Note that, you can also use the following fields to perform a search as per your requirement: Item, Start Date, Completion Date, and Serial Number.
5. Search for the row with the work order for which you want to perform the operation transaction. Click the expansion icon in the first column to expand the row.
6. Select the check box in the Complete column for the first serial number.
7. Click the Complete with Details button. Note that the Complete with Details option can be used only for Complete, Reject, or Scrap quantity, and not more than one quantity can be populated.
8. Leave the Transaction Date as system current date and time.
9. Enter any value in the Transaction Note field to indicate any information for the transaction.
10. Click Next. The Materials train stop is displayed.
11. In the Materials train stop, review the operation pull material requirements derived from the work order definition.
12. For the component that you want to perform the transaction, update the To Transact quantity. Note that the To Transact quantities are defaulted from the work order definition and can be updated to reflect actual usage quantities.
13. Click Next. The Resources train stop is displayed.

14. In the Resources train stop, for the resource that you want to perform the transaction, update the To Charge quantity. Note that the To Charge quantities are defaulted from the work order definition and can be updated to reflect actual usage quantities.
15. Click Next. Inventory train stop is displayed.
16. In Inventory train stop, leave the Subinventory as populated by the default value. Preassigned lot numbers of the product display in the drop-down list.
17. You can perform product completions or returns for work orders with preassigned lots. You will be able to complete or return the product only to one of the preassigned lots.

Note: This enforces completion to one of the preassigned lots during automatic product completions. Preassign lot number defaults lot number if only one lot is preassigned or if work order number is a preassigned lot number.

18. Click Generate Lot or Generate Serial in the following cases:
 - o If the product is set up as **Full lot control** enabled in the Product Information Management work area, you can select the required number of rows and click **Generate Lot** to automatically generate sequential lot numbers for your product.
 - o If the product is set up as serial control enabled, and it has the serial generation attribute set up as **Dynamic entry at inventory receipt** in the Product Information Management work area, you can select the required number of rows and click **Generate Serial** to automatically generate sequential serial numbers for your product.

Note: You can also enter lot and serial numbers manually.

19. You can update lot control dates such as, Lot Expiration Date, Lot Origination Date, and Hold Until Date.
20. Click Save and Close. A confirmation message is shown to confirm that the required quantities have been completed to inventory for the work order operation.

Note: You can update the lot control dates such as Lot origination date, Expiration date, and Hold Until date at the time of product completion using user interface, REST services and file-based data import (FBDI).

Note: Dual units of measure is supported in operation transactions. If you want to issue a material with dual units of measure, you must mention secondary quantity. If you want to complete a product with dual units of measure, you must mention the secondary quantity. In all transactions, the secondary unit of measure is derived from the item definition in Product Information Management. Only the secondary quantity is entered by the user.

Related Topics

- [Report a Resource Transaction](#)
- [Report a Material Transaction](#)

Report an Operation Transaction for Process Work Orders

As a production operator, here are the steps you can perform to complete the required quantities to inventory, for a work order operation of a process manufacturing work order.

1. In the Work Execution work area, verify the manufacturing organization on the Overview page. If it's not the correct organization, click **Change Organization** and set it to the required organization.

2. On the Work Execution Overview page, in the Tasks pane, click the **Review Dispatch List** link.
3. On the Review Dispatch List page, use the Search region to search for the work order for which you want to perform the transaction. You can also search for a work order in a specific status. Here are the listed attributes if you want to search for a work order by its status:

Field	Value
Work Area	Select the work area of the work order.
Work Center	Select the work center of the work order.
Status	Select the status of the work order. The valid values are: Complete, Optional, Ready, Reject, and Scrap.
Work Order	Enter the work order.
Work Method	Select the work method of the work order. The valid values are Discrete Manufacturing and Process Manufacturing. For process manufacturing work orders, select the Process Manufacturing work method. Note: The work method field is available only when you perform an advanced search.

4. Click **Search**.

The records that fulfill the search criteria are displayed.

Note: You can also use the following fields to perform a search as per your requirement: Item, Start Date, Completion Date, and Serial Number.

5. (Optional) Click **Advanced Search**.

The records that fulfill the search criteria are displayed.

Note: You can also use the following fields to perform an advanced search as per your requirement: Work Area, Work Center, Status, Work Order, Start Date, Completion Date, Serial Number, and Work Method.

6. Search for the row with the work order for which you want to perform the operation transaction. Click the expansion icon in the first column to expand the row.
7. Enter the quantity for the **Complete**, or **Reject**, or **Scrap**.

8. Click **Complete with Details**.
You can use the **Complete with Details** option only for **Complete**, **Reject**, or **Scrap** quantity, and not more than one quantity can be populated.
The Product train stop is displayed.
9. In the Product train stop, leave the **Transaction Date** as system current date and time.
10. Enter any value in the **Transaction Note** field to indicate any information for the transaction.
11. Click **Next**.
The Materials train stop is displayed.
12. In the Materials train stop, review the operation pull material requirements derived from the work order operation items.
13. For the material that you want to perform the transaction, update the **To Transact** quantity.
Note: The **To Transact** quantities are defaulted from the work order definition and can be updated to reflect actual usage quantities. You can change the quantity during Backflush. This change is allowed based on the plant parameter setup, which must be set as Materials or Both.
14. Click **Next**.
The Resources train stop is displayed.
15. In the Resources train stop, for the resource that you want to perform the transaction, update the **To Charge** quantity.
Note: The **To Charge** quantities are defaulted from the work order definition and can be updated to reflect actual usage quantities. You can change the quantity during Autotransact. This change is allowed based on the plant parameter setup, which must be set as Resources or Both.
16. Click **Next**.
Inventory train stop is displayed.
For process manufacturing work orders, Inventory train stop is displayed for all operations for operation completions but not for the **Reject** or **Scrap** transactions. For product completion with lot number preassigned for the products, you can complete to the preassigned lot numbers only. You can add any ad hoc output items for this operation. You can add output items, delete defaulted output items, or change quantities.
17. In Inventory train stop, for the output item that you want to perform the transaction, update the **Output Type** as product or by-product, and update the **To Transact** quantity.
Note: The Primary output item must have at least one lot number preassigned. Preassigning lot numbers to other products and by-products is optional. The default output item value of the **To Transact** quantity for process manufacturing work orders is the expected quantity. You can update the **To Transact** field manually. If the output item is serial controlled, then to transact quantity will be 1. The validation on the **To Transact** quantity isn't possible.
18. Click **Generate Lot** or **Generate Serial** in the following cases:
 - If the product is set up as Full lot control enabled in the Product Information Management work area, you can select the required number of rows and click Generate Lot to automatically generate sequential lot numbers for your product.
 - If the product is set up as serial control enabled, and it has the serial generation attribute set up as Dynamic entry at inventory receipt in the Product Information Management work area, you can select the required number of rows and click Generate Serial to automatically generate sequential serial numbers for your product.

Note: You can also enter lot and serial numbers manually.

19. Click Save and Close.

A confirmation message is shown to confirm that the required quantities have been completed to inventory for the work order operation.

Note: Dual units of measure is supported in operation transactions. If you want to issue a material with dual units of measure, you must mention secondary quantity. If you want to complete a product with dual units of measure, you must mention the secondary quantity. In all transactions, the secondary unit of measure is derived from the item definition in Product Information Management. Only the secondary quantity is entered by the user.

How You Report Material Transactions

The Report Material Transactions task enables a production operator to report materials for the work order operation. You can issue materials from inventory to the work order operation and return the issued materials back to inventory.

You can report a material transaction on the Report Material Transactions page. You can access this page from either of the following pages:

- On the Review Dispatch List page, click the Report Material Transactions icon for the work order operation. This link is enabled if a role assigned to you has the Report Material Transactions (WIP_REPORT_MATERIAL_TRANSACTIONS_PRIV) privilege associated to it.
- On the Work Execution Overview page, in Tasks pane, click the Report Material Transactions link. Select the work order and work order operation.

The material transactions can also be imported through the Material Transaction Web Service or through the predefined XLSM templates.

Tip: The autotransact operations aren't shown in the dispatch list. Hence, the materials for the auto transact operations are reported by accessing the Report Material Transactions page from the Work Execution Overview page.

CAUTION: In a contract manufacturing plant, you must not report material transactions for the contract manufacturer owned components.

Dual units of measure is supported in material transactions. If you want to issue an item with dual units of measure, you can specify both the quantities in both the primary and secondary unit of measures.

Issuing Materials to the Work Order Operation

On the Report Material Transactions page, the materials are issued to the work order by specifying the transaction type as **Issue**. You can control the issuing of the materials using the Show Components option. The **Show Components** option is defaulted based on the setting of the Default Transaction Mode plant parameter. However, you can edit the Show Components option as per your requirement.

- When the Show Components option is set to All: All the material requirements as defined on the work order for the operation with Push supply type are defaulted. This mode is ideally used when all the required materials are issued at once and there are minimal or no changes to the material requirements. The defaulted material requirements are sorted by the material control status and shown in the following order:

- a. Lot and serial controlled components
- b. Serial controlled components only
- c. Lot controlled components only
- d. Components with no serial or lot control

Within a particular material control status, the components are ordered by Inventory_item_id. Also, based on whether the **Default Transaction Quantity** plant parameter is set to material or both, the materials are defaulted with required quantity. The ad hoc materials, that's the materials not defined as required in the work order operation can be manually entered using the Add action.

Note: For a supplier operation, the component that's defaulted, represents Original Equipment Manufacturer-supplied component associated to the supplier operation with the supply type as "Push".

- When the Show Components option is set to Manually entered: The material requirements as defined on the work order for the operation aren't defaulted. You can enter the required materials manually. This mode is ideally used when only few of the required materials are issued at once.

You can enter the transact quantity, serial number, and lot number for the material based on the material control setup. The subinventory and locator are defaulted based on setup at work order or plant level. However, you can edit the Subinventory and Locator fields. The material transactions can also be reported by using a scanner. You can scan multiple serial numbers by scanning the component number once. You can optionally scan component serial attributes for components that are serial controlled at issue. Serial attributes if configured can be entered or updated for components which are serial controlled. For lot controlled components, it's possible to view lot attributes which have been entered in Oracle Inventory.

For the serial tracked manufacturing, in which the production is tracked using the serial numbers, the materials are issued with reference to the item serial number. For all the components, whether serial controlled, lot controlled, or uncontrolled, the issued quantities are tracked at the serial level.

If **Additional Manual Material Issue** is set to **Do not allow**, the operator can't manually issue additional materials that aren't defined in the work order with push supply type, or manually issue quantities greater than those specified in the work order.

If the Basis is set up as Fixed, then the materials appear only during the first transaction of the work order operation. Fixed components can be issued only once, and when issued, they won't appear again. The application will check whether there's any net issue against a material with Basis attribute as Fixed, which won't show as it has already been issued.

For manufacturing plants which are enabled to track inventory by the country of origin, operators can optionally specify the country of origin from the list of countries. When the country of origin is specified, the on hand balances for the country are updated. If the country of origin isn't specified, the on hand inventory tracked without the country of origin will be updated. When the required balances aren't available, negative balances are created if the organization allows negative balances.

You can perform discrete and process manufacturing transactions without providing the country of origin for specific items or items assigned to a specific category even when the organization mandates otherwise. You can define an attribute tracking exception for the country of origin at the item or item-category level using the Configure Inventory Attribute Exceptions setup task for Inventory Management.

Returning Materials to Inventory

On the Report Material Transactions page, the materials issued to the work order are returned to inventory by specifying the transaction type as Return. You can control the returning of the materials using the Show components option. The

Show components option is defaulted based on the setting of the Default Transaction Mode plant parameter. However, you can edit the Show components option as per your requirement.

- When the Show components option is set to All: All the materials issued to the work order for the operation with Push supply type are defaulted.
- When the Show components option is set to Manually entered: The material requirements as defined on the work order for the operation aren't defaulted and you can enter the required materials manually.

For the serial-tracked manufacturing, in which the production is tracked using the serial numbers, the materials are returned in reference to the item serial number.

When the Restrict lot numbers during return plant parameter is enabled, you can select and return only those lot numbers that have been issued from the lot numbers list at the work order operation. However, you can return any lot numbers though the same lot hasn't been issued in the following conditions

- if **Restrict lot numbers during return** plant parameter is NOT enabled
- if you have the **Allow unrestricted return to lot numbers** privilege when **Restrict lot numbers during return** plant parameter is enabled

Note: The material return for component at given operation can now be done only after the last issue of the component at the operation.

Note: If you have enabled Electronic Signatures and Electronic Records, you can submit the material transaction for approval. An E-Signature page opens where you can view the status of the approval process of the material transaction.

Negative Issue and Negative Return

If the quantity is negative and the transaction type is Issue, then it's a negative issue transaction. If the quantity is negative and the transaction type is Return, then it's a negative return transaction.

Items with a negative quantity and a Push supply type are transacted using negative issue transaction. The negative issue transaction removes the item from the assembly and issues it back to the stores. If the item is lot or serial controlled, you must specify details.

Items transacted with a negative issue transaction type can be returned back to the assembly through a negative return transaction. If the item is lot or serial controlled, you must specify details.

In addition to the negative quantity items specified in the work order, users can also transact ad hoc items with negative quantity through negative issue transactions. For a Rework work order, the defective item is removed using a negative issue transaction, and the replacement for that item is done using issue transaction.

If **Enable Genealogy Tracking** is set for the items, and the Rework work order is serial tracked, then the details of the assembly serial and component serials that are issued to the rework work order are posted to genealogy.

For material with **Dynamic at inventory receipt** serial generation, the Component Serial Number list of values will continue to show serial numbers which were previously issued to the manufacturing plant. However, you can also perform a negative material issue with a serial number which was previously issued to a different manufacturing plant. You can also enter a new serial number.

For material with serial generation setup at work order issue, you have the option to perform the negative material issue without a serial number, which you can configure by selecting the plant parameter **Allow negative issue without serial number entry**.

Related Topics

- [Overview of Production Execution Tasks](#)
- [How You Report Operation Transactions](#)
- [How You Report Resource Transactions](#)
- [How You Report Orderless Transactions](#)
- [Report a Material Transaction](#)

Report a Material Transaction

The example discusses reporting a material transaction in a serial tracked operation and the process of issuing materials to a work order operation. The steps in this example are applicable to discrete work orders.

Note: Serial tracked operations are currently supported for only discrete manufacturing. Process manufacturing supports only nonserial-tracked operations.

Steps to Report a Material Transaction

To issue materials to a work order operation, perform the following steps:

1. In the Navigator, click the Work Execution work area link.
2. Verify the manufacturing organization on the page. If it is not the correct organization, click the Change Organization and set it to the required organization.
3. On the Work Execution Overview page, in the Tasks pane, click the Review Dispatch List link.
4. On the Review Dispatch List page, use the Search region to search for the work order for which you want to perform the transaction.

The following table lists the specific values you must choose to search for work orders based on their statuses:

Field	Value
Work Area	Select the work area of the work order.
Work Center	Select the work center of the work order.
Status	Select the status of the work order. The valid values are: Complete, Optional, Ready, Reject, and Scrap.
Work Order	Enter the work order.

5. Click the Search button. The records that fulfill the search criteria are displayed. Note that, you can also use the following fields to perform a search as per your requirement: Item, Start Date, Completion Date, and Serial Number.
6. Search for the row with the work order for which you want to perform the transaction. Click the Materials link to report the material transaction.
7. Retain the Transaction Type option as Issue for issuing the materials to the work order operation. For returning the materials to inventory, you must select Return as the Transaction Type option.
8. Retain the default system date as the Transaction Date. You can update the field to a past date if required.
9. In the Show Components option, Select All to default all the material requirements defined on the work order for the operation with Push supply type. You can select Manually entered as the show components option so that the material requirements as defined on the work order for the operation are not defaulted and you can enter the required materials manually.
10. Now, the materials set up on the work order operation are shown in the page. You can manually enter a new material by adding a new row. In the new row, from the Component list, select the material. From the Component Serial Number list, select the serial number for the material.
11. For each material that you want to issue, in the To Transact field, enter the material quantity to be issued to the work order operation. The To Transact quantity is derived from the work order and can be updated to reflect the actual usage quantity. A check mark is shown in the Status field when all the required data is entered for the component.
12. Click the expansion icon of each updated row to view more details. Verify the correct subinventory in the Subinventory list and update it if required.
13. Click the Save and Close button. A confirmation message is shown on the successful completion of the material transaction.

Related Topics

- [How You Report Material Transactions](#)

How You Report Resource Transactions

A resource transaction is an execution transaction that charges the work order operation for the resources that are consumed in the operation. The resource transactions are reported for performing the following two tasks:

- To manually charge a resource to the work order operation.
- To reverse the charges made earlier for a resource to a work order operation.

Both charging and reversal are recorded as two separate transactions.

You can report a resource transaction on the Report Resource Transactions page. You can access this page from either of the following pages:

- On the Review Dispatch List page, click the Report resource transactions icon for the work order operation.
- On the Work Execution Overview page, in Tasks pane, click the Report Resource Transactions link. Select the work order and work order operation.

The Report Resource Transactions page opens with the resources that are set up in the work order operation with the charge type as Manual.

The following table lists the fields along with their descriptions on the Report Resource Transactions page:

Field	Description
Item	The product that's being manufactured in the work order.
Work Order Quantity	The quantity of the item that's being manufactured in the work order.
Work Center	The work center for the work order operation.
Transaction Type	The type of the resource transaction. The two options are: <ul style="list-style-type: none"> Charge: Select Charge for charging a work order operation with the resources consumed in the operation. Reverse: Select Reverse for reversing the charges to correct any clerical error.
Transaction Date	The following two validations must be honored: <ul style="list-style-type: none"> Transaction date must be same or later than the work order released date. Transaction date can't be a future date.
Project Number	Enter the project number. This field is available only for organizations that are enabled for inventory tracking by project.
Task Number	Select the task number. This field is available only for organizations that are enabled for inventory tracking by project.
Show Resources	The resources to be shown for the work order operation. The two options are: <ul style="list-style-type: none"> Manually Entered: When selected, only the manually entered resources are shown. The default resources from the work order aren't shown. All : When selected, all the resources including the resources that are defaulted from work order. The Show Resources option is derived based on the setting of the Default Transaction Mode plant parameter.
Status	Icon that shows whether or not the mandatory attributes have been entered for the row. Also, a plus icon is shown for the newly added ad hoc resources.
Sequence	The resource sequence within the work order operation resources. For the ad hoc resources that aren't set up in the work order, a new sequence is generated when the resource is added.
Resource	The name of the resource.
Resource Instance	The name of the resource instance.
Type	The resource type as defined in the work order resources or in the resource definition.
Activity	The resource activity as defined in the work order resources or in the resource definition.
Basis	The basis type as defined in the work order operation for the resource.

Field	Description
UOM	The unit of measure as defined in the work order resources or in the resource definition.
Required	The resource quantity to charge the work order operation. The To Charge field is defaulted to the quantity specified in the Required field if the plant parameter Default Transaction Quantity is set as either Both or Resource.
To Charge	The resource quantity to charge the work order operation. The To Charge field is defaulted to the quantity specified in the Required field if the plant parameter Default Transaction Quantity is set as either Both or Resource.

Charging Resources to the Work Order Operation

You can charge a work order operation for the labor and equipment resources that are consumed while performing the operation. The consumed resources can be the resources that are set up in the work order operation or any other additional ad hoc resources that are consumed during the operation. Select the Transaction Type as Charge for charging the resources. Optionally you can also select the resource instance. If the Basis is set up as Fixed, then the resource appears only during the first transaction of the work order operation. At first, the manual charging is checked. The net charged quantity must be zero for the resource in the work order operation with Basis attribute as Fixed. If it's not zero, then the resource isn't shown. This means that Fixed resources can be charged only once, and when charged, they won't appear again. The application will check whether there is any net charge against a resource with Basis attribute as Fixed, which won't show as it has already been charged.

The equipment profile is validated when reporting an equipment resource. You can confirm the equipment's qualifications when reporting an operation or resource transaction using the equipment resource instance. During operation completion or resource charging, you can't proceed with an unqualified equipment resource instance and need to reassign to a qualified equipment resource instance.

The job profile is validated when reporting labor. You can confirm the operator's qualifications when reporting an operation or resource transaction using the labor resource instance. During resource charging, you can't proceed with an unqualified operator and need to reassign to a qualified operator.

Reversing Resource Charges to the Work Order Operation

If a resource is charged by mistake, it can be reversed with another transaction of type Resource Reverse. Select the Transaction Type as Reverse for reversing the charged resources. If the Basis is set up as Fixed, then the resource appears only during the last transaction of the work order operation. For the last manual reverse, the quantity for resource in the work order operation must be zero in all the dispatch states except for Ready. And there must be some previously charged quantity that must become zero for the resource after the transaction.

Related Topics

- [Overview of Production Execution Tasks](#)
- [How You Report Operation Transactions](#)
- [How You Report Material Transactions](#)
- [How You Report Orderless Transactions](#)
- [Report a Resource Transaction](#)

Report a Resource Transaction

The following example illustrates reporting a resource transaction in an operation. The example discusses the process of charging resources to a work order operation.

Steps to Report a Resource Transaction

To charge resources to a work order operation, perform the following steps:

1. In the Navigator, click the Work Execution work area link.
2. Verify the manufacturing organization on the page. If it is not the correct organization, click the Change Organization and set it to the required organization.
3. On the Work Execution Overview page, in the Tasks pane, click the Review Dispatch List link.
4. On the Review Dispatch List page, use the Search region to search for the work order for which you want to perform the transaction.

You can also search for work orders by their statuses. The following table lists out all the search criteria on the basis of which you can query a work order:

Field	Value
Work Area	Select the work area of the work order.
Work Center	Select the work center of the work order.
Status	Select the status of the work order. The valid values are: Complete, Optional, Ready, Reject, and Scrap.
Work Order	Enter the work order.

5. Click the Search button. The records that fulfill the search criteria are displayed. Note that, you can also use the following fields to perform a search as per your requirement: Item, Start Date, Completion Date, and Serial Number.
6. Look for the row with the work order for which you want to perform the transaction. Click the Report resource transactions icon to report the resource transaction.
7. Retain the Transaction Type option as Charge for charging the resources to the work order operation.
For reversing any charged resources, you must select Reverse as the Transaction Type option.
8. Retain the default system date as the Transaction Date. You can update the field to a past date if required.
9. In the Show Resources option, select All to view all the resources including the ones set up on the work order operation.

You can also view only the manually entered resources by selecting Manually entered as the Show Resources option.

10. Now, the resources set up on the work order operation are shown in the page. If needed, you can manually enter a new resource by adding a new row. In the new row, from the Resource list, select the resource. You can

also add resource instances associated with the resource. Optionally, from the Activity list, select the resource activity.

11. For each resource that you want to charge, in the To Transact field, enter the resource quantity to be charged to the work order operation. The To Transact quantity is defaulted from the work order definition and can be updated to reflect the actual usage quantity.

A check mark is shown in the Status field when all the required data is entered for the resource.

12. Click the Save and Close button. A confirmation message is shown on the successful completion of the resource transaction.

Related Topics

- [How You Report Resource Transactions](#)

Output Transactions Reporting for Work Orders

For discrete manufacturing work order count point operations, an ad hoc output can be reported as an output completion transaction into a specified completion subinventory from the Review Dispatch List page. You can use the output reverse transaction to correct the output completion transaction. This capability is also available through File-Based Data Import (FBDI), ADFdi data import correction, and REST web service. The ad hoc output completions will use a fixed cost that is set up in the Manage Standard Costs page. The primary product is reported along with the operation completion transaction at the last operation.

Process manufacturing work orders can have multiple outputs at any operation. However, one of the output items in the processing manufacturing work order must be a primary output and other output items can be products or by-products. A process manufacturing work order can have only one primary output and it must have a primary output. The output items defined in the process work order operation can be of type Automatic or Manual. Automatic outputs are completed to inventory when the operation completion is reported for the operation. You can report the output items with completion type as Manual as output transaction on the Report Output Items page. You can add output items manually in the work order as well as update or delete them. However, you can't report outputs in resequenceable operations.

As a production operator, you can manually report the output items for a work order operation from the Review Dispatch List page in the Work Execution work area:

- The progress at a work order operation level by reporting the output items that were setup in the work order for manual reporting for process work orders.
- An ad hoc output can be reported as an output completion transaction.
- The output transaction types are complete and reverse.
- The output types are Product and By-product.

You can set up the output items in a process work order with completion type **Manual**, or you may not set up in the work order at all.

Select the row for the work order operation in the Review Dispatch List page and click the Report Output Transactions action icon. The **Report Output Items** page appears. By default, the process work order output items setup in the work order operation with completion type as **Manual** are reported in the Report Output Items page.

For manufacturing plants which are enabled to track inventory by the country of origin, operators can optionally specify the country of origin from the list of countries. When the specific country of origin is specified, the on hand balances for the country of origin are updated. If the country of origin isn't specified, the on hand inventory tracked without the country of origin will be updated.

You can perform discrete and process manufacturing transactions without providing the country of origin for specific items or items assigned to a specific category even when the organization mandates otherwise. You can define an attribute tracking exception for the country of origin at the item or item-category level using the Configure Inventory Attribute Exceptions setup task for Inventory Management.

When the Restrict lot numbers during return plant parameter is enabled, you can select and return only those lot numbers that have been issued from the lot numbers list at the work order operation. However, you can return any lot numbers though the same lot hasn't been issued in the following conditions

- if **Restrict lot numbers during return** plant parameter is NOT enabled
- if you have the **Allow unrestricted return to lot numbers** privilege when **Restrict lot numbers during return** plant parameter is enabled

Note: Dual units of measure is supported in output transactions for process work orders. If you want to issue a material with dual units of measure, you must mention secondary quantity. If you want to complete a product with dual units of measure, you must mention the secondary quantity. In all transactions, the secondary unit of measure is derived from the item definition in Product Information Management. Only the secondary quantity is entered by the user.

Report an Output Transaction for Process Work Orders

As a production operator, here are the steps you can perform to complete the output items to inventory which are setup for manual completion in the process manufacturing work order.

1. In the Work Execution work area, verify the manufacturing organization on the Overview page. If it's not the correct organization, click **Change Organization** and set it to the required organization.
2. On the Work Execution Overview page, in the Tasks pane, click the **Review Dispatch List** link.
3. On the Review Dispatch List page, use the Search region to search for the work order for which you want to perform the transaction. You can also search for a work order in a specific status.
4. Click **Search**.

The records that fulfill the search criteria are displayed.

Note: You can also use the following fields to perform a search as per your requirement: Item, Start Date, Completion Date, and Serial Number.

5. (Optional) Click **Advanced Search**.

The records that fulfill the search criteria are displayed.

Note: You can also use the following fields to perform an advanced search as per your requirement: Work Area, Work Center, Status, Work Order, Start Date, Completion Date, Serial Number, and Work Method.

6. Search for the row with the work order for which you want to perform the output transaction and click the **Report output transactions** icon.

Here are the listed attributes in the Report Output Items page.

Field	Value
Status	<p>Displays the status of the row entry.</p> <p>If all required fields are entered for the row, the status displays a tick mark.</p>
Output	Select the output item for process manufacturing work orders.
Description	<p>Displays the description of the output item.</p> <p>The description is defaulted from the selected output item definition.</p>
Output Type	<p>Select the output type.</p> <p>The valid values are: Product and By-product.</p> <p>The default value is By-product.</p>
UOM	Displays the default unit of measure of the selected output item.
Secondary UOM	Displays the secondary unit of measure of the selected output item.
Expected	<p>Displays the selected output item quantity.</p> <p>The expected output quantity is calculated and populated based on the work order output quantity and the work order quantity.</p> <p>The expected quantity value is zero for ad hoc output items.</p>
Previously Completed	<p>Displays the previously completed value. If no quantity is completed, it's zero.</p> <p>The previously completed value is read-only.</p>
To Transact	<p>Enter the output item quantity to perform the transaction.</p> <p>The default To Transact quantity for process manufacturing work orders is the expected quantity minus previously completed quantity.</p>
Secondary Quantity	Enter the secondary output item quantity to perform the transaction.

Field	Value
<p>Lot Number</p>	<p>Enter the lot number of the product.</p> <p>Preassigned lot numbers of the product display in the drop-down list. You can complete or return the primary products only to preassigned lots. If you have preassigned lots to other products or by-products, you will be able to complete or return only to the preassigned lots.</p> <p>If preassign lots is enabled for a work order, you will be able to initiate product completion for a primary output item only if at least one lot number is preassigned to work order.</p> <p>If there is only one lot number preassigned in the work order for a product, it will be defaulted. If there are multiple lot numbers preassigned and if work order number is a lot number, it will defaulted else, you will need to select the lot number from the drop-down list. You can't generate lot numbers during product completion or return if there are preassigned lot numbers for the product. In case, you delete the work order number from the preassigned lot numbers manually in the work order, then the lot number won't be defaulted.</p>
<p>Parent Lot Number</p>	<p>Parent Lot Number is used to group lot numbers. If the item attribute Child Lot Enabled is selected, you can optionally specify the parent lot number. You can either manually enter the parent lot number or you can click Generate Parent Lot to automatically generate the parent lot number. If an existing lot is used, the parent lot number can't be edited. If the existing lot doesn't have a parent lot number, the parent lot number can't be captured during completion transactions. For more information about parent lot numbers, refer to the Item Inventory Specification Attributes section in the Using Product Master Data Management guide.</p>
<p>Lot Expiration Date</p>	<p>Select the date on which the lot will expire.</p> <p>Note: You can update the lot expiration date for the lots at the time of product completion. However, you can update the lot expiration date only if the lot expiration control attribute in item definition is setup as User-defined expiration date.</p> <p>If the Lot Origination Date is updated, the Lot Expiration Date and the Hold Until Dates will be recalculated. Update of Lot dates is supported for work order and orderless transactions.</p>
<p>Lot Origination Date</p>	<p>Select the exact date on which the lot is manufactured. The Lot Origination date defaults to the Transaction date, which you can edit.</p>

Field	Value
	<p>Note: You can update the lot origination date for the lots that are either preassigned to the work order or for any lots at the time of product completion.</p> <p>Updating the lot origination date at the time of product completion automatically updates the lot expiration date and Hold Until Dates as setup in the item definition.</p>
Lot Hold Until Date	<p>Select the date until which the lot can be hold. The Hold until date defaults to Lot Origination date + Hold days as in item definition, which you can edit.</p> <p>Note: You can update the lot hold until date for the lots at the time of product completion.</p>
Serial Number	Enter the serial number of the product.

7. Click **Save and Close**.

A confirmation message is shown to confirm that the output items were reported to inventory for the work order operation on the Review Dispatch List page.

Note: You can update the lot control dates such as Lot Origination Date, Lot Expiration Date, and Hold Until Date at the time of product completion using user interface, REST services and file-based data import (FBDI).

How You Report Orderless Transactions

You can report the production transactions, such as reporting of completion or scrap of an item, without having to create a work order. These transactions can be reported with reference to a work definition that's used to determine the material and resource usages.

The reported production transactions can be reversed by reporting either Orderless Return or Return From Scrap transactions. The referenced work definition is used to return the materials back to inventory. The resource charges are also reversed based on the work definition.

You can report the orderless completion and scrap using the Report Orderless Completion page that's accessible from the Work Execution Overview page. You can report the orderless return and return from scrap using the Report Orderless Return page that's accessible from the Work Execution Overview page. You can also import the orderless transactions through the Material Transaction Web Service or Import Material Transaction file based import process.

CAUTION: You can't perform orderless transactions in a contract manufacturing plant. You can't report orderless transactions for configured items and you also can't report orderless transactions for process manufacturing work definitions.

Specifying the Product Information

In the Product train stop, you must specify the following item information and the reference to the work definition.

- **Transaction Type:** In the Report Orderless Completion page, select the Transaction Type as Complete for reporting the production completions. Or select the Transaction Type as Scrap for reporting the production scraps. In the Report Orderless Return page, select the Transaction Type as Return for reversing the production completions. Or select the Transaction Type as Return from Scrap for reversing the production scraps. The Scrap and Return from Scrap transaction types are enabled only if you have the WIP_REPORT_SCRAP_TRANSACTIONS_PRIV privilege.
- **Transaction Subtype:** The Transaction Subtype field represents the specific nature of the work that's being performed, such as standard production, prototyping, or repair. The Costing can derive the transaction accounts based on the Transaction Subtype field.
- **Work Definition:** After selecting the item, the work definition with the production priority as 1 is defaulted. However, you can select another work definition that determines the correct material and resource usage as per your requirement.
- **Generate Serial:** If your product is serial control enabled and has the serialization attribute set up as Dynamic entry at inventory receipt in the Product Information Management work area, you can either manually enter serial numbers or click Generate Serial to automatically generate sequential serial numbers.

Note: Dual units of measure is supported in orderless transactions. If you want to issue a material with dual units of measure, you must mention secondary quantity. If you want to complete a product with dual units of measure, you must mention the secondary quantity. In all transactions, the secondary unit of measure is derived from the item definition in Product Information Management. Only the secondary quantity is entered by the user.

Reviewing the Backflush materials

In the Backflush Materials train stop, you can review the material requirements. If the **Include component yield in material requirements** plant parameter check box is selected, the yield is considered in the calculation of the required quantity. The material usages specified in the selected work definition with the supply types as push, operation pull, or assembly pull are displayed.

If the plant parameter Allow quantity changes during backflush is set as either Materials or Both, you can perform the following:

- Modify the transaction quantities for the materials.
- Delete the defaulted material transactions.
- Add new material transactions.

Lots can be defaulted or manually entered by the user, based on the setting of the plant parameter, Lot Selection During Backflush.

- If the parameter is set to Manual, the lots aren't defaulted and the user manually enters the lots.
- If the parameter is set to Lot FIFO, the lots are defaulted on the basis of first in first out, using the receipt date.
- If the parameter is set to Lot FEFO, the lots are defaulted on the basis of first expiration first out, using the expiration date.

Note: If the lot and serial attributes descriptive flexfields attributes are set up, you can add additional information for the lot and serial attributes in the Additional Lot and Serial Information region.

Reviewing the Autotransact Resources

In the Autotransact Resources train stop, you can review the resource requirements. The resource usages specified in the selected work definition are defaulted as resource transactions with the required quantity.

If the plant parameter Allow Quantity Changes During Backflush is set as either Resources or Both, you can perform the following:

- Modify the transaction quantities for the resources and optionally mention resource instances.
- Delete the defaulted resource transactions.
- Add new resource transactions.

The job profile is validated when reporting labor. You can confirm the operator's qualifications when reporting an operation or resource transaction using the labor resource instance. During operation completion or resource charging, you can't proceed with an unqualified operator and need to reassign to a qualified operator.

The equipment profile is validated when reporting an equipment resource. When reporting equipment resources, the system will enforce an entry of a qualified equipment resource instance. The transaction date is used to validate whether the resource instance possesses a valid qualification on this date. You can't proceed with an unqualified equipment resource instance or without specifying a resource instance and need to assign a qualified equipment resource instance to complete the transaction.

Specifying Inventory Details

In Inventory train stop, you can specify inventory information. This is only applicable for complete and return transactions. Inventory train stop is disabled for the scrap and return from scrap transactions.

You can complete or return the transaction quantity from more than one subinventory or locator. You can complete the quantities to an existing lot or you can specify a new lot number.

Note: You can't reference a work definition with supplier operations to perform an orderless transaction.

If your product is lot control enabled, you can either manually enter lot numbers, or you can click **Generate Lot** to automatically generate sequential lot numbers. Also, if the item attribute Child Lot Enabled is selected, you can optionally specify the parent lot number. You can either manually enter the parent lot number or you can click Generate Parent Lot to automatically generate the parent lot number. If an existing lot is used, the parent lot number can't be edited. If the existing lot doesn't have a parent lot number, the parent lot number can't be captured during completion transactions. Refer to Item Inventory Specification Attributes section in the Using Product Master Data Management guide for more details.

If the lot and serial attributes descriptive flexfields attributes are set up, you can add additional information for the lot and serial attributes in the Additional Lot and Serial Information region.

If you have enabled Electronic Signatures and Electronic Records, you can submit the orderless transaction for approval. An E-Signature page opens where you can view the status of the approval process of the orderless transaction.

For manufacturing plants which are enabled to track inventory by the country of origin, operators can optionally specify the country of origin from the list of countries. When the specific country of origin is specified, the on hand balances for the country of origin are updated. If the country of origin isn't specified, the on hand inventory tracked without the country of origin will be updated.

You can perform discrete and process manufacturing transactions without providing the country of origin for specific items or items assigned to a specific category even when the organization mandates otherwise. You can define an

attribute tracking exception for the country of origin at the item or item-category level using the Configure Inventory Attribute Exceptions setup task for Inventory Management.

Related Topics

- [Overview of Production Execution Tasks](#)
- [Report an Orderless Transaction](#)

Report an Orderless Transaction

This example illustrates how to report production completion for an item as an orderless transaction.

Steps to Report an Orderless Transaction

Perform the following steps to report an orderless transaction:

1. On the Work Execution Overview page, in the Tasks pane, click the Report Orderless Completion link.
2. Enter the item for which you want to perform the transaction.
3. The Work Definition field gets automatically defaulted to the work definition with the production priority set as 1. Retain the value or select another work definition as per your requirement. The work definition determines the material and resource usages.

When you enter the item first time, the work definition does not get automatically set to the default value. So, you must enter the item code again. The second time, the work definition is defaulted.

4. Retain the Transaction Type as Complete to report a production complete transaction. The Complete option is by default selected but you can select the Scrap option to report a production scrap.
5. Enter or select values for the fields on the page as required.

The following table lists the fields and their corresponding values that you must select on the page:

Field	Value
Transaction Subtype	Select the subtype for the transaction.
Quantity	Enter the quantity of item on which you want to perform the transaction.
Note	Enter a description for the transaction to be added as note.

6. For organizations enabled for inventory tracking by project, you can enter the Project Number and Task Number in the Product train stop. All other project-related attributes are derived per the setup.
7. Click Generate Serial to automatically generate sequential serial numbers.

Note: You can perform this step only if your product is serial control enabled and has the serialization attribute set up as Dynamic entry at inventory receipt in the Product Information Management work area.

8. Click Next.

9. On the Orderless Complete: Backflush Materials page, review the material transactions defaulted from the work definition.
10. You can update the Transact Quantity field as required to reflect the usage quantities of the components.
11. Click Next.
12. On the Orderless Complete: Autocharge Resources page, review the resource transactions defaulted from the work definition.
13. You can update the To Charge field as required to reflect the usage quantities of the resources. You can optionally mention resource instance.
14. Click Next.
15. On the Orderless Complete: Inventory page, retain or update the value for the Subinventory field.
16. Click Generate Lot to automatically generate sequential lot numbers.

Note: You can perform this step only if your product is set up with the attribute Full lot control in the Product Information Management work area.

17. From the Save and Transact Another menu, select: click and Close.
18. The transaction is completed and a message is shown to confirm that the orderless completion is reported.

Related Topics

- [Overview of Production Execution Tasks](#)
- [How You Report Orderless Transactions](#)

Inspections

How You Manage Inspections

Integration of Oracle Manufacturing with Oracle Quality Management helps you to inspect at an operation and accordingly accept or reject the inspected transaction. The inspection results you enter and the specification limits set up in the inspection plan decide whether the serial or quantity of an operation can be accepted or rejected.

If you've been assigned a job role your enterprise uses for production operator work, and the Edit Inspection Results (QA_EDIT_INSPECTION_RESULTS_PRIV) privilege, you can use an inspection plan already set up for particular work order operations to perform inspection. You can inspect the operations based on certain inspection criteria. Only after you inspect the operation, the inspection results help drive whether the quantity in the operation is completed, rejected, or optionally scrapped.

An inspection plan can be associated with an item or item category that's being manufactured in your organization. Inspections can be performed at intermediate operations for the subassemblies or at the final operation for the finished product. Currently, process manufacturing can operate in the same plant as discrete manufacturing, as determined by the work method for products being produced. This capability enables you to model, track, and cost for materials and processes using the appropriate manufacturing method for each stage of production. As with discrete manufacturing, process manufacturing supports similar capabilities for in-house manufacturing and outside processing of standard products with the option to enable electronic records and electronic signatures for critical business events. You can design your production process with work definitions, manage production with a material availability check and work order picking, execute production with quality inspection and production exceptions, and perform cost rollup and cost accounting.

Note: Inspections can be performed only for count point in-house operations. Supplier operations, autotransact operations, or optional operations can't have inspections.

There are three different inspections pertaining to manufacturing that can be set up in quality management:

- Work in process Inspection
- Resource Inspection
- Inventory Inspection

Work In Process Sampling

The Work In Process Sampling in Quality Inspection Management provides the ability to select representative sample(s) out of a discrete or process manufacturing work order operation quantity to determine the quality of non-serialized work in process (WIP). You can specify the type of sampling to employ when you're defining your work in process inspection requirements. It's supported for inline inspections at non-serial tracked operations only. Inspections at serial tracked operations will continue to require that each individual serial to be inspected at that operation. You can define quantity per sample with a unit of measure for inspection.

WIP Sampling is supported for inline inspections while performing operation transactions.

For more information about WIP Sampling setup, refer the Using Quality Management guide.

Inspections for Work Order Operations

Navigate to the **Review Dispatch List** task to initiate inspection for an operation by selecting the required operation from the dispatch list. You can initiate the inspection and complete the operation transaction corresponding to the disposition based on inspection results. If the parent transaction succeeds, the inspection results are saved automatically.

Select the **Inspections** task from the Work Execution work area or the **View Inspections History** link from the Edit Work Order page to view the inspection results for specific work order operations.

Some steps must be completed in quality management before you can perform transactions for a work order operation. The following must be set up in quality management:

- Inspection Characteristics
- Approved inspection plans with appropriate criteria

When you navigate to the **Review Dispatch List** task, you can see a record of work order operations which are in Ready or Reject status. Inspection can be performed for both serial-tracked and nonserial-tracked operations. You can select **Quick Complete** or **Complete with Details** to enter the inspection results and complete the transaction.

Note: Transaction is eligible for the **Quick Complete** action based on certain existing criteria.

Once you enter the inspection results, the disposition is decided. Only quantities or serials that pass the inspection, can be completed. If some quantities or serials fail inspection, depending on your privileges, you can perform the reject or scrap transaction. You can also optionally move reject quantity to scrap.

Note: A nonconformance issue (NC) is issued automatically when there is any reject.

Rejected quantities can be reworked and inspected again from Reject status. A different inspection plan can be configured for inspection from Reject status.

For process manufacturing work orders, the output quantities will be calculated based on the transaction quantity approved by inspection.

Create Inspections

In case of standalone inspections, you can select the **Create Inspection** task to carry out an inspection for a work order operation, resource, or inventory. You must manually specify which work order operation, resource, or inventory you want to inspect and if a plan is already set up you can use that. Otherwise, you can specify your own characteristics or characteristic groups and inspect accordingly.

Select the **Create Inspection** task from the Work Execution work area and fill up the following fields:

- Select the **Type** as either Work in process, Resource, or Inventory based on the following considerations:
 - Select Inventory to inspect the inventoried items that may have been created through an orderless transaction. Select an inventoried item in case of Inventory type.
 - Select Resource to inspect a resource or the process such as the temperature at which an equipment is supposed to operate. Select the Resource in case of Resource type.
 - Select Work in process to inspect a serial-tracked or nonserial-tracked operation. Select the work order you want to inspect in case of a Work in process type.
- You can also fill in other details to make your search more efficient.

Note: The fields dynamically change depending on what you specify as the value for **Type**.

Depending on what you choose as **Type**, certain fields are required.

- You can initiate a work in process inspection for a work order operation from the dispatch list by clicking the Report Inspection Details icon against the work order operation row. The work order and operation details are defaulted. If the operation has multiple output items, you can select one output item.
- Fill in the item or work center or operation fields depending on what you have specified.
- Fill in the preassigned lot numbers that are populated in the drop-down list of the Lot field.

The preassign lot number enables a standalone WIP inspection against a preassigned lot at the last operation in a Discrete Work Order.

The preassign lot number enables a standalone WIP for preassigned lot for lot-controlled product or by-product at any operation in a Process Work Order.

- Fill in the required Inspection Quantity.

If an approved inspection plan already exists, you can select that to enter the inspection results. Click **OK**.

- If no inspection plan is defined, proceed to the inspection and select the **Add** icon to specify a Characteristic or a **Characteristic Group** for inspection.

Once you have entered the inspection results, click **Save** to save your changes. You receive a confirmation message if your transaction was successfully completed.

Note: If Issue types corresponding to Inspection is set to the User-defined or Inherited from Parent options, the process of creating them will fail. So, ensure that you use these settings only for legacy data import, if at all. It is recommended to always set them to Sequence-generated. You should use standalone inspections for process manufacturing work orders.

Related Topics

- [How You Report Operation Transactions](#)
- [Inspect Serial-Tracked In-House Operations](#)
- [Inspect Nonserial-Tracked In-House Operations](#)

Inspect Serial-Tracked In-House Operations

Use the Work Execution work area to complete inspection for all your work order operations which have required inspection assigned to them in quality management.

Inspections can be initiated only when the dispatch status is Ready or Reject. It can't be initiated from Scrap or Complete status.

You can enter inspection results during Quick Complete and Complete with Details. The primary purpose of these transactions is to report the progress of work as operation transaction. The inspection results decide the disposition as Complete, Scrap, or Reject.

Note: Serial-tracked operations are supported only for discrete work orders.

Setups To Be Completed Before Inspection

This is a decision table that explains certain conditions that must be met before you continue this task:

Setups	What Should Be Done?
Inspection Characteristics	These must be set up in order to use them in inspection plan specifications or to add them directly to an inspection.
Inspection Plan	An inspection plan is defined and associated with an item or an item category in the work order. Note: The plan must be WIP Inspection plan.
Inspection Criteria	The inspection criteria act as a trigger to initiate inspection either during operation completion from Ready or for Rework operations in Reject state.
Inspection Plan Status	The status of the plan you're associating with the item or item category must be set to Approved .
Inspection plan optional	The inspection plan is set up as a required attribute if you don't select this check box.

Quick Complete Action

Select the Review Dispatch List task and follow these steps to inspect the output of an operation which has mandatory inspection predefined in quality management:

1. Select a serial-tracked operation from the dispatch list which is **Ready** and expand the Details section.

For serial-tracked operations in Ready state, an **Inspect and Complete** check box is displayed against each serial number of the operation you're trying to complete the required inspection for. Select one or more of the check boxes and click **Quick Complete** to inspect the serials.

2. On the Quick Complete: Inspection page, you can view the applicable inspection plan for entering inspection results.

The page has certain context values populated corresponding to the inspection plan that's being used to inspect this particular operation. Those values are as follows:

- The attribute **Serials** in the inspection plan is populated with the total number of serials selected for inspection. You have to enter the inspection result separately for each serial.

Tip: You can scan the serial for inspection. Scanning the serial makes it the first serial in the list.

- Accept or Reject is displayed for each serial based on the results entered and is triggered by the logic in the inspection plan.
- The accepted, rejected, and pending quantities are populated at the inspection plan header level.
- Once the inspection result for every serial is processed and the disposition for each serial is displayed as Accept or Reject, you can click the **Save and Close** button.

When you click the **Save and Close** button, you view a dialog box titled Quick Complete: Work Order Operation Sequence if:

- There's at least one rejected serial.
 - You have scrap privilege.
3. In the Quick Complete: Work Order Operation Sequence dialog box you can select the **Scrap** check box for the serials in Reject state to discard the inspected serial for the operation.
 4. Click **Complete** to receive a confirmation message for a successful transaction or click **Cancel** to cancel the transaction.

If the transaction is canceled after inspection or if it fails, then all the transactions will be reset and the inspection results collected wouldn't be saved.

Complete With Details Action

The Complete With Details action allows you to choose only one serial at a time in case of serial-tracked operations. Select the Review Dispatch List task and follow these steps to inspect an operation which has mandatory inspection predefined in quality management:

1. Select the required operation from the dispatch list which is Ready and expand the Details section.

For serial-tracked operations in Ready state, an **Inspect and Complete** check box is displayed against each serial number of the operation you're trying to complete required inspection for. Select one serial and click **Complete With Details** to initiate inspection.

2. On the Complete With Details: Inspection Plan page, you're able to enter inspection results for the selected serial.

Accepted or Rejected is displayed based on the results entered and is triggered by the logic in inspection plan. Once you enter inspection results for the serial, and the disposition as Accepted or Rejected is done, the **Next** button is enabled.

3. Click **Next**. The Product page opens. You can view a summary of the current operation transactions you have inspected. Depending on the inspection results, the page is populated with the certain details:

The following table shows attributes and corresponding values populated on the Complete With Details: Product page:

Transaction Type	Values Populated
Complete	If the serial has passed inspection, the completed serial is displayed.
Reject	If the serial didn't pass inspection a different page is displayed where the Transaction Type is selected as Reject by default. You can choose the Scrap option only if you have scrap privilege.

Depending on whether you choose to move the rejected serial to scrap or retain it as rejected, you must provide a Scrap reason or a Reject reason respectively.

Note: If you navigate back to Product page from a subsequent page, none of the attributes except **Transaction Note** can be edited.

4. Click **Next**. The Backflush Materials page opens. You can view a list of all components which have items required for the transaction.
5. Click **Next**. The Resources page opens. You can view a list of all resources which have items required for the transaction.
6. Click **Next**. The Inventory page opens if the current operation is the last operation. You can view the serial for completion.
7. Click **Save and Close** to receive a confirmation message that your transaction has been successfully completed.

Related Topics

- [How You Manage Inspections](#)
- [Inspect Nonserial-Tracked In-House Operations](#)

Inspect Nonserial-Tracked In-House Operations

Use the Work Execution work area to complete inspection for all your work order operations which have required inspection assigned to them in quality management.

Inspections can be initiated only when the dispatch status is Ready or Reject. It can't be initiated from Scrap or Complete states.

For nonserial-tracked operations, you can either use the **Quick Complete** or the **Complete With Details** action to enter the inspection results. The inspection results decide the disposition as Complete, Scrap, or Reject.

Setups To Be Completed Before Inspection

This is a decision table that explains certain conditions that must be met before you continue this task:

Setups	What Should Be Done?
Inspection Characteristics	These must be set up in order to use them in inspection plan specifications or to add them directly to an inspection.
Inspection Plan	<p>An inspection plan is defined and associated with an item or an item category in the work order.</p> <p>You can specify the inspection level to use with a given Work In Process inspection plan. You can override the default inspection level of 100% and specify the inspection plan level of your choice. However, you can only use the mandatory Work In Process inspection plans to perform in-line Work In Process inspections.</p> <p>Note: The plan must be WIP Inspection plan and the Plan Type must be Work in Process.</p>
Inspection Criteria	The inspection criteria sets the trigger to initiate inspection at the required operation and dispatch status.
Plan Status	The status of the plan you're associating with the item or item category must be set to Approved .
Inspection plan optional	The inspection plan is set up as a required attribute if you don't select this check box.

Quick Complete Action

Select the Review Dispatch List task and follow these steps to inspect the output of an operation which has mandatory inspection predefined in quality management:

1. Select a nonserial-tracked operation from the dispatch list which is in Ready state and expand the Details section.

For nonserial-tracked operations in Ready state, **Inspect and Complete** is displayed against the operation you're trying to complete required inspection for.

2. Specify the quantity you want to inspect and complete and click **Quick Complete**.
3. On the Quick Complete: Inspection Plan page, you can view the applicable inspection plan for entering inspection results.

The page has certain context values populated corresponding to the inspection plan that's being used to inspect this particular operation. Those values are:

- The inspection plan displayed has the quantity populated as the quantity you specified for inspection. Based on the inspection level in the Inspection Plan, the number of samples to be inspected would be calculated.
- The inspection plan automatically generates a sequential number. You can select each number from the side panel and enter inspection results against a quantity sample.

- Accept or Reject is displayed for each sample based on the results entered and the total accepted or rejected quantities are calculated by the logic in the Inspection Plan.
- Accepted, Rejected, and Pending quantities are populated at the inspection plan header level.
- Once the inspection results for every sample quantity and the disposition for each sample as Accepted or Rejected are done, the **Save and Close** button is enabled.

When you click **Save and Close** button, you can view a dialog box titled Quick Complete: Work Order Operation Sequence if:

- There's some rejected quantity.
 - You have scrap privilege.
4. On the Quick Complete: Work Order Operation Sequence dialog box you can change the quantities from Reject to Scrap without altering the total quantity.
 5. Click **Complete** to get a confirmation message for successful transaction or click **Cancel** to cancel the transaction.

If the transaction is canceled after inspection or if it fails, then all the transactions would be reset and the inspection results collected wouldn't be saved.

Complete With Details Action

The Complete with Details action, allows you to complete, scrap and reject quantities in one transaction cycle. Select the Review Dispatch List task and follow these steps to inspect the output of an operation which has mandatory inspection predefined in quality management:

1. Select an operation from the dispatch list which is Ready and expand the Details section.

For nonserial-tracked operations in Ready state, **Inspect and Complete** is displayed against the operation you're trying to complete required inspection for.

2. Specify the quantity you want to inspect and complete and click **Complete With Details**.

On the Complete With Detail: Inspection Plan page, you can view the applicable inspection plan for entering inspection results.

The page has certain context values populated corresponding to the inspection plan used to inspect this particular operation. Those values are:

- The inspection plan displayed has the quantity populated as the quantity you specified for inspection. Based on the inspection level in the Inspection Plan, the number of samples to be inspected would be calculated.
- The inspection plan automatically generates a sequential number for each sample quantity. Select each of them to enter results individually.
- Accept or Reject is displayed for each sample based on the results entered and the total accepted or rejected quantities are calculated by the logic in the Inspection Plan.
- Accepted, Rejected, and Pending quantities are populated at the inspection plan header level.
- Once the inspection results for every sample quantity and the disposition for each sample as Accepted or Rejected are done, the **Next** button is enabled.

3. Click **Next**. The Product page opens. You can view a summary of the current operation transactions you have inspected.

The following table lists the attributes of the Complete With Details: Product page, depending on the inspection results:

Attributes	Values Populated
Complete	The accepted quantity by inspection is populated by default and can't be edited.
Reject	The rejected quantity in inspection is the default value. It can be edited only if you have scrap privilege.
Scrap	The default value populated is zero. This can be edited only if you have scrap privilege.
Reject Reason	This is enabled only if the reject quantity is greater than zero.
Scrap Reason	This is enabled only if the scrap quantity is greater than zero.

Note: You can't edit the total transaction quantity at any point in the flow. You can only choose to move the reject quantity to scrap. If you navigate back to Product page from a subsequent page, none of the attributes except **Transaction Note** can be edited.

4. Click **Next**. The Backflush Materials page opens. You can view a list of all components which have items required for the complete, reject and scrap transactions.

Note: When the component quantities are increased or decreased or if a new component is added, then the change in quantity is implemented for any one of the transactions.

5. Click **Next**. The Resources page opens. You can view a list of all resources which have items required for the complete, reject and scrap transactions.

Note: When the transaction quantity for the resource is increased or decreased or if a new resource is added, then the change in quantity is implemented for any one of the transactions.

6. Click **Next**. The Inventory page opens. You can view the quantity for completion. Scrap and Reject quantities are not included.

The Inventory page is displayed only if the current operation is the last operation.

7. Click **Save and Close**. You receive a confirmation message if your transaction was successful.

Related Topics

Production Transactions

Overview of Electronic Signatures and Electronic Records for Production Transactions

You can enable the ability to capture electronic signatures and generate electronic records inline while reporting the following in the Work Execution work area.

- Work Order Material Transaction
- Work Order Operation Transaction
- Work Order Output Transaction
- Orderless Transaction

To capture electronic signatures and generate electronic records for Work Order Material Transaction, Work Order Operation Transaction, and Orderless Transaction in an organization, you need to set up the following:

- Enable Work Order Material Transaction, Work Order Operation Transaction, and Orderless Transaction as Required for the Organization. Follow these steps:
 - a. In the Setup and Maintenance work area, go to the following:
 - Offering: Manufacturing and Supply Chain Materials Management
 - Functional Area: Facilities
 - Task: Configure Electronic Signature Preferences
 - b. Enable the E-Signature for Production Transaction.
- Configure the Business Process Rules to Determine the Approvers for Work Order Material Transaction, Work Order Operation Transaction, and Orderless Transaction. Follow these steps:
 - a. In the Setup and Maintenance work area, go to the following:
 - Offering: Manufacturing and Supply Chain Materials Management
 - Functional Area: Facilities
 - Task: Manage Task Configurations for Supply Chain Management
 - b. Define approval rules for Production Transaction.

Note: For more information about implementing E-Signatures and generating E-Records, refer to the Implementing E-Signatures and E-Records chapter of the Oracle SCM Cloud Implementing Manufacturing and Supply Chain Materials Management guide.

How You Capture E-Signatures and Generating E-Records for Production Transactions Management

When you enable electronic signatures and electronic records for Work Order Material Transaction, the inline process to generate electronic records and capture electronic signatures is initiated when you submit a material issue or return transaction for approval through the Report Material Transactions page.

The E-record contains information about the following:

- Work Order Details
- Operation Details
- Material Transaction Details with Material Lot and Serial Details

Note: The process isn't initiated when a material transaction is imported through file-based data import or web service.

If you enable electronic signatures and electronic records for Work Order Operation Transaction, the inline process to generate electronic records and capture electronic signatures is initiated. The process begins when you report quantities or serials as any of the following:

- Completed
- Scrapped
- Rejected or Reversed to Ready

You can start the process at a work order operation using Quick Complete or Complete with Details actions in the Review Dispatch List page or Manage Supplier Operations page.

The E-Record contains information about the following:

- Work Order Details
- Operation Details
- Inspection Details
- Attachment Details
- Operation Transaction Details
- Product Transaction Details with Product Lot and Serial Details
- Backflush Material Details with Material Lot and Serial Details
- Inspection Results Details
- Quality Issue Details
- Material Transaction Details

Note: If multiple transactions, such as **complete**, **scrap**, and **reject** are reported through a single action, then a single electronic record is generated which contains the details of all the transactions reported.

Note: The process isn't initiated when an operation transaction is imported through file-based data import or web service.

Similarly, if you enable electronic signatures and electronic records for Orderless Transaction, the inline process to generate electronic records and capture electronic signatures is initiated. The process begins when you report an orderless completion transaction or an orderless scrap transaction through the Report Orderless Completion page, or an orderless return or an orderless return from scrap transaction through the Orderless Return page.

The E-Record contains information about the following:

- Orderless Transaction Details
- Attachment Details
- Inventory Transaction Details
- Backflush Material Details

Note: The process isn't initiated when an orderless transaction is imported through file-based data import or web service.

When you submit a work order material transaction, work order operation transaction, or an orderless transaction for approval, you can also be an approver of the transaction. You can review the electronic records, enter comments, and indicate your approval or rejection and sign the E-Record in the E-Signature page.

Notifications are sent to other approvers who can access them through bell notifications in the Oracle Cloud application. Approvers can review the electronic records before adding their electronic signature, enter their comments, indicate their approval or rejection and sign the electronic record by entering their password. The transaction isn't saved until all approvals are completed. Depending upon the outcome of the approval, the transaction is saved or rolled back.

You can search and view the existing E-Records for Work Order Material Transaction, Work Order Operation Transaction, and Orderless Transaction from the Electronic Records work area.

Note: For more information about capturing E-Signatures and generating E-Records, refer to the Oracle SCM Cloud Using E-Records, refer to the Oracle SCM Cloud Using E-Signatures and E-Records guide.

Review Production Transaction History

Using the Production Transaction History page, you can view all the production transactions that have been reported on the shop floor. The view is sorted in reverse chronological order to allow recent transactions to be displayed first. You can filter the production transactions based on a transaction date range, item serial number, work order, or item.

The Production Transaction History page, accessible from the Work Execution Overview page, enables you to view the production transaction history of a work order and the orderless transaction history of an item. The Production Transaction History page for the work order can also be accessed using the transaction history link in the work order History tab.

Note: Dual units of measure is supported in production transaction history.

Note: The UDI is generated as part of the discrete work order product completion or during orderless completion and the generated UDI can be seen in the production transaction history.

Reviewing Production Transaction History of a Work Order

You can view the material, resource (with resource instance details if mentioned during the transactions), and operation transactions for a work order execution. You can view the corresponding backflushed material and automatically charged resources for the operation transactions. Additionally, you can view the production completions into inventory for the operation transactions for the last operation sequence. For process work orders, manual output transactions are displayed as product completions without a parent transaction reference (operation transaction reference).

Note: Materials include components and products, or outputs in the case of process manufacturing work orders.

To review the production transaction history of a work order, perform the following steps:

1. On the Production Transaction History page, in the Search region, you can query by certain values.

The following table lists the various values based on which you can query the production transactions:

Field	Description
Search For	Retain the Work orders option.
Work Order	Enter the work order number for which you want to view the production transaction history.

2. Click the Search button. The production transactions reported for the work order are shown.
3. Review the production transaction history of the work order. This includes the operation transactions, automatically charged resource transactions, and backflushed material transactions reported for the work order. Also includes output items reported manually for process work order.
4. Click the Done button.

Reviewing Orderless Transaction History of an Item

You can view the orderless completion, scrap, return or return from scrap transactions for an orderless execution. You can view the corresponding backflushed materials and automatically charged resources for the orderless transactions.

To review the orderless transactions for an item, perform the following steps:

1. On the Production Transaction History page, in the Search region, you can query by certain values.

The following table lists the various values based on which you can query the production transaction history:

Field	Description
Search For	Select the Orderless option.
Item	Enter the item name for which you want to view the orderless transaction history.

2. Click the Search button. The orderless transactions reported for the item are shown.
3. Review the orderless transaction history of the item.

4. Click the Done button.

Related Topics

- [Overview of Production Execution Tasks](#)

How You Pick Materials for Work Orders

In the Work Execution work area, use the Pick Materials for Work Orders task to pick materials for work orders that are in released status. Clicking the Pick Materials for Work Orders task opens the scheduler job page.

This task initiates the movement of those materials from a common stock inventory to a shop floor supply subinventory to make them available to the work orders scheduled for production. As a production supervisor, you can schedule or submit the materials picking to more effectively control and move the materials to the shop floor for use in production.

You can initiate the picking of materials for timely availability of materials during production from the following pages:

- Manage Work Orders page
- Manage Material Availability Assignments page
- Pick Materials for Work Orders scheduler job, which is initiated by clicking the **Pick Materials for Work Orders** task on the Work Execution work area

For more information about how to release and pick materials from the Manage Work Orders page and the Material Availability Assignments page, refer the following topics from the Manage Production chapter of the Using Manufacturing guide:

- Overview of Work Orders
- How You Manage Work Order Material Availability Assignments

You can integrate pick materials with Oracle Fusion Cloud Warehouse Management, or another warehouse management system to reserve, pick, move, and work order material from a warehouse to a supply subinventory, or issue material directly to a work order based on the work order material picking requests generated in Oracle Cloud Manufacturing.

For more information about picking of materials for work orders refer to the Using Inventory Management guide.

Define Parameters for Picking of Materials

Initiate the scheduled process for picking from the Work Execution work area. The scheduled process creates a movement request to move your wanted materials to the appropriate shop floor location.

Follow these steps:

1. In the Work Execution work area, select the **Tasks** panel.
2. In the Execute Production section, select the **Pick Materials for Work Orders** task.

3. Specify the parameters required for picking.

The following table provides you information about how to specify the different parameters:

Parameter	Value to be Specified	Considerations
Organization	Specify the organization where you're executing production.	This is a required parameter. The list of values displays all organizations that you have access to and you can select from the list.
Work Method	This value is populated based on the organization you select. Depending on the organization, the work method parameter takes one or more of these values: <ul style="list-style-type: none"> ○ All ○ Discrete Manufacturing ○ Process Manufacturing ○ Maintenance Management 	If you have selected a manufacturing organization, which has more than one work method, the work method is defaulted as All.
Work Order Type	Select one of the following values: <ul style="list-style-type: none"> ○ All ○ Standard ○ Nonstandard ○ Rework ○ Transform 	<p>If the work method is discrete manufacturing, you can choose the type of work order from this list of values.</p> <p>If the work method is process manufacturing, only the standard work order is available.</p> <p>If the work method is maintenance, you can choose the type of work order from the list of values:</p> <ul style="list-style-type: none"> ○ All ○ Preventive ○ Corrective
Pick Materials For	Select one of the following values to pick materials for multiple work order operations: <ul style="list-style-type: none"> ○ All Work Orders ○ Partially Picked Work Orders ○ Work Orders Not Picked 	<p>If you have selected a partially picked work orders, the materials are picked up for work orders that have been partially picked.</p> <p>The All Work Orders is the defaulted value to pick materials for work order operations.</p>
From Work Order	Select a work order to pick materials from the work orders list.	This parameter defines the range of work orders to pick materials from a work order.

Parameter	Value to be Specified	Considerations
To Work Order	Select a work order to pick materials from the work orders list.	This parameter defines the range of work orders to pick materials to a work order.
From Operation Sequence	Provide a specific work order operation sequence to pick materials from.	This parameter is a numeric value.
To Operation Sequence	Provide a specific work order operation sequence to pick materials to.	This parameter is a numeric value.
Work Center	Specify the work center where you're executing production.	
From Work Order Operation Start Date	Represents the planned start date of the operation and also referred as scheduled start date to pick materials from. This is a mandatory attribute. The operation start date must be encompassed within the work order start and completion date.	The maximum duration between the From Work Order Operation Start Date and To Work order Operation Start Date is 90 Days.
To Work Order Operation Start Date	Represents the planned completion date of the operation and also referred to the scheduled completion date and time of the work order operation. The completion date must be encompassed within the work order start and completion date.	The maximum duration between the From Work Order Operation Start Date and To Work order Operation Start Date is 90 Days.
Hours Ahead	The default value is 8. You can specify any value up to 500.	This is a required parameter. This represents the number of hours ahead of current time until which you want materials to be picked.
Hours Behind	You can specify any value up to 500.	This represents the number of hours behind the current time within which you want materials to be picked.
Pick Slip Grouping Rule	The list of values are defaulted from what's specified in plant parameters.	This is a required parameter. The grouping rule enforces on what basis your pick slips can be grouped together. Note: Pick Slip Grouping Rule isn't applicable if manufacturing is integrated with warehouse management system.

Parameter	Value to be Specified	Considerations
Project Number	The project number associated with the work order. This parameter is available if the organization is tracked by project.	None Note: Project isn't applicable if manufacturing is integrated with warehouse management system.
Task Number	The task number associated with the work order. This parameter is available if the organization is tracked by project.	None Note: Task isn't applicable if manufacturing is integrated with warehouse management system.

- The **Print pick slips** check box selection is inherited from what's specified in the plant parameter. If you don't want to print the pick slip report you can deselect the check box.
You can also route the pick slip report to the output devices such as fax, printer, and email, based on the plant parameters defined up in the Manage Inventory Document Output Preferences task in Inventory. You can configure these output devices through the Manage Inventory Document Output preferences inventory task for the Pick Materials for Work Orders scheduled process.
- Select the **Pick a work order only if all eligible materials are available** check box if you don't want partial picking for work orders.
- Select the **Enable parallel processing** check box to consider material picking for different work orders in parallel.
- Click Submit.

Note: You can also schedule this task periodically to generate the picking request. Click Advanced and select **Using a schedule**.

You can pick materials only for work orders that are in Released status. The following table summarizes how picking is carried out for other work order statuses.

Work Order Status	Impact on Picking
Canceled	If the pick slip is confirmed when the work order status is set to canceled, there is no impact on picking. If the pick slip isn't confirmed when the work order is set to canceled, the pick slip line is canceled.
Closed	If the pick slip is confirmed when the work order status is set to closed, there is no impact on picking. If the pick slip isn't confirmed when the work order is set to closed, the pick slip line is canceled.
Unreleased	If the pick slip is confirmed when the work order status is set to Unreleased, there is no impact on picking. If the pick slip isn't confirmed when the work order is set to Unreleased, the pick slip line is canceled.

Conditions for Material Issue During Picking

The following table summarizes the various conditions, parameters, and scenarios that have an impact on material issue during the picking activity.

Issue Push materials Directly	Work Order Operation	Material	Supply Type	Subinventory	Move Order	Move Order Line Type
Yes	Serialized	Serial-tracked	Pull	Derived from plant parameters or specified in the work order	Moved to subinventory	WIP Material Pick
Yes	Serialized	Nonserial-tracked	Pull	Derived from plant parameters or specified in the work order	Moved to subinventory	WIP Material Pick
Yes	Serialized	Serial-tracked	Push	Specified in the work order	Moved to subinventory	WIP Material Pick
Yes	Serialized	Serial-tracked	Push	Not specified	Not picked	Not applicable
Yes	Serialized	Nonserial-tracked	Push	Specified in the work order	Moved to subinventory	WIP Material Pick
Yes	Serialized	Nonserial-tracked	Push	Not specified	Not picked	Not applicable
Yes	Nonserialized	Serial-tracked	Pull	Derived from plant parameters or specified in the work order	Moved to subinventory	WIP Material Pick
Yes	Nonserialized	Nonserial-tracked	Pull	Derived in the plant parameters or specified in the work order	Moved to subinventory	WIP Material Pick
Yes	Nonserialized	Serial-tracked	Push	Specified in the work order	Directly issued to work order	WIP Material Issue
Yes	Nonserialized	Serial-tracked	Push	Not specified	Directly issued to work order	WIP Material Issue
Yes	Nonserialized	Nonserial-tracked	Push	Specified in the work order	Directly issued to work order	WIP Material Issue
Yes	Nonserialized	Nonserial-tracked	Push	Not specified	Directly issued to work order	WIP Material Issue

Issue Push materials Directly	Work Order Operation	Material	Supply Type	Subinventory	Move Order	Move Order Line Type
No	Serialized	Serial-tracked	Pull	Derived from plant parameters or specified in the work order	Moved to subinventory	WIP Material Pick
No	Serialized	Nonserial-tracked	Pull	Derived from plant parameters or specified in the work order	Moved to subinventory	WIP Material Pick
No	Serialized	Serial-tracked	Push	Specified in the work order	Moved to subinventory	WIP Material Pick
No	Serialized	Serial-tracked	Push	Not specified	Not picked	Not applicable
No	Serialized	Nonserial-tracked	Push	Specified in the work order	Moved to subinventory	WIP Material Pick
No	Serialized	Nonserial-tracked	Push	Not specified	Not picked	Not applicable
No	Nonserialized	Serial-tracked	Pull	Derived from plant parameters or specified in the work order	Moved to subinventory	WIP Material Pick
No	Nonserialized	Nonserial-tracked	Pull	Derived from plant parameters or specified in the work order	Moved to subinventory	WIP Material Pick
No	Nonserialized	Serial-tracked	Push	Specified in the work order	Moved to subinventory	WIP Material Pick
No	Nonserialized	Serial-tracked	Push	Not specified	Directly issued to work order	WIP Material Issue
No	Nonserialized	Nonserial-tracked	Push	Specified in the work order	Moved to subinventory	WIP Material Pick
No	Nonserialized	Nonserial-tracked	Push	Not specified	Directly issued to work order	WIP Material Issue

Overpicking Materials for Work Orders

In a scenario when you can't reasonably or quickly split up the allocated quantity of material on your pick slip, you need the ability to pick more than the requested quantity and then move it to an area for further processing. To enable overpicking materials for work orders, you need to select **Allow overpicking for special handling** in Manage Inventory

Organization Parameters. This enables you to specify more than the requested quantity on your pick-and-move requests for work orders, and move it to a staging or processing location.

You can overpick materials under the following conditions:

- The materials are nonserial-tracked.
- Detailed level reservation doesn't exist for the materials. You can overpick materials if high level reservation exists.
- If eligible for direct issue, the requested quantity will be directly issued to work order. The excess quantity remains in the staging subinventory or supply subinventory, which can then be moved back to the source subinventory.

Related Topics

- [Assess Reports to Pick Materials for Work Orders](#)
- [Considerations for Picking Materials](#)
- [How You Manage Work Order Material Availability Assignments](#)
- [Overview of Work Orders](#)
- [How You Manage Work Order Operation Items](#)

Considerations for Picking Materials

When you initiate the scheduled process Pick Materials for Work Orders in the Work Execution work area, you're creating a movement request in inventory. This creates movement lines for materials to be either directly issued to the work order which is in released status and must be started on the shop floor, or to be moved to a destination subinventory from where materials are available during production. There are a few points that must be considered.

They're as follows:

Work Order Status Changes

When the work order status is changed from released to canceled, closed, or unreleased, the following points must be considered:

- If there is any open movement request, the movement request lines are canceled.
- If the movement request line is pick confirmed, the allocated and picked quantity can't be reversed.

If Oracle Manufacturing is integrated with warehouse management system, you can't change the status of a work order to canceled, closed and unreleased when open movement requests exist in warehouse management system.

Work Order Quantity Changes

When the work order quantity is changed, the following points must be considered:

- If the work order quantity is increased, the work order is updated and the increase in materials is considered for the next pick release action.

- If the work order quantity is decreased, there is no impact on the material quantity because the decreased work order quantity can't be less than the issued material quantity. You're notified about the open movement request for the work order.

If Oracle Manufacturing is integrated with warehouse management system, you can't reduce the work order quantity when open movement requests exist in the warehouse management system.

Work Order Material Quantity Changes

When the material quantity for a work order is changed, the following points must be considered:

- If the work order material quantity is increased, the increase in material quantity will be considered for the next pick release action.
- If the work order material quantity is decreased, there is no impact on the material quantity because the decreased work order material quantity can't be less than the issued material quantity. You're notified about the open movement request for the work order material.
- If the work order material is deleted, the quantity is updated to zero or negative and if there are any open movement request lines, they're canceled.

Note: The material quantity is updated to negative only in case of rework and transform work orders.

If Oracle Manufacturing is integrated with warehouse management system, you can't reduce the work order material quantity, or change the supply type when open movement requests exist in warehouse management system.

Movement Request Status Changes

When the status of a movement request is changed, the following points must be considered:

- If the move order is canceled, the quantity to be moved is updated.
- If the move order is closed, the quantity to be moved is updated.
- If the move order is partially picked, the quantity to be moved is updated.

Note: The work order materials corresponding to the movement request lines would be eligible for pick release.

Movement Request Quantity Changes

When the movement request quantity is changed, the following points must be considered:

- There can't be an increase in the movement request quantity because overpicking isn't allowed.
- If the picked quantity is decreased, the work order material is allocated with the lesser quantity and the balance quantity of the material will be considered for the next pick release action.

Related Topics

- [How You Pick Materials for Work Orders](#)
- [Assess Reports to Pick Materials for Work Orders](#)
- [Overview of Work Orders](#)
- [How You Update a Work Order](#)

FAQs for Picking Materials

Is there a setup to cancel all movement request lines created for a released work order? (OR) Can all the lines of a movement request for a work order be canceled together?

There's no option to cancel the movement request individually to prevent picking materials. When you cancel the work order, all the open movement request lines get canceled. The line status of work order shows **Canceled by Source** and that work order would be unavailable for the Confirm pick slip action. The allocations for the work order would get canceled.

While reporting material transactions for components issued to the work order, why is the user allowed to change the subinventory and locator from where it was staged by component pick to another subinventory/locator?

The component, which is allocated (made available) to the work order and moved to the subinventory/locator isn't reserved. The component that you pick for a specific work order and move to a specific subinventory/locator must be consumed only by the same work order from that subinventory/locator, which happens only if the material is reserved.

Is it possible to pick the components/materials required for a work order from specific sub-inventory?

You can't pick from specific sub-inventory or back order pick if the on-hand isn't available in specific sub-inventory. During work order components picking, the subinventory/locator (supply subinventory or sometimes referred as staging subinventory) details are provided to Inventory; and Inventory decides the (source) subinventory/locator from which the items are allocated and picked, based on the on-hand availability and the picking rules.

After you confirm the picking of items, one of the following actions are performed:

- The items are transferred from the source subinventory to the supply subinventory.
- The items are directly issued to the work order.

However, this action is based on the plant parameter and supply type of the specific component.

Why does "Print Movement Request Pick Slip Report" for moving work order components, doesn't display un-allocated or canceled picks?

The **Print Movement Request Pick Slip Report** plant parameter through Oracle Manufacturing would generate pick status for **Open picks** only. Hence, the canceled or un-allocated lines won't be recorded in the report.

What is the significance of plant parameter "Include pull components for pick release"?

The Include pull components for pick release plant parameter determines whether the components with supply types operation pull/ assembly pull are considered for picking. Check the value if the components need to be picked for supply type operation pull/ assembly pull. The pick is created even if the material is already available in the supply subinventory. Duplicate/excessive quantity isn't issued to the work order.

Why is the application not allowing work order completion of an operation for a component of supply type operation pull if the on-hand is less than required quantity?

The application doesn't allow work order completion of an operation for a component of supply type operation pull if the on-hand is less than required quantity because this is the designed application behavior. The application automatically pulls the required components driving on-hand negative to complete the operation.

Does component picking allow picking of substitute items defined for the component?

The work order picking only allows picking for the components defined in the work order. The substitute items don't show up at work order level. As an alternative, you need to manually delete the component and add the relevant substitute item and, make any changes for the component for example, change quantity.

How to pre-reserve material before pick-release a work order?

A reservation links a supply source (such as on-hand inventory or a purchase order or a work order) to a demand source (such as Sales Order, cycle count, or user-defined demand source), and guarantees allotment of material to the demand source. You can reserve material at the subinventory, locator, and if applicable, lot and serial number level.

In this case, the application always considers Work Order is Supply and Components are demand for Work Order. Reservation doesn't happen until pick release because application doesn't want to reserve until Material/Components moved to Supply Sub inventory/Shop floor work area from Raw Material Sub inventory. When you do the component pick release, after pre-reserving components of a work order then component picking honors prior reservations it creates picks for components from the subinventory, locator, lot or serial which is pre-reserved. The reservation for the work order components is carried forward to the destination subinventory after the pick slip confirmation when the picks for pre-reserved components are confirmed.

Can the component picks made for a work order be deleted or canceled?

There's no direct way to delete the pick release already created for Work Orders. You can follow one of the alternative approaches instead of deleting the picks created:

- Case 1: No transactions on the work order

Change the status from Released to either Unreleased, or Cancel, or Closed, and save it.

This action marks the movement line status as "Cancelled from Source" and deletes the picks created for a work order.

- Case 2: Partial transacted work order

For a partially transacted work order and components picks against item not yet transacted.

- a. Navigate to the Operation for the component against which the movement request was created.
- b. Override the quantity to 0 or delete the component and save.
- c. Update the quantity back to original quantity and save the record.

This action marks the movement line status as **Canceled from Source**.

How You Pick Reserved Assemblies for Rework Work Orders

You can optionally pick the reserved assemblies to be reworked and move them to a supply subinventory before issue. By reserving and picking the rework work order assembly item, you can simplify the rework process. You can ensure that the right assembly is reworked.

The capabilities of this feature are:

- Reserve rework work order assembly items: You can reserve for two scenarios. When the assembly is automatically issued upon release action, or when the assembly is manually issued.

- Pick the reserved assembly items of the rework work order: The work order operation items of the rework work order are reserved and picked, similar to other work order types.

Key Capabilities

Here are some key capabilities of this feature:

Specify assembly items details

You can specify the assembly item details with supply subinventory and supply locator. You can issue rework work order assembly from the supply subinventory and specify locator details when you create a rework work order. When the assembly is picked, it can be from the source subinventory and source locator specified during the pick confirm action. The material will be moved from the source subinventory to the supply subinventory. When you select the plant parameter value, **Execute Rework Work Order with Manual Control**, the rework assembly is manually issued. It is automatically issued from the supply subinventory and supply locator that's specified, if the plant parameter Execute Rework Work Order with Manual Control isn't enabled.

Reserve assembly of a rework work order

You can manage the behavior if the rework assembly is a plain item for different values of the plant parameter. You can perform an automatic reservation and a detailed reservation manually for the rework work order assembly. During material issue transaction, an assembly item is issued and the reservation is relieved. All pending reserved serials are relieved when the work order is Completed, Canceled, or Closed. An automatic reservation is a high level reservation with organization on hand quantity. A detailed reservation is a manual reservation with details of subinventory, locator, lot, and serial.

Reserve assembly serials of a rework work order with the single click

When the assembly item is serial controlled, you can specify the serials and reserve them using the **Reserve Serials** action. The serials are reserved and the lock icon is shown for the serial to indicate that it's reserved.

Reserve the same serials automatically in inventory

After reserving the assembly item serials, if you navigate to the reservations page in inventory, the details of the reservation with subinventory, locator, and serials are displayed. You can navigate to inventory from manufacturing in the Manage Work Orders page by using the Reserve Materials Manually action.

Pick the same serials that were reserved

You can pick the same serials that were reserved in inventory in the Confirm Pick Slips page. After you create the reservation and picking is initiated, you can see that the same serials are allocated. During the pick confirm action, the same serials are picked.

Reservation of Materials

Overview of Reservation of Materials for Work Orders

If you want to maintain your production schedule and on-time delivery, you must focus on material availability for production. Factories use various processes to ensure that material is available for production to enable uninterrupted

manufacturing. This process may be a material planning solution, such as Oracle Supply Chain Planning to make sure products are available based on projected demand. However, even with the best planning, production supervisors sometimes need to guarantee material availability for a specific work order. To enable this, supervisors may need to reserve the materials to specific work orders before the actual start of production.

You must enable the Allow reservations for work order materials plant parameter to reserve materials for work orders. If you've been assigned a job role your enterprise uses for production supervisor work, you can reserve materials for work orders.

Here are the capabilities supported in the reservation of materials for work orders:

- **Create Reservations:** You can create reservations at the organization level (automatic reservation) or detailed (manual reservation) at subinventory, locator, lot, or serial level
- **View Reservations:** You can identify, view, and edit the reservation
- **Honor Reservations:** You can respect and fulfill reservations in all related processes
- **Issue Reserved Materials:** You can transact the reserved materials to the respective work order
- **Undo Material Reservations:** You can undo the reserved material manually from inventory or from the work order
- **Analyze Material Reservations:** You can report on the reservation quantities for the required and issued quantities

You can reserve materials for work orders and perform reservation for work order materials from Oracle Inventory and Oracle Manufacturing. You can reserve and transact materials for all types of discrete and process work orders.

Note: You can create, retrieve, update, and delete reservation for work order materials by using the Inventory Reservation user interface and the Inventory Reservation REST service.

Reserve Materials for Work Orders in Manufacturing and Inventory

In Inventory, you can manage reservations for work order materials from inventory when you query the work order and check the reservations, or launch the Create Reservations page and perform detailed reservations.

In Manufacturing, you can manage reservations for work order materials by using the Reserve Materials Manually action. You can reserve the on hand quantity using the scheduled process, or by using the **Reserve Materials Manually** action, launch the **Create Reservations** user interface in Inventory and perform detailed reservations.

Benefits of Reservation of Materials for Work Orders

There are many benefits in reserving materials. Among them are:

- You can ensure the reserved materials aren't used for any other demand, thereby maintaining production schedule adherence and on time delivery
- You can reserve the right of materials for a work order
- You can plan and procure materials efficiently and ensure that the expected quality of output is maintained
- You can avoid delay in product deliveries because of shortage or non-availability of the right materials to manufacture the product

Using this feature, you can now reserve materials for the work order in advance and ensure timely completion of the product as per schedule.

How You Reserve Materials for Work Orders in Manufacturing

All material reservations are performed in the Oracle Inventory Management. A work order is a demand placed on the warehouse to reserve and pick material similar to a sales order or a transfer order.

You can manage reservation for work order materials in inventory. You can search, create, edit, and delete reservations for work order materials.

Manage Reservations in Inventory

The Manage Reservations and Picks page in Inventory enables you to search reservations for work order demand. When you enable the plant parameter **Allow reservations for work order materials** for the organization, this page displays additional fields, such as Operation Sequence and Work Order Product. Work order product is the primary output on the work order.

With material picking, you can create picks for the work order demand. This feature lets you reserve material for work order demand. Using the search parameters, you can:

- Search for reservations for a work order number.
- Refine your search to look for reservations for a specific operation by entering the operation sequence number or the item.
- Look for reservations for a work order number by entering an organization or item, choosing the Demand Document Type as Work Order and entering the work order number in the **Demand Document Number**.

The Demand Document Number list of values displays work orders in Released and Unreleased status.

Reserve Materials Manually

You can reserve materials manually in the Create Reservations page in inventory. You can access this page from Oracle Manufacturing and from Inventory.

- In Manufacturing in the Manage Work Orders page, when you click the **Reserve Materials Manually** button corresponding to the work order number, the Create Reservations page opens. This retrieves all the eligible materials of a work order number and displays the reservation details corresponding to the material. You can select a specific work order material and create reservation for it.
- In the Inventory Management functional area, use the **Manage Reservations and Picks** task to access the Create Reservations page. The Demand Document Number value and the Operation Sequence value is displayed by default with the work order number when you access the Create Reservations page when you access this page through the work order from Manufacturing. The values of these fields aren't displayed by default when you access this page from inventory.

Reserve Materials Automatically

You can use the **Reserve Automatically** button to reserve the work order material to the on hand supply automatically. When on hand supply isn't available, you can reserve work order materials to sources other than on hand supply sources, such as Purchase Order, Requisition, Transfer Order, Transfer Order Return, and Work Order in the details section. You can reserve a work order material to on hand in a specific subinventory or locator. If you want to reserve

specific serial numbers to a work order material, you can enter subinventory or locator, in case of a locator-controlled subinventory, and enter the specific serial numbers you want to reserve using the **Record Serial Number Information** button. For a lot-controlled material, you can reserve a specific lot number to a work order material.

Note: You can't delete a reservation for a work order when there are open picks associated to the reservation.

You can reserve materials automatically for materials of a project-based work order. The material that doesn't belong to any project is referred to as common material. You can control whether or not you can reserve common material instead of project material using the inventory attributes of an item.

The **Allow User of Common Supplies** attribute is dependent on the values of the **Hard Pegging Level** attribute. The behavior for this attribute is specified in the following table:

Hard Pegging Level	Allow User of Common Supplies	Expected Behavior
None	Null	Allows reservation of common inventory
No	No	Disallows reservation of common inventory
Project and Task Project Project Group	No	Allows reservation of common inventory

Honor Reservations

Pick release honors previously detailed reservations, which were created for work order materials. The detailed reservation, if created for subinventory, locator, lot number, serial number, project, and task number is honored by the material pick release process. As a result, the picks are created for work order materials as detailed during the manual reservation. The manual reservation is carried forward to the destination subinventory, if it's reservable.

If there are no prior reservations, pick release creates detailed reservations for work order materials on pick confirm if the destination subinventory is reservable. The reservations aren't created for work order materials when the destination subinventory isn't reservable.

How You Manage Reservations for Work Order Materials in Manufacturing

To manage reservations automatically for work order materials in Oracle Manufacturing, you can select one or more work orders in released or unreleased status and reserve materials in the following two ways:

- In the Manage Work Orders page, you can create reservations using the **Reserve Materials Automatically** action, for the on hand quantity. A scheduled process starts in the background, to create reservations for all the eligible work order materials.

- In the Material Availability Assignments page, you can select one or more work orders in released or unreleased status and reserve materials. You can create reservations using the Reserve Materials Automatically action, for the on hand quantity. It's the same action as on the Manage Work Orders page, and a scheduled process starts in the background.

You can review the scheduled process output report and check the reservation details. The materials of the selected work orders are reserved based on the ATR (Available to Reserve) quantity. If not, an appropriate error message is displayed for those materials that aren't reserved. If a reservation has already been made for one or more materials, the lock icon is displayed for the work order.

You can also reserve materials manually for work order materials in Manufacturing in the following two ways:

- In the Edit Work Order Operations page, use the Reserve Materials Manually action to reserve materials for the work order operation. The inventory reservation user interface is launched, and you can create detailed reservations for the materials, with Subinventory, Locator, Lot, and Serial details.
- In the Material Availability Assignments Details page, use the Reserve Materials Manually action to reserve materials for the work order operation. The inventory reservation user interface is launched, and you can create detailed reservations for the materials, for the Subinventory, Locator, Lot, and Serial details.

If the reservation for the work order material is made for another work order, the details are displayed in the existing Edit Work Order page Reservations tab. You can review the details of the work order product as supply and the details of the work order component as demand. After the reservation is made for the work order material, the reserved quantity is displayed, and can be viewed in the Edit Operations Items page.

Transact Reserved Materials to Work Orders

You can transact the reserved materials to the work order. The View Reservations details of the work order material displays the details of the reserved material. These details include Document Type, Document Number, Revision, Lot, Subinventory, Locator, Reserved quantity, UOM, and Serial.

The reservation for the material is relieved when you transact reserved materials or when you perform material issue transaction. You can create reservations and perform the work in process issue transactions, which relieves the reservation. When you use the work order pick release, then the detailed reservation is also carried forward to the destination subinventory, and this reservation is relieved when the material issue transactions are performed for the work order.

Use Case 1 for Item Variations

When the item isn't enabled for lot or serial control, and the detailed reservation for work order material is performed for subinventory named **Stores**. Then this reservation is relieved only when the material is issued from the subinventory named Stores and is retained if you use material from a subinventory other than the one named Stores. When the reservation isn't detailed for a specific subinventory or locator, the reservation is relieved regardless of the subinventory you use to issue material to the work order.

Use Case 2 for Item Variations

If you have performed a reservation for a specific lot or serial, the reservation is relieved only when the reserved lot or serial is issued to the work order. When the reservation isn't detailed for a specific lot or serial, then the reservation is relieved regardless of what lot or serial is reserved. Also, when the reservation is detailed to a subinventory but not detailed to specific lot or serial, then the reservation is relieved as long as serials or lots in that subinventory are issued to the work order else the reservation is retained.

Delete Reservations of Work Order Materials

You can delete the existing reservations of the work order materials if you do any of the following:

- Change the work order status
- Decrease the work order quantity
- Decrease the operation item quantity

You can delete the pending reservations if you complete, cancel, or close the work order. If you have already allocated the materials, then the movement requests will also be deleted before the reservations are deleted.

Transfer Transactions from Production to Costing

The Transfer Transactions from Production to Costing action is used to transfer the manufacturing execution transaction details and work order status updates to costing for accurate costing of the work orders.

Here's an example of a resource transaction. The application reads the records in the resource transaction table. If the resource is a costed resource and Costing Interfaced attribute is set as No, the transaction record is transferred to the costing. On successful transfer, the Costing Interfaced attribute is set as yes for the transaction record. If the Costing attribute isn't enabled in the resource definition, the resource transaction records of such resources aren't considered for transferring to costing.

Note: Both discrete work order and process work orders are transferred.

As part of this transfer, the following are interfaced from Oracle Manufacturing to costing:

- Resource transaction for costed resources
- All the operation transactions
- All the work order status updates

For executing project-specific manufacturing, the resources transactions are enriched with the following project details:

- Expenditure Type is set to the expenditure type associated to the resource. If an expenditure type isn't associated to the resource, then it's set to the expenditure type associated to the Labor/Nonlabor Transaction Type in the Manage Default Expenditure Types page.
- Expenditure Item Date is set to the resource transaction date and the expenditure organization is set to the manufacturing plant.
- Other project details such as the User Defined Attribute values are derived from the project-specific work order.

The Transfer Transactions from Production to Costing page, accessible from the Work Execution Overview page, enables you to run the program on demand or schedule the program to run at a specific interval of time.

To run the program on demand, perform the following steps:

1. On the Transfer Transactions from Production to Costing page, in the Parameters region, you must select certain values.

The following table lists the values you must enter for various parameters on the page:

Field	Description
Plant	The name of the manufacturing plant.
Source System	The source system that has generated the record. The default value is All.

2. Click the Submit button. A message is shown confirming that the process is submitted.

To schedule the program, perform the following steps:

1. On the Transfer Transactions from Production to Costing page, click the Advanced button. The Transfer Transactions from Production to Costing page is reloaded with two new tabs: Schedule tab and Notification tab.
2. On the Schedule tab, you must enter or select certain values.

The following table lists the values you must enter for various parameters on the page:

Field	Description
Run	Select the Using a schedule option.
Frequency	Select the interval at which you want to program to run. You can also select a saved schedule.
Start Date	Select the date from which you want to start running the program as per the schedule.

3. Click the Submit button.

Related Topics

- [Overview of Production Execution Tasks](#)

How You Import Production Transactions

You can import production transactions, such as material transactions, resource transactions, operation transactions, and output transactions by using the File-Based Data Import mechanism, or by using REST web services.

For more details on FBDI, refer to the File-Based Data Import for Oracle Supply Chain Management Cloud guide. For more details on REST web services, refer to the REST Web Services for Oracle Supply Chain Management Cloud guide.

For a limited use, you can also use the SOAP web services for importing operation and material transactions.

Import Work Order Material Transactions

You can import the component transactions and output transactions for work order execution and the product transactions in orderless execution. For the component transactions in work order execution, the component issues to the work order and the component returns to inventory can be imported. For the output transactions in a work order count point operation, output completions and returns can be imported. For the product transactions in orderless execution, the product completion, return, scrap, and return from scrap transactions can be imported with reference to a work definition that's used to backflush the components and charge the resources.

You can report component outputs for standard discrete manufacturing work order count point operations using the Work Order Material Transactions REST API.

There's a separate FBDI template to import material transactions for process manufacturing work orders. This template is used to import output item transactions. You can use the REST service material transactions to create output transactions through integration with external systems. Output items that are completed and reversed can also be reported.

Import Work Order Resource Transactions

You can import the resource transactions for work order execution. The resources charged to the work order and the resources reversed from the work order can be imported.

CAUTION: There's no SOAP web service to import resource transactions into Oracle Manufacturing.

Import Work Order Operation Transactions

You can import the operation transactions for work order execution. The operation or product completion or return, reject, return from reject, scrap and return from scrap transactions can be imported. There are separate FBDI templates to import operation transactions for discrete manufacturing and process manufacturing work orders. To import discrete manufacturing operation transactions, use the `WorkOrderOperationTransactionTemplate.xlsm` template. To import process manufacturing operation transactions, use the `ProcessWorkOrderOperationTransactionTemplate.xlsm` template.

You can create operation, material, and resource transactions using a REST API. However, you can't update, delete, or query the production transactions using a REST API.

You can create start and stop times for an operation using a REST API. You can also query for the start and stop operations using a REST API.

You can query for a dispatch list using a REST API.

Correct Production Transactions for Import

You can use the **Correct Work Orders and Transactions for Import** task in the Work Execution work area to view all the File-Based Data Import records and REST API records that resulted in errors, and you can also export them into ADFdi spreadsheets to correct the errors. After you have corrected the errors in ADFdi, you can upload the spreadsheet to resubmit the records that returned errors for processing.

Note: You can correct errors and resubmit the completed data from the user interface for both file-based data import and REST services for the following types of production transactions:

- Work order operation transactions import
- Work order material transactions import
- Work order resource transactions import

Follow these steps to correct the errors and resubmit the completed data for any production transaction import record:

1. In the Work Execution work area, select the **Correct Work Orders and Transactions for Import** task from the Tasks panel.
2. Use the filters to search for specific import transaction entries. You can use a combination of the following filters to search for the import transactions:
 - Select the import transaction type based on whether you're correcting data for operation transactions, material transactions, or resource transactions.
 - Search for the unique batch code identifier of your import batch.
 - Search for the transaction based on the batch status. If the batch completed but has some errors that you must redress, you can search with **Completed with errors**. If the batch is still in process due to server failure or any other application error, you can search with **In process**.
 - Search for the transaction record based on the request identifier of the corresponding import work orders scheduled process.
3. The search results display a list of all the relevant import transaction records. Click Manage in Spreadsheet to initiate the correction process through ADFdi.
4. Every ADFdi spreadsheet has separate worksheets for its various attributes. You can manually correct the errors and then set the batch status of the individual rows to Ready.
5. After you have corrected all the errors and saved the statuses as ready, click Upload to resubmit the corrected records for processing. You have to upload each worksheet individually.
6. You can refresh your search on the Correct Work Orders and Transactions for Import or search on the basis of the batch status as Ready to view if the corrected records were successfully updated.
7. After updating, you must run the appropriate scheduled process to import production transactions.

Using the ADFdi spreadsheet, you make corrections to transactions imported through FBDI or REST service, quickly from a single user interface.

To query and correct REST API error records, you must enable the opt-in for the Correct REST API Transaction Errors Using the ADFdi Interface feature.

Here's few things that you must consider before enabling this feature:

- You must not have hybrid mode of error handling. For example, when you decide to resubmit error REST calls, you must do so for all errors. You must not resubmit some error REST calls and ignore in some other cases.
- When you get REST call errors and you decide to resubmit error REST calls from the calling program, you must not enable the opt-in, because it might create duplicate transactions.
- When you get REST call errors and you decided not to resubmit error REST calls from the calling program, you must enable the opt-in and must resubmit the transactions.
- If you flip between opt in and opt out when there are errored transactions in the application, errored transactions will be processed as per the opt in/opt out status at the time REST call errored out.

Note: For more information about File-Based Data Import to import or update legacy and other data into Supply Chain Management Cloud from external applications, refer to the File-Based Data Import for Oracle Supply Chain Management Cloud Development Guide.

Related Topics

- [Overview of Production Execution Tasks](#)
- [Overview of External Data Integration Services for Importing Data](#)

6 Product Genealogy

Overview of Tracing Product Genealogy

The tracing product genealogy feature enables you to capture and view the genealogy data for various transactions related to lot control enabled and serialized products and components. The transactions can be inventory transactions, work order operation transactions, and work order material transactions.

You can track the product genealogy data throughout the complete life cycle starting from raw material to finished product and then to the customer. The genealogy data can help you get information and in turn help you solve problems by:

- Identifying the source and scope of a problem.
- Identifying the relevant pieces of information for the failure.
- Identifying the other items that may be impacted due to a relationship or common origin.
- Providing locations of the item during its life cycle.

To summarize, tracing product genealogy feature enables you to:

- Search and view the genealogy instances.
- View detailed information of item lot number and serial number.
- View relationship between the genealogy instances.
- View the transaction history of the genealogy instances based on lot number or serial number.

How You Review Product Genealogy

You can search and view the genealogy details of products on the Review Product Genealogy page. This page also serves as a starting point to view genealogy instances, their relationships, and transaction history.

For a product or component to be tracked in genealogy, you must set the Enable Genealogy Tracking item attribute to Yes.

You can perform a basic keyword search or use the filters to perform an advance search. The filters enable you to perform the search based on a range of lot numbers, a range of serial numbers, or the item. Optionally, you can also provide the range of transaction dates to restrict the result to specific dates. You can save the frequently used search criteria and reuse it. You can also run a search automatically by creating a saved search and setting it as default. If you set a default search, the search is automatically run and the results are displayed whenever the Review Product Genealogy page is opened.

For each product genealogy record, you can perform the following actions:

- Information: View detailed information such as lot number and serial number details.
- Genealogy Details: View the genealogy details such as relationship between the genealogy instances.
- Transaction History: View transaction history of the product genealogy record.

In the event of any failure during processing of genealogy transactions, you can resubmit the failed genealogy transactions for processing. The Retry in-Error Genealogy Transactions scheduled process enables you to retry the genealogy transactions that failed during previous data capture. You must have the Manage Asset Interface Errors privilege to run the **Retry in-Error Genealogy Transactions** scheduled process.

You can select or deselect the Review Errors Mode check box before running the scheduled process. If the Review Errors Mode check box is selected, the scheduled process lists the interface errors without reprocess the genealogy transactions. If the Review Errors Mode check box is deselected, the scheduled process reprocesses the genealogy transactions and then lists the remaining interface errors.

Note: Dual units of measure is supported in lot genealogy. You can view transaction history of manufacturing and inventory transactions in dual units of measure. It also displays the on-hand, issued, and shipped quantities dual units of measure.

How You View Lot and Serial Number Information

For each product genealogy record, you can view the lot and serial number information of the product instance. On the Review Product Genealogy page, in the search results, select the record for which you want to view the lot or serial information. From the record menu, select: Information. The Information dialog box opens. The information is displayed based on the type of product instance of the record.

If the product instance is lot control enabled, then the Information dialog box is displayed with the following tabs:

- **Lot Details:** Displays the lot number-specific details of the product instance. The dialog box shows details such as the lot, item, lot status, material status, expiration date, and so on.
- **On Hand:** Displays lot quantities that are available in the warehouse.
- **Issued:** Displays lot quantities that are issued to the work orders.
- **Shipped:** Displays lot quantities that are shipped to the customers.

If the product instance is serial control enabled, then the Information dialog box is displayed with the serial number-specific details of the product instance. The dialog box shows details such as the serial number, item, usage, material status, organization, subinventory, and so on.

If the product instance is serial control and lot control enabled, then the Information dialog box is displayed with the following tabs:

- **Serial Details:** Displays the serial number-specific details of the product instance. The dialog box shows details such as the serial number, item, usage, material status, organization, subinventory, and so on.
- **Lot Details:** Displays the lot number-specific details of the product instance. The dialog box shows details such as the lot, item, lot status, material status, expiration date, and so on.

How You View Product Genealogy Details

For each product genealogy record, you can view the product genealogy details such as the relationship between the genealogy instances. On the Review Product Genealogy page, in the search results, select the record for which you want to view the lot or serial information.

The graphical view shows the genealogy hierarchy depicting the parent-child relationships between components and assembly. You can drill down to view additional details and related information.

Prior to this enhancement, when you transacted lot and serial-controlled input or output items with **Enable Genealogy Tracking** set to **Yes**, the application immediately ran the scheduled process **Manufacturing Transactions to Genealogy Interface**. The genealogy was built after the scheduled process was completed. When users performed large volume of transactions, the application automatically ran many **Manufacturing Transactions to Genealogy Interface** scheduled processes to build genealogy automatically. This reduced the performance of the overall application. Now you have a new profile option **Genealogy Build Deferred During Execution** which will help in addressing the issue quickly and efficiently.

Product Genealogy in Process Manufacturing

You can trace end-to-end lot genealogy of co-products and by-products. Visualize and analyze the parent-child relationships between input and output items under lot control, whether generated from in-house receiving, production, and shipping transactions, or imported through a spreadsheet from a supplier.

For all output lots completed in an operation, all of the material lots issued up to the operation have a child relationship in genealogy.

This will help in investigating and resolving product quality issues and customer complaints in a timely manner.

CAUTION: In a Process work order, if the input issue and output completion transactions happen simultaneously, the genealogy will not be built accurately.

How You View Product Genealogy Transaction History

You can view the transaction history of specific lot or serial number on the Transaction History page. On the Review Product Genealogy page, in the search result, from the Actions menu of the product genealogy record, select: Transaction History. The Transaction History page for the product instance opens.

The transaction history is displayed in form of map and can be filtered based on the following attributes:

- Source: Refers to the source of transaction.
- Source Transaction Type: Refers to the type of transaction from the specified source. You can click the transaction type link to review more details. For example, if you click the Product Completion link, the related work order transaction history details are searched and displayed.

While reviewing the transaction history details, you can zoom in and zoom out within a range of an hour to half years.

7 Reports and Analytics

How You Manage Work Definition Reports

You can access a work definition report from the Work Definition work area task panel. You can also access it from the Manage Work Definitions page. Using the Actions menu, you can print the work definition report in .pdf format instantly from the Oracle Manufacturing user interface in the following two ways:

- **Manage Work Definitions page:** Click the work definition version for which the report is to be generated.
- **Edit Work Definition page:** Generate a report for the edited version.

Additionally, from the work area task panel, the Scheduled Process Submission user interface for the report enables you to generate reports for various parameters. You can also access work definition report for multiple work definitions through a scheduled process.

A work definition report enables you to do the following:

- Provide the option for offline review, to ensure that the work definition has been set up correctly.
- Enable exchanging discrete work definition information offline, for example, with the contract manufacturer.

In a contract manufacturing organization, the work definition report has key milestone operations. The report is configured by default to print in a format most suitable for a Contract Manufacturer such as printing only milestone operations. This option is enabled by checking the **Count Point Only** indicator for the Operations. The report is attached to the Blanket Purchase Agreement and is communicated to the contract manufacturer.

The submission of the scheduled process can be performed through the **Print Work Definition Report** task in the Work Definition work area task panel.

Related Topics

- [Work Order Reports](#)

Work Order Reports

Prebuilt reports are available in Oracle Manufacturing and provide you with specific information for a given entity. The following are the work definition and work order reports available in Manufacturing:

- Components List report
- Work Order Traveler report
- Product Label report

You can use the report to review the available details about work orders. You can also view, save, and print these reports.

You can access work orders from the Manage Work Orders page through the **Print to PDF** action. You can also access work order reports such as **Print Components List** and **Print Work Order Traveler** for multiple work orders through the separate scheduled processes available in the Work Execution work area. Another way to access the Print Work Order Traveler and Print Labels reports is from the **Review Dispatch List** page.

The preassigned lot numbers display in the following reports:

- Work order traveler
- Product labels

The Work Order Traveler for discrete and process work orders display the lot numbers preassigned to the work order. Product labels display the preassigned lot numbers for discrete and process manufacturing work order operations. Preassigned Lot Numbers are displayed at all operations.

Note: For more information about configuring plant parameters, refer to the topic Overview of Manufacturing Plants in this guide. For more information about plant parameters, refer to the Implementing Manufacturing and Supply Chain Materials Management guide.

Related Topics

How You Print Components List

The Print Components List feature provides you the ability to generate and print the components list for the work order. It provides you the flexibility to view, save and print the report.

As a production supervisor, you can print the components list during the production process when reviewing and managing the work orders.

As part of the components list report, details such as subinventory, locator, operation sequence, name, work center, required quantity, Unit of Measure (UOM), basis, supply type, required date, and substituted are printed. In addition, details of the work order such as work order number, description, product, status, start and completion dates, quantity, project number, task number, and UOM are displayed.

In addition, details of the work order such as work order number, description, product, status, start and completion dates, quantity, and UOM are displayed.

The components list report is printed in the following ways:

- Select the required work order in the Manage Work Orders page and select the **Print Components List** action in the **Print to PDF Table** menu.
- Select the **Print Components List** to generate report in .pdf format.
- To Print Components List scheduled process, select multiple work orders using parameters, such as work order number, dates, product, work center, status, and component required dates.
- The list of components shown in the report can be grouped by work order and work center, sorted by subinventory and components.

After the successful completion of the scheduled process, the report is generated in .pdf format.

The scheduled process is launched for the selected work orders. The parameters for the scheduled process are:

- ****From Work Order**
- ****To Work Order**
- ****From Work Order Start Date**
- ****To Work Order Start Date**

- ****Work Order Product**
- ****Item Category**
- Work Center
- Work Order Status: Default is blank. The other statuses are Unreleased, Released, On Hold, Canceled, Completed, and Closed. In addition, the user-defined statuses of the work order are displayed.
- From Component Required Date
- To Component Required Date
- Project Number (if the organization is tracked by project)
- Task Number (if the organization is tracked by project)
- Group By: Values are **Work Order** and **WorkOrder/Work Center**
- Sort By: Values are **Subinventory** and **Component**

At least one of the fields marked ** must be entered.

Note: You have an option to enter **Submission Notes** before you submit the components list for printing.

Note: The .pdf format is available for you to print the document on a local printer.

Related Topics

- [Work Order Reports](#)
- [How You Manage Work Definition Reports](#)
- [Overview of Manufacturing Plants](#)
- [How You Manage Work Areas](#)

Assess Reports to Pick Materials for Work Orders

To ensure material-tracking and timely availability of materials to the staging area of production, you can initiate the **Pick Materials for Work Orders** scheduled process in the Work Execution work area. After the scheduled process runs and completes successfully, you can view the generated reports in the Scheduled Processes work area.

Follow these steps:

1. In the Scheduled Processes work area, search for **Pick Materials for Work Orders**. You can also use the Process ID as the basis for your search.
2. In the Search Results area, click the Attachment in the **Log and Output** area after the status of the scheduled process displays as succeeded
3. Search for **Print Materials Worker for the Work Orders** which is a subordinate scheduled process. It displays the following information:
 - Scheduled process parameters
 - Movement request number
 - Details of work order
 - Operation number

- Required date for the materials
 - Required quantity of materials
 - Previously picked quantity of materials
 - Remaining quantity for allocation
 - Allocation quantity
 - Unit of measure for materials
 - Error message if there are some materials that cannot be allocated due to shortage
4. Search for **Print Movement Request Pick Slip** which is another subordinate scheduled process. It displays the following information:
- Scheduled process parameters
 - Number of work orders selected
 - Number of work orders allocated for pick release
 - Number of work orders not allocated for pick release
 - Pick slip number
 - Movement request number
 - Source subinventory
 - Destination subinventory
 - Work order number
 - Operation sequence
 - Work area
 - Work center
 - Number of subordinate scheduled processes and their process identifiers

Note: The **Print Movement Request Pick Slip Report** is generated only if you had selected the **Print pick slip** parameter check box before submitting the picking request.

If you have the required access to the Inventory work area, you can select the Manage Movement Requests task and use the details in the **Print Movement Request Pick Slip Report** to query for your movement requests. The following details are common for all work order material picking movement requests:

- **Movement Request Type:** Shop floor
- **Transaction Type:** Work in Process Pick

In the Inventory work area, you can also select the **Confirm Pick Slip** task and query your pick slip based on the work order type and the work order number. You can then enter the picked quantity, select the pick slip lines, and perform the confirm pick slip action.

The picked quantity of the material is either directly issued to the work order or is transferred to the destination subinventory.

After you have assessed all the reports in the Scheduled Processes work area, and performed the **Confirm Pick Slip** action in the Inventory work area, you can check if the allocated quantity and the picked quantity values are updated for a work order operation.

The allocated quantity is updated and displayed when the movement request is created for the work order operation item. The picked quantity is updated and displayed when the pick slip is confirmed. You can view the updated values for these quantities on the following pages:

- **Edit Operation Items** tab on the Edit Work Orders page
- **Material Availability Details** tab on the Manage Material Availability Assignments page.

Related Topics

- [How You Pick Materials for Work Orders](#)
- [Considerations for Picking Materials](#)

How You Print Work Order Traveler

The Work Order Traveler or shop packet is a set of documents associated with a work order that travels with the subassembly as it moves through the routing in the shop floor.

It usually consists of the following information to assist you to complete the work order:

- Work order information
- Product serial information
- Configuration transactional item attributes
- Work definition details
- Work order operations, materials, resources and resource instances
- Reservation against sales orders
- Project and task number(if the organization is tracked by project)
- Attachments which can be of the following types:
 - Work order
 - Work order operation
 - Work order operation resource
 - Work order operation material
 - Work Order Operation Output (for process manufacturing work orders)
 - Product lot number that displays the preassigned lot numbers
 - Sales order header
 - Sales order line

You can use the **Print Work Order Traveler** feature to print the work order traveler during production execution. The work order traveler contains work order details such as work order information, work definition details, work order operations, materials and resources, and reservations and attachments. For serialization enabled operations, the work order traveler also consists of product serial numbers.

In Oracle Manufacturing, you generate the work order traveler from the following pages:

- From the dispatch list by selecting the required work orders, and starting the action Print Work Order Traveler. The scheduled process is launched for the work order in the selected row.

You can select only one row at a time from the dispatch list. So the traveler can be printed only for a single work order at a time.

- From the **Overview** page by clicking the link **Print Work Order Traveler**.

This will open up the user interface to submit the scheduled process. You can print travelers for multiple work orders from here. Each work order traveler is in a separate .pdf.

- From the **Manage Work Orders** page by selecting the required work orders, and selecting the action **Print Work Order Traveler**.

The scheduled process is initiated for the selected work orders. The parameters for the scheduled process are:

- Work Method
- ****From Work Order**
- ****To Work Order**
- ****From Work Order Start Date**
- ****To Work Order Start Date**
- Work Order Type: Default is All. Options are Standard and Nonstandard
- ****Work Order Product**
- ****Item Category**
- Work Order Status: Default is blank. The other statuses are Unreleased, Released, On Hold, Canceled, Completed, and Closed. In addition, the user-defined statuses of the work order are displayed.
- Project Number (if the organization is tracked by project)
- Task Number (if the organization is tracked by project)
- Include Attachments: Default is **Yes**. The possible attachment types are:
 - Short text
 - Long text
 - Image File
 - URL
 - File attachments

At least one of the fields marked ****** must be entered.

You can start the background process **Print Work Order Traveler** if you create the work order traveler from the mentioned pages.

The Work Order Traveler template can be configured to include additional attributes. The attributes from work order header, work definition, work order operations, work order product serial, work order reservations, work order Transactional Item Attributes (TIA) values, and attachments can be added to the work order traveler. These sections exist in the default template. You can remove any unwanted sections or add more attributes in some sections if these attributes are available in work order.

Note: Only one work order template is applicable for one organization. All travelers are printed with the same template. Multiple templates for the same organization aren't supported.

For more information about configuring plant parameters, refer to the topic Overview of Manufacturing Plants in this guide. For more information about plant parameters, refer to the Implementing Manufacturing and Supply Chain Materials Management guide.

Related Topics

- [How You Print Components List](#)
- [How You Print Labels](#)
- [How You Modify Copies of Predefined Reports in Manufacturing](#)

How You Print Extensible Work Order Traveler

As a production operator, you might require additional information in the work order traveler that can't be readily added in the existing traveler template. However, using an extensible work order traveler you can include additional attributes required for your business need.

By default, the Extensible Work Order Traveler displays only the attributes available in the existing traveler template and doesn't include any additional information. But, you can easily configure the template to add these additional information. The Extensible Work Order Traveler can include additional information such as item related information that's not available in the default template for you to add or edit. You can print the Generate Extensible Work Order Traveler Report from scheduled process job, from the Review Dispatch List, Manage Work Orders, and Manage Supplier Operations pages.

By default, the new extensible work order traveler displays only text attachments and URLs. It generates work order traveler as a BIP report so that you can leverage the functionalities for a BIP report like bursting. You can configure bursting in BIP reports to embed the PDF attachments, if required. Additionally, you can edit this report in BI Publisher.

Related Topics

- [How You Print Components List](#)
- [How You Print Labels](#)
- [How You Modify Copies of Predefined Reports in Manufacturing](#)

How You Modify Copies of Predefined Reports in Manufacturing

The Customize option automatically creates a copy of a predefined report and stores it in the **Shared Folders > Custom** within the business intelligence (BI) catalog. The copy includes the report definition, folder structure, and original report permissions, and is linked internally to the original report. You can edit the copy of the report, leaving the original report intact. When users open or schedule the original report, they're actually using the newer version.

Note: Since the data model for the Work Order Traveler isn't available in the catalog, users can download the data model directly using the link Download Files (provided in the Related Topics section).

For more information about how to configure and modify reports in Oracle Manufacturing, refer to the *Creating and Administering Analytics and Reports for SCM* guide.

Related Topics

- [How You Print Work Order Traveler](#)
- [How You Print Components List](#)
- [How You Print Labels](#)
- [PrintWorkOrderTravelerDm.xml](#)

How You Print Labels

The Print Product Label feature enables you to print product labels during production execution. Users can print product labels during the production process when reviewing work orders, reviewing the dispatch list, and reporting operation transactions.

The product label is printed in the following ways:

- Select the work order in the **Manage Work Orders** page, and click the **Print Label** action in the Print to PDF Table menu.
- Select the work order serials in the **Serial** tab of the **Work Order** page, and click the **Print Label** action in the table **Actions** menu.
- Select the work order operation in the **Review Dispatch List** page, and click the **Print Label** action in the table **Actions** menu.
- Select the work order operation in the **Manage Supplier Operations** page, and click the **Print Label** action in the table **Actions** menu.
- While reporting operation transactions, select the **Print Label** check box in the **Product Details** page.
- While reporting output items, select the **Print Label** check box.

The product label printing is determined by the selection of the Print product labels using external applications plant parameter:

- If the Print product labels using external applications is unchecked, the labels will be printed in native PDF rendering. The label content is generated in .pdf format based on the template layout specified in the Default Label Layout Template plant parameter. If a template isn't specified at the plant level, the template specified in the report definition of the BI publisher configuration is used for all plants. The .pdf format is automatically downloaded to the browser, and you can print the document on a local printer. As part of the predefined product label template, label content for the product such as item number, item description, work order number, and quantity are printed. For serialization enabled operations, product serial numbers are also printed. The label template can be modified to include additional attributes from item definition, work order, operation transaction, serial number, and lot number.
Note: The operation transaction attributes are included in the label content only when the label is printed when reporting operation transactions.
- If the Print product labels using external applications is checked, native printing functionality into PDF is suppressed and a print product label business event is generated. External printing applications can listen to the business event to generate labels externally

Related Topics

- [How You Print Components List](#)
- [How You Print Work Order Traveler](#)
- [Overview of Manufacturing Plants](#)
- [How You Manage Work Areas](#)

How You Print Electronic Production Records

Use the Print Electronic Production Records scheduled process to generate a summary of a product's production record based on its work order, including its complete production and quality history.

You can create an electronic production record to collate essential work order information, which enhances the process of compliance documentation of product conformance ensuring audit trails and traceability.

- Run this scheduled process from the Work Execution work area task list to print production records for a single work order or for multiple work orders.
- Run this process directly from the Scheduled Processes user interface.
- Production record is generated only when work orders are in either a closed or a completed status.
- View the documents generated on completed requests by navigating to Schedule process page under Tools and downloading the documents from the output log.
- Enhance the electronic production record using Oracle Business Intelligence Publisher (BIP), which is an extensible report that allows for the template to be modified. You can customize the template to add or remove attributes from the predefined attribute list, or to change the layout of the report.

Note: For more information about this scheduled process, see the Print Electronic Production Records topic under the Manufacturing Scheduled Processes in chapter in the Scheduled Processes for SCM guide.

OTBI for Oracle Fusion Manufacturing

Overview of OTBI for Oracle Fusion Manufacturing

Oracle Transactional Business Intelligence (OTBI) offers you real time, self-service reporting directly from Oracle Manufacturing. It's a dynamic reporting layer built keeping the business user in mind.

OTBI analysis can be created and viewed using **Reports and Analytics** from the panel drawer of the Work Execution work area within Manufacturing or using the native BI Analytics (Answers) application. The Reports and Analytics option can also be accessed from the Navigator by selecting it from **Tools** on the Home page.

If you've been assigned a job role your enterprise uses for production supervisor work, you can automatically access the manufacturing-related OTBI subject areas. The analysis can be performed only for those organizations that you've access to.

OTBI provides the following Manufacturing subject areas, which you can use to build modified analysis. These subject areas are:

- Manufacturing - Work Order Performance Real Time
- Manufacturing - Material Usage Real Time
- Manufacturing - Resource Usage Real Time
- Manufacturing - Actual Production Real Time
- Manufacturing - Production Exceptions Real Time
- Manufacturing - Purchased Item Usage Real Time

The previously mentioned subject areas support analysis of both in-house manufacturing and contract manufacturing-related work orders, their execution transactions, and operation start or stop metrics.

The dimensions and facts in these subject areas provide you visibility to work order management and work execution transactions.

You can use the common dimensions provided in the previously mentioned subject areas to cross join information between Manufacturing and subject areas belonging to other products such as Oracle Order Management, Oracle Inventory, Oracle Shipping and so on. For example, you can use the product item name information from Manufacturing and join the on-hand balance information from Inventory to create an analysis which provides visibility of work order product's availability.

The following predefined transactional analysis samples are provided for your use:

- **Cycle Time Performance:** Can be used to analyze average total cycle time in addition to queue, run, and idle time components.
- **Work Orders Scheduled Today:** Can be used to analyze work orders scheduled in your plant for the current date of the application.

Note: You can edit the predefined sample analysis provided to you and you can also create your own transactional sample analysis.

Related Topics

- [Oracle SCM Cloud Subject Areas for Transactional Business Intelligence in SCM](#)
- [Oracle SCM Cloud Creating and Administering Analytics and Reports for SCM](#)

Manufacturing - Work Order Performance Real Time

The Manufacturing - Work Order Performance Real Time subject area provides real time information about work order execution and operation cycle times. You can analyze all the supported manufacturing work methods, types of work orders, work order operations and its operation transactions using this subject area. You can analyze the outside processing using this subject area. The out of the box metrics that are exposed in this subject area are:

Metric Name	Description
Reserved Quantity	Represents the work order quantity reserved against a demand.
Completed Quantity	Represents the quantity completed in a work order execution. This metric displays completed quantity at either the work order level, operation level, or at operation transaction level depending on the dimensions used in the analysis.
Start Quantity	Represents the work order quantity in a discrete manufacturing work order and the work order batch quantity in a process manufacturing work order.
Primary Output Quantity	Represents the primary output quantity expected to be completed in a process manufacturing work order.
Scrap Quantity	Represents the quantity scrapped in a work order execution. This metric displays scrapped quantity at either the work order level, operation level, or at operation transaction level depending on the dimensions used in the analysis.
Ready Quantity	Represents the quantities in Ready state in work order operations.
Rejected Quantity	Represents the quantity rejected in a work order execution. This metric displays rejected quantity at either the operation level, or at operation transaction level depending on the dimensions used in the analysis.
Past Due Backlog Quantity	Represents the sum of quantities in work orders that are in Released status and whose planned completion date is in the past.
Past Due Backlog	Represents the count of work orders that are in Released status and whose planned completion date is in the past.
Scrap %	Represents the percentage of scrapped quantity.
On Hold Quantity	Represents the sum of quantities in work orders that are in On Hold status.
Unreleased Quantity	Represents the sum of quantities in work orders that are in Unreleased status.
Overcompletion Quantity	Represents the difference between the actual completed quantity and planned work order start quantity; when the completed quantity is greater than the work order start quantity.
Rejected %	Represents the percentage of rejected quantity.
Overcompletion Tolerance by Quantity	Represents the overcompletion tolerance quantity set at work order header.
Overcompletion Tolerance by Percentage	Represents the overcompletion tolerance percentage set at work order header.
# of On Hold Work Orders	Represents the count of work orders that are in On Hold status.

Metric Name	Description
# of Unreleased Work Orders	Represents the count of work orders that are in Unreleased status.
Work Order Aging (0 to 1 Day)	Represents the count of work orders that are in Unreleased, Released, or On Hold statuses whose difference between the past due start date and the current date is 0 to 1 day.
Work Order Aging (1 to 3 Days)	Represents the count of work orders that are in Unreleased, Released or On Hold statuses whose difference between the past due start date and the current date is 1 to 3 days.
Work Order Aging (3 to 7 Days)	Represents the count of work orders that are in Unreleased, Released or On Hold statuses whose difference between the past due start date and the current date is 3 to 7 days.
Work Order Aging (> 7 Days)	Represents the count of work orders that are in Unreleased, Released or On Hold statuses whose difference between the past due start date and the current date is greater than 7 days.
Count of Late Work Orders	Represents the count of late work orders that are in either, Unreleased, or Released, or On Hold status and whose Planned Completion Date is greater than the Need By Date on the work order. The records whose Need By date is populated are considered to calculate this metric.
Serial Quantity	Represents the serial quantity associated to the work order.
# of Rework Orders	Represents the count of work orders whose type is REWORK.
# of Transform Work Orders	Represents the count of work orders whose type is TRANSFORM.
Run Time (Hours)	Represents the cumulative of elapsed time in hours between Start and Stop times for a given operation or product serial number.
Idle Time (Hours)	Represents the cumulative of elapsed time between Start time for given operation time entry and previous stop for the same operation/serial.
Queue Time (Hours)	Represents the elapsed time between the Work Order release date and first Start time for first count point nonsupplier operation. For subsequent count point nonsupplier operation, it's the elapsed time between last stop of the previous count point operation (nonsupplier) and first start of the operation.
Supplier Fixed Lead Time	Represents the fixed lead time for supplier operations of work orders, which is expressed in the lead time UOM.
Supplier Variable Lead Time	Represents the variable lead time for supplier operations of work orders, which is expressed in the lead time UOM per unit of product manufactured.
Supplier Total Lead Time	Represents the total lead time for supplier operations of work orders. Its the supplier fixed lead time + (supplier variable lead time * work order quantity), which is expressed in the lead time UOM.
In-Process Quantity	Represents the quantities in In-Process state for supplier operations in work order.

Metric Name	Description
PO Requested Quantity	Represents the quantities at a supplier operation for which purchase requests have been requested.
PO Approved Quantity	Represents the quantities at a supplier operation for which approved purchase order exists.
Shipped Quantity	Represents the quantities at a supplier operation which has been shipped to the supplier.
Received Quantity	Represents the quantities at a supplier operation which has been received from the supplier.
Over Receipt Quantity	Represents the quantities at a supplier operation that has been over received due to purchase order receipt tolerances.
Supplier Delay	Represents the delay in completion of supplier operation. Its the difference between the supplier operation completion date and the current date.

A few of the cross-subject area analysis that you can perform in this subject area are:

- Analyze demand details using the Order management - Fulfillment Line Real Time subject area for back-to-back sales orders where work order is the supply
- Analyze product on-hand balances

The descriptive flexfields supported in this subject area are:

- Work order header descriptive flexfields
- Work order operations descriptive flexfields
- Work order operations transactions descriptive flexfields
- Product serial descriptive flexfields
- Product serial attributes descriptive flexfields
- Work Center descriptive flexfields
- Work Area descriptive flexfields

For more information about the subject areas, see:

- The Subject Areas chapter in the Creating and Administering Analytics and Reports for SCM guide.
- The Manufacturing subject areas in the Subject Areas for Transactional Business Intelligence in SCM guide.

Related Topics

- [Oracle SCM Cloud Creating and Administering Analytics and Reports for SCM](#)
- [Oracle SCM Cloud Subject Areas for Transactional Business Intelligence in SCM](#)

Manufacturing - Material Usage Real Time

The Manufacturing - Material Usage Real Time subject area provides real time information about material usages in work execution. You can analyze component lot number and component serial number information for material

transactions. In case of serialized production, you can track material serial numbers issued with respect to their parent serial number. The out of the box metrics that are exposed in this subject area are:

Metric Name	Description
Required Quantity	Represents the quantity of material item that's required to perform the operation in the work order.
Actual Usage Quantity	Represents the actual usage of the materials consumed in a work order operation. It represents the difference between issued and returned quantities.
Open Quantity	Represents the open quantity that's yet to be issued to the work order operation, which is the difference between required and actual quantities.
Material Issued Quantity in Transaction UOM	Represents the issued quantity in transaction UOM for material item.
Material Returned Quantity in Transaction UOM	Represents the returned quantity in transaction UOM for material item.
Material Negative Issued Quantity in Transaction UOM	Represents the negative issued quantity in transaction UOM for material item.
Material Negative Returned Quantity in Transaction UOM	Represents the negative returned quantity in transaction UOM for material item.
Reserved Quantity	Represents the reserved quantity of a material item.
Material Issued Quantity in Primary UOM	Represents the issued quantity in primary UOM for material item.
Material Returned Quantity in Primary UOM	Represents the returned quantity in primary UOM for material item.
Material Negative Issued Quantity in Primary UOM	Represents the negative issued quantity in primary UOM for material item.
Material Negative Returned Quantity in Primary UOM	Represents the negative returned quantity in primary UOM for material item.
Material Issued Quantity in Secondary UOM	Represents the issued quantity in secondary UOM for material item.
Material Returned Quantity in Secondary UOM	Represents the returned quantity in secondary UOM for material item.
Material Negative Issued Quantity in Secondary UOM	Represents the negative issued quantity in secondary UOM for material item.

Metric Name	Description
Material Negative Returned Quantity in Secondary UOM	Represents the negative returned quantity in secondary UOM for material item.
On Hand Balance	Represents the plant level on-hand balance in primary UOM of the material item. You can obtain on-hand balances of product item using Inventory subject areas.
On Hand Balance in Secondary UOM	Represents the plant level on-hand balance in secondary UOM of the material item. You can obtain on-hand balances of product item using Inventory subject areas.

A few of the cross-subject area analysis that you can perform in this subject area are:

- Analyze demand details using the Order management - Fulfillment Line Real Time subject area for back-to-back sales orders where work order is the supply
- Analyze product and component item on-hand balances
- Analyze manufacturing transactions for a project and task

The descriptive flexfields supported in this subject area are:

- Work order header descriptive flexfields
- Work order operations descriptive flexfields
- Work order operation material descriptive flexfields
- Component serial descriptive flexfields
- Component serial attributes descriptive flexfields
- Component lot descriptive flexfields
- Component lot attributes descriptive flexfields
- Work center descriptive flexfields
- Work area descriptive flexfields
- Product serial attributes descriptive flexfields
- Product serial number descriptive flexfields

For more information about the subject areas, see:

- The Subject Areas chapter in the Creating and Administering Analytics and Reports for SCM guide.
- The Manufacturing subject areas in the Subject Areas for Transactional Business Intelligence in SCM guide.

Related Topics

- [Oracle SCM Cloud Creating and Administering Analytics and Reports for SCM](#)
- [Oracle SCM Cloud Subject Areas for Transactional Business Intelligence in SCM](#)

Manufacturing - Resource Usage Real Time

The Manufacturing - Resource Usage Real Time subject area provides real time information about resource and resource instance usages in work execution. The out of the box metrics that are exposed in this subject area are:

Metric Name	Description
Planned Quantity Usage	Represents the planned usage of the resource that's required to perform the operation in the work order.
Actual Quantity Usage	Represents the actual usage of the resource or resource instance that was transacted to perform the operation in the work order.
Usage Quantity Variance	Represents the difference between the planned usage and actual usage of a resource.
Usage Quantity Variance %	Represents the usage quantity variance over the planned usage as a percentage value.
Usage Rate	Represents the usage rate of the resource required to manufacture one unit of the product item.

The descriptive flexfields supported in this subject area are:

- Work order header descriptive flexfields
- Work order operations descriptive flexfields
- Work order operation resource descriptive flexfields
- Work order resource transactions descriptive flexfields
- Work Center descriptive flexfields
- Work Area descriptive flexfields
- Resource descriptive flexfields
- Equipment Resource Instance descriptive flexfields
- Labor Resource Instance descriptive flexfields

For more information about the subject areas, see:

- The Subject Areas chapter in the *Creating and Administering Analytics and Reports for SCM* guide.
- The Manufacturing subject areas in the *Subject Areas for Transactional Business Intelligence in SCM* guide.

Related Topics

- [Oracle SCM Cloud Creating and Administering Analytics and Reports for SCM](#)
- [Oracle SCM Cloud Subject Areas for Transactional Business Intelligence in SCM](#)

Manufacturing - Actual Production Real Time

The Manufacturing - Actual Production Real Time subject area provides real time information about work order completion transactions. In case of process manufacturing, the output items can be yielded from any operation. You can use product dimension to analyze discrete manufacturing and output dimension to analyze process manufacturing. You can also analyze product lot number and product serial number information along with a Unique Device Identifier (UDI) that was completed into inventory. The out of the box metrics that are exposed in this subject area are:

Metric Name	Description
Expected Output Quantity	Represents the expected output quantity of the primary output item, co-product item or by-product item in a process manufacturing work order, or the expected product quantity in a discrete manufacturing work order.
Actual Output Quantity	Represents the actual quantities of output items yielded in a process manufacturing work order, or the actual production yielded in a discrete manufacturing work order.
Open Quantity	Represents the difference between expected output quantity and the actual output quantity.
Completion Quantity in Transaction UOM	Represents the completed quantity in transaction UOM for output items yielded in a process manufacturing work order or the completed quantity in transaction UOM for the product item of a discrete manufacturing work order.
Return Quantity in Transaction UOM	Represents the returned quantity in transaction UOM for output items yielded in a process manufacturing work order or the return quantity in transaction UOM for the product item of a discrete manufacturing work order.
Completion Quantity in Primary UOM	Represents the completed quantity in primary UOM for output items yielded in a process manufacturing work order or the completed quantity in primary UOM for the product item of a discrete manufacturing work order.
Return Quantity in Primary UOM	Represents the returned quantity in primary UOM for output items yielded in a process manufacturing work order or the return quantity in primary UOM for the product item of a discrete manufacturing work order.
Completion Quantity in Secondary UOM	Represents the completed quantity in secondary UOM for output items yielded in a process manufacturing work order or the completed quantity in secondary UOM for the product item of a discrete manufacturing work order.
Return Quantity in Secondary UOM	Represents the returned quantity in secondary UOM for output items yielded in a process manufacturing work order or the return quantity in secondary UOM for the product item of a discrete manufacturing work order.
On Hand Balance	Represents the plant level on-hand balance in primary UOM of the output items yielded in a process manufacturing work order. You can obtain on-hand balances of product item using Inventory subject areas.
On Hand Balance in Secondary UOM	Represents the plant level on-hand balance in secondary UOM of the output items yielded in a process manufacturing work order. You can obtain on-hand balances of product item using Inventory subject areas.

Some of the cross-subject area analysis that you can perform in this subject area are:

- Analyze demand details using the Order management - Fulfillment Line Real Time subject area for back-to-back sales orders where work order is the supply
- Analyze product and output item on-hand balances
- Analyze manufacturing transactions for a project and task

The descriptive flexfields supported in this subject area are:

- Work order header descriptive flexfields
- Product serial descriptive flexfields
- Product serial attributes descriptive flexfields
- Product lot descriptive flexfields
- Product lot attributes descriptive flexfields

For more information about the subject areas, see:

- The Subject Areas chapter in the Creating and Administering Analytics and Reports for SCM guide.
- The Manufacturing subject areas in the Subject Areas for Transactional Business Intelligence in SCM guide.

Related Topics

- [Oracle SCM Cloud Creating and Administering Analytics and Reports for SCM](#)
- [Oracle SCM Cloud Subject Areas for Transactional Business Intelligence in SCM](#)

Manufacturing - Production Exceptions Real Time

The Manufacturing - Production Exceptions Real Time subject area enables you to create an analysis which provides visibility of metrics related to production exceptions logged in your plant. The out of the box metrics that are exposed in this subject area are:

Metric Name	Description
Counts	
# of Exceptions	Represents the count of total production exceptions.
# of open Exceptions	Represents the count of open production exceptions.
# of closed Exceptions	Represents the count of closed production exceptions.
# of Pending Approval for Closure Exceptions	Represents the count of production exceptions which are in Pending Approval for Closure status.
Percentage of open exceptions by total exceptions count	Represents the percentage of count of open exceptions by the count of total exceptions.
Percentage of closed exceptions by total exceptions count	Represents the percentage of count of closed exceptions by the count of total exceptions.
Percentage of Pending Approval for Closure exceptions by total exceptions count	Represents the percentage of count of exceptions in Pending Approval for Closure status by the count of total exceptions.

Metric Name	Description
Aging-Open Production Exceptions by Creation Date	
# of Exceptions with 0 to 30 days age	Represents the count of open exceptions falling between 0 to 30 days when considered from create date to current date.
# of Exceptions with 31 to 60 days age	Represents the count of open exceptions falling between 31 to 60 days when considered from create date to current date.
# of Exceptions with 61 to 90 days age	Represents the count of open exceptions falling between 61 to 90 days when considered from create date to current date.
# of Exceptions with 90+ days age	Represents the count of open exceptions having age of above 91 days when considered from create date to current date.
Average Age of Exceptions	Represents the average age of open exceptions in days from create date to current date.
Aging-Open Production Exceptions by Update Date	
# of Exceptions with 0 to 30 days age	Represents the count of open exceptions falling between 0 to 30 days when considered from the last update date to current date.
# of Exceptions with 31 to 60 days age	Represents the count of open exceptions falling between 31 to 60 days when considered from the last update date to current date.
# of Exceptions with 61 to 90 days age	Represents the count of open exceptions falling between 61 to 90 days when considered from the last update date to current date.
# of Exceptions with 90+ days age	Represents the count of open exceptions having age of above 91 days when considered from the last update date to current date.
Average Age of Exceptions	Represents the average age of open exceptions in days from the last update date to current date.
Cycle Time	
Average Overall Cycle Time	Represents the average cycle time of exceptions in days from create date to closed date.
Average Last Update Cycle Time	Represents the average cycle time of exceptions in days from create date to last updated date.
Average Excepted Cycle Time	Represents the average cycle time of exceptions in days from create date to expected resolution date.
Average Expected Downtime	Represents the average expected downtime time of exceptions in minutes.
Impacted Work Order operations	

Metric Name	Description
# of impacted work order operations	Represents the count of Impacted work order operations that are associated with open exceptions.
# of impacted work order with critical exceptions	Represents the count of impacted work orders associated with open exceptions having high severity.
Average Age of past due operations	Represents the average age of impacted work order operations in hours from their scheduled completion date to the current date.
Average Age of past due component requirements	Represents the average age of impacted not issued components in hours from their required date to the current date.

The descriptive flexfields supported in this subject area are:

- Work order header descriptive flexfields
- Work order operations descriptive flexfields
- Product serial number descriptive flexfields
- Product serial attributes descriptive flexfields

For more information about the subject areas, see:

- The Subject Areas chapter in the *Creating and Administering Analytics and Reports for SCM* guide.
- The Manufacturing subject areas in the *Subject Areas for Transactional Business Intelligence in SCM* guide.

Related Topics

- [Oracle SCM Cloud Creating and Administering Analytics and Reports for SCM](#)
- [Oracle SCM Cloud Subject Areas for Transactional Business Intelligence in SCM](#)

Manufacturing - Purchased Item Usage Real Time

The Manufacturing - Purchased Item Usage Real Time subject area enables you to create an analysis which provides visibility of the purchase lifecycle of items procured directly against a work order. Outside processing are excluded from this subject area, as its analyzed using Manufacturing-Work Order Performance Real Time subject area. The out of the box metrics that are exposed in this subject area are:

Metric Name	Description
Requisition Quantity	Represents the requisition quantity of purchase requisitions raised against purchased items of manufacturing work orders.
Requisition Quantity in Secondary UOM	Represents the requisition quantity in secondary UOM of purchase requisitions raised against purchased items of manufacturing work orders.

Metric Name	Description
Requisition Amount	Represents the requisition amount of purchase requisitions raised against purchased items of manufacturing work orders.
Purchase Order Quantity	Represents the order quantity of purchase orders raised against purchased items of manufacturing work orders.
Purchase Order Quantity in Secondary UOM	Represents the order quantity in secondary UOM of purchase orders raised against purchased items of manufacturing work orders.
Purchase Order Amount	Represents the order amount of purchase orders raised against purchased items of manufacturing work orders.
Delivered Quantity	Represents the put away quantity for purchased items of manufacturing work orders.
Delivered Quantity in Secondary UOM	Represents the put away quantity in secondary UOM for purchased items of manufacturing work orders.
Return to Receiving Quantity	Represents the return to receiving quantity for purchased items of manufacturing work orders.
Return to Receiving Quantity in Secondary UOM	Represents the return to receiving quantity in secondary UOM for purchased items of manufacturing work orders.
Return to Supplier Quantity	Represents the return to supplier quantity for purchased items of manufacturing work orders.
Return to Supplier Quantity in Secondary UOM	Represents the return to supplier quantity in secondary UOM for purchased items of manufacturing work orders.
Correct Receipt Quantity	Represents the corrected receipt quantity for purchased items of manufacturing work orders.
Correct Receipt Quantity in Secondary UOM	Represents the corrected return quantity in secondary UOM for purchased items of manufacturing work orders.
Correct Return Quantity	Represents the corrected return quantity for purchased items of manufacturing work orders.
Correct Return Quantity in Secondary UOM	Represents the corrected return quantity in secondary UOM for purchased items of manufacturing work orders.

The descriptive flexfields supported in this subject area are:

- Work order header descriptive flexfields
- Work order operations descriptive flexfields
- Work center descriptive flexfields
- Work area descriptive flexfields

For more information about the subject areas, see:

- The Subject Areas chapter in the *Creating and Administering Analytics and Reports for SCM* guide.
- The Manufacturing subject areas in the *Subject Areas for Transactional Business Intelligence in SCM* guide.

Related Topics

- [Oracle SCM Cloud Creating and Administering Analytics and Reports for SCM](#)
- [Oracle SCM Cloud Subject Areas for Transactional Business Intelligence in SCM](#)

BICC for Oracle Manufacturing

You can use View Objects (VO) exposed in Oracle Business Intelligence Cloud Connector (BICC) data stores for extracting data out of your application instances. For example, you can use this information in your own data warehouse and also to integrate it with a third-party reporting solution.

For more information about BICC, refer to the *Extract Data Stores for SCM* guide in the Help Center.

Deep Links for Oracle Manufacturing

You can use deep links to open pages without navigating through the menu structure. Deep links come in handy if you want users to go directly from various locations in Oracle Applications. You can add deep links to a business intelligence report, an email notification, or a company website hosted on Oracle Cloud. For example, you can create an OTBI report with links to open the Work Order page from the report. To see a complete list of the available deep links, use the Deep Links work area (Navigator > Tools > Deep Links). For access to this work area, you need to have the View Administration Link (FND_VIEW_ADMIN_LINK_PRIV) privilege.

Here are the list of objects in manufacturing that support deep link capabilities:

1. Resource
2. Work definition
3. Work Order
4. Production Exceptions

For more information about Deep Links, refer to the *Oracle SCM Cloud Implementing Common Features for SCM* guide in the Help Center.